

DICOM Conformance Statement

IntelliSpace Breast R3.1

Multi-modality features powered by
IntelliSpace Clinical Applications R9.1V7



Issued by:

Philips Medical Systems Nederland BV, a Philips Healthcare company,

P.O. Box 10.000
5680 DA Best
The Netherlands

Email : dicom@philips.com

Internet: <http://www.healthcare.philips.com/connectivity>

Document number: PIIOffc.0000903

Date: 08-April-2013

1. DICOM Conformance Statement Overview

The IntelliSpace Breast* is a stand-alone product that integrates the review of mammography, breast ultrasound and MR. It complements the Full Field Digital Mammography (FFDM) acquisition system. It is designed to optimize mammography screening review for digital images and also facilitates more in-depth diagnostic review. The other breast imaging modalities MR and ultrasound can be reviewed in conjunction to other modality priors. The workstation is applicable to any digital mammography acquisition system and fit for Computed Radiography (CR) and Digital Radiography (DR). It is applicable to Mammography - US and MR systems, of Philips and other vendors, as well as to PACS systems, of Philips and other vendors.

*Multi-modality features powered by IntelliSpace Clinical Applications.

Table 1: Network Services

SOP Class		User of Service (SCU)	Provider of Service (SCP)
Name	UID		
Other			
Verification SOP Class	1.2.840.10008.1.1	Yes	Yes
Print Management			
Basic Grayscale Print Management Meta SOP Class	1.2.840.10008.5.1.1.9	Yes	No
>Basic Film Session SOP Class	1.2.840.10008.5.1.1.1	Yes	No
>Basic Film Box SOP Class	1.2.840.10008.5.1.1.2	Yes	No
>Basic Grayscale Image Box SOP Class	1.2.840.10008.5.1.1.4	Yes	No
>Printer SOP Class	1.2.840.10008.5.1.1.16	Yes	No
Query/Retrieve			
Patient Root QR Information Model - FIND SOP Class	1.2.840.10008.5.1.4.1.2.1.1	Yes	No
Patient Root QR Information Model - MOVE SOP Class	1.2.840.10008.5.1.4.1.2.1.2	Yes	No
Study Root QR Information Model - FIND SOP Class	1.2.840.10008.5.1.4.1.2.2.1	Yes	No
Study Root QR Information Model - MOVE SOP Class	1.2.840.10008.5.1.4.1.2.2.2	Yes	No
Patient/Study Only QR Info. Model - FIND SOP Class (Retired)	1.2.840.10008.5.1.4.1.2.3.1	Yes	No
Patient/Study Only QR Info. Model - MOVE SOP Class (Retired)	1.2.840.10008.5.1.4.1.2.3.2	Yes	No
Transfer			
Computed Radiography Image Storage SOP Class	1.2.840.10008.5.1.4.1.1.1	No	Yes
Digital X-Ray Image Storage - For Pres. SOP	1.2.840.10008.5.1.4.1.1.1.1	No	Yes
Digital X-Ray Image Storage - For Proc. SOP	1.2.840.10008.5.1.4.1.1.1.1.1	No	Yes
Digital Mammography X-Ray Image Storage - Pres. SOP	1.2.840.10008.5.1.4.1.1.1.2	No	Yes
Digital Mammography X-Ray Image Storage - Proc. SOP	1.2.840.10008.5.1.4.1.1.1.2.1	No	Yes
Ultrasound Multi-frame Image Storage SOP Class	1.2.840.10008.5.1.4.1.1.3.1	No	Yes
MR Image Storage SOP Class	1.2.840.10008.5.1.4.1.1.4	No	Yes
Ultrasound Image Storage SOP Class	1.2.840.10008.5.1.4.1.1.6.1	No	Yes
Secondary Capture Image Storage SOP Class	1.2.840.10008.5.1.4.1.1.7	Yes	Yes
Grayscale Softcopy Presentation State Storage SOP Class	1.2.840.10008.5.1.4.1.1.11.1	Yes	Yes
Breast Tomosynthesis Image Storage	1.2.840.10008.5.1.4.1.1.13.1.3	Yes	Yes
Enhanced SR SOP Class	1.2.840.10008.5.1.4.1.1.88.22	Yes	Yes
Comprehensive SR SOP Class	1.2.840.10008.5.1.4.1.1.88.33	Yes	Yes
Mammography CAD SR SOP Class	1.2.840.10008.5.1.4.1.1.88.50	No	Yes

A table of Supported Media Storage Application Profiles (with roles) is provided.

Media Storage Application Profile	File-set Creator (FSC)	File-set Updater (FSU)	File-set Reader (FSR)
Compact Disk-Recordable			
General Purpose CD-R Interchange	Yes	No	No
DVD			
General Purpose DVD Interchange with JPEG	Yes	No	No
USB			
General Purpose USB media	Yes	No	No

2. Table of Contents

1.	DICOM CONFORMANCE STATEMENT OVERVIEW	1
2.	TABLE OF CONTENTS	2
3.	INTRODUCTION	4
3.1.	REVISION HISTORY	4
3.2.	AUDIENCE	4
3.3.	REMARKS	4
3.4.	DEFINITIONS, TERMS AND ABBREVIATIONS	5
3.5.	REFERENCES	6
4.	NETWORKING	7
4.1.	IMPLEMENTATION MODEL	7
4.1.1.	Application Data Flow.....	7
4.1.2.	Functional Definition of AE's.....	7
4.1.2.1.	Functional Definition of DICOM Server AE.....	7
4.1.2.2.	Functional Definition of Radiology Client AE.....	8
4.1.3.	Sequencing of Real World Activities.....	8
4.2.	AE SPECIFICATIONS	10
4.2.1.	DICOM Server AE.....	10
4.2.1.1.	SOP Classes.....	10
4.2.1.2.	Association Policies.....	11
4.2.1.2.1.	General.....	11
4.2.1.2.2.	Number of Associations.....	11
4.2.1.2.3.	Asynchronous Nature.....	11
4.2.1.2.4.	Implementation Identifying Information.....	11
4.2.1.2.5.	Communication Failure Handling.....	11
4.2.1.3.	Association Initiation Policy.....	11
4.2.1.3.1.	(Real-World) Activity – FIND As SCU.....	12
4.2.1.3.2.	(Real-World) Activity – MOVE As SCU.....	15
4.2.1.3.3.	(Real-World) Activity – Image Export.....	17
4.2.1.4.	Association Acceptance Policy.....	18
4.2.1.4.1.	(Real-World) Activity – Verification as SCP.....	19
4.2.1.4.2.	(Real-World) Activity – Image Import.....	20
4.2.2.	Radiology Client AE.....	21
4.2.2.1.	SOP Classes.....	21
4.2.2.2.	Association Policies.....	22
4.2.2.2.1.	General.....	22
4.2.2.2.2.	Number of Associations.....	22
4.2.2.2.3.	Asynchronous Nature.....	22
4.2.2.2.4.	Implementation Identifying Information.....	22
4.2.2.2.5.	Communication Failure Handling.....	22
4.2.2.3.	Association Initiation Policy.....	22
4.2.2.3.1.	(Real-World) Activity – Verification as SCU.....	23
4.2.2.3.2.	(Real-World) Activity – Print Management As SCU.....	24
4.2.2.4.	Association Acceptance Policy.....	26
4.3.	NETWORK INTERFACES	26
4.3.1.	Physical Network Interfaces.....	26
4.3.2.	Additional Protocols.....	27
4.4.	CONFIGURATION	27
4.4.1.	AE Title/Presentation Address Mapping.....	27
4.4.1.1.	Local AE Titles.....	27
4.4.1.2.	Remote AE Title/Presentation Address Mapping.....	27
4.4.2.	Parameters.....	27
5.	MEDIA INTERCHANGE	28
5.1.	IMPLEMENTATION MODEL	28
5.1.1.	Application Data Flow Diagram.....	28
5.1.2.	Functional Definitions of AE's.....	28
5.1.3.	Sequencing of Real World Activities.....	28
5.2.	AE SPECIFICATIONS	28
5.3.	AUGMENTED AND PRIVATE APPLICATION PROFILES	28
5.4.	MEDIA CONFIGURATION	28
6.	SUPPORT OF CHARACTER SETS	30
7.	SECURITY	31
7.1.	SECURITY PROFILES	31
8.	ANNEXES OF APPLICATION "VIEWER"	32
8.1.	IOD CONTENTS	32
8.1.1.	Created SOP Instance.....	32
8.1.1.1.	List of created SOP Classes.....	32
8.1.1.2.	Grayscale Softcopy Presentation State Storage SOP Class.....	32

8.1.1.3.	Enhanced SR SOP Class	Error! Bookmark not defined.
8.1.1.4.	Comprehensive SR SOP Class	35
8.1.1.5.	Secondary Capture Image Storage SOP Class.....	36
8.1.2.	Usage of Attributes from Received IOD.....	38
8.1.2.1.	Usage of the Functionality Viewer	38
8.1.2.1.1.	Limitation for Mammography CAD SR SOP Class	39
8.1.2.1.2.	Limitation for Softcopy Presentation State Storage SOP Class.....	39
8.1.3.	Attribute Mapping	41
8.1.4.	Coerced/Modified fields	41
8.2.	DATA DICTIONARY OF PRIVATE ATTRIBUTES	41
8.3.	CODED TERMINOLOGY AND TEMPLATES.....	41
8.3.1.	Context Groups	41
8.3.2.	Template Specifications.....	41
8.3.3.	Private code definitions	41
8.4.	GRAYSCALE IMAGE CONSISTENCY.....	41
8.5.	STANDARD EXTENDED/SPECIALIZED/PRIVATE SOPS	41
8.6.	PRIVATE TRANSFER SYNTAXES	42

3. Introduction

The introduction specifies product and relevant disclaimers as well as any general information that the vendor feels is appropriate.

3.1. Revision History

The revision history provides dates and differences of the different releases.

Table 2: Revision History

Document Version	Date of Issue	Status	Description
00	08-April-2013	Approved	Final Version.

3.2. Audience

This Conformance Statement is intended for:

- (Potential) customers
- System integrators of medical equipment
- Marketing staff interested in system functionality
- Software designers implementing DICOM interfaces

It is assumed that the reader is familiar with the DICOM standard.

3.3. Remarks

The DICOM Conformance Statement is contained in chapter 4 through 8 and follows the contents and structuring requirements of DICOM PS 3.2.

This DICOM Conformance Statement by itself does not guarantee successful interoperability of Philips equipment with non-Philips equipment. The user (or user's agent) should be aware of the following issues:

- **Interoperability**
Interoperability refers to the ability of application functions, distributed over two or more systems, to work successfully together. The integration of medical devices into an IT environment may require application functions that are not specified within the scope of DICOM. Consequently, using only the information provided by this Conformance Statement does not guarantee interoperability of Philips equipment with non-Philips equipment.
It is the user's responsibility to analyze thoroughly the application requirements and to specify a solution that integrates Philips equipment with non-Philips equipment.
- **Validation**
Philips equipment has been carefully tested to assure that the actual implementation of the DICOM interface corresponds with this Conformance Statement.
Where Philips equipment is linked to non-Philips equipment, the first step is to compare the relevant Conformance Statements. If the Conformance Statements indicate that successful information exchange should be possible, additional validation tests will be necessary to ensure the functionality, performance, accuracy and stability of image and image related data. It is the responsibility of the user (or user's agent) to specify the appropriate test suite and to carry out the additional validation tests.
- **New versions of the DICOM Standard**
The DICOM Standard will evolve in future to meet the user's growing requirements and to incorporate new features and technologies. Philips is actively involved in this evolution and plans to adapt its equipment to future versions of the DICOM Standard. In order to do so, Philips reserves the right to make changes to its products or to discontinue its delivery.
The user should ensure that any non-Philips provider linking to Philips equipment also adapts to future versions of the DICOM Standard. If not, the incorporation of DICOM enhancements into Philips equipment may lead to loss of connectivity (in case of networking) and incompatibility (in case of media).

3.4. Definitions, Terms and Abbreviations

Table 3: Definitions, Terms and Abbreviations

Abbreviation/Term	Explanation
AE	Application Entity
ANSI	American National Standard Institute
AP	Application Profile
BOT	Basic Offset Table
CAD	Computer Aided Diagnosis
CD	Compact Disc
CD-R	CD-Recordable
CD-M	CD-Medical
CR	Computed Radiography
CT	Computed Tomography
DCR	Dynamic Cardio Review
DICOM	Digital Imaging and Communications in Medicine
DIMSE	DICOM Message Service Element
DIMSE-C	DIMSE-Composite
DIMSE-N	DIMSE-Normalized
DX	Digital X-Ray
EBE	DICOM Explicit VR Big Endian
ELE	DICOM Explicit VR Little Endian
FSC	File-set Creator
FSR	File-set Reader
FSU	File-set Updater
GUI	Graphic User Interface
HIS	Hospital Information System
HL7	Health Level Seven
IBS	IntelliSpace Breast
ILE	DICOM Implicit VR Little Endian
IOD	Information Object Definition
ISIS	Information System - Imaging System
MG	Mammography / Mammographic
MOD	Magneto-Optical Disk
MPPS	Modality Performed Procedure Step
MR	Magnetic Resonance
NEMA	National Electrical Manufacturers Association
NM	Nuclear Medicine
PDU	Protocol Data Unit
RF	X-Ray Radio Fluoroscopic
RIS	Radiology Information System
RT	Radiotherapy
RWA	Real-World Activity
SC	Secondary Capture
SCM	Study Component Management
SCP	Service Class Provider
SCU	Service Class User
SOP	Service Object Pair
SR	Structured Report
TCP/IP	Transmission Control Protocol/Internet Protocol
UID	Unique Identifier
US	Ultrasound
USMF	Ultrasound Multi-frame
WLM	Worklist Management
XA	X-Ray Angiographic

3.5. References

[DICOM] Digital Imaging and Communications in Medicine, Parts 1 - 18 (NEMA PS 3.1- PS 3.18),
National Electrical Manufacturers Association (NEMA)
Publication Sales 1300 N. 17th Street, Suite 1752, Rosslyn, Virginia. 22209, United States of America
Internet: <http://medical.nema.org/>

Note that at any point in time the official standard consists of the most recent yearly edition of the base standard (currently 2011) plus all the supplements and correction items that have been approved as Final Text.

4. Networking

4.1. Implementation model

The implementation model consists of three sections:

- The application data flow diagram, specifying the relationship between the Application Entities and the "external world" or Real-World Activities,
- A functional description of each Application Entity, and
- The sequencing constraints among them.

4.1.1. Application Data Flow

The DICOM Serve and Radiology Client Application Entities are all integrated parts of the IntelliSpace Breast product.

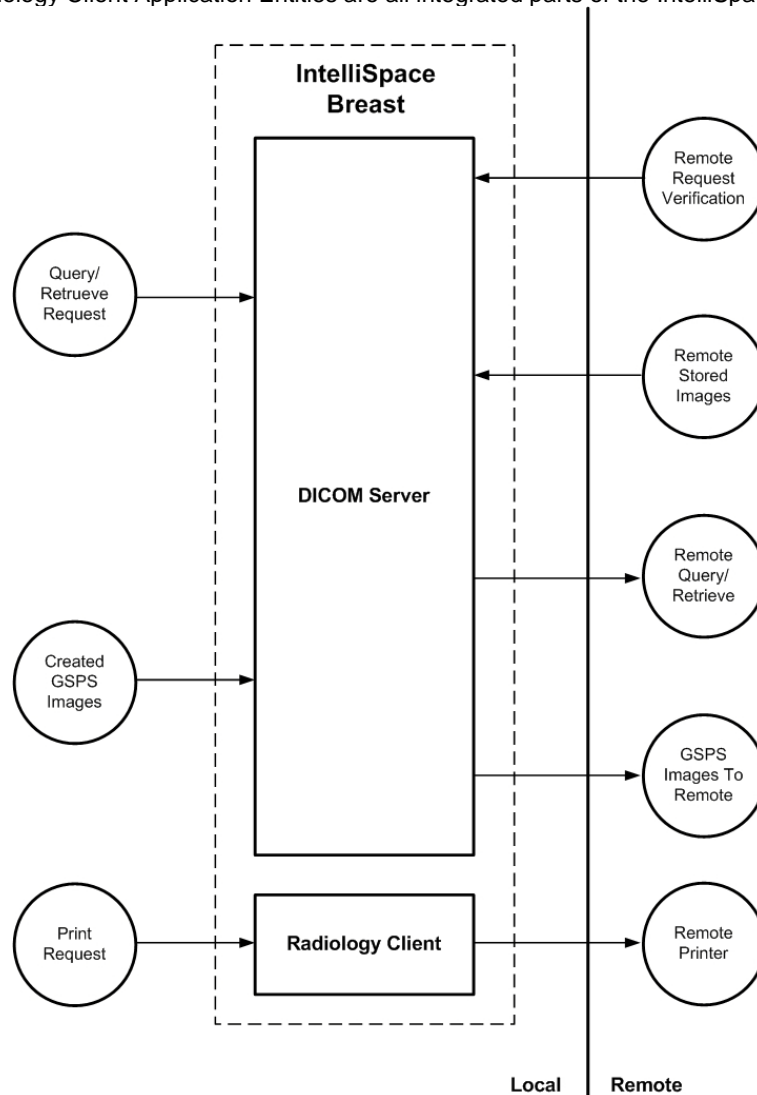

Figure 1: Application Data Flow Diagram

4.1.2. Functional Definition of AE's

This section contains a functional definition for each individual local Application Entity.

4.1.2.1. Functional Definition of DICOM Server AE

The DICOM Server can initiate and receive DICOM association requests. It will automatically be started as part of the operating system. Once started, the DICOM server will wait for another application to connect to its DICOM Storage service. Client applications also have the ability to initiate DICOM associations by the DICOM Server to remote DICOM devices for Storage and Query/Retrieve services.

4.1.2.2. Functional Definition of Radiology Client AE

The Radiology Client will initiate DICOM associations for DICOM Printing services on an as needed basis dependent upon interactive requests from users of the system.

4.1.3. Sequencing of Real World Activities

Real world activity of Manual Push of Priors.

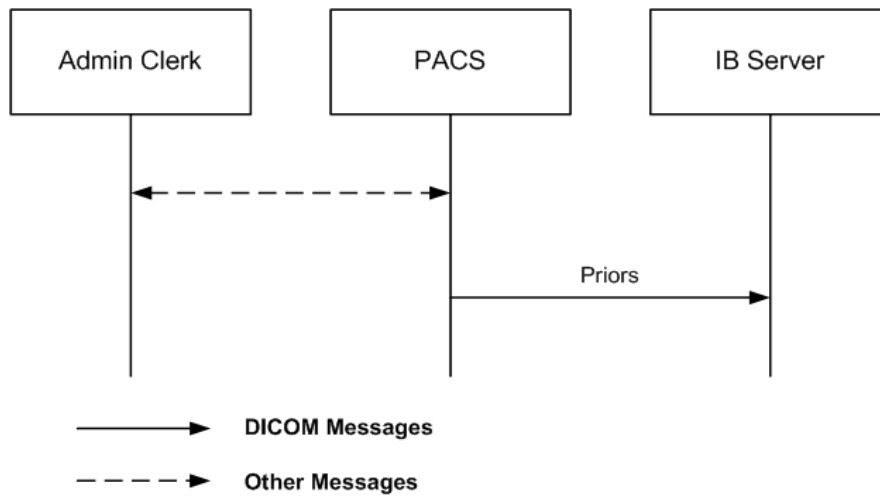

Figure 2: Manual Push Of Priors

Steps:

- The admin clerk selects Priors on the PACS and requests to send them to the ISB. The PACS responds by sending the requested studies to the ISB.

Real world activity of RIS-Triggered Push of Priors (PACS => ISB)

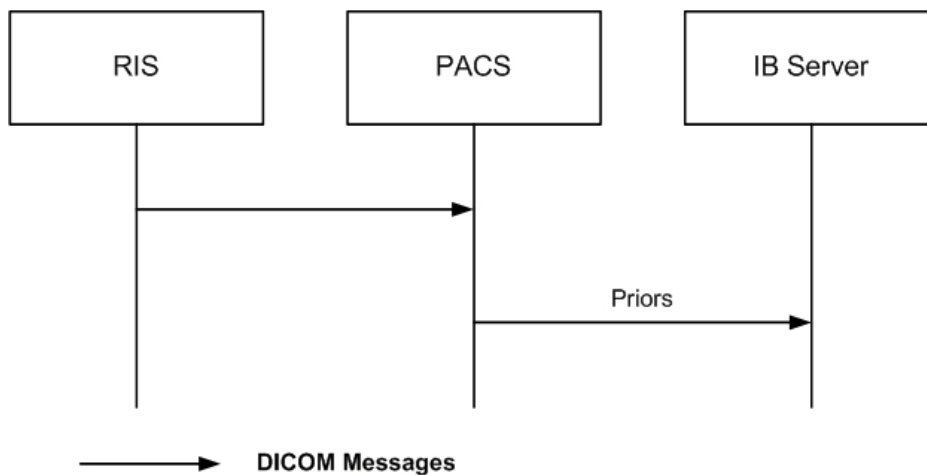

Figure 3: RIS triggered Push of Priors

Steps:

- As configured in the RIS, the RIS inspects the modality worklist for the patient which Priors will be sent to the PACS.
- The RIS requests the PACS to send them to the ISB. The PACS responds by sending the requested Studies to the ISB.

Real world activity of handling exams without CAD influences.

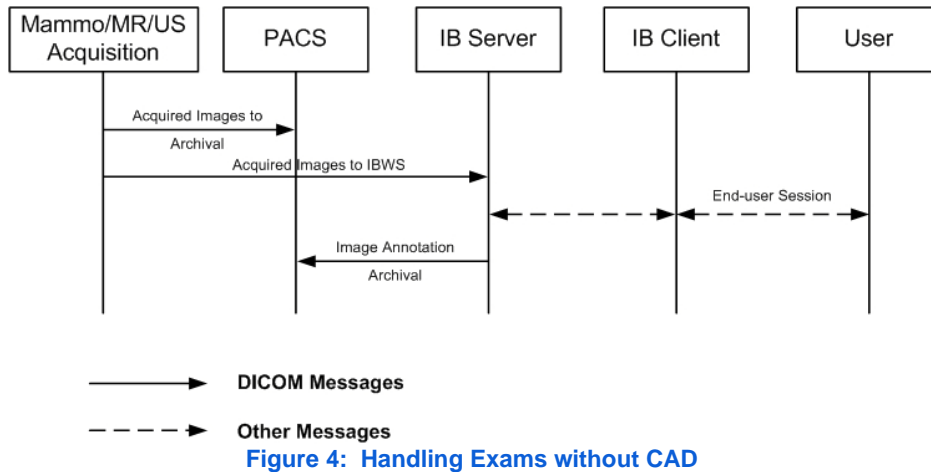

Figure 4: Handling Exams without CAD

Steps:

- The acquisition system acquires images according to schedule. It archives the images to the PACS. It also sends the images to the ISB.
- The radiologist logs on to an ISB Client, and selects a worklist. The system responds by displaying the worklist with cases to be handled.
- The radiologist reads a case, selected from the worklist:
 - When needed, he captures Images and fills in BI-RADS properties.
 - When needed, he consults Priors and Prior Reports/Evidence.
- When he is done, he can mark the case "Read". This will generate a report. The system responds by archiving the Evidence in DICOM SR and storing the captured Images on the PACS as GSPS, SR or SC, and displaying the selected case.

Last two steps can be repeated as long as there are cases available, or until the Radiologist logs off. Real world activity of handling exams with CAD influences (CAD markers and Breast Density information).

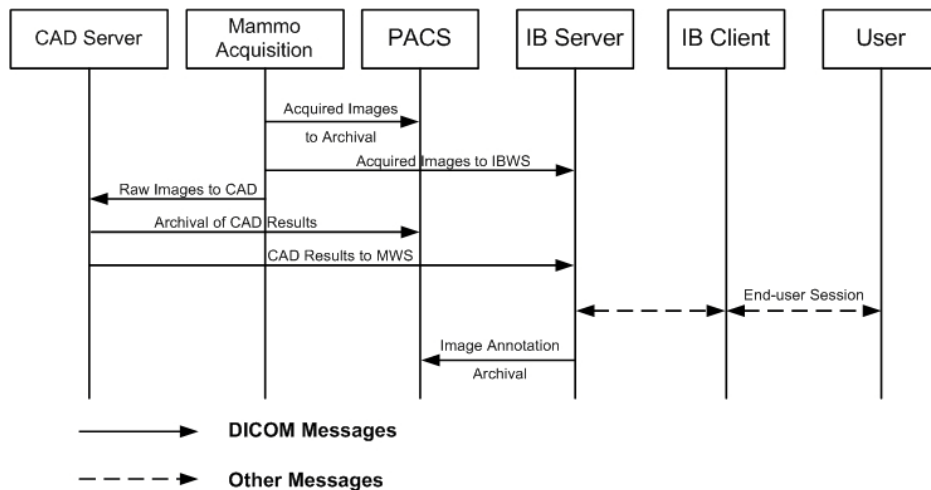

Figure 5: Handling Exams with CAD

Steps:

- The acquisition System acquires images according to schedule. It archives the image to the PACS. It also sends the images to the ISB and to the CAD Server.
- The CAD Server produces findings and sends them to the ISB. Note that archiving of the CAD results is not the responsibility of the IntelliSpace Breast system.
- The Radiologist logs on to an ISB client, and selects a work list. The IntelliSpace Breast system responds by displaying the work list with cases to be handled.
- The Radiologist reads a case, selected from the work list:
 - When needed, he fills in Evidence.
 - When needed, he consults Priors and Prior Reports/Evidence.
 - He may consult the CAD results.
 - He may produce reports.
- When he is done, he marks the case "Read" and he may select the next case. The saved annotations are auto pushed to the PACS.

Last two steps can be repeated as long as there are cases available, or until the Radiologist logs off.

Real world activity of Occasional retrieving of Priors.

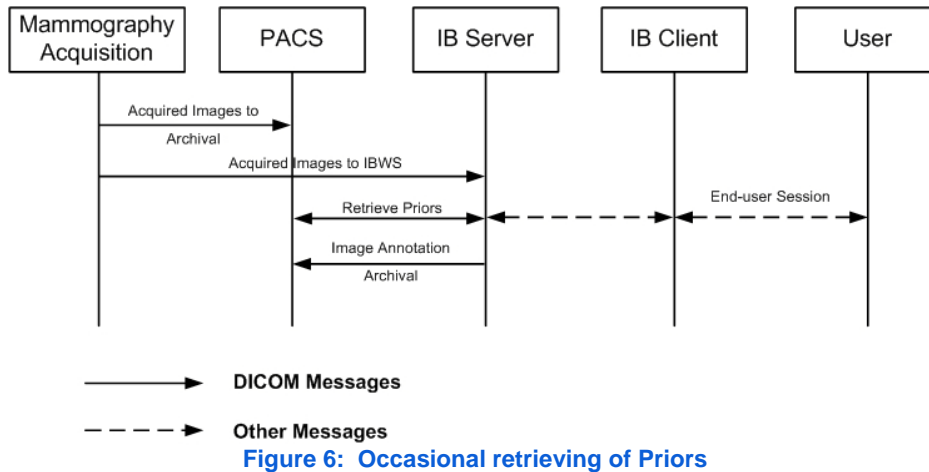

Figure 6: Occasional retrieving of Priors

Steps:

- The acquisition system acquires images according to schedule. It archives the images to the PACS. It also sends the images to the ISB.
- The Radiologist logs on to an ISB client, and selects a work list. The system responds by displaying the work list with cases to be handled.
- The Radiologist reads a case, selected from the work list:
- He fills in Evidence.
- It may happen that the Radiologists want to see Priors that for some reason are not on the ISB. He requests the ISB to get all relevant Priors (including optionally prior Mammo CAD Structured Reports) that reside on the PACS. The ISB responds by querying them from the PACS, and getting them from the PACS, after which they are displayed on the screen.
- He may produce reports in a reporting system.
- When he is done, he marks the case “Read” and he may select the next case. The ISB responds by archiving the annotations on the PACS, and displaying the selected case.

Last two steps can be repeated as long as there are cases available, or until the Radiologist logs off.

4.2. AE Specifications

This section in the DICOM Conformance Statement is a set of Application Entity specifications. There are as many of these subsections as there are different AE's in the implementation.

4.2.1. DICOM Server AE

Detail of this specific Application Entity is specified in this section.

4.2.1.1. SOP Classes

This Application Entity provides Standard Conformance to the following SOP Classes.

Table 4: SOP Classes for DICOM Server AE

SOP Class Name	SOP Class UID	SCU	SCP
Verification SOP Class	1.2.840.10008.1.1	No	Yes
Computed Radiography Image Storage SOP Class	1.2.840.10008.5.1.4.1.1.1	No	Yes
Digital X-Ray Image Storage - For Pres. SOP	1.2.840.10008.5.1.4.1.1.1.1	No	Yes
Digital X-Ray Image Storage - For Proc. SOP	1.2.840.10008.5.1.4.1.1.1.1.1	No	Yes
Digital Mammography X-Ray Image Storage - Pres. SOP	1.2.840.10008.5.1.4.1.1.1.2	No	Yes
Digital Mammography X-Ray Image Storage - Proc. SOP	1.2.840.10008.5.1.4.1.1.1.2.1	No	Yes
Grayscale Softcopy Presentation State Storage SOP Class	1.2.840.10008.5.1.4.1.1.11.1	Yes	Yes
Breast Tomosynthesis Image Storage	1.2.840.10008.5.1.4.1.1.13.1.3	No	Yes
Ultrasound Multi-frame Image Storage SOP Class	1.2.840.10008.5.1.4.1.1.3.1	No	Yes
MR Image Storage SOP Class	1.2.840.10008.5.1.4.1.1.4	No	Yes
Ultrasound Image Storage SOP Class	1.2.840.10008.5.1.4.1.1.6.1	No	Yes
Secondary Capture Image Storage SOP Class	1.2.840.10008.5.1.4.1.1.7	Yes	Yes
Enhanced SR SOP Class	1.2.840.10008.5.1.4.1.1.88.22	Yes	Yes
Comprehensive SR SOP Class	1.2.840.10008.5.1.4.1.1.88.33	Yes	Yes
Mammography CAD SR SOP Class	1.2.840.10008.5.1.4.1.1.88.50	No	Yes
Patient Root QR Information Model - FIND SOP Class	1.2.840.10008.5.1.4.1.2.1.1	Yes	No
Patient Root QR Information Model - MOVE SOP Class	1.2.840.10008.5.1.4.1.2.1.2	Yes	No
Study Root QR Information Model - FIND SOP Class	1.2.840.10008.5.1.4.1.2.2.1	Yes	No
Study Root QR Information Model - MOVE SOP Class	1.2.840.10008.5.1.4.1.2.2.2	Yes	No

SOP Class Name	SOP Class UID	SCU	SCP
Patient/Study Only QR Info. Model - FIND SOP Class (Retired)	1.2.840.10008.5.1.4.1.2.3.1	Yes	No
Patient/Study Only QR Info. Model - MOVE SOP Class (Retired)	1.2.840.10008.5.1.4.1.2.3.2	Yes	No

Note: Any SOP specific behavior is documented later in the conformance statement in the applicable SOP specific conformance section.

4.2.1.2. Association Policies

Each AE specification contains a description of the general association establishment and acceptance policies of the AE.

4.2.1.2.1. General

The DICOM standard application context is specified below.

Table 5: DICOM Application Context

Description	Value
Application Context Name	1.2.840.10008.3.1.1.1

4.2.1.2.2. Number of Associations

The number of simultaneous associations that an Application Entity may support as an Initiator or Acceptor is specified here.

Table 6: Number of associations as an Association Initiator for this AE

Description	Value
Maximum number of simultaneous associations	5 (Storage)3 (Query)2 (Move)

Table 7: Number of associations as an Association Acceptor for this AE

Description	Value
Maximum number of simultaneous associations	50

4.2.1.2.3. Asynchronous Nature

Not supported.

4.2.1.2.4. Implementation Identifying Information

The value supplied for Implementation Class UID and version name are documented here.

Table 8: DICOM Implementation Class and Version for DICOM Server AE – C-FIND as SCU and C-MOVE as SCU

Implementation Class UID	1.3.46.670589.5.2.10
Implementation Version Name	EV/MIP 1.0

Table 9: DICOM Implementation Class and Version for DICOM Server AE – Image Export

Implementation Class UID	1.3.46.670589.46.1.3.1
Implementation Version Name	Philips_ISB_3_1

4.2.1.2.5. Communication Failure Handling

The behavior of the AE during communication failure is summarized in the next table.

Table 10: Communication Failure Behavior

Exception	Behavior
Timeout	The Association is aborted using A-ABORT and the command is marked as failed. The reason is logged and reported to the user.

4.2.1.3. Association Initiation Policy

The Application Entity will respond to a received Association rejection as shown in the next table.

Table 11: Association Rejection response

Result	Source	Reason/Diagnosis	Behavior
1 - rejected-permanent	1 - DICOM UL service-user	1 - no-reason-given	
		2 - application-context-name-not-supported	
		3 - calling-AE-title-not-recognized	
		7 - called-AE-title-not-recognized	
	2 - DICOM UL service-provider (ACSE related function)	1 - no-reason-given	
	2 - protocol-version-not-supported		
2 - rejected-transient	1 - DICOM UL service-user	1 - temporary-congestion	
		2 - local-limit-exceeded	
		1 - no-reason-given	
		2 - application-context-name-not-supported	
	3 - calling-AE-title-not-recognized		
	7 - called-AE-title-not-recognized		
2 - DICOM UL service-provider (ACSE related function)	2 - DICOM UL service-provider (ACSE related function)	1 - no-reason-given	
		2 - protocol-version-not-supported	
	3 - DICOM UL service-provider (Presentation related function)	1 - temporary-congestion	
		2 - local-limit-exceeded	

The behavior of the AE on receiving an Association abort is summarized in the next table.

Table 12: Association Abort Handling

Source	Reason/Diagnosis	Behavior
0 - DICOM UL service-user (initiated abort)	0 - reason-not-specified	
2 - DICOM UL service-provider (initiated abort)	0 - reason-not-specified	
	1 - unrecognized-PDU	
	2 - unexpected-PDU	
	4 - unrecognized-PDU-parameter	
	5 - unexpected-PDU-parameter	
	6 - invalid-PDU-parameter-value	

4.2.1.3.1. (Real-World) Activity – FIND As SCU

4.2.1.3.1.1. Description and Sequencing of Activities

ISB Client applications use the iQuery tool of the DICOM Server to initiate and manage DICOM associations with remote application Entities that support the DICOM Query/Retrieve Service as a Service Class Provider. The iQuery tool allows ISB Client applications to interact with the DICOM Server via a proprietary interface. The DICOM Server’s iQuery tool is an interactive end-user application and will generate DICOM transactions based upon end-user initiated activities.

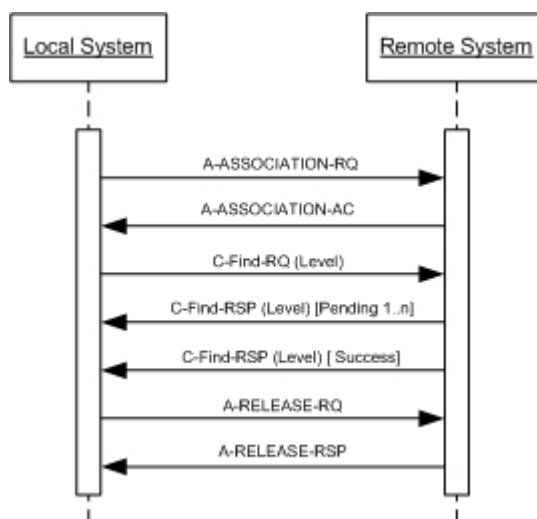

Figure 7: (Real World) Activity - FIND As SCU

4.2.1.3.1.2. Proposed Presentation Contexts

Table 13: Proposed Presentation Contexts for (Real-World) Activity – FIND As SCU

Presentation Context Table					
Abstract Syntax		Transfer Syntax		Role	Extended Negotiation
Name	UID	Name List	UID List		
Patient Root QR Information Model - FIND SOP Class	1.2.840.10008.5.1.4.1.2.1.1	Explicit VR Big Endian	1.2.840.10008.1.2.2	SCU	None
		Explicit VR Little Endian	1.2.840.10008.1.2.1		
		Implicit VR Little Endian	1.2.840.10008.1.2		
Patient/Study Only QR Info. Model - FIND SOP Class (Retired)	1.2.840.10008.5.1.4.1.2.3.1	Explicit VR Big Endian	1.2.840.10008.1.2.2	SCU	None
		Explicit VR Little Endian	1.2.840.10008.1.2.1		
		Implicit VR Little Endian	1.2.840.10008.1.2		
Study Root QR Information Model - FIND SOP Class	1.2.840.10008.5.1.4.1.2.2.1	Explicit VR Big Endian	1.2.840.10008.1.2.2	SCU	None
		Explicit VR Little Endian	1.2.840.10008.1.2.1		
		Implicit VR Little Endian	1.2.840.10008.1.2		

4.2.1.3.1.3. SOP Specific Conformance for Patient Root QR Information Model - FIND SOP Class

This section and sub-section include the manufacturer SOP and Dataset specific information as well the status codes and their corresponding behavior.

4.2.1.3.1.3.1. Dataset Specific Conformance for Patient Root QR Information Model - FIND SOP Class C-FIND-SCU

Detail regarding the Dataset Specific response behavior will be reported in this section.

Table 14: Supported Query Keys for Patient Root Information Model

Patient Root Information Model				
Attribute Name	Tag	VR	Type Of Matching	Comment
Q/R Patient level				
Patient ID	0010,0020	LO	Single Value, Universal, WildCard	
Patient's Name	0010,0010	PN	Single Value, Universal, WildCard	
Issuer of Patient ID	0010,0021	LO	Single Value, Universal, WildCard	
Patient's Birth Date	0010,0030	DA	Single Value, Universal, WildCard	
Patient's Sex	0010,0040	CS	Single Value, Universal, WildCard	
Q/R Study level				
Study Instance UID	0020,000D	UI	Single Value, Universal	
Study Date	0008,0020	DA	Single Value, Universal	
Study Time	0008,0030	TM	Single Value, Universal	
Study Time	0008,0030	TM	Single Value, Universal	
Accession Number	0008,0050	SH	Single Value, Universal	
Modalities in Study	0008,0061	CS	Single Value, Universal	
Referring Physician's Name	0008,0090	PN	Single Value, Universal	
Study Description	0008,1030	LO	Single Value, Universal	
Patient's Name	0010,0010	PN	Single Value, Universal	
Patient ID	0010,0020	LO	Single Value, Universal, WildCard	
Patient's Birth Date	0010,0030	DA	Single Value, Universal, WildCard	
Patient's Sex	0010,0040	CS	Single Value, Universal, WildCard	
Study ID	0020,0010	SH	Single Value, Universal	
Number of Study Related Series	00201206	IS	Single Value, Universal	
Number of Study Related Instances	00201208	IS	Single Value, Universal	

This part of the section includes the dataset specific behavior, i.e. error codes, error and exception handling, time-outs, etc.

Table 15: Status Response

Service Status	Error Code	Further Meaning	Behavior
Success	0000	Success	Continue processing response
Pending	FF00	Current match is supplied	Send A-RELEASE-RQ
	FF01	Matches are continuing but one or more Optional Keys were not supported	Send A-RELEASE-RQ

Service Status	Error Code	Further Meaning	Behavior
Cancel	FE00	Matching terminated due to Cancel Request	Stop waiting for response from the SCP

4.2.1.3.1.4. SOP Specific Conformance for Patient/Study Only QR Info. Model - FIND SOP Class (Retired)

4.2.1.3.1.4.1. Dataset Specific Conformance for Patient/Study Only QR Info. Model - FIND SOP Class C-FIND-SCU

This section includes the dataset specific behavior, i.e. error codes, error and exception handling, time-outs, etc. All DICOM attributes specified as valid keys for C-FIND messages are legal for ISB Server query keys as well. In practice the set actually used is defined by client-side requests so only a pertinent subset would be used. The table lists essential tags that ISB Server will expect any Query/Retrieve SCP to support for the Patient/Study Only Information Model.

Table 16: Supported Query Keys for Patient/Study Only Information Model

Patient/Study Only Information Model				
Attribute Name	Tag	VR	Type Of Matching	Comment
Q/R Patient level				
Patient ID	0010,0020	LO	Single Value, Universal, WildCard	
Patient's Name	0010,0010	PN	Single Value, Universal, WildCard	
Issuer of Patient ID	00100021	LO	Single Value, Universal, WildCard	
Patient's Birth Date	00100030	DA	Single Value, Universal, WildCard	
Patient's Sex	00100040	CS	Single Value, Universal, WildCard	
Q/R Study level				
Study Instance UID	0020,000D	UI	Single Value, Universal	
Study Date	0008,0020	DA	Single Value, Universal	
Study Time	0008,0030	TM	Single Value, Universal	
Study Time	0008,0030	TM	Single Value, Universal	
Accession Number	0008,0050	SH	Single Value, Universal	
Modalities in Study	0008,0061	CS	Single Value, Universal	
Referring Physician's Name	0008,0090	PN	Single Value, Universal	
Study Description	0008,1030	LO	Single Value, Universal	
Patient's Name	0010,0010	PN	Single Value, Universal	
Patient ID	0010,0020	LO	Single Value, Universal, WildCard	
Patient's Birth Date	0010,0030	DA	Single Value, Universal, WildCard	
Patient's Sex	0010,0040	CS	Single Value, Universal, WildCard	
Study ID	0020,0010	SH	Single Value, Universal	
Number of Study Related Series	00201206	IS	Single Value, Universal	
Number of Study Related Instances	00201208	IS	Single Value, Universal	

This part of the section includes the dataset specific behavior, i.e. error codes, error and exception handling, time-outs, etc.

Table 17: Status Response

Service Status	Error Code	Further Meaning	Behavior
Success	0000	Success	Continue processing response.
Pending	FF00	Current match is supplied	Process requests up to the set max number of responses and if the results exceed this number send A-RELEASE-RQ
	FF01	Matches are continuing but one or more Optional Keys were not supported	
Cancel	FE00	Matching terminated due to Cancel Request	Stop waiting for response from the SCP

4.2.1.3.1.5. SOP Specific Conformance for Study Root QR Information Model - FIND SOP Class

This section and sub-section include the manufacturer SOP and Dataset specific information as well the status codes and their corresponding behavior.

4.2.1.3.1.5.1. Dataset Specific Conformance for Study Root QR Information Model - FIND SOP Class C-FIND-SCU

Detail regarding the Dataset Specific response behavior will be reported in this section.

Table 18: Supported Query Keys for Study Root Information Model

Study Root Information Model				
Attribute Name	Tag	VR	Type Of Matching	Comment
Q/R Study level				
Study Instance UID	0020,000D	UI	Single Value, Universal	
Study Date	0008,0020	DA	Single Value, Universal	
Study Time	0008,0030	TM	Single Value, Universal	
Study Time	0008,0030	TM	Single Value, Universal	
Accession Number	0008,0050	SH	Single Value, Universal	
Modalities in Study	0008,0061	CS	Single Value, Universal	
Referring Physician's Name	0008,0090	PN	Single Value, Universal	
Study Description	0008,1030	LO	Single Value, Universal	
Patient's Name	0010,0010	PN	Single Value, Universal	
Patient ID	0010,0020	LO	Single Value, Universal, WildCard	
Patient's Birth Date	0010,0030	DA	Single Value, Universal, WildCard	
Patient's Sex	0010,0040	CS	Single Value, Universal, WildCard	
Study ID	0020,0010	SH	Single Value, Universal	
Number of Study Related Series	00201206	IS	Single Value, Universal	
Number of Study Related Instances	00201208	IS	Single Value, Universal	
Q/R Series level				
Modality	00080060	CS	Single Value, Universal	
Series Description	0008103E	LO	Single Value, Universal, Wild Card	
Study Instance UID	0020000D	UI	Single Value, Universal	
Series Instance UID	0020000E	UI	Single Value, Universal	
Series Number	00200011	IS	Single Value, Universal	
Number of Series Related Instances	00201209	IS		
Scheduled Procedure Step ID	00400009	SH		
Performed Procedure Step Start Date	00400244	DA		
Performed Procedure Step Start Time	00400245	TM		
Request Attributes Sequence	00400275	SQ		
>Requested Procedure ID	00401001	SH		
Q/R Image level				
Study Instance UID	0020000D	UI	Single Value, Universal	
Series Instance UID	0020000E	UI	Single Value, Universal	
Instance Number	00200013	IS		

This part of the section includes the dataset specific behavior, i.e. error codes, error and exception handling, time-outs, etc.

Table 19: Status Response

Service Status	Error Code	Further Meaning	Behavior
Success	0000	Success	Continue processing response
Pending	FF00	Current match is supplied	Process requests up to the set max number of responses and if the results exceed this number send A-RELEASE-RQ
	FF01	Matches are continuing but one or more Optional Keys were not supported	
Cancel	FE00	Matching terminated due to Cancel Request	Stop waiting for response from the SCP

4.2.1.3.2. (Real-World) Activity – MOVE as SCU

4.2.1.3.2.1. Description and Sequencing of Activities

The system will initiate associations for the DICOM Query/Retrieve Service to perform pre fetch operations (Done through a third party tool internally). This enables the system to query for and retrieve older DICOM studies from a remote DICOM entity which are determined to be relative to the currently ordered and scheduled studies.

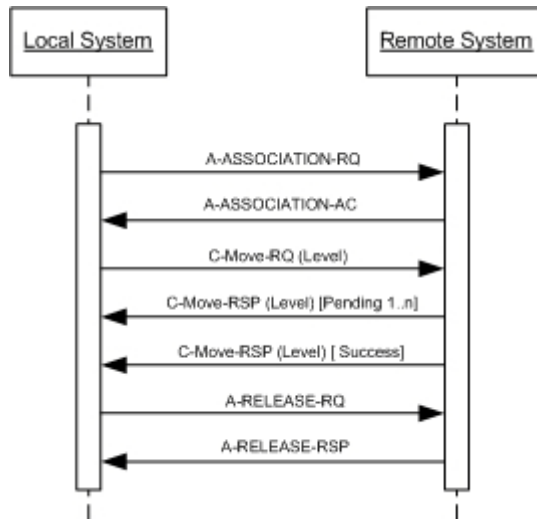

Figure 8: (Real World) Activity - MOVE As SCU

4.2.1.3.2.2. Proposed Presentation Contexts

The presentation contexts are defined in the next table.

Table 20: Proposed Presentation Contexts for (Real-World) Activity – MOVE As SCU

Presentation Context Table					
Abstract Syntax		Transfer Syntax		Role	Extend ed Negotia tion
Name	UID	Name List	UID List		
Patient Root QR Information Model - MOVE SOP Class	1.2.840.10008.5.1.4.1.2.1.2	Explicit VR Big Endian	1.2.840.10008.1.2.2	SCU	None
		Explicit VR Little Endian	1.2.840.10008.1.2.1		
		Implicit VR Little Endian	1.2.840.10008.1.2		
Patient/Study Only QR Info. Model - MOVE SOP Class (Retired)	1.2.840.10008.5.1.4.1.2.3.2	Explicit VR Big Endian	1.2.840.10008.1.2.2	SCU	None
		Explicit VR Little Endian	1.2.840.10008.1.2.1		
		Implicit VR Little Endian	1.2.840.10008.1.2		
Study Root QR Information Model - MOVE SOP Class	1.2.840.10008.5.1.4.1.2.2.2	Explicit VR Big Endian	1.2.840.10008.1.2.2	SCU	None
		Explicit VR Little Endian	1.2.840.10008.1.2.1		
		Implicit VR Little Endian	1.2.840.10008.1.2		

4.2.1.3.2.3. SOP Specific Conformance for Patient Root QR Information Model - MOVE SOP Class

This section and sub-section include the manufacturer SOP and Dataset specific information as well the status codes and their corresponding behavior.

4.2.1.3.2.3.1. Dataset Specific Conformance for Patient Root QR Information Model - MOVE SOP Class C-MOVE-SCU

Detail regarding the Dataset Specific response behavior will be reported in this section.

Table 21: Identifiers for MOVE Patient Root Information Model as SCU

Patient Root Information Model			
Attribute Name	Tag	VR	Comment
Q/R Patient level			
Patient ID	0010,0020	LO	
Q/R Study level			
Patient ID	0010,0020	LO	
Study Instance UID	0020,000D	UI	

4.2.1.3.2.4. SOP Specific Conformance for Patient/Study Only QR Info. Model - MOVE SOP Class (Retired)

This section and sub-section include the manufacturer SOP and Dataset specific information as well the status codes and their corresponding behavior.

4.2.1.3.2.4.1. Dataset Specific Conformance for Patient/Study Only QR Info. Model - MOVE SOP Class C-MOVE-SCU

Detail regarding the Dataset Specific response behavior will be reported in this section.

Table 22: Identifiers for MOVE Patient/Study Only Information Model as SCU

Patient/Study Only Information Model			
Attribute Name	Tag	VR	Comment
Q/R Patient level			
Patient ID	0010,0020	LO	
Q/R Study level			
Patient ID	0010,0020	LO	
Study Instance UID	0020,000D	UI	

4.2.1.3.2.5. SOP Specific Conformance for Study Root QR Information Model - MOVE SOP Class

This section and sub-section include the manufacturer SOP and Dataset specific information as well the status codes and their corresponding behavior.

4.2.1.3.2.5.1. Dataset Specific Conformance for Study Root QR Information Model - MOVE SOP Class C-MOVE-SCU

Detail regarding the Dataset Specific response behavior will be reported in this section.

Table 23: Identifiers for MOVE Study Root Information Model as SCU

Study Root Information Model			
Attribute Name	Tag	VR	Comment
Q/R Study level			
Study Instance UID	0020,000D	UI	
Q/R Study level			
Study Instance UID	0020,000D	UI	
Series Instance UID	0020,000E	UI	

4.2.1.3.3. (Real-World) Activity – Image Export

4.2.1.3.3.1. Description and Sequencing of Activities

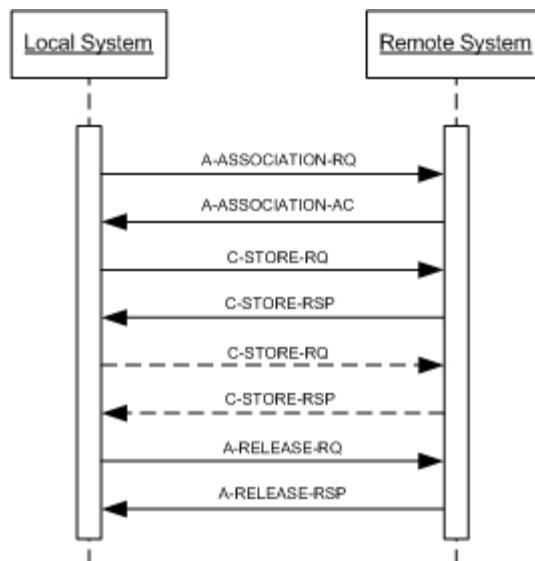

Figure 9: (Real World) Activity - STORE As SCU

4.2.1.3.3.2. Proposed Presentation Contexts

The presentation contexts are defined in the next table.

Table 24: Proposed Presentation Contexts for (Real-World) Activity – Image Export

Presentation Context Table					
Abstract Syntax		Transfer Syntax		Role	Extend ed Negotiation
Name	UID	Name List	UID List		
Comprehensive SR SOP Class	1.2.840.10008.5.1.4.1.1.88.33	Explicit VR Big Endian	1.2.840.10008.1.2.2	SCU	None
		Explicit VR Little Endian	1.2.840.10008.1.2.1		

Presentation Context Table					
Abstract Syntax		Transfer Syntax		Role	Extended Negotiation
Name	UID	Name List	UID List		
Enhanced SR SOP Class	1.2.840.10008.5.1.4.1.1.88.22	Implicit VR Little Endian	1.2.840.10008.1.2	SCU	None
		Explicit VR Big Endian	1.2.840.10008.1.2.2		
		Explicit VR Little Endian	1.2.840.10008.1.2.1		
		Implicit VR Little Endian	1.2.840.10008.1.2		
Grayscale Softcopy Presentation State Storage SOP Class	1.2.840.10008.5.1.4.1.1.11.1	Explicit VR Big Endian	1.2.840.10008.1.2.2	SCU	None
		Explicit VR Little Endian	1.2.840.10008.1.2.1		
		Implicit VR Little Endian	1.2.840.10008.1.2		
Secondary Capture Image Storage SOP Class	1.2.840.10008.5.1.4.1.1.7	Explicit VR Big Endian	1.2.840.10008.1.2.2	SCU	None
		Explicit VR Little Endian	1.2.840.10008.1.2.1		
		Implicit VR Little Endian	1.2.840.10008.1.2		

4.2.1.3.3.3. SOP Specific Conformance for Storage SOP Classes

This section and sub-section include the manufacturer SOP and Dataset specific information as well the status codes and their corresponding behavior.

4.2.1.3.3.3.1. Dataset Specific Conformance for C-STORE-RQ

Detail regarding the Dataset Specific response behavior will be reported in this section. This includes the dataset specific behavior, i.e. error codes, error and exception handling, time-outs, etc.

Table 25: Status Response

Service Status	Error Code	Further Meaning	Behavior
Success	0000	Successful stored	
Failure	A7xx	Refused: Out of Resources	Association released. Storage job fails.
	A900	Error: Data Set does not match SOP Class	Association released. Storage job fails
	C000	Error: cannot understand	Association released. Storage job fails
Warning	B000	Coercion of Data Elements	Storage job continues
	B007	Data Set does not match SOP Class	Storage job continues
	B006	Elements Discarded	Storage job continues

4.2.1.4. Association Acceptance Policy

The Application Entity may reject Association attempts as shown in the table below.

Table 26: Association Reject Reasons

Result	Source	Reason/Diagnosis	Behavior
1 - rejected permanent	1 - DICOM UL service-user	1 - no-reason-given	
		2 - application-context-name-not-supported	
		3 - calling-AE-title-not-recognized	
	2 - DICOM UL service provider (ACSE related function)	7 - called-AE-title-not-recognized	
		1 - no-reason-given	
		2 - protocol-version-not-supported	
2 - rejected-transient	3 - DICOM UL service provider (Presentation related function)	1 - temporary-congestion	
		2 - local-limit-exceeded	
		1 - DICOM UL service-user	
	2 - DICOM UL service provider (ACSE related function)	1 - no-reason-given	
		2 - application-context-name-not-supported	
		3 - calling-AE-title-not-recognized	
3 - DICOM UL service provider (Presentation related function)	7 - called-AE-title-not-recognized		
	1 - no-reason-given		
	2 - protocol-version-not-supported		
		1 - temporary-congestion	
		2 - local-limit-exceeded	

The behavior of the AE for sending an Association abort is summarized in next table.

Table 27: Association Abort Policies

Source	Reason/Diagnosis	Behavior
0 - DICOM UL service-user (initiated abort)	0 - reason-not-specified	
2 - DICOM UL service-provider (initiated abort)	0 - reason-not-specified	
	1 - unrecognized-PDU	
	2 - unexpected-PDU	
	4 - unrecognized-PDU parameter	
	5 - unexpected-PDU parameter	
	6 - invalid-PDU-parameter value	

4.2.1.4.1. (Real-World) Activity – Verification as SCP

4.2.1.4.1.1. Description and Sequencing of Activities

The ISB DICOM Server will accept and process request for Verification Service that are initiated by remote DICOM entities.

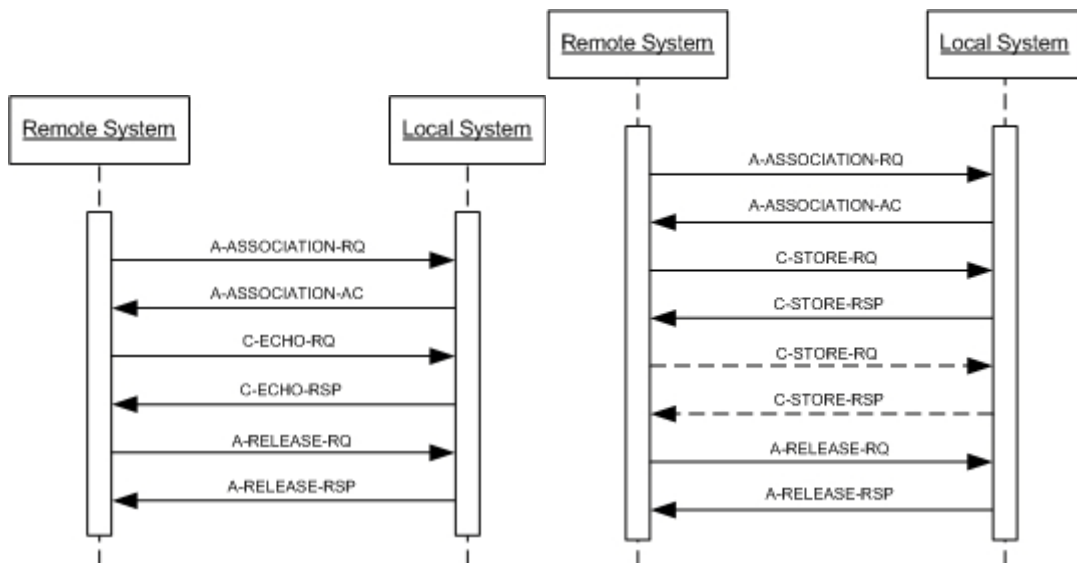

Figure 10: (Real World) Activity - ECHO As SCP

4.2.1.4.1.2. Accepted Presentation Contexts

The presentation contexts are defined in the next table.

Table 28: Acceptable Presentation Contexts for (Real-World) Activity – Verification as SCP

Presentation Context Table					
Abstract Syntax		Transfer Syntax		Role	Extend ed Negotiation
Name	UID	Name List	UID List		
Verification SOP Class	1.2.840.10008.1.1	Explicit VR Big Endian	1.2.840.10008.1.2.2	SCP	None
		Explicit VR Little Endian	1.2.840.10008.1.2.1		
		Implicit VR Little Endian	1.2.840.10008.1.2		

4.2.1.4.1.3. SOP Specific Conformance for Verification SOP Class

This section and sub-section include the manufacturer SOP and Dataset specific information as well the status codes and their corresponding behavior.

4.2.1.4.1.3.1. Dataset Specific Conformance for Verification C-ECHO SCP

Detail regarding the Dataset Specific response behavior will be reported in this section. This part of the section includes the dataset specific behavior, i.e. error codes, error and exception handling, time-outs, etc.

Table 29: Status Response

Service Status	Error Code	Further Meaning	Behavior
Success	0000	Success	

4.2.1.4.2. (Real-World) Activity – Image Import

4.2.1.4.2.1. Description and Sequencing of Activities

The ISB DICOM Server will accept DICOM Storage Service association requests that are initiated by remote DICOM entities. The ISB DICOM Server will process the stored DICOM images and make them available for access by ISB client applications.

The ISB systems accept images of the SOP Classes:

- Computer Radiography Image Storage ^[1]
- Digital X-Ray Image Storage - for Presentation ^[1]
- Digital Mammography X-Ray Image - For Presentation
- Digital Mammography X-Ray Image - For Processing
- MR Image Storage, but only for body part = "Breast"
- Ultrasound Multi-Frame Image Storage, but only for body part = "Breast"
- Ultrasound Image Storage, but only for body part = "Breast"
- Breast Tomosynthesis Image Storage
- Mammography CAD SR
- Secondary Capture Image Storage
- Enhanced SR ^[2]
- Comprehensive SR

[1] Only intended for Body part "Breast"

[2] Only TID4200 and its descendants can be viewed for this SOP.

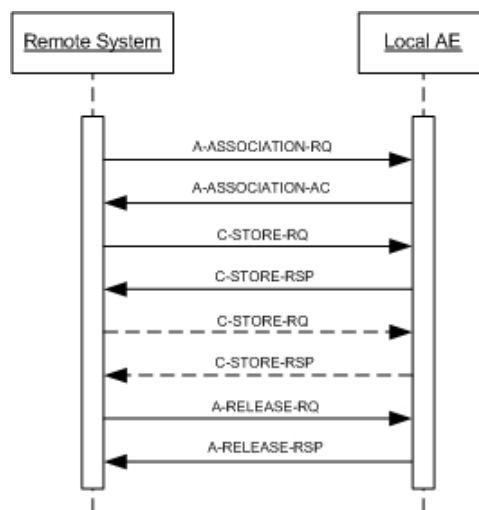

Figure 11: (Real World) Activity - STORE as SCP

4.2.1.4.2.2. Accepted Presentation Contexts

The presentation contexts are defined in the next table.

Table 30: Acceptable Presentation Contexts for (Real-World) Activity – Image Import

Presentation Context Table					
Abstract Syntax		Transfer Syntax		Role	Extended Negotiation
Name	UID	Name List	UID List		
Comprehensive SR SOP Class	1.2.840.10008.5.1.4.1.1.88.33	Explicit VR Big Endian	1.2.840.10008.1.2.2	SCP	None
		Explicit VR Little Endian	1.2.840.10008.1.2.1		
		Implicit VR Little Endian	1.2.840.10008.1.2		
Computed Radiography Image Storage SOP Class	1.2.840.10008.5.1.4.1.1.1	Explicit VR Big Endian	1.2.840.10008.1.2.2	SCP	None
		Explicit VR Little Endian	1.2.840.10008.1.2.1		
		Implicit VR Little Endian	1.2.840.10008.1.2		
Digital Mammography X-Ray Image Storage - Pres. SOP	1.2.840.10008.5.1.4.1.1.1.2	Explicit VR Big Endian	1.2.840.10008.1.2.2	SCP	None
		Explicit VR Little Endian	1.2.840.10008.1.2.1		
		Implicit VR Little Endian			
Digital Mammography X-Ray Image Storage - Proc. SOP	1.2.840.10008.5.1.4.1.1.1.2.1	Explicit VR Big Endian	1.2.840.10008.1.2.2	SCP	None
		Explicit VR Little Endian	1.2.840.10008.1.2.1		
		Implicit VR Little Endian	1.2.840.10008.1.2		
Digital X-Ray Image	1.2.840.10008.5.1.4.1.1.1	Explicit VR Big Endian	1.2.840.10008.1.2.2	SCP	None

Presentation Context Table					
Abstract Syntax		Transfer Syntax		Role	Extended Negotiation
Name	UID	Name List	UID List		
Storage - For Pres. SOP		Explicit VR Little Endian	1.2.840.10008.1.2.1		
		Implicit VR Little Endian	1.2.840.10008.1.2		
Digital X-Ray Image Storage - For Proc. SOP	1.2.840.10008.5.1.4.1.1.1.1	Explicit VR Big Endian	1.2.840.10008.1.2.2	SCP	None
		Explicit VR Little Endian	1.2.840.10008.1.2.1		
		Implicit VR Little Endian	1.2.840.10008.1.2		
		Implicit VR Little Endian	1.2.840.10008.1.2		
Enhanced SR SOP Class	1.2.840.10008.5.1.4.1.1.88.22	Explicit VR Big Endian	1.2.840.10008.1.2.2	SCP	None
		Explicit VR Little Endian	1.2.840.10008.1.2.1		
		Implicit VR Little Endian	1.2.840.10008.1.2		
		Implicit VR Little Endian	1.2.840.10008.1.2		
Grayscale Softcopy Presentation State Storage SOP Class	1.2.840.10008.5.1.4.1.1.11.1	Explicit VR Big Endian	1.2.840.10008.1.2.2	SCP	None
		Explicit VR Little Endian	1.2.840.10008.1.2.1		
		Implicit VR Little Endian	1.2.840.10008.1.2		
		Implicit VR Little Endian	1.2.840.10008.1.2		
Mammography CAD SR SOP Class	1.2.840.10008.5.1.4.1.1.88.50	Explicit VR Big Endian	1.2.840.10008.1.2.2	SCP	None
		Explicit VR Little Endian	1.2.840.10008.1.2.1		
		Implicit VR Little Endian	1.2.840.10008.1.2		
		Implicit VR Little Endian	1.2.840.10008.1.2		
MR Image Storage SOP Class	1.2.840.10008.5.1.4.1.1.4	Explicit VR Big Endian	1.2.840.10008.1.2.2	SCP	None
		Explicit VR Little Endian	1.2.840.10008.1.2.1		
		Implicit VR Little Endian	1.2.840.10008.1.2		
		Implicit VR Little Endian	1.2.840.10008.1.2		
Secondary Capture Image Storage SOP Class	1.2.840.10008.5.1.4.1.1.7	Explicit VR Big Endian	1.2.840.10008.1.2.2	SCP	None
		Explicit VR Little Endian	1.2.840.10008.1.2.1		
		Implicit VR Little Endian	1.2.840.10008.1.2		
		Implicit VR Little Endian	1.2.840.10008.1.2		
Ultrasound Image Storage SOP Class	1.2.840.10008.5.1.4.1.1.6.1	Explicit VR Big Endian	1.2.840.10008.1.2.2	SCP	None
		Explicit VR Little Endian	1.2.840.10008.1.2.1		
		Implicit VR Little Endian	1.2.840.10008.1.2		
		Implicit VR Little Endian	1.2.840.10008.1.2		
Ultrasound Multi-frame Image Storage SOP Class	1.2.840.10008.5.1.4.1.1.3.1	Explicit VR Big Endian	1.2.840.10008.1.2.2	SCP	None
		Explicit VR Little Endian	1.2.840.10008.1.2.1		
		Implicit VR Little Endian	1.2.840.10008.1.2		
		Implicit VR Little Endian	1.2.840.10008.1.2		

The ISB DICOM server will examine the Transfer Syntaxes for a given Presentation Context in the order that they are presented in the Association Request. The first proposed Transfer Syntax that matches a support Transfer Syntax will be accepted for each supported proposed Presentation Context.

4.2.1.4.2.3. SOP Specific Conformance for Storage SOP Classes

This section and sub-section include the manufacturer SOP and Dataset specific information as well the status codes and their corresponding behavior.

4.2.1.4.2.3.1. Dataset Specific Conformance for C-STORE-RSP

This section includes the SOP specific behavior, i.e. error codes, error and exception handling, time-outs, etc. The ISB DICOM Server conforms to the SOPs of the Storage Service Class at level 2(Full). No elements are discarded, but some demographic elements may be modified. Modification of data elements is initiated either by processing of manual edits initiated by end users of the system or automatic edits initiated by information received from ADT or Order Entry Systems (HIS/RIS). Remote DICOM SCUs are able to request high priority processing of DICOM requests by negotiating their DICOM associations with the configurable high priority Application Entity Tile of the DICOM Server. High priority DICOM Storage requests are processed ahead of other pending requests for normal priority storage. The ISB application entity returns the status code of "0" if the receipt of C-STORE message was successful; otherwise it returns one of the following codes: Behavior of an Application Entity SOP class is summarized as shown in next Tables The standard as well as the manufacturer specific status codes and their corresponding behavior are specified.

4.2.2. Radiology Client AE

Detail of this specific Application Entity is specified in this section.

4.2.2.1. SOP Classes

This Application Entity provides Standard Conformance to the following SOP Classes.

Table 31: SOP Classes for Radiology Client AE

SOP Class Name	SOP Class UID	SCU	SCP
Verification SOP Class	1.2.840.10008.1.1	Yes	No
Basic Grayscale Print Management Meta SOP Class	1.2.840.10008.5.1.1.9	Yes	No
>Basic Film Box SOP Class	1.2.840.10008.5.1.1.2	Yes	No

SOP Class Name	SOP Class UID	SCU	SCP
>Basic Film Session SOP Class	1.2.840.10008.5.1.1.1	Yes	No
>Basic Grayscale Image Box SOP Class	1.2.840.10008.5.1.1.4	Yes	No
>Printer SOP Class	1.2.840.10008.5.1.1.16	Yes	No

Note: Any SOP specific behavior is documented later in the conformance statement in the applicable SOP specific conformance section.

4.2.2.2. Association Policies

Each AE specification contains a description of the general association establishment and acceptance policies of the AE.

4.2.2.2.1. General

The DICOM standard application context is specified below.

Table 32: DICOM Application Context

Description	Value
Application Context Name	1.2.840.10008.3.1.1.1

4.2.2.2.2. Number of Associations

The number of simultaneous associations that an Application Entity may support as an Initiator or Acceptor is specified here.

Table 33: Number of associations as an Association Initiator for this AE

Description	Value
Maximum number of simultaneous associations	1

Table 34: Number of associations as an Association Acceptor for this AE

Description	Value
Maximum number of simultaneous associations	0

4.2.2.2.3. Asynchronous Nature

Not supported.

4.2.2.2.4. Implementation Identifying Information

The value supplied for Implementation Class UID and version name are documented here.

Table 35: DICOM Implementation Class and Version for Radiology Client AE

Implementation Class UID	1.3.46.670589.46.1.3.1
Implementation Version Name	Philips_ISB_3_1

4.2.2.2.5. Communication Failure Handling

The behavior of the AE during communication failure is summarized in the next table.

Table 36: Communication Failure Behavior

Exception	Behavior
Timeout	The Association is aborted using A-ABORT and the command is marked as failed. The reason is logged and reported to the user.

4.2.2.3. Association Initiation Policy

The behavior of this Application Entity is summarized in the next Table.

Table 37: Response Status Handler Behavior

Service Status	Error Code	Further Meaning	Behavior
Success	0000		

The Application Entity will respond to a received Association rejection as shown in the next table.

Table 38: Association Rejection response

Result	Source	Reason/Diagnosis	Behavior
1 - rejected-permanent	1 - DICOM UL service-user	1 - no-reason-given	
		2 - application-context-name-not supported	
		3 - calling-AE-title-not-recognized	
		7 - called-AE-title-not-recognized	
	2 - DICOM UL service-provider (ACSE related function)	1 - no-reason-given	
		2 - protocol-version-not-supported	
2 - rejected-transient	1 - DICOM UL service-user	1 - no-reason-given	
		2 - application-context-name-not-supported	
		3 - calling-AE-title-not-recognized	
		7 - called-AE-title-not-recognized	
	2 - DICOM UL service-provider (ACSE related function)	1 - no-reason-given	
		2 - protocol-version-not-supported	
3 - DICOM UL service-provider (Presentation related function)	1 - temporary-congestion		
	2 - local-limit-exceeded		

The behavior of the AE on receiving an Association abort is summarized in the next table.

Table 39: Association Abort Handling

Source	Reason/Diagnosis	Behavior
0 - DICOM UL service-user (initiated abort)	0 - reason-not-specified	
2 - DICOM UL service-provider (initiated abort)	0 - reason-not-specified	
	1 - unrecognized-PDU	
	2 - unexpected-PDU	
	4 - unrecognized-PDU-parameter	
	5 - unexpected-PDU-parameter	
	6 - invalid-PDU-parameter-value	

4.2.2.3.1. (Real-World) Activity – Verification as SCU

4.2.2.3.1.1. Description and Sequencing of Activities

From the IntelliSpace Breast it is not possible to send manual a DICOM C-ECHO RQ message.

4.2.2.3.1.2. Proposed Presentation Contexts

The presentation contexts are defined in the next table.

Table 40: Proposed Presentation Contexts for (Real-World) Activity – Verification as SCU

Presentation Context Table					
Abstract Syntax		Transfer Syntax		Role	Extend ed Negoti ation
Name	UID	Name List	UID List		
Verification SOP Class	1.2.840.10008.1.1	Explicit VR Big Endian	1.2.840.10008.1.2.2	SCU	None
		Explicit VR Little Endian	1.2.840.10008.1.2.1		
		Implicit VR Little Endian	1.2.840.10008.1.2		

4.2.2.3.1.3. SOP Specific Conformance for Verification SOP Class

This section and sub-section include the manufacturer SOP and Dataset specific information as well the status codes and their corresponding behavior.

4.2.2.3.1.3.1. Dataset Specific Conformance for Verification C-ECHO SCU

Not applicable.

4.2.2.3.2. (Real-World) Activity – Print Management As SCU

4.2.2.3.2.1. Description and Sequencing of Activities

The ISB Radiology Client application entity will establish and manage associations with remote DICOM entities to service user requests for DICOM Image Printing. User requests for DICOM Image Printing are initiated by user interaction with the application interface. The system allows to prevent printing annotations (including image information) over the patient’s anatomy.

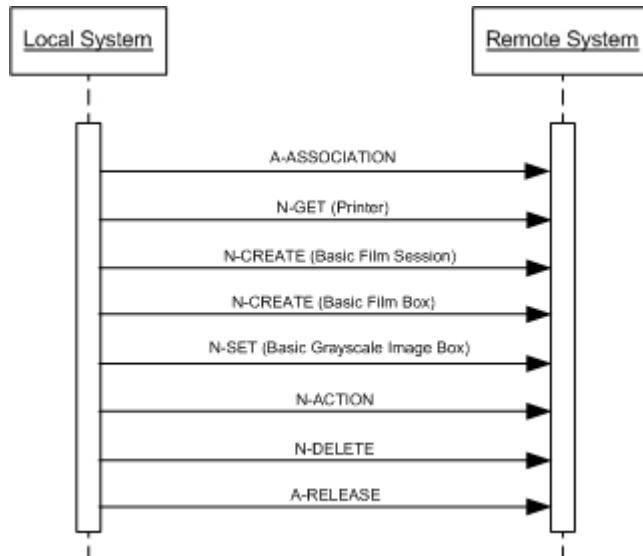

Figure 12: (Real World) Activity - PRINT as SCU

4.2.2.3.2.2. Proposed Presentation Contexts

The presentation contexts are defined in the next table.

Table 41: Proposed Presentation Contexts for (Real-World) Activity – Print Management As SCU

Presentation Context Table					
Abstract Syntax		Transfer Syntax		Role	Extend ed Negoti ation
Name	UID	Name List	UID List		
Basic Grayscale Print Management Meta SOP Class	1.2.840.10008.5.1.1.9			SCU	None
>Basic Film Box SOP Class	1.2.840.10008.5.1.1.2	Explicit VR Big Endian	1.2.840.10008.1.2.2	SCU	None
		Explicit VR Little Endian	1.2.840.10008.1.2.1		
		Implicit VR Little Endian	1.2.840.10008.1.2		
>Basic Film Session SOP Class	1.2.840.10008.5.1.1.1	Explicit VR Big Endian	1.2.840.10008.1.2.2	SCU	None
		Explicit VR Little Endian	1.2.840.10008.1.2.1		
		Implicit VR Little Endian	1.2.840.10008.1.2		
>Basic Grayscale Image Box SOP Class	1.2.840.10008.5.1.1.4	Explicit VR Big Endian	1.2.840.10008.1.2.2	SCU	None
		Explicit VR Little Endian	1.2.840.10008.1.2.1		
		Implicit VR Little Endian	1.2.840.10008.1.2		
>Printer SOP Class	1.2.840.10008.5.1.1.16	Explicit VR Big Endian	1.2.840.10008.1.2.2	SCU	None
		Explicit VR Little Endian	1.2.840.10008.1.2.1		
		Implicit VR Little Endian	1.2.840.10008.1.2		

4.2.2.3.2.3. SOP Specific Conformance for Basic Film Box SOP Class of the Basic Grayscale Print Management Meta SOP Class

This section and sub-section include the manufacturer SOP and Dataset specific information as well the status codes and their corresponding behavior.

4.2.3.2.3.1. Dataset Specific Conformance for Basic Film Box SOP Class N-CREATE-SCU

Detail regarding the Dataset Specific response behavior will be reported in this section.

Table 42: Basic Film Box Presentation Module

Attribute Name	Tag	VR	Value	Presence of Value	Source	Comment
Configuration Information	2010,0150	ST		ALWAYS	AUTO	
Film Orientation	2010,0040	CS	LANDSCAPE, PORTRAIT	ALWAYS	AUTO	
Film Size ID	2010,0050	CS	10INX12IN, 10INX14IN, 11INX14IN, 11INX17IN, 14INX14IN, 14INX17IN, 24CMX24CM, 24CMX30CM, 8_5INX11IN, 8INX10IN, A3, A4	ALWAYS	AUTO	
Image Display Format	2010,0010	ST	STANDARD\1,1	ALWAYS	AUTO	
Max Density	2010,0130	US		ALWAYS	AUTO	
Min Density	2010,0120	US		ALWAYS	AUTO	

4.2.3.2.4. SOP Specific Conformance for Basic Film Session SOP Class of the Basic Grayscale Print Management Meta SOP Class

This section and sub-section include the manufacturer SOP and Dataset specific information as well the status codes and their corresponding behavior.

4.2.3.2.4.1. Dataset Specific Conformance for Basic Film Session SOP Class N-CREATE-SCU

Detail regarding the Dataset Specific response behavior will be reported in this section.

Table 43: Basic Film Session Presentation Module

Attribute Name	Tag	VR	Value	Presence of Value	Source	Comment
Medium Type	2000,0030	CS	BLUE FILM, CLEAR FILM, PAPER	ALWAYS	AUTO	
Number of Copies	2000,0010	IS	1 to 10	ALWAYS	AUTO	
Print Priority	2000,0020	CS	LOW	ALWAYS	AUTO	

4.2.3.2.5. SOP Specific Conformance for Basic Grayscale Image Box SOP Class of the Basic Grayscale Print Management Meta SOP Class

This section and sub-section include the manufacturer SOP and Dataset specific information as well the status codes and their corresponding behavior.

4.2.3.2.5.1. Dataset Specific Conformance for Basic Grayscale Image Box SOP Class N-SET-SCU

Detail regarding the Dataset Specific response behavior will be reported in this section.

Table 44: Image Box Pixel Presentation Module

Attribute Name	Tag	VR	Value	Presence of Value	Source	Comment
Configuration Information	2010,0150	ST		ALWAYS	AUTO	
Image Box Position	2020,0010	US		ALWAYS	AUTO	
Basic Grayscale Image Sequence	2020,0110	SQ		ALWAYS	AUTO	
>Bits Allocated	0028,0100	US	8	ALWAYS	AUTO	
>Bits Stored	0028,0101	US	8	ALWAYS	AUTO	
>Columns	0028,0011	US		ALWAYS	AUTO	
>High Bit	0028,0102	US	7	ALWAYS	AUTO	
>Photometric Interpretation	0028,0004	CS	MONOCHROME2	ALWAYS	AUTO	
>Pixel Aspect Ratio	0028,0034	IS		ALWAYS	AUTO	
>Pixel Data	7FE0,0010	OW/OB		ALWAYS	AUTO	
>Pixel Representation	0028,0103	US	0x0000	ALWAYS	AUTO	
>Rows	0028,0010	US		ALWAYS	AUTO	
>Samples per Pixel	0028,0002	US	1	ALWAYS	AUTO	

This part of the section includes the dataset specific behavior, i.e. error codes, error and exception handling, time-outs, etc.

Table 45: Status Response

Service Status	Error Code	Further Meaning	Behavior
Success	0000		
Failed	<>0000		
Warning	<>0000		

4.2.2.3.2.6. SOP Specific Conformance for Printer SOP Class of the Basic Grayscale Print Management Meta SOP Class

This section and sub-section include the manufacturer SOP and Dataset specific information as well the status codes and their corresponding behavior.

4.2.2.3.2.6.1. Dataset Specific Conformance for Printer SOP Class N-EVENT-REPORT-SCP

Detail regarding the Dataset Specific response behavior will be reported in this section.

Table 46: Printer Module

Attribute Name	Tag	VR	Value	Presence of Value	Source	Comment
Printer Status Info	2110,0020	CS		ALWAYS	AUTO	

4.2.2.4. Association Acceptance Policy

The Application Entity may reject Association attempts as shown in the table below.

Table 47: Association Reject Reasons

Result	Source	Reason/Diagnosis	Behavior
1 - rejected permanent	1 - DICOM UL service-user	1 - no-reason-given 2 - application-context-name-not-supported 3 - calling-AE-title-not-recognized 7 - called-AE-title-not-recognized	
	2 - DICOM UL service provider (ACSE related function)	1 - no-reason-given 2 - protocol-version-not-supported	
	3 - DICOM UL service provider (Presentation related function)	1 - temporary-congestion 2 - local-limit-exceeded	
2 - rejected-transient	1 - DICOM UL service-user	1 - no-reason-given 2 - application-context-name-not-supported 3 - calling-AE-title-not-recognized 7 - called-AE-title-not-recognized	
	2 - DICOM UL service provider (ACSE related function)	1 - no-reason-given 2 - protocol-version-not-supported	
	3 - DICOM UL service provider (Presentation related function)	1 - temporary-congestion 2 - local-limit-exceeded	

The behavior of the AE for sending an Association abort is summarized in next table.

Table 48: Association Abort Policies

Source	Reason/Diagnosis	Behavior
0 - DICOM UL service-user (initiated abort)	0 - reason-not-specified	
2 - DICOM UL service-provider (initiated abort)	0 - reason-not-specified	
	1 - unrecognized-PDU	
	2 - unexpected-PDU	
	4 - unrecognized-PDU parameter	
	5 - unexpected-PDU parameter	
	6 - invalid-PDU-parameter value	

4.3. Network Interfaces

4.3.1. Physical Network Interfaces

The ISB Server provides only DICOM V3.0 TCP/IP Network Communication Support as defined in PS 3.8 of the standard.

TCP/IP is the only protocol stack supported:

Supported physical medium include:

- IEEE 802.3-1995 100BASE-TX (Fast Ethernet)
- IEEE 802.3 1000BASE-X (Fiber Optic Gigabit Ethernet).

1000BASE-X is preferred, especially when using with MR data and IntelliSpace clinical Application package.

4.3.2. Additional Protocols

Not applicable

4.4. Configuration

Any implementation's DICOM conformance may be dependent upon configuration, which takes place at the time of installation. Issues concerning configuration are addressed in this section.

4.4.1. AE Title/Presentation Address Mapping

An important installation issue is the translation from AE title to presentation address. How this is to be performed is described here.

4.4.1.1. Local AE Titles

The local AE title mapping and configuration are specified as:

Table 49: AE Title configuration table

Application Entity	Default AE Title	Default TCP/IP Port
DICOM Server	PHILIPS_SCP (Import)	104
	PHILIPS_SCU (Export)	
	PHILIPS_QRU (iQuery)	107
Radiology Server	PHILIPS_SCP	104

4.4.1.2. Remote AE Title/Presentation Address Mapping

The ISB Server can be configured to accept all systems for import of images.

For Printing, iExport, iQuery the ip-address, AE-Title and Port number must be default.

4.4.2. Parameters

The specification of important operational parameters, their default value and range (if configurable) are specified here.

Table 50: Configuration Parameters Table

Parameter	Configurable	Default Value
General Parameter		
Time-out waiting for acceptance or rejection Response to an Association Open Request (Application Level timeout)	Yes	60sec
Retry Delay	Yes	10min
AE Specific Parameters		
Maximum PDU size the AE can receive - DICOM Server	Yes	Max 63 K
Maximum PDU size the AE can send - DICOM Server	Yes	Max 63 K
Maximum PDU size the AE can receive - Radiology Client	Yes	Max 28 K
Maximum PDU size the AE can send - Radiology Client	Yes	Max 28 K
Number of simultaneous Associations by Service and/or SOP Class – Storage SCP	Yes	20, max 50
Number of simultaneous Associations by Service and/or SOP Class – Storage SCU	No	5
Number of simultaneous Associations by Service and/or SOP Class – Query	No	3
Number of simultaneous Associations by Service and/or SOP Class – Move	No	2

5. Media Interchange

5.1. Implementation model

The implementation model identifies the DICOM Application Entities for Media in specific implementation and relates the Application Entities to Real-World Activities.

5.1.1. Application Data Flow Diagram

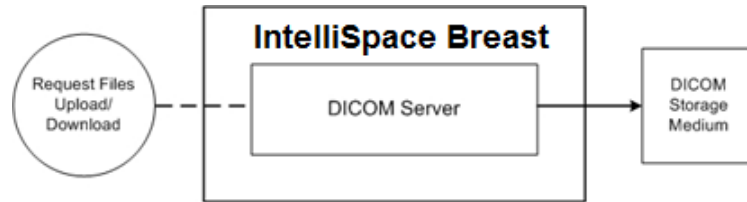

Figure 13: Application Data Flow Diagram (Media)

5.1.2. Functional Definitions of AE's

The IntelliSpace Breast system supports exporting annotations a local directory (USB stick or hard disk).

Used annotations:

- Presentation states
- CAD Structured Reports
- Enhanced SR

5.1.3. Sequencing of Real World Activities

Not applicable.

5.2. AE Specifications

Not applicable

5.2.1. Media AE - Specification

The DICOM Server AE provides standard conformance to the DICOM interchange option of the media storage service class, and follows the specifications as defined in the DICOM standard – Media Storage and File Format for Data Interchange (PS 3.10) and Media Storage Application Profiles (PS 3.11).

The DICOM Server AE supports CD-R media (writing only).

The DICOM Server AE supports FSC onto Media for all supported export storage SOP classes and the private storage SOP classes supported by the DICOM Server AE.

Table 51: DICOM Server AE related Application Profiles

Supported Application Profile	Identifier	Real-World Activities	Roles
General Purpose CD-R Interchange	STD-GEN-CD	Create File-set	FSC
General Purpose DVD	STD-GEN-DVD-JPEG	Create File-set	FSC
General Purpose USB	STD-GEN-USB	Create File-set	FSC

Note:

Read File-set = Display Directory and Read Image

Create File-set = Write Image

5.3. Augmented and Private Application Profiles

Not applicable

5.4. Media Configuration

Any implementation's DICOM conformance may be dependent upon configuration that takes place at the time of installation. Issues concerning configuration are addressed in this section.

6. Support of Character Sets

Any support for character sets in Network and Media services is described here.

Table 52: Supported DICOM Character Sets

Character Set Description	Defined Term	ESC Sequence	ISO Registration Number	Code Element	Character Set
Latin alphabet No. 1	ISO_IR 100	-	ISO-IR 6	G0	ISO 646
		-	ISO-IR 100	G1	Supplementary set of ISO 8859

7. Security

7.1. Security Profiles

Not applicable

8. Annexes of application "Viewer"

8.1. IOD Contents

8.1.1. Created SOP Instance

This section specifies each IOD created (including private IOD's). It should specify the attribute name, tag, VR, and value. The value should specify the range and source (e.g. user input, Modality Worklist, automatically generated, etc.). For content items in templates, the range and source of the concept name and concept values should be specified. Whether the value is always present or not shall be specified.

Abbreviations used in the IOD tables for the column "Presence of Module" are:

ALWAYS The module is always present
 CONDITIONAL The module is used under specified condition

Abbreviations used in the Module table for the column "Presence of Value" are:

ALWAYS The attribute is always present with a value
 EMPTY The attribute is always present without any value (attribute sent zero length)
 VNAP The attribute is always present and its Value is Not Always Present (attribute sent zero length if no value is present)
 ANAP The attribute is present under specified condition – if present then it will always have a value
 VNAPCV The attribute is present under specified condition – if present then its Value is Not Always Present (attribute sent zero length if condition applies and no value is present)
 ANAPEV The attribute is present under specified condition – if present then it will not have any value

Annexes of application "Viewer"

The abbreviations used in the Module table for the column "Source" are:

AUTO The attribute value is generated automatically
 CONFIG The attribute value source is a configurable parameter
 COPY The attribute value source is another SOP instance
 FIXED The attribute value is hard-coded in the application
 IMPLICIT The attribute value source is a user-implicit setting
 MPPS The attribute value is the same as that use for Modality Performed Procedure Step
 MWL The attribute value source is a Modality Worklist
 USER The attribute value source is explicit user input

List of created SOP Classes

Table 53: List of created SOP Classes

SOP Class Name	SOP Class UID
Grayscale Softcopy Presentation State Storage SOP Class	1.2.840.10008.5.1.4.1.1.11.1
Comprehensive SR SOP Class	1.2.840.10008.5.1.4.1.1.88.33
Secondary Capture Image Storage SOP Class	1.2.840.10008.5.1.4.1.1.7

8.1.1.1. Grayscale Softcopy Presentation State Storage SOP Class

Note: Presentation State (GSPS) is supported for images displayed on the diagnostic monitors only.

Table 54: IOD of Created Grayscale Softcopy Presentation State Storage SOP Class Instances

Information Entity	Module	Presence Of Module
Patient	Patient Module	ALWAYS
Study	General Study Module	ALWAYS
	General Series Module	ALWAYS
Series	Presentation Series Module	ALWAYS
	General Equipment Module	ALWAYS
Equipment Presentation State	Presentation State Identification Module	ALWAYS
	Presentation State Relationship Module	ALWAYS
	Displayed Area Module	ALWAYS
	Graphic Annotation Module	CONDITIONAL
	Spatial Transformation Module	CONDITIONAL
	Graphic Layer Module	CONDITIONAL
	Modality LUT Module	CONDITIONAL
	Softcopy VOI LUT Module	CONDITIONAL
	Softcopy Presentation LUT Module	ALWAYS
	SOP Common Module	ALWAYS

Table 55: Patient Module

Attribute Name	Tag	VR	Value	Presence of Value	Source	Comment
Patient ID	0010,0020	LO		VNAP	COPY	
Patient's Birth Date	0010,0030	DA		VNAP	COPY	
Patient's Name	0010,0010	PN		VNAP	COPY	
Patient's Sex	0010,0040	CS		VNAP	COPY	

Table 56: General Study Module

Attribute Name	Tag	VR	Value	Presence of Value	Source	Comment
Accession Number	0008,0050	SH		VNAP	COPY	
Referring Physician's Name	0008,0090	PN		VNAP	COPY	
Study Date	0008,0020	DA		VNAP	COPY	
Study ID	0020,0010	SH		VNAP	COPY	
Study Instance UID	0020,000D	UI		ALWAYS	COPY	
Study Time	0008,0030	TM		VNAP	COPY	
Physician(s) of Record Identification Sequence	0008,1049	SQ		ANAP	COPY	
>Person Identification Code Sequence	0040,1101	SQ		ALWAYS	COPY	
>>Code Meaning	0008,0104	LO		ALWAYS	COPY	
>>Code Value	0008,0100	SH		ALWAYS	COPY	
>>Coding Scheme Designator	0008,0102	SH		ALWAYS	COPY	
Physician(s) Reading Study Identification Sequence	0008,1062	SQ		ANAP	COPY	
>Person Identification Code Sequence	0040,1101	SQ		ALWAYS	COPY	
>>Code Meaning	0008,0104	LO		ALWAYS	COPY	
>>Code Value	0008,0100	SH		ALWAYS	COPY	
>>Coding Scheme Designator	0008,0102	SH		ALWAYS	COPY	
Referring Physician Identification Sequence	0008,0096	SQ		ANAP	COPY	
>Person Identification Code Sequence	0040,1101	SQ		ALWAYS	COPY	
>>Code Meaning	0008,0104	LO		ALWAYS	COPY	
>>Code Value	0008,0100	SH		ALWAYS	COPY	
>>Coding Scheme Designator	0008,0102	SH		ALWAYS	COPY	

Table 57: General Series Module

Attribute Name	Tag	VR	Value	Presence of Value	Source	Comment
Laterality	0020,0060	CS		EMPTY	AUTO	
Patient Position	0018,5100	CS		EMPTY	AUTO	
Series Instance UID	0020,000E	UI		ALWAYS	AUTO	
Series Number	0020,0011	IS		VNAP	AUTO	
Operator Identification Sequence	0008,1072	SQ		ANAP	AUTO	
>Person Identification Code Sequence	0040,1101	SQ		ALWAYS	AUTO	
>>Code Meaning	0008,0104	LO		ALWAYS	AUTO	
>>Code Value	0008,0100	SH		ALWAYS	AUTO	
>>Coding Scheme Designator	0008,0102	SH		ALWAYS	AUTO	
Performing Physician Identification Sequence	0008,1052	SQ		ANAP	COPY	
>Person Identification Code Sequence	0040,1101	SQ		ALWAYS	COPY	
>>Code Meaning	0008,0104	LO		ALWAYS	COPY	
>>Code Value	0008,0100	SH		ALWAYS	COPY	
>>Coding Scheme Designator	0008,0102	SH		ALWAYS	COPY	

Table 58: Presentation Series Module

Attribute Name	Tag	VR	Value	Presence of Value	Source	Comment
Modality	0008,0060	CS	PR	ALWAYS	FIXED	

Table 59: General Equipment Module

Attribute Name	Tag	VR	Value	Presence of Value	Source	Comment
Manufacturer	0008,0070	LO	Philips Medical Systems	ALWAYS	FIXED	

Table 60: Presentation State Identification Module

Attribute Name	Tag	VR	Value	Presence of Value	Source	Comment
Presentation Creation Date	0070,0082	DA		ALWAYS	AUTO	
Presentation Creation Time	0070,0083	TM		ALWAYS	AUTO	
Content Creator's Name	0070,0084	PN		VNAP	AUTO	
Content Description	0070,0081	LO		VNAP	AUTO, USER	
Content Label	0070,0080	CS		ALWAYS	AUTO	
Instance Number	0020,0013	IS		ALWAYS	AUTO	

Table 61: Presentation State Relationship Module

Attribute Name	Tag	VR	Value	Presence of Value	Source	Comment
Referenced Series Sequence	0008,1115	SQ		ALWAYS	AUTO	
>Series Instance UID	0020,000E	UI		ALWAYS	AUTO	
>Referenced Image Sequence	0008,1140	SQ		ALWAYS	AUTO	
>>Referenced SOP Class UID	0008,1150	UI		ALWAYS	AUTO	
>>Referenced SOP Instance UID	0008,1155	UI		ALWAYS	AUTO	

Table 62: Displayed Area Module

Attribute Name	Tag	VR	Value	Presence of Value	Source	Comment
Displayed Area Selection Sequence	0070,005A	SQ		ALWAYS	AUTO	
>Displayed Area Bottom Right Hand Corner	0070,0053	SL		ALWAYS	AUTO	
>Displayed Area Top Left Hand Corner	0070,0052	SL		ALWAYS	AUTO	
>Presentation Size Mode	0070,0100	CS		ALWAYS	AUTO	
>Referenced Image Sequence	0008,1140	SQ		ANAP	AUTO	
>>Referenced SOP Class UID	0008,1150	UI		ALWAYS	AUTO	
>>Referenced SOP Instance UID	0008,1155	UI		ALWAYS	AUTO	

Table 63: Graphic Annotation Module

Attribute Name	Tag	VR	Value	Presence of Value	Source	Comment
Graphic Annotation Sequence	0070,0001	SQ		ANAPCV	AUTO	
>Graphic Layer	0070,0002	CS		ALWAYS	AUTO	
>Graphic Object Sequence	0070,0009	SQ		ANAP	AUTO	
>>Graphic Annotation Units	0070,0005	CS		ALWAYS	AUTO	
>>Graphic Data	0070,0022	FL		ALWAYS	AUTO	
>>Graphic Dimensions	0070,0020	US		ALWAYS	AUTO	
>>Graphic Type	0070,0023	CS		ALWAYS	AUTO	
>>Number of Graphic Points	0070,0021	US		ALWAYS	AUTO	
>Text Object Sequence	0070,0008	SQ		ANAP	AUTO	
>>Unformatted Text Value	0070,0006	ST		ALWAYS	AUTO	

Table 64: Spatial Transformation Module

Attribute Name	Tag	VR	Value	Presence of Value	Source	Comment
Image Horizontal Flip	0070,0041	CS		ALWAYS	AUTO	
Image Rotation	0070,0042	US		ALWAYS	AUTO	

Table 65: Graphic Layer Module

Attribute Name	Tag	VR	Value	Presence of Value	Source	Comment
Graphic Layer Sequence	0070,0060	SQ		ALWAYS	AUTO	
>Graphic Layer	0070,0002	CS		ALWAYS	AUTO	
>Graphic Layer Order	0070,0062	IS		ALWAYS	AUTO	

Table 66: Modality LUT Module

Attribute Name	Tag	VR	Value	Presence of Value	Source	Comment
Rescale Intercept	0028,1052	DS		ANAP	COPY	
Rescale Slope	0028,1053	DS		ANAP	COPY	
Rescale Type	0028,1054	LO		ANAP	COPY	
Modality LUT Sequence	0028,3000	SQ		ANAP	COPY	
>LUT Data	0028,3006	US/OW		ANAP	COPY	

>LUT Descriptor	0028,3002	US/SS		ANAP	COPY	
>Modality LUT Type	0028,3004	LO		ANAP	COPY	

Table 67: Softcopy VOI LUT Module

Attribute Name	Tag	VR	Value	Presence of Value	Source	Comment
Softcopy VOI LUT Sequence	0028,3110	SQ		ALWAYS	AUTO	
>Referenced Image Sequence	0008,1140	SQ		ANAP	AUTO	
>>Referenced SOP Class UID	0008,1150	UI		ALWAYS	AUTO	
>>Referenced SOP Instance UID	0008,1155	UI		ALWAYS	AUTO	
>Window Center	0028,1050	DS		ANAP	AUTO	
>Window Width	0028,1051	DS		ALWAYS	AUTO	

Table 68: Softcopy Presentation LUT Module

Attribute Name	Tag	VR	Value	Presence of Value	Source	Comment
Presentation LUT Shape	2050,0020	CS		ANAP	AUTO	
Presentation LUT Sequence	2050,0010	SQ		ANAP	AUTO	
>LUT Data	0028,3006	US/OW		ALWAYS	AUTO	
>LUT Descriptor	0028,3002	US/SS		ALWAYS	AUTO	

Table 69: SOP Common Module

Attribute Name	Tag	VR	Value	Presence of Value	Source	Comment
SOP Class UID	0008,0016	UI		ALWAYS	AUTO	
SOP Instance UID	0008,0018	UI		ALWAYS	AUTO	
Specific Character Set	0008,0005	CS		ANAP	AUTO	

8.1.1.2. Comprehensive SR SOP Class

Table 70: IOD of Created Enhanced SR SOP Class Instances

Information Entity	Module	Presence Of Module
Patient	Patient Module	
Study	General Study Module	
Study	Patient Study Module	
Series	SR Document Series Module	
Equipment	General Equipment Module	
Document	SR Document General Module	
	SR Document Content Module	

Table 71: Patient Module

Attribute Name	Tag	VR	Value	Presence of Value	Source	Comment
Patient ID	0010,0020	LO		VNAP	COPY	
Patient's Birth Date	0010,0030	DA		VNAP	COPY	
Patient's Name	0010,0010	PN		VNAP	COPY	
Patient's Sex	0010,0040	CS		VNAP	COPY	

Table 72: General Study Module

Attribute Name	Tag	VR	Value	Presence of Value	Source	Comment
Accession Number	0008,0050	SH		VNAP	COPY	
Name of Physician(s) Reading Study	0008,1060	PN		ANAPCV	COPY	
Referring Physician's Name	0008,0090	PN		VNAP	COPY	
Study Date	0008,0020	DA		VNAP	COPY	
Study Description	0008,1030	LO		ANAPCV	COPY	
Study ID	0020,0010	SH		VNAP	COPY	
Study Instance UID	0020,000D	UI		ALWAYS	COPY	
Study Time	0008,0030	TM		VNAP	COPY	
Procedure Code Sequence	0008,1032	SQ		ANAPCV	COPY	
>Code Meaning	0008,0104	LO		ALWAYS	COPY	
>Code Value	0008,0100	SH		ALWAYS	COPY	
>Coding Scheme Designator	0008,0102	SH		ALWAYS	COPY	
>Context Group Extension Flag	0008,010B	CS		ANAPCV	COPY	
Referenced Study Sequence	0008,1110	SQ		ANAPCV	COPY	
>Referenced SOP Class UID	0008,1150	UI		ALWAYS	COPY	

Attribute Name	Tag	VR	Value	Presence of Value	Source	Comment
>Referenced SOP Instance UID	0008,1155	UI		ALWAYS	COPY	

Table 73: Patient Study Module

Attribute Name	Tag	VR	Value	Presence of Value	Source	Comment
Patient's Weight	0010,1030	DS		ANAPCV		

Table 74: SR Document Series Module

Attribute Name	Tag	VR	Value	Presence of Value	Source	Comment
Modality	0008,0060	CS	SR	ALWAYS	FIXED	
Series Instance UID	0020,000E	UI		ALWAYS		
Series Number	0020,0011	IS		ALWAYS	AUTO	
Referenced Performed Procedure Step Sequence	0008,1111	SQ		EMPTY		
>Referenced SOP Class UID	0008,1150	UI		EMPTY		
>Referenced SOP Instance UID	0008,1155	UI		EMPTY		

Table 75: General Equipment Module

Attribute Name	Tag	VR	Value	Presence of Value	Source	Comment
Institution Name	0008,0080	LO		ANAPCV	CONFIG	
Manufacturer	0008,0070	LO	Philips Medical Systems	ALWAYS	FIXED	
Manufacturer's Model Name	0008,1090	LO	ICA	ALWAYS	FIXED	
Software Version(s)	0018,1020	LO	ICA 9.1	ALWAYS	FIXED	

Table 76: SR Document General Module

Attribute Name	Tag	VR	Value	Presence of Value	Source	Comment
Completion Flag	0040,A491	CS		ANAP	AUTO	
Content Date	0008,0023	DA		ALWAYS	AUTO	
Content Time	0008,0033	TM		ALWAYS	AUTO	
Instance Number	0020,0013	IS	1	ALWAYS	FIXED	
Verification Flag	0040,A493	CS	UNVERIFIED	ALWAYS	FIXED	
Performed Procedure Code Sequence	0040,A372	SQ		VNAP	COPY	
>Code Meaning	0008,0104	LO		ALWAYS	COPY	
>Code Value	0008,0100	SH		ALWAYS	COPY	
>Coding Scheme Designator	0008,0102	SH		ALWAYS	COPY	

Table 77: SR Document Content Module

Attribute Name	Tag	VR	Value	Presence of Value	Source	Comment
Value Type	0040,A040	CS		ALWAYS	AUTO	
Concept Name Code Sequence	0040,A043	SQ		ALWAYS	AUTO	
>Code Meaning	0008,0104	LO	Breast Imaging Report	ALWAYS	FIXED	
>Code Value	0008,0100	SH	111400	ALWAYS	FIXED	
>Coding Scheme Designator	0008,0102	SH	DCM	ALWAYS	FIXED	
>Context Group Version	0008,0106	DT		ANAP	AUTO	
Content Sequence	0040,A730	SQ		ALWAYS	USER	According to TID 4200
>Relationship Type	0040,A010	CS		ALWAYS	FIXED	

8.1.1.3. Secondary Capture Image Storage SOP Class

Table 78: IOD of Created Secondary Capture Image Storage SOP Class Instances

Information Entity	Module	Presence Of Module
Patient	Patient Module	
Study	General Study Module	
Study	Patient Study Module	
Series	General Series Module	
Equipment	General Equipment Module	
Equipment	SC Equipment Module	
Image	General Image Module	

Image	Image Pixel Module	
Image	SOP Common Module	

Table 79: Patient Module

Attribute Name	Tag	VR	Value	Presence of Value	Source	Comment
Patient ID	0010,0020	LO		VNAP	COPY	
Patient's Birth Date	0010,0030	DA		VNAP	COPY	
Patient's Name	0010,0010	PN		VNAP	COPY	
Patient's Sex	0010,0040	CS		VNAP	COPY	

Table 80: General Study Module

Attribute Name	Tag	VR	Value	Presence of Value	Source	Comment
Accession Number	0008,0050	SH		VNAP	COPY	
Name of Physician(s) Reading Study	0008,1060	PN		ANAPCV	COPY	
Referring Physician's Name	0008,0090	PN		VNAP	COPY	
Study Date	0008,0020	DA		VNAP	COPY	
Study Description	0008,1030	LO		ANAPCV	COPY	
Study ID	0020,0010	SH		VNAP	COPY	
Study Instance UID	0020,000D	UI		ALWAYS	COPY	
Study Time	0008,0030	TM		VNAP	COPY	
Procedure Code Sequence	0008,1032	SQ		ANAPCV	COPY	
>Code Meaning	0008,0104	LO		ALWAYS	COPY	
>Code Value	0008,0100	SH		ALWAYS	COPY	
>Coding Scheme Designator	0008,0102	SH		ALWAYS	COPY	
>Context Group Extension Flag	0008,010B	CS		ANAPCV	COPY	
Referenced Study Sequence	0008,1110	SQ		ANAPCV	COPY	
>Referenced SOP Class UID	0008,1150	UI		ALWAYS	COPY	
>Referenced SOP Instance UID	0008,1155	UI		ALWAYS	COPY	

Table 81: Patient Study Module

Attribute Name	Tag	VR	Value	Presence of Value	Source	Comment
Patient's Weight	0010,1030	DS		ANAPCV		

Table 82: General Series Module

Attribute Name	Tag	VR	Value	Presence of Value	Source	Comment
Performing Physician's Name	0008,1050	PN		ANAPCV	COPY	
Protocol Name	0018,1030	LO		ALWAYS	FIXED	
Series Date	0008,0021	DA		ALWAYS	AUTO	
Series Instance UID	0020,000E	UI		ALWAYS	AUTO	
Series Number	0020,0011	IS		ALWAYS	AUTO	
Series Time	0008,0031	TM		ALWAYS	AUTO	
Request Attributes Sequence	0040,0275	SQ		ANAPCV	COPY	
>Requested Procedure ID	0040,1001	SH		ANAP	COPY	
>Scheduled Procedure Step Description	0040,0007	LO		ANAPCV	COPY	
>Scheduled Procedure Step ID	0040,0009	SH		ANAP	COPY	
Performed Procedure Step Description	0040,0254	LO		ANAPCV	COPY	
Performed Procedure Step ID	0040,0253	SH		ANAPCV	COPY	
Performed Procedure Step Start Date	0040,0244	DA		ANAPCV	AUTO	
Performed Procedure Step Start Time	0040,0245	TM		ANAPCV	AUTO	
Performed Protocol Code Sequence	0040,0260	SQ		ANAPCV	COPY	
>Code Meaning	0008,0104	LO		ALWAYS	COPY	
>Code Value	0008,0100	SH		ALWAYS	COPY	
>Coding Scheme Designator	0008,0102	SH		ALWAYS	COPY	
>Context Group Extension Flag	0008,010B	CS		ANAPCV	COPY	

Table 83: General Equipment Module

Attribute Name	Tag	VR	Value	Presence of Value	Source	Comment
Institution Name	0008,0080	LO		ANAPCV	CONFIG	

Manufacturer	0008,0070	LO	Philips Medical Systems	VNAP	FIXED	
Manufacturer's Model Name	0008,1090	LO	ICA	ANAPCV	FIXED	
Software Version(s)	0018,1020	LO	ICA 9.1	ALWAYS	FIXED	

Table 84: SC Equipment Module

Attribute Name	Tag	VR	Value	Presence of Value	Source	Comment
Conversion Type	0008,0064	CS	WSD	ALWAYS	FIXED	
Modality	0008,0060	CS		ANAPCV	COPY, FIXED	For Captures we COPY this from the Exam modality. For SCReports the value is fixed to OT

Table 85: General Image Module

Attribute Name	Tag	VR	Value	Presence of Value	Source	Comment
Image Comments	0020,4000	LT	Captured Image, Breast Report Page	ALWAYS	FIXED	
Image Type	0008,0008	CS	Value 1: DERIVED, Value 2: SECONDARY	ALWAYS	FIXED	
Instance Number	0020,0013	IS		ALWAYS	AUTO	

Table 86: Image Pixel Module

Attribute Name	Tag	VR	Value	Presence of Value	Source	Comment
Bits Allocated	0028,0100	US	8	ALWAYS	FIXED	
Bits Stored	0028,0101	US	8	ALWAYS	FIXED	
Columns	0028,0011	US		ALWAYS	AUTO, FIXED	FIXED for report, AUTO for Key image
High Bit	0028,0102	US	7	ALWAYS	FIXED	
Photometric Interpretation	0028,0004	CS	RGB	ALWAYS	FIXED	
Pixel Representation	0028,0103	US	0	ALWAYS	FIXED	
Planar Configuration	0028,0006	US	0	ANAP	FIXED	
Rows	0028,0010	US		ALWAYS	AUTO, FIXED	FIXED for report, AUTO for Key image
Samples per Pixel	0028,0002	US	3	ALWAYS	FIXED	

Table 87: SOP Common Module

Attribute Name	Tag	VR	Value	Presence of Value	Source	Comment
Instance Creation Date	0008,0012	DA		ALWAYS	AUTO	
Instance Creation Time	0008,0013	TM		ALWAYS	AUTO	
SOP Class UID	0008,0016	UI		ALWAYS	COPY	
SOP Instance UID	0008,0018	UI		ALWAYS	AUTO	

8.1.2. Usage of Attributes from Received IOD

The following table describes the functionality which can be used by this application.

Table 88: Functionalities

Functionality	Type1	Optional	Private
Viewer	X		

8.1.2.1. Usage of the Functionality Viewer

The IntelliSpace Breast can display images for the image SOP Classes found in the table below. Additionally Softcopy Presentation State Storage SOP Class and/or findings from the Mammography CAD SR SOP Class can be displayed.

In case images have the value "Breast" or configured synonym for DICOM attribute "Body Part Examined" (0018,0015) the ISB will recognize this as Mammography image.

Table 89: Supported SOP Classes for functionality Viewer

SOP Class name	SOP Class UID
Computed Radiography Image Storage SOP Class	1.2.840.10008.5.1.4.1.1.1
Breast Tomosynthesis Image Storage	1.2.840.10008.5.1.4.1.1.13.1.3
Digital Mammography X-Ray Image Storage - Pres. SOP	1.2.840.10008.5.1.4.1.1.1.2
Digital X-Ray Image Storage - For Pres. SOP	1.2.840.10008.5.1.4.1.1.1.1
MR Image Storage SOP Class	1.2.840.10008.5.1.4.1.1.4
Secondary Capture Image Storage SOP Class	1.2.840.10008.5.1.4.1.1.7
Ultrasound Image Storage SOP Class	1.2.840.10008.5.1.4.1.1.6.1
Ultrasound Multi-frame Image Storage SOP Class	1.2.840.10008.5.1.4.1.1.3.1
Mammography CAD SR SOP Class*	1.2.840.10008.5.1.4.1.1.88.50
Softcopy Presentation State Storage SOP Class *	1.2.840.10008.5.1.4.1.1.11.1

Note *: SOP Classes are no image SOP Classes and have limitations as described in the following sub-directories

8.1.2.1.1. Limitation for Mammography CAD SR SOP Class

The IntelliSpace Breast only supports CAD SR objects when the image object (for presentation) attribute "Spatial Locations Preserved" (0028,135A) has the value YES.

If the value for this DICOM attribute (0028,135A) = NO or REORIENT_ONLY the CAD SR findings will not be visible displayed.

8.1.2.1.2. Limitation for Softcopy Presentation State Storage SOP Class

Presentation States are translated and displayed on the IntelliSpace Breast with some limitations as described in this section.

Explanation of the values used in the column "Implemented for Viewing" of table below:

Yes All Type 1/1C and Type 2/2C tags are supported.

No This feature is not provided and/or the required information is not available.

Partial Some tags are supported.

Table 90: IOD of Used Softcopy Presentation State Storage SOP Class

Module	Implemented for Viewing
Patient Module	Yes.
Clinical Trial Subject Module	No
General Study Module	Yes.
Patient Study Module	No
Clinical Trail Study Module	No
General Series Module	Yes
Clinical Trail Series Module	No
Presentation Series Module	Yes
General Equipment Module	No
Presentation State Identification Module	Yes
Presentation State Relationship Module	Partial
Presentation State Shutter Module	No
Presentation State Mask Module	No
Mask Module	No
Display Shutter Module	Partial
Bitmap Display Module	No
Overlay Plane Module	No
Overlay Activation Module	No
Displayed Area Module	No
Graphic Annotation Module	Partial
Spatial Transformation Module	Yes
Graphic Layer Module	No
Modality LUT Module	Yes
Softcopy VOI LUT Module	Partial
Softcopy Presentation LUT Module	Yes
SOP Common Module	No

For the following modules the limitations are described in the following sections:

- Display Shutter Module
- Graphic Annotation Module
- Soft Copy VOI LUT Module
- Presentation State Relationship Module

8.1.2.1.2.1. Softcopy VOI LUT Module

Softcopy VOI LUT Sequence (0028, 3110) is supported with the exception to:

- Multiple values for Window Center (0028, 1050) and Window Width (0028, 1051).
- (0028,1055) Window Centre & Width Explanation.
- (0028,1030) VOI LUT sequence.

In case a presentation state contains one of the not supported elements, the content is ignored.

Table 91: Supported attributes for Presentation State Relation Module

Attribute Name	Tag	VR	Comment
Referenced Image Sequence	0008,1140	SQ	
>Referenced SOP Class UID	0008,1150	UI	
>Referenced SOP Instance UID	0008,1155	UI	
>Referenced Frame Number	0008,1160	IS	

8.1.2.1.2.2. Display Shutter Module

Only when attribute (0018,1600) Shutter Shape has the value "RECTANGULAR" or "CIRCULAR" (and all other limitations are accepted) the presentation state is applied.

In all other situations like attribute value "POLYGONAL", BITMAP" or unknown Enumerated value, it will display a warning to indicate that the presentation state contains not supported shutters.

When attribute contains more than 1 value, like "CIRCULAR/RECTANGLER", the presentation state is also not applied.

Table 92: Supported attributes for Display Shutter Module

Attribute Name	Tag	VR	Comment
Shutter Shape	0018,1600	CS	Values = RECTANGULAR or CIRCULAR
Shutter Left Vertical Edge	0018,1602	IS	If Shutter Shape = RECTANGULAR
Shutter Right Vertical Edge	0018,1604	IS	If Shutter Shape = RECTANGULAR
Shutter Upper Horizontal Edge	0018,1606	IS	If Shutter Shape = RECTANGULAR
Shutter Lower Horizontal Edge	0018,1608	IS	If Shutter Shape = RECTANGULAR
Center of Circular Shutter	0018,1610	IS	If Shutter Shape = CIRCULAR
Radius of Circular Shutter	0018,1612	IS	If Shutter Shape = CIRCULAR

8.1.2.1.2.3. Graphic Annotation Module

Graphic Annotation Sequence (0070, 0001) is supported with the exception off:

- (0070,0002) Graphic Layer no coloring and layering.
- (0070,0003) Bounding Box Annotation Units,
- (0070,0004) Anchor Point Annotation Units,
- (0070,0005) Graphic Annotation Units for the value DISPLAY.
- (0070,0012) Bounding Box Text Horizontal Justification
- (0070,0023) The Graphic Types INTERPOLATED and POINT.
- (0070,0024) Graphic Filled

When a presentation state contains one of the not supported graphic objects, the presentation state is not applied. It will display a warning ("The selected presentation state is not supported") to indicate that the presentation state contains not supported objects.

When a presentation state contains one of the not supported graphic properties, for example Graphic Filled (0070, 0024), the graphic object will be displayed, however the value of the property is ignored.

Table 93: Supported attributes for Graphic Annotation Module

Attribute Name	Tag	VR	Comment
Graphic Annotation Sequence	0070,0001	SQ	
>Referenced Image Sequence	0008,1140	SQ	
>>Referenced SOP Class UID	0008,1150	UI	

Attribute Name	Tag	VR	Comment
>>Referenced SOP Instance UID	0008,1155	UI	
>>Referenced Frame Number	0008,1160	IS	
>Text Object Sequence	0070,0008	SQ	
>>Unformatted Text Value	0070,0006	ST	If attribute not available warning is displayed.
>>Bounding Box Top Left Hand Corner	0070,0010	FL	No sub pixel coordinates are supported. Coordinates are truncated to integers.
>>Bounding Box Bottom Right Hand Corner	0070,0011	FL	No sub pixel coordinates are supported. Coordinates are truncated to integers.
>>Anchor Point	0070,0014	FL	No sub pixel coordinates are supported. Coordinates are truncated to integers.
>>Anchor Point Visibility	0070,0015	CS	Only if value="Y" If absent interpreted as "Y" (= Yes).
>Graphic Object Sequence	0070,0009	SQ	
>>Graphic Type	0070,0023	CS	Only if value=POLYLINE, CIRCLE, ELLIPSE
>>Graphic Data	0070,0022	FL	

Table 94: Supported attributes for Softcopy VOI LUT Module

Attribute Name	Tag	VR	Comment
Softcopy VOI LUT Sequence	0028,3110	SQ	
>Referenced Image Sequence	0008,1140	SQ	
>>Referenced SOP Class UID	0008,1150	UI	
>>Referenced SOP Instance UID	0008,1155	UI	
>>Referenced Frame Number	0008,1160	IS	
>Windows Center	0028,1050	DS	Multi valued will be ignored
>Windows Width	0028,1051	DS	Multi valued will be ignored

8.1.3. Attribute Mapping

Not applicable.

8.1.4. Coerced/Modified fields

Not applicable.

8.2. Data Dictionary of Private Attributes

Not applicable.

8.3. Coded Terminology and Templates

Not applicable.

8.3.1. Context Groups

Not applicable.

8.3.2. Template Specifications

Not applicable.

8.3.3. Private code definitions

Not applicable.

8.4. Grayscale Image consistency

The high resolution display monitor attached to the product can be calibrated according to the Grayscale Standard Display Function (GSDf). The service/Installation Tool is used together with a luminance meter to measure the Characteristic Curve of the display system and the current ambient light. See the product Service Manual for details on the calibration procedure and supported calibration hardware. The result of the calibration procedure is a Monitor Correction LUT that will be active within the display subsystem after a system reboot.

8.5. Standard Extended/Specialized/Private SOPs

Not applicable.

8.6. Private Transfer Syntaxes

Not applicable.