

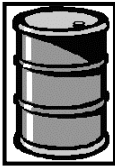

PHILIPS HEALTHCARE	Product Recycling Passport	Page 1 of 5
-------------------------------	-----------------------------------	-------------

Product name	V680 Ventilator	
Identification code(s)	850011, 1103044	
Total weight (in Kg)	12.85kg	
Producer/ Manufacturer	Name company:	Respironics California Inc.
	Address:	2271 Cosmos Court Carlsbad, CA
	Zip code:	92011
	Country:	USA

Recycle Info	Items:	Location
Special attention 		

	Items:	Location
Fluids / Gases		

	Type:	Location
Batteries To be Removed	Lithium Ion	Figure 2 (1)
	Lithium	Figure 2 (2)

Hazardous	Substances:	Location
	Lead (Pb), Printed Circuit Board x6 Figure 1 (1)	Figure 1 (1)
	Lead (Pb), Printed Circuit Board x1 Figure 2 (1)	Figure 2 (3)

Copies are uncontrolled

 To be Removed		

**Show locations of materials mentioned on the previous sheet.
(Please use an illustration/drawing of the system, photos are discouraged)**

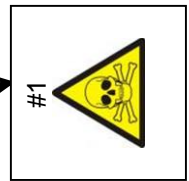
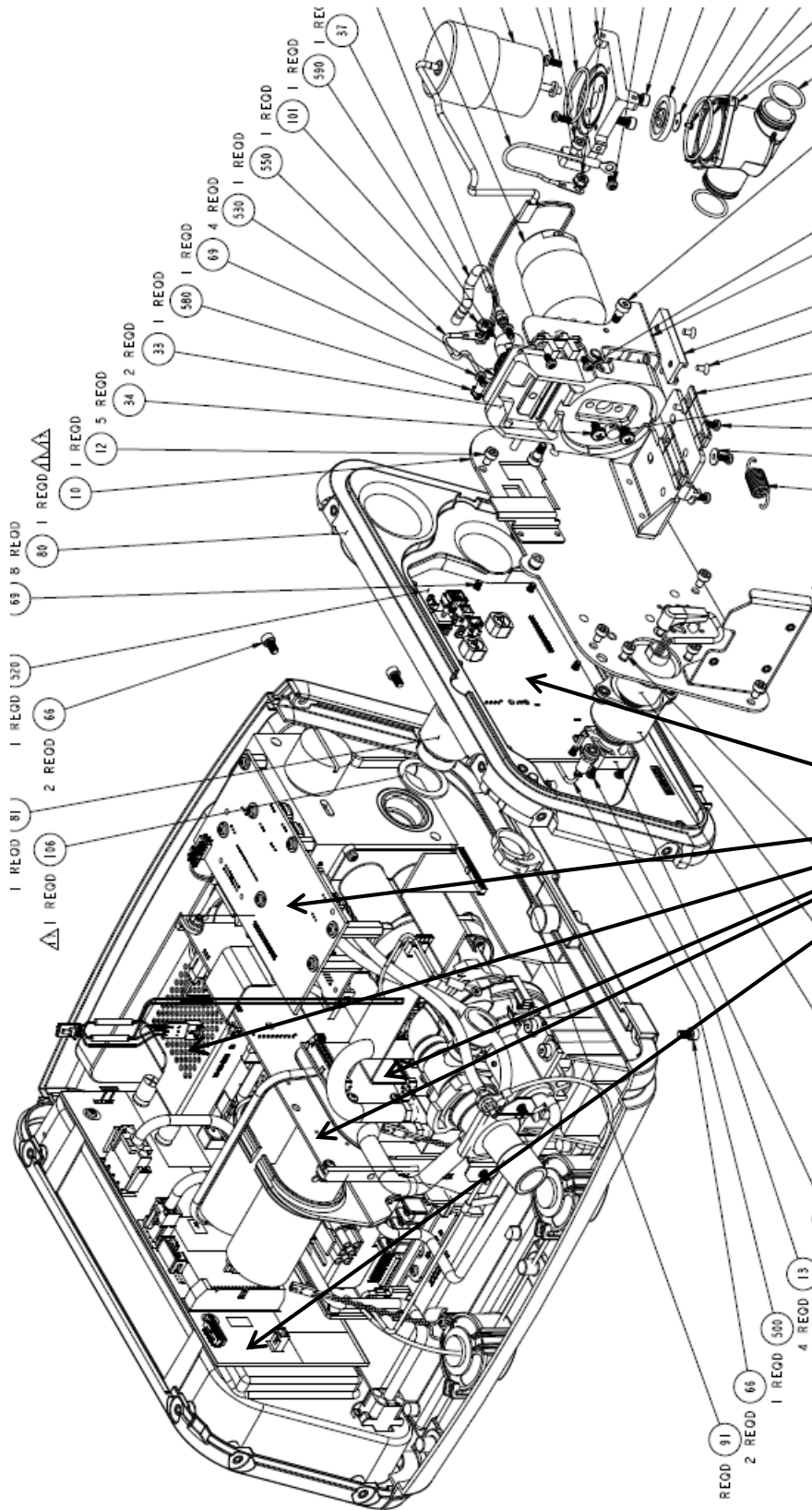
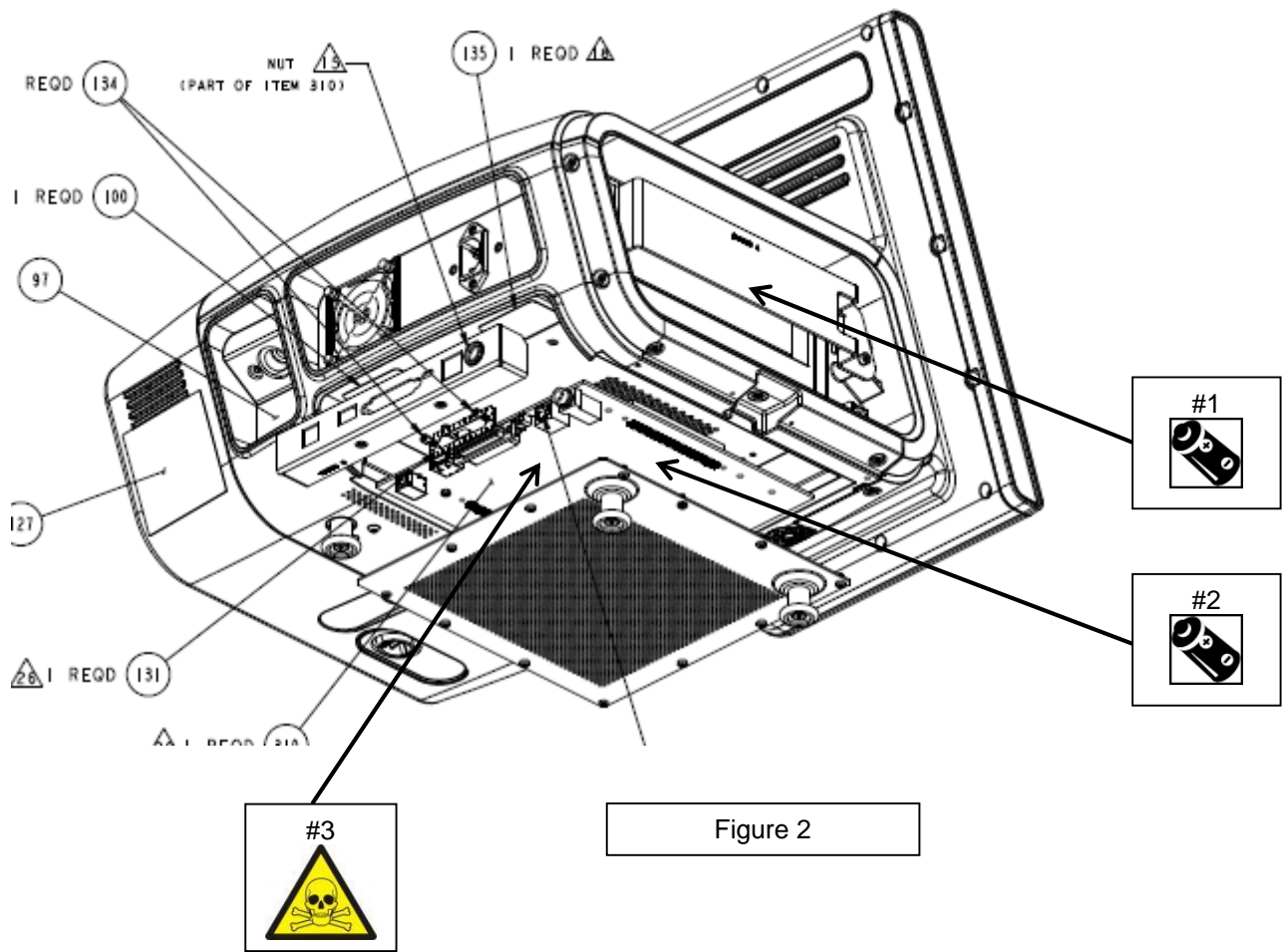

Figure 1



Recycling Passport Revision History

Rev	Description	Date
A	Initial release	January 12, 2016

Copies are uncontrolled