

PHILIPS

RESPIRONICS

DreamStation

BiPAP Pro

Auto BiPAP



User manual

Table of Contents

- Intended Use..... 1
- Important..... 1
- Warnings..... 1
- Cautions..... 2
- Contraindications 2
- Symbols Glossary..... 3
- System Contents..... 4
- How to Contact Philips Respironics 4
- System Overview..... 5
- Installing/Replacing the Air Filters 6
- Where to Place the Device..... 7
- Supplying AC Power to the Device..... 7
- Connecting the Breathing Circuit..... 8
- Navigating the Device Screens..... 9
- Starting the Device..... 9
- Menu Navigation (Therapy ON) and Optional Humidification Settings 10
- Ramp Feature..... 10
- Menu Navigation (Therapy OFF)..... 11
- Bluetooth*[®] Wireless Technology..... 15
- Check Mask Fit..... 16
- Sleep Progress 16
- Altitude Compensation 16
- Device Alerts 17
- Troubleshooting 20
- Accessories 22
- Traveling with the System 24
- Cleaning the Device 24
- Caring for the Filters 24
- Cleaning the Tubing..... 24
- Service..... 24
- Additional Notices..... 25
- Specifications 25
- Disposal..... 27
- EMC Information 27
- Limited Warranty Back Page

Caution: U.S. federal law restricts this device to sale by or on the order of a physician.

Intended Use

The Philips Respironics DreamStation systems deliver positive airway pressure therapy for the treatment of Obstructive Sleep Apnea in spontaneously breathing patients weighing over 30 kg (66 lbs). It is for use in the home or hospital/institutional environment.

Important

The device is to be used only on the instruction of a licensed physician. Your home care provider will make the correct pressure settings and device configurations including accessories, according to your health care professional's prescription.

Several accessories are available to make your OSA treatment with the DreamStation system as convenient and comfortable as possible. To ensure that you receive the safe, effective therapy prescribed for you, use only Philips Respironics accessories.

Warnings

A warning indicates the possibility of injury to the user or the operator.

- This manual serves as a reference. The instructions in this manual are not intended to supersede the health care professional's instructions regarding the use of the device.
- The operator should read and understand this entire manual before using the device.
- This device is not intended for life support.
- The device should be used only with masks and connectors recommended by Philips Respironics or with those recommended by the health care professional or respiratory therapist. A mask should not be used unless the device is turned on and operating properly. The exhalation port(s) associated with the mask should never be blocked. **Explanation of the Warning:** The device is intended to be used with special masks or connectors that have exhalation ports to allow continuous flow of air out of the mask. When the device is turned on and functioning properly, new air from the device flushes the exhaled air out through the mask exhalation port. However, when the device is not operating, enough fresh air will not be provided through the mask, and exhaled air may be rebreathed. Rebreathing of exhaled air for longer than several minutes can in some circumstances lead to suffocation.
- If you are using a full face mask (a mask covering both your mouth and your nose), the mask must be equipped with a safety (entrainment) valve.
- When using oxygen with this system, the oxygen supply must comply with local regulations for medical oxygen.
- Oxygen supports combustion. Oxygen should not be used while smoking or in the presence of an open flame.
- When using oxygen with this system, turn the device on before turning on the oxygen. Turn the oxygen off before turning the device off. This will prevent oxygen accumulation in the device. **Explanation of the Warning:** When the device is not in operation and the oxygen flow is left on, oxygen delivered into the tubing may accumulate within the device's enclosure. Oxygen accumulated in the device enclosure will create a risk of fire.
- When using oxygen with this system, a Philips Respironics Pressure Valve must be placed in-line with the patient circuit between the device and the oxygen source. The pressure valve helps prevent the backflow of oxygen from the patient circuit into the device when the unit is off. Failure to use the pressure valve could result in a fire hazard.
- Do not connect the device to an unregulated or high pressure oxygen source.
- Do not use the device in the presence of a flammable anaesthetic mixture in combination with oxygen or air, or in the presence of nitrous oxide.
- Do not use the device near a source of toxic or harmful vapors.
- Do not use this device if the room temperature is warmer than 35° C (95° F). If the device is used at room temperatures warmer than 35° C (95° F), the temperature of the airflow may exceed 43° C (109° F). This could cause irritation or injury to your airway.
- Do not operate the device in direct sunlight or near a heating appliance because these conditions can increase the temperature of the air coming out of the device.
- Contact your health care professional if symptoms of sleep apnea recur.
- If you notice any unexplained changes in the performance of this device, if it is making unusual or harsh sounds, if it has been dropped or mishandled, if water is spilled into the enclosure, or if the enclosure is broken, disconnect the power cord and discontinue use. Contact your home care provider.
- Repairs and adjustments must be performed by Philips Respironics-authorized service personnel only. Unauthorized service could cause injury, invalidate the warranty, or result in costly damage.
- Do not use any accessories, detachable parts, and materials not recommended by Philips Respironics. Incompatible parts or accessories can result in degraded performance.
- Use only approved cables and accessories. Misuse may affect EMC performance and should be avoided.
- The Health Industry Manufacturers Association recommends that a minimum separation of six inches be maintained between a wireless phone and a pacemaker to avoid potential interference with the pacemaker. The DreamStation on-board *Bluetooth* communication should be considered a wireless phone in this regard.
- Use only power cords supplied by Philips Respironics for this device. Use of power cords not supplied by Philips Respironics may cause overheating or damage to the device and may result in increased emissions or decreased immunity of the equipment or system.
- The device should not be used while stacked or in close approximation to other non-approved devices.
- Do not pull or stretch the tubing. This could result in circuit leaks.

- Inspect the tubing for damage or wear. Discard and replace the tubing as necessary.
 - Periodically inspect electrical cords and cables for damage or signs of wear. Discontinue use and replace if damaged.
 - To avoid electrical shock, always unplug the power cord from the wall outlet before cleaning the device. DO NOT immerse the device in any fluids.
 - If the device is used by multiple persons (such as rental devices), a low-resistance, main flow bacteria filter should be installed in-line between the device and the circuit tubing to prevent contamination.
 - Be sure to route the power cord to the outlet in a way that will prevent the cord from being tripped over or interfered with by chairs or other furniture.
 - This device is activated when the power cord is connected.
 - For safe operation when using a humidifier, the humidifier must always be positioned below the breathing circuit connection at the mask. The humidifier must be level for proper operation.
- Note:** Please see the “Limited Warranty” section of this manual for information on warranty coverage.

Cautions

A Caution indicates the possibility of damage to the device.

- Medical electrical equipment needs special precautions regarding EMC and needs to be installed according to EMC information. Contact your home care provider regarding EMC installation information.
- Mobile RF communications equipment can affect medical electrical equipment.
- Pins of connectors marked with the ESD warning symbol shall not be touched and connections shall not be made without special precautions. Precautionary procedures include methods to prevent build-up of electrostatic charge (e.g., air conditioning, humidification, conductive floor coverings, non-synthetic clothing), discharging one’s body to the frame of the equipment or system or to earth. It is recommended that all individuals that will handle this device understand these precautionary procedures at a minimum as part of their training.
- Before operating the device, ensure that the SD card/filter access door and the modem access door are both closed whenever any of the accessories such as the Link Module or Modem are not installed. Refer to the instructions that came with your accessory.
- Condensation may damage the device. If this device has been exposed to either very hot or very cold temperatures, allow it to adjust to room temperature (operating temperature) before starting therapy. Do not operate the device outside of the operating temperature range shown in the Specifications.
- Do not use extension cords with this device.
- Make sure the filter area on the side of the device is not blocked by bedding, curtains, or other items. Air must flow freely around the device for the system to work properly.
- Do not place the device directly onto carpet, fabric, or other flammable materials.
- Do not place the device in or on any container that can collect or hold water.
- A properly installed, undamaged Philips Respironics blue pollen filter is required for proper operation.
- Tobacco smoke may cause tar build-up within the device, which may result in the device malfunctioning.
- Clogged inlet filters may cause high operating temperatures that may affect device performance. Regularly examine the inlet filters as needed for integrity and to check for accumulated debris.
- Never install a wet filter into the device. You must ensure sufficient drying time for the rinsed filter.
- Always ensure that the DC power cord securely fits into your therapy device prior to use. Contact your home care provider or Philips Respironics to determine if you have the appropriate DC cord for your specific therapy device.
- When DC power is obtained from a vehicle battery, the device should not be used while the vehicle’s engine is running. Damage to the device may occur.
- Only use a Philips Respironics DC Power Cord and Battery Adapter Cable. Use of any other system may cause damage to the device.

Contraindications

















When assessing the relative risks and benefits of using this equipment, the clinician should understand that this device can deliver pressures up to 25 cm H₂O. In the event of certain fault conditions, a maximum pressure of 40 cm H₂O is possible. Studies have shown that the following pre-existing conditions may contraindicate the use of CPAP therapy for some patients:









- Bullous Lung Disease
- Pathologically Low Blood Pressure
- Bypassed Upper Airway
- Pneumothorax
- Pneumocephalus has been reported in a patient using nasal Continuous Positive Airway Pressure. Caution should be used when prescribing CPAP for susceptible patients such as those with: cerebral spinal fluid (CSF) leaks, abnormalities of the cribriform plate, prior history of head trauma, and/or pneumocephalus. (Chest 1989; 96:1425-1426)

The use of positive airway pressure therapy may be temporarily contraindicated if you exhibit signs of a sinus or middle ear infection. Not for use with patients whose upper airways are bypassed. Contact your health care professional if you have any questions concerning your therapy.

Symbols Glossary

The following symbols may appear on the device, power supply and accessories:

Symbol	Definition	Reference
	Operator's manual; operating instructions Consult instructions for use.	IEC 60878 ISO 7000-1641 Symbol 5.4.3, ISO 15223-1
	AC power (Alternating current) Indicates on the rating plate that the equipment is suitable for alternating current only; to identify relevant terminals.	IEC 60417-5032
	DC power (Direct current) Indicates on the rating plate that the equipment is suitable for direct current only; to identify relevant terminals.	IEC 60417-5031
IP22	Drip Proof Equipment	IEC 60529
	Caution, consult accompanying documents.	IEC 60878 Symbol 5.1.2, ISO 15223-1
	Electrostatic sensitive devices (ESD warning symbol) Attention – Observe precautions for handling electrostatic sensitive devices.	IEC 60878 IEC 60417-5134
	Class II equipment (Double Insulated) To identify equipment meeting the safety requirements specified for Class II equipment.	IEC 60878 IEC 60417-5172
	Type BF applied part To identify a type BF applied part complying with IEC 60601-1.	IEC 60878 IEC 60417-5333
	For indoor use only Equipment is designed primarily for indoor use.	IEC 60878 IEC 60417-5957
	Approved for airline use.	RTCA/DO-160G section 21, category M.
	Separate collection for electrical and electronic equipment per EC Directive 2012/19/EU.	-
	Bluetooth® symbol Indicates the device has Bluetooth capabilities.	-
	Non-ionizing electromagnetic radiation Indicates that the equipment includes RF transmitters.	IEC 60878 IEC 60417-5140
SpO₂	Oximeter Connection	-
	Serial Connection Identifies a connector for a serial data connection.	IEC 60878 IEC 60417-5850
	Keep away from sunlight Indicates the medical device needs protection from light sources.	IEC 60878 ISO 7000-0624 Symbol 5.3.2, ISO 15223-1
R_x ONLY	Prescription device Caution: U. S. federal law restricts this device to sale by or on the order of a physician.	-
	Do not disassemble.	-
	Therapy on/off (Stand-by) Identifies the button to turn therapy on or off (puts the device in a stand-by condition).	IEC 60878 IEC 60417-5009

Symbol	Definition	Reference
	Ramp (Variability) To identify the control device by means of which a quantity is controlled. The controlled quantity increases with the figure width.	IEC 60878 IEC 60417-5004
	Keep dry Indicates the medical device that needs to be protected from moisture.	IEC 60878 ISO 7000-0626 Symbol 5.3.4, ISO 15223-1
	Fragile, handle with care Indicates the medical device can be broken or damaged if not handled carefully.	IEC 60878 ISO 7000-0621 Symbol 5.3.1, ISO 15223-1
	Temperature limit Indicates the storage temperature limits to which the medical device can be safely exposed.	IEC 60878 ISO 7000-0632 Symbol 5.3.7, ISO 15223-1
	Humidity limitation Indicates the range of humidity to which the medical device can be safely exposed.	IEC 60878 ISO 7000-2620 Symbol 5.3.8, ISO 15223-1
	Manufacturer Indicates the medical device manufacturer.	IEC 60878 ISO 7000-3082 Symbol 5.1.1, ISO 15223-1
	Date of manufacture Indicates the date when the medical device was manufactured.	IEC 60878 ISO 7000-2497 Symbol 5.1.3, ISO 15223-1
	Reorder number Indicated the manufacturer's catalogue number so the medical device can be identified.	ISO 7000-2493 Symbol 5.1.6, ISO 15223-1
	Serial number Identify the manufacturer's serial number for the medical device.	IEC 60878 ISO 7000-2498 Symbol 5.1.7, ISO 15223-1
Standards Reference ISO 7000:2014, Graphical symbols for use on equipment – Registered symbols ISO 15223-1:2012, Medical devices—Symbols to be used with medical devices labels - General requirements IEC 60417:2002 DB, Graphical symbols for use on equipment IEC/TR 60878:2015, Graphical symbols for electrical equipment in medical practice IEC 60529:1989, Degrees of protection provided by enclosures (IP Code)		

System Contents

Your DreamStation system may include the following items:

- Device
- User manual
- Carrying case
- Power cord
- Power supply ( 1118499)
- SD card
- Flexible tubing
- Reusable blue pollen filter
- Disposable light-blue ultra-fine filter (optional)
- Humidifier (optional)

Note: If any of these items are missing, contact your home care provider.

How to Contact Philips Respironics

Should you experience trouble with this equipment or require assistance setting up, using, or maintaining the device or accessories, please contact your home care provider. If you need to contact Philips Respironics directly, call the Philips Respironics Customer Service department at 1-800-345-6443 or 1-724-387-4000. You can also use the following address:

Respironics, Inc.
1001 Murry Ridge Lane
Murrysville, PA 15668

System Overview



The DreamStation therapy device is designed for the treatment of Obstructive Sleep Apnea (OSA). The DreamStation BiPAP Pro can be set up as a Bi-level device, which delivers two different positive pressure levels: IPAP (Inspiratory Positive Airway Pressure) and EPAP (Expiratory Positive Airway Pressure). The DreamStation BiPAP Auto can also be set up as an Auto Bi-level device. Both BiPAP systems can also be set up as a CPAP (Continuous Positive Airway Pressure) device. Your home care provider will choose the appropriate pressure settings for you.

When prescribed for you, the device provides several special features to help make your therapy more comfortable. The ramp function allows you to lower the pressure when you are trying to fall asleep. The air pressure will gradually increase until your prescription pressure is reached. Also, the Flex comfort feature provides you with pressure relief when you exhale during therapy.

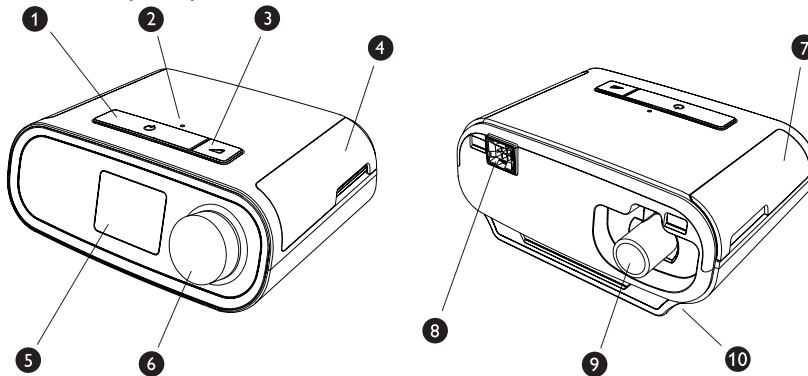
Several accessories are also available for use with your device. Contact your home care provider to purchase any accessories not included with your system.



This figure illustrates some of the device features, described in the following table.

#	Device Feature	Description
1	Therapy On/Off Button 	Starts and stops the airflow for therapy. If the Therapy On/Off button LED is flashing, you may have a pending message. Press or turn the knob to display the message.
2	Ambient Light Sensor	Detects room light levels and adjusts brightness of LCD Display Screen.
3	Ramp Button 	Activates the ramp feature during therapy.
4	Door, SD card & Filter Access	This door lifts open for access to the SD card and filter area.
5	LCD Display Screen	This is the User Interface for the therapy device.
6	Control Dial	Turn the dial to scroll between options on the screen. Press the dial to choose an option.
7	Door, Accessory Access	This door lifts open for access to the (optional) accessories.
8	Humidifier Connector	Humidifier connects to the back of the therapy device. The humidifier pin connector will attach here.
9	Air Outlet Port	Connect the tubing here.
10	Power Inlet	Connect the power cord here.

Installing/Replacing the Air Filters

Caution: A properly installed, undamaged Philips Respironics blue pollen filter is required for proper operation.

The device uses a reusable blue pollen filter that can be rinsed and a disposable light-blue ultra-fine filter. The reusable blue filter screens out normal household dust and pollens, while the light-blue ultra-fine filter provides more complete filtration of very fine particles. The reusable blue filter must be in place at all times when the device is operating. The ultra-fine filter is recommended for people who are sensitive to tobacco smoke or other small particles. The reusable blue filter is supplied with the device. A disposable light-blue ultra-fine filter may also be included. If your filter is not already installed when you receive your device, you must at least install the reusable filter before using the device.

This device has an automatic air filter reminder. Every 30 days, the device will display a message reminding you to check your filters and replace them as directed.

Note: This message is a reminder only. The device does not detect the performance of the filters nor does it recognize when a filter has been rinsed or replaced.

1. Lift up on the filter access door and swing open. If replacing, pull out the old filter assembly.

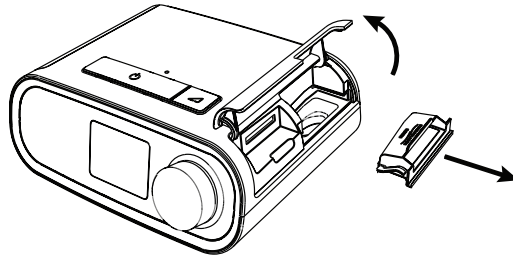

2. If applicable, place a dry, reusable blue pollen filter (1) on top of a new, optional disposable light-blue ultra-fine filter (2) and firmly snap them together.

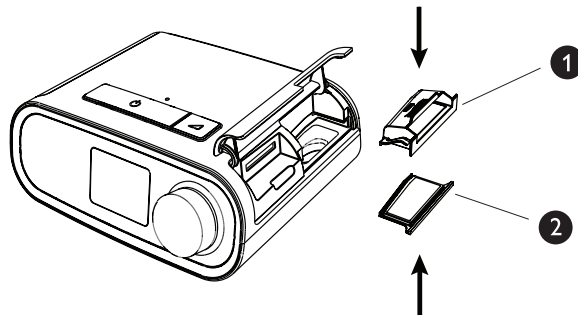

3. Place the new filter assembly back in the side of the therapy device. Swing the door closed.

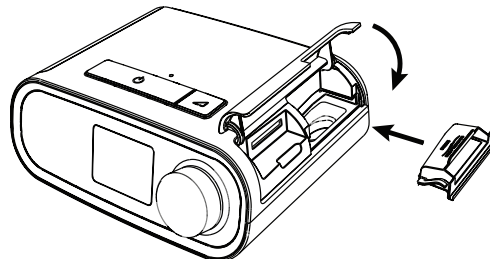

Where to Place the Device

Place the device on a firm, flat surface somewhere within easy reach of where you will use it at a level lower than your sleeping position. Make sure the device is away from any heating or cooling equipment (e.g., forced air vents, radiators, air conditioners).

Note: When positioning the device, make sure that the power cable is accessible because removing power is the only way to turn off the device.

Caution: Make sure the filter area on the side of the device is not blocked by bedding, curtains, or other items. Air must flow freely around the device for the system to work properly.

Caution: Do not place the device directly onto carpet, fabric, or other flammable materials.

Caution: Do not place the device in or on any container that can collect or hold water.

Supplying AC Power to the Device

Complete the following steps to operate the device using AC power:

1. Plug the socket end of the AC power cord (included) into the power supply (also included).
2. Plug the pronged end of the AC power cord into an electrical outlet that is not controlled by a wall switch.

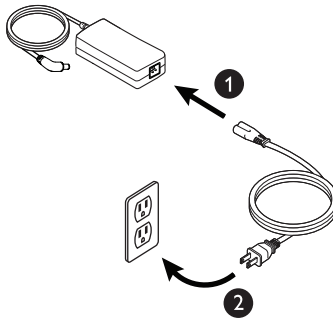

3. Plug the power supply cord's connector into the power inlet on the side of the device.

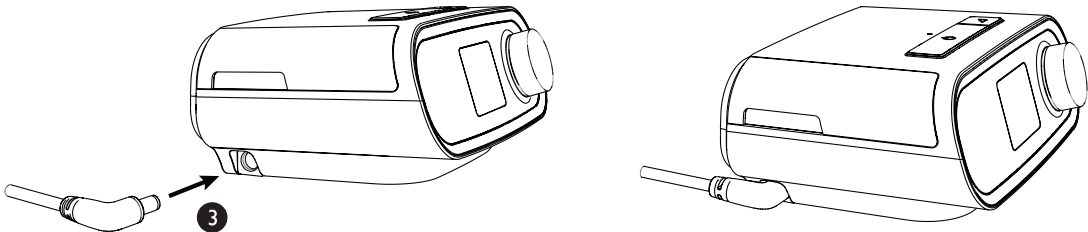

4. Verify that the plug at the side of the device, at the power supply, and at the electrical outlet are fully inserted. This will help to ensure that a secure, reliable electrical connection has been made.

Note: If the following Check Power icon appears on the screen, please repeat step 4.



Important: To remove AC power, disconnect the power supply cord from the electrical outlet.

Warning: Periodically inspect electrical cords and cables for damage or signs of wear. Discontinue use and replace if damaged.

Caution: Do not use extension cords with this device.

Connecting the Breathing Circuit

To use the system, you will need the following accessories in order to assemble the recommended breathing circuit:

- Philips Respironics interface (nasal mask or full face mask) with integrated exhalation port, or Philips Respironics interface with a separate exhalation device (such as the Whisper Swivel II)
- Philips Respironics flexible tubing, 1.83 m (6 ft.)
- Philips Respironics headgear (for the mask)

To connect your breathing circuit to the device, complete the following steps:

1. Connect the flexible tubing to the air outlet on the back of the therapy device. Line up the connector (1) at the top of the heated tube to the top of the air outlet port on the back of the device.

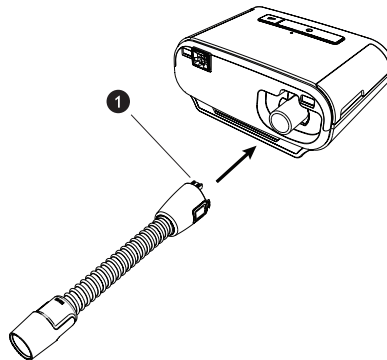

2. Press the tubing into place over the air outlet port until the tabs on the side of the tube click into place in the slots on the sides of the outlet port.

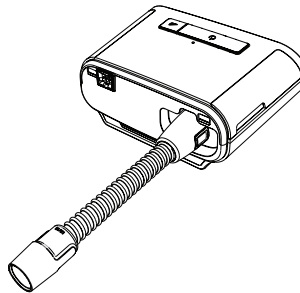

Note: If you are using a standard tube (not shown) instead of a heated tube, simply slide the tubing over the air outlet port on the therapy device.

Note: If you are using the optional 12 mm tubing, an adaptor is required to connect to the therapy device.

Note: If required, connect a bacteria filter to the device air outlet, and then connect the flexible tubing to the outlet of the bacteria filter. When using the bacteria filter, the device performance may be affected. However, the device will remain functional and deliver therapy.

3. Connect the tubing to the mask. For proper placement and positioning, refer to the instructions that came with your mask.

Warning: Do not pull or stretch the tubing. This could result in circuit leaks.

Warning: Inspect the tubing for damage or wear. Discard and replace the tubing as necessary.

4. Attach the headgear to the mask if necessary. Refer to the instructions that came with your headgear.

Warning: If you are using a full face mask (a mask covering both your mouth and your nose), the mask must be equipped with a safety (entrainment) valve.

Warning: If the device is used by multiple persons (such as rental devices), a low-resistance, main flow bacteria filter should be installed in-line between the device and the circuit tubing to prevent contamination.



Navigating the Device Screens



The User Interface (UI) on this device allows you to adjust the device settings and view information about your therapy. The UI is comprised of the display screen and the control dial. Rotate the control dial in either direction to scroll through the menu options on the display screen.

Note: The display is not a touch screen. You must use the control dial to navigate the device menu.

To adjust a setting:

1. Rotate the control dial to your desired menu option.
2. Press the control dial to select that setting.
3. Rotate the control dial to change the setting.
4. Press the control dial again to save the change.

Note: The rotate dial icon  on any screen indicates to rotate the dial to perform an action. The click dial icon  on any screen indicates to press the dial to perform an action.

Note: Pressing the dial when the down arrow  appears on any screen will take you to a sub-menu with more menu options. Pressing the dial when the up arrow  appears on any sub-menu will return you back to the main menu.

Note: The screens shown throughout this manual are examples for reference only. Actual screens may vary based upon device model and provider settings.

Starting the Device

1. Ensure power is supplied to the device. The first screen to display will be the Philips Respironics logo, followed by the device model screen, and then the Home screen.

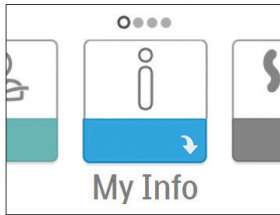

Home Screen

The first time the device is powered on, a pop-up may prompt you to set the time on the device. The default setting is Greenwich Mean Time, but if prompted you may adjust the time in 30 minute increments to match your local time zone. The time can always be adjusted under the “My Setup” menu.

Note: This time setting is not displayed as a clock function on the device. It is only used to align your therapy data for your Provider’s data reports.

2. Put on your mask assembly. Refer to the instructions supplied with the mask.
3. Press the Therapy button () on top of the device to turn on airflow and begin therapy. The current delivered pressure will display on the screen.
4. Make sure that no air is leaking from your mask. If necessary, adjust the mask and headgear until the air leak stops. See the instructions provided with your mask for more information.
Note: A small amount of mask leak is normal and acceptable. Correct large mask leaks or eye irritation from an air leak as soon as possible.
5. If you are using the device in a bed with a headboard, try placing the tubing over the headboard. This may reduce tension on the mask.
6. Press the Therapy button again to turn off therapy.

Note: During therapy, if there is a mains interruption (i.e. power loss) the device will return to the Home screen once power is restored. You may resume therapy as needed.

Menu Navigation (Therapy ON) and Optional Humidification Settings

While the device is delivering therapy, you can adjust Tube Temperature or Humidifier Settings. Rotate the control dial to choose either setting. Press and rotate the dial to change the setting.

Note: If you are using the Humidifier without the Heated Tube, simply just rotate the control dial to change the Humidifier setting.

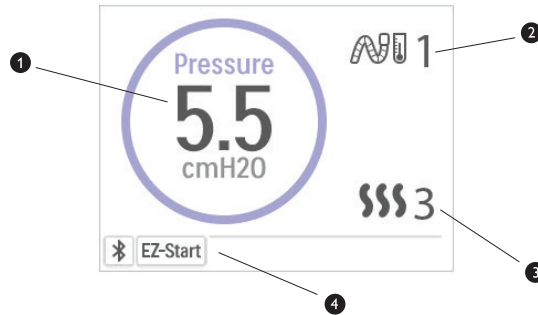

Therapy Pressure Screen

#	Feature	Description
1	Therapy Pressure	Displays the current delivered pressure.
2	Adjustable Tube Temperature Setting	You can change this setting from 0 to 5. Only displays when optional heated tube is connected.
3	Adjustable Humidifier Setting	You can change this setting from 0 to 5. Only displays when humidifier is attached.
4	Enabled Features	Depending on setup, certain enabled therapy features will display here.

Ramp Feature

The device is equipped with an optional ramp feature that your home care provider can enable or disable. This feature reduces the air pressure when you are trying to fall asleep and then gradually increases (ramps) the pressure until your prescription setting is reached, allowing you to fall asleep more comfortably.

If ramp is enabled on your device, after you turn on the airflow, press the Ramp () button on the top of the device. You can use the Ramp button as often as you wish during the night.

When you click the ramp button, the Therapy screen will change to reflect the Ramp pressure, and the green circle will reflect the gradual increase in pressure.



Ramp Pressure Screen

Your device has two ramp modes. Your Provider will select the one that is most appropriate for you. The standard ramp mode increases pressure at a steady rate. Alternately, the SmartRamp mode maintains a constant lower pressure until the device detects that you require more pressure.

Menu Navigation (Therapy OFF)

From the Home screen, you can scroll between the following menus. Only the menus available and enabled on your device will display.

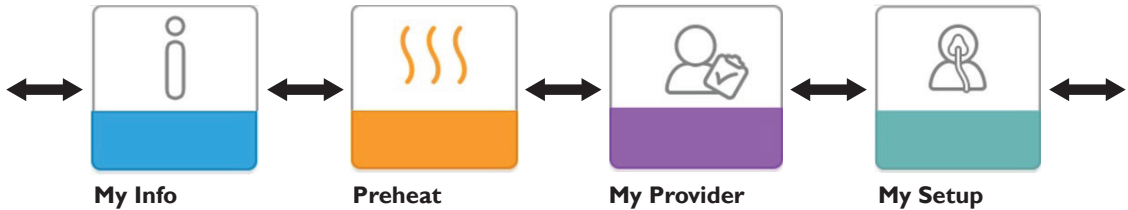

My Info: This menu provides summary statistics of your therapy use.

Preheat (if available): This function lets you warm up your humidifier for 30 minutes before starting a therapy session.



My Provider: This menu contains information that your provider may direct you to read to them so they can better assist you over the phone.

My Setup: This menu contains comfort settings that you can adjust as needed.

My Info:



When you select “My Info”, you will be able to view the following screens. These screens will only display if they are available and enabled on your device. You cannot change settings in the Info menu. These screens are only for reference. Your home care provider may periodically ask you for this information.

Icon	Text	Description
	Therapy Hours	This screen displays the amount of time the user is actually receiving therapy on the device for the most recent 1 day time frame. It also displays the average amount of time the patient is actually receiving therapy over the last 7 days and 30 days.
AHI	AHI	This screen displays the nightly Apnea/Hypopnea indices (AHI) value for the most recent 1 day time frame. It also displays the average of these individual nightly AHI values over a 7 day and a 30 day time frame. This screen only displays if your home care provider has enabled it.
	Mask Fit	Displays the value “100% minus Large Leak”. Large Leak is the percentage of time that the mask leak was so high that it is no longer possible for the device to identify respiratory events with statistical accuracy. Displays the value for the most recent 1 day, as well as the values over last 7 days and 30 days. This screen only displays if your home care provider has enabled it.
Periodic Breathing	Periodic Breathing	Displays the percentage of time that the user experienced periodic breathing. Displays the value for the most recent 1 day time frame, as well as values for the last 7 days and 30 days. If you observe a large increase in the percent of time in periodic breathing indicated here, contact your home care provider for assistance. This screen only displays if your home care provider has enabled it.

Icon	Text	Description
90% Pressure	90% Pressure	This screen displays the nightly value of 90% Pressure for the most recent 1 day time frame. It also displays the average of these individual nightly values of 90% Pressure over a 7 day and a 30 day time frame. Available on the Auto model.
IPAP: 90% Pressure	IPAP: 90% Pressure	Displays the value of 90% inhalation pressure for the most recent 1 day, as well as the average values over the last 7 days and 30 days. Available on the BiPAP Auto model.
EPAP: 90% Pressure	EPAP: 90% Pressure	Displays the value of 90% exhalation pressure for the most recent 1 day, as well as the average values over the last 7 days and 30 days. Available on the BiPAP Auto model.

Preheat (if available):



Preheat On Screen



Preheat Off Screen

Note: The Preheat menu will only display if it is available on your device.



When using a humidifier, the device can preheat the water tank for up to 30 minutes prior to starting therapy. In order to activate the preheat mode, the blower must be “off” and a humidifier must be attached. When “Preheat” is selected, you will be able to turn the control dial to choose between “on” or “off”. Press the control dial again to make your selection. During the 30 minute preheat, you will still be able to use the control dial to select other menu options from the Home screen.

My Provider:



When you select “My Provider”, you will be able to view the following screens. These screens will only display if they are available and enabled on your device. You cannot change settings in the Provider menu. These screens are only for reference. Your home care provider may periodically ask you for this information.



Icon	Text	Description
	Device Info	This screen displays your therapy device information: serial number, model and software version.
	Provider Contact Info	This screen will display the contact information for your provider if it has been uploaded to your device.
	Phone-In	This screen displays the total therapy hours for the device, the total blower hours, the total number of days used when the sessions were greater than 4 hours, and a compliance check number used by your home care provider to validate that the data provided by you is the data taken from this screen.











Icon	Text	Description
	Compliance	This screen displays your start date, the total number of days used when the sessions were greater than 4 hours, and a check code number used by your home care provider.
VIC90	VIC90	This Visual Inspection Check screen will display a check code number created from information gathered over the most recent 90 day period. This 15 digit number will display as: xxx.xxxx.xxxx.xxxx . Your home care provider may periodically ask you for this information.
A-TRIAL	A-Trial	If Auto-Trial mode is available, this screen displays Days: xx/xx (where xx/xx is the number of accumulated trial days / number of selected trial days). Available on the Pro, Auto, BiPAP Pro, and BiPAP Auto models.
	Upload	Allows user to initiate a modem call when an optional Cellular Modem or Wi-Fi Accessory is installed. Signal strength is indicated at the top right of this screen. After the modem upload has finished, the screen will either display a green checkmark with the text "Completed" to indicate a successful upload, or a red X with the text "Failed" to indicate an unsuccessful upload. If the upload fails, initiate an upload a second time, or contact your home care provider if the issue persists. This screen is locked if modem is off.
	Performance Check	Your device is equipped with a self-diagnostic tool called "Performance Check." This tool can evaluate your device for certain errors. It also allows you to share key device settings with your home care provider. Use Performance Check when directed to by your home care provider. At conclusion of the scan, the screen displays a green checkmark if no issue is detected. If device displays a red "X," please contact your home care provider for assistance.



My Setup:



When you select "My Setup", you will be able to view the following screens. These screens will only display if they are available and enabled on your device. You can change the settings in the Setup menu.

Icon	Text	Description
	Ramp	This displays the ramp starting pressure. You can increase or decrease the ramp starting pressure in 0.5 cm H ₂ O increments.
	Ramp Time	When you set the Ramp time, the device increases the pressure from the value set on the Ramp screen to the therapy pressure setting over the length of time specified here.

Icon	Text	Description
	Flex	<p>This allows you to adjust the level of air pressure relief that you feel when you exhale during therapy. Your home care provider can enable or disable this feature. When your provider enables Flex, a level will already be set for you on the device. You can increase or decrease the setting from 1 to 3. The setting of “1” provides a small amount of pressure relief, with higher numbers providing additional relief.</p> <p>Note: If a lock icon  is displayed on this screen, it indicates that your provider has locked this setting and you cannot change it.</p>
	Rise Time	<p>Rise time is the time it takes for the device to change from EPAP to IPAP. This screen allows you to adjust the rise time so you can find the desired setting.</p>
	Humidification	<p>This displays the Humidification Mode being used. You can choose between Fixed or Adaptive Humidification. If a heated tube is being used, the device will automatically switch to Heated Tube Humidification Mode. A “lock” symbol will appear next to the mode setting indicating that so long as the heated tube is attached to the device, this mode cannot be changed. However, the heater plate and tube temperature settings can still be adjusted on the device Therapy screen as normal.</p>
	Mask Type	<p>This setting allows you to adjust the level of air pressure relief based on the specific Philips Respironics mask. Each Philips Respironics mask may have a “System One” resistance control setting. Contact your home care provider if you cannot find this resistance setting for your mask.</p> <p>Note: If a lock icon  is displayed on this screen, it indicates that your provider has locked this setting and you cannot change it.</p>
	Tube Type	<p>This setting allows you to select the correct size diameter tubing that you are using with the device. You can choose either (22) for the Philips Respironics 22 mm tubing, (15) for the Philips Respironics 15 mm tubing, or (12) for the optional Philips Respironics 12 mm tubing.. When using Heated Tubing, the device will automatically change this setting to the appropriate tubing type (15H) and you will not be able to change it.</p> <p>Note: Tubing is identified on the cuff with the tubing identifier symbol: “12”, “15”, or “15H”. 22 mm tubing contains no symbol.</p> <p>Note: If a lock icon  is displayed on this screen, it indicates that your provider has locked this setting and you cannot change it.</p>
	Language	<p>This feature allows you to choose which language to display on the interface. You can choose English or Spanish.</p>
	Check Mask Fit	<p>This feature allows you to check the fit of your mask prior to starting therapy. This is done by measuring the amount of leak.</p>

Icon	Text	Description
	Modem	Allows you to turn modem off temporarily or turn it back on. When modem is turned off, it will automatically turn on again after 3 days. Only displays when modem is installed.
	Bluetooth	Allows you to turn Bluetooth off and on. Also, it allows you to clear the pairing with a compatible Bluetooth device.
	Time	Allows you to adjust the time. The default setting is Greenwich Mean Time, but you may adjust the time in 30 minute increments to match your local time zone. Note: This time setting is not displayed as a clock function on the device. It is only used to align your therapy data for your Provider's data reports.

Bluetooth Wireless Technology

Your device has *Bluetooth* wireless technology, which is one method by which you can transfer your therapy device's data to DreamMapper. DreamMapper is a mobile and web-based system designed to help Obstructive Sleep Apnea (OSA) patients enhance their sleep therapy experience.

Pairing your therapy device to your *Bluetooth* enabled Mobile Device

Note: You can only pair your therapy device to one mobile device at any given time.

Note: Pairing works best when your therapy device and mobile device are in the same room.

Note: The current version of DreamMapper will guide you through these instructions.

Note: After initiating pairing, you will have 30 seconds to complete the setup. After this time, it will be cancelled automatically.

Follow the steps below to manually pair to your mobile phone or tablet.

1. With your therapy device powered up and the blower off, initiate *Bluetooth* Setup from the DreamMapper mobile app.
2. If you need to select from a list of available *Bluetooth* devices, the therapy device will appear as "PR BT XXXX" (XXXX will be the last four digits of the serial number listed on your therapy device).
3. You will be required to confirm pairing via one of these two methods:

- **Your mobile device may ask you to enter a PIN code**

The following icon will appear on your therapy device screen with "Pair?":



Rotate the therapy device's Control Dial to select "yes," and press the Control Dial. Your therapy device will display a 6 digit PIN. Enter this PIN on your mobile device to complete pairing.

- **Your mobile device may ask you to confirm a PIN code**

The following icon will appear on your therapy device screen with a 6 digit PIN and "Pair?":



Verify that the PIN is the same on both the therapy device and the mobile device. If so, rotate the therapy device's Control Dial to select "yes" and press the Control Dial. Then, accept on the mobile device to complete pairing.

Check Mask Fit

The optional check mask fit feature can be enabled or disabled by your home care provider. This feature allows you to check the fit of your mask prior to starting therapy. This is done by measuring the amount of leak. Put on your mask assembly. Refer to your mask instructions if needed. Navigate to the Check Mask Fit screen under “My Setup” and press the control dial to initiate the check.

The device will deliver a test pressure while the screen counts down 40 seconds. A green bar indicates good fit, while a red bar indicates improvement is needed. After the test, normal therapy will start and the screen will either display a green checkmark or a red “X”. The green checkmark indicates that the leak found allows for optimal performance of the device. The red “X” indicates that the leak may affect device performance, however, the device will remain functional and deliver therapy.

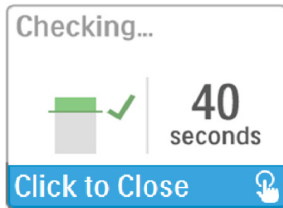

Check Mask Fit Screen

Note: If you choose to try to improve your mask fit, you can stop therapy, adjust the fit of your mask, and rerun the check mask fit. Please refer to the instructions that came with your mask and headgear for the proper fitting procedure.

Sleep Progress

Your device provides summary information about your therapy use each time the therapy is turned off. The first screen displays your “Three Night Summary.” It shows your nightly usage for the last 3 sleep sessions (measured in 24 hour periods, ending at noon each day). The most recent session is displayed in the right hand bar, labeled with the number of hours slept. A green bar indicates that you slept more than 4 hours, and a yellow bar indicates less than 4 hours of use.

The second screen shows the total number of 4+ hour nights that you have slept in the last 30 days. It provides a goal of sleeping at least 4 hours per night for 70% of the last 30 nights. Therefore the goal is 21 “good nights” of use. This screen provides a simple way to track your progress. The screen will stop displaying when you reach the goal, or after the first 90 days of use has passed, whichever comes first.

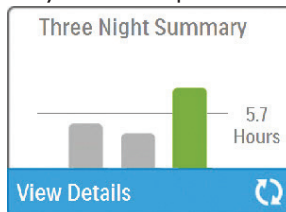

Three Night Summary Screen

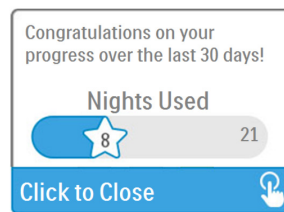

Goal Progress Screen

Altitude Compensation





This device automatically compensates for altitude up to 7,500 feet. No manual adjustment is necessary.







Device Alerts







Device alerts are pop-ups that show up on the UI screen. There are 5 types of alerts described here:





- **Status:** These alerts are just the pop-up screen.
- **Notification:** These alerts consist of the pop-up screen in addition to a blinking Power LED on top of the device.
- **Alert 1:** These alerts consist of the pop-up screen, a blinking Power LED and an audible beep when displayed. This alert will not occur during therapy.
- **Alert 2:** These alerts consist of the pop-up screen, a blinking Power LED and an audible beep when displayed. This alert can occur during therapy.
- **Safe State:** These alerts consist of the pop-up screen, a blinking Power LED and a repeating audible beep.
Note: Status alerts automatically time out after 30 seconds and their pop up screens disappear. All other alerts must be acknowledged to clear.

Alert Summary Table: The following table summarizes the alerts.

Alert	Icon	Type	Description	Possible Cause	Action
Data Activity: Do not remove SD card.		Status	SD card read/write underway.	n/a	No action needed.
Change Accepted		Status	Confirms acceptance of prescription change or device upgrade.	n/a	No action needed.
EZ-Start Pressure Incremented to xx.x		Status	Displays when EZ-Start mode is enabled and device is increasing therapy pressure setting for the next session.	n/a	No action needed.
Oximetry: Good Connection (icon only)		Status	Displays on the therapy screen when the blower is on and 3 seconds of good connection is detected. Appears at the beginning of therapy. This screen will not display again if the finger probe is removed and reapplied unless therapy is stopped and restarted.	n/a	No action needed.
Pair?: 123456 Yes/No		Status	Prompts to accept or decline pairing to a Bluetooth compatible device. This device can be identified by the digits displayed.	n/a	Rotate control dial to accept pairing (Yes), or decline (No), then press control dial to confirm selection.

Alert	Icon	Type	Description	Possible Cause	Action
SD Card Removed.		Notification or Alert 2	Indicates SD card has been removed from therapy device and not reinserted before the start of the current therapy session.	SD card was not reinserted into device.	Reinsert SD card, or click to clear alert.
Oximetry: Good Study (icon only)		Notification	Notifies that user has achieved at least 4 hours of therapy and oximetry use. Appears at the end of therapy.	n/a	Press Control Dial to acknowledge and clear the message.
SD Card Error: Remove and Reinsert		Notification	SD card error detected	Device cannot read the SD card. A problem may exist with the SD card or it was ejected during a writing activity, or it was inserted incorrectly.	Remove SD card and reinsert. If alert continues to occur, replace with another card or contact your provider.
SD Card Full.		Notification	SD card is full.	SD card is full.	Remove SD card and replace with a new card, or contact your provider for a new SD card.
Patient Message (Refer to section)		Notification	Message from your Provider.	n/a	Press Control Dial to acknowledge and clear the message.
Change Rejected		Alert 1	A prescription or settings change was rejected.	Change missing or incorrect.	Contact your provider.
Humidification Error: Contact support if the problem persists.		Status	Humidifier error (only when humidifier is present)	Humidifier heater plate error or humidifier not properly connected to therapy device	Turn off device and disconnect from power. Detach the humidifier, visually check that electrical contacts are clear, then reconnect humidifier and power cord. If alert continues, contact your provider.

Alert	Icon	Type	Description	Possible Cause	Action
Heated Tube Error. Contact support if the problem persists.		Status	Heated tube error (only when heated tube is present)	Heated tube may be overheated or damaged.	Turn off device. Detach heated tube from humidifier, make sure that tube is not covered or obstructed, and then reattach to humidifier. If alert continues, contact your provider.
The attached power supply does not support humidification.		Alert 2	Indicates that the attached power supply is not capable of supporting humidification or heated tube.	Incorrect power supply.	Switch to a Philips Respironics DreamStation power supply that is capable of supporting humidification. Or operate therapy device without humidifier.
Service Required		Safe State	Indicates an error which enters device into "Safe State." This allows power to remain on but airflow is disabled.	Device error.	Press Control Dial to silence alert. Disconnect device from power. Reattach power cord to restore power. If the alert continues to occur, contact your home care provider.
Check Power		Notification	Indicates an incompatible power supply is attached.	Incompatible power supply, or power cord is not fully inserted into device's power inlet.	Confirm power cord is fully inserted into device's power inlet. Confirm a compatible Philips Respironics power supply is attached. Switch to compatible power supply if needed.
Low Voltage		Notification	Low voltage.	Incompatible power supply is attached.	Confirm a compatible Philips Respironics power supply is attached. Switch to compatible power supply if needed. If battery is being used, ensure battery is adequately charged.
Automatic Off		Status	Displayed when therapy ends due to automatic off function.	The mask has been removed.	Put your mask back on, confirm good fit, and turn airflow on to resume therapy.

Alert	Icon	Type	Description	Possible Cause	Action
Inlet blocked. Check filter.		Notification	Blocked airway	Blockage at device inlet.	Check device air inlet is not obstructed. Check air filter(s) are installed properly; replace if needed.
Low Leak: Check Mask and Tube		Notification	Blocked airway	Blockage at tube or mask.	Check tube is not crushed or folded such that air flow is restricted. Check mask is attached properly and without any obstruction.
Check Mask Fit	n/a	Status	Displayed when Check Mask Fit function is enabled from Patient Menu.	n/a	This alert can be cleared by pressing the Control Dial. Otherwise it will time out after 60 seconds.
Loading Language and Rebooting		Status	Displayed when a new language is selected from the menu.	n/a	No action needed. Times out when complete.
Busy		Status	Displayed when the device is temporarily inaccessible due to data communication.	n/a	No action needed.
“Sleep Progress”	n/a	Status	Displays last 3 nights hourly use on first screen, and nights of use on second screen.	n/a	Press Control Dial to acknowledge and clear each screen. Otherwise message times out after 30 seconds.

Troubleshooting

Your device is equipped with a self-diagnostic tool call “Performance Check”. This tool can evaluate your device for certain errors. It also allows you to share key device settings with your Provider. Use Performance Check when directed by your provider.

The table below lists some of the problems you may experience with your device and possible solutions to those problems.

Problem	Why It Happened	What To Do
Nothing happens when you apply power to the device. The backlights on the buttons do not light.	There’s no power at the outlet or the device is unplugged.	If you are using AC power, check the outlet and verify that the device is properly plugged in. Make sure there is power available at the outlet. Make sure the AC power cord is connected correctly to the power supply and the power supply cord is securely connected to the device’s power inlet. If the problem continues to occur, contact your home care provider. Return both the device and power supply to your provider, so they can determine if the problem is with the device or power supply. If you are using DC power, make sure your DC power cord and battery adaptor cable connections are secure. Check your battery. It may need recharged or replaced. If the problem persists, check the DC cord’s fuse following the instructions supplied with your DC cord. The fuse may need to be replaced. If the problem still occurs, contact your home care provider.

Problem	Why It Happened	What To Do
The airflow does not turn on.	There may be a problem with the blower.	Make sure the device is powered correctly. Make sure the Home screen appears on the user interface. Press the Therapy button on top of the device to start airflow. If the airflow does not turn on, there may be a problem with your device. Contact your home care provider for assistance.
The device's display is erratic.	The device has been dropped or mishandled, or the device is in an area with high Electromagnetic Interference (EMI) emissions.	Unplug the device. Reapply power to the device. If the problem continues, relocate the device to an area with lower EMI emissions (away from electronic equipment such as cellular phones, cordless phones, computers, TVs, electronic games, hair dryers, etc.). If the problem still occurs, contact your home care provider for assistance.
The Ramp feature does not work when you press the Ramp button.	Your home care provider did not prescribe Ramp for you, or your therapy pressure is already set to the minimum setting.	If Ramp has not been prescribed for you, discuss this feature with your home care provider to see if they will change your prescription. If your provider has enabled Ramp, but the feature still does not work, check the current pressure setting on the Therapy screen. If the therapy pressure is set to the minimum setting (4.0 cm H ₂ O), or the Ramp starting pressure is the same as the therapy pressure, the Ramp feature will not work. Make sure that the ramp time setting is >0.
The airflow is much warmer than usual.	The air filters may be dirty. The device may be operating in direct sunlight or near a heater.	Rinse or replace the reusable air filter or replace the disposable ultra-fine filter. The temperature of the air may vary somewhat based on your room temperature. Make sure that the device is properly ventilated. Keep the device away from bedding or curtains that could block the flow of air around the device. Make sure the device is away from direct sunlight and heating equipment. If using the humidifier with the device, check the humidifier settings. Refer to the humidifier instructions to make sure the humidifier is working properly. If the problem continues, contact your home care provider.
The airflow pressure feels too high or too low.	The Tubing type setting may be incorrect.	Make sure the Tubing type setting (22 or 15) matches the tubing that you are using (Philips Respironics 22 or 15 mm tubing). If you are using the Heated Tubing, this setting will be 15H and you cannot change it.
Tube Temperature is turned on in "Setup" screen but Heated Tubing is not warm.	Incorrect power supply is being used.	Make sure the 80W power supply is being used or a compatible battery or DC cable is being used.
I'm having difficulty adjusting the heated humidifier setting or the heated tube temperature setting.	The blower is not turned on, or the humidifier or heated tube is not fully connected.	The humidifier setting and tube temperature settings can only be adjusted from the Therapy ON display screen. Confirm that the blower is turned on, and that the settings are visible on the right side of the screen, then adjust to desired comfort. If the blower is on but the humidifier settings are not displayed on the Therapy ON screen, then unplug the device. Confirm that the humidifier and/or heated tube electrical contacts are not obstructed or damaged. Then reconnect the humidifier and/or heated tube, and reconnect the device's power supply. Turn the blower on; if the settings are still not visible, contact your provider for assistance.

Problem	Why It Happened	What To Do
The water in the water chamber runs out before morning.	Water chamber was not full at start of session. Mask leak is excessively high. The ambient conditions are very dry/cool.	Under most conditions, a full water chamber should last for a typical sleep session. However, many factors impact water consumption, including: the ambient temperature and humidity in your bedroom, your humidifier or heated tube settings, the level of mask leak, and the duration of your sleep session. First, make sure that the water chamber is filled to the maximum fill line at the start of your sleep session. Check that your mask is fitted properly, and adjust as needed to reduce mask leak to normal levels. You may use the Check Mask Fit function to evaluate your mask fit. Also, confirm that the device, humidifier, humidifier seals and tube are connected properly and not leaking. You may also choose to lower your humidifier and/or heated tube settings or change the humidification mode from Fixed to Adaptive humidification mode to increase the time that your humidifier water will last.
I hear a leak or whistling sound coming from my therapy device or humidifier (not related to mask leak).	The therapy device air inlet may be obstructed. The humidifier or tube is not fully connected. The humidifier seals are not fully seated or are missing.	Check therapy device air inlet is not obstructed, and filters are free of debris and properly inserted. Confirm that the device, humidifier, and tube are connected properly and not leaking. Confirm that the humidifier lid seal and dry box seal are present and properly seated; if needed, gently press around the perimeter of the seals to reseal them.
I accidentally spilled water into my humidifier basin.	The water chamber has been filled beyond the maximum fill line.	A small amount of water spilled in the basin of the humidifier will not harm your device. A small spill in the humidifier will evaporate under normal humidifier use. However, too much water in the humidifier basin could spill over the humidifier lid hinge and might damage your furniture. Disconnect power from the device. Remove the water chamber, pour out any excess water until the water level is at or below the maximum fill line and set the chamber aside. Separate the humidifier from the therapy device, and pour out the spilled water. Once the heater plate has cooled, wipe the inside of the humidifier with a paper towel or soft cloth. If needed, dry the underside of the humidifier and confirm that your table top is dry. Reconnect the humidifier and power supply, and reinstall the water chamber.

Accessories

There are several accessories available for your DreamStation system such as a Humidifier, Cellular Modem, Wi-Fi Accessory or a Link Module. Contact your home care provider for additional information on the available accessories. When using optional accessories, always follow the instructions enclosed with the accessories.

Caution: Pins of connectors should not be touched. Connections should not be made to these connectors unless ESD precautionary procedures are used. Precautionary procedures include methods to prevent build-up of electrostatic charge (e.g., air conditioning, humidification, conductive floor coverings, non-synthetic clothing), discharging one's body to the frame of the equipment or system or to earth or a large metal object, and bonding oneself by means of a wrist strap to the equipment or system or to earth.

Adding a Humidifier with or without Heated Tubing

You can use the heated humidifier and the heated tube with your device. They are available from your home care provider. A humidifier may reduce nasal dryness and irritation by adding moisture to the airflow.

Warning: For safe operation, the humidifier must always be positioned below the breathing circuit connection at the mask. The humidifier must be level for proper operation.

Note: Refer to the humidifier's instructions for complete setup information.

Using the SD Card

The DreamStation system comes with an SD card inserted in the SD card slot on the side of the device to record information for the home care provider. Your home care provider may ask you to periodically remove the SD card and send it to them for evaluation.

Updating Software Using the SD card

To check which version of software is currently on your device, navigate to My Provider and select Device Info.

You can update the device software using the SD card. The software update must be done when the therapy is off.

1. Insert an SD card with the new software version into the device. A pop-up screen appears asking “Would you like to upgrade software?”
2. Turn the control dial to select Yes and then press the control dial to start the upgrade. The busy icon appears while the upgrade is in progress. Do not remove power from the device.
3. If the software update is successful, the Change Accepted icon appears on the screen. Remove the SD card from the device to restart the device and use the new software.
4. If an SD card error is detected, the Change Rejected icon appears. Remove the SD card and reinsert. If the alert continues to occur, contact Philips Respironics at 1-800-345-6443 or 1-724-387-4000 for a new SD card.

Using the DreamStation Link Module

The Link Module is able to receive oximetry data and transfer it to the therapy device for home use or in a laboratory setting. For use in a laboratory setting, the Link Module also includes an RS-232 (or “DB9”) port to allow remote control of the DreamStation Sleep Therapy Device by a personal computer.

Note: Please consult the instructions that accompany the Link Module for installation and removal.

Note: There are no SpO₂ alarms available.

Note: Oximetry data is not displayed.

Dispose of the module following the same disposal instructions for your therapy device.

Warnings:

- If you notice any unexplained changes in the performance of this device, if it has been dropped or mishandled, if water is spilled into the enclosure, or if the enclosure is broken, discontinue use. Contact your home care provider.
- Repairs and adjustments must be performed by Philips Respironics-authorized service personnel only. Unauthorized service could cause injury, invalidate the warranty, or result in costly damage.
- Do not use any accessories, detachable parts, and materials not recommended by Philips Respironics. Incompatible parts or accessories can result in degraded performance.

Adding Supplemental Oxygen

Oxygen can be added to the patient circuit. Please note the warnings listed below when using oxygen with the device.

Warnings:

- When using oxygen with this system, the oxygen supply must comply with local regulations for medical oxygen.
- Oxygen supports combustion. Oxygen should not be used while smoking or in the presence of an open flame.
- If supplemental oxygen is added at the exit of the flow generator or humidifier, a Philips Respironics Pressure Valve must be placed in-line with the patient circuit between the device and the oxygen source. The pressure valve helps prevent the backflow of oxygen from the patient circuit into the device when the unit is off. Failure to use the pressure valve could result in a fire hazard.
- When adding oxygen at the mask end of the hose, a Philips Respironics Pressure Valve is not required for oxygen flow rates of ≤4 liters per minute. However, the reusable and disposable filters must be in place on the flow generator. Failure to install both the reusable and disposable filters could result in a fire hazard.
Note: Refer to the pressure valve’s instructions for complete setup information.
- When using oxygen with this system, turn the device on before turning on the oxygen. Turn the oxygen off before turning the device off. This will prevent oxygen accumulation in the device.
- Do not connect the device to an unregulated or high pressure oxygen source.

Supplying DC Power to the Device

A Philips Respironics DC power cord can be used to operate this device in a stationary recreational vehicle, boat, or motor home. In addition, a Philips Respironics DC battery adapter cable, when used with a DC power cord, allows the device to be operated from a 12 VDC free-standing battery.

Caution: Always ensure that the DC power cord securely fits into your therapy device prior to use. Contact your home care provider or Philips Respironics to determine if you have the appropriate DC cord for your specific therapy device.

Caution: When DC power is obtained from a vehicle battery, the device should not be used while the vehicle’s engine is running. Damage to the device may occur.

Caution: Only use a Philips Respironics DC Power Cord and Battery Adapter Cable. Use of any other system may cause damage to the device.

Refer to the instructions supplied with the DC power cord and adapter cable for information on how to operate the device using DC power.

Traveling with the System

When traveling, the carrying case is for carry-on luggage only. The carrying case will not protect the system if it is put through checked baggage. If traveling with the optional humidifier, do not travel with water in the water tank. For your convenience at security stations, there is a note on the bottom of the device stating that it is medical equipment and is suitable for airline use. It may be helpful to bring this manual along with you to help security personnel understand the DreamStation device.

If you are traveling to a country with a line voltage different than the one you are currently using, a different power cord or an international plug adaptor may be required to make your power cord compatible with the power outlets of the country to which you are traveling. Contact your home care provider for additional information.

Airline Travel

The device is suitable for use on airlines when the device is operating from an AC or DC power source.

Note: It is not suitable for airline use with any of the modems or humidifiers installed in the unit.

Cleaning the Device

Warning: To avoid electrical shock, always unplug the power cord from the wall outlet before cleaning the device. DO NOT immerse the device in any fluids.

1. Unplug the device, and wipe the outside of the device with a cloth slightly dampened with water and a mild detergent. Let the device dry completely before plugging in the power cord.
2. Inspect the device and all circuit parts for damage after cleaning. Replace any damaged parts.

Caring for the Filters

Under normal usage, you should rinse the reusable blue pollen filter at least once every two weeks and replace it with a new one every six months. The disposable light-blue ultra-fine filter should be replaced after 30 nights of use or sooner if it appears dirty or damaged. DO NOT rinse the ultra-fine filter.

Caution: Dirty inlet filters may cause high operating temperatures that may affect device performance. Regularly examine the inlet filters as needed for integrity and to check for accumulated debris.

This device has an automatic air filter reminder. Every 30 days, the device will display a message reminding you to check your filters and replace them as directed.

Note: This message is a reminder only. The device does not detect the performance of the filters nor does it recognize when a filter has been rinsed or replaced.

1. If the device is operating, stop the airflow. Disconnect the device from the power source.
2. Remove the filter(s) from the device. Refer to the “Installing/Replacing the Air Filters” section of this manual.
3. Take the reusable filter to a sink, turn it upside down, and run warm tap water through the white middle portion of the filter to rinse away any debris.
4. Shake the filter to remove as much water as possible.
5. Allow the filter to air dry completely before reinstalling it. If the filter is damaged, replace it. (Only Philips Respironics-supplied filters should be used as replacement filters.)
6. Reinstall the filters. Refer to the “Installing/Replacing the Air Filters” section of this manual.

Caution: Never install a wet filter into the device. You must ensure sufficient drying time for the filter.

Note: Only Philips Respironics-supplied filters should be used as replacement filters.

Note: Replace the disposable, ultra-fine filter if it is damaged for has accumulated debris.

Cleaning the Tubing

Hand wash the tubing and the mask adaptor (if included) before first use and daily.

For daily cleaning, disconnect the tubing from the device and the mask, and, if included, disconnect the mask adaptor from the tubing. For the 12, 15, or 22 mm flexible tubing, gently wash the tubing and mask adaptor in a solution of warm water and a liquid dish soap. Rinse thoroughly. Air dry. Inspect the tubing and mask adaptor for damage or wear. Discard and replace if necessary.

Note: Refer to the humidifier manual for the instructions on how to clean the heated tube.

Caution: Do not clean the tubing and mask adaptor with bleach, alcohol, solutions containing bleach or alcohol, or solutions containing conditioners or moisturizers.

Caution: Any deviation from these instructions may impact the performance of the product.

Service

The device does not require routine servicing.

Warning: If you notice any unexplained changes in the performance of this device, if it is making unusual or harsh sounds, if it has been dropped or mishandled, if water is spilled into the enclosure, or if the enclosure is broken, disconnect the power cord and discontinue use. Contact your home care provider.

Additional Notices

- Notice:** The *Bluetooth*[®] word mark and logos are registered trademarks owned by Bluetooth SIG, Inc. and any use of such marks by Philips Respironics is under license. Other trademarks and trade names are those of their respective owners.
- Notice:** The DreamStation Therapy Device is capable of transmitting data between the therapy device and a mobile device. This connection between the therapy device and a mobile device is encrypted.
- Notice:** A small portion of the firmware that performs data encryption on the DreamStation device is being utilized under the Apache 2.0 and Mozilla 2.0 licenses. These licenses are available at: www.apache.org/licenses/LICENSE-2.0 and <https://www.mozilla.org/en-US/MPL/2.0/>
- Notice:** This device contains a FCC certified *Bluetooth* radio module (located on the main board). Only the co-location of this *Bluetooth* radio with the radio transceivers of the DreamStation Wi-Fi Accessory and Cellular Modem has been FCC approved and is permitted. For compliance with FCC RF exposure guidelines a minimum distance of 20 cm between the Wi-Fi Accessory or the Cellular Modem and the user's body should be maintained during operation of one of those accessories together with the DreamStation.
- Notice:** FCC ID: THO1116426
- Notice:** THO1116426 is the FCC ID of the FCC certified *Bluetooth* module contained in this device.
- Notice:** Use of non-original manufacturer-approved accessories may violate your local RF exposure guidelines and should be avoided.
- Notice:** This device complies with part 15 of the FCC Rules. Operation is subject to the following two conditions: (1) This device may not cause harmful interference, and (2) this device must accept any interference received, including interference that may cause undesired operation. This equipment has been tested and found to comply with the limits for a Class B digital device, pursuant to Part 15 of the FCC Rules. These limits are designed to provide reasonable protection against harmful interference in a residential installation. This equipment generates, uses, and can radiate radio frequency energy and, if not installed and used in accordance with the instructions, may cause harmful interference to radio communications. However, there is no guarantee that interference will not occur in a particular installation. If this equipment does cause harmful interference to radio, TV reception, or other devices which can be determined by turning the equipment on and off, the user is encouraged to try to correct the interference by one or more of the following measures:
- Reorient or relocate the receiving antenna (on the radio, TV, or other device).
 - Increase the separation between the equipment and receiver.
 - Connect the equipment into an outlet on a circuit different from that to which the receiver is connected.
 - Consult the dealer of the device for help.
- Notice:** Any changes or modifications made to the device that are not expressly approved by Respironics may void the user's authority to operate the equipment.

Specifications

Environmental

Operating Temperature: 5° to 35° C (41° to 95° F)
Storage Temperature: -20° to 60° C (-4° to 140° F)
Relative Humidity (operating & storage): 15 to 95% (non-condensing)
Atmospheric Pressure: 101 to 77 kPa (0 - 2286 m / 0 - 7500 ft)

Physical

Dimensions: 15.7 x 19.3 x 8.4 cm (6.2" L x 7.6" W x 3.3" H)
Weight (Device with power supply): Approximately 1.33 kg (2.94 lbs)

Service Life

The expected service life of the DreamStation Therapy Device and Link Module is 5 years.

Standards Compliance

 This device is designed to conform to the following standards:

IEC 60601-1 General Requirements for Basic Safety and Essential Performance of Medical Electrical Equipment
ISO 80601-2-70 Sleep Apnea Breathing Therapy Equipment
EN 60601-1-2 Electromagnetic Compatibility
RTCA/DO-160G section 21, category M; Emission of Radio Frequency Energy

IEC 60601-1 Classification

Type of Protection Against Electric Shock: Class II Equipment
Degree of Protection Against Electric Shock: Type BF Applied Part
Degree of Protection against Ingress of Water:
Device: Drip Proof, IP22
Link Module: Drip Proof, IP22
80W power supply: Drip Proof, IP22
Mode of Operation: Continuous

Electrical

AC Power Consumption (with 80W power supply): 100 – 240 VAC, 50/60 Hz, 2.0-1.0 A

Note: Power supply is part of the medical electrical equipment.

DC Power Consumption: 12VDC, 6.67 A

Fuses: There are no user-replaceable fuses.

Radio Specifications

Operating Frequency Range: 2402 - 2480 MHz

Maximum Output Power: <10 dBm

Modulation: GFSK, P/4 DQPSK, 8DQPSK

Intake Port Filters

Pollen Filter: 100% Polyester
88% Efficient @ 7-10 micron size

Ultra-fine Filter: Blended Synthetic Fiber
95% Efficient @ 0.5-0.7 micron size

Declared Dual-Number Noise Emissions Values

In accordance with ISO 4871

The A-weighted sound pressure level is:

Device: 26.1 dB(A) with and uncertainty of 2 dB(A).

Device with Humidifier: 27.3 dB(A) with and uncertainty of 2 dB(A).

The A-weighted sound power level is:

Device: 34.1 dB(A) with an uncertainty of 2 dB(A).

Device with Humidifier: 35.3 dB(A) with an uncertainty of 2 dB(A).

Note: Values determined according to noise test code given in ISO 80601-2-70:2015, using the basic standards ISO 3744 and ISO 4871.

Pressure Accuracy

Bi-level Pressure Increments: 4.0 to 25.0 cm H₂O (in 0.5 cm H₂O increments)

Bi-level maximum static pressure accuracy, according to ISO 80601-2-70:2015:

Pressure	Static Accuracy
10 cm H ₂ O	± 0.3 cm H ₂ O

Static pressure accuracy has a measurement uncertainty of 3.7%

Bi-level maximum dynamic pressure variation, according to ISO 80601-2-70:2015:

Pressure	10 BPM	15 BPM	20 BPM
< 10 cm H ₂ O	± 0.4 cm H ₂ O	± 0.5 cm H ₂ O	± 0.8 cm H ₂ O
≥ 10.0 to 25 cm H ₂ O	± 0.5 cm H ₂ O	± 0.8 cm H ₂ O	± 1.0 cm H ₂ O

Dynamic pressure accuracy has a measurement uncertainty of 4.3%

Note: All tests were performed with and without humidifier and with 22 mm and 12 mm standard tubes and 15 mm heated tube.

Bi-level accuracy: Tests were performed according to ISO 80601-2-70:2015

IPAP	EPAP	BPM	IPAP		EPAP	
			Avg. Max Deviation (cm H ₂ O)	StDev Max Deviation (cm H ₂ O)	Avg. Max Deviation (cm H ₂ O)	StDev Max Deviation (cm H ₂ O)
8	4	10	0.38	0.02	0.29	0.01
8	4	15	0.39	0.03	0.29	0.01
8	4	20	0.26	0.17	0.22	0.02
11	7	10	0.37	0.02	0.38	0.01
11	7	15	0.37	0.03	0.36	0.01
11	7	20	0.39	0.05	0.30	0.04
17	13	10	0.35	0.03	0.48	0.01
17	13	15	0.33	0.04	0.47	0.02
17	13	20	0.58	0.04	0.40	0.03
22	18	10	0.36	0.04	0.45	0.02
22	18	15	0.39	0.05	0.53	0.02
22	18	20	0.68	0.11	0.51	0.07
25	21	10	0.42	0.03	0.50	0.02
25	21	15	0.38	0.06	0.58	0.02
25	21	20	0.59	0.22	0.57	0.07

Bi-level accuracy has a measurement uncertainty of 4.3%

The data was analyzed with 25% of the inspiratory and expiratory windows, beginning halfway through each phase (from time=50% to $t=75\%$).

CPAP Pressure Increments: 4.0 to 20.0 cm H₂O (in 0.5 cm H₂O increments)

CPAP maximum static pressure accuracy, according to ISO 80601-2-70:2015:

Pressure	Static Accuracy
10 cm H ₂ O	± 0.3 cm H ₂ O

Static pressure accuracy has a measurement uncertainty of 3.7%

CPAP Maximum dynamic pressure variation, according to ISO 80601-2-70:2015:

Pressure	10 BPM	15 BPM	20 BPM
< 10 cm H ₂ O	± 0.4 cm H ₂ O	± 0.5 cm H ₂ O	± 0.8 cm H ₂ O
≥ 10.0 to 20 cm H ₂ O	± 0.5 cm H ₂ O	± 0.8 cm H ₂ O	± 1.0 cm H ₂ O

Dynamic pressure accuracy has a measurement uncertainty of 4.3%

Note: All tests were performed with and without humidifier and with 22 mm and 12 mm standard tubes and 15 mm heated tube.

Maximum Flow Rate (typical)

Bi-level:

		Test pressures (cm H ₂ O)				
		4.0	9.0	15.0	20.0	25.0
22 mm tubing	Measured pressure at the patient connection port (cm H ₂ O)	3.7	8.4	13.8	18.7	23.6
	Average flow at the patient connection port (l/min)	85	132	131	135	119
15 mm tubing (heated or non-heated)	Measured pressure at the patient connection port (cm H ₂ O)	3.7	8.3	13.9	18.8	23.8
	Average flow at the patient connection port (l/min)	85	127	135	118	108
12 mm tubing	Measured pressure at the patient connection port (cm H ₂ O)	4.0	8.0	14.0	19.0	24.0
	Average flow at the patient connection port (l/min)	85	93	91	102	101

CPAP:

		Test pressures (cm H ₂ O)				
		4.0	8.0	12.0	16.0	20.0
22 mm tubing	Measured pressure at the patient connection port (cm H ₂ O)	3.7	7.7	11.2	14.9	18.9
	Average flow at the patient connection port (l/min)	85	124	131	132	128
15 mm tubing (heated or non-heated)	Measured pressure at the patient connection port (cm H ₂ O)	3.7	7.4	10.9	14.9	18.8
	Average flow at the patient connection port (l/min)	86	127	134	133	117
12 mm tubing	Measured pressure at the patient connection port (cm H ₂ O)	4.0	7.0	11.0	15.0	19.0
	Average flow at the patient connection port (l/min)	85	95	94	100	102

Disposal

Separate collection for electrical and electronic equipment per EC Directive 2012/19/EU. Dispose of this device in accordance with local regulations.

EMC Information

Your unit has been designed to meet EMC standards throughout its Service Life without additional maintenance. There is always an opportunity to relocate your DreamStation Therapy Device within an environment that contains other devices with their own unknown EMC behavior. If you believe your unit is affected by locating it closer to another device, simply separate the devices to remove the condition.

Pressure and Flow Accuracy

The DreamStation Therapy Device is designed to perform within the pressure and flowrate accuracies specified in the user manual. If you suspect that the pressure and/or flow rate accuracy is affected by EMC interference remove power and relocate the device to another area. If performance continues to be affected discontinue use and contact your home care provider.

SpO2 and Pulse Rate Accuracy

The DreamStation Therapy Device is designed to capture the SpO₂ and Pulse Rate oximetry data within the accuracy specification described in the sensor manufacturer's instructions for use. When 4 hours of successful oximetry data have been achieved the device indicates this to the user by displaying "Oximetry: Good Study". If you suspect that your unit is affected by EMC interference remove power and relocate the device to another area. If performance continues to be affected discontinue use and contact your home care provider.

Guidance and Manufacturer's Declaration - Electromagnetic Emissions – This device is intended for use in the electromagnetic environment specified below. The user of this device should make sure it is used in such an environment.

Emissions Test	Compliance	Electromagnetic Environment - Guidance
RF emissions CISPR 11	Group 1	The device uses RF energy only for its internal function. Therefore, its RF emissions are very low and are not likely to cause any interference in nearby electronic equipment.
RF emissions CISPR 11	Class B	The device is suitable for use in all establishments, including domestic establishments and those directly connected to the public low-voltage power supply network.
Harmonic emissions IEC 61000-3-2	Class A	
Voltage fluctuations/Flicker emissions IEC 61000-3-3	Complies	
Emission of Radio Frequency Energy RTCA/DO-160G Section 21	Category M	This device is suitable for use onboard commercial airplanes inside passenger cabin.

Guidance and Manufacturer's Declaration - Electromagnetic Immunity – This device is intended for use in the electromagnetic environment specified below. The user of this device should make sure it is used in such an environment.

Immunity Test	IEC 60601 Test Level	Compliance Level	Electromagnetic Environment - Guidance
Electrostatic Discharge (ESD) IEC 61000-4-2	±8 kV contact	±8 kV contact	Floors should be wood, concrete or ceramic tile. If floors are covered with synthetic material, the relative humidity should be at least 30%.
	±15 kV air	±15 kV air	
Electrical fast Transient/burst IEC 61000-4-4	±2 kV for power supply lines	±2 kV for supply mains	Mains power quality should be that of a typical home or hospital environment.
	±1 kV for input-output lines	±1 kV for input/output lines	
Surge IEC 61000-4-5	±1 kV differential mode	±1 kV differential mode	Mains power quality should be that of a typical home or hospital environment.
	±2 kV common mode	±2 kV for common mode	
Voltage dips, short interruptions and voltage variations on power supply input lines IEC 61000-4-11	<5% U _T (>95% dip in U _T) for 0.5 cycle at 45 degree increments	<5% U _T (>95% dip in U _T) for 0.5 cycle at 45 degree increments	Mains power quality should be that of a typical home or hospital environment. If the user of the device requires continued operation during power mains interruptions, it is recommended that the device be powered from an uninterruptible power supply or a battery.
	70% U _T (30% dip in U _T) for 0.5 seconds	70% U _T (30% dip in U _T) for 0.5 seconds	
	<5% U _T (>95% dip in U _T) for 5 seconds	<5% U _T (>95% dip in U _T) for 5 seconds	
Power frequency (50/60 Hz) magnetic field IEC 61000-4-8	30 A/m	30 A/m	Power frequency magnetic fields should be at levels characteristic of a typical location in a typical hospital or home environment.

NOTE: U_T is the a.c. mains voltage prior to application of the test level.

Guidance and Manufacturer's Declaration - Electromagnetic Immunity – This device is intended for use in the electromagnetic environment specified below. The user of this device should make sure it is used in such an environment.

Immunity Test	IEC 60601 Test Level	Compliance Level	Electromagnetic Environment - Guidance
Conducted RF IEC 61000-4-6	3 Vrms 150 kHz to 80 MHz	3 Vrms 150 kHz to 80 MHz	Portable and mobile RF communications equipment should be used no closer to any part of the device, including cables, than the recommended 30 cm separation distance. Interference may occur in the vicinity of equipment marked with the following symbol: 
	6 Vrms Amateur Radio & ISM Bands between 150 kHz and 80 MHz	6 Vrms Amateur Radio & ISM Bands between 150 kHz and 80 MHz	
Radiated RF IEC 61000-4-3	10 V/m 80 MHz to 2.7 GHz	10 V/m	

Limited Warranty

Respironics, Inc. warrants that the system shall be free from defects of workmanship and materials and will perform in accordance with the product specifications for a period of two (2) years from the date of sale by Respironics, Inc. to the dealer. If the product fails to perform in accordance with the product specifications, Respironics, Inc. will repair or replace – at its option – the defective material or part. Respironics, Inc. will pay customary freight charges from Respironics, Inc. to the dealer location only. This warranty does not cover damage caused by accident, misuse, abuse, alteration, water ingress, and other defects not related to material or workmanship. The Respironics, Inc. Service department shall examine any devices returned for service, and Respironics, Inc. reserves the right to charge an evaluation fee for any returned device as to which no problem is found after investigation by Respironics, Inc. Service.

This warranty is non-transferable by unauthorized distributors of Respironics, Inc. products and Respironics, Inc. reserves the right to charge dealers for warranty service of failed product not purchased directly from Respironics, Inc. or authorized distributors.

Respironics, Inc. disclaims all liability for economic loss, loss of profits, overhead, or consequential damages which may be claimed to arise from any sale or use of this product. Some states do not allow the exclusion or limitation of incidental or consequential damages, so the above limitation or exclusion may not apply to you.

This warranty is given in lieu of all other express warranties. In addition, any implied warranties – including any warranty of merchantability or fitness for the particular purpose – are limited to two years. Some states do not allow limitations on how long an implied warranty lasts, so the above limitation may not apply to you. This warranty gives you specific legal rights, and you may also have other rights which vary from state to state.

To exercise your rights under this warranty, contact your local authorized Respironics, Inc. dealer or contact Respironics, Inc. at:

1001 Murry Ridge Lane
Murrysville, Pennsylvania 15668-8550
1-724-387-4000



Respironics Inc.
1001 Murry Ridge Lane
Murrysville, PA 15668 USA



REF 1120831

1120831 R08
HM 02/28/2018
EN-DOM