

# DICOM Conformance Statement

## Pinnacle<sup>3</sup> Radiotherapy Treatment Planning System R9.8

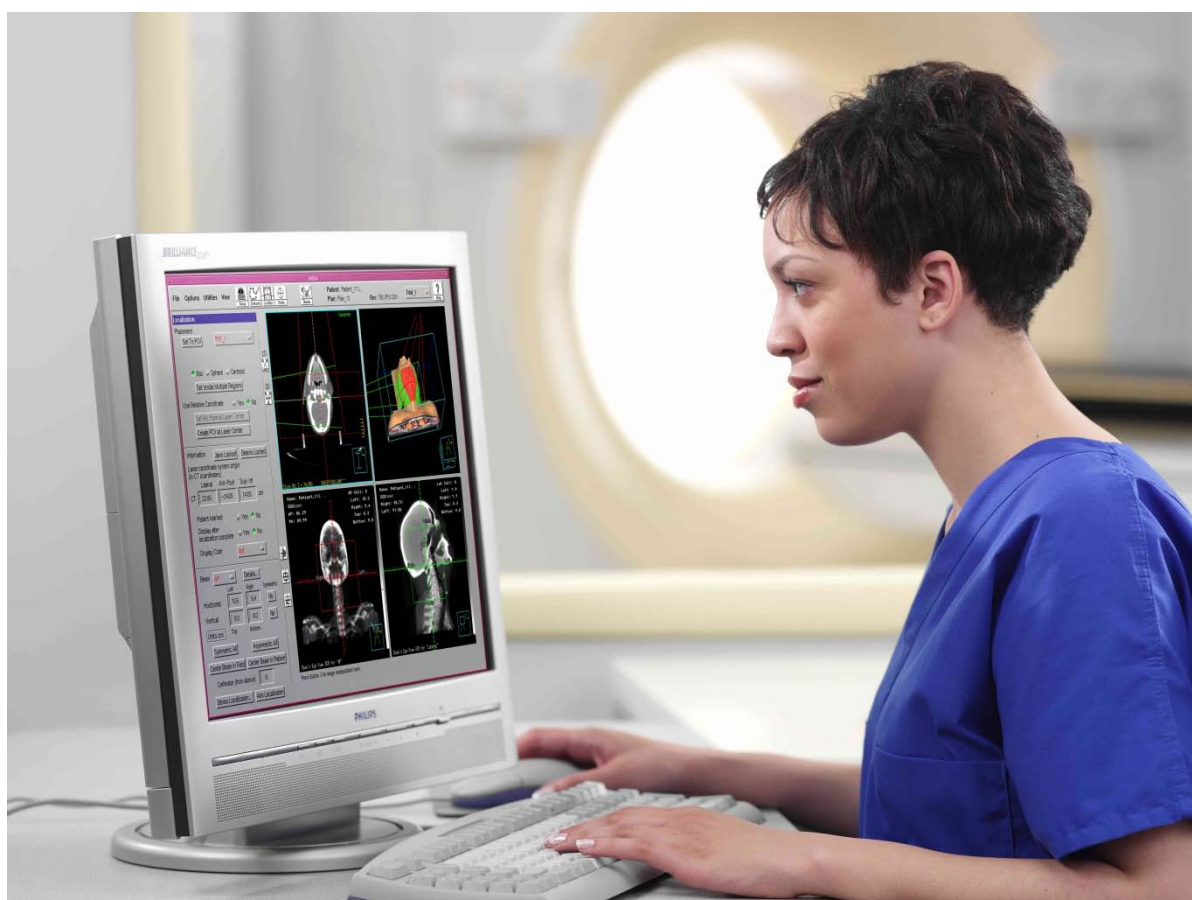

**Issued by:**

Philips Healthcare  
P.O. Box 10.000  
5680 DA Best  
The Netherlands

Email: [dicom@philips.com](mailto:dicom@philips.com)

Internet: <http://www.healthcare.philips.com/main/about/connectivity>

Document Number: DHF181911

Date: 04-September-2013

## 1. DICOM Conformance Statement Overview

This conformance statement refers to the "Pinnacle<sup>3</sup> Radiation Treatment Planning System" which is used in conjunction with the record and verify (R&V) systems. This version of DICOM Conformance Statement applies to Philips Pinnacle workstation, version 9.8. Pinnacle<sup>3</sup> sets the standard for 3D treatment planning and visualization systems. As an imaging workstation, Pinnacle<sup>3</sup>'s sophisticated 2D and 3D imaging options, multi-modality image fusion, and treatment simulation tools allow users to accurately localize and delineate target and critical structures. Fully integrated photon, electron, stereotactic radio surgery, and brachytherapy treatment planning allow users to perform all of their treatment planning from a single platform. Finally, accurate 3D dose calculation algorithms and plan evaluation tools facilitate the applications of new treatment techniques.

It contains a short description of the applications involved and provides technical information about the data exchange capabilities of the equipment. The main elements describing these capabilities are: the supported DICOM Service Object Pair (SOP) Classes, Roles, Information Object Definitions (IOD) and Transfer Syntaxes.

This application was developed using the MergeCOM-3 Advanced Software Tool Kit for DICOM Services supplied by Merge Technologies Incorporated, Milwaukee, Wisconsin USA.

The following Table presents an overview of all network services and the applicable SOP Classes as provided by the Pinnacle<sup>3</sup>.

**Table 1: Network Services**

SOP Class		User of Service (SCU)	Provider of Service (SCP)
Name	UID		
<b>Other</b>			
Verification SOP Class	1.2.840.10008.1.1	Yes	Yes
<b>Print Management</b>			
Basic Color Print Management Meta SOP Class	1.2.840.10008.5.1.1.18	Yes	No
>Basic Film Session SOP Class	1.2.840.10008.5.1.1.1	Yes	No
Basic Grayscale Print Management Meta SOP Class	1.2.840.10008.5.1.1.9	Yes	No
>Basic Film Session SOP Class	1.2.840.10008.5.1.1.1	Yes	No
<b>Transfer</b>			
Positron Emission Tomography Image Storage SOP Class	1.2.840.10008.5.1.4.1.1.128	Yes	Yes
CT Image Storage SOP Class	1.2.840.10008.5.1.4.1.1.2	Yes	Yes
Nuclear Medicine Image Storage SOP Class	1.2.840.10008.5.1.4.1.1.20	Yes	Yes
MR Image Storage SOP Class	1.2.840.10008.5.1.4.1.1.4	Yes	Yes
RT Image Storage SOP Class	1.2.840.10008.5.1.4.1.1.481.1	Yes	Yes
RT Dose Storage SOP Class	1.2.840.10008.5.1.4.1.1.481.2	Yes	Yes
RT Structure Set Storage SOP Class	1.2.840.10008.5.1.4.1.1.481.3	Yes	Yes
RT Plan Storage SOP Class	1.2.840.10008.5.1.4.1.1.481.5	Yes	Yes
Ultrasound Image Storage SOP Class	1.2.840.10008.5.1.4.1.1.6.1	No	Yes
Spatial Registration Storage	1.2.840.10008.5.1.4.1.1.66.1	Yes	Yes
Secondary Capture Image Storage SOP Class	1.2.840.10008.5.1.4.1.1.7	Yes	Yes
Computed Radiography Image Storage SOP Class	1.2.840.10008.5.1.4.1.1.1	Yes	No

## 2. Table of Contents

<b>1.</b>	<b>DICOM CONFORMANCE STATEMENT OVERVIEW .....</b>	<b>3</b>
<b>2.</b>	<b>TABLE OF CONTENTS .....</b>	<b>4</b>
<b>3.</b>	<b>INTRODUCTION .....</b>	<b>6</b>
<b>3.1.</b>	<b>REVISION HISTORY .....</b>	<b>6</b>
<b>3.2.</b>	<b>AUDIENCE .....</b>	<b>6</b>
<b>3.3.</b>	<b>REMARKS .....</b>	<b>6</b>
<b>3.4.</b>	<b>DEFINITIONS, TERMS AND ABBREVIATIONS.....</b>	<b>7</b>
<b>3.5.</b>	<b>REFERENCES.....</b>	<b>7</b>
<b>4.</b>	<b>NETWORKING .....</b>	<b>8</b>
<b>4.1.</b>	<b>IMPLEMENTATION MODEL .....</b>	<b>8</b>
4.1.1.	Application Data Flow.....	8
4.1.2.	Functional Definition of AE's .....	9
4.1.2.1.	Functional Definition of ADACRTP_SCP .....	9
4.1.2.2.	Functional Definition of ADACRTP_SCU.....	10
4.1.3.	Sequencing of Real World Activities .....	10
<b>4.2.</b>	<b>AE SPECIFICATIONS .....</b>	<b>12</b>
4.2.1.	ADACRTP_SCP .....	12
4.2.1.1.	SOP Classes .....	12
4.2.1.2.	Association Policies .....	12
4.2.1.2.1.	General.....	12
4.2.1.2.2.	Number of Associations.....	12
4.2.1.2.3.	Asynchronous Nature .....	13
4.2.1.2.4.	Implementation Identifying Information .....	13
4.2.1.2.5.	Communication Failure Handling.....	13
4.2.1.3.	Association Initiation Policy .....	13
4.2.1.4.	Association Acceptance Policy .....	14
4.2.1.4.1.	(Real-World) Activity – Verification as SCP .....	14
4.2.1.4.2.	(Real-World) Activity – Image Import.....	15
4.2.2.	ADACRTP_SCU .....	18
4.2.2.1.	SOP Classes .....	18
4.2.2.2.	Association Policies .....	18
4.2.2.2.1.	General.....	18
4.2.2.2.2.	Number of Associations.....	19
4.2.2.2.3.	Asynchronous Nature .....	19
4.2.2.2.4.	Implementation Identifying Information .....	19
4.2.2.2.5.	Communication Failure Handling.....	19
4.2.2.3.	Association Initiation Policy .....	19
4.2.2.3.1.	(Real-World) Activity – Verification as SCU .....	20
4.2.2.3.2.	(Real-World) Activity – Image Export.....	21
4.2.2.3.3.	(Real-World) Activity – Print Management as SCU.....	23
4.2.2.4.	Association Acceptance Policy .....	33
<b>4.3.</b>	<b>NETWORK INTERFACES.....</b>	<b>34</b>
4.3.1.	Physical Network Interfaces .....	34
4.3.2.	Additional Protocols .....	34
<b>4.4.</b>	<b>CONFIGURATION.....</b>	<b>34</b>
4.4.1.	AE Title/Presentation Address Mapping.....	34
4.4.1.1.	Local AE Titles.....	34
4.4.1.2.	Remote AE Title/Presentation Address Mapping.....	34
4.4.2.	Parameters.....	34
<b>5.</b>	<b>MEDIA INTERCHANGE .....</b>	<b>36</b>
<b>5.1.</b>	<b>IMPLEMENTATION MODEL .....</b>	<b>36</b>
5.1.1.	Application Data Flow Diagram .....	36

5.1.2.	Functional Definitions of AE's.....	36
5.1.3.	Sequencing of Real World Activities .....	36
<b>5.2.</b>	<b>AE SPECIFICATIONS .....</b>	<b>36</b>
5.2.1.	Media AE Media - Specification .....	36
5.2.1.1.	File Meta Information for the Media AE .....	36
5.2.1.2.	Real-World Activities.....	36
5.2.1.2.1.	RWA - Read File-set.....	36
5.2.1.2.2.	RWA - Create File-set.....	36
<b>5.3.</b>	<b>AUGMENTED AND PRIVATE APPLICATION PROFILES.....</b>	<b>37</b>
<b>5.4.</b>	<b>MEDIA CONFIGURATION .....</b>	<b>37</b>
<b>6.</b>	<b>SUPPORT OF CHARACTER SETS.....</b>	<b>38</b>
<b>7.</b>	<b>SECURITY.....</b>	<b>39</b>
<b>7.1.</b>	<b>SECURITY PROFILES .....</b>	<b>39</b>
7.1.1.	Security use Profiles .....	39
7.1.2.	Security Transport Connection Profiles.....	39
7.1.3.	Digital Signature Profiles.....	39
7.1.4.	Media Storage Security Profiles .....	39
7.1.5.	Attribute Confidentiality Profiles .....	39
7.1.6.	Network Address Management Profiles .....	39
7.1.7.	Time Synchronization Profiles.....	39
7.1.8.	Application Configuration Management Profiles.....	39
7.1.9.	Audit Trail Profiles .....	39
<b>7.2.</b>	<b>ASSOCIATION LEVEL SECURITY.....</b>	<b>39</b>
<b>7.3.</b>	<b>APPLICATION LEVEL SECURITY .....</b>	<b>39</b>
<b>8.</b>	<b>ANNEXES OF APPLICATION "PINNACLE" .....</b>	<b>40</b>
<b>8.1.</b>	<b>IOD CONTENTS .....</b>	<b>40</b>
8.1.1.	Created SOP Instance .....	40
8.1.1.1.	List of created SOP Classes.....	40
8.1.1.2.	Computed Radiography Image Storage SOP Class.....	41
8.1.1.3.	RT Image Storage SOP Class.....	43
8.1.1.4.	RT Dose Storage SOP Class .....	46
8.1.1.5.	RT Structure Set Storage SOP Class.....	50
8.1.1.6.	RT Plan Storage SOP Class.....	54
8.1.1.7.	Spatial Registration Storage.....	62
8.1.1.8.	Secondary Capture Image Storage SOP Class.....	64
8.1.2.	Usage of Attributes from Received IOD .....	66
8.1.2.1.	Usage of the Functionality CT, MR, NM and PET Image Storage IODs.....	66
8.1.2.2.	Usage of the Functionality RT Structure Set Storage SOP Class.....	68
8.1.2.3.	Usage of the Functionality RT Plan Storage SOP Class .....	71
8.1.2.4.	Usage of the Functionality Spatial Registration Storage SOP Class .....	77
8.1.2.5.	Usage of the Functionality RT Dose Storage SOP Class .....	78
8.1.3.	Attribute Mapping.....	81
8.1.4.	Coerced/Modified fields.....	81
<b>8.2.</b>	<b>DATA DICTIONARY OF PRIVATE ATTRIBUTES.....</b>	<b>81</b>
<b>8.3.</b>	<b>CODED TERMINOLOGY AND TEMPLATES .....</b>	<b>81</b>
8.3.1.	Context Groups .....	81
8.3.2.	Template Specifications .....	81
8.3.3.	Private code definitions .....	81
<b>8.4.</b>	<b>GRAYSCALE IMAGE CONSISTENCY .....</b>	<b>81</b>
<b>8.5.</b>	<b>STANDARD EXTENDED/SPECIALIZED/PRIVATE SOPS.....</b>	<b>81</b>
8.5.1.	RT Plan Storage SOP Class Instances.....	81
<b>8.6.</b>	<b>PRIVATE TRANSFER SYNTAXES.....</b>	<b>82</b>

## 3. Introduction

The introduction specifies product and relevant disclaimers as well as any general information that the vendor feels is appropriate.

### 3.1. Revision History

The revision history provides dates and differences of the different releases.

**Table 2: Revision History**

Document Version	Date of Issue	Status	Description
00	04-September-2012	Initial Release	This is the initial release of the Pinnacle 9.8 DICOM Conformance Statement.

### 3.2. Audience

This Conformance Statement is intended for:

- (Potential) customers
- System integrators of medical equipment
- Marketing staff interested in system functionality
- Software designers implementing DICOM interfaces

It is assumed that the reader is familiar with the DICOM standard.

### 3.3. Remarks

The DICOM Conformance Statement is contained in chapter 4 through 8 and follows the contents and structuring requirements of DICOM PS 3.2.

This DICOM Conformance Statement by itself does not guarantee successful interoperability of Philips equipment with non-Philips equipment. The user (or user's agent) should be aware of the following issues:

- **Interoperability**  
Interoperability refers to the ability of application functions, distributed over two or more systems, to work successfully together. The integration of medical devices into an IT environment may require application functions that are not specified within the scope of DICOM. Consequently, using only the information provided by this Conformance Statement does not guarantee interoperability of Philips equipment with non-Philips equipment. It is the user's responsibility to analyze thoroughly the application requirements and to specify a solution that integrates Philips equipment with non-Philips equipment.
- **Validation**  
Philips equipment has been carefully tested to assure that the actual implementation of the DICOM interface corresponds with this Conformance Statement. Where Philips equipment is linked to non-Philips equipment, the first step is to compare the relevant Conformance Statements. If the Conformance Statements indicate that successful information exchange should be possible, additional validation tests will be necessary to ensure the functionality, performance, accuracy and stability of image and image related data. It is the responsibility of the user (or user's agent) to specify the appropriate test suite and to carry out the additional validation tests.
- **New versions of the DICOM Standard**  
The DICOM Standard will evolve in future to meet the user's growing requirements and to incorporate new features and technologies. Philips is actively involved in this evolution and plans to adapt its equipment to future versions of the DICOM Standard. In order to do so, Philips reserves the right to make changes to its products or to discontinue its delivery. The user should ensure that any non-Philips provider linking to Philips equipment also adapts to future versions of the DICOM Standard. If not, the incorporation of DICOM enhancements into Philips equipment may lead to loss of connectivity (in case of networking) and incompatibility (in case of media).

## 3.4. Definitions, Terms and Abbreviations

**Table 3: Definitions, Terms and Abbreviations**

Abbreviation/Term	Explanation
AE	Application Entity
CD	Compact Disc
CD-R	CD-Recordable
CD-M	CD-Medical
CR	Computed Radiography
CT	Computed Tomography
DICOM	Digital Imaging and Communications in Medicine
EBE	Explicit VR Big Endian
ELE	DICOM Explicit VR Little Endian
FSC	File-set Creator
FSR	File-set Reader
FSU	File-set Updater
ILE	DICOM Implicit VR Little Endian
IOD	Information Object Definition
MPPS	Modality Performed Procedure Step
MR	Magnetic Resonance
NEMA	National Electrical Manufacturers Association
NM	Nuclear Medicine
PDU	Protocol Data Unit
RIS	Radiology Information System
RT	Radiotherapy
RWA	Real-World Activity
SC	Secondary Capture
SCP	Service Class Provider
SCU	Service Class User
SOP	Service Object Pair
TCP/IP	Transmission Control Protocol/Internet Protocol
UID	Unique Identifier

## 3.5. References

[DICOM] Digital Imaging and Communications in Medicine, Parts 1 - 18 (NEMA PS 3.1- PS 3.18), National Electrical Manufacturers Association (NEMA) Publication Sales 1300 N. 17th Street, Suite 1752 Rosslyn, Virginia. 22209, United States of America  
 Internet: <http://medical.nema.org/>  
 Note that at any point in time the official standard consists of the most recent yearly edition of the base standard (currently 2011) plus all the supplements and correction items that have been approved as Final Text.

## 4. Networking

This section contains the networking related services (vs. the media related ones).

### 4.1. Implementation model

The implementation model consists of three sections:

- The application data flow diagram, specifying the relationship between the Application Entities and the "external world" or Real-World Activities,
- A functional description of each Application Entity, and
- The sequencing constraints among them.

#### 4.1.1. Application Data Flow

The ADACRTP\_SCP server application stores received DICOM message information within a standard UNIX directory. This directory is specified on the command line of the application launched at system boot. The messages may then be imported into the Pinnacle<sup>3</sup> database via the Launch Pad application's Import capability.

For DICOM RT messages, import is performed within the Pinnacle<sup>3</sup> application. The Plan or Structure Set information is added to the plan being edited.

ADACRTP\_SCP is a daemon, started at system boot, which runs continuously. Launch Pad is a Pinnacle<sup>3</sup> application which utilizes an associated DICOM-to- Pinnacle<sup>3</sup> file format converter to import DICOM image data to the Pinnacle<sup>3</sup> database.

ADACRTP\_SCU is the Pinnacle<sup>3</sup> application. (Note that the actual AE Title will be the name of the workstation, capitalized; the default name ADACRTP\_SCU will only be used if the workstation name cannot be determined.) ADACRTP\_SCU will answer Verification requests only if the application is running. Print and RT transmission requests are submitted as requested by the user. It can also send the received CT, MR, NM, and PET images back to the remote server via the DICOM Image Export feature of Launch Pad or CT images used as the primary dataset of the Pinnacle<sup>3</sup> plan via the DICOM Image Export feature of Pinnacle<sup>3</sup>.

The Pinnacle<sup>3</sup>-related Implementation Model is shown in the following figure.



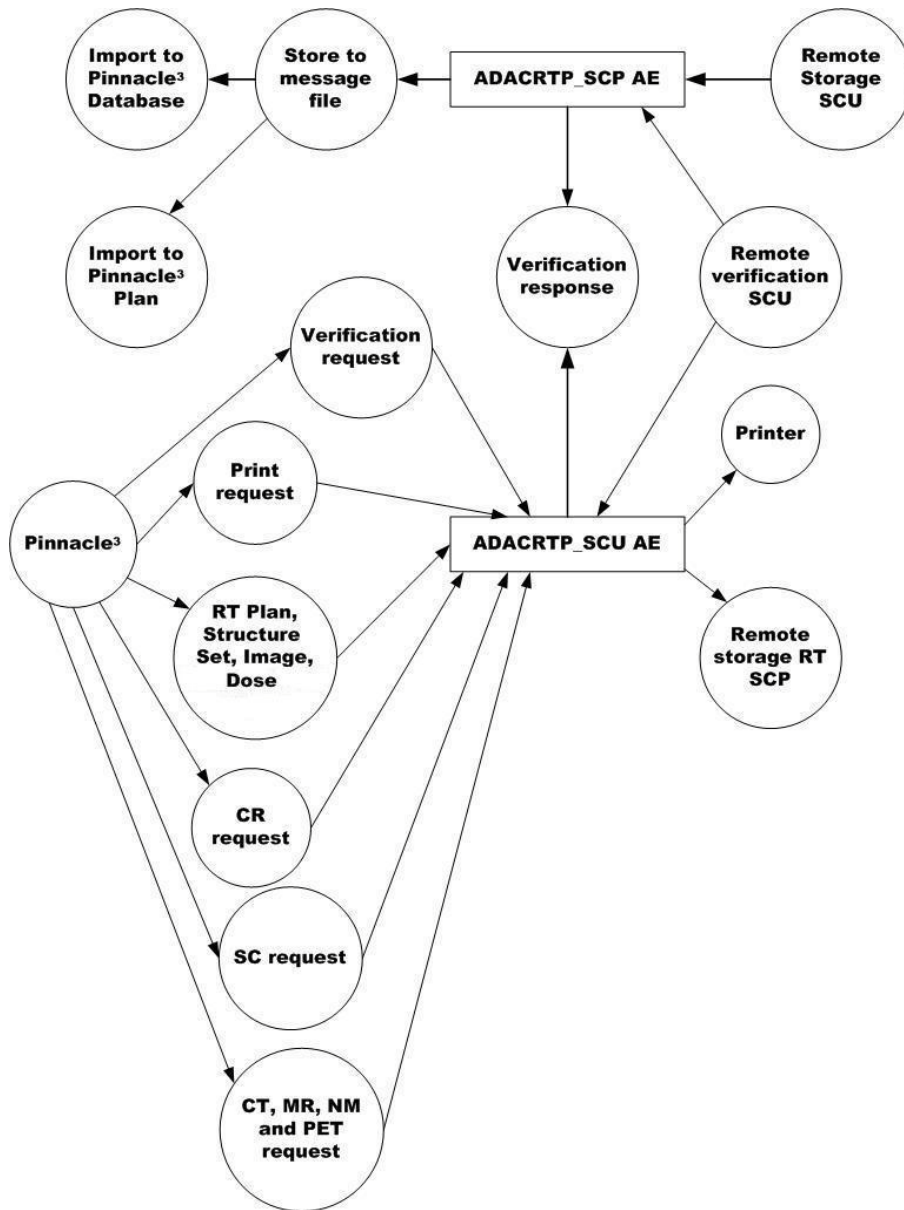

Figure 1: Pinnacle Implementation Model

As documented in PS 3.4, the arrows in the diagram have the following meanings:  
 An arrow pointing to the right indicates the local application entity initiates an association.  
 An arrow pointing to the left indicates the local application entity accepts an association.

#### 4.1.2. Functional Definition of AE's

This section contains a functional definition for each individual local Application Entity.

##### 4.1.2.1. Functional Definition of ADACRTP\_SCP

The ADACRTP\_SCP server application waits until it receives a C-STORE request from a remote SCU. Upon receipt it will save the received data to a directory with a unique file name. The server is capable of handling multiple associations.

ADACRTP\_SCP is a daemon, started at system boot, which runs continuously.  
 When invoked, the DICOM-to- Pinnacle<sup>3</sup> file format converter will scan the directory of files for image messages written by

ADACRTP\_SCP to determine if individual files may be associated. The association criterion is a matching Series Instance UID. If files belong to the same series, they will be imported to Pinnacle<sup>3</sup> as a single data set.

Launch Pad is a Pinnacle<sup>3</sup> application that utilizes the DICOM-to- Pinnacle<sup>3</sup> file format converter to import DICOM image data to the Pinnacle<sup>3</sup> database.

#### 4.1.2.2. Functional Definition of ADACRTP\_SCU

Import of RT Plan and RT Structure Set IODs is accomplished within Pinnacle<sup>3</sup>. The user creates a plan, edits it, and invokes the import operation. The message files will be scanned for RT messages and the selections presented to the user. On import the plan will be populated with the information as described in the selected RT Plan and/or RT Structure Set messages.

The Pinnacle<sup>3</sup> application, using the workstation's name as the AE Title or failing that, ADACRTP\_SCU, communicates with the remote application using the DICOM protocol. At the user's request an association is established with the AE defined in the printer configuration just prior to sending a print request to that AE. After completion of the transmission the association is closed.

The Pinnacle<sup>3</sup> application also communicates with a remote SCP to transfer RT Plan, RT Structure Set, RT Dose, and RT Image IODs. At the user's request an association is established with an AE defined during installation. After completion of the transmission the association is closed. It is also capable of sending the CT, MR, NM and PET images back to the remote server, via the DICOM Image Export feature of Launch Pad or CT images used as the primary dataset of the Pinnacle<sup>3</sup> plan within the DICOM Image Export feature of Pinnacle<sup>3</sup>.

The Pinnacle<sup>3</sup> application also communicates with a remote SCP to transfer computed radiography and secondary capture IODs. At the user's request an association is established with an AE defined during installation. After completion of the transmission the association is closed.

#### 4.1.3. Sequencing of Real World Activities

This section contains description of specific sequencing as well as potential constraints of Real-World Activities, including any applicable user interactions, as performed by the DICOM Server.

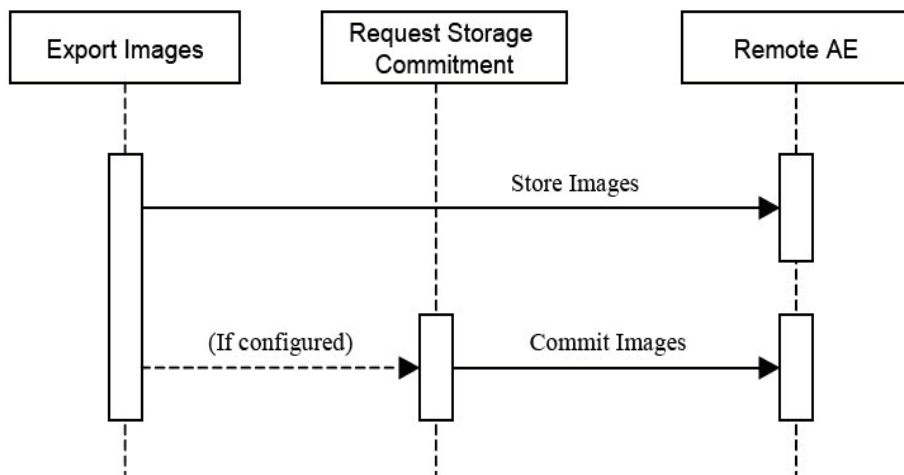

Figure 2: RWA Sequencing for Export Images

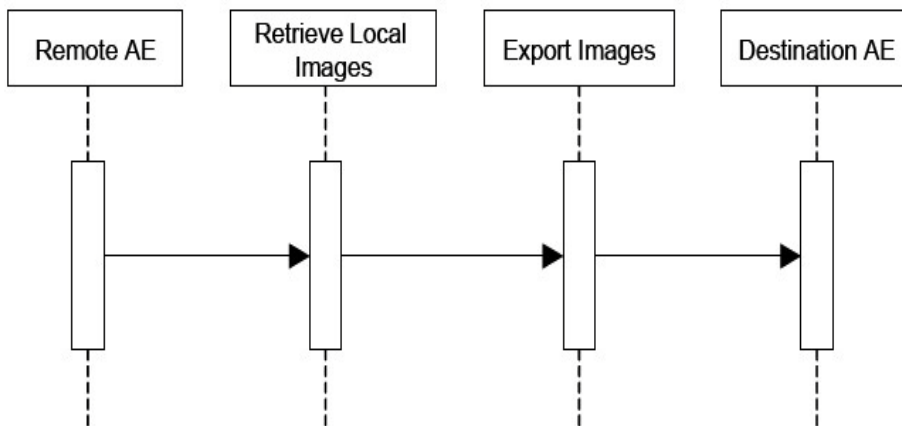

Figure 3: RWA Sequencing for Retrieve Local Images

## 4.2. AE Specifications

The Network capabilities of the system consist of two DICOM Application Entities:

- An Imaging, RT Plan, and Structure Set Import Storage AE (ADACRTP\_SCP)
- A Send Print, RT Plan, RT Image, Dose, Structure Set, Computed Radiography, Secondary Capture, Spatial Registration, and Imaging AE (ADACRTP\_SCU)

Throughout this document ADACRTP\_SCU is used to specify the AE Title representing the Pinnacle<sup>3</sup> application. In the field the presented AE Title will be the capitalized hostname of the machine sending the message.

### 4.2.1. ADACRTP\_SCP

The ADACRTP\_SCP Application Entity provides Standard Conformance to the DICOM SOP classes as an SCP specified in next table.

#### 4.2.1.1. SOP Classes

This Application Entity provides Standard Conformance to the following SOP Classes.

**Table 4: SOP Classes for ADACRTP\_SCP**

SOP Class Name	SOP Class UID	SCU	SCP
Verification SOP Class	1.2.840.10008.1.1	No	Yes
Positron Emission Tomography Image Storage SOP Class	1.2.840.10008.5.1.4.1.1.128	No	Yes
CT Image Storage SOP Class	1.2.840.10008.5.1.4.1.1.2	No	Yes
Nuclear Medicine Image Storage SOP Class	1.2.840.10008.5.1.4.1.1.20	No	Yes
MR Image Storage SOP Class	1.2.840.10008.5.1.4.1.1.4	No	Yes
RT Image Storage SOP Class	1.2.840.10008.5.1.4.1.1.481.1	No	Yes
RT Dose Storage SOP Class	1.2.840.10008.5.1.4.1.1.481.2	No	Yes
RT Structure Set Storage SOP Class	1.2.840.10008.5.1.4.1.1.481.3	No	Yes
RT Plan Storage SOP Class	1.2.840.10008.5.1.4.1.1.481.5	No	Yes
Ultrasound Image Storage SOP Class	1.2.840.10008.5.1.4.1.1.6.1	No	Yes
Spatial Registration Storage	1.2.840.10008.5.1.4.1.1.66.1	No	Yes
Secondary Capture Image Storage SOP Class	1.2.840.10008.5.1.4.1.1.7	No	Yes

#### Notes:

The SCP will accept Secondary Capture Image and RT Image, but Pinnacle does not support it and thus it cannot be imported.

The SCP will accept Ultrasound Image, but Pinnacle does not fully support it and thus it likely will not be importable.

Any SOP specific behavior is documented later in the conformance statement in the applicable SOP specific conformance section.

#### 4.2.1.2. Association Policies

Each AE specification contains a description of the general association establishment and acceptance policies of the AE.

##### 4.2.1.2.1. General

The ADACRTP\_SCP AE and the ADACRTP\_SCU AE always propose the following DICOM Application Context Name (ACN):

1.2.840.10008.3.1.1.1.

The maximum PDU length negotiation is included in all association establishment requests. For all services the maximum PDU size is 28672 bytes.

##### 4.2.1.2.2. Number of Associations

The number of simultaneous associations that will be accepted by ADACRTP\_SCP is limited only by system resources.

ADACRTP\_SCP will spawn a new process to handle each connection request it receives. Therefore, ADACRTP\_SCP can support multiple simultaneous connections, and there are no inherent limitations on the total number of simultaneous associations.

The ADACRTP\_SCU application entity opens a single association for each request.

#### 4.2.1.2.3. Asynchronous Nature

DICOM asynchronous mode is not supported, meaning that only one transaction may be outstanding over an association at any given point in time.

#### 4.2.1.2.4. Implementation Identifying Information

The value supplied for Implementation Class UID and version name are documented here.

**Table 5: DICOM Implementation Class and Version for ADACRTP\_SCP**

Implementation Class UID	2.16.840.1.113669.2.931128
Implementation Version Name	ADAC_RTP_XX

#### 4.2.1.2.5. Communication Failure Handling

The behavior of the AE during communication failure is summarized in next table.

**Table 6: Communication Failure Behavior**

Exception	Behavior	Comment
ARTIM Timeout	The system stops the ARTIM timer and closes the transport connection.	Configurable, minimum value=1.
Association Timeout	A release request is sent in order to close the association.	Configurable, minimum value=1.

#### 4.2.1.3. Association Initiation Policy

Not applicable.

**4.2.1.4. Association Acceptance Policy**

When ADACRTP\_SCP accepts an association it will receive supported SOP Instances and store the messages to disk. There is neither limitation on who may connect to the SCP, nor on the number of simultaneous associations it will support. When ADACRTP\_SCP receives a verification request it responds with a success status.

Import of the data into Pinnacle<sup>3</sup> is a separate operation requested by the user. Upon import the attribute values contained in the message will be verified. Import may be performed from the standard directory, written by the SCP, or from CD that conforms to the media interchange format as described in PS3.10.

**4.2.1.4.1. (Real-World) Activity – Verification as SCP**

**4.2.1.4.1.1. Description and Sequencing of Activities**

The ADACRTP\_SCP accepts Associations from configured systems that wish to verify application level communication using the C-ECHO command.

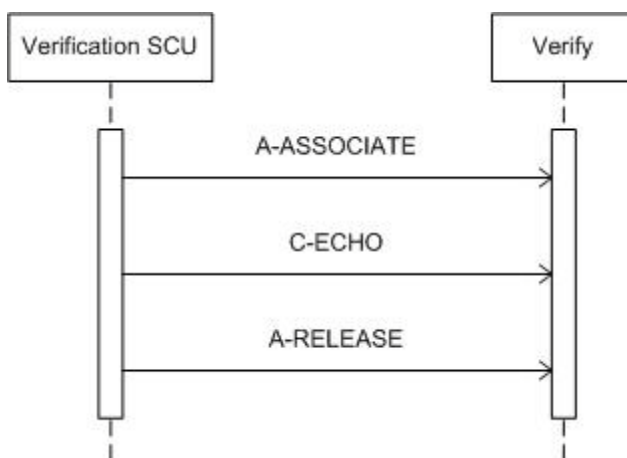

**Figure 4: Data Flow Diagram – Verify**

**4.2.1.4.1.2. Accepted Presentation Contexts**

The presentation contexts are defined in the next table.

**Table 7: Acceptable Presentation Contexts for (Real-World) Activity – Verification as SCP**

Presentation Context Table					
Abstract Syntax		Transfer Syntax		Role	Extended Negotiation
Name	UID	Name List	UID List		
Verification SOP Class	1.2.840.10008.1.1	Implicit VR Little Endian	1.2.840.10008.1.2	SCP	None
		Explicit VR Little Endian	1.2.840.10008.1.2.1		

**4.2.1.4.1.3. SOP Specific Conformance for Verification SOP Class**

The ADACRTP\_SCP server application responds to remote C-ECHO requests with success status.

**4.2.1.4.1.3.1. Dataset Specific Conformance for Verification C-ECHO SCP**

Detail regarding the Dataset Specific response behavior will be reported in this section.

This part of the section includes the dataset specific behavior, i.e. error codes, error and exception handling, time-outs, etc.

**Table 8: Status Response**

Service Status	Error Code	Further Meaning	Behavior
Success	0000	Confirmation	Confirm the verification request.

**4.2.1.4.2. (Real-World) Activity – Image Import**

**4.2.1.4.2.1. Description and Sequencing of Activities**

The ADACRTP\_SCP server application will automatically handle requests for image storage and store them on receipt of C-STORE requests. The file will be stored in the directory specified at startup of the daemon.

The timers used for the management of associations and DICOM services (i.e., C-STORE) are specified in the configuration files for the server.

The real world activity associated with the C-STORE operation is the storage of the image in the memory of the system upon which DICOM Server is running in order to make it available for immediate processing by applications. DICOM Server will issue a failure status if it is unable to store the image in the memory.

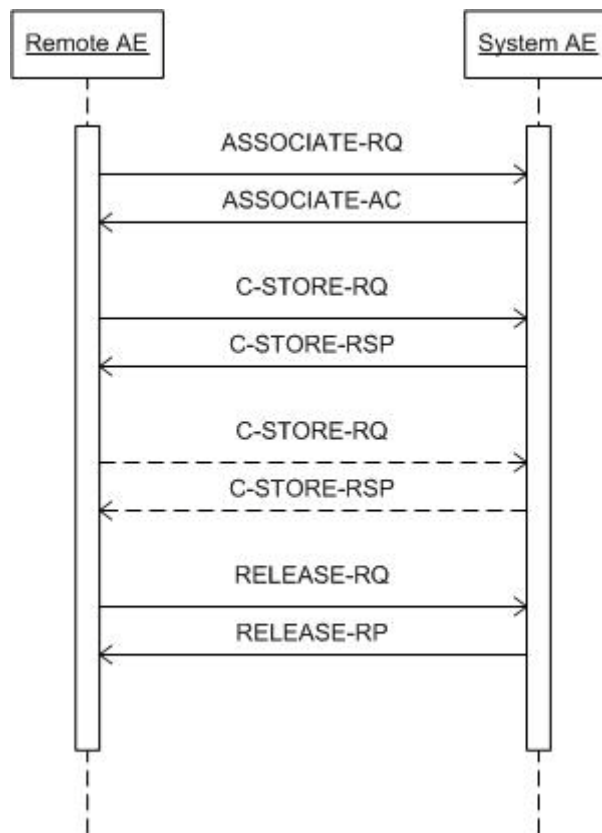

**Figure 5: (Real World) Activity - Import**

**4.2.1.4.2.2. Accepted Presentation Contexts**

Any of the presentation contexts in next table are acceptable for ADACRTP\_SCP to receive images.

**Table 9: Acceptable Presentation Contexts for (Real-World) Activity – Import**

Presentation Context Table					
Abstract Syntax		Transfer Syntax		Role	Extended Negotiation
Name	UID	Name List	UID List		
Positron Emission Tomography Image Storage SOP Class	1.2.840.10008.5.1.4.1.1.128	Implicit VR Little Endian	1.2.840.10008.1.2	SCP	None
		Explicit VR Little Endian	1.2.840.10008.1.2.1		
CT Image Storage SOP Class	1.2.840.10008.5.1.4.1.1.2	Implicit VR Little Endian	1.2.840.10008.1.2	SCP	None
		Explicit VR Little Endian	1.2.840.10008.1.2.1		
Nuclear Medicine Image Storage SOP Class	1.2.840.10008.5.1.4.1.1.20	Implicit VR Little Endian	1.2.840.10008.1.2	SCP	None
		Explicit VR Little Endian	1.2.840.10008.1.2.1		
MR Image Storage SOP Class	1.2.840.10008.5.1.4.1.1.4	Explicit VR Little Endian	1.2.840.10008.1.2.1	SCP	None
		Implicit VR Little Endian	1.2.840.10008.1.2		
RT Image Storage SOP Class	1.2.840.10008.5.1.4.1.1.481.1	Explicit VR Little Endian	1.2.840.10008.1.2.1	SCP	None
		Implicit VR Little Endian	1.2.840.10008.1.2		
RT Dose Storage SOP Class	1.2.840.10008.5.1.4.1.1.481.2	Explicit VR Little Endian	1.2.840.10008.1.2.1	SCP	None
		Implicit VR Little Endian	1.2.840.10008.1.2		
RT Structure Set Storage SOP Class	1.2.840.10008.5.1.4.1.1.481.3	Explicit VR Little Endian	1.2.840.10008.1.2.1	SCP	None
		Implicit VR Little Endian	1.2.840.10008.1.2		
RT Plan Storage SOP Class	1.2.840.10008.5.1.4.1.1.481.5	Explicit VR Little Endian	1.2.840.10008.1.2.1	SCP	None
		Implicit VR Little Endian	1.2.840.10008.1.2		
Ultrasound Image Storage SOP Class	1.2.840.10008.5.1.4.1.1.6.1	Explicit VR Little Endian	1.2.840.10008.1.2.1	SCP	None
		Implicit VR Little Endian	1.2.840.10008.1.2		
Spatial Registration Storage	1.2.840.10008.5.1.4.1.1.66.1	Implicit VR Little Endian	1.2.840.10008.1.2	SCP	None
		Explicit VR Little Endian	1.2.840.10008.1.2.1		
Secondary Capture Image Storage SOP Class	1.2.840.10008.5.1.4.1.1.7	Implicit VR Little Endian	1.2.840.10008.1.2	SCP	None
		Explicit VR Little Endian	1.2.840.10008.1.2.1		

**Note:** ILE and ELE is the default syntax. It is possible to configure our DICOM server to additionally handle EBE and IBE but it is not configured as such by default.

#### 4.2.1.4.2.3. SOP Specific Conformance for Storage SOP Classes

This section and sub-section includes the manufacturer SOP and Dataset specific information as well the status codes and their corresponding behavior.

DICOM Server provides standard conformance to the DICOM V3.0 Storage Service Class as a SCP. DICOM Server conforms to the SOPs of the Storage Service Class at Level 2 (Full). In case of a successful C-STORE, the stored image may be accessed by the processing applications.

#### 4.2.1.4.2.3.1. Dataset Specific Conformance for C-STORE-RSP

ADACRTP\_SCP conforms to the SOPs of the Image Storage Service Class at Level 0, meaning a subset of the attributes associated with the image will be stored. All others will be discarded.

Upon receipt of a C-STORE request by ADACRTP\_SCP, the message is saved to a file in the directory specified to the process at startup. Upon saving the data to this file, a successful C-STORE-RSP is returned to the sender.

If insufficient resources exist to store the messages, a response indicating such will be transmitted and the association aborted.

Images transferred prior to depleting the resources will be preserved. The image in the process of transfer upon depletion of resources will be removed.

Minimal interpretation of the transferred images is performed by the Image Storage SCP. Data consistency and orientation issues are addressed when the data is imported to Pinnacle<sup>3</sup>.



Voxel sizing information is required for image data to be used within Pinnacle<sup>3</sup>. If the X, Y, or Z voxel dimensions are missing from the DICOM message, the user will be prompted for proper dimensions on import to Pinnacle<sup>3</sup>.

Pinnacle<sup>3</sup> will not accept non-axial data sets for use as a primary data set.

On receipt of Nuclear Medicine data in a multi-image format, each frame of the multi-image is treated as a slice within a volume. The volume is spaced isotropically in the Z dimension.

The following table lists the actions that are performed when an exception occurs. The Service Name Status Responses that are returned by ADACRTP\_SCP are given.

**Table 10: Status Response**

Service Status	Error Code	Further Meaning	Behavior
Success	0x0000	Successfully stored	Whenever the store operation succeeded.
Error	0xA700	Failed	Notification will be sent. Logging will be done and connection will be aborted.

## 4.2.2. ADACRTP\_SCU

### 4.2.2.1. SOP Classes

This Application Entity provides Standard Conformance to the following SOP Classes.

**Table 11: SOP Classes for ADACRTP\_SCU**

SOP Class Name	SOP Class UID	SCU	SCP
Verification SOP Class	1.2.840.10008.1.1	Yes	No
Computed Radiography Image Storage SOP Class	1.2.840.10008.5.1.4.1.1.1	Yes	No
Positron Emission Tomography Image Storage SOP Class	1.2.840.10008.5.1.4.1.1.128	Yes	No
CT Image Storage SOP Class	1.2.840.10008.5.1.4.1.1.2	Yes	No
Nuclear Medicine Image Storage SOP Class	1.2.840.10008.5.1.4.1.1.20	Yes	No
MR Image Storage SOP Class	1.2.840.10008.5.1.4.1.1.4	Yes	No
RT Image Storage SOP Class	1.2.840.10008.5.1.4.1.1.481.1	Yes	No
RT Dose Storage SOP Class	1.2.840.10008.5.1.4.1.1.481.2	Yes	No
RT Structure Set Storage SOP Class	1.2.840.10008.5.1.4.1.1.481.3	Yes	No
RT Plan Storage SOP Class	1.2.840.10008.5.1.4.1.1.481.5	Yes	No
Spatial Registration Storage	1.2.840.10008.5.1.4.1.1.66.1	Yes	No
Secondary Capture Image Storage SOP Class	1.2.840.10008.5.1.4.1.1.7	Yes	No
Basic Color Print Management Meta SOP Class	1.2.840.10008.5.1.1.18	Yes	No
>Basic Film Session SOP Class	1.2.840.10008.5.1.1.1	Yes	No
>Basic Film Box SOP Class	1.2.840.10008.5.1.1.2	Yes	No
>Basic Color Image Box SOP Class	1.2.840.10008.5.1.1.4.1	Yes	No
>Printer SOP Class	1.2.840.10008.5.1.1.16	Yes	No
Basic Grayscale Print Management Meta SOP Class	1.2.840.10008.5.1.1.9	Yes	No
>Basic Film Session SOP Class	1.2.840.10008.5.1.1.1	Yes	No
>Basic Film Box SOP Class	1.2.840.10008.5.1.1.2	Yes	No
>Basic Grayscale Image Box SOP Class	1.2.840.10008.5.1.1.4	Yes	No
>Printer SOP Class	1.2.840.10008.5.1.1.16	Yes	No

**Note:** Any SOP specific behavior is documented later in the conformance statement in the applicable SOP specific conformance section.

### 4.2.2.2. Association Policies

Each AE specification contains a description of the general association establishment and acceptance policies of the AE.

#### 4.2.2.2.1. General

The ADACRTP\_SCU Network AE always proposes the following DICOM Application Context Name (ACN): 1.2.840.10008.3.1.1.1. The maximum PDU length negotiation is included in all association establishment requests. The maximum PDU size is: 28 KB. Note that the actual local AE Title will be the name of the workstation, capitalized: the default name 'ADACRTP\_SCU' will only be used if the workstation name cannot be determined.

**Table 12: DICOM Application Context**

Description	Value
Application Context Name	1.2.840.10008.3.1.1.1

#### 4.2.2.2.2. Number of Associations

The ADACRTP\_SCU application entity opens a single association for each user requested transfer.

**Table 13: Number of associations as an Association Initiator for this AE**

Description	Value
Maximum number of simultaneous associations	1

#### 4.2.2.2.3. Asynchronous Nature

DICOM asynchronous mode is not supported meaning that only one transaction may be outstanding over an association at any given point in time.

**Table 14: Asynchronous nature as an Association Initiator for this AE**

Description	Value
Maximum number of outstanding asynchronous transactions	1

#### 4.2.2.2.4. Implementation Identifying Information

The value supplied for Implementation Class UID and version name are documented here.

**Table 15: DICOM Implementation Class and Version for ADACRTP\_SCU**

Implementation Class UID	2.16.840.1.113669.2.931128
Implementation Version Name	ADAC_RTP_XX

#### 4.2.2.2.5. Communication Failure Handling

Not applicable.

#### 4.2.2.3. Association Initiation Policy

The Application Entity will respond to a received Association rejection as shown in the next table.

##### Associated Real-World Activity:

When transmitting RT IODs, ADACRTP\_SCU initiates an association for RT Plan, RT Image, RT Dose, RT Structure Set and Spatial Registration based on the information selected by the user. The association is closed after completion of the transfer.

The configuration of the printer in Pinnacle<sup>3</sup> also includes the time-out value to wait for a reply message from the SCP. The default value is 30 seconds. If the time-out is exceeded, ADACRTP\_SCU will abort the association.

##### Associated Real-World Activity for Storage Operations:

ADACRTP\_SCU initiates associations on request from the user. An association is established with the specified application entity. ADACRTP\_SCU sends a C\_STORE request for each message to be sent.

**Table 16: Association Rejection response**

Result	Source	Reason/Diagnosis	Explanation
1 - rejected-permanent	1 - DICOM UL service-user	1 - no-reason-given	The connection is closed.
		2 - application-context-name-not supported	The connection is closed.
		3 - calling-AE-title-not-recognized	The connection is closed.
		7 - called-AE-title-not-recognized	The connection is closed.
	2 - DICOM UL service-provider (ACSE related)	1 - no-reason-given	The connection is closed.

Result	Source	Reason/Diagnosis	Explanation
	function)	2 - protocol-version-not-supported	The connection is closed.
	3 - DICOM UL service-provider (Presentation related function)	1 - temporary-congestion	The connection is closed.
		2 - Local-limit-exceeded	The connection is closed.
2 - rejected-transient	1 - DICOM UL service-user	1 - no-reason-given	The connection is closed.
		2 - application-context-name-not-supported	The connection is closed.
		3 - calling-AE-title-not-recognized	The connection is closed.
	2 - DICOM UL service-provider (ACSE related function)	7 - called-AE-title-not-recognized	The connection is closed.
		1 - no-reason-given	The connection is closed.
		2 - protocol-version-not-supported	The connection is closed.
	3 - DICOM UL service-provider (Presentation related function)	1 - temporary congestion	The connection is closed.
		2 - local-limit-exceeded	The connection is closed.

The behavior of the AE on receiving an association abort is summarized in next table.

**Table 17: Association Abort Handling**

Source	Reason/Diagnosis	behavior
0 - DICOM UL service-user (initiated abort)	0 - reason-not-specified	The connection is closed.
2 - DICOM UL service-provider (initiated abort)	0 - reason-not-specified	The connection is closed.
	1- unrecognized-PDU	The connection is closed.
	2 - unexpected-PDU	The connection is closed.
	4 - unrecognized-PDU parameter	The connection is closed.
	5 - unexpected-PDU parameter	The connection is closed.
	6 - invalid-PDU-parameter value	The connection is closed.

**4.2.2.3.1. (Real-World) Activity – Verification as SCU**

**4.2.2.3.1.1. Description and Sequencing of Activities**

The ADACRTP\_SCU implements the Verification service class / Verification SOP class to verify application level communication.

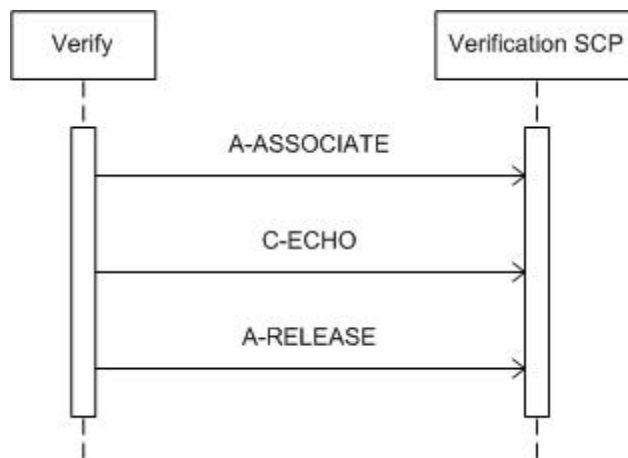

**Figure 6: Data Flow Diagram – Verification as SCU**

#### 4.2.2.3.1.2. Proposed Presentation Contexts

The presentation contexts are defined in the next table.

**Table 18: Proposed Presentation Contexts for (Real-World) Activity – Verification as SCU**

Presentation Context Table					
Abstract Syntax		Transfer Syntax		Role	Extended Negotiation
Name	UID	Name List	UID List		
Verification SOP Class	1.2.840.10008.1.1	Explicit VR Big Endian	1.2.840.10008.1.2.2	SCU	None
		Explicit VR Little Endian	1.2.840.10008.1.2.1		
		Implicit VR Little Endian	1.2.840.10008.1.2		

**Note:** ILE is the Pinnacle SCU default syntax. It is possible to configure our Pinnacle SCU to additionally handle ELE and EBE but it is not configured as such by default.

#### 4.2.2.3.1.3. SOP Specific Conformance for Verification SOP Class

This section and sub-section include the manufacturer SOP and Dataset specific information as well the status codes and their corresponding behavior.

##### 4.2.2.3.1.3.1. Dataset Specific Conformance for Verification C-ECHO SCU

Detail regarding the Dataset Specific response behavior will be reported in this section.

This part of the section includes the dataset specific behavior, i.e. error codes, error and exception handling, time-outs, etc.

**Table 19: Status Response**

Service Status	Error Code	Further Meaning	Behavior
Success	0000	Confirmation	The SCP has successfully returned a verification response.

#### 4.2.2.3.2. (Real-World) Activity – Image Export

##### 4.2.2.3.2.1. Description and Sequencing of Activities

This section contains a UML sequence diagram, which depicts the Application Entity and Real-World Activities as vertical bars and shows the events exchanged between them as arrows.

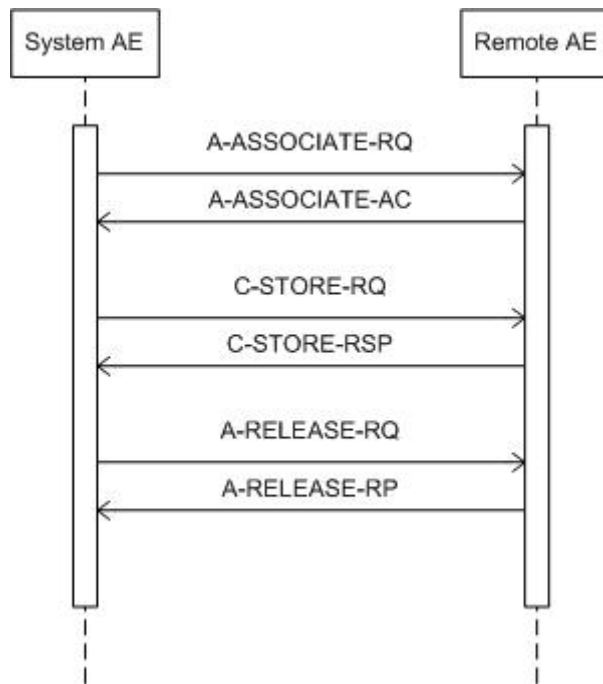

Figure 7: (Real World) Activity - Export

4.2.2.3.2.2. Proposed Presentation Contexts

The presentation contexts are defined in the next table.

Table 20: Proposed Presentation Contexts for (Real-World) Activity – Export

Presentation Context Table					
Abstract Syntax		Transfer Syntax		Role	Extended Negotiation
Name	UID	Name List	UID List		
Computed Radiography Image Storage SOP Class	1.2.840.10008.5.1.4.1.1.1	Explicit VR Big Endian	1.2.840.10008.1.2.2	SCU	None
		Explicit VR Little Endian	1.2.840.10008.1.2.1		
		Implicit VR Little Endian	1.2.840.10008.1.2		
Positron Emission Tomography Image Storage SOP Class	1.2.840.10008.5.1.4.1.1.128	Implicit VR Little Endian	1.2.840.10008.1.2	SCU	None
		Explicit VR Big Endian	1.2.840.10008.1.2.2		
		Explicit VR Little Endian	1.2.840.10008.1.2.1		
CT Image Storage SOP Class	1.2.840.10008.5.1.4.1.1.2	Implicit VR Little Endian	1.2.840.10008.1.2	SCU	None
		Explicit VR Big Endian	1.2.840.10008.1.2.2		
		Explicit VR Little Endian	1.2.840.10008.1.2.1		
Nuclear Medicine Image Storage SOP Class	1.2.840.10008.5.1.4.1.1.20	Implicit VR Little Endian	1.2.840.10008.1.2	SCU	None
		Explicit VR Big Endian	1.2.840.10008.1.2.2		
		Explicit VR Little Endian	1.2.840.10008.1.2.1		
MR Image Storage SOP Class	1.2.840.10008.5.1.4.1.1.4	Implicit VR Little Endian	1.2.840.10008.1.2	SCU	None
		Explicit VR Big Endian	1.2.840.10008.1.2.2		
		Explicit VR Little Endian	1.2.840.10008.1.2.1		
RT Image Storage SOP Class	1.2.840.10008.5.1.4.1.1.481.1	Implicit VR Little Endian	1.2.840.10008.1.2	SCU	None
		Explicit VR Big Endian	1.2.840.10008.1.2.2		
		Explicit VR Little Endian	1.2.840.10008.1.2.1		

Presentation Context Table					
Abstract Syntax		Transfer Syntax		Role	Extended Negotiation
Name	UID	Name List	UID List		
RT Dose Storage SOP Class	1.2.840.10008.5.1.4.1.1.481.2	Implicit VR Little Endian	1.2.840.10008.1.2	SCU	None
		Explicit VR Big Endian	1.2.840.10008.1.2.2		
		Explicit VR Little Endian	1.2.840.10008.1.2.1		
RT Structure Set Storage SOP Class	1.2.840.10008.5.1.4.1.1.481.3	Implicit VR Little Endian	1.2.840.10008.1.2	SCU	None
		Explicit VR Big Endian	1.2.840.10008.1.2.2		
		Explicit VR Little Endian	1.2.840.10008.1.2.1		
RT Plan Storage SOP Class	1.2.840.10008.5.1.4.1.1.481.5	Implicit VR Little Endian	1.2.840.10008.1.2	SCU	None
		Explicit VR Big Endian	1.2.840.10008.1.2.2		
		Explicit VR Little Endian	1.2.840.10008.1.2.1		
Spatial Registration Storage	1.2.840.10008.5.1.4.1.1.66.1	Implicit VR Little Endian	1.2.840.10008.1.2	SCU	None
		Explicit VR Big Endian	1.2.840.10008.1.2.2		
		Explicit VR Little Endian	1.2.840.10008.1.2.1		
Secondary Capture Image Storage SOP Class	1.2.840.10008.5.1.4.1.1.7	Implicit VR Little Endian	1.2.840.10008.1.2	SCU	None
		Explicit VR Big Endian	1.2.840.10008.1.2.2		
		Explicit VR Little Endian	1.2.840.10008.1.2.1		

#### 4.2.2.3.2.3. SOP Specific Conformance for Storage SOP Classes

This section and sub-section include the manufacturer SOP and Dataset specific information as well the status codes and their corresponding behavior.

##### 4.2.2.3.2.3.1. Dataset Specific Conformance for C-STORE-RQ

Detail regarding the Dataset Specific response behavior will be reported in this section.

This includes the dataset specific behavior, i.e. error codes, error and exception handling, time-outs, etc.

**Table 21: Status Response**

Service Status	Error Code	Further Meaning	Behavior
Success	0000	Successful stored	
Failure	A7xx	Refused: Out of Resources	
	A9xx	Error: Data Set does not match SOP Class	
	Cxxx	Error: cannot understand	
Warning	B000	Coercion of Data Elements	
	B007	Data Set does not match SOP Class	
	B006	Elements Discarded	

#### 4.2.2.3.3. (Real-World) Activity – Print Management as SCU

##### 4.2.2.3.3.1. Description and Sequencing of Activities

The ADACRTP\_SCU application entity initiates an association for the Color or Grayscale print services class based on the configuration of the printer in Pinnacle<sup>3</sup>. The association is closed when the response to the N-ACTION on the Basic Film Session or Basic Film Box SOP classes is received.

The configuration of the printer in Pinnacle<sup>3</sup> also includes the time-out value to wait for a reply message from the SCP. The default value is 30 seconds. If the time-out is exceeded, ADACRTP\_SCU will abort the association.

The ADACRTP\_SCU application entity initiates associations for the printing of images to a Basic Print SCP. The image to be printed is specified by the user.

When the user requests a print, an association is established with the configured application entity. ADACRTP\_SCU sends a Printer, N-GET message to the Basic Print SCP to determine the status of the printer. This is followed by a Basic Film Session N-CREATE message, which in turn is followed by a Basic Film Box N-CREATE. Depending on the configuration of the printer, ADACRTP\_SCU will then transmit a N-SET message on a Basic Grayscale or Color Image Box. Finally, an N-ACTION message is sent to instruct the Basic Print SCP to print either at the Basic Film Session or at the Basic Film Box level, depending on printer configuration.

The below UML sequence diagram depicts the Application Entity and Real-World Activities as vertical bars and shows the events exchanged between them as arrows.

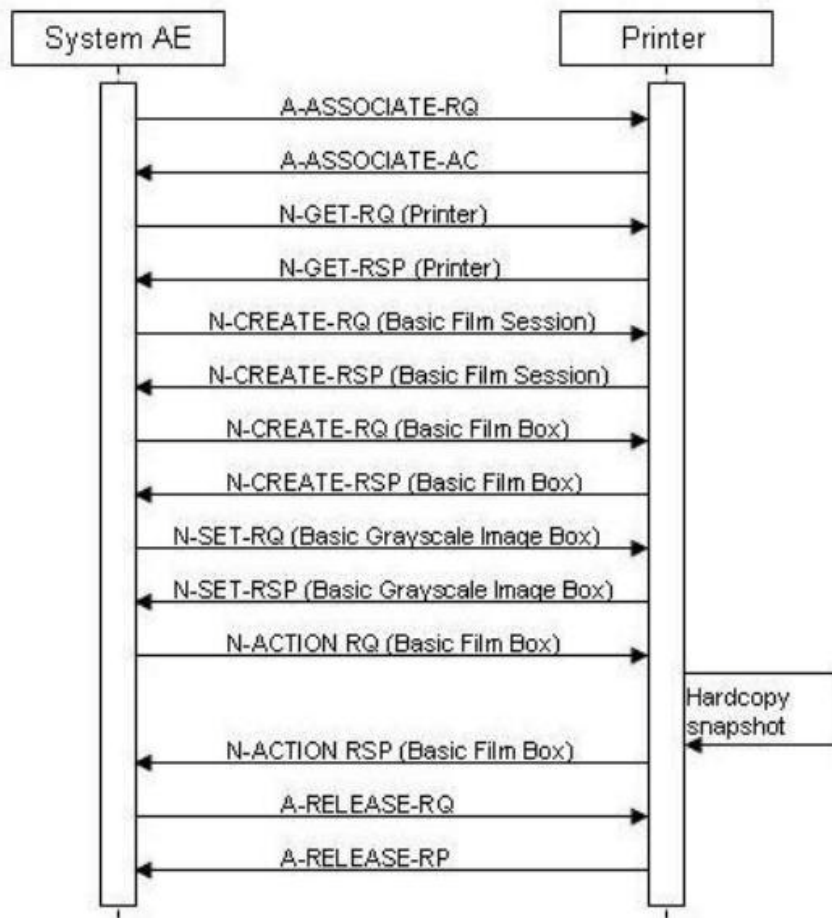

Figure 8: (Real World) Activity - Print Management as SCU

4.2.2.3.3.2. Proposed Presentation Contexts

The presentation contexts are defined in the next table.



**Table 22: Proposed Presentation Contexts for (Real-World) Activity – Print Management As SCU**

Presentation Context Table					
Abstract Syntax		Transfer Syntax		Role	Extended Negotiation
Name	UID	Name List	UID List		
Basic Color Print Management Meta SOP Class (1.2.840.10008.5.1.1.18)					
>Basic Film Session SOP Class	1.2.840.10008.5.1.1.1	Implicit VR Little Endian	1.2.840.10008.1.2	SCU	None
>Basic Film Box SOP Class	1.2.840.10008.5.1.1.2	Implicit VR Little Endian	1.2.840.10008.1.2	SCU	None
>Basic Color Image Box SOP Class	1.2.840.10008.5.1.1.4.1	Implicit VR Little Endian	1.2.840.10008.1.2	SCU	None
>Printer SOP Class	1.2.840.10008.5.1.1.16	Implicit VR Little Endian	1.2.840.10008.1.2	SCU	None
Basic Grayscale Print Management Meta SOP Class (1.2.840.10008.5.1.1.9)					
>Basic Film Session SOP Class	1.2.840.10008.5.1.1.1	Implicit VR Little Endian	1.2.840.10008.1.2	SCU	None
>Basic Film Box SOP Class	1.2.840.10008.5.1.1.2	Implicit VR Little Endian	1.2.840.10008.1.2	SCU	None
>Basic Grayscale Image Box SOP Class	1.2.840.10008.5.1.1.4	Implicit VR Little Endian	1.2.840.10008.1.2	SCU	None
>Printer SOP Class	1.2.840.10008.5.1.1.16	Implicit VR Little Endian	1.2.840.10008.1.2	SCU	None

This section specifies each IOD created (including private IOD's).

Abbreviations used in the Module table for the column "Presence of Value" are:

ALWAYS	The attribute is always present with a value
EMPTY	The attribute is always present without any value (attribute sent zero length)
VNAP	The attribute is always present and its Value is Not Always Present (attribute sent zero length if no value is present)
ANAP	The attribute is present under specified condition – if present then it will always have a value
ANAPCV	The attribute is present under specified condition – if present then its Value is Not Always Present (attribute sent zero length if condition applies and no value is present)
ANAPEV	The attribute is present under specified condition – if present then it will not have any value

The abbreviations used in the Module table for the column "Source" are:

AUTO	The attribute value is generated automatically
CONFIG	The attribute value source is a configurable parameter
COPY	The attribute value source is another SOP instance
FIXED	The attribute value is hard-coded in the application
IMPLICIT	The attribute value source is a user-implicit setting
MPPS	The attribute value is the same as that use for Modality Performed Procedure Step
MWL	The attribute value source is a Modality Worklist
USER	The attribute value source is explicit user input

#### 4.2.2.3.3.3. SOP Specific Conformance for Basic Film Session SOP Class of the Basic Color Print Management Meta SOP Class

This section and sub-section include the manufacturer SOP and Dataset specific information as well the status codes and their corresponding behavior.

##### 4.2.2.3.3.3.1. Dataset Specific Conformance for Basic Film Session SOP Class N-CREATE-SCU

Detail regarding the Dataset Specific response behavior will be reported in this section.

**Table 23: Basic Film Session Presentation Module**

Attribute Name	Tag	VR	Value	Presence of Value	Source	Comment
Number of Copies	2000,0010	IS	1	ANAPCV	CONFIG, USER	
Print Priority	2000,0020	CS	MEDIUM	ANAPCV	CONFIG, USER	
Medium Type	2000,0030	CS	PAPER, CLEAR FILM, or BLUE FILM	ANAPCV	USER	Default: PAPER
Film Destination	2000,0040	CS	MAGAZINE, PROCESSOR, BIN_1, BIN_2, BIN_3, BIN_4, BIN_5, BIN_6, BIN_7, or BIN_8	ANAPCV	USER	Default: MAGAZINE

This part of the section includes the dataset specific behavior, i.e. error codes, error and exception handling, time-outs, etc.

**Table 24: Status Response**

Service Status	Error Code	Further Meaning	Behavior
Success	0000	Matching is complete	The SCU has successfully returned all matching information

#### 4.2.2.3.3.3.2. Dataset Specific Conformance for Basic Film Session SOP Class N-ACTION-SCU

Detail regarding the Dataset Specific response behavior will be reported in this section.

This part of the section includes the dataset specific behavior, i.e. error codes, error and exception handling, time-outs, etc.

**Table 25: Status Response**

Service Status	Error Code	Further Meaning	Behavior
Success	0000	Matching is complete	The SCU has successfully returned all matching information

#### 4.2.2.3.3.4. SOP Specific Conformance for Basic Film Session SOP Class of the Basic Grayscale Print Management Meta SOP Class

This section and sub-section include the manufacturer SOP and Dataset specific information as well the status codes and their corresponding behavior.

##### 4.2.2.3.3.4.1. Dataset Specific Conformance for Basic Film Session SOP Class N-CREATE-SCU

Detail regarding the Dataset Specific response behavior will be reported in this section.

**Table 26: Basic Film Session Presentation Module**

Attribute Name	Tag	VR	Value	Presence of Value	Source	Comment
Number of Copies	2000,0010	IS	1	ANAPCV	CONFIG, USER	
Print Priority	2000,0020	CS	MEDIUM	ANAPCV	CONFIG, USER	

Medium Type	2000,0030	CS	PAPER, CLEAR FILM, BLUE FILM	ANAPCV	USER	Default: PAPER
Film Destination	2000,0040	CS	MAGAZINE, PROCESSOR, BIN_1, BIN_2, BIN_3, BIN_4, BIN_5, BIN_6, BIN_7, BIN_8	ANAPCV	USER	Default: MAGAZINE

This part of the section includes the dataset specific behavior, i.e. error codes, error and exception handling, time-outs, etc.

**Table 27: Status Response**

Service Status	Error Code	Further Meaning	Behavior
Success	0000	Matching is complete	The SCU has successfully returned all matching information

#### 4.2.2.3.3.4.2. Dataset Specific Conformance for Basic Film Session SOP Class N-ACTION-SCU

Detail regarding the Dataset Specific response behavior will be reported in this section.

This part of the section includes the dataset specific behavior, i.e. error codes, error and exception handling, time-outs, etc.

**Table 28: Status Response**

Service Status	Error Code	Further Meaning	Behavior
Success	0000	Matching is complete	The SCU has successfully returned all matching information

#### 4.2.2.3.3.5. SOP Specific Conformance for Printer SOP Class of the Basic Color Print Management Meta SOP Class

This section and sub-section include the manufacturer SOP and Dataset specific information as well the status codes and their corresponding behavior.

#### 4.2.2.3.3.5.1. Dataset Specific Conformance for Printer SOP Class N-EVENT-REPORT-SCP

Detail regarding the Dataset Specific response behavior will be reported in this section.

This part of the section includes the dataset specific behavior, i.e. error codes, error and exception handling, time-outs, etc.

**Table 29: Status Response**

Service Status	Error Code	Further Meaning	Behavior
Success	0000	Matching is complete	The SCU has successfully returned all matching information

#### 4.2.2.3.3.5.2. Dataset Specific Conformance for Printer SOP Class N-GET-SCU

Detail regarding the Dataset Specific response behavior will be reported in this section.

**Table 30: Printer Module<sup>\*</sup>**

Attribute Name	Tag	VR	Value <sup>*</sup>	Presence of Value	Source	Comment
Manufacturer	0008,0070	LO		ANAPCV	COPY	None
Manufacturer's Model Name	0008,1090	LO		ANAPCV	COPY	None

Device Serial Number	0018,1000	LO		ANAPCV	COPY	None
Software Version(s)	0018,1020	LO		ANAPCV	COPY	None
Printer Status	2110,0010	CS		ANAPCV	COPY	None
Printer Status Info	2110,0020	CS		ANAPCV	COPY	None

The System conforms to the SOPs of the Print Service Class at level 2 (full). No data elements are discarded or coerced by the System.

**Note:** \*The actual values depend on the type of printer.

**Table 31: Status Response**

Service Status	Error Code	Further Meaning	Behavior
Success	0000	Matching is complete	The SCU has successfully returned all matching information

#### 4.2.2.3.3.6. SOP Specific Conformance for Printer SOP Class of the Basic Grayscale Print Management Meta SOP Class

This section and sub-section include the manufacturer SOP and Dataset specific information as well the status codes and their corresponding behavior.

##### 4.2.2.3.3.6.1. Dataset Specific Conformance for Printer SOP Class N-EVENT-REPORT-SCP

Detail regarding the Dataset Specific response behavior will be reported in this section.

This part of the section includes the dataset specific behavior, i.e. error codes, error and exception handling, time-outs, etc.

**Table 32: Status Response**

Service Status	Error Code	Further Meaning	Behavior
Success	0000	Matching is complete	The SCU has successfully returned all matching information

##### 4.2.2.3.3.6.2. Dataset Specific Conformance for Printer SOP Class N-GET-SCU

Detail regarding the Dataset Specific response behavior will be reported in this section.

**Table 33: Printer Module<sup>\*</sup>**

Attribute Name	Tag	VR	Value *	Presence of Value	Source	Comment
Manufacturer	0008,0070	LO		ANAPCV	AUTO	None
Manufacturer's Model Name	0008,1090	LO		ANAPCV	AUTO	None
Device Serial Number	0018,1000	LO		ANAPCV	AUTO	None
Software Version(s)	0018,1020	LO		ANAPCV	AUTO	None
Printer Status	2110,0010	CS		ANAPCV	AUTO	None
Printer Status Info	2110,0020	CS		ANAPCV	AUTO	None

The System conforms to the SOPs of the Print Service Class at level 2 (full). No data elements are discarded or coerced by the System.

**Note:** \*The actual values depend on the type of printer.

**Table 34: Status Response**

Service Status	Error Code	Further Meaning	Behavior
Success	0000	Matching is complete	The SCU has successfully returned all matching information

#### 4.2.2.3.3.7. SOP Specific Conformance for Basic Film Box SOP Class of the Basic Grayscale Print Management Meta SOP Class

This section and sub-section include the manufacturer SOP and Dataset specific information as well the status codes and their corresponding behavior.

##### 4.2.2.3.3.7.1. Dataset Specific Conformance for Basic Film Box SOP Class N-CREATE-SCU

Detail regarding the Dataset Specific response behavior will be reported in this section.

**Table 35: Basic Film Box Presentation Module**

Attribute Name	Tag	VR	Value	Presence of Value	Source	Comment
Image Display Format	2010,0010	ST	STANDARD\1,1	ALWAYS	CONFIG	
Film Orientation	2010,0040	CS	PORTRAIT	ANAPCV	CONFIG, USER	
Film Size ID	2010,0050	CS	14INX17IN, 14INX14IN, 11INX14IN, 10INX14IN, 10INX12IN, 8INX10IN, 24CMX30CM, or 24CMX24CM	ANAPCV	CONFIG, USER	Default: 14INX17IN
Magnification Type	2010,0060	CS	CUBIC, BILINEAR, or REPLICATE	ANAPCV	CONFIG	Default: CUBIC
Smoothing Type	2010,0080	CS		ANAPCV	CONFIG	
Border Density	2010,0100	CS	BLACK or WHITE	ANAPCV	CONFIG	Default: WHITE
Empty Image Density	2010,0110	CS	BLACK or WHITE	ANAPCV	CONFIG	Default: BLACK
Max Density	2010,0130	US		ANAPCV	CONFIG	
Trim	2010,0140	CS	YES or NO	ANAPCV	CONFIG, USER	Default: NO
Configuration Information	2010,0150	ST		ANAPCV	CONFIG	

This part of the section includes the dataset specific behavior, i.e. error codes, error and exception handling, time-outs, etc.

**Table 36: Status Response**

Service Status	Error Code	Further Meaning	Behavior
Success	0000	Matching is complete	The SCU has successfully returned all matching information

##### 4.2.2.3.3.7.2. Dataset Specific Conformance for Basic Film Box SOP Class N-ACTION-SCU

Detail regarding the Dataset Specific response behavior will be reported in this section.

This part of the section includes the dataset specific behavior, i.e. error codes, error and exception handling, time-outs, etc.

**Table 37: Status Response**

Service Status	Error Code	Further Meaning	Behavior
Success	0000	Matching is complete	The SCU has successfully returned all matching information

#### 4.2.2.3.3.8. SOP Specific Conformance for Basic Film Box SOP Class of the Basic Color Print Management Meta SOP Class

This section and sub-section include the manufacturer SOP and Dataset specific information as well the status codes and their corresponding behavior.

##### 4.2.2.3.3.8.1. Dataset Specific Conformance for Basic Film Box SOP Class N-CREATE-SCU

Detail regarding the Dataset Specific response behavior will be reported in this section.

**Table 38: Basic Film Box Presentation Module**

Attribute Name	Tag	VR	Value	Presence of Value	Source	Comment
Image Display Format	2010,0010	ST	STANDARD\1,1	ALWAYS	CONFIG	
Film Orientation	2010,0040	CS	PORTRAIT	ANAPCV	CONFIG, USER	
Film Size ID	2010,0050	CS	14INX17IN, 14INX14IN, 11INX14IN, 10INX14IN, 10INX12IN, 8INX10IN, 24CMX30CM, or 24CMX24CM	ANAPCV	CONFIG, USER	Default: 14INX17IN
Magnification Type	2010,0060	CS	CUBIC, BILINEAR, or REPLICATE	ANAPCV	CONFIG	Default: CUBIC
Smoothing Type	2010,0080	CS		ANAPCV	CONFIG	
Border Density	2010,0100	CS	BLACK or WHITE	ANAPCV	CONFIG	Default: WHITE
Empty Image Density	2010,0110	CS	BLACK or WHITE	ANAPCV	CONFIG	Default: BLACK
Max Density	2010,0130	US		ANAPCV	CONFIG	
Trim	2010,0140	CS	YES or NO	ANAPCV	CONFIG, USER	Default: NO
Configuration Information	2010,0150	ST		ANAPCV	CONFIG	

This part of the section includes the dataset specific behavior, i.e. error codes, error and exception handling, time-outs, etc.

**Table 39: Status Response**

Service Status	Error Code	Further Meaning	Behavior
Success	0000	Matching is complete	The SCU has successfully returned all matching information

##### 4.2.2.3.3.8.2. Dataset Specific Conformance for Basic Film Box SOP Class N-ACTION-SCU

Detail regarding the Dataset Specific response behavior will be reported in this section.

This part of the section includes the dataset specific behavior, i.e. error codes, error and exception handling, time-outs, etc.

**Table 40: Status Response**

Service Status	Error Code	Further Meaning	Behavior
Success	0000	Matching is complete	The SCU has successfully returned all matching information

#### 4.2.2.3.3.9. SOP Specific Conformance for Basic Grayscale Image Box SOP Class of the Basic Grayscale Print Management Meta SOP Class

This section and sub-section include the manufacturer SOP and Dataset specific information as well the status codes and their corresponding behavior.

##### 4.2.2.3.3.9.1. Dataset Specific Conformance for Basic Grayscale Image Box SOP Class N-SET-SCU

Detail regarding the Dataset Specific response behavior will be reported in this section.

**Table 41: Image Box Pixel Presentation Module**

Attribute Name	Tag	VR	Value	Presence of Value	Source	Comment
Image Box Position	2020,0010	US	1	ALWAYS	AUTO	
Polarity	2020,0020	CS	NORMAL or REVERSE	ANAPCV	AUTO	
Requested Image Size	2020,0030	DS		ANAPCV	AUTO	
Basic Grayscale Image Sequence	2020,0110	SQ		ALWAYS	AUTO	
>Samples per Pixel	0028,0002	US	1	ALWAYS	AUTO	
>Photometric Interpretation	0028,0004	CS	MONOCHROME2	ALWAYS	AUTO	
>Rows	0028,0010	US		ALWAYS	AUTO	
>Columns	0028,0011	US		ALWAYS	AUTO	
>Pixel Aspect Ratio	0028,0034	IS		ANAP	AUTO	Value required only if not 1:1.
>Bits Allocated	0028,0100	US	8	ALWAYS	AUTO	
>Bits Stored	0028,0101	US	8	ALWAYS	AUTO	
>High Bit	0028,0102	US	7	ALWAYS	AUTO	
>Pixel Representation	0028,0103	US	0x0000	ALWAYS	AUTO	
>Pixel Data	7FE0,0010	OW/OB		ALWAYS	AUTO	

This part of the section includes the dataset specific behavior, i.e. error codes, error and exception handling, time-outs, etc.

**Table 42: Status Response**

Service Status	Error Code	Further Meaning	Behavior
Success	0000	Matching is complete	The SCU has successfully returned all matching information

#### 4.2.2.3.3.10. SOP Specific Conformance for Basic Color Image Box SOP Class of the Basic Color Print Management Meta SOP Class

This section and sub-section include the manufacturer SOP and Dataset specific information as well the status codes and their corresponding behavior.

##### 4.2.2.3.3.10.1. Dataset Specific Conformance for Basic Color Image Box SOP Class N-SET-SCU

Detail regarding the Dataset Specific response behavior will be reported in this section.

**Table 43: Image Box Pixel Presentation Module**

Attribute Name	Tag	VR	Value	Presence of Value	Source	Comment
Image Box Position	2020,0010	US	1	ALWAYS	AUTO	

Polarity	2020,0020	CS	NORMAL or REVERSE	ANAPCV	AUTO	
Requested Image Size	2020,0030	DS		ANAPCV	AUTO	
Basic Color Image Sequence	2020,0111	SQ		ALWAYS	AUTO	
>Samples per Pixel	0028,0002	US	3	ALWAYS	AUTO	
>Photometric Interpretation	0028,0004	CS	RGB	ALWAYS	AUTO	
>Planar Configuration	0028,0006	US	0	ALWAYS	AUTO	
>Rows	0028,0010	US		ALWAYS	AUTO	
>Columns	0028,0011	US		ALWAYS	AUTO	
>Pixel Aspect Ratio	0028,0034	IS	1\1	ANAP	AUTO	
>Bits Allocated	0028,0100	US	8	ALWAYS	AUTO	
>Bits Stored	0028,0101	US	8	ALWAYS	AUTO	
>High Bit	0028,0102	US	7	ALWAYS	AUTO	
>Pixel Representation	0028,0103	US	0x0000	ALWAYS	AUTO	
>Pixel Data	7FE0,0010	OW/OB		ALWAYS	AUTO	

This part of the section includes the dataset specific behavior, i.e. error codes, error and exception handling, time-outs, etc.

**Table 44: Status Response**

Service Status	Error Code	Further Meaning	Behavior
Success	0000	Matching is complete	The SCU has successfully returned all matching information



#### 4.2.2.4. Association Acceptance Policy

Not applicable.

## 4.3. Network Interfaces

### 4.3.1. Physical Network Interfaces

The System provides only DICOM V3.0 TCP/IP Network Communication Support as defined in PS 3.8 of the standard. TCP/IP is the only protocol stack supported.

Supported physical medium include:

IEEE 802.3-1995, 10BASE-T

IEEE 802.3-1995, 100BASE-TX (Fast Ethernet)

IEEE 802.3, 1000BASE-X (Fiber Optic Gigabit Ethernet).

The TCP/IP Stack as supported by the underlying Operating System.

The API is the WinSock 2 interface as supported by the underlying Operating System.

### 4.3.2. Additional Protocols

Additional protocols such as used for network management are not applicable.

## 4.4. Configuration

Any implementation's DICOM conformance may be dependent upon configuration, which takes place at the time of installation. Issues concerning configuration are addressed in this section.

### 4.4.1. AE Title/Presentation Address Mapping

#### 4.4.1.1. Local AE Titles

**DICOM Port:** The port number combined with the application entity title identifying ADACRTP\_SCP to DICOM clients on the network (default: 104).

**Application Entity Title:** The name of ADACRTP\_SCP by which, combined with the DICOM Port number, DICOM clients may address the server (default: ADACRTP\_SCP).

The local AE title mapping and configuration are specified as:

**Table 45: AE Title configuration table**

Application Entity	Default AE Title	Default TCP/IP Port
DICOM Server	<hostname>; <hostname><local folder>; SCU: ADACRTP_SCU; SCP: ADACRTP_SCP	104 (Configurable)
Print	ADACRTP_SCU	Configurable

#### 4.4.1.2. Remote AE Title/Presentation Address Mapping

One or more remote AEs can be configured.

The following AE specific information must be available to configure a remote AE:

- AE title.
- Hostname or IP address (or both).
- Port number.

### 4.4.2. Parameters

The specification of important operational parameters, their default value and range (if configurable) is specified here.

**Table 46: Configuration Parameters Table**

General Parameter	Configurable	Default Value
Association Release Time-out	Yes	15 seconds
Association Reply Time-out	Yes	15 seconds
Association Time-out	Yes	30 seconds
Port-Number	Yes	104
TCP/IP Listen Port	Yes	104
Maximum PDU size the AE can receive	Yes	28672 bytes
Maximum PDU size the AE can send	Yes	28672 bytes
Connection Time-out	Yes	15 seconds
Inactivity Time-out	Yes	15 seconds

These configurations may be performed by Customer Support.

## 5. Media Interchange

### 5.1. Implementation model

#### 5.1.1. Application Data Flow Diagram

Not applicable, Pinnacle<sup>3</sup> does not support any Media for image Import/Export.

#### 5.1.2. Functional Definitions of AE's

Not applicable.

#### 5.1.3. Sequencing of Real World Activities

Not applicable.

### 5.2. AE Specifications

Not applicable.

#### 5.2.1. Media AE Media - Specification

Not applicable.

##### 5.2.1.1. File Meta Information for the Media AE

Not applicable.

##### 5.2.1.2. Real-World Activities

Not applicable.

###### 5.2.1.2.1. RWA - Read File-set

Not applicable.

###### 5.2.1.2.1.1. Media Storage Application Profile

Not applicable.

###### 5.2.1.2.1.1.1. Options

Not applicable.

###### 5.2.1.2.2. RWA - Create File-set

Not applicable.

###### 5.2.1.2.2.1. Media Storage Application Profile

Not applicable.

###### 5.2.1.2.2.1.1. Options

Not applicable.

### **5.3. Augmented and Private Application Profiles**

Not applicable

### **5.4. Media Configuration**

Not applicable.

## 6. Support of Character Sets

Any support for character sets in Network and Media services is described here.

**Table 47: Supported DICOM Character Sets**

Character Set Description	Defined Term	ESC Sequence	ISO Registration Number	Code Element	Character Set
Latin alphabet No. 1	ISO_IR 100	-	ISO-IR 6	G0	ISO 646
		-	ISO-IR 100	G1	Supplementary set of ISO 8859

## 7. Security

### 7.1. Security Profiles

Not applicable.

#### 7.1.1. Security use Profiles

Not applicable.

#### 7.1.2. Security Transport Connection Profiles

Not applicable.

#### 7.1.3. Digital Signature Profiles

Not applicable.

#### 7.1.4. Media Storage Security Profiles

Not applicable.

#### 7.1.5. Attribute Confidentiality Profiles

Not applicable.

#### 7.1.6. Network Address Management Profiles

Not applicable.

#### 7.1.7. Time Synchronization Profiles

Not applicable.

#### 7.1.8. Application Configuration Management Profiles

Not applicable.

#### 7.1.9. Audit Trail Profiles

Not applicable.

### 7.2. Association Level Security

Not applicable.

### 7.3. Application Level Security

Not applicable.

## 8. Annexes of application "Pinnacle"

### 8.1. IOD Contents

#### 8.1.1. Created SOP Instance

This section specifies each IOD created by this application.

This section specifies each IOD created (including private IOD's). It should specify the attribute name, tag, VR, and value. The value should specify the range and source (e.g. user input, Modality Worklist, automatically generated, etc.). For content items in templates, the range and source of the concept name and concept values should be specified. Whether the value is always present or not shall be specified.

Abbreviations used in the IOD tables for the column "Presence of Module" are:

ALWAYS           The module is always present  
CONDITIONAL    The module is used under specified condition

Abbreviations used in the Module table for the column "Presence of Value" are:

ALWAYS           The attribute is always present with a value  
EMPTY            The attribute is always present without any value (attribute sent zero length)  
VNAP             The attribute is always present and its Value is Not Always Present  
                    (attribute sent zero length if no value is present)  
ANAP             The attribute is present under specified condition – if present then it will always have a value  
ANAPCV          The attribute is present under specified condition – if present then its Value is Not Always Present  
                    (attribute sent zero length if condition applies and no value is present)  
ANAPEV          The attribute is present under specified condition – if present then it will not have any value

The abbreviations used in the Module table for the column "Source" are:

AUTO             The attribute value is generated automatically  
CONFIG          The attribute value source is a configurable parameter  
COPY            The attribute value source is another SOP instance  
FIXED            The attribute value is hard-coded in the application  
IMPLICIT        The attribute value source is a user-implicit setting  
MPPS            The attribute value is the same as that use for Modality Performed Procedure Step  
MWL             The attribute value source is a Modality Worklist  
USER            The attribute value source is explicit user input

##### 8.1.1.1. List of created SOP Classes

**Table 48: List of created SOP Classes**

SOP Class Name	SOP Class UID
Computed Radiography Image Storage SOP Class	1.2.840.10008.5.1.4.1.1.1
RT Image Storage SOP Class	1.2.840.10008.5.1.4.1.1.481.1
RT Dose Storage SOP Class	1.2.840.10008.5.1.4.1.1.481.2
RT Structure Set Storage SOP Class	1.2.840.10008.5.1.4.1.1.481.3
RT Plan Storage SOP Class	1.2.840.10008.5.1.4.1.1.481.5
Spatial Registration Storage	1.2.840.10008.5.1.4.1.1.66.1
Secondary Capture Image Storage SOP Class	1.2.840.10008.5.1.4.1.1.7



## 8.1.1.2. Computed Radiography Image Storage SOP Class

Table 49: IOD of Created Computed Radiography Image Storage SOP Class Instances

Information Entity	Module	Presence Of Module
Patient	Patient Module	ALWAYS
Study	General Study Module	ALWAYS
Series	General Series Module	ALWAYS
Series	CR Series Module	ALWAYS
Equipment	General Equipment Module	ALWAYS
Image	General Image Module	ALWAYS
Image	CR Image Module	ALWAYS
Image	VOI LUT Module	ALWAYS
Image	SOP Common Module	ALWAYS

Table 50: Patient Module

Attribute Name	Tag	VR	Value	Presence of Value	Source	Comment
Patient's Name	0010,0010	PN		VNAP	COPY, USER	Patient's full legal name, as entered in Launch Pad.
Patient ID	0010,0020	LO		VNAP	COPY, USER	The patient's Medical Record Number, as entered in Launch Pad.
Patient's Birth Date	0010,0030	DA		VNAP	COPY, USER	The patient's Birth date, as entered in Launch Pad.
Patient's Sex	0010,0040	CS	M, F, or O	VNAP	COPY, USER	As appropriate based on Launch Pad entry.

Table 51: General Study Module

Attribute Name	Tag	VR	Value	Presence of Value	Source	Comment
Study Date	0008,0020	DA		VNAP	COPY	Copied from the Primary Image set, if transferred via DICOM.
Study Time	0008,0030	TM		VNAP	COPY	Copied from the Primary Image set, if transferred via DICOM.
Accession Number	0008,0050	SH		VNAP	COPY	Copied from the Primary Image set, if transferred via DICOM.
Referring Physician's Name	0008,0090	PN		VNAP	COPY	Copied from the Primary Image set, if transferred via DICOM.
Study Description	0008,1030	LO		ANAPCV	COPY, USER	Comment as entered in Launch Pad.
Physician of Record	0008,1048	PN		ANAPCV	COPY, USER	Physician as entered in Launch Pad.
Study Instance UID	0020,000D	UI		ALWAYS	AUTO, COPY	Copied from the Primary Image set, if transferred via DICOM, else it is generated
Study ID	0020,0010	SH		VNAP	COPY	Copied from the Primary Image set, if transferred via DICOM.

Table 52: General Series Module

Attribute Name	Tag	VR	Value	Presence of Value	Source	Comment
Modality	0008,0060	CS	CR	ALWAYS	AUTO, FIXED, COPY	

Series Instance UID	0020,000E	UI		ALWAYS	AUTO	Generated on Export.
Series Number	0020,0011	IS		VNAP	COPY	Empty.
Laterality	0020,0060	CS		ANAPCV	COPY	Empty.

Table 53: CR Series Module

Attribute Name	Tag	VR	Value	Presence of Value	Source	Comment
Body Part Examined	0018,0015	CS		VNAP	COPY	Empty.
View Position	0018,5101	CS		VNAP	COPY	Empty.

Table 54: General Equipment Module

Attribute Name	Tag	VR	Value	Presence of Value	Source	Comment
Manufacturer	0008,0070	LO	ADAC	VNAP	AUTO, COPY	
Station Name	0008,1010	SH		ANAPCV	CONFIG, COPY	The host name of the workstation which transmits the data.
Manufacturer's Model Name	0008,1090	LO	Pinnacle <sup>3</sup>	ANAPCV	AUTO, COPY	
Software Version(s)	0018,1020	LO		ANAPCV	FIXED	Current version of Pinnacle <sup>3</sup> which transmits the data.

Table 55: General Image Module

Attribute Name	Tag	VR	Value	Presence of Value	Source	Comment
Content Date	0008,0023	DA		ANAPCV	AUTO	Date the transfer was performed.
Content Time	0008,0033	TM		ANAPCV	AUTO	Time the transfer was performed.
Instance Number	0020,0013	IS	1	VNAP	FIXED	
Patient Orientation	0020,0020	CS		ANAPCV	COPY	Empty

Table 56: CR Image Module

Attribute Name	Tag	VR	Value	Presence of Value	Source	Comment
Imager Pixel Spacing	0018,1164	DS		ANAPCV	AUTO, COPY	Multivalve XY resolution of the image pixels.
Photometric Interpretation	0028,0004	CS	MONOCHROME2	ALWAYS	COPY	

Table 57: VOI LUT Module

Attribute Name	Tag	VR	Value	Presence of Value	Source	Comment
Window Center	0028,1050	DS		ANAP	AUTO, COPY	The default window center value for the image, for display purposes.
Window Width	0028,1051	DS		ANAP	AUTO, COPY	The default window width value for the image, for display purposes.

Table 58: SOP Common Module

Attribute Name	Tag	VR	Value	Presence of Value	Source	Comment
Specific Character Set	0008,0005	CS	ISO_IR 100	ANAP	AUTO, COPY	
Instance Creation Date	0008,0012	DA		ANAPCV	AUTO	The date the message was created.
Instance Creation Time	0008,0013	TM		ANAPCV	AUTO	The time the message was created.

SOP Class UID	0008,0016	UI	1.2.840.10008.5.1.4.1.1.1	ALWAYS	COPY	
SOP Instance UID	0008,0018	UI		ALWAYS	AUTO	

### 8.1.1.3. RT Image Storage SOP Class

**Table 59: IOD of Created RT Image Storage SOP Class Instances**

Information Entity	Module	Presence Of Module
Patient	Patient Module	ALWAYS
Study	General Study Module	ALWAYS
Series	RT Series Module	ALWAYS
Frame of Reference	Frame of Reference Module	ALWAYS
Equipment	General Equipment Module	ALWAYS
Image	General Image Module	ALWAYS
Image	Image Pixel Module	ALWAYS
Image	RT Image Module	ALWAYS
Image	Modality LUT Module	ALWAYS
Image	VOI LUT Module	ALWAYS
Image	SOP Common Module	ALWAYS

**Table 60: Patient Module**

Attribute Name	Tag	VR	Value	Presence of Value	Source	Comment
Patient's Name	0010,0010	PN		VNAP	COPY, USER	Patient's full legal name, as entered in Launch Pad.
Patient ID	0010,0020	LO		VNAP	COPY, USER	The patient's Medical Record Number, as entered in Launch Pad.
Patient's Birth Date	0010,0030	DA		VNAP	COPY, USER	The patient's Birth date, as entered in Launch Pad.
Patient's Sex	0010,0040	CS	M, F, or O	VNAP	COPY, USER	As appropriate based on Launch Pad entry.

**Table 61: General Study Module**

Attribute Name	Tag	VR	Value	Presence of Value	Source	Comment
Study Date	0008,0020	DA		VNAP	COPY	Copied from the Primary Image set, if transferred via DICOM.
Study Time	0008,0030	TM		VNAP	COPY	Copied from the Primary Image set, if transferred via DICOM.
Accession Number	0008,0050	SH		VNAP	COPY	Copied from the Primary Image set, if transferred via DICOM else it is generated.
Referring Physician's Name	0008,0090	PN		VNAP	COPY	Copied from the Primary Image set, if transferred via DICOM.
Study Description	0008,1030	LO		ANAPCV	COPY, USER	Comment as entered in Launch Pad.
Physician of Record	0008,1048	PN		ANAPCV	COPY, USER	Physician as entered in Launch Pad.
Referenced Study Sequence	0008,1110	SQ		ANAPCV	COPY	
>Referenced SOP Class UID	0008,1150	UI	1.2.840.10008.3.1.2.3.2	ANAP	AUTO	
>Referenced SOP Instance UID	0008,1155	UI		ANAP	AUTO	
Study Instance UID	0020,000D	UI		ALWAYS	AUTO, COPY	Generated.

Study ID	0020,0010	SH		VNAP	COPY	Copied from the Primary Image set, if transferred via DICOM.
----------	-----------	----	--	------	------	--

Table 62: RT Series Module

Attribute Name	Tag	VR	Value	Presence of Value	Source	Comment
Modality	0008,0060	CS	RTIMAGE	ALWAYS	COPY	
Series Description	0008,103E	LO		ANAPCV	COPY, USER	Series Description from DICOM Export Window.
Series Instance UID	0020,000E	UI		ALWAYS	AUTO	Generated.
Series Number	0020,0011	IS		VNAP	AUTO, COPY	Series Number from DICOM Export Window.

Table 63: Frame of Reference Module

Attribute Name	Tag	VR	Value	Presence of Value	Source	Comment
Frame of Reference UID	0020,0052	UI		ALWAYS	AUTO	Matches the Frame of Reference UID for the primary image set if the patient position has not been altered on import. If the patient position was altered on import, a new Frame of Reference UID will be generated.
Position Reference Indicator	0020,1040	LO		VNAP	COPY	

Table 64: General Equipment Module

Attribute Name	Tag	VR	Value	Presence of Value	Source	Comment
Manufacturer	0008,0070	LO	ADAC	VNAP	AUTO, COPY	
Station Name	0008,1010	SH		ANAPCV	CONFIG, COPY	The host name of the workstation which transmits the data.
Manufacturer's Model Name	0008,1090	LO	Pinnacle <sup>3</sup>	ANAPCV	AUTO, COPY	
Software Version(s)	0018,1020	LO		ANAPCV	FIXED	Current version of Pinnacle <sup>3</sup> which transmits the data.

Table 65: General Image Module

Attribute Name	Tag	VR	Value	Presence of Value	Source	Comment
Content Date	0008,0023	DA		ANAPCV	AUTO	Date the transfer was performed.
Content Time	0008,0033	TM		ANAPCV	AUTO	Time the transfer was performed.
Instance Number	0020,0013	IS		VNAP	AUTO	A unique number for each IOD instance sent in a single transfer operation.
Patient Orientation	0020,0020	CS		ANAPCV	COPY	Empty

Table 66: Image Pixel Module

Attribute Name	Tag	VR	Value	Presence of Value	Source	Comment
Rows	0028,0010	US		ALWAYS	AUTO, COPY	Number of rows in the image.
Columns	0028,0011	US		ALWAYS	AUTO, COPY	Number of columns in the image.

Pixel Data	7FE0,0010	OW/ OB		ALWAYS	COPY	Pixel data.
------------	-----------	-----------	--	--------	------	-------------

Table 67: RT Image Module

Attribute Name	Tag	VR	Value	Presence of Value	Source	Comment
Image Type	0008,0008	CS	DERIVED\SECONDARY\DRR	ALWAYS	AUTO	
Conversion Type	0008,0064	CS	WSD	VNAP	AUTO, COPY	
Operators' Name	0008,1070	PN		VNAP	COPY, USER	Dosimetrist Name as entered in Launch Pad.
Samples per Pixel	0028,0002	US	1	ALWAYS	AUTO, COPY	
Photometric Interpretation	0028,0004	CS	MONOCHROME2	ALWAYS	COPY	
Bits Allocated	0028,0100	US	16	ALWAYS	COPY	Number of bits allocated for each pixel sample. ('16')
Bits Stored	0028,0101	US	16	ALWAYS	COPY	Number of bits stored for each pixel sample. ('16')
High Bit	0028,0102	US	15	ALWAYS	COPY	Most significant bit for pixel sample data. ('15')
Pixel Representation	0028,0103	US	0	ALWAYS	COPY	Data representation of the pixel samples. ('0')
RT Image Label	3002,0002	SH		ALWAYS	AUTO, COPY	Beam Name appended with BEV .
RT Image Plane	3002,000C	CS	NORMAL	ALWAYS	COPY	
X-Ray Image Receptor Translation	3002,000D	DS	0.0\0.0\0.0	ANAPCV	COPY	
X-Ray Image Receptor Angle	3002,000E	DS		VNAP	COPY	If Image Type (0008,0008) is DRR, set to 0. Else it is equivalent to the collimator angle of the beam.
Image Plane Pixel Spacing	3002,0011	DS		VNAP	COPY	Pixel size in the format X\Y in mm.
RT Image Position	3002,0012	DS		VNAP	COPY	Coordinate of the center of the first pixel transmitted.
Radiation Machine Name	3002,0020	SH		VNAP	COPY	The name of the machine assigned to the beam corresponding to this image.
Radiation Machine SAD	3002,0022	DS		VNAP	COPY	Distance from source to gantry rotation axis for the beam in mm.
Radiation Machine SSD	3002,0024	DS		ANAPCV	COPY	Distance from source to patient surface for the beam in mm.
RT Image SID	3002,0026	DS		VNAP	COPY	SAD for the beam in mm.
Primary Dosimeter Unit	300A,00B3	CS	MU	VNAP	COPY	
Gantry Angle	300A,011E	DS		ANAPCV	COPY	The gantry angle of the beam for this control point. Control point zero will always represent the starting angle for the beam.
Beam Limiting Device Angle	300A,0120	DS		ANAPCV	COPY	The collimator angle for the beam.
Patient Support Angle	300A,0122	DS		ANAPCV	COPY	The couch angle for the beam.
Table Top Eccentric Angle	300A,0125	DS	0.0	ANAPCV	COPY	
Referenced RT Plan Sequence	300C,0002	SQ		ANAPCV	COPY	The sequence is included only if the export of an RT Plan is performed within the same association as RT Image instance.
>Referenced SOP Class UID	0008,1150	UI	1.2.840.10008.5.1.4.1.1.481.5	ANAPCV	COPY	

>Referenced SOP Instance UID	0008,1155	UI		ANAPCV	COPY	Instance UID of RT plan object exported in the same association as this RT Image instance.
Referenced Beam Number	300C,0006	IS		ANAPCV	COPY	Identifies the beam number of this beam within that RT Plan instance exported simultaneously with the RT Image instance.
>Primary Fluence Mode Sequence	3002,0050	SQ		ANAP	AUTO	Only a single item shall be exported in this sequence.  If the beam's energy is commissioned as "FFF", this sequence shall be sent.
>>Fluence Mode	3002,0051	CS	NON_STANDARD	ANAPCV	AUTO	
>>Fluence Mode ID	3002,0052	SH	FFF	ANAPCV	AUTO	

Table 68: Modality LUT Module

Attribute Name	Tag	VR	Value	Presence of Value	Source	Comment
Rescale Intercept	0028,1052	DS	0.0	ANAP	COPY	
Rescale Slope	0028,1053	DS	1.0	ANAP	COPY	
Rescale Type	0028,1054	LO	US	ANAP	COPY	

Table 69: VOI LUT Module

Attribute Name	Tag	VR	Value	Presence of Value	Source	Comment
Window Center	0028,1050	DS		ANAP	AUTO	The default window center value for the image, for display purposes.
Window Width	0028,1051	DS		ANAP	AUTO	The default window width value for the image, for display purposes.

Table 70: SOP Common Module

Attribute Name	Tag	VR	Value	Presence of Value	Source	Comment
Specific Character Set	0008,0005	CS	ISO_IR 100	ANAP	AUTO, COPY	
Instance Creation Date	0008,0012	DA		ANAPCV	AUTO	The date the message was created.
Instance Creation Time	0008,0013	TM		ANAPCV	AUTO	The time the message was created.
SOP Class UID	0008,0016	UI	1.2.840.10008.5.1.4.1.1.481.1	ALWAYS	COPY	
SOP Instance UID	0008,0018	UI		ALWAYS	AUTO	Generated.

#### 8.1.1.4. RT Dose Storage SOP Class

Table 71: IOD of Created RT Dose Storage SOP Class Instances

Information Entity	Module	Presence Of Module
Patient	Patient Module	ALWAYS
Study	General Study Module	ALWAYS
Series	RT Series Module	ALWAYS
Frame of Reference	Frame of Reference Module	ALWAYS
Equipment	General Equipment Module	ALWAYS
Dose	General Image Module	ALWAYS

Dose	Image Plane Module	ALWAYS
Dose	Multi-Frame Module	ALWAYS
Dose	RT Dose Module	ALWAYS
Dose	SOP Common Module	ALWAYS

Table 72: Patient Module

Attribute Name	Tag	VR	Value	Presence of Value	Source	Comment
Patient's Name	0010,0010	PN		VNAP	COPY, USER	Patient's full legal name, as entered in Launch Pad.
Patient ID	0010,0020	LO		VNAP	COPY, USER	The patient's Medical Record Number, as entered in Launch Pad.
Patient's Birth Date	0010,0030	DA		VNAP	COPY, USER	The patient's Birth date, as entered in Launch Pad.
Patient's Sex	0010,0040	CS	M, F, or O	VNAP	COPY, USER	As appropriate based on Launch Pad entry.

Table 73: General Study Module

Attribute Name	Tag	VR	Value	Presence of Value	Source	Comment
Study Date	0008,0020	DA		VNAP	COPY	Copied from the Primary Image set, if transferred via DICOM.
Study Time	0008,0030	TM		VNAP	COPY	Copied from the Primary Image set, if transferred via DICOM.
Accession Number	0008,0050	SH		VNAP	COPY	Copied from the Primary Image set, if transferred via DICOM.
Referring Physician's Name	0008,0090	PN		VNAP	COPY	Copied from the Primary Image set, if transferred via DICOM.
Study Description	0008,1030	LO		ANAPCV	COPY, USER	Comment as entered in Launch Pad.
Physician of Record	0008,1048	PN		ANAPCV	COPY, USER	Physician as entered in Launch Pad.
Referenced Study Sequence	0008,1110	SQ		ANAPCV	COPY	
>Referenced SOP Class UID	0008,1150	UI	1.2.840.10008.3.1.2.3.2	ANAP	AUTO	
>Referenced SOP Instance UID	0008,1155	UI		ANAP	AUTO	
Study Instance UID	0020,000D	UI		ALWAYS	AUTO, COPY	Copied from the Primary Image set, if transferred via DICOM, else it is generated.
Study ID	0020,0010	SH		VNAP	COPY	Copied from the Primary Image set, if transferred via DICOM.

Table 74: RT Series Module

Attribute Name	Tag	VR	Value	Presence of Value	Source	Comment
Modality	0008,0060	CS	RTDOSE	ALWAYS	COPY	
Series Description	0008,103E	LO		ANAPCV	COPY, USER	Series Description from DICOM Export Window.
Series Instance UID	0020,000E	UI		ALWAYS	AUTO	Generated.
Series Number	0020,0011	IS		VNAP	AUTO, COPY	Series Number from DICOM Export Window.

Table 75: Frame of Reference Module

Attribute Name	Tag	VR	Value	Presence of Value	Source	Comment
Frame of Reference UID	0020,0052	UI		ALWAYS	AUTO	Matches the Frame of Reference UID for the primary image set if the patient position has not been altered on import.
Position Reference Indicator	0020,1040	LO		VNAP	COPY	

Table 76: General Equipment Module

Attribute Name	Tag	VR	Value	Presence of Value	Source	Comment
Manufacturer	0008,0070	LO	ADAC	VNAP	AUTO, COPY	
Station Name	0008,1010	SH		ANAPCV	CONFIG, COPY	The host name of the workstation which transmits the data.
Manufacturer's Model Name	0008,1090	LO	Pinnacle <sup>3</sup>	ANAPCV	AUTO, COPY	
Software Version(s)	0018,1020	LO		ANAPCV	FIXED	Current version of Pinnacle <sup>3</sup> which transmits the data.

Table 77: General Image Module

Attribute Name	Tag	VR	Value	Presence of Value	Source	Comment
Content Date	0008,0023	DA		ANAPCV	AUTO	Date the transfer was performed.
Content Time	0008,0033	TM		ANAPCV	AUTO	Time the transfer was performed.
Instance Number	0020,0013	IS		VNAP	AUTO	A unique number for each IOD instance sent in a single transfer operation.

Table 78: Image Plane Module

Attribute Name	Tag	VR	Value	Presence of Value	Source	Comment
Slice Thickness	0018,0050	DS		VNAP	AUTO	The spacing, in mm, between slices of the dose grid planes.
Image Position (Patient)	0020,0032	DS		ALWAYS	AUTO	The x, y, and z coordinates of the upper left hand corner (center of the first voxel transmitted) of the image, in mm.
Image Orientation (Patient)	0020,0037	DS		ALWAYS	AUTO	The direction cosines of the first row and the first column with respect to the patient. Matches the orientation of the Primary Image Set.
Pixel Spacing	0028,0030	DS		ALWAYS	AUTO	Physical distance in the patient between the center of each voxel, specified by a numeric pair - adjacent row spacing (delimiter) adjacent column spacing in mm.

Table 79: Image Pixel Module

Attribute Name	Tag	VR	Value	Presence of Value	Source	Comment
Samples per Pixel	0028,0002	US	1	ALWAYS	AUTO, COPY	
Photometric Interpretation	0028,0004	CS	MONOCHROME2	ALWAYS	COPY	



Rows	0028,0010	US		ALWAYS	AUTO, COPY	Number of rows in the image.
Columns	0028,0011	US		ALWAYS	AUTO, COPY	Number of columns in the image.
Bits Allocated	0028,0100	US	16	ALWAYS	COPY	
Bits Stored	0028,0101	US	16	ALWAYS	COPY	
High Bit	0028,0102	US	15	ALWAYS	COPY	
Pixel Representation	0028,0103	US	0	ALWAYS	COPY	'0' designates unsigned integer

Table 80: Multi-Frame Module

Attribute Name	Tag	VR	Value	Presence of Value	Source	Comment
Number of Frames	0028,0008	IS		ALWAYS	COPY	Number of frames in a Multi-frame Image. See of the DICOM Part3 specification PS3.3 for explanation.
Frame Increment Pointer	0028,0009	AT		ALWAYS	FIXED, COPY	Contains the Data Element Tag of the attribute that is used as the frame increment in Multi-frame pixel data. Points to Grid Frame Offset Vector (300C,0004). See C.7.6.6.1.1 for further explanation.

Table 81: RT Dose Module

Attribute Name	Tag	VR	Value	Presence of Value	Source	Comment
Dose Units	3004,0002	CS	GY	ALWAYS	COPY	Units used to describe dose: 'GY' (Gray)
Dose Type	3004,0004	CS	PHYSICAL	ALWAYS	COPY	PHYSICAL (physical dose)
Normalization Point	3004,0008	DS		ANAPCV	AUTO	If specified for the plan, the position of the dose normalization point in the patient coordinates system.
Dose Summation Type	3004,000A	CS	PLAN, FRACTION, BEAM, or CONTROL_POINT	ALWAYS	AUTO, COPY	PLAN = dose calculated for the entire trial. FRACTION = dose calculated for a selected prescription. BEAM = dose calculated for one or more beams in each selected prescription. CONTROL_POINT = dose calculated for one or more control points for each beam in the selected prescription. BRACHY and MULTI_PLAN are not supported.
Grid Frame Offset Vector	3004,000C	DS		ANAP	AUTO	An array which contains the z coordinates (in mm) of the image frames in a multi-frame dose. All coordinates are relative to Image Position (Patient) (0020,0032).

Dose Grid Scaling	3004,000E	DS		ALWAYS	AUTO	Scaling factor that when multiplied by the dose grid data found in the Pixel Data (7FE0,0010) attribute of the Image Pixel Module, yields grid doses in the dose units as specified by Dose Units (3004,0002).
Tissue Heterogeneity Correction	3004,0014	CS	IMAGE, ROI_OVERRIDE, or WATER	ANAPCV	AUTO	IMAGE = image data. ROI_OVERRIDE = one or more ROI densities override image or water values where they exist. WATER = entire volume treated as water equivalent.
Referenced RT Plan Sequence	300C,0002	SQ		ANAP	COPY	Introduces sequence of one Class/Instance pair describing the RT Plan associated with the dose.
>Referenced SOP Class UID	0008,1150	UI	1.2.840.10008.5.1.4.1.1.481.5	ANAP	AUTO	RT Plan Storage
>Referenced SOP Instance UID	0008,1155	UI		ANAP	AUTO	Unique identifier of the referenced RT Plan SOP Instance.
Pixel Data	7FE0,0010	OW/ OB		ALWAYS	COPY	Pixel data.

Table 82: SOP Common Module

Attribute Name	Tag	VR	Value	Presence of Value	Source	Comment
Specific Character Set	0008,0005	CS	ISO_IR 100	ANAP	AUTO, COPY	
Instance Creation Date	0008,0012	DA		ANAPCV	AUTO	The date the message was created.
Instance Creation Time	0008,0013	TM		ANAPCV	AUTO	The time the message was created.
SOP Class UID	0008,0016	UI	1.2.840.10008.5.1.4.1.1.481.2	ALWAYS	COPY	
SOP Instance UID	0008,0018	UI		ALWAYS	AUTO	Generated.

#### 8.1.1.5. RT Structure Set Storage SOP Class

Table 83: IOD of Created RT Structure Set Storage SOP Class Instances

Information Entity	Module	Presence Of Module
Patient	Patient Module	ALWAYS
Study	General Study Module	ALWAYS
Series	RT Series Module	ALWAYS
Equipment	General Equipment Module	ALWAYS
Structure Set	Structure Set Module	ALWAYS
Structure Set	ROI Contour Module	ALWAYS
Structure Set	RT ROI Observations Module	ALWAYS
Structure Set	SOP Common Module	ALWAYS

Table 84: Patient Module

Attribute Name	Tag	VR	Value	Presence of Value	Source	Comment
Patient's Name	0010,0010	PN		VNAP	COPY, USER	Patient's full legal name, as entered in Launch Pad.
Patient ID	0010,0020	LO		VNAP	COPY, USER	The patient's Medical Record Number, as entered in Launch Pad.
Patient's Birth Date	0010,0030	DA		VNAP	COPY, USER	The patient's Birth date, as entered in Launch Pad.
Patient's Sex	0010,0040	CS	M, F, or O	VNAP	COPY, USER	Based on Launch Pad entry.

Table 85: General Study Module

Attribute Name	Tag	VR	Value	Presence of Value	Source	Comment
Study Date	0008,0020	DA		VNAP	COPY	Copied from the dataset the structures are assigned to, if transferred via DICOM.
Study Time	0008,0030	TM		VNAP	COPY	Copied from the dataset the structures are assigned to, if transferred via DICOM.
Accession Number	0008,0050	SH		VNAP	COPY	Copied from the dataset the structures are assigned to, if transferred via DICOM.
Referring Physician's Name	0008,0090	PN		VNAP	COPY	Copied from the dataset the structures are assigned to, if transferred via DICOM.
Study Description	0008,1030	LO		ANAPCV	COPY, USER	Comment as entered in Launch Pad.
Physician of Record	0008,1048	PN		ANAPCV	COPY, USER	Physician as entered in Launch Pad.
Referenced Study Sequence	0008,1110	SQ		ANAPCV	COPY	
>Referenced SOP Class UID	0008,1150	UI	1.2.840.10008.3.1.2.3.2	ANAP	AUTO	
>Referenced SOP Instance UID	0008,1155	UI		ANAP	AUTO	Study UID of the data set from which this image was defined.
Study Instance UID	0020,000D	UI		ALWAYS	AUTO, COPY	Copied from the dataset the structures are assigned to, if transferred via DICOM, else it is generated.
Study ID	0020,0010	SH		VNAP	COPY	Copied from the dataset the structures are assigned to, if transferred via DICOM.

Table 86: RT Series Module

Attribute Name	Tag	VR	Value	Presence of Value	Source	Comment
Modality	0008,0060	CS	RTSTRUCT	ALWAYS	COPY	
Series Description	0008,103E	LO		ANAPCV	COPY, USER	Series Description from the DICOM Export Window.
Series Instance UID	0020,000E	UI		ALWAYS	AUTO	Generated.
Series Number	0020,0011	IS		VNAP	AUTO, COPY	Series Number from the DICOM Export Window.

Table 87: General Equipment Module

Attribute Name	Tag	VR	Value	Presence of Value	Source	Comment
Manufacturer	0008,0070	LO	ADAC	VNAP	AUTO, COPY	
Station Name	0008,1010	SH		ANAPCV	CONFIG, COPY	The host name of the workstation which transmits the data.
Manufacturer's Model Name	0008,1090	LO	Pinnacle <sup>3</sup>	ANAPCV	AUTO, COPY	
Software Version(s)	0018,1020	LO		ANAPCV	FIXED	Current version of Pinnacle <sup>3</sup> which transmits the data.

Table 88: Structure Set Module

Attribute Name	Tag	VR	Value	Presence of Value	Source	Comment
Structure Set Label	3006,0002	SH		ALWAYS	AUTO	The name of the plan.
Structure Set Name	3006,0004	LO	POIandROIandBolus	ANAPCV	FIXED	
Structure Set Date	3006,0008	DA		VNAP	AUTO	Date of transfer
Structure Set Time	3006,0009	TM		VNAP	AUTO	Time of transfer.
Referenced Frame of Reference Sequence	3006,0010	SQ		ANAPCV	AUTO	Introduces the sequence describing the frame of reference for the data set.
>Frame of Reference UID	0020,0052	UI		ANAP	AUTO	Duplicated from the image data set the structure is assigned to, as transferred via DICOM.
>RT Referenced Study Sequence	3006,0012	SQ		ANAPCV	AUTO	Introduces the sequence describing studies referenced by this structure set.
>>RT Referenced Series Sequence	3006,0014	SQ		ANAP	AUTO	Introduces the sequence describing the series referenced by this structure set.
>>>Series Instance UID	0020,000E	UI		ANAP	AUTO	The Series UID duplicated from the image data set as transferred via DICOM.
>>>Contour Image Sequence	3006,0016	SQ		ANAP	AUTO	Introduces the list of Image Class and Instance UIDs within the data set series. There will be 1 entry per slice.
>>>>Referenced SOP Class UID	0008,1150	UI		ANAP	AUTO	The Image Class UID duplicated from the image data set as transferred via DICOM.
>>>>Referenced SOP Instance UID	0008,1155	UI		ANAP	AUTO	The instance UID duplicated from the image instance for the contour as transferred via DICOM.
>>Referenced SOP Class UID	0008,1150	UI	1.2.840.10008.3.1.2.3.2	ANAP	AUTO	
>>Referenced SOP Instance UID	0008,1155	UI		ANAP	AUTO	The Study UID duplicated from the image data set as transferred via DICOM.
Structure Set ROI Sequence	3006,0020	SQ		ANAPCV	AUTO	Introduces the sequence of structures. One entry per ROI or POI.
>ROI Number	3006,0022	IS		ANAP	AUTO	A unique number for POIs and ROIs within the message.
>Referenced Frame of Reference UID	3006,0024	UI		ANAP	AUTO	The Frame of Reference UID for each instance UID, duplicated from the image.
>ROI Name	3006,0026	LO		ANAPCV	AUTO	The name of the ROI or POI as entered in Pinnacle <sup>3</sup>
>ROI Volume	3006,002C	DS		ANAPCV	AUTO	The volume of the ROI in cubic cm.
>ROI Generation Algorithm	3006,0036	CS	SEMIAUTOMATIC	ANAPCV	FIXED	

Table 89: ROI Contour Module

Attribute Name	Tag	VR	Value	Presence of Value	Source	Comment
ROI Contour Sequence	3006,0039	SQ		ALWAYS	AUTO	Introduces the sequence of Contour Sequences defining ROIs or POIs.
>ROI Display Color	3006,002A	IS		ANAPCV	AUTO	The color of the ROI.
>Contour Sequence	3006,0040	SQ		ANAPCV	AUTO	Introduces the sequence of Contours defining an ROI.
>>Contour Image Sequence	3006,0016	SQ		ANAPCV	AUTO	Introduces the sequence of image UIDs to which this contour corresponds. The sequence will contain 1 item.
>>>Referenced SOP Class UID	0008,1150	UI		ANAP	AUTO	Image class UID duplicated from the DICOM transfer of the assigned data set. Requires that the image data set has been transferred via DICOM.
>>>Referenced SOP Instance UID	0008,1155	UI		ANAP	AUTO	Image instance UID duplicated from the DICOM transfer of the data set. Requires that the image data set has been transferred via DICOM.
>>Contour Geometric Type	3006,0042	CS	POI or CLOSED_PLANAR	ANAP	AUTO	For POIs: POINT. For ROIs: CLOSED_PLANAR.
>>Number of Contour Points	3006,0046	IS		ANAP	AUTO	1 for a POI; otherwise, the number of points describing the contour in the Contour Data attribute (3006,0050).
>>Contour Data	3006,0050	DS		ANAP	AUTO	The (x, y, z) triplets describing the vertices of the ROI or point of the POI.
>Referenced ROI Number	3006,0084	IS		ALWAYS	AUTO	Unique identifier of POI or ROI within this message instance.

Table 90: RT ROI Observations Module

Attribute Name	Tag	VR	Value	Presence of Value	Source	Comment
RT ROI Observations Sequence	3006,0080	SQ		ALWAYS	AUTO	Introduces a sequence of ROI observations. 1 per beam.
>Observation Number	3006,0082	IS		ALWAYS	AUTO	Unique identifier of POI or ROI within this message instance.
>Referenced ROI Number	3006,0084	IS		ALWAYS	AUTO	Unique identifier of POI or ROI within this message instance.
>RT ROI Interpreted Type	3006,00A4	CS	EXTERNAL, PTV, CTV, GTV, TREATED_VOLUME, IRRAD_VOLUME, AVOIDANCE, ORGAN, CAVITY, SUPPORT, FIXATION, DOSE_REGION, CONTROL, BOLUS or MARKER	VNAP	AUTO	Type of ROI or POI.
>ROI Interpreter	3006,00A6	PN		VNAP	COPY	Empty

Table 91: SOP Common Module

Attribute Name	Tag	VR	Value	Presence of Value	Source	Comment
Specific Character Set	0008,0005	CS	ISO_IR 100	ANAP	AUTO, COPY	

Instance Creation Date	0008,0012	DA		ANAPCV	AUTO	The date the message was created.
Instance Creation Time	0008,0013	TM		ANAPCV	AUTO	The time the message was created.
SOP Class UID	0008,0016	UI	1.2.840.10008.5.1.4.1.1.481.3	ALWAYS	COPY	
SOP Instance UID	0008,0018	UI		ALWAYS	AUTO	Generated.

### 8.1.1.6. RT Plan Storage SOP Class

**Table 92: IOD of Created RT Plan Storage SOP Class Instances**

Information Entity	Module	Presence Of Module
Patient	Patient Module	ALWAYS
Study	General Study Module	ALWAYS
Series	RT Series Module	ALWAYS
Frame of Reference	Frame of Reference Module	ALWAYS
Equipment	General Equipment Module	ALWAYS
Plan	RT General Plan Module	ALWAYS
Plan	RT Tolerance Tables Module	ALWAYS
Plan	RT Patient Setup Module	ALWAYS
Plan	RT Fraction Scheme Module	ALWAYS
Plan	RT Beams Module	ALWAYS
Plan	SOP Common Module	ALWAYS
	Extended Dicom and Private attributes (Refer section 8.5)	ALWAYS

**Table 93: Patient Module**

Attribute Name	Tag	VR	Value	Presence of Value	Source	Comment
Patient's Name	0010,0010	PN		VNAP	COPY, USER	Patient's full legal name, as entered in Launch Pad.
Patient ID	0010,0020	LO		VNAP	COPY, USER	The patient's Medical Record Number, as entered in Launch Pad.
Patient's Birth Date	0010,0030	DA		VNAP	COPY, USER	The patient's Birth date, as entered in Launch Pad.
Patient's Sex	0010,0040	CS	M, F, or O	VNAP	COPY, USER	As appropriate based on Launch Pad entry.

\*This date will be in yyyyymmdd format. If entered or imported in yyyy-mm-dd format, the date will be converted automatically upon export. Other date formats will not be exported.

**Table 94: General Study Module**

Attribute Name	Tag	VR	Value	Presence of Value	Source	Comment
Study Date	0008,0020	DA		VNAP	COPY	Copied from the Primary Image set, if transferred via DICOM.
Study Time	0008,0030	TM		VNAP	COPY	Copied from the Primary Image set, if transferred via DICOM.
Accession Number	0008,0050	SH		VNAP	COPY	Copied from the Primary Image set, if transferred via DICOM.
Referring Physician's Name	0008,0090	PN		VNAP	COPY	Copied from the Primary Image set, if transferred via DICOM.

Study Description	0008,1030	LO		ANAPCV	COPY, USER	Comment as entered in Launch Pad.
Physician of Record	0008,1048	PN		ANAPCV	COPY, USER	Physician as entered in Launch Pad.
Referenced Study Sequence	0008,1110	SQ		ANAPCV	COPY	
>Referenced SOP Class UID	0008,1150	UI	1.2.840.10008.3.1.2.3.2	ANAP	AUTO	
>Referenced SOP Instance UID	0008,1155	UI		ANAP	AUTO	Study UID of the data set from which this image was defined.
Study Instance UID	0020,000D	UI		ALWAYS	AUTO, COPY	Generated.
Study ID	0020,0010	SH		VNAP	COPY	Copied from the Primary Image set, if transferred via DICOM.

Table 95: RT Series Module

Attribute Name	Tag	VR	Value	Presence of Value	Source	Comment
Modality	0008,0060	CS	RTPLAN	ALWAYS	COPY	
Series Description	0008,103E	LO		ANAPCV	COPY, USER	Series Description from DICOM Export Window.
Series Instance UID	0020,000E	UI		ALWAYS	AUTO	Generated.
Series Number	0020,0011	IS		VNAP	AUTO, COPY	Series Number from DICOM Export Window.

Table 96: Frame of Reference Module

Attribute Name	Tag	VR	Value	Presence of Value	Source	Comment
Frame of Reference UID	0020,0052	UI		ALWAYS	AUTO	
Position Reference Indicator	0020,1040	LO		VNAP	AUTO	

Table 97: General Equipment Module

Attribute Name	Tag	VR	Value	Presence of Value	Source	Comment
Manufacturer	0008,0070	LO	ADAC	VNAP	AUTO, COPY	
Station Name	0008,1010	SH		ANAPCV	CONFIG, COPY	The host name of the workstation which transmits the data.
Manufacturer's Model Name	0008,1090	LO	Pinnacle <sup>3</sup>	ANAPCV	AUTO, COPY	
Software Version(s)	0018,1020	LO		ANAPCV	FIXED	Current version of Pinnacle <sup>3</sup> which transmits the data.

Table 98: RT General Plan Module

Attribute Name	Tag	VR	Value	Presence of Value	Source	Comment
Operators' Name	0008,1070	PN		VNAP	AUTO, USER	The Dosimetrist name as entered in Launch Pad.
RT Plan Label	300A,0002	SH		ALWAYS	AUTO, USER	The plan name as entered in Launch Pad concatenated with the Trial Number (i.e., <planName>-<Trial#>).
RT Plan Name	300A,0003	LO		ANAPCV	AUTO, USER	The plan name as entered in Launch Pad.

RT Plan Description	300A,0004	ST		ANAPCV	AUTO, USER	The comment as entered in Launch Pad.
RT Plan Date	300A,0006	DA		VNAP	AUTO	The date that the message was created.
RT Plan Time	300A,0007	TM		VNAP	AUTO	The time that the message was created.
RT Plan Geometry	300A,000C	CS		ALWAYS	AUTO	Set to PATIENT if the primary data set coordinate system is valid and Structure Sets are being exported with the plan. Else the value is TREATMENT_DEVICE. Note: The coordinate system is considered valid if it's a valid DICOM format (not Pinnacle format), and the dataset has not been modified in the Volume Editor.
Referenced Structure Set Sequence	300C,0060	SQ		ANAP	AUTO	Sent if RT Plan Geometry is PATIENT.
>Referenced SOP Class UID	0008,1150	UI	1.2.840.10008.5.1.4.1.1.481.3	ANAP	AUTO	
>Referenced SOP Instance UID	0008,1155	UI		ANAP	AUTO	Indicates the structure set that references the patient's coordinate system frame of reference.

Table 99: RT Tolerance Tables Module

Attribute Name	Tag	VR	Value	Presence of Value	Source	Comment
Tolerance Table Sequence	300A,0040	SQ		ANAPCV	AUTO	Introduces sequence of tolerance tables to be used for delivery of treatment plan. One or more items may be included in sequence.
>Tolerance Table Number	300A,0042	IS		ANAP	AUTO	Identification number of the Tolerance Table as defined in the physics machine. The value of Tolerance Table Number (300A,0042) shall be unique within the RT Plan in which it is created. Required if Tolerance Table Sequence (300A,0040) is sent.
>Tolerance Table Label	300A,0043	SH		ANAPCV	AUTO	User-defined label for Tolerance Table. Defined as part of the tolerance table in the physics machine.

Table 100: RT Patient Setup Module

Attribute Name	Tag	VR	Value	Presence of Value	Source	Comment
Patient Setup Sequence	300A,0180	SQ		ALWAYS	COPY	Introduces the sequence of patient setup data.
>Patient Position	0018,5100	CS		ANAP	COPY	'The treatment position defined by the CT scan. Duplicated from the Primary data set on which the plan was created.
>Patient Setup Number	300A,0182	IS	'1'	ALWAYS	FIXED	



Table 101: RT Fraction Scheme Module\*

Attribute Name	Tag	VR	Value	Presence of Value	Source	Comment
Fraction Group Sequence	300A,0070	SQ		ALWAYS	AUTO, COPY	Introduces sequence of Fraction Groups in current Fraction Scheme. Each Fraction Group is translated to a Prescription in Pinnacle <sup>3</sup> .
>Fraction Group Number	300A,0071	IS		ALWAYS	AUTO, COPY	Prescription number in Pinnacle.
>Number of Fractions Planned	300A,0078	IS		VNAP	AUTO, COPY	The number of fractions for the selected prescription.
>Number of Beams	300A,0080	IS		ALWAYS	AUTO, COPY	The number of beams using this prescription. The number will include 2 additional beams if setup beams are being exported.
>Number of Brachy Application Setups	300A,00A0	IS	0	ALWAYS	FIXED	
>Referenced Beam Sequence	300C,0004	SQ		ANAP	AUTO, COPY	Introduces the sequence of treatment beams in the current Fraction Group.
>>Beam Dose Specification Point	300A,0082	DS		ANAPCV	AUTO, COPY	The location of the Dose Reference Point for the beam, as specified in the Monitor Units window.
>>Beam Dose	300A,0084	DS		ANAPCV	AUTO, COPY	The dose in Gy, to the reference point, calculated for this beam. This will be a value of '0' for setup beams.
>>Beam Meterset	300A,0086	DS		ANAPCV	AUTO, COPY	The monitor units calculated for this beam. This will be a value of '0' for setup beams.
>>Referenced Beam Number	300C,0006	IS		ANAP	AUTO, COPY	Specifies the Beam Number (300A,00C0) of the beam using this prescription.

\*Attributes related to brachytherapy treatments are not supported

Table 102: RT Beams Module

Attribute Name	Tag	VR	Value	Presence of Value	Source	Comment
Beam Sequence	300A,00B0	SQ		ALWAYS	AUTO	Introduces the sequence of treatment beams for this RT Plan. There will be 1 entry per beam.
>Manufacturer	0008,0070	LO		ANAPCV	AUTO	The manufacturer of the machine assigned to this beam.
>Institution Name	0008,0080	LO		ANAPCV	AUTO	The name of the institution in Pinnacle <sup>3</sup> .
>Treatment Machine Name	300A,00B2	SH		VNAP	AUTO	The name of the machine assigned to this beam.
>Primary Dosimeter Unit	300A,00B3	CS	MU	ANAPCV	AUTO	
>Source-Axis Distance	300A,00B4	DS		ANAPCV	AUTO	The SAD of the machine assigned to this beam in mm.
>Beam Limiting Device Sequence	300A,00B6	SQ		ALWAYS	AUTO	Introduces the sequence of beam limiting devices (collimator) jaw or leaf (element) sets.

>>RT Beam Limiting Device Type	300A,00B8	CS		ALWAYS	AUTO	As appropriate: X = symmetric jaw pair in X direction Y = symmetric jaw pair in Y direction ASYMX = asymmetric jaw pair in X direction ASYMY = asymmetric jaw pair in Y direction MLCX = multileaf jaw pair in X direction MLCY = multileaf jaw pair in Y direction.
>>Source to Beam Limiting Device Distance	300A,00BA	DS		ANAPCV	AUTO	The Source to Beam Limiting Device distance in mm. As entered for the device in the machine definition. (Note that this is suppressible via script. See our latest DICOM RT Release Note for more detail.)
>>Number of Leaf/Jaw Pairs	300A,00BC	IS		ALWAYS	AUTO	1 for jaws or the number of leaf pairs for an MLC.
>>Leaf Position Boundaries	300A,00BE	DS		ANAPCV	AUTO	The position of the edges of the leaf boundaries with respect to the central axis. There will be the number of leaf pairs + 1 entries.
>Beam Number	300A,00C0	IS		ALWAYS	AUTO	The ordinal representing the position of the beam in the beam list as displayed in Pinnacle <sup>3</sup> .
>Beam Name	300A,00C2	LO		ANAPCV	AUTO	If the Field ID is specified for the beam, its value is exported in this attribute and the Pinnacle <sup>3</sup> Beam Name is exported in the Beam Description attribute (300A,00C3). If the Field ID is not specified this attribute contains the name of the beam as specified in Pinnacle <sup>3</sup> .
>Beam Description	300A,00C3	ST		ANAPCV	AUTO	If Field ID is specified for the beam, this attribute contains the Pinnacle <sup>3</sup> Beam Name.
>Beam Type	300A,00C4	CS	STATIC or DYNAMIC	ALWAYS	AUTO	'DYNAMIC' for a beam in which treatment geometry or characteristics are modified during delivery. 'STATIC' for a fixed field, fixed beam. (Note that there is a method to override this field. See our latest DICOM RT Release Note for more detail.)
>Radiation Type	300A,00C6	CS	PHOTON or ELECTRON	VNAP	AUTO, FIXED	
>Primary Fluence Mode Sequence	3002,0050	SQ		ANAP	AUTO	Only a single item shall be exported in this sequence.  If the beam's energy is commissioned as "FFF", this sequence shall be sent.
>>Fluence Mode	3002,0051	CS	NON_STANDARD	ANAPCV	AUTO	
>>Fluence Mode ID	3002,0052	SH	FFF	ANAPCV	AUTO	
>Referenced Patient Setup Number	300C,006A	IS		ANAPCV	AUTO, COPY	References the Patient Setup number (300A,0182) as defined in the Patient Setup Module.

>High-Dose Technique Type	300A,00C7	CS	SRS	ANAP	FIXED	For photon and stereo beams if the computed MU value of a beam exceeds the MU threshold specified in the High-Dose Technique configuration of the treatment machine the attribute is set to "SRS" and is exported with the beam module of the RT plan. The attribute will not be exported when the MU value does not exceed the threshold.
>Treatment Delivery Type	300A,00CE	CS	TREATMENT or SETUP	ANAPCV	AUTO	
>Number of Wedges	300A,00D0	IS	0 or 1	ALWAYS	AUTO	
>Wedge Sequence	300A,00D1	SQ		ANAP	AUTO	Introduces sequence of treatment wedges. Required if Number of Wedges is non-zero.
>>Wedge Number	300A,00D2	IS	0	ANAP	FIXED	
>>Wedge Type	300A,00D3	CS	STANDARD, DYNAMIC, or MOTORIZED	ANAPCV	AUTO	As appropriate: STANDARD = standard (static) wedge DYNAMIC = moving beam limiting device jaw simulating wedge MOTORIZED = single wedge that can be removed from beam remotely.
>>Wedge ID	300A,00D4	SH		ANAPCV	AUTO	The Manufacturer code of the wedge assigned to the beam.
>>Wedge Angle	300A,00D5	IS		ANAPCV	AUTO	The angle of the wedge for the beam.
>>Wedge Factor	300A,00D6	DS		ANAPCV	COPY	Empty.
>>Wedge Orientation	300A,00D8	DS		ANAPCV	AUTO	The orientation of the wedge.
>Number of Compensators	300A,00E0	IS	0 or 1	ALWAYS	AUTO	
>Compensator Sequence	300A,00E3	SQ		ANAP	COPY	Compensators are not currently exported by Pinnacle <sup>3</sup> .
>Number of Boli	300A,00ED	IS		ALWAYS	AUTO, FIXED	Number of Boli assigned to beam.
>Number of Blocks	300A,00F0	IS		ALWAYS	AUTO, FIXED	The number of contours required to describe the block.
>Total Block Tray Factor	300A,00F2	DS		ANAPCV	AUTO	The tray factor of the beam.
>Block Sequence	300A,00F4	SQ		ANAP	AUTO	Introduces sequence of blocks associated with Beam. Required if Number of Blocks is non-zero.
>>Material ID	300A,00E1	SH		ANAPCV	COPY	Empty
>>Block Tray ID	300A,00F5	SH		ANAPCV	AUTO	The tray number, if any, otherwise UNKNOWN TRAY ID.
>>Source to Block Tray Distance	300A,00F6	DS		ANAPCV	AUTO	The Source to Tray Distance as defined for the machine.
>>Block Type	300A,00F8	CS	SHIELDING or APERTURE	ANAP	AUTO	
>>Block Divergence	300A,00FA	CS	PRESENT	ANAPCV	FIXED	
>>Block Number	300A,00FC	IS		ANAP	AUTO	The identifying number for this contour.
>>Block Thickness	300A,0100	DS		ANAPCV	COPY	Empty
>>Block Transmission	300A,0102	DS		ANAPCV	AUTO	The block and tray factor of the beam.
>>Block Number of Points	300A,0104	IS		ANAPCV	AUTO	The number of points used to describe the contour.
>>Block Data	300A,0106	DS		ANAPCV	AUTO	Data containing the (x, y) pairs describing the edge of the contour.
>Applicator Sequence	300A,0107	SQ		ANAPCV	AUTO	Introduces the sequence of Applicators. Only a single item shall be permitted in this sequence.

>>Accessory Code	300A,00F9	LO		ANAP	AUTO	If an Accessory Code is provided in the stereo collimator definition of the machine, the Accessory Code is exported in this attribute. If an accessory code is not provided in the Stereo Collimator definition of the machine, this attribute is not exported.
>>Applicator ID	300A,0108	SH		ANAP	AUTO	The user name assigned to the applicator or circular collimator. For a stereo beam, send the name of the circular collimator. For an electron beam, send the electron applicator name.
>>Applicator Type	300A,0109	CS	STEREOTACTIC, ELECTRON_SQUARE, or ELECTRON_RECT	ANAP	AUTO	For a stereo beam, set to 'STEREOTACTIC'. For an electron beam the dimensions of the applicator will be checked, if length = height 'ELECTRON_SQUARE' will be sent. Otherwise 'ELECTRON_RECT'.
>Final Cumulative Meterset Weight	300A,010E	DS	1	ANAP	AUTO	
>Number of Control Points	300A,0110	IS		ALWAYS	AUTO	The number of control points used to describe the beam behavior during treatment. (Setup beams will each use 2 control points.)
>Control Point Sequence	300A,0111	SQ		ALWAYS	AUTO	Introduces the sequence of machine configurations describing this treatment beam.
>>Control Point Index	300A,0112	IS		ANAP	AUTO	Sequentially numbered starting at 0.
>>Nominal Beam Energy	300A,0114	DS		ANAPCV	AUTO	The selected machine energy for this beam.
>>Dose Rate Set	300A,0115	DS		ANAPCV	AUTO	Dose rate of the control point.
>>Wedge Position Sequence	300A,0116	SQ		ANAPCV	AUTO	Introduces sequence of Wedge positions and identities for this control point.
>>>Wedge Position	300A,0118	CS	IN or OUT	ANAP	FIXED	
>>>Referenced Wedge Number	300C,00C0	IS		ANAP	AUTO, COPY	The Wedge Number (300A,00D2) assigned to the selected wedge for this control point.
>>Beam Limiting Device Position Sequence	300A,011A	SQ		ANAP	AUTO	Introduces the sequence of beam limiting device (collimator) jaw or leaf (element) positions.
>>>RT Beam Limiting Device Type	300A,00B8	CS	See Comment	ANAP	AUTO	Assigned as appropriate: X = symmetric jaw pair in X direction Y = symmetric jaw pair in Y direction ASYMX = asymmetric jaw pair in X direction ASYMY = asymmetric jaw pair in Y direction MLCX = multileaf jaw pair in X direction MLCY = multileaf jaw pair in Y direction.
>>>Leaf/Jaw Positions	300A,011C	DS		ANAP	AUTO	The jaw or MLC leaf positions for this control point in mm.
>>Gantry Angle	300A,011E	DS		ANAP	AUTO	The gantry angle of the beam for this control point. Control point zero will always represent the starting angle for the beam.

>>Gantry Rotation Direction	300A,011F	CS	CW, CC, or NONE	ANAP	AUTO	If an arc is being described, this will represent the direction of the gantry rotation ('CW' or 'CC'). If this is a fixed treatment the value will be 'NONE'.
>>Beam Limiting Device Angle	300A,0120	DS		ANAP	AUTO	The collimator angle for the beam.
>>Beam Limiting Device Rotation Direction	300A,0121	CS	NONE	ANAP	FIXED	
>>Patient Support Angle	300A,0122	DS		ANAP	AUTO	The couch angle for the beam.
>>Patient Support Rotation Direction	300A,0123	CS	NONE	ANAP	FIXED	
>>Table Top Eccentric Angle	300A,0125	DS	0	ANAP	FIXED	
>>Table Top Eccentric Rotation Direction	300A,0126	CS	NONE	ANAP	FIXED	
>>Table Top Vertical Position	300A,0128	DS		ANAPCV	COPY	Empty
>>Table Top Longitudinal Position	300A,0129	DS		ANAPCV	COPY	Empty
>>Table Top Lateral Position	300A,012A	DS		ANAPCV	COPY	Empty
>>Isocenter Position	300A,012C	DS	'PATIENT' or empty	ANAPCV	AUTO	Sent in mm in the DICOM Patient coordinate system, if RT Plan Geometry (300A, 000C) is PATIENT. Empty, if RT Plan Geometry is TREATMENT_DEVICE.
>>Source to Surface Distance	300A,0130	DS		ANAPCV	AUTO	SSD of the beam in mm.
>>Cumulative Meterset Weight	300A,0134	DS		ANAPCV	AUTO	For control point 0, this is 0.0. For each subsequent control point this represents the weight of the MU delivered during this control point, expressed as a percentage. The final value will be 1.
>Referenced Tolerance Table Number	300C,00A0	IS		ANAPCV	AUTO	The number associated with the Tolerance Table in the DICOM Export Window as defined in your physics machine.
>Referenced Bolus Sequence	300C,00B0	SQ		ANAP	AUTO	Introduces the sequence of boluses associated with the beam.
>>Referenced ROI Number	3006,0084	IS		ANAP	AUTO	Indicates that bolus is specified for the beam.

Table 103: SOP Common Module

Attribute Name	Tag	VR	Value	Presence of Value	Source	Comment
Specific Character Set	0008,0005	CS	ISO_IR 100	ANAP	AUTO, COPY	
Instance Creation Date	0008,0012	DA		ANAPCV	AUTO	The date the message was created.
Instance Creation Time	0008,0013	TM		ANAPCV	AUTO	The time the message was created.
SOP Class UID	0008,0016	UI	1.2.840.10008.5.1.4.1.1.481.5	ALWAYS	COPY	
SOP Instance UID	0008,0018	UI		ALWAYS	AUTO	Generated.

## 8.1.1.7. Spatial Registration Storage

Table 104: IOD of Created Spatial Registration Storage Instances

Information Entity	Module	Presence Of Module
Patient	Patient Module	ALWAYS
Study	General Study Module	ALWAYS
Series	RT Series Module	ALWAYS
Frame of Reference	Frame of Reference Module	ALWAYS
Equipment	General Equipment Module	ALWAYS
Spatial Registration	Spatial Registration Module	ALWAYS
	SOP Common Module	ALWAYS

Table 105: Patient Module

Attribute Name	Tag	VR	Value	Presence of Value	Source	Comment
Patient's Name	0010,0010	PN		VNAP	COPY, USER	Patient's full legal name, as entered in Launch Pad.
Patient ID	0010,0020	LO		VNAP	COPY, USER	The patient's Medical Record Number, as entered in Launch Pad.
Patient's Birth Date	0010,0030	DA		VNAP	COPY, USER	The patient's Birth date, as entered in Launch Pad.
Patient's Sex	0010,0040	CS	M, F, or O	VNAP	COPY, USER	As appropriate based on Launch Pad entry.

\*This date will be in yyyyymmdd format. If entered or imported in yyyy-mm-dd format, the date will be converted automatically upon export. Other date formats will not be exported.

Table 106: General Study Module

Attribute Name	Tag	VR	Value	Presence of Value	Source	Comment
Study Date	0008,0020	DA		VNAP	COPY	Copied from the Primary Image set, if transferred via DICOM.
Study Time	0008,0030	TM		VNAP	COPY	Copied from the Primary Image set, if transferred via DICOM.
Accession Number	0008,0050	SH		VNAP	COPY	Copied from the Primary Image set, if transferred via DICOM.
Referring Physician's Name	0008,0090	PN		VNAP	COPY	Copied from the Primary Image set, if transferred via DICOM.
Study Description	0008,1030	LO		ANAPCV	COPY, USER	Comment as entered in Launch Pad.
Physician of Record	0008,1048	PN		ANAPCV	COPY, USER	Physician as entered in Launch Pad.
Referenced Study Sequence	0008,1110	SQ		ANAPCV	COPY	Introduces the sequence describing the study containing the data set for which this set of ROIs was defined.
>Referenced SOP Class UID	0008,1150	UI	1.2.840.10008.3.1.2.3.2	ANAP	AUTO	
>Referenced SOP Instance UID	0008,1155	UI		ANAP	AUTO	Study UID of the data set from which this image was defined.
Study Instance UID	0020,000D	UI		ALWAYS	AUTO, COPY	Copied from the Primary Image Set, if transferred via DICOM, else it is generated.
Study ID	0020,0010	SH		VNAP	COPY	Copied from the Primary Image set, if transferred via DICOM.

Table 107: RT Series Module

Attribute Name	Tag	VR	Value	Presence of Value	Source	Comment
Modality	0008,0060	CS	REG	ALWAYS	COPY	
Series Description	0008,103E	LO		ANAPCV	COPY, USER	Series Description from the DICOM Export Window.
Series Instance UID	0020,000E	UI		ALWAYS	AUTO	Generated.
Series Number	0020,0011	IS		VNAP	AUTO, COPY	Series Number from the DICOM Export Window.

Table 108: Frame of Reference Module

Attribute Name	Tag	VR	Value	Presence of Value	Source	Comment
Frame of Reference UID	0020,0052	UI		ALWAYS	AUTO	Matches the Frame of Reference UID for the primary image set if the patient position has not been altered on import. If the patient position was altered on import, a new Frame of Reference UID will be generated.
Position Reference Indicator	0020,1040	LO		VNAP	COPY	

Table 109: General Equipment Module

Attribute Name	Tag	VR	Value	Presence of Value	Source	Comment
Manufacturer	0008,0070	LO	ADAC	VNAP	AUTO, COPY	
Station Name	0008,1010	SH		ANAPCV	CONFIG, COPY	The host name of the workstation which transmits the data.
Manufacturer's Model Name	0008,1090	LO	Pinnacle <sup>3</sup>	ANAPCV	AUTO, COPY	
Software Version(s)	0018,1020	LO		ANAPCV	FIXED	Current version of Pinnacle <sup>3</sup> which transmits the data.

Table 110: Spatial Registration Module

Attribute Name	Tag	VR	Value	Presence of Value	Source	Comment
Content Date	0008,0023	DA		ALWAYS	COPY	Copied from Plan.
Content Time	0008,0033	TM		ALWAYS	COPY	Copied from Plan.
Registration Sequence	0070,0308	SQ		ALWAYS	AUTO	Introduces two registration sequences.
>Frame of Reference UID	0020,0052	UI		ANAP	AUTO	Identifies the dataset's Frame of Reference.
>>Referenced SOP Class UID	0008,1150	UI		ALWAYS	AUTO	The SOP Class UID of each image in the dataset.
>>Referenced SOP Instance UID	0008,1155	UI		ALWAYS	AUTO	The SOP Instance UID of each image in the dataset.
>Matrix Registration Sequence	0070,0309	SQ		ALWAYS	AUTO	Introduces a single matrix registration sequence.
>>Frame of Reference Transformation Comment	3006,00C8	DS		EMPTY	COPY	Empty.
>>Registration Type Code Sequence	0070,030D	SQ		VNAP	COPY	Empty.
>>Matrix Sequence	0070,030A	SQ		ALWAYS	AUTO	Introduces a single matrix registration.

>>>Frame of Reference Transformation Matrix	3006,00C6	DS		ALWAYS	AUTO	A 4x4 homogeneous transformation matrix that registers the secondary dataset to the primary dataset. Matrix elements shall be listed in row-major order. The primary dataset must be an identity matrix.
Instance Number	0020,0013	IS	1	ALWAYS	FIXED	
Content Label	0070,0080	CS		ALWAYS	AUTO	Current time/date stamp.

Table 111: SOP Common Module

Attribute Name	Tag	VR	Value	Presence of Value	Source	Comment
Specific Character Set	0008,0005	CS	ISO_IR 100	ANAP	AUTO, COPY	
Instance Creation Date	0008,0012	DA		ANAPCV	AUTO	The date the message was created.
Instance Creation Time	0008,0013	TM		ANAPCV	AUTO	The time the message was created.
SOP Class UID	0008,0016	UI	1.2.840.10008.5.1.4.1.1.66.1	ALWAYS	COPY	
SOP Instance UID	0008,0018	UI		ALWAYS	AUTO	Generated.

### 8.1.1.8. Secondary Capture Image Storage SOP Class

Table 112: IOD of Created Secondary Capture Image Storage SOP Class Instances

Information Entity	Module	Presence Of Module
Patient	Patient Module	ALWAYS
Study	General Study Module	ALWAYS
Series	General Series Module	ALWAYS
Equipment	General Equipment Module	ALWAYS
Equipment	SC Equipment Module	ALWAYS
Image	General Image Module	ALWAYS
Image	VOI LUT Module	ALWAYS
Image	SOP Common Module	ALWAYS

Table 113: Patient Module

Attribute Name	Tag	VR	Value	Presence of Value	Source	Comment
Patient's Name	0010,0010	PN		VNAP	COPY, USER	Patient's full legal name, as entered in Launch Pad.
Patient ID	0010,0020	LO		VNAP	COPY, USER	The patient's Medical Record Number, as entered in Launch Pad.
Patient's Birth Date	0010,0030	DA		VNAP	COPY, USER	The patient's Birth date, as entered in Launch Pad.
Patient's Sex	0010,0040	CS	M, F, or O	VNAP	COPY, USER	As appropriate based on Launch Pad entry.

Table 114: General Study Module

Attribute Name	Tag	VR	Value	Presence of Value	Source	Comment
Study Date	0008,0020	DA		VNAP	COPY	Copied from the Primary Image set, if transferred via DICOM.



Study Time	0008,0030	TM		VNAP	COPY	Copied from the Primary Image set, if transferred via DICOM.
Accession Number	0008,0050	SH		VNAP	COPY	Copied from the Primary Image set, if transferred via DICOM.
Referring Physician's Name	0008,0090	PN		VNAP	COPY	Copied from the Primary Image set, if transferred via DICOM.
Study Description	0008,1030	LO		ANAPCV	COPY, USER	Comment as entered in Launch Pad.
Physician of Record	0008,1048	PN		ANAPCV	COPY, USER	Physician as entered in Launch Pad.
Study Instance UID	0020,000D	UI		ALWAYS	AUTO, COPY	Copied from the Primary Image set, if transferred via DICOM, else it is generated.
Study ID	0020,0010	SH		VNAP	COPY	Copied from the Primary Image set, if transferred via DICOM.

Table 115: General Series Module

Attribute Name	Tag	VR	Value	Presence of Value	Source	Comment
Series Instance UID	0020,000E	UI		ALWAYS	AUTO	Generated on Export.
Series Number	0020,0011	IS		VNAP	COPY	Empty.
Laterality	0020,0060	CS		ANAPCV	COPY	Empty.

Table 116: General Equipment Module

Attribute Name	Tag	VR	Value	Presence of Value	Source	Comment
Manufacturer	0008,0070	LO	ADAC	VNAP	AUTO, COPY	
Station Name	0008,1010	SH		ANAPCV	CONFIG, COPY	The host name of the workstation which transmits the data.
Manufacturer's Model Name	0008,1090	LO	Pinnacle <sup>3</sup>	ANAPCV	AUTO, COPY	
Software Version(s)	0018,1020	LO		ANAPCV	FIXED	Current version of Pinnacle <sup>3</sup> which transmits the data.

Table 117: SC Equipment Module

Attribute Name	Tag	VR	Value	Presence of Value	Source	Comment
Modality	0008,0060	CS	OT	ALWAYS	AUTO	
Conversion Type	0008,0064	CS	WSD	ALWAYS	AUTO	

Table 118: General Image Module

Attribute Name	Tag	VR	Value	Presence of Value	Source	Comment
Content Date	0008,0023	DA		ANAPCV	AUTO	Date the transfer was performed.
Content Time	0008,0033	TM		ANAPCV	AUTO	Time the transfer was performed.
Instance Number	0020,0013	IS	1	VNAP	AUTO	
Patient Orientation	0020,0020	CS		ANAPCV	COPY	Empty.

Table 119: VOI LUT Module

Attribute Name	Tag	VR	Value	Presence of Value	Source	Comment
Window Center	0028,1050	DS		ANAP	AUTO, COPY	The default window center value for the image, for display purposes.
Window Width	0028,1051	DS		ANAP	AUTO, COPY	The default window width value for the image, for display purposes.

Table 120: SOP Common Module

Attribute Name	Tag	VR	Value	Presence of Value	Source	Comment
Specific Character Set	0008,0005	CS	ISO_IR 100	ANAP	AUTO, COPY	
Instance Creation Date	0008,0012	DA		ANAPCV	AUTO	The date the message was created.
Instance Creation Time	0008,0013	TM		ANAPCV	AUTO	The time the message was created.
SOP Class UID	0008,0016	UI	1.2.840.10008.5.1.4.1.1.7	ALWAYS	COPY	
SOP Instance UID	0008,0018	UI		ALWAYS	AUTO	

## 8.1.2. Usage of Attributes from Received IOD

### 8.1.2.1. Usage of the Functionality CT, MR, NM and PET Image Storage IODs

The following table lists the supported SOP Classes which can be used by these applications.

Table 121: Supported SOP Classes for functionality CT, MR, NM and PET Image Storage IODs

SOP Class name	SOP Class UID
CT Image Storage SOP Class	1.2.840.10008.5.1.4.1.1.2
MR Image Storage SOP Class	1.2.840.10008.5.1.4.1.1.4
Nuclear Medicine Image Storage SOP Class	1.2.840.10008.5.1.4.1.1.20
Positron Emission Tomography Image Storage SOP Class	1.2.840.10008.5.1.4.1.1.128

Table 122: Used attributes from CT, MR, NM and PET Image SOP Class Instances

Information Entity	Module	Presence Of Module
Patient	Patient Module	ALWAYS
Study	General Study Module	ALWAYS
Series	General Series Module	ALWAYS
Frame of Reference	Frame of Reference Module	CONDITIONAL
Equipment	General Equipment Module	ALWAYS
Image	General Image Module	ALWAYS
Image	Image Plane Module	ALWAYS
Image	Image Pixel Module	ALWAYS
Image	CT Image Module*	ALWAYS
Image	MR Image Module*	ALWAYS
Image	NM Image Pixel Module*	ALWAYS
Image	NM Reconstruction Module*	CONDITIONAL
Image	PET Image Module*	ALWAYS
	SOP Common Module	CONDITIONAL

**Note:** \* Modules are only present per imaging modality.

Table 123: Supported attributes of functionality CT, MR, NM and PET SOP Class Instances

Attribute Name	Tag	VR	Value	Comment
SOP Instance UID	(0008,0018)	UI		Used in identifying the SOP Instance.
SOP Class UID	(0008,0016)	UI		Used in identifying the SOP class.
Patient's Name	(0010,0010)	PN		Displayed to user.
Patient ID	(0010,0020)	LO		Patient ID. Used in the "Medical Record Number" part of the Patient Demographics feature of AcQSim <sup>3</sup> .
Patient's Birth Date	(0010,0030)	DA		Birth date of the patient. Used in the Patient Demographics feature of AcQSim <sup>3</sup> .
Patient's Sex	(0010,0040)	CS		Displayed to user.
Pixel Spacing	(0028,0030)	DS		Physical distance in the patient between the center of each pixel.
Image Orientation (Patient)	(0020,0037)	DS		Used to find out how the image is stored (how it is reconstructed as compared to the original patient scan orientation). In combination with information from "Patient Position" (0018, 5100) field, this is used to properly import the images in the original orientation of the patient scan.
Slice Location	(0020,1041)	DS		Position of slice relative to an unspecified implementation-specific reference point. Used to represent horizontal couch position in Philips scanners only.
Slice Thickness	(0018,0050)	DS		Nominal slice thickness, in mm.
Image Position (Patient)	(0020,0032)	DS		The x, y, and z coordinates of the upper left corner (center of first voxel transmitted) of the image in mm. Used to properly position each slice in the dataset.
Rows	(0028,0010)	US		Number of rows in the image.
Columns	(0028,0011)	US		Number of columns in the image.
Pixel Representation	(0028,0103)	US		Data representation of the pixel samples.
Pixel Data	(7FE0,0010)	OW/OB		Pixel data.
Study Date	(0008,0020)	DA		Displayed to user. Need to contain same value throughout the study or null.
Study Time	(0008,0030)	TM		Displayed to user. Need to contain same value throughout the study or null.
Referring Physician's Name	(0008,0090)	PN		Patient's referring physician. Used in the Patient Demographics feature of AcQSim <sup>3</sup> .
Study Instance UID	(0020,000D)	UI		Used to associate multiple images into a single Pinnacle <sup>3</sup> data file.
Study Description	(0008,1030)	LO		Study description. Used in the "Comments" field of the Patient Demographics feature of AcQSim <sup>3</sup> .
Patient Position	(0018,5100)	CS	HFS, HFP, HF DL, HFDR, FFS, FFP, FF DL, or FFDR	Used to determine the patient's original position/orientation at the scanner. Although this is a type 2 attribute in DICOM Standards, it is important that this info is provided to be used in Pinnacle <sup>3</sup> .

Series Instance UID	(0020,000E)	UI		Used to associate multiple images into a single Pinnacle <sup>3</sup> data file.
Modality	(0008,0060)	CS		Determine special processing required for interpretation of the image data.
Instance Number	(0020,0013)	IS		Used as slice number. If no value exists or values are the same throughout the dataset, Pinnacle <sup>3</sup> uses its own slice numbering mechanism.
Manufacturer	(0008,0070)	LO		
Pixel Padding Value	(0028,0120)	US/SS		Value of pixels added to non-rectangular image to pad to rectangular format.
Manufacturer's Model Name	(0008,1090)	LO		Manufacturer's model name.
Frame of Reference UID	(0020,0052)	UI		Uniquely identify the Frame of Reference for the series. For CT and MR data must be the same for every image in the series.
Image Type	(0008,0008)	CS		Image identification characteristics.
Table Height	(0018,1130)	DS		Couch height.
Bits Stored	(0028,0101)	US		Number of bits stored for each pixel sample.
Rescale Slope	(0028,1053)	DS		Used to scale data to Hounsfield Units.
Bits Allocated	(0028,0100)	US		Number of bits allocated for each pixel sample.
High Bit	(0028,0102)	US		Most significant bit for pixel sample data. For CT, NM and PT, value is one less than the value in Bits Stored.
Rescale Intercept	(0028,1052)	DS		Used to scale data to appropriate units. Always zero for PET images.
Photometric Interpretation	(0028,0004)	CS	MONOCHROME2	.
Gantry/Detector Tilt	(0018,1120)	DS		If present, must be zero.
Samples per Pixel	(0028,0002)	US	1	
Spacing Between Slices	(0018,0088)	DS		Used to determine the spacing of the slices for rendering.

### 8.1.2.2. Usage of the Functionality RT Structure Set Storage SOP Class

The following table lists the supported SOP Classes which can be used by this application.

**Table 124: Supported SOP Classes for functionality RT Structure Set Storage SOP Class**

SOP Class name	SOP Class UID
RT Structure Set Storage SOP Class	1.2.840.10008.5.1.4.1.1.481.3

**Table 125: Used attributes from RT Structure Set Storage SOP Class Instances**

Information Entity	Module	Presence Of Module
Patient	Patient Module	ALWAYS

Series	RT Series Module	ALWAYS
Equipment	General Equipment Module	ALWAYS
Structure Set	Structure Set Module	ALWAYS
Structure Set	ROI Contour Module	ALWAYS
Structure Set	RT ROI Observations Module	ALWAYS
Structure Set	SOP Common Module	ALWAYS

Table 126: Patient Module

Attribute Name	Tag	VR	Value	Presence of Value	Source	Comment
Patient's Name	0010,0010	PN		VNAP	COPY	Used to verify the patient plan matches with the data. Matched with the patient name as entered in Launch Pad.
Patient ID	0010,0020	LO		VNAP	COPY	Used to verify the patient plan matches with the data. Matched with the medical record number as entered in Launch Pad.
Patient's Birth Date	0010,0030	DA		VNAP	COPY	Not used.
Patient's Sex	0010,0040	CS		VNAP	COPY	Used to verify the patient plan matches with the data.

Table 127: RT Series Module

Attribute Name	Tag	VR	Value	Presence of Value	Source	Comment
Modality	0008,0060	CS	RTSTRUCT	ALWAYS	COPY	
Series Description	0008,103E	LO		ANAPCV	COPY	Not used.
Series Instance UID	0020,000E	UI		ALWAYS	COPY	Written to transfer log.
Series Number	0020,0011	IS		VNAP	COPY	Not used.

Table 128: General Equipment Module

Attribute Name	Tag	VR	Value	Presence of Value	Source	Comment
Manufacturer	0008,0070	LO		VNAP	COPY	Written to transfer log.
Station Name	0008,1010	SH		ANAPCV	COPY	Written to transfer log.
Manufacturer's Model Name	0008,1090	LO		ANAPCV	COPY	Written to transfer log.
Software Version(s)	0018,1020	LO		ANAPCV	COPY	Written to transfer log.

Table 129: Structure Set Module

Attribute Name	Tag	VR	Value	Presence of Value	Source	Comment
Structure Set Label	3006,0002	SH		ALWAYS	COPY	Not used.
Structure Set Name	3006,0004	LO		ANAPCV	COPY	Not used.
Structure Set Date	3006,0008	DA		VNAP	COPY	Not used.
Structure Set Time	3006,0009	TM		VNAP	COPY	Not used.
Referenced Frame of Reference Sequence	3006,0010	SQ		ANAPCV	COPY	Introduces the sequence describing the frame of reference for the data set. Data must have been transferred to Pinnacle <sup>3</sup> via DICOM.
>Frame of Reference UID	0020,0052	UI		ANAP	COPY	Must equal the Frame of Reference UID of the plan data set.

>RT Referenced Study Sequence	3006,0012	SQ		ANAPCV	COPY	Introduces the sequence describing studies referenced by this structure set. In Pinnacle <sup>3</sup> this identifies the data set used by the plan.
>>RT Referenced Series Sequence	3006,0014	SQ		ANAP	COPY	Introduces the sequence describing the series referenced by this structure set. In Pinnacle <sup>3</sup> this identifies the data set.
>>>Series Instance UID	0020,000E	UI		ANAP	COPY	Used to verify that the structure set corresponds to the current plan. If not the discrepancy is logged and the user warned.
>>>Contour Image Sequence	3006,0016	SQ		ANAP	COPY	Introduces the list of Image Class and Instance UIDs within the data set series. May include images that have no contours assigned.
>>>>Referenced SOP Class UID	0008,1150	UI		ANAP	COPY	Used to verify that images used to define contours are of the correct class. If not the discrepancy is logged and the user warned.
>>>>Referenced SOP Instance UID	0008,1155	UI		ANAP	COPY	Used to verify that the image to which the contour is assigned has been transferred to Pinnacle <sup>3</sup> . If not the discrepancy is logged and the user warned.
>>Referenced SOP Class UID	0008,1150	UI		ANAP	COPY	Not used.
>>Referenced SOP Instance UID	0008,1155	UI		ANAP	COPY	Used to verify that the structure set corresponds to the current plan. If not the discrepancy is logged and the user warned.
Structure Set ROI Sequence	3006,0020	SQ		ANAPCV	COPY	Introduces the sequence of structures. One entry per ROI.
>ROI Number	3006,0022	IS		ANAP	COPY	Uniquely identifies an ROI when referenced by an ROI Contour and RT ROI Observations modules.
>Referenced Frame of Reference UID	3006,0024	UI		ANAP	COPY	Must match the Frame of Reference UID for the data set. If not the discrepancy is logged and the user notified.
>ROI Name	3006,0026	LO		ANAPCV	COPY	Used as the ROI or POI name in Pinnacle <sup>3</sup> . If the name is not a valid Pinnacle <sup>3</sup> name or duplicates an existing name, a new unique name will be generated, the action logged, and the user warned.
>ROI Volume	3006,002C	DS		ANAPCV	COPY	Not used.
>ROI Generation Algorithm	3006,0036	CS		ANAPCV	COPY	Not used.

Table 130: ROI Contour Module

Attribute Name	Tag	VR	Value	Presence of Value	Source	Comment
ROI Contour Sequence	3006,0039	SQ		ALWAYS	COPY	Introduces the sequence of Contour Sequences defining ROIs.
>ROI Display Color	3006,002A	IS		ANAPCV	COPY	Used to assign a color to the ROI.
>Contour Sequence	3006,0040	SQ		ANAPCV	COPY	Introduces the sequence of Contours defining an ROI.

>>Contour Image Sequence	3006,0016	SQ		ANAPCV	COPY	Introduces the sequence of image UIDs to which this contour corresponds. The sequence will contain 1 item.
>>>Referenced SOP Class UID	0008,1150	UI		ANAP	COPY	Required that all Class UIDs are the same. If not the discrepancy will be logged.
>>>Referenced SOP Instance UID	0008,1155	UI		ANAP	COPY	If present, and if the contour is transverse, the contour is assigned to the image identified by this UID, ignoring the z coordinate specified in the contour data.
>>Contour Geometric Type	3006,0042	CS	POINT or CLOSED_PLANAR	ANAP	COPY	If POINT, the contour represents a POI. If CLOSED_PLANAR, the contour represents an ROI.
>>Number of Contour Points	3006,0046	IS		ANAP	COPY	The number of points describing the contour in the Contour Data attributes.
>>Contour Data	3006,0050	DS		ANAP	COPY	The (x, y, z) coordinates of the vertices of a single contour in the ROI.
>Referenced ROI Number	3006,0084	IS		ALWAYS	COPY	Used to match the contours with the ROI data in the Structure Set.

Table 131: RT ROI Observations Module

Attribute Name	Tag	VR	Value	Presence of Value	Source	Comment
RT ROI Observations Sequence	3006,0080	SQ		ALWAYS	COPY	Introduces a sequence of ROI observations. 1 per beam.
>Observation Number	3006,0082	IS		ALWAYS	COPY	Not used.
>Referenced ROI Number	3006,0084	IS		ALWAYS	COPY	Not used.
>RT ROI Interpreted Type	3006,00A4	CS	EXTERNAL, PTV, CTV, GTV, TREATED_VOLUME, IRRAD_VOLUME, AVOIDANCE, ORGAN, CAVITY, SUPPORT, FIXATION, DOSE_REGION, CONTROL, BOLUS, or MARKER	VNAP	COPY	Type of ROI or POI.

Table 132: SOP Common Module

Attribute Name	Tag	VR	Value	Presence of Value	Source	Comment
Specific Character Set	0008,0005	CS		ANAP	COPY	
Instance Creation Date	0008,0012	DA		ANAPCV	COPY	
Instance Creation Time	0008,0013	TM		ANAPCV	COPY	
SOP Class UID	0008,0016	UI	1.2.840.10008.5.1.4.1.1.481.3	ALWAYS	COPY	
SOP Instance UID	0008,0018	UI		ALWAYS	COPY	

### 8.1.2.3. Usage of the Functionality RT Plan Storage SOP Class

The following table lists the supported SOP Classes which can be used by this application.

**Table 133: Supported SOP Classes for functionality RT Plan Storage SOP Class**

SOP Class name	SOP Class UID
RT Plan Storage SOP Class	1.2.840.10008.5.1.4.1.1.481.5

**Table 134: Used attributes from RT Plan Storage SOP Class Instances**

Information Entity	Module	Presence Of Module
Patient	Patient Module	ALWAYS
Series	RT Series Module	ALWAYS
Equipment	General Equipment Module	ALWAYS
Plan	RT General Plan Module	ALWAYS
Plan	RT Fraction Scheme Module	ALWAYS
Plan	RT Beams Module	ALWAYS
Plan	SOP Common Module	ALWAYS

**Table 135: Patient Module**

Attribute Name	Tag	VR	Value	Presence of Value	Source	Comment
Patient's Name	0010,0010	PN		VNAP	COPY	Used to verify the patient plan matches with the data. Matched with the patient name as entered in Launch Pad.
Patient ID	0010,0020	LO		VNAP	COPY	Used to verify the patient plan matches with the data. Matched with the medical record number as entered in Launch Pad.
Patient's Birth Date	0010,0030	DA		VNAP	COPY	Not used.
Patient's Sex	0010,0040	CS		VNAP	COPY	Used to verify the patient plan matches with the data.

**Table136: RT Series Module**

Attribute Name	Tag	VR	Value	Presence of Value	Source	Comment
Modality	0008,0060	CS	RTPLAN	ALWAYS	COPY	
Series Description	0008,103E	LO		ANAPCV	COPY	User defined description for this series.
Series Instance UID	0020,000E	UI		ALWAYS	COPY	Written to transfer log.
Series Number	0020,0011	IS		VNAP	COPY	A number that identifies this series.

**Table 137: General Equipment Module**

Attribute Name	Tag	VR	Value	Presence of Value	Source	Comment
Manufacturer	0008,0070	LO		VNAP	COPY	Written to transfer log.
Station Name	0008,1010	SH		ANAPCV	COPY	Written to transfer log.
Manufacturer's Model Name	0008,1090	LO		ANAPCV	COPY	Written to transfer log.
Software Version(s)	0018,1020	LO		ANAPCV	COPY	Written to transfer log.

**Table 138: RT General Plan Module**

Attribute Name	Tag	VR	Value	Presence of Value	Source	Comment
Operators' Name	0008,1070	PN		VNAP	COPY	Not used.
RT Plan Label	300A,0002	SH		ALWAYS	COPY	Not used.
RT Plan Name	300A,0003	LO		ANAPCV	COPY	Not used.



RT Plan Description	300A,0004	ST		ANAPCV	COPY	Not used.
RT Plan Date	300A,0006	DA		VNAP	COPY	Not used.
RT Plan Time	300A,0007	TM		VNAP	COPY	Not used.
RT Plan Geometry	300A,000C	CS		ALWAYS	COPY	Not used.

Table 139: RT Fraction Scheme Module\*

Attribute Name	Tag	VR	Value	Presence of Value	Source	Comment
Fraction Group Sequence	300A,0070	SQ		ALWAYS	COPY	Introduces sequence of Fraction Groups in current Fraction Scheme. Each Fraction Group is translated to a Prescription in Pinnacle <sup>3</sup> .
>Fraction Group Number	300A,0071	IS		ALWAYS	COPY	Identifies the fraction scheme for a beam.
>Number of Fractions Planned	300A,0078	IS		VNAP	COPY	The number of fractions for a prescription.
>Number of Beams	300A,0080	IS		ALWAYS	COPY	Used to verify the consistency of the transmitted plan. If this does not match the actual number of beams using this plan, the discrepancy is logged and the user warned.
>Number of Brachy Application Setups	300A,00A0	IS		ALWAYS	COPY	Not used.
>Referenced Beam Sequence	300C,0004	SQ		ANAP	COPY	Introduces the sequence of treatment beams in the current Fraction Group.
>>Beam Dose	300A,0084	DS		ANAPCV	COPY	Not used.
>>Beam Meterset	300A,0086	DS		ANAPCV	COPY	Not used.
>>Referenced Beam Number	300C,0006	IS		ANAP	COPY	Associates a prescription with a beam.

Note: \* Attributes related to brachytherapy treatments are not supported.

Table 140: RT Beams Module

Attribute Name	Tag	VR	Value	Presence of Value	Source	Comment
Beam Sequence	300A,00B0	SQ		ALWAYS	COPY	Introduces the sequence of treatment beams for this RT Plan. There will be 1 entry per beam.
>Manufacturer	0008,0070	LO		ANAPCV	COPY	The manufacturer of the machine assigned to this beam.
>Institution Name	0008,0080	LO		ANAPCV		Not used.
>Treatment Machine Name	300A,00B2	SH		VNAP	COPY	The name of the machine assigned to this beam.
>Primary Dosimeter Unit	300A,00B3	CS	MU	ANAPCV	COPY	"MINUTE" is not supported.
>Source-Axis Distance	300A,00B4	DS		ANAPCV	COPY	The SAD of the machine assigned to this beam in mm.
>Beam Limiting Device Sequence	300A,00B6	SQ		ALWAYS	COPY	Introduces the sequence of beam limiting devices (collimator) jaw or leaf (element) sets.

>>RT Beam Limiting Device Type	300A,00B8	CS		ALWAYS	COPY	As appropriate: X = symmetric jaw pair in X direction Y = symmetric jaw pair in Y direction ASYMX = asymmetric jaw pair in X direction ASYMY = asymmetric jaw pair in Y direction MLCX = multileaf jaw pair in X direction MLCY = multileaf jaw pair in Y direction.
>>Source to Beam Limiting Device Distance	300A,00BA	DS		ANAPCV	COPY	The Source to Beam Limiting Device distance in mm.
>>Number of Leaf/Jaw Pairs	300A,00BC	IS		ALWAYS	COPY	
>>Leaf Position Boundaries	300A,00BE	DS		ANAPCV	COPY	The position of the edges of the leaf boundaries with respect to the central axis. There will be the number of leaf pairs + 1 entries.
>Beam Number	300A,00C0	IS		ALWAYS	COPY	Must be unique within the sequence, and within the plan.
>Beam Name	300A,00C2	LO		ANAPCV	COPY	Must be unique.
>Beam Description	300A,00C3	ST		ANAPCV		Not used.
>Beam Type	300A,00C4	CS	STATIC or DYNAMIC	ALWAYS	COPY	Only 2 control points are supported, so essentially we support a static or arc beam.
>Radiation Type	300A,00C6	CS	PHOTON or ELECTRON	VNAP	COPY	
>Referenced Patient Setup Number	300C,006A	IS		ANAPCV	COPY	References the Patient Setup number (300A,0182) as defined in the Patient Setup Module. However Pinnacle only has one primary data set, so there can only be a single sequence.
>Primary Fluence Mode Sequence	3002,0050	SQ		ANAP	COPY	Only a single item shall be permitted in this sequence. If there is more than one item, the Primary Fluence Mode Sequence shall be ignored and the user warned.
>>Fluence Mode	3002,0051	CS		ANAPCV	COPY	Not used.
>>Fluence Mode ID	3002,0052	SH	FFF	ANAPCV	COPY	The matching energy commissioned as FFF will be used for this beam. If there is no commissioned FFF energy, the default energy shall be used.
>High-Dose Technique Type	300A,00C7	CS	NORMAL	ANAPCV	COPY	If sent, the only value supported is NORMAL. If not the discrepancy is logged and the user warned.
>Treatment Delivery Type	300A,00CE	CS	TREATMENT or SETUP	ANAPCV	COPY	
>Number of Wedges	300A,00D0	IS	0 or 1	ALWAYS	COPY	
>Wedge Sequence	300A,00D1	SQ		ANAP	COPY	Introduces sequence of treatment wedges. Required if Number of Wedges is non-zero.
>>Wedge Number	300A,00D2	IS	0	ANAP		Not used.
>>Wedge Type	300A,00D3	CS	STANDARD, DYNAMIC, or MOTORIZED	ANAPCV	COPY	As appropriate: STANDARD = standard (static) wedge DYNAMIC = moving beam limiting device jaw simulating wedge MOTORIZED = single wedge that can be removed from beam remotely.
>>Wedge ID	300A,00D4	SH		ANAPCV	COPY	The Manufacturer code of the wedge assigned to the beam. Must match a code in wedge list.

>>Wedge Angle	300A,00D5	IS		ANAPCV	COPY	The angle of the wedge for the beam.
>>Wedge Factor	300A,00D6	DS		ANAPCV	COPY	Not used.
>>Wedge Orientation	300A,00D8	DS		ANAPCV	COPY	The orientation of the wedge. Must be 0, 90, 180, 270, or 360.
>Number of Compensators	300A,00E0	IS		ALWAYS	COPY	Not supported.
>Compensator Sequence	300A,00E3	SQ		ANAP		Not supported.
>Number of Boli	300A,00ED	IS		ALWAYS		Not supported.
>Number of Blocks	300A,00F0	IS		ALWAYS	COPY	The number of contours required to describe the block.
>Total Block Tray Factor	300A,00F2	DS		ANAPCV	COPY	The tray factor of the beam.
>Block Sequence	300A,00F4	SQ		ANAP	COPY	Introduces sequence of blocks associated with Beam. Required if Number of Blocks is non-zero.
>>Material ID	300A,00E1	SH		ANAPCV	COPY	Not supported.
>>Block Tray ID	300A,00F5	SH		ANAPCV	AUTO	Not supported.
>>Source to Block Tray Distance	300A,00F6	DS		ANAPCV	COPY	Not supported.
>>Block Type	300A,00F8	CS	SHIELDING or APERTURE	ANAP	AUTO	Not supported.
>>Block Divergence	300A,00FA	CS	PRESENT	ANAPCV	FIXED	Not supported.
>>Block Number	300A,00FC	IS		ANAP	AUTO	Not supported.
>>Block Thickness	300A,0100	DS		ANAPCV	COPY	Not supported.
>>Block Transmission	300A,0102	DS		ANAPCV	AUTO	Not supported.
>>Block Number of Points	300A,0104	IS		ANAPCV	AUTO	Not supported.
>>Block Data	300A,0106	DS		ANAPCV	AUTO	Not supported.
>Applicator Sequence	300A,0107	SQ		ANAPCV	COPY	Introduces the sequence of Applicators. Only a single item shall be permitted in this sequence.
>>Accessory Code	300A,00F9	LO		ANAP	AUTO	Supported.
>>Applicator ID	300A,0108	SH		ANAP		Name of the applicator or circular collimator assigned to the beam. For a stereo beam, the name of the circular collimator. For an electron beam, the electron applicator name. Must match an electron applicator or circular collimator in the applicator list.
>>Applicator Type	300A,0109	CS	STEREOTACTIC, ELECTRON_SQUARE, or ELECTRON_RECT	ANAP	COPY	For a stereo beam, set to 'STEREOTACTIC'. For an electron beam the dimensions of the applicator will be checked, if length = height 'ELECTRON_SQUARE' will be set. Otherwise 'ELECTRON_RECT'.
>Final Cumulative Meterset Weight	300A,010E	DS		ANAP	COPY	Must be 1.
>Number of Control Points	300A,0110	IS	2	ALWAYS	COPY	Must be 2, else the beam will be rejected.
>Control Point Sequence	300A,0111	SQ		ALWAYS	COPY	Introduces the sequence of machine configurations describing this treatment beam.
>>Control Point Index	300A,0112	IS		ANAP		
>>Nominal Beam Energy	300A,0114	DS		ANAPCV	COPY	The selected machine energy for this beam. Pinnacle does not support the import of different energies for multiple control points within the same beam.
>>Dose Rate Set	300A,0115	DS		ANAPCV		Not used.

>>Wedge Position Sequence	300A,0116	SQ		ANAPCV		Not used, since we only support a sequence of 1 wedge.
>>>Wedge Position	300A,0118	CS		ANAP	AUTO	If this tag is present, the wedge is presumed to be "IN" since it was defined at all.
>>>Referenced Wedge Number	300C,00C0	IS		ANAP		Not used.
>>Beam Limiting Device Position Sequence	300A,011A	SQ		ANAP		Not used.
>>>RT Beam Limiting Device Type	300A,00B8	CS		ANAP		Not used.
>>>Leaf/Jaw Positions	300A,011C	DS		ANAP	COPY	The jaw or MLC leaf positions for this control point in mm.
>>Gantry Angle	300A,011E	DS		ANAP	COPY	The gantry angle of the beam for this control point. Control point zero will always represent the starting angle for the beam.
>>Gantry Rotation Direction	300A,011F	CS	CW, CC, or NONE	ANAP	COPY	If an arc is being described, this will represent the direction of the gantry rotation ('CW' or 'CC'). If this is a fixed treatment the value should be 'NONE'.
>>Beam Limiting Device Angle	300A,0120	DS		ANAP	COPY	The collimator angle for the beam.
>>Beam Limiting Device Rotation Direction	300A,0121	CS	NONE	ANAP	FIXED	Pinnacle does not support rotation of the collimator during treatment.
>>Patient Support Angle	300A,0122	DS		ANAP	COPY	The couch angle for the beam.
>>Patient Support Rotation Direction	300A,0123	CS	NONE	ANAP	FIXED	Pinnacle does not support rotation of the couch during treatment.
>>Table Top Eccentric Angle	300A,0125	DS		ANAP		Not used.
>>Table Top Eccentric Rotation Direction	300A,0126	CS		ANAP		Not used.
>>Table Top Vertical Position	300A,0128	DS		ANAPCV		Not used.
>>Table Top Longitudinal Position	300A,0129	DS		ANAPCV		Not used.
>>Table Top Lateral Position	300A,012A	DS		ANAPCV		Not used.
>>Isocenter Position	300A,012C	DS		ANAPCV	COPY	Pinnacle does not support movement of the isocenter during treatment.
>>Source to Surface Distance	300A,0130	DS		ANAPCV		Not imported. Pinnacle computes the SSD.
>>Cumulative Meterset Weight	300A,0134	DS		ANAPCV	FIXED	The first control point weight must be 0, and the second must be 1.
>Referenced Tolerance Table Number	300C,00A0	IS		ANAPCV		Not used.
>Referenced Bolus Sequence	300C,00B0	SQ		ANAP		Not used.
>>Referenced ROI Number	3006,0084	IS		ANAP		Not used

Table 141: SOP Common Module

Attribute Name	Tag	VR	Value	Presence of Value	Source	Comment
Specific Character Set	0008,0005	CS		ANAP	COPY	
Instance Creation Date	0008,0012	DA		ANAPCV	COPY	
Instance Creation Time	0008,0013	TM		ANAPCV	COPY	

SOP Class UID	0008,0016	UI	1.2.840.10008.5.1.4.1.1.481.5	ALWAYS	COPY	
SOP Instance UID	0008,0018	UI		ALWAYS	COPY	

#### 8.1.2.4. Usage of the Functionality Spatial Registration Storage SOP Class

The following table lists the supported SOP Classes which can be used by this application.

**Table 142: Supported SOP Classes for functionality Spatial Registration Storage SOP Class**

SOP Class name	SOP Class UID
Spatial Registration Storage	1.2.840.10008.5.1.4.1.1.66.1

**Table 143: Used attributes from Spatial Registration Storage SOP Class Instances**

Information Entity	Module	Presence Of Module
Patient	Patient Module	ALWAYS
Series	RT Series Module	ALWAYS
Frame of Reference	Frame of Reference Module	ALWAYS
Equipment	General Equipment Module	ALWAYS
Spatial Registration	Spatial Registration Module	ALWAYS
	SOP Common Module	ALWAYS

**Table 144: Patient Module**

Attribute Name	Tag	VR	Value	Presence of Value	Source	Comment
Patient's Name	0010,0010	PN		VNAP	COPY	Used to verify the patient plan matches with the data. Matched with the patient name as entered in Launch Pad.
Patient ID	0010,0020	LO		VNAP	COPY	Used to verify the patient plan matches with the data. Matched with the medical record number as entered in Launch Pad.
Patient's Birth Date	0010,0030	DA		VNAP	COPY	Not used.
Patient's Sex	0010,0040	CS		VNAP	COPY	Used to verify the patient plan matches with the data.

**Table 145: RT Series Module**

Attribute Name	Tag	VR	Value	Presence of Value	Source	Comment
Modality	0008,0060	CS	REG	ALWAYS	COPY	
Series Description	0008,103E	LO		ANAPCV	COPY	User defined description for this series.
Series Instance UID	0020,000E	UI		ALWAYS	COPY	Written to transfer log.
Series Number	0020,0011	IS		VNAP	COPY	A number that identifies this series.

**Table 146: Frame of Reference Module**

Attribute Name	Tag	VR	Value	Presence of Value	Source	Comment
Frame of Reference UID	0020,0052	UI		ALWAYS	COPY	Not used.
Position Reference Indicator	0020,1040	LO		VNAP	COPY	Not used.

**Table 147: General Equipment Module**

Attribute Name	Tag	VR	Value	Presence of Value	Source	Comment
Manufacturer	0008,0070	LO		VNAP	COPY	Written to transfer log.
Station Name	0008,1010	SH		ANAPCV	COPY	Written to transfer log.
Manufacturer's Model Name	0008,1090	LO		ANAPCV	COPY	Written to transfer log.
Software Version(s)	0018,1020	LO		ANAPCV	COPY	Written to transfer log.

**Table 148: Spatial Registration Module**

Attribute Name	Tag	VR	Value	Presence of Value	Source	Comment
Content Date	0008,0023	DA		ALWAYS	COPY	Not used.
Content Time	0008,0033	TM		ALWAYS	COPY	Not used.
Registration Sequence	0070,0308	SQ		ALWAYS	COPY	Introduces two registration sequences.
>Frame of Reference UID	0020,0052	UI		ANAP	COPY	Identifies the dataset's Frame of Reference.
>>Referenced SOP Class UID	0008,1150	UI		ALWAYS	COPY	Not used.
>>Referenced SOP Instance UID	0008,1155	UI		ALWAYS	COPY	Not used.
>Matrix Registration Sequence	0070,0309	SQ		ALWAYS	COPY	Introduces a single matrix registration sequence.
>>Frame of Reference Transformation Comment	3006,00C8	DS		ANAPCV	COPY	Not used.
>>Registration Type Code Sequence	0070,030D	SQ		VNAP	COPY	Not used.
>>Matrix Sequence	0070,030A	SQ		ALWAYS	COPY	Introduces a single matrix registration.
>>>Frame of Reference Transformation Matrix	3006,00C6	DS		ALWAYS	COPY	A 4x4 homogeneous transformation matrix that registers the secondary dataset to the primary dataset. Matrix elements shall be listed in row-major order. The primary dataset must be an identity matrix.
Instance Number	0020,0013	IS		ALWAYS	COPY	Not used.
Content Label	0070,0080	CS		ALWAYS	COPY	Not used.

**Table 149: SOP Common Module**

Attribute Name	Tag	VR	Value	Presence of Value	Source	Comment
Specific Character Set	0008,0005	CS		ANAP	COPY	
Instance Creation Date	0008,0012	DA		ANAPCV	COPY	
Instance Creation Time	0008,0013	TM		ANAPCV	COPY	
SOP Class UID	0008,0016	UI	1.2.840.10008.5.1.4.1.1.66.1	ALWAYS	COPY	
SOP Instance UID	0008,0018	UI		ALWAYS	COPY	

**8.1.2.5. Usage of the Functionality RT Dose Storage SOP Class**

The following table lists the supported SOP Classes which can be used by this application.

**Table 150: Supported SOP Classes for functionality RT Dose Storage SOP Class**

SOP Class name	SOP Class UID
RT Dose Storage SOP Class	1.2.840.10008.5.1.4.1.1.481.2

**Table 151: Used attributes from RT Dose Storage Instances**

Information Entity	Module	Presence Of Module
Patient	Patient Module	ALWAYS
Series	RT Series Module	ALWAYS
Frame of Reference	Frame of Reference Module	ALWAYS
Equipment	General Equipment Module	ALWAYS
Dose	Image Plane Module	ALWAYS
Dose	Image Pixel Module	ALWAYS
Dose	Multi-Frame Module	ALWAYS
Dose	RT Dose Module	ALWAYS
Dose	SOP Common Module	ALWAYS

**Table 152: Patient Module**

Attribute Name	Tag	VR	Value	Presence of Value	Source	Comment
Patient's Name	0010,0010	PN		VNAP	COPY	Used to verify the patient plan matches with the data. Matched with the patient name as entered in Launch Pad.
Patient ID	0010,0020	LO		VNAP	COPY	Used to verify the patient plan matches with the data. Matched with the medical record number as entered in Launch Pad.
Patient's Birth Date	0010,0030	DA		VNAP	COPY	Not used.
Patient's Sex	0010,0040	CS		VNAP	COPY	Used to verify the patient plan matches with the data.

**Table 153: RT Series Module**

Attribute Name	Tag	VR	Value	Presence of Value	Source	Comment
Modality	0008,0060	CS	RTDOSE	ALWAYS	COPY	

**Table 154: Frame of Reference Module**

Attribute Name	Tag	VR	Value	Presence of Value	Source	Comment
Frame of Reference UID	0020,0052	UI		ALWAYS	COPY	Matches the Frame of Reference UID to the image set. If there are multiple Frame of References that match (i.e. gated dataset) then we let the user decide which dataset to assign the dose to upon import.
Position Reference Indicator	0020,1040	LO		VNAP	COPY	

**Table 155: General Equipment Module**

Attribute Name	Tag	VR	Value	Presence of Value	Source	Comment
Manufacturer	0008,0070	LO		VNAP	COPY	Written to transfer log.
Station Name	0008,1010	SH		ANAPCV	COPY	Written to transfer log.
Manufacturer's Model Name	0008,1090	LO		ANAPCV	COPY	Written to transfer log.
Software Version(s)	0018,1020	LO		ANAPCV	COPY	Written to transfer log.

Table 156: Image Plane Module

Attribute Name	Tag	VR	Value	Presence of Value	Source	Comment
Slice Thickness	0018,0050	DS		ALWAYS	COPY	Nominal slice thickness, in mm.
Image Orientation (Patient)	0020,0037	DS		ALWAYS	COPY	Must be axial to import dose, and it will determine the dose coordinate system.
Pixel Spacing	0028,0030	DS		ALWAYS	COPY	Physical distance in the patient between the center of each voxel, specified by a numeric pair - adjacent row spacing (delimiter) adjacent column spacing in mm.

Table 157: Image Pixel Module

Attribute Name	Tag	VR	Value	Presence of Value	Source	Comment
Samples per Pixel	0028,0002	US	1	ALWAYS	COPY	
Photometric Interpretation	0028,0004	CS	MONOCHROME2	ALWAYS	COPY	
Rows	0028,0010	US		ALWAYS	AUTO, COPY	Number of rows in the image.
Columns	0028,0011	US		ALWAYS	AUTO, COPY	Number of columns in the image.
Bits Allocated	0028,0100	US	16	ALWAYS	COPY	
Bits Stored	0028,0101	US	16	ALWAYS	COPY	
High Bit	0028,0102	US	15	ALWAYS	COPY	
Pixel Representation	0028,0103	US	0	ALWAYS	COPY	'0' designates unsigned integer.

Table 158: Multi-Frame Module

Attribute Name	Tag	VR	Value	Presence of Value	Source	Comment
Number of Frames	0028,0008	IS		ALWAYS	COPY	Number of frames in a Multi-frame Image. See of the DICOM Part3 specification PS3.3 for explanation.

Table 159: RT Dose Module

Attribute Name	Tag	VR	Value	Presence of Value	Source	Comment
Dose Units	3004,0002	CS	GY	ALWAYS	COPY	Units used to describe dose: 'GY' (Gray)
Dose Type	3004,0004	CS	PHYSICAL or EFFECTIVE	ALWAYS	COPY	
Dose Summation Type	3004,000A	CS	PLAN	ALWAYS	COPY	'PLAN' (dose calculated for a single Prescription (Fraction Group) within an RT Plan)
Grid Frame Offset Vector	3004,000C	DS		ANAP	COPY	We accept only grid based dose whose direction is increasing or decreasing, does not change direction, and is not variably spaced.
Dose Grid Scaling	3004,000E	DS		ALWAYS	COPY	Scaling factor that when multiplied by the dose grid data found in the Pixel Data (7FE0,0010) attribute of the Image Pixel Module, yields grid doses in the dose units as specified by Dose Units (3004,0002).



Table 160: SOP Common Module

Attribute Name	Tag	VR	Value	Presence of Value	Source	Comment
Specific Character Set	0008,0005	CS		ANAP	COPY	
Instance Creation Date	0008,0012	DA		ANAPCV	COPY	
Instance Creation Time	0008,0013	TM		ANAPCV	COPY	
SOP Class UID	0008,0016	UI	1.2.840.10008.5.1.4.1.1.481.2	ALWAYS	COPY	
SOP Instance UID	0008,0018	UI		ALWAYS	COPY	

### 8.1.3. Attribute Mapping

Not applicable.

### 8.1.4. Coerced/Modified fields

Not applicable.

## 8.2. Data Dictionary of Private Attributes

Not applicable.

## 8.3. Coded Terminology and Templates

Not applicable.

### 8.3.1. Context Groups

Not applicable.

### 8.3.2. Template Specifications

Not applicable.

### 8.3.3. Private code definitions

Not applicable.

## 8.4. Grayscale Image consistency

Not applicable.

## 8.5. Standard Extended/Specialized/Private SOPs

### 8.5.1. RT Plan Storage SOP Class Instances

Table 161: Extended DICOM and private attributes for RT Plan Storage SOP Class Instances\*

Attribute Name	Tag	VR	Value	Presence of Value	Source	Comment
Private Creator Code	3253,0010			ALWAYS	AUTO	-
>OBI Field Type Specification	3253,1000			ANAP	AUTO	-
>OBI Information Length	3253,1001			ANAP	AUTO	-
Extended Interface Format	3253,1002			ANAP	AUTO	-

\* The Varian Private attributes are only included if Varian OBI support has been enabled and Setup beams are being exported.

## 8.6. Private Transfer Syntaxes

Not applicable.