

DICOM Conformance Statement

Azurion R2.2

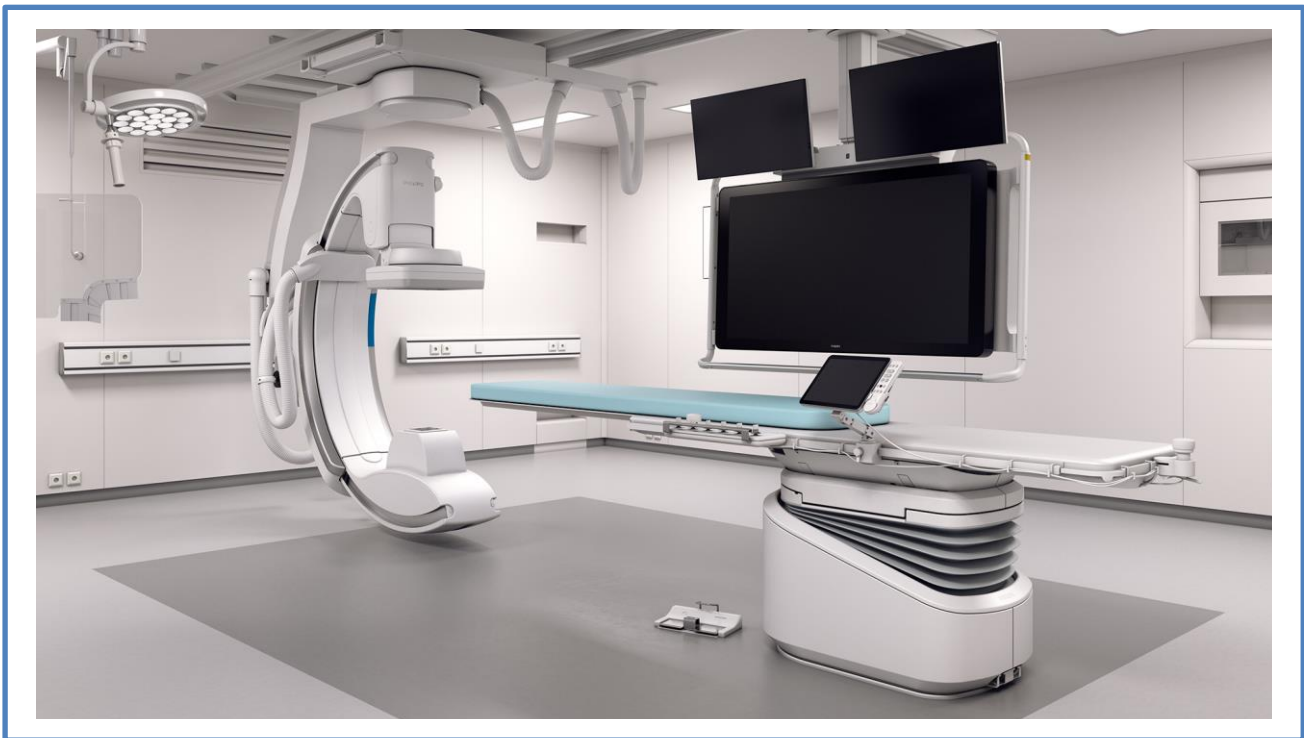

Issued by:

Philips Medical Systems Nederland BV, a Philips Healthcare company,

P.O. Box 10.000
5680 DA Best
The Netherlands

Internet: <https://www.philips.com/DICOM>

Doc Id: HSDP-705820
Date: 2021-May-07

1. DICOM Conformance Statement Overview

Azurion R2.2 system is an interventional X-ray system that is used to perform:

- Image guidance during diagnostic, interventional and minimally invasive surgery procedures for the following clinical application areas: vascular, non-vascular, cardiovascular and neuro procedures.
- Cardiac imaging applications including diagnostics, interventional and minimally invasive surgery procedures.

It provides the following DICOM data exchange features:

- Query the MWL SCP for a Modality Worklist (MWL)
- Update the Modality Performed Procedure Step (MPPS).
- Transfer of DICOM Images and Grayscale Presentation States.
- Query/Retrieve a Workstation or PACS for a list of entries representing Series information of DICOM Images
- Send Storage Commitment to the PACS (for the safe-keeping of the previously transmitted images) and handling the Storage Commitment notifications received from the PACS.
- Print Images on DICOM Printers
- Transfer of X-Ray Radiation Dose Structured Reports to the PACS or Workstation.

The system is verified as DIN 6862-2 compliant

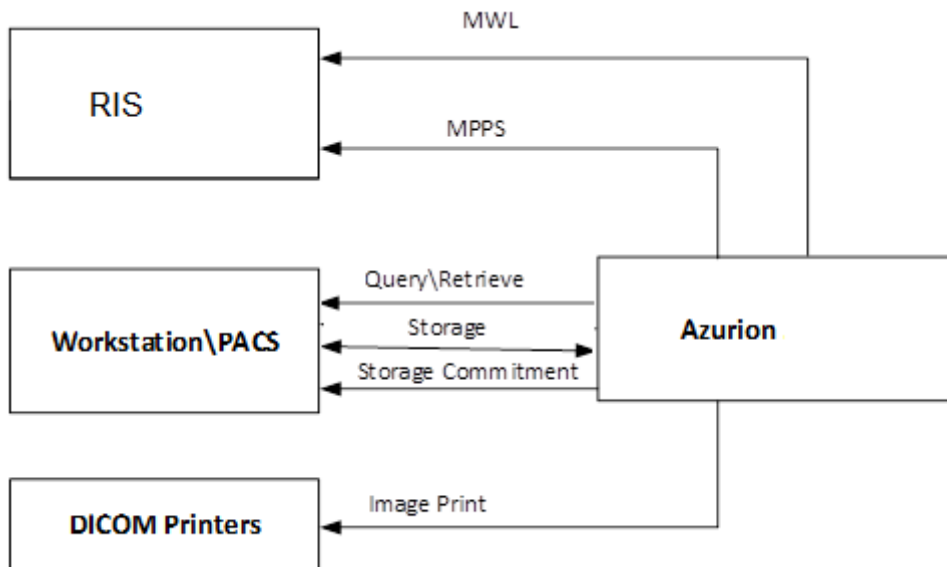

Figure 1 : Data Flow of Azurion R2.2 in a DICOM Network

Table 1: Network Services

SOP Class		User of Service (SCU)	Provider of Service (SCP)
Name	UID		
Other			
Verification SOP Class	1.2.840.10008.1.1	Yes	Yes
Print Management			
Basic Grayscale Print Management Meta SOP Class	1.2.840.10008.5.1.1.9	Yes	No
>Basic Film Session SOP Class	1.2.840.10008.5.1.1.1	Yes	No
>Basic Film Box SOP Class	1.2.840.10008.5.1.1.2	Yes	No
>Basic Grayscale Image Box SOP Class	1.2.840.10008.5.1.1.4	Yes	No
>Printer SOP Class	1.2.840.10008.5.1.1.16	Yes	No
Basic Color Print Management Meta SOP Class	1.2.840.10008.5.1.1.18	Yes	No
>Basic Film Session SOP Class	1.2.840.10008.5.1.1.1	Yes	No

SOP Class		User of Service (SCU)	Provider of Service (SCP)
Name	UID		
>Basic Film Box SOP Class	1.2.840.10008.5.1.1.2	Yes	No
>Basic Color Image Box SOP Class	1.2.840.10008.5.1.1.4.1	Yes	No
>Printer SOP Class	1.2.840.10008.5.1.1.16	Yes	No
Query/Retrieve			
Patient Root QR Information Model - FIND SOP Class	1.2.840.10008.5.1.4.1.2.1.1	Yes	No
Study Root QR Information Model - FIND SOP Class	1.2.840.10008.5.1.4.1.2.2.1	Yes	No
Patient Root QR Information Model - MOVE SOP Class	1.2.840.10008.5.1.4.1.2.1.2	Yes	No
Study Root QR Information Model - MOVE SOP Class	1.2.840.10008.5.1.4.1.2.2.2	Yes	No
Transfer			
Secondary Capture Image Storage SOP Class	1.2.840.10008.5.1.4.1.1.7	Yes	Yes
Grayscale Softcopy Presentation State Storage SOP Class	1.2.840.10008.5.1.4.1.1.11.1	Yes	Yes
X-Ray Angiographic Image Storage SOP Class	1.2.840.10008.5.1.4.1.1.12.1	Yes	Yes
X-Ray Radiation Dose Structured Report SOP Class	1.2.840.10008.5.1.4.1.1.88.67	Yes	No
Workflow Management			
Storage Commitment Push Model SOP Class	1.2.840.10008.1.20.1	Yes	No
Modality Performed Procedure Step SOP Class	1.2.840.10008.3.1.2.3.3	Yes	No
Modality Worklist Information Model - FIND SOP Class	1.2.840.10008.5.1.4.31	Yes	No

Table 2: Media Services

Media Storage Application Profile	File-set Creator (FSC)	File-set Updater (FSU)	File-set Reader (FSR)
Compact disk-Recordable			
General Purpose CD-R Interchange	Yes	No	Yes
DVD-RAM			
General Purpose Interchange on DVD-RAM Media	Yes	No	Yes
USB			
General Purpose USB Media	Yes	Yes	Yes

2. Table of Contents

1.	DICOM CONFORMANCE STATEMENT OVERVIEW	3
2.	TABLE OF CONTENTS	5
3.	INTRODUCTION	7
3.1.	REVISION HISTORY	7
3.2.	AUDIENCE	7
3.3.	REMARKS	7
3.4.	DEFINITIONS, TERMS AND ABBREVIATIONS.....	8
3.5.	REFERENCES.....	9
4.	NETWORKING	10
4.1.	IMPLEMENTATION MODEL	10
4.1.1.	Application Data Flow.....	10
4.1.2.	Functional Definition of AE's	11
4.1.2.1.	Functional Definition of Application Entity Azurion R2.2	11
4.1.3.	Sequencing of Real World Activities	12
4.2.	AE SPECIFICATIONS	13
4.2.1.	AE Specification of Azurion R2.2	13
4.2.1.1.	SOP Classes	13
4.2.1.2.	Association Policies.....	14
4.2.1.3.	General.....	14
4.2.1.4.	Number of Associations.....	14
4.2.1.5.	Asynchronous Nature	14
4.2.1.6.	Implementation Identifying Information	14
4.2.1.7.	Communication Failure Handling.....	14
4.2.1.8.	Association Initiation Policy	15
4.2.1.9.	(Real-World) Activity – Verification as SCU.....	15
4.2.1.10.	(Real-World) Activity – Modality Worklist as SCU.....	17
4.2.1.11.	(Real-World) Activity – Modality Performed Procedure Step as SCU.....	21
4.2.1.12.	(Real-World) Activity – Image Export.....	30
4.2.1.13.	(Real-World) Activity – Storage Commitment Push Model as SCU	32
4.2.1.14.	(Real-World) Activity – FIND as SCU	34
4.2.1.15.	(Real-World) Activity – MOVE as SCU	39
4.2.1.16.	(Real-World) Activity – Print Management as SCU.....	42
4.2.1.17.	Association Acceptance Policy	51
4.2.1.18.	(Real-World) Activity – Verification as SCP	52
4.2.1.19.	(Real-World) Activity – Image Import.....	53
4.3.	NETWORK INTERFACES.....	54
4.3.1.	Physical Network Interfaces	54
4.3.2.	Additional Protocols	55
4.3.2.1.	Basic TLS Secure Transport Connection Profile	55
4.3.2.2.	Basic Application Level Confidentiality Profile	55
4.3.3.	Ipv4 and Ipv6 Support	55
4.4.	CONFIGURATION.....	55
4.4.1.	AE Title/Presentation Address Mapping.....	55
4.4.1.1.	Local AE Titles.....	55
4.4.1.2.	Remote AE Title/Presentation Address Mapping.....	55
4.4.2.	Parameters.....	55
5.	MEDIA INTERCHANGE	56
5.1.	IMPLEMENTATION MODEL	56
5.1.1.	Application Data Flow Diagram	56
5.1.2.	Functional Definitions of AE's.....	56
5.1.3.	Sequencing of Real World Activities	56
5.2.	AE SPECIFICATIONS	56
5.2.1.	Media Storage Media – Specification.....	56

5.2.1.1.	File Meta Information for the Media AE	57
5.2.1.2.	Real-World Activities.....	57
5.2.1.3.	RWA – Read File-set.....	57
5.2.1.4.	RWA – Create File-set.....	57
5.2.1.5.	RWA – Update File-set.....	57
5.3.	AUGMENTED AND PRIVATE APPLICATION PROFILES.....	58
5.4.	MEDIA CONFIGURATION	58
6.	SUPPORT OF CHARACTER SETS.....	59
7.	SECURITY.....	60
7.1.	SECURITY PROFILES	60
7.1.1.	Security use Profiles	60
7.1.2.	Security Transport Connection Profiles.....	60
7.1.3.	Digital Signature Profiles	61
7.1.4.	Media Storage Security Profiles	61
7.1.5.	Attribute Confidentiality Profiles	61
7.1.6.	Network Address Management Profiles	62
7.1.7.	Time Synchronization Profiles.....	62
7.1.8.	Application Configuration Management Profiles.....	62
7.1.9.	Audit Trail Profiles	62
7.2.	ASSOCIATION LEVEL SECURITY.....	63
7.3.	APPLICATION LEVEL SECURITY	63
8.	ANNEXES.....	64
8.1.	IOD CONTENTS	64
8.1.1.	Created SOP Instances.....	64
8.1.1.1.	List of Created SOP Classes	64
8.1.1.2.	Secondary Capture Image Storage SOP Class.....	64
8.1.1.3.	Grayscale Softcopy Presentation State Storage SOP Class	68
8.1.1.4.	X-Ray Angiographic Image Storage SOP Class.....	74
8.1.1.5.	X-Ray Radiation Dose SR	82
8.1.2.	Attribute Mapping	86
8.1.3.	Coerced/Modified Fields.....	86
8.2.	DATA DICTIONARY OF PRIVATE ATTRIBUTES.....	86
8.3.	CODED TERMINOLOGY AND TEMPLATES	86
8.3.1.	Context Group.....	86
8.3.2.	Template Specifications	86
8.3.2.1.	TID 10001 Projection X-Ray Radiation Dose.....	87
8.3.2.2.	TID 10002 Accumulated X-Ray Dose.....	88
8.3.2.3.	TID 10003 Irradiation Event X-Ray Data	88
8.3.2.4.	TID 10003B Irradiation Event X-Ray Source Data (for Fluoroscopy Irradiation Event type)	90
8.3.2.5.	TID 10003B Irradiation Event X-Ray Source Data (for Stationary Acquisition Irradiation Event type)	90
8.3.2.6.	TID 10003C Irradiation Event X-Ray Mechanical Data.....	91
8.3.2.7.	TID 10004 Accumulated Projection X-Ray Dose (for Fluoroscopy Irradiation Event type)	92
8.3.2.8.	TID 10004 Accumulated Projection X-Ray Dose (for Stationary Acquisition Irradiation Event type)	92
8.3.2.9.	TID 10007 Accumulated Total Projection Radiography Dose.....	92
8.3.2.10.	TID 1002 Observer Context.....	92
8.3.2.11.	TID 1004 Device Observer Identifying Attributes	93
8.3.3.	Private Code Definitions.....	93
8.4.	GRAYSCALE IMAGE CONSISTENCY	93
8.5.	STANDARD/EXTENDED/SPECIALIZED/PRIVATE SOP CLASSES	93
9.	DOCUMENT REVISION HISTORY	ERROR! BOOKMARK NOT DEFINED.
10.	APPROVAL	ERROR! BOOKMARK NOT DEFINED.

3. Introduction

3.1. Revision History

The revision history provides dates and differences of the different releases.

Table 3: Revision History

Document Version	Date of Issue	Description
01	07-May-2021	First release of Azurion R2.2

3.2. Audience

This Conformance Statement is intended for:

- (Potential) customers
- System integrators of medical equipment
- Marketing staff interested in system functionality
- Software designers implementing DICOM interfaces

It is assumed that the reader is familiar with the DICOM standard.

3.3. Remarks

The DICOM Conformance Statement is contained in chapter 4 through 8 and follows the contents and structuring requirements of DICOM PS 3.2.

This DICOM Conformance Statement by itself does not guarantee successful interoperability of Philips equipment with non-Philips equipment. The user (or user's agent) should be aware of the following issues:

- **Interoperability**

Interoperability refers to the ability of application functions, distributed over two or more systems, to work successfully together. The integration of medical devices into an IT environment may require application functions that are not specified within the scope of DICOM. Consequently, using only the information provided by this Conformance Statement does not guarantee interoperability of Philips equipment with non-Philips equipment.

It is the user's responsibility to analyse thoroughly the application requirements and to specify a solution that integrates Philips equipment with non-Philips equipment.

- **Validation**

Philips equipment has been carefully tested to assure that the actual implementation of the DICOM interface corresponds with this Conformance Statement.

Where Philips equipment is linked to non-Philips equipment, the first step is to compare the relevant Conformance Statements. If the Conformance Statements indicate that successful information exchange should be possible, additional validation tests will be necessary to ensure the functionality, performance, accuracy and stability of image and image related data. It is the responsibility of the user (or user's agent) to specify the appropriate test suite and to carry out the additional validation tests.

- **New versions of the DICOM Standard**

The DICOM Standard will evolve in future to meet the user's growing requirements and to incorporate new features and technologies. Philips is actively involved in this evolution and plans to adapt its equipment to future versions of the DICOM Standard. In order to do so, Philips reserves the right to make changes to its products or to discontinue its delivery. The user should ensure that any non-Philips provider linking to Philips equipment also adapts to future versions of the DICOM Standard. If not, the incorporation of DICOM enhancements into Philips equipment may lead to loss of connectivity (in case of networking) and incompatibility (in case of media).

3.4. Definitions, Terms and Abbreviations

Table 4: Definitions, Terms and Abbreviations

Abbreviation/Term	Explanation
AE	Application Entity
ANSI	American National Standard Institute
CD	Compact Disc
CD-R	CD-Recordable
CIS	Clinical Information System
DICOM	Digital Imaging and Communications in Medicine
DIMSE	DICOM Message Service Element
DX	Digital X-Ray
EBE	DICOM Explicit VR Big Endian
ELE	DICOM Explicit VR Little Endian
FSC	File-set Creator
FSR	File-set Reader
FSU	File-set Updater
GUI	Graphic User Interface
ILE	DICOM Implicit VR Little Endian
IOD	Information Object Definition
ISIS	Information System – Imaging System
MPPS	Modality Performed Procedure Step
NEMA	National Electrical Manufacturers Association
PDU	Protocol Data Unit
RIS	Radiology Information Systems
RWA	Real-World Activity
SC	Secondary Capture
SCP	Service Class Provider
SCU	Service Class User
SOP	Service Object Pair
SR	Structured Report
TCP/IP	Transmission Control Protocol/Internet Protocol
UID	Unique Identifier
WLM	Worklist Management
XA	X-Ray Angiographic

3.5. References

[DICOM] Digital Imaging and Communications in Medicine, Parts 1 – 22 (NEMA PS 3.1- PS 3.22),
National Electrical Manufacturers Association
1300 North 17th Street
Suite 900
Arlington, Virginia 22209
Internet: <https://www.dicomstandard.org/current>

Note that at any point in time the official standard consists of the most recent yearly edition of the base standard (currently 2019) plus all the supplements and correction items that have been approved as Final Text.

4. Networking

4.1. Implementation model

The implementation model consists of three sections:

- The application data flow diagram, specifying the relationship between the Application Entities and the “external world” or Real-World Activities,
- A functional description of each Application Entity, and
- The sequencing constraints among them.

4.1.1. Application Data Flow

Azurion R2.2 has a single Application Entity in its implementation, namely Azurion R2.2 Application Entity. Figure 2 shows the relationship between the Local and Remote Real World Activities.

- After RWA Verify Application Level Communication, the Azurion R2.2 as SCU uses the remote Request Verification SCP functionality to verify communication.
- After RWA Modality Worklist, the Azurion R2.2 as SCU uses the remote Modality Worklist Information Model SCP functionality to query for Modality Worklist.
- After RWA Create and Set Modality Performed Procedure Step, the Azurion R2.2 as SCU uses the remote Modality Performed Procedure Step SOP Class functionality to Report Modality Performed Procedure Step.
- After RWA Transfer Images + Presentation States + X-Ray Dose Structured Report, the Azurion R2.2 as SCU uses the remote SCP Storage Service Class functionality to store local images-Ray Dose Structured Report and presentation states in a remote database.
- The Azurion R2.2 as SCP Storage Service class accepts images +presentation states from the remote SCU.
- After RWA Storage Commitment, the Azurion R2.2 as SCU uses the remote SCP Storage Commitment Service Class functionality to commit remote images and presentation states.
- After RWA Print Images, the Azurion R2.2 as SCU uses the remote SCP Print management Service Class functionality to print the images.
- After RWA Query Retrieve, the Azurion R2.2 as SCU uses the remote SCP Query Retrieve images Service Class functionality to Query Retrieve.

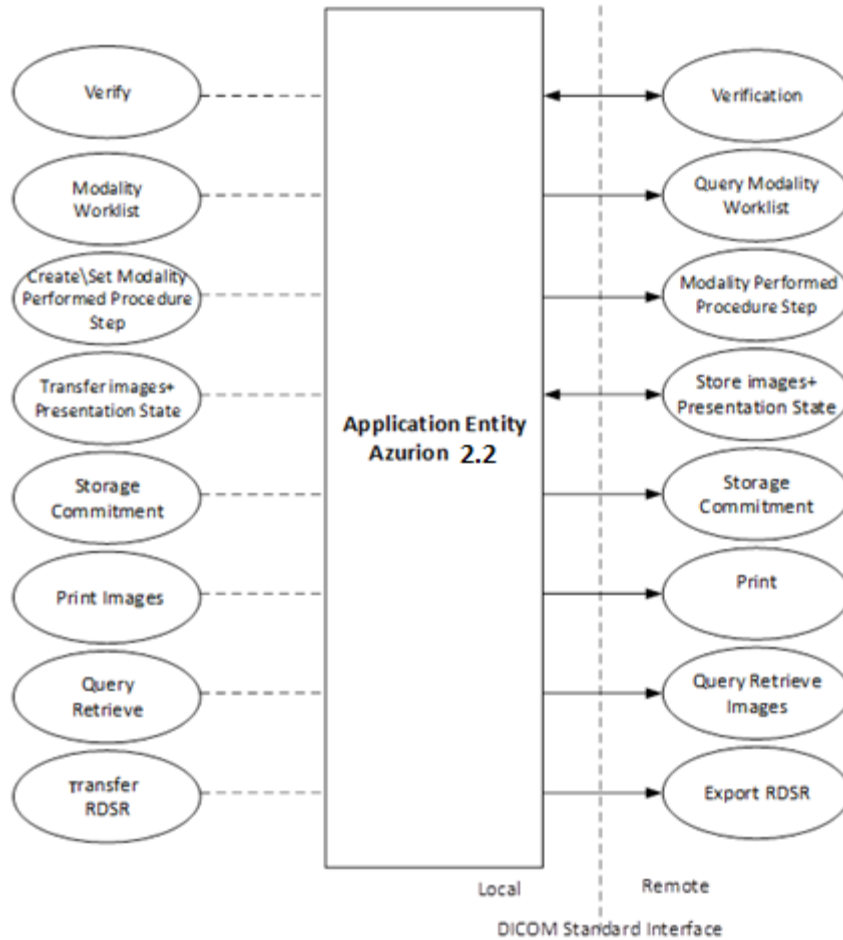

Figure 2 : Functional Overview

4.1.2. Functional Definition of AE's

This section contains a functional definition for each individual local Application Entity.

4.1.2.1. Functional Definition of Application Entity Azurion R2.2

Verification Service Class

The Azurion R2.2 can perform (only to pre-configured systems) the Verification service as SCU, the Azurion R2.2 shall request an Association. When the association is accepted by the remote system, the Azurion R2.2 shall send the Verification request, receive the Verification response, and request for releasing the association.

The Azurion R2.2 can also perform the verification service as SCP, it shall accept association when the association is requested by the remote system.

Storage Service Class

The Azurion R2.2 can perform (only to pre-configured systems) the Storage service as SCU (RWA Transfer Images + Presentation States and Structured Report), triggered by the operator or by an event in the system, e.g. closing of an examination, acquisition of images. The Azurion R2.2 shall request an association with the selected remote SCP for all applicable Storage SOP classes. When the association is accepted, the Azurion R2.2 shall send the Storage requests (including data from local database), receive the Storage responses and act accordingly, and finally request for releasing the association.

The Azurion R2.2 can also perform (only to pre-configured systems) the Storage service as SCP (RWA accept Images +Presentation States). The Azurion R2.2 shall receive an association with the selected remote SCU for all applicable Storage SOP classes, accept the association and receives the Storage requests responses and act accordingly.

Print Management Service Class

The Azurion R2.2 can perform the Print service as SCU (RWA Print Images), triggered by the operator. For each printed sheet, the Azurion R2.2 shall request an association with the selected remote SCP (i.e., a Print Server) for all applicable SOP classes of the applicable Print Management Meta SOP class. When the association is accepted, the Azurion R2.2 shall send the Print requests including data from local database (the N-GET RQ message to get the printer status, the N-CREATE-RQ message to create the Film Session and the Film Box, the N-SET-RQ message to set the Image Box on the printer, finally, the N-ACTION-RQ message to give printer the command to print), receive the Print responses and act accordingly, and finally request for releasing the association. The Azurion R2.2 can perform the Print service as SCU (RWA Get Printer Status), triggered by the operator in the service mode. The Azurion R2.2 shall request an association with the selected remote SCP (Print Server) for the Printer SOP class. When the association is accepted, the Azurion R2.2 shall send the N-GET request, receive the responses from the Print Server and act accordingly, and finally request for releasing the association.

Basic Worklist Management Service Class

The Azurion R2.2 can perform (only to the pre-configured MWL SCP) the Basic Worklist Management service as SCU (RWA Request Modality Worklist), triggered by the operator. The Azurion R2.2 shall request an association. When the association is accepted, the Azurion R2.2 shall send the Worklist request, receive the Worklist responses, and request for releasing the association.

Study Management Service Class

The Azurion R2.2 can perform (only to the pre-configured MWL SCP) the Study Management service as SCU (RWA Create and Set Modality Performed Procedure Step), triggered by the start of an examination (triggered by the first x-ray exposure) for acquisition or closing. The Azurion R2.2 shall request an association. When the association is accepted, the Azurion R2.2 shall send Create and Set requests, receive the responses, and request for releasing the association.

Query Retrieve Service Class

The Azurion R2.2 can perform the Query Retrieve service as SCU. The Azurion R2.2 shall request an association. When the association is accepted, the Azurion R2.2 shall send a Query/Retrieve request, receive the responses, and request for releasing the association.

4.1.3. Sequencing of Real World Activities

The following sequence of Real World activities are supported by Azurion R2.2:

- The clinical user queries the MWL SCP for a (specific) Worklist representing the list of Scheduled Procedure Steps (with demographic information). Based on that query entered at Azurion R2.2, it sends the C-FIND-RQ message with the query criteria. The automatic broad query with configured query criteria shall be triggered whenever user selects scheduled patients page or all patients page.
- The clinical user starts the examination. As a result, Azurion R2.2 notifies the MWL SCP of the start of a new Procedure Step, i.e. it sends the MPPS N-CREATE-RQ message with the "IN PROGRESS" status of the examination.
- The clinical user acquires images with a certain procedure. As a result, if background image transfer is configured, Azurion R2.2 sends automatically the acquired images (and corresponding presentation states) to the PACS and/or the Workstation, i.e., it sends the C-STORE-RQ messages containing the image (and presentation state) information.
- The clinical user completes the examination. As a result, if auto-transfer is configured, Azurion R2.2 sends images (and corresponding presentation states) and dose report to the PACS and/or Workstation (background image transfer), i.e., it sends the C-STORE-RQ messages containing the image (and presentation state) and dose report information.
- When all images (and presentation states), which were to be automatically transferred to the PACS, have been transferred and storage-commit configured, the Azurion R2.2 asks the PACS to take responsibility for the images (and presentation states) that it has stored that originate from the examination, i.e., it sends the N-ACTION-RQ message containing the request for storage commit.
- Azurion R2.2 notifies the MWL SCP of the completion of a Procedure Step, i.e., it sends the N-SET-RQ message with the "COMPLETED" status of the examination. Additionally to the basic flow of activities, the clinical user may also perform the following steps:
 - The clinical user manually transfers images to the PACS and/or Workstation. As a result, Azurion R2.2 sends the C-STORE-RQ messages containing the image information.
 - The clinical user manually prints selected images. As a result, Azurion R2.2 sends the N-GET-RQ message to get the printer status, the N-CREATE-RQ message to create the Film Session and the Film Box, the N-SET-RQ message to set the Image Box on the printer. Finally, it sends the N-ACTION-RQ message to give printer the command to print.

Figure 3 presents normal scheduled workflow. Other workflow situations (e.g., unscheduled procedure steps) will have other sequencing constraints. For example, printing could equally take place after the acquired images have been stored or after the examination have been closed or could be omitted completely. Query for images could take place before images have been acquired or could be omitted completely.

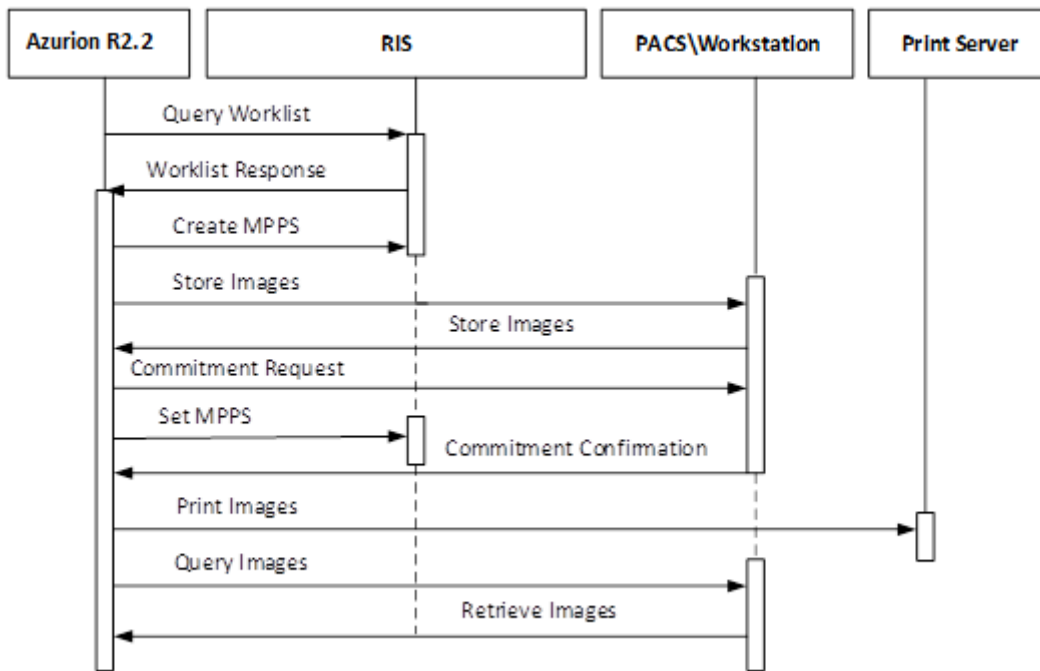

Figure 3 : Azurion R2.2 Sequence Diagram

4.2. AE Specifications

This section in the DICOM Conformance Statement is a set of Application Entity specifications. There are as many of these subsections as there are different AE's in the implementation.

4.2.1. AE Specification of Azurion R2.2

Detail of this specific Application Entity is specified in this section.

4.2.1.1. SOP Classes

This Application Entity provides Standard Conformance to the following SOP Classes.

Table 5: SOP Classes for Azurion R2.2

SOP Class Name	SOP Class UID	SCU	SCP
Verification SOP Class	1.2.840.10008.1.1	Yes	Yes
Storage Commitment Push Model SOP Class	1.2.840.10008.1.20.1	Yes	No
Modality Performed Procedure Step SOP Class	1.2.840.10008.3.1.2.3.3	Yes	No
Basic Grayscale Print Management Meta SOP Class	1.2.840.10008.5.1.1.9	Yes	No
>Basic Film Session SOP Class	1.2.840.10008.5.1.1.1	Yes	No
>Basic Film Box SOP Class	1.2.840.10008.5.1.1.2	Yes	No
>Basic Grayscale Image Box SOP Class	1.2.840.10008.5.1.1.4	Yes	No
>Printer SOP Class	1.2.840.10008.5.1.1.16	Yes	No
Basic Color Print Management Meta SOP Class	1.2.840.10008.5.1.1.18	Yes	No
>Basic Film Session SOP Class	1.2.840.10008.5.1.1.1	Yes	No
>Basic Film Box SOP Class	1.2.840.10008.5.1.1.2	Yes	No

>Basic Color Image Box SOP Class	1.2.840.10008.5.1.1.4.1	Yes	No
>Printer SOP Class	1.2.840.10008.5.1.1.16	Yes	No
Secondary Capture Image Storage SOP Class	1.2.840.10008.5.1.4.1.1.7	Yes	Yes
Grayscale Softcopy Presentation State Storage SOP Class	1.2.840.10008.5.1.4.1.1.11.1	Yes	Yes
X-Ray Angiographic Image Storage SOP Class	1.2.840.10008.5.1.4.1.1.12.1	Yes	Yes
X-Ray Radiation Dose SR	1.2.840.10008.5.1.4.1.1.88.67	Yes	No
Modality Worklist Information Model – FIND SOP Class	1.2.840.10008.5.1.4.31	Yes	No
Patient Root QR Information Model – FIND SOP Class	1.2.840.10008.5.1.4.1.2.1.1	Yes	No
Study Root QR Information Model – FIND SOP Class	1.2.840.10008.5.1.4.1.2.2.1	Yes	No
Patient Root QR Information Model – MOVE SOP Class	1.2.840.10008.5.1.4.1.2.1.2	Yes	No
Study Root QR Information Model – MOVE SOP Class	1.2.840.10008.5.1.4.1.2.2.2	Yes	No

4.2.1.2. Association Policies

Each AE specification contains a description of the general association establishment and acceptance policies of the AE.

4.2.1.3. General

DICOM standard application context name for DICOM 3.0 is always proposed:

Table 6: DICOM Application Context

Description	Value
Application Context Name	1.2.840.10008.3.1.1.1

4.2.1.4. Number of Associations

Azurion R2.2(SCU) can initialize a maximum of one simultaneous associations. The maximum number of simultaneous associations supported by the Azurion R2.2(SCP) is unlimited by default.

Table 7: Maximum number of associations as an Association Initiator for Azurion R2.2

Property	Value
Maximum number of simultaneous associations	1

4.2.1.5. Asynchronous Nature

The Azurion R2.2 does not support asynchronous operations except for storage commitment. After the storage commitment N-ACTION request is transmitted, storage commitment notification may be handled on another association

4.2.1.6. Implementation Identifying Information

The value supplied for Implementation Class UID and version name are documented here.

Table 8: DICOM Implementation Class and Version for Azurion R2.2

Property	Value
Implementation Class UID	1.3.46.670589.7.29.2.2.1
Implementation Version Name	Azurion

4.2.1.7. Communication Failure Handling

The behaviour of this application entity during communication failure is summarized in the table below.

Table 9: Communication Failure Behavior

Exception	Behaviour
Timeout	The association is released and the command is marked failed.

Exception	Behaviour
	The reason is logged and reported to the user.
Association aborted	The ABORT is handled by failing the job and the command is marked failed. The reason is logged and reported to the user.

4.2.1.8. Association Initiation Policy

The Application Entity will respond to a received Association rejection as shown in the next table.

Table 10: Association Rejection response

Result	Source	Reason/Diagnosis	Behaviour
1-rejected-permanent	1-DICOM UL service-user	1-no-reason-given	Log entry.
		2-application-context-name-not-supported	Log entry.
		3-calling-AE-title-not-recognized	Log entry.
		7-called- AE-title-not-recognized	Log entry.
	2-DICOM UL service-provider (ACSE related function)	1-no-reason-given	Log entry.
		2-no-reason-given	Log entry.
		3-DICOM UL service-provider (Presentation related function)	1-temporary-congestion
2-rejected-transient	1-DICOM UL service-user	1-no-reason-given	Log entry.
		2-application-context-name-not-supported	Log entry.
		3-calling-AE-title-not-recognized	Log entry.
		7-called- AE-title-not-recognized	Log entry.
	2-DICOM UL service-provider (ACSE related function)	1-no-reason-given	Log entry.
		2-no-reason-given	Log entry.
	3-DICOM UL service-provider (Presentation related function)	1-temporary-congestion	Log entry.
		2-local-limit-exceeded	Log entry.

Table 11: Association Abort Handling

Source	Reason/Diagnosis	Behaviour
0 – DICOM UL service-user	0 – reason-not-specified	Log entry.
2 – DICOM UL service-provider	0 – reason-not-specified	Log entry.
	1 – unrecognized-PDU	Log entry.
	2 – unexpected-PDU	Log entry.
	4 – unrecognized-PDU-parameter	Log entry.
	5 – unexpected-PDU-parameter	Log entry.
	6 – invalid-PDU-parameter-value	Log entry.

4.2.1.9. (Real-World) Activity – Verification as SCU

4.2.1.9.1.1. Description and Sequencing of Activities

For each Verify Application Level Communication request, an association towards the remote system is established and a C-ECHO request is transmitted. Once the response is received, the association is closed.

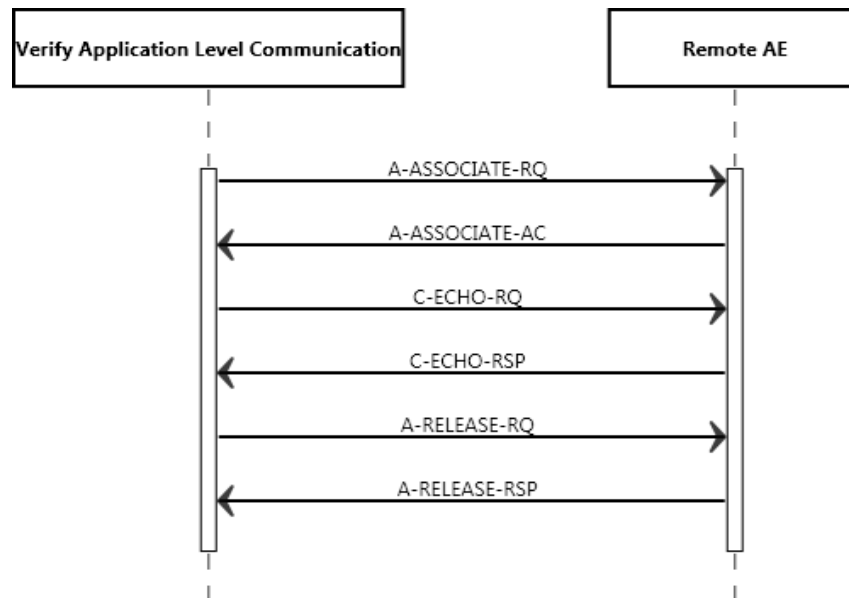

Figure 4: Sequencing of RWA Verify Application Level Communication

4.2.1.9.1.2. Proposed Presentation Contexts

Each time an association is initiated, the Azurion R2.2 proposes one presentation contexts to be used on that association. The presentation context proposed by the Azurion R2.2 for Verify Application Level Communication is defined in Table below.

Table 12: Proposed Presentation Contexts for (Real-World) Activity – Verification as SCU

Presentation Context Table					
Abstract Syntax		Transfer Syntax		Role	Ext. Neg.
Name	UID	Name	UID		
Verification SOP Class	1.2.840.10008.1.1	Implicit VR Little Endian	1.2.840.10008.1.2	SCU	None
		Explicit VR Little Endian	1.2.840.10008.1.2.1		
		Explicit VR Big Endian	1.2.840.10008.1.2.2		

4.2.1.9.1.3. SOP Specific Conformance for Verification SOP Class

4.2.1.9.1.3.1. Dataset Specific Conformance for Verification SOP Class C-ECHO-SCU

The behavior of the Azurion R2.2 for status codes in a Verification response is summarized in Table 13.

Table 13: Verification C-ECHO Response Status Handling Behavior

Service Status	Error Code	Further Meaning	Behaviour
Success	0000	Confirmation	The SCP has successfully responded to the verification request.

The behavior of the Azurion R2.2 during communication failure is summarized in Table 14.

Table 14: Verification Communication Failure Behavior

Service Status	Error Code
Timeout	Association is closed. The reason is logged and reported to the user.
Association aborted	The reason is logged and failure is reported to the user.
Association rejected	The reason is logged and failure is reported to the user.

4.2.1.10. (Real-World) Activity – Modality Worklist as SCU

4.2.1.10.1.1. Description and Sequencing of Activities

For each Broad or Specific Worklist request, the Azurion R2.2 opens an association towards the Basic Worklist Management SCP and sends a C-FIND request. After retrieval of all responses containing matching Worklist items, the association is closed (see Figure 5). All returned Worklist items are displayed to the operator who can select an item from the Worklist and perform an examination.

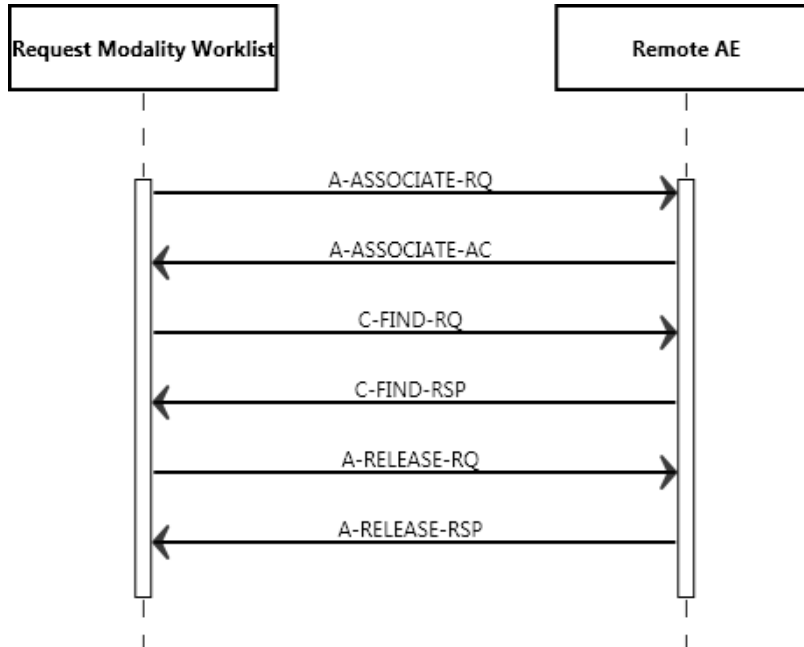

Figure 5 : Sequencing of RWA Request Modality Worklist

The clinical user may cancel the query to the MWL SCP. As a result, Azurion R2.2 sends a C-FIND Cancel Request to the MWL SCP.

4.2.1.10.1.2. Proposed Presentation Contexts

The presentation contexts are defined in the Table 15.

Table 15: Proposed Presentation Contexts for (Real-World) Activity – Modality worklist as SCU

Presentation Context Table					
Abstract Syntax		Transfer Syntax		Role	Ext. Neg.
Name	UID	Name	UID		
Modality Worklist Information Model – FIND SOP Class	1.2.840.10008.5.1.4.31	Implicit VR Little Endian	1.2.840.10008.1.2	SCU	None
		Explicit VR Little Endian	1.2.840.10008.1.2.1		
		Explicit VR Big Endian	1.2.840.10008.1.2.2		

4.2.1.10.1.3. SOP Specific Conformance for Modality Worklist Information Model – FIND SOP Class

Two kinds of queries can be done with the Azurion R2.2: a broad query and a specific query. A broad query for the Worklist is initiated by the operator without filling in any search criteria (the search criteria are based on system configuration). The Matching Keys are presented in Table 16.

A specific Worklist request is initiated by the operator after filling in search criteria in the Graphical User Interface. At least one key should be specified. No verification of query results in relation to the original query criteria is done. The Matching Keys are presented in Table 17.

A received Worklist entry is validated. The entry will be discarded, and an error will be reported when a type-one or type-two attribute is missing, or when the translation of a type-one attribute fails (this includes individual attributes within a sub-sequence).

Table 16: Broad Query Presentation Contexts for (Real-World) Activity Modality Worklist as SCU

Attribute Name	Tag	Matching Key
Scheduled Station AE Title	(0040,0001)	Single value matching
Scheduled Procedure Step Start Date	(0040,0002)	Universal matching or range matching
Scheduled Procedure Step Start Time	(0040,0003)	Universal matching or range matching
Modality	(0008,0060)	Single value matching and Universal matching

Table 17: Matching Table MWL Information Model – Specific Query

Attribute Name	Tag	Matching Key
Scheduled Station AE Title	(0040,0001)	Universal matching or single value matching
Scheduled Procedure Step Start Date	(0040,0002)	Universal matching or range matching
Modality	(0008,0060)	Universal matching or single value matching
Patient's Name	(0010,0010)	Universal matching or single value matching or wild card matching
Patient ID	(0010,0020)	Universal matching or single value matching
Accession Number	(0008,0050)	Universal matching or single value matching
Requested Procedure ID	(0040,1001)	Universal matching or single value matching

4.2.1.10.1.3.1. Dataset Specific Conformance for Modality Worklist Information Model – FIND SOP Class C-FIND-SCU

This section specifies the Modality Worklist Request Attributes.

For each attribute in the following information is supplied:

- Attribute Name: Attributes supported to build a Modality Worklist Request Identifier.
- Tag: DICOM tag for this attribute.
- VR: DICOM VR for this attribute.
- M: Matching Keys for (automatic) Worklist Update.
- R: Return Keys. An "X" will indicate that this attribute as matching key can be used
- Q: Interactive Query Key. An "X" will indicate that this attribute as matching key can be used.
- D: Displayed Keys. An "X" indicates that this Worklist attribute is displayed to the user during a patient registration dialog.
- IOD: An "X" indicates that this Worklist attribute is included into all object Instances created during performance of the related Procedure Step.
- Type of Matching: The following types of matching exists:
- Single Value Matching
 - List of UID Matching
 - Wild Card Matching
 - Range Matching
 - Sequence Matching
 - Universal Matching

Table 18: C-FIND-RQ Dataset Specification.

Modality Worklist Information Model – FIND SOP Class									
Attribute Name	Tag	VR	M	R	Q	D	IOD	Type Of Matching	Comment
Scheduled Procedure Step									
Scheduled Procedure Step Sequence	0040,0100	SQ		X				NA	
>Modality	0008,0060	CS	X	X	X	X	X	Single Value, Universal, Wild Card	
>Requested Contrast Agent	0032,1070	LO	X	X				Universal	
>Scheduled Station AE Title	0040,0001	AE	X	X	X	X		Single Value, Universal, Wild Card	
>Scheduled Procedure Step Start Date	0040,0002	DA	X	X	X	X		Single Value, Universal, Wild Card, range	
>Scheduled Procedure Step Start Time	0040,0003	TM	X	X		X		Single Value, Range, Universal	
>Scheduled Performing Physician's Name	0040,0006	PN	X	X	X	X		Single Value, Universal, Wild Card	
>Scheduled Procedure Step Description	0040,0007	LO	X					Universal	
>Scheduled Protocol Code Sequence	0040,0008	SQ	X					Universal	
>>Code Value	0008,0100	SH	X					Universal	
>>Coding Scheme Designator	0008,0102	SH	X					Universal	
>>Coding Scheme Version	0008,0103	SH	X					Universal	
>>Code Meaning	0008,0104	LO	X					Universal	
>>Protocol Context Sequence	0040,0440	SQ	X					Universal	
>>>Measurement Units Code Sequence	0040,08EA	SQ	X					Universal	
>>>>Code Value	0008,0100	SH	X					Universal	
>>>>Coding Scheme Designator	0008,0102	SH	X					Universal	
>>>>Coding Scheme Version	0008,0103	SH	X					Universal	
>>>>Code Meaning	0008,0104	LO	X					Universal	
>>>Value Type	0040,A040	CS	X					Universal	
>>>Concept Name Code Sequence	0040,A043	SQ	X					Universal	
>>>>Code Value	0008,0100	SH	X					Universal	
>>>>Coding Scheme Designator	0008,0102	SH	X					Universal	
>>>>Coding Scheme Version	0008,0103	SH	X					Universal	
>>>>Code Meaning	0008,0104	LO	X					Universal	
>>>DateTime	0040,A120	DT	X					Universal	
>>>Person Name	0040,A123	PN	X					Universal	
>>>Text Value	0040,A160	UT	X					Universal	
>>>Concept Code Sequence	0040,A168	SQ	X					Universal	
>>>>Code Value	0008,0100	SH	X					Universal	
>>>>Coding Scheme Designator	0008,0102	SH	X					Universal	
>>>>Coding Scheme Version	0008,0103	SH	X					Universal	
>>>>Code Meaning	0008,0104	LO	X					Universal	
>>>Numeric Value	0040,A30A	DS	X					Universal	
>Scheduled Procedure Step ID	0040,0009	SH	X					Universal	
>Scheduled Station Name	0040,0010	SH	X					Universal	

Modality Worklist Information Model – FIND SOP Class									
Attribute Name	Tag	VR	M	R	Q	D	IOD	Type Of Matching	Comment
Scheduled Procedure Step									
>Scheduled Procedure Step Location	0040,0011	SH	X					Universal	
>Pre-Medication	0040,0012	LO	X					Universal	
>Scheduled Procedure Step Status	0040,0020	CS	X					Universal	
Requested Procedure									
Study Instance UID	0020,000D	UI	X	X				Universal	
Requested Procedure Code Sequence	0032,1064	SQ	X					Universal	
>Code Value	0008,0100	SH	X					Universal	
>Coding Scheme Designator	0008,0102	SH	X					Universal	
>Coding Scheme Version	0008,0103	SH	X					Universal	
>Code Meaning	0008,0104	LO	X					Universal	
Requested Procedure ID	0040,1001	SH	X		X	X		Single Value, Universal, Wild Card	
Patient Transport Arrangements	0040,1004	LO	X					Universal	
Imaging Service Request									
Accession Number	0008,0050	SH	X		X	X	X	Single Value, Universal, Wild Card	
Referring Physician's Name	0008,0090	PN	X	X			X	Universal	
Requesting Physician	0032,1032	PN	X					Universal	
Visit Relationship									
Referenced Patient Sequence	0008,1120	SQ						NA	
>Referenced SOP Class UID	0008,1150	UI	X					Universal	
>Referenced SOP Instance UID	0008,1155	UI	X					Universal	
Patient Identification									
Patient's Name	0010,0010	PN	X	X	X	X	X	Single Value, Universal	
Patient ID	0010,0020	LO	X	X	X	X	X	Single Value, Universal	
Patient Demographic									
Patients Birth Date	0010,0030	DA	X	X			X	Single, Universal, Range, Wild Card	
Patient's Sex	0010,0040	CS	X	X			X	Single Value, Universal	
Patient's Weight	0010,1030	DS	X	X			X	Universal	
Patient Medical									
Medical Alerts	0010,2000	LO	X					Universal	
Allergies	0010,2110	LO	X					Universal	
Pregnancy Status	0010,21C0	US	X	X				Universal	
Patient State	0038,0500	LO	X	X				Universal	
SOP Common									
Specific Character Set	0008,0005	CS		X					

The behavior of the Azurion R2.2 for status codes in C-FIND response is summarized in Table 19.

Table 19: Modality Worklist C-FIND Response Status Handling Behavior

Service Status	Error Code	Further Meaning	Behaviour
Success	0000	Matching is complete - No final Identifier is supplied.	The result is reported to the user and is logged.
Refused	A700	Out of Resources	Stops with processing the C-FIND Response(s) from the SCP. No responses displayed to the user.
Failed	A900	Identifier Does Not Match SOP Class	Stops with processing the C-FIND Response(s) from the SCP. The reason is logged and the failure is reported to the user. No responses displayed to the user.
	C001	Unable to process	Stops with processing the C-FIND Response(s) from the SCP. The reason is logged and the failure is reported to the user. No responses displayed to the user.
Cancel	FE00	Matching terminated due to Cancel Match request	Stops with processing the C-FIND Response(s) from the SCP. No responses displayed to the user.
Pending	FF00	Matches are continuing – Current. Match is supported in the same manner as supplied and any Optional Keys were Required Keys.	Continues with processing of the C-FIND Response(s) from the SCP
	FF01	Matches are continuing – Warning that one or more Optional Keys were not supported for existence for this Identifier.	Continues with processing of the C-FIND Response(s) from the SCP.
*	Any other status code	*	The association is aborted using A-ABORT. The reason is logged and the failure is reported to the user. No responses displayed to the user.

The behavior of the Azurion R2.2 during communication failure is summarized in Table 20.

Table 20: Modality Worklist Communication Failure Behavior

Exception	Behaviour
Timeout	The query is marked as failed. The reason is logged and reported to the user. The Azurion R2.2 stops processing the C-FIND Response(s) from the SCP.
Association Aborted	If the association is aborted using A-ABORT, the query is marked as failed. The reason is logged and failure is reported to the user. Stops with processing the C-FIND Response(s) from the SCP.
Association Rejected	The query is marked as failed. The reason is logged and failure is reported to the user. No C-FIND request performed.

4.2.1.11. (Real-World) Activity – Modality Performed Procedure Step as SCU

4.2.1.11.1.1. Description and Sequencing of Activities

For each MPPS Job, a new association towards the Modality Performed Procedure Step is established and closed when the MPPS Job has been transmitted. There are three kinds of MPPS Jobs:

- *MPPS Create Job.* Only an N-CREATE request with status “IN PROGRESS” is transmitted. Once the response is received, the association is closed. The MPPS Create Job is submitted when:
 - A Worklist examination is selected for acquisition;
 - A local examination is selected for acquisition and the system is configured to be connected to an IHE compatible MWL SCP.
 - An already Completed Worklist examination or an already Completed, local examination, is re-selected for acquisition (IHE Append Use Case).
- *MPPS Set Job.* Only an N-SET request is transmitted. The status field will respectively be set to “DISCONTINUED” or “COMPLETED”. Once the response is received, the association is closed. The MPPS Set Job is submitted when:

- An examination is discontinued/deleted/restored to solve patient mixing or closed and the MPPS Create Job is already handled (transmitted).
- *MPPS Create & Set Job*. Over the same association both the N-CREATE request and the N-SET request corresponding to the same examination are transmitted. The MPPS Create & Set Job is submitted when:
 An examination is discontinued/deleted/restored to solve patient mixing and the MPPS Create Job is not already handled (not transmitted). In such a case the MPPS Create & Set Job replaces the MPPS Create Job.

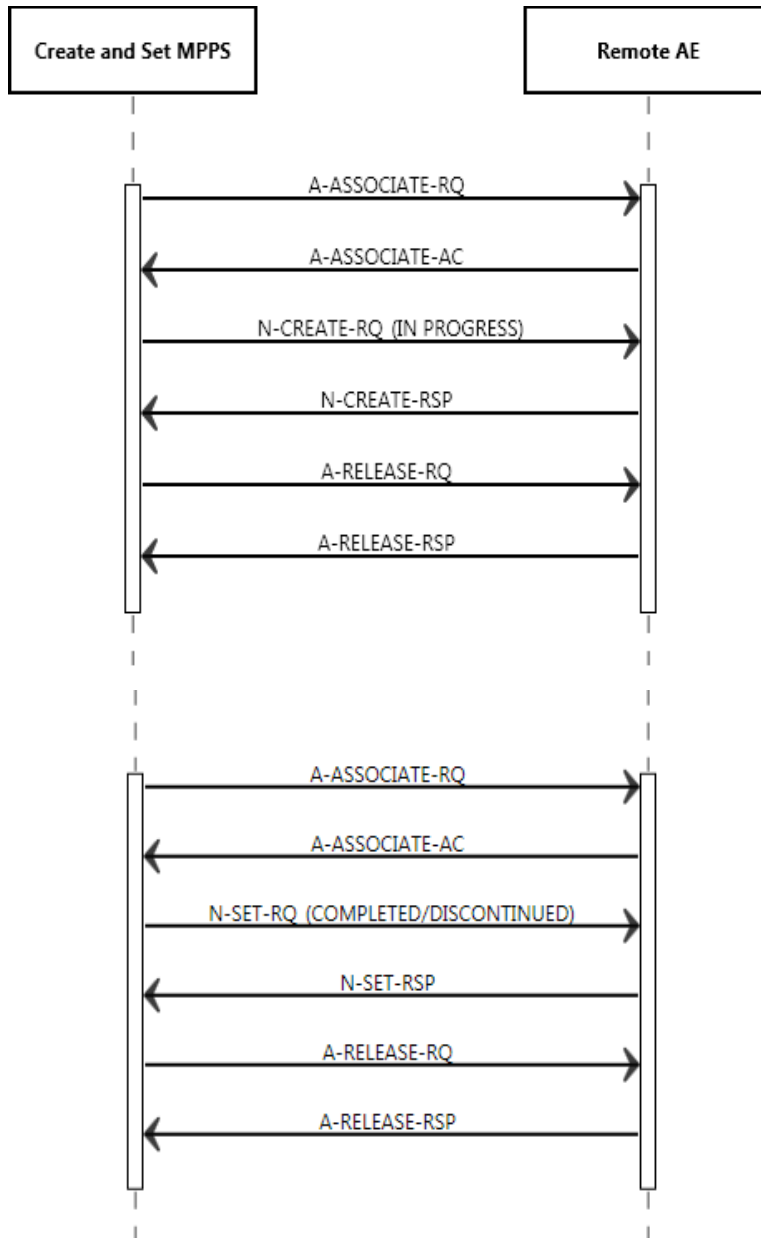

Figure 6: Sequencing of RWA separate MPPS Create and separate MPPS Set Job

MPPS Create and MPPS Set in same association can be established when a procedure is reopened for review and performed some snapshots and export them and then close the study.

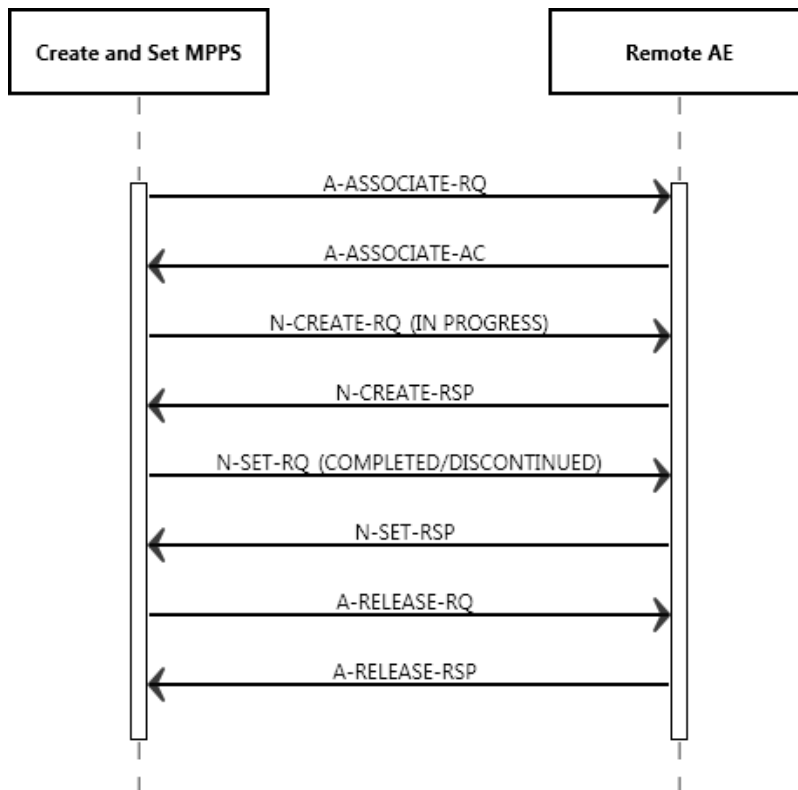

Figure 7: Sequencing of RWA MPPS Create and Set Job

4.2.1.11.1.2. Proposed Presentation Contexts

Each time an association is initiated, the Azurion R2.2 proposes one presentation context to be used on that association. The presentation context proposed by the Azurion R2.2 for Create and Set Modality Performed Procedure Step is defined in table 21.

The implementation chooses Explicit VR Little Endian transfer syntax in case multiple transfer syntaxes are accepted in the association acceptance. All details regarding the specific conformance, including response behavior to all status codes, both from an application level and communication errors are provided in table 23.

Table 21: Proposed Presentation Contexts for (Real-World) Activity – MPPS as SCU

Presentation Context Table					
Abstract Syntax		Transfer Syntax		Role	Extended Negotiation
Name	UID	Name	UID		
Modality Performed Procedure Step SOP Class	1.2.840.10008.3.1.2.3.3	Implicit VR Little Endian	1.2.840.10008.1.2	SCU	None
		Explicit VR Little Endian	1.2.840.10008.1.2.1		
		Explicit VR Big Endian	1.2.840.10008.1.2.2		

4.2.1.11.1.3. SOP Specific Conformance Modality Performed Procedure Step SOP Class

The set of attributes within an N-CREATE and N-SET messages is fixed and it does not depend on configuration settings. In an N-CREATE message, all possible attributes and attribute sequences used in the N-SET are forecasted by defining the attributes and settings their values to NULL. When an N-SET message is transmitted, it may occur that a forecasted attribute isn't actually used. Table 22 up till Table 24 indicate whether or not an attribute and attribute value is sent during N-CREATE.

Table 24 up till Table 26 indicate whether or not an attribute and attribute value is sent during MPPS N-SET.

4.2.1.11.1.3.1. Dataset Specific Conformance for Modality Performed Procedure Step SOP Class N-CREATE-SCU

Table 22: N-CREATE-RQ Dataset Specification.

Modality Performed Procedure Step SOP Class				
Attribute Name	Tag	VR	Value	Comment
SOP Common Module				
Specific Character Set	0008,0005	CS		
Performed Procedure Step Relationship				
Referenced Patient Sequence	0008,1120	SQ		
>Referenced SOP Class UID	0008,1150	UI		
>Referenced SOP Instance UID	0008,1155	UI		
Patient's Name	0010,0010	PN		
Patient ID	0010,0020	LO		
Patient's Birth Date	0010,0030	DA		
Patient's Sex	0010,0040	CS		
Scheduled Step Attributes Sequence	0040,0270	SQ		
>Accession Number	0008,0050	SH		Empty in case of an unscheduled exam
>Referenced Study Sequence	0008,1110	SQ		Empty in case of an unscheduled exam
>>Referenced SOP Class UID	0008,1150	UI		
>>Referenced SOP Instance UID	0008,1155	UI		
>Study Instance UID	0020,000D	UI		
>Requested Procedure Description	0032,1060	LO		Empty in case of an unscheduled exam
>Scheduled Procedure Step Description	0040,0007	LO		Empty in case of an unscheduled exam
>Scheduled Protocol Code Sequence	0040,0008	SQ		
>>Code Value	0008,0100	SH		
>>Coding Scheme Designator	0008,0102	SH		
>>Code Meaning	0008,0104	LO		
>Scheduled Procedure Step ID	0040,0009	SH		Empty in case of an unscheduled exam
>Requested Procedure ID	0040,1001	SH		Empty in case of an unscheduled exam
Performed Procedure Step Information				
Procedure Code Sequence	0008,1032	SQ		
>Code Value	0008,0100	SH		
>Coding Scheme Designator	0008,0102	SH		
>Code Meaning	0008,0104	LO		
>Context Group Extension Flag	0008,010B	CS		
>Context Identifier	0008,010F	CS		
>Context UID	0008,0117	UI		
Performed Station AE Title	0040,0241	AE		AE Title as configured by the MWL SCP/CIS unit.
Performed Station Name	0040,0242	SH		
Performed Location	0040,0243	SH		Always Empty
Performed Procedure Step Start Date	0040,0244	DA		
Performed Procedure Step Start Time	0040,0245	TM		
Performed Procedure Step End Date	0040,0250	DA		
Performed Procedure Step End Time	0040,0251	TM		
Performed Procedure Step Status	0040,0252	CS		
Performed Procedure Step ID	0040,0253	SH		
Performed Procedure Step Description	0040,0254	LO		
Performed Procedure Type Description	0040,0255	LO		

Modality Performed Procedure Step SOP Class				
Attribute Name	Tag	VR	Value	Comment
Image Acquisition Results				
Modality	0008,0060	CS		Applied Value(s): XA
Study ID	0020,0010	SH		If no Study ID is known, the Accession Number will be used as value.
Performed Protocol Code Sequence	0040,0260	SQ		
>Code Value	0008,0100	SH		
>Coding Scheme Designator	0008,0102	SH		
>Coding Scheme Version	0008,0103	SH		
>Code Meaning	0008,0104	LO		
>Context Group Extension Flag	0008,010B	CS		
>Context Identifier	0008,010F	CS		
>Context UID	0008,0117	UI		
>Protocol Context Sequence	0040,0440	SQ		
>>Content Item Modifier Sequence	0040,0441	SQ		
>>>Value Type	0040,A040	CS		
>>>Concept Name Code Sequence	0040,A043	SQ		
>>>>Code Value	0008,0100	SH		
>>>>Coding Scheme Designator	0008,0102	SH		
>>>>Code Meaning	0008,0104	LO		
>>>>Context Group Extension Flag	0008,010B	CS		
>>>>Context Identifier	0008,010F	CS		
>>>>Context UID	0008,0117	UI		
>>Value Type	0040,A040	CS		
>>Concept Name Code Sequence	0040,A043	SQ		
>>>Code Value	0008,0100	SH		
>>>Coding Scheme Designator	0008,0102	SH		
>>>Code Meaning	0008,0104	LO		
>>>Context Group Extension Flag	0008,010B	CS		
>>>Context Identifier	0008,010F	CS		
>>>Context UID	0008,0117	UI		
Performed Series Sequence	0040,0340	SQ		Sequence will be empty when there are no images to report
>Retrieve AE Title	0008,0054	AE		
>Series Description	0008,103E	LO		
>Performing Physician's Name	0008,1050	PN		
>Operators' Name	0008,1070	PN		
>Operator Identification Sequence	0008,1072	SQ		
>>Institution Address	0008,0081	ST		
>>Person Identification Code Sequence	0040,1101	SQ		
>>>Code Value	0008,0100	SH		
>>>Coding Scheme Designator	0008,0102	SH		
>>>Code Meaning	0008,0104	LO		
>>>Context Group Extension Flag	0008,010B	CS		
>>>Context Identifier	0008,010F	CS		

Modality Performed Procedure Step SOP Class				
Attribute Name	Tag	VR	Value	Comment
>>>Context UID	0008,0117	UI		
>>Person's Address	0040,1102	ST		
>>Person's Telephone Numbers	0040,1103	LO		
>Referenced Image Sequence	0008,1140	SQ		
>>Referenced SOP Class UID	0008,1150	UI		
>>Referenced SOP Instance UID	0008,1155	UI		
>>Container Identifier	0040,0512	LO		
>>Specimen Description Sequence	0040,0560	SQ		
>>>Specimen Identifier	0040,0551	LO		
>>>Specimen UID	0040,0554	UI		
>Protocol Name	0018,1030	LO		
>Series Instance UID	0020,000E	UI		
>Referenced Non-Image Composite SOP Instance Sequence	0040,0220	SQ		
>>Referenced SOP Class UID	0008,1150	UI		
>>Referenced SOP Instance UID	0008,1155	UI		
Radiation Dose				
Image and Fluoroscopy Area Dose Product	0018,115E	DS		
Total Time of Fluoroscopy	0040,0300	US		
Total Number of Exposures	0040,0301	US		
Entrance Dose	0040,0302	US		
Exposure Dose Sequence	0040,030E	SQ		
Entrance Dose in mGy	0040,8302	DS		
Billing And Material Management Codes				
Film Consumption Sequence	0040,0321	SQ		Always Empty
>Medium Type	2000,0030	CS		
>Film Size ID	2010,0050	CS		
>Number of Films	2100,0170	IS		

The behavior of the Azurion R2.2 for status codes in an MPPS N-CREATE response and NSET response is presented in Table 23 and Table 24 respectively. In case of the retransmission attempt each message stored in the persistent queue is sent over a separate association.

Table 23: MPPS N-CREATE Response Status Handling Behavior

Service Status	Error Code	Further Meaning	Behavior
Success	0000	Successful operation.	Association will be released. The notify status of the related examination is Updated (set to in progress). The examination status is not changed (e.g. still in progress).
Failure	0213	Resource Limitation	The message contents is made persistent and the message is added to the persistent queue and waits For the next retransmission attempt. The examination status is not changed (e.g. still in Progress).
*	Any other status	*	Association will be released. If the response status is reported during initial

	code		transmission the message contents is made persistent and the message is added to the Persistent queue. If this response status is the result of the retransmission attempt related examination is updated to the state as if the transmission Succeeded. This means that the notify status of the related examination is updated (set to in progress) The examination status is not changed (e.g. still in progress).The response status Is logged as a warning.
--	------	--	--

Table 24: MPPS Communication Failure Behavior (N-SET, N-CREATE) Exception Behavior

Exception	Behavior
Timeout	The Association is aborted using A-ABORT. The reason is logged and reported to the user. The message content is made persistent and the message is added to the persistent queue and waits for the next retransmission attempt. The examination status is set to CLOSED.
Association Aborted	The command is marked as failed. The reason is logged and reported to the user. The message content is made persistent and the message is added to the persistent queue and waits for the next retransmission attempt. The examination status is set to CLOSED.
Association Rejected	The command is marked as failed. The reason is logged and reported to the user. The message content is made persistent and the message is added to the persistent queue and waits for the next retransmission attempt. The examination status is set to CLOSED.

4.2.1.11.1.3.2. Dataset Specific Conformance for Modality Performed Procedure Step SOP Class N-SET-SCU

Table 25: N-SET-RQ Dataset Specification.

Modality Performed Procedure Step SOP Class				
Attribute Name	Tag	VR	Value	Comment
Sop Common Module				
Specific Character Set	0008,0005	CS		
Performed Procedure Step Information				
Procedure Code Sequence	0008,1032	SQ		
>Code Value	0008,0100	SH		
>Coding Scheme Designator	0008,0102	SH		
>Code Meaning	0008,0104	LO		
>Context Group Extension Flag	0008,010B	CS		
>Context Identifier	0008,010F	CS		
>Context UID	0008,0117	UI		
Performed Procedure Step End Date	0040,0250	DA		
Performed Procedure Step End Time	0040,0251	TM		
Performed Procedure Step Status	0040,0252	CS		Applied Values: COMPLETED or DISCONTINUED
Performed Procedure Step Description	0040,0254	LO		May be Empty by configuration
Performed Procedure Type Description	0040,0255	LO		
Image Acquisition Results				
Performed Protocol Code Sequence	0040,0260	SQ		Sequence remains empty
>Code Value	0008,0100	SH		
>Coding Scheme Designator	0008,0102	SH		
>Code Meaning	0008,0104	LO		
>Context Group Extension Flag	0008,010B	CS		

Modality Performed Procedure Step SOP Class				
Attribute Name	Tag	VR	Value	Comment
>Context Identifier	0008,010F	CS		
>Context UID	0008,0117	UI		
>Protocol Context Sequence	0040,0440	SQ		May be empty when no images to be reported
>>Content Item Modifier Sequence	0040,0441	SQ		
>>>Value Type	0040,A040	CS		
>>>Concept Name Code Sequence	0040,A043	SQ		
>>>>Code Value	0008,0100	SH		
>>>>Coding Scheme Designator	0008,0102	SH		
>>>>Code Meaning	0008,0104	LO		
>>>>Context Group Extension Flag	0008,010B	CS		
>>>>Context Identifier	0008,010F	CS		
>>>>Context UID	0008,0117	UI		
>>Value Type	0040,A040	CS		
>>Concept Name Code Sequence	0040,A043	SQ		
>>>Code Value	0008,0100	SH		
>>>Coding Scheme Designator	0008,0102	SH		
>>>Code Meaning	0008,0104	LO		
>>>Context Group Extension Flag	0008,010B	CS		
>>>Context Identifier	0008,010F	CS		
>>>Context UID	0008,0117	UI		
Performed Series Sequence	0040,0340	SQ		
>Retrieve AE Title	0008,0054	AE		
>Series Description	0008,103E	LO		
>Series Description Code Sequence	0008,103F	SQ		
>>Code Value	0008,0100	SH		
>>Coding Scheme Designator	0008,0102	SH		
>>Code Meaning	0008,0104	LO		
>>Context Group Extension Flag	0008,010B	CS		
>>Context Identifier	0008,010F	CS		
>>Context UID	0008,0117	UI		
>Performing Physician's Name	0008,1050	PN		
>Performing Physician Identification Sequence	0008,1052	SQ		
>>Institution Address	0008,0081	ST		
>>Person Identification Code Sequence	0040,1101	SQ		
>>>Code Value	0008,0100	SH		
>>>Coding Scheme Designator	0008,0102	SH		
>>>Code Meaning	0008,0104	LO		
>>>Context Group Extension Flag	0008,010B	CS		
>>>Context Identifier	0008,010F	CS		
>>>Context UID	0008,0117	UI		
>>Person's Address	0040,1102	ST		
>>Person's Telephone Numbers	0040,1103	LO		
>Operators' Name	0008,1070	PN		
>Operator Identification Sequence	0008,1072	SQ		
>>Institution Address	0008,0081	ST		
>>Person Identification Code Sequence	0040,1101	SQ		
>>>Code Value	0008,0100	SH		

Modality Performed Procedure Step SOP Class				
Attribute Name	Tag	VR	Value	Comment
>>>Coding Scheme Designator	0008,0102	SH		
>>>Code Meaning	0008,0104	LO		
>>>Context Group Extension Flag	0008,010B	CS		
>>>Context Identifier	0008,010F	CS		
>>>Context UID	0008,0117	UI		
>>Person's Address	0040,1102	ST		
>>Person's Telephone Numbers	0040,1103	LO		
>Referenced Image Sequence	0008,1140	SQ		
>>Referenced SOP Class UID	0008,1150	UI		
>>Referenced SOP Instance UID	0008,1155	UI		
>>Container Identifier	0040,0512	LO		
>>Specimen Description Sequence	0040,0560	SQ		
>>>Specimen Identifier	0040,0551	LO		
>>>Specimen UID	0040,0554	UI		
>Protocol Name	0018,1030	LO		
>Series Instance UID	0020,000E	UI		
>Referenced Non-Image Composite SOP Instance Sequence	0040,0220	SQ		Refers to Dicom Object that were transferred to the PACS.
>>Referenced SOP Class UID	0008,1150	UI		
>>Referenced SOP Instance UID	0008,1155	UI		
>Archive Requested	0040,A494	CS		
Radiation Dose				
Image and Fluoroscopy Area Dose Product	0018,115E	DS		
Total Time of Fluoroscopy	0040,0300	US		
Total Number of Exposures	0040,0301	US		
Entrance Dose	0040,0302	US		
Entrance Dose in mGy	0040,8302	DS		
Exposure Dose Sequence	0040,030E	SQ		
>KVP	0018,0060	DS		
>Exposure Time	0018,1150	IS		
>Radiation Mode	0018,115A	CS	PULSED	
>Filter Type	0018,1160	SH		
>Filter Material	0018,7050	CS		
>X-Ray Tube Current In uA	0018,8151	DS		
>Comments on Radiation Dose	0040,0310	ST		
Billing And Material Management Codes				
Film Consumption Sequence	0040,0321	SQ		
>Medium Type	2000,0030	CS		
>Film Size ID	2010,0050	CS		
>Number of Films	2100,0170	IS		

The behavior of the Azurion R2.2 for status codes in an MPPS N-SET response is presented in Table 26. In case of the retransmission attempt each message stored in the persistent queue is sent over a separate association.

Table 26: MPPS N-SET Response Status Handling Behavior

Service Status	Error Code	Further Meaning	Behavior
Success	0000	Successful operation.	Association will be released. The notify status of the related examination is

			Updated (set to notified). The examination status is Set to COMPLETED and it is logged.
Failure	0213	Resource Limitation	The message content is made persistent and the Message is added to the persistent queue and waits For the next retransmission attempt. The examination status is set to CLOSED.
*	Any other status code	*	Association will be released. If this response status is reported during initial transmission the message contents is made persistent and the message is added to the persistent queue. If this response status is the result of the retransmission attempt related examination is updated to the state as if the transmission succeeded. Than the notify status of the related examination is updated (set to notified). The response status is logged as a warning. The examination status is set to COMPLETED.

4.2.1.12. (Real-World) Activity – Image Export

4.2.1.12.1.1. Description and Sequencing of Activities

The operator can select images (and presentation states) and request them to be sent to (pre-configure) multiple destinations. Each request is forwarded to the job queue and processed as individual request to Transfer Images (and Presentation States). If background image and presentation state transfer is configured, the Azurion R2.2 sends the acquired images and presentation states automatically. It can be configured which instances will be automatically marked and the destinations where the instances are automatically sent to. The background image and presentation state transfer is triggered by the image acquisition event and/or by the close examination event in Azurion R2.2. For each request to Transfer Images (and Presentation States) (i.e., transfer job), one association towards the remote system is established. Within the association, for each image or presentation state, a C-STORE request is transmitted. Once the responses are received, the association is closed. A possible sequence of interactions between the Azurion R2.2 and a remote AE with only one C-STORE request is presented in Figure 8.

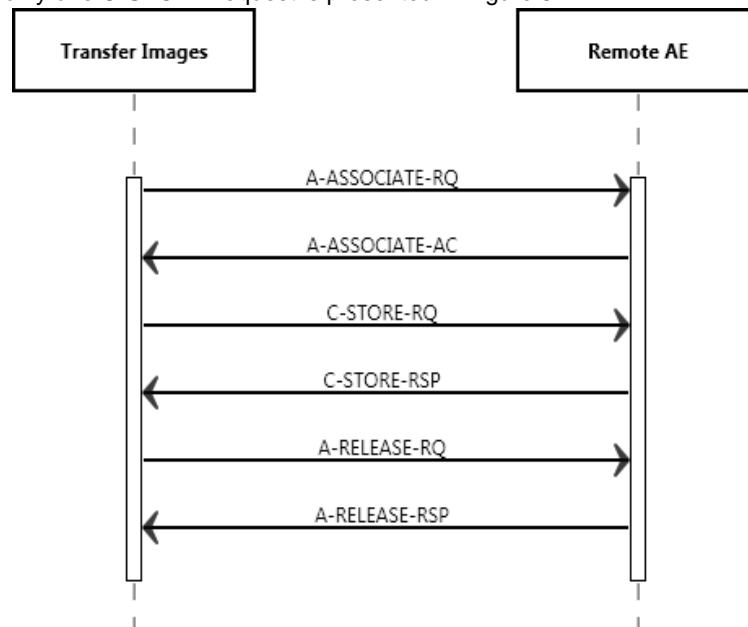

Figure 8 : Sequencing of RWA Image Export

4.2.1.12.1.2. Proposed Presentation Contexts

Each time an association is initiated, the Azurion R2.2 proposes two presentation contexts to be used on that association. The presentation context proposed by the Azurion R2.2 for Transfer Images is defined in Table 27.

The implementation proposes each SOP Class only once in the abstract syntax specifying all possible transfer syntaxes for that SOP Class. Due to the fact that the SCP has to react with a chosen transfer syntax, as per SOP Class used transfer syntax is forced by the SCP.

Table 27: Proposed Presentation Contexts for (Real-World) Activity Image Export

Presentation Context Table					
Abstract Syntax		Transfer Syntax		Role	Extended Negotiation
Name	UID	Name	UID		
Secondary Capture Image Storage SOP Class	1.2.840.10008.5.1.4.1.1.7	Implicit VR Little Endian	1.2.840.10008.1.2	SCU	None
		Explicit VR Little Endian	1.2.840.10008.1.2.1		
		Explicit VR Big Endian	1.2.840.10008.1.2.2		
		JPEG Lossless, Non-Hierarchical, First-Order Prediction (Process 14)	1.2.840.10008.1.2.4.70		
Grayscale Softcopy Presentation State Storage SOP Class	1.2.840.10008.5.1.4.1.1.11.1	Implicit VR Little Endian	1.2.840.10008.1.2	SCU	None
		Explicit VR Little Endian	1.2.840.10008.1.2.1		
		Explicit VR Big Endian	1.2.840.10008.1.2.2		
X-Ray Angiographic Image Storage SOP Class	1.2.840.10008.5.1.4.1.1.12.1	Implicit VR Little Endian	1.2.840.10008.1.2	SCU	None
		Explicit VR Little Endian	1.2.840.10008.1.2.1		
		Explicit VR Big Endian	1.2.840.10008.1.2.2		
		JPEG Lossless, Non-Hierarchical, First-Order Prediction (Process 14)	1.2.840.10008.1.2.4.70		
X-Ray Radiation Dose SR	1.2.840.10008.5.1.4.1.1.88.67	Implicit VR Little Endian	1.2.840.10008.1.2	SCU	None
		Explicit VR Little Endian	1.2.840.10008.1.2.1		
		Explicit VR Big Endian	1.2.840.10008.1.2.2		

4.2.1.12.1.3. SOP Specific Conformance for SOP Classes

Azurion R2.2 can exchange image data in the following formats:

- X-Ray Angiographic images can either be sent with raw pixel data or processed pixel data.
- Standard Secondary Capture (1.2.840.10008.5.1.4.1.1.7)
- Standard Grayscale Softcopy Presentation State SOP Class (1.2.840.10008.5.1.4.1.1.11.1)

Furthermore, the Azurion R2.2 can exchange non-image data in the following format:

- X-Ray Radiation Dose Structured Report (1.2.840.10008.5.1.4.1.1.88.67)

The behavior of Azurion R2.2 for status codes in a C-STORE response is summarized in Table 28.

Table 28: Storage C-STORE Response Status Handling Behavior

Service Status	Error Code	Further Meaning	Behavior
Success	0000	Successful operation	The SCP has successfully stored the SOP Instances. If all SOP Instances in a send job have status success then the job is marked as completed. Success is logged.
Refused	A700-A7FF	Out of Resources	The association is released and the send job is marked as failed. An error message is logged.
Error	A900-A9FF	Data Set does not match SOP Class	
	C000-CFFF	Cannot Understand	
Warning	B000	Coercion of Data Elements	The association is released and the send job is marked as failed. An error message is logged.
	B006	Elements discarded	
	B007	Data set does not match SOP class	
*	Any other status code	*	The association is released and the send job is marked as failed. An error message is logged.

The behavior of Azurion R2.2 during communication failure is summarized in Table 29.

Table 29: Storage Communication Failure Behavior

Exception	Behavior
Timeout	The send job is marked as failed. An error message is logged.
Association aborted	The send job is marked as failed. An error message is logged.
Association rejected	The send job is marked as failed. An error message is logged.

4.2.1.13. (Real-World) Activity – Storage Commitment Push Model as SCU

4.2.1.13.1.1. Description and Sequencing of Activities

Azurion R2.2 Storage Commitment as a SCU service. It accepts a storage commitment notification (N-EVENT-REPORT) from systems that send them.

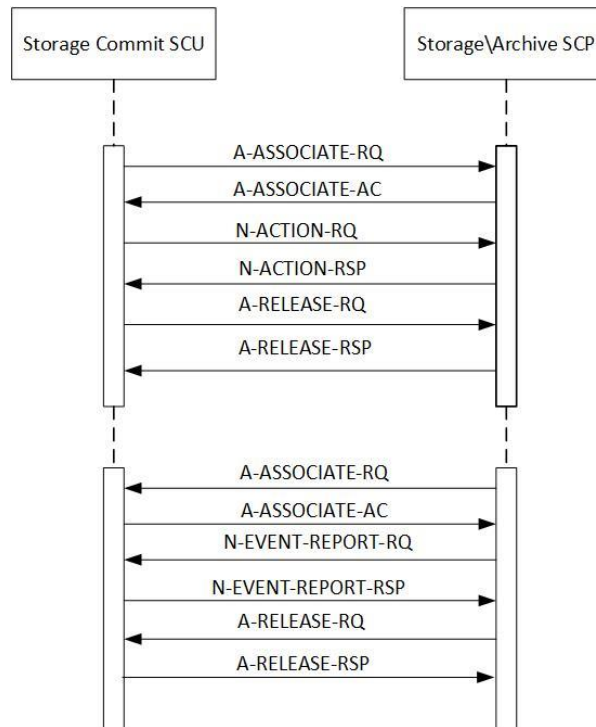

Figure 9: Data Flow Diagram – Commit Image (asynchronous)

4.2.1.13.1.2. Proposed Presentation Contexts

The presentation contexts are defined in the Table 30.

Table 30: Proposed Presentation Contexts for (Real-World) Activity – Storage Commitment Push Model as SCU

Presentation Context Table					
Abstract Syntax		Transfer Syntax		Role	Extended Negotiation
Name	UID	Name	UID		
Storage Commitment Push Model SOP Class	1.2.840.10008.1.20.1	Implicit VR Little Endian	1.2.840.10008.1.2	SCU	None
		Explicit VR Little Endian	1.2.840.10008.1.2.1		
		Explicit VR Big Endian	1.2.840.10008.1.2.2		

4.2.1.13.1.3. SOP Specific Conformance for Storage Commitment Push Model SOP Class

This section and sub-section include the manufacturer SOP and Dataset specific information as well the status codes and their corresponding behavior.

4.2.1.13.1.3.1. Dataset Specific Conformance for Storage Commitment Push Model SOP Class N-ACTION-SCU

Details regarding the Dataset Specific response behaviour will be reported in this section.

Table 31: N-ACTION-RQ Dataset Specification.

Storage Commitment Push Model SOP Class			
Attribute Name	Tag	VR	Comment
Sop Common Module			
SOP Class UID	0008,0016	UI	
SOP Instance UID	0008,0018	UI	
Storage Commitment Module			
Transaction UID	0008,1195	UI	
Referenced SOP Sequence	0008,1199	SQ	
>Referenced SOP Class UID	0008,1150	UI	
>Referenced SOP Instance UID	0008,1155	UI	

The details regarding the response behaviour to status codes are provided in Table 32.

Table 32: Storage Commitment N-ACTION Response Status Handling Behavior

Service Status	Error Code	Further Meaning	Behavior
Success	0000	Successful operation	The storage commitment request has been successfully sent. The storage commitment request job is marked as completed. Success is logged.

Table 33: Storage Commitment N-EVENT-REPORT Behavior

Event Type	Event Type ID	Behavior
Storage Commitment Request Successful	1	The Examination is marked as completed and it becomes a candidate for an automatic deletion from the local database if local resources become scarce.
Storage Commitment Request Complete – Failures Exist	2	The failure is reported to the operator by not marking the examination as completed. The operator may re-transfer the image data (which was previously transferred to the PACS).

4.2.1.13.1.3.2. Dataset Specific Conformance for Storage Commitment Push Model SOP Class N-EVENT-REPORT-SCP

Details regarding the Dataset Specific response behavior will be reported in this section.

Table 34: N-EVENT-REPORT-RSP Dataset Specification.

Storage Commitment Push Model SOP Class			
Attribute Name	Tag	VR	Comment
Sop Common Module			
SOP Class UID	0008,0016	UI	
SOP Instance UID	0008,0018	UI	

The details regarding the response behavior to status codes are provided in Table 35.

Table 35: Storage Commitment N-EVENT-REPORT Response Status Handling Behavior

Service Status	Error Code	Further Meaning	Behavior
Success	0000	Successful operation	The storage commitment result has been successfully received. The SCP has successfully stored the SOP Instances. The examination is marked as completed.

Table 36: Storage Commitment N-EVENT-REPORT Response Status

Event Type	Event Type ID	Behavior
Storage Commitment Request Successful	1	The Examination is marked as completed and it becomes a candidate for an automatic deletion from the local database if local resources become scarce.
Storage Commitment Request Complete – Failures Exist	2	The failure is reported to the operator by not marking the examination as completed. The operator may re-transfer the image data (which was previously transferred to the PACS).

4.2.1.14. (Real-World) Activity – FIND as SCU

4.2.1.14.1.1. Description and Sequencing of Activities

The operator is able to query a (pre-configured) remote database. The ACP AE initiates an association to the selected Remote AE and uses it to send C-FIND requests (and receive the associated find replies). For each query a number of C-FIND requests is established in one association to the peer entity, which is released when all query results are received. An example sequencing of Activities is presented in Figure 10 and Figure 11.

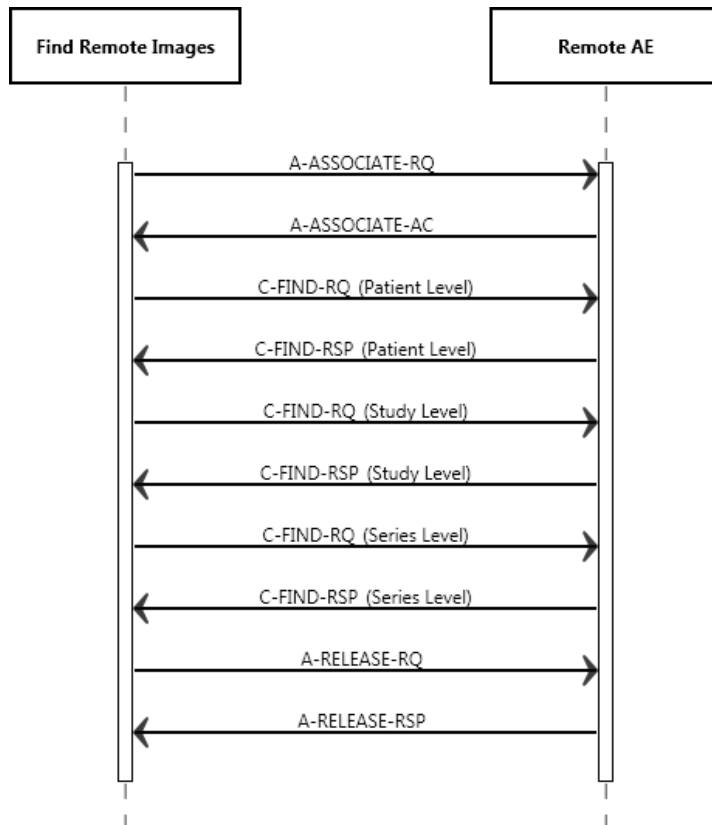

Figure 10: Sequencing of RWA (Patient Root Q/R Information Model)

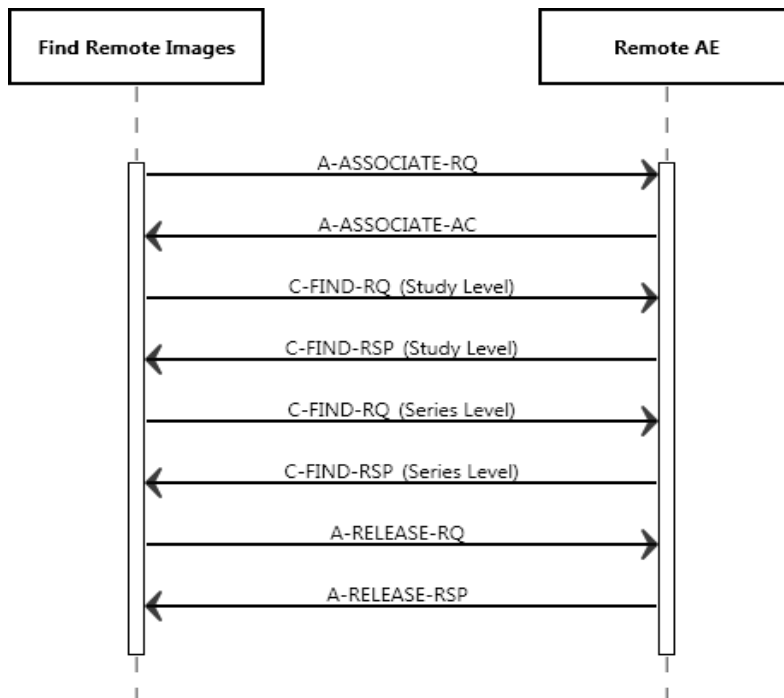

Figure 11: Sequencing of RWA (Study Root Q/R Information Model)

The clinical user may cancel the query to the PACS or Workstation. As a result, the Azurion R2.2 sends a C-FIND Cancel Request to the PACS or Workstation.

4.2.1.14.1.2. Proposed Presentation Contexts

Each time an association is initiated, the ACP AE proposes two presentation contexts to be used on that association. The presentation context proposed by the ACP AE for Find Remote Images is defined in Table 37.

Table 37: Proposed Presentation Contexts for (Real-World) Activity – FIND As SCU

Presentation Context Table					
Abstract Syntax		Transfer Syntax		Role	Extended Negotiation
Name	UID	Name	UID		
Patient Root QR Information Model – FIND SOP Class	1.2.840.10008.5.1.4.1.2.1.1	Implicit VR Little Endian	1.2.840.10008.1.2	SCU	None
		Explicit VR Little Endian	1.2.840.10008.1.2.1		
		Explicit VR Big Endian	1.2.840.10008.1.2.2		
Study Root QR Information Model – FIND SOP Class	1.2.840.10008.5.1.4.1.2.2.1	Implicit VR Little Endian	1.2.840.10008.1.2	SCU	None
		Explicit VR Little Endian	1.2.840.10008.1.2.1		
		Explicit VR Big Endian	1.2.840.10008.1.2.2		

4.2.1.14.1.3. SOP Specific Conformance for SOP Classes

The Azurion R2.2 provides standard conformance to this SOP class. The Azurion R2.2 AE does not generate queries containing optional keys and it does not generate relational queries.

4.2.1.14.1.3.1. Dataset Specific Conformance for Patient Root QR Information Model – FIND SOP Class C-FIND-SCU

In Table 37 the supported query keys for each query level are described. Universal matching is supported by default.

Table 38: Supported Query Keys for Patient Root Information Model

Patient Root Information Model				
Attribute Name	Tag	VR	Type Of Matching	Comment
Query/Retrieve Level	0008,0052	CS	Single Value	PATIENT, STUDY, SERIES
Specific Character Set	0008,0005	CS		
Q/R Patient Level				
Patient's Name	0010,0010	PN	Single value matching or wild card matching or universal matching	
Patient ID	0010,0020	LO	Single value matching or wild card matching or universal matching	
Patient's Birth Date	0010,0030	DA	Single value matching or universal matching	
Patient's Sex	0010,0040	CS	Universal matching only	
Q/R Study level				
Study Date	0008,0020	DA	Range matching or universal matching	
Study Time	0008,0030	TM	Universal matching only	
Accession Number	0008,0050	SH	Value matching or wild card matching or universal matching	
Query/Retrieve Level	0008,0052	CS	Single	
Modalities in Study	0008,0061	CS	Single	
Study Description	0008,1030)	LO	Universal matching	
Patient's Name	0010,0010	PN	Single value matching or wild card matching or universal matching	
Patient ID	0010,0020	LO	Single value matching or universal matching	
Patient's Birth Date	0010,0030	DA	Single value matching or universal matching	
Patient's Sex	0010,0040	CS	Universal matching only	
Patient Size	0010,1020	DS	Universal matching	
Patient Weight	0010,1030	DS	Universal matching	
Patient Comment	0010,4000	LT	Universal matching	
Study ID	0020,0010	SH	Universal matching only	
Study Instance UID	0020,000D	UI	Universal matching only	
Number Of Study Related Series	0020,1206	IS	Universal matching	
Q/R Series level				
Modality	0008,0060	CS	Universal matching only	
Series Description	0008,103E	LO	Universal matching	
Number Of Series Related Instances	0008,1050	PN	Universal matching only	
Study Instance UID	0020,000D	UI	Single value matching only	
Series Instance UID	0020,000E	UI	Universal matching only	
Series Number	0020,0011	IS	Universal matching only	

The behavior of the Azurion R2.2 for status codes in C-FIND response is summarized in Table 38.

Table 39: Status Response

Service Status	Error Code	Further Meaning	Behavior
Success	0000	Matching is complete – No final Identifier is supplied.	Stops with processing the C-Find Response(s) from the SCP. All results are displayed to the operator.
Refused	A700	Out of Resources	The association is released and the send job is marked as failed. An error message is logged.
Failed	A900	Identifier Does Not Match SOP Class	
	Cxxx	Unable to process	
Cancel	FE00	Matching terminated due to Cancel Match request	Stops with processing the C-Find Response(s) from the SCP. Results already received up to that point are displayed to the operator.
Pending	FF00	Matches are continuing – Current Match is supported in the same manner as supplied and any Optional Keys were Required Keys.	Continues with processing of the C-Find Response(s) from the SCP
	FF01	Matches are continuing – Warning that one or more Optional Keys were not supported for existence for this Identifier.	Continues with processing of the C-Find Response(s) from the SCP.
*	Any other status code	*	The association is aborted using A-ABORT. The reason is logged and the failure is reported to the user.

The behavior of the Azurion R2.2 during communication failure is summarized.

Table 40: DICOM Command Communication Failure Behavior

Exception	Behavior
Timeout	The send job is marked as failed. An error message is logged.
Association aborted	The send job is marked as failed. An error message is logged.
Association rejected	The send job is marked as failed. An error message is logged.

4.2.1.14.1.4. SOP Specific Conformance for Study Root QR Information Model – FIND SOP Class

The Azurion R2.2 provides standard conformance to this SOP class. The Azurion R2.2 AE does not generate queries containing optional keys and it does not generate relational queries.

4.2.1.14.1.4.1. Dataset Specific Conformance for Study Root QR Information Model – FIND SOP Class C-FIND-SCU

In table 40 the supported query keys for each query level are described. Universal matching is supported as default.

Table 41: Supported Query Keys for Study Root Information Model

Study Root Information Model				
Attribute Name	Tag	VR	Type Of Matching	Comment
Query/Retrieve Level	0008,0052	CS	Single Value	STUDY, SERIES
Specific Character Set	0008,0005	CS		
Q/R Study level				
Study Date	0008,0020	DA	Range matching or universal matching	
Study Time	0008,0030	TM	Universal matching only	
Accession Number	0008,0050	SH	Value matching or wild card matching or universal matching	
Query/Retrieve Level	0008,0052	CS	Single	STUDY
Modalities in Study	0008,0061	CS	Single	

Study Root Information Model				
Attribute Name	Tag	VR	Type Of Matching	Comment
Study Description	0008,1030)	LO	Universal matching	
Patient's Name	0010,0010	PN	Single value matching or wild card matching or universal matching	
Patient ID	0010,0020	LO	Single value matching or universal matching	
Patient's Birth Date	0010,0030	DA	Single value matching or universal matching	
Patient's Sex	0010,0040	CS	Universal matching only	
Patient Size	0010,1020	DS	Universal matching	
Patient Weight	0010,1030	DS	Universal matching	
Patient Comment	0010,4000	LT	Universal matching	
Study ID	0020,0010	SH	Universal matching only	
Study Instance UID	0020,000D	UI	Universal matching only	
Number Of Study Related Series	0020,1206	IS	Universal matching	
Referring Physician name	0008,0090	PN	Universal matching	
Q/R Series level				
Modality	0008,0060	CS	Universal matching only	
Series Description	0008,103E	LO	Universal matching	
Number Of Series Related Instances	0008,1050	PN	Universal matching only	
Study Instance UID	0020,000D	UI	Single value matching only	
Series Instance UID	0020,000E	UI	Universal matching only	
Series Number	0020,0011	IS	Universal matching only	

The behavior of the Azurion R2.2 for status codes in C-FIND response is summarized.

Table 42: Status Response

Se Status	Error Code	Further Meaning	Behavior
Success	0000	Matching is complete – No final Identifier is supplied.	Stops with processing the C-Find Response(s) from the SCP. All results are displayed to the operator.
Refused	A700	Out of Resources	The association is released and the send job is marked as failed. An error message is logged.
Failed	A900	Identifier Does Not Match SOP Class	
	Cxxx	Unable to process	
Cancel	FE00	Matching terminated due to Cancel Match request	Stops with processing the C-Find Response(s) from the SCP. Results already received up to that point are displayed to the operator.
Pending	FF00	Matches are continuing – Current Match is supported in the same manner as supplied and any Optional Keys were Required Keys.	Continues with processing of the C-Find Response(s) from the SCP
	FF01	Matches are continuing – Warning that one or more Optional Keys were not supported for existence for this Identifier.	Continues with processing of the C-Find Response(s) from the SCP.
*	Any other status code	*	The association is aborted using A-ABORT. The reason is logged and the failure is reported to the user.

The behavior of the Azurion R2.2 during communication failure is summarized in Table 43.

Table 43: DICOM Command Communication Failure Behavior

Exception	Behavior
Timeout	The send job is marked as failed. An error message is logged.
Association aborted	The send job is marked as failed. An error message is logged.
Association rejected	The send job is marked as failed. An error message is logged.

4.2.1.15. (Real-World) Activity – MOVE as SCU

4.2.1.15.1.1. Description and Sequencing of Activities

The request to move remote images is forwarded to the job queue. For each move job, one association towards the remote system is established, and C-MOVE requests are transmitted. Once the responses are received, the association is closed. An example of sequencing of activities is presented in Figure C-MOVE requests are done on the series level.

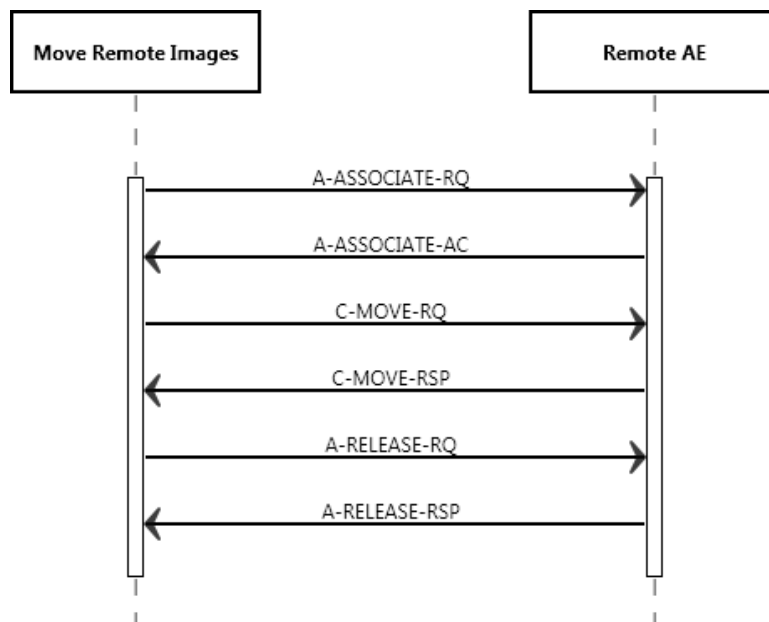

Figure 12: Sequencing of RWA

The clinical user may cancel the move operation. As a result, the Azurion R2.2 Sends a C-MOVE Cancel Request to the PACS or Workstation.

4.2.1.15.1.2. Proposed Presentation Contexts

The presentation contexts for MOVE as SCU are defined in table 44.

Table 44: Proposed Presentation Contexts for (Real-World) Activity – MOVE As SCU

Presentation Context Table					
Abstract Syntax		Transfer Syntax		Role	Extended Negotiation
Name	UID	Name List	UID List		
Patient Root QR Information Model – MOVE SOP Class	1.2.840.10008.5.1.4.1.2.1.2	Explicit VR Big Endian	1.2.840.10008.1.2.2	SCU	None
		Explicit VR Little Endian	1.2.840.10008.1.2.1		
		Implicit VR Little Endian	1.2.840.10008.1.2		

Presentation Context Table					
Abstract Syntax		Transfer Syntax		Role	Extended Negotiation
Name	UID	Name List	UID List		
Study Root QR Information Model – MOVE SOP Class	1.2.840.10008.5.1.4.1.2.2.2	Explicit VR Big Endian	1.2.840.10008.1.2.2	SCU	None
		Explicit VR Little Endian	1.2.840.10008.1.2.1		
		Implicit VR Little Endian	1.2.840.10008.1.2		

The implementation proposes each SOP Class only ones in the abstract syntax specifying all possible transfer syntaxes for that SOP Class. Due to the fact that the SCP has to react with a chosen transfer syntax, the per SOP Class used transfer syntax is forced by the SCP

4.2.1.15.1.3. SOP Specific Conformance for SOP Classes

Selecting a query result can retrieve only whole examinations. It is not possible to retrieve information if Patient ID contains the sign “greater than” or “less than” (> or <).

A C-MOVE can be done with the keys presented in Table 45 or Table 48.

4.2.1.15.1.4. SOP Specific Conformance for Patient Root QR Information Model – MOVE SOP Class

The Azurion R2.2 provides standard conformance for the Patient Root QR Information Model – MOVE SOP Class.

4.2.1.15.1.4.1. Dataset Specific Conformance for Patient Root QR Information Model – MOVE SOP Class C-MOVE-SCU

The behavior of the Identifiers for MOVE is summarized in this section.

Table 45: Identifiers for MOVE Patient Root Information Model as SCU

Patient Root Information Model			
Attribute Name	Tag	VR	Comment
Query/Retrieve Level	0008,0052	CS	Applied value: Series
Q/R Series level			
Patient ID	0010,0020	PN	
Study Instance UID	0020,000D	UI	
Series Instance UID	0020,000E	UI	

The DICOM C-MOVE Patient Root Information Model Command Status Response Handling is shown in the Table 46.

Table 46: Status Response for C-MOVE Patient Root Information Model

Service Status	Error Code	Further Meaning	Behavior
Success	0000	Sub-operations Complete No Failures	The move job is marked as completed. The association is released. Success is logged.
Refused	A701	Out of Resources – Unable to calculate number of matches	The association is released and the send job is marked as failed. An error message is logged. The reason is logged and reported to the user.
	A702	Out of Resources – Unable to perform sub operations	
	A801	Move Destination Unknown	
Failed	A900	Identifier Does Not Match SOP Class	The association is released and the send job is marked as failed. An error message is logged
	Cxxx	Unable to process	
Cancel	FE00	Sub-operations terminated due to Cancel Indication	The move job is marked as cancelled. The association is released. The reason is logged and reported to the user.

Service Status	Error Code	Further Meaning	Behavior
Warning	B000	Sub-operations Complete – One or more Failures	The association is released and the send job is marked as failed. An error message is logged
*	Any other status code	*	The association is released and the send job is marked as failed. An error message is logged

The possible Communication Failures during a C-MOVE as SCU are shown in the Table 47.

Table 47: DICOM Command Communication Failure Behavior for C-MOVE Patient Root Information Model.

Exception	Behavior
Timeout	The send job is marked as failed. An error message is logged.
Association aborted	The send job is marked as failed. An error message is logged.
Association rejected	The send job is marked as failed. An error message is logged.

4.2.1.15.1.5. SOP Specific Conformance for Study Root QR Information Model – MOVE SOP Class

The Azurion R2.2 provides standard conformance to this SOP class.

4.2.1.15.1.5.1. Dataset Specific Conformance for Study Root QR Information Model – MOVE SOP Class C-MOVE-SCU

The identifiers for C-MOVE as SCU are listed in the Table 48.

Table 48: Identifiers for MOVE Study Root Information Model as SCU

Study Root Information Model			
Attribute Name	Tag	VR	Comment
Query/Retrieve Level	0008,0052	CS	Applied value: SERIES
Q/R Series level			
Series Instance UID	0020,000E	UI	
Study Instance UID	0020,000D	UI	

The DICOM C-MOVE Study Root Information Model Command Status Response Handling is shown in the Table 49.

Table 49: Status response for Study Root Information Model C-MOVE-SCU.

Service Status	Error Code	Further Meaning	Behavior
Success	0000	Sub-operations Complete – No Failures	The SCP has successfully stored the SOP Instances. If all SOP Instances in a send job have status success then the job is marked as completed. Success is logged.
Refused	A701	Out of Resources – Unable to calculate number of matches	The association is released and the send job is marked as failed. An error message is logged.
	A702	Out of Resources – Unable to perform sub operations	
	A801	Move Destination Unknown	
Failed	A900	Identifier Does Not Match SOP Class	The association is released and the send job is marked as failed.

Service Status	Error Code	Further Meaning	Behavior
	Cxxx	Unable to process	An error message is logged.
Cancel	FE00	Sub-operations terminated due to Cancel Indication	The move job is marked as cancelled. The association is released. The reason is logged and reported to the user.
Warning	B000	Sub-operations Complete – One or more Failures	The association is released and the send job is marked as failed. An error message is logged.
*	Any other Status code	*	The association is released and the send job is marked as failed. An error message is logged.

The possible Communication Failures for C-MOVE-SCU are shown in the table 50.

Table 50: DICOM Command Communication Failure Behavior for Study Root Information Model C-MOVE-SCU

Exception	Behavior
Timeout	The send job is marked as failed. An error message is logged.
Association aborted	The send job is marked as failed. An error message is logged.
Association rejected	The send job is marked as failed. An error message is logged.

4.2.1.16. (Real-World) Activity – Print Management as SCU

4.2.1.16.1.1. Description and Sequencing of Activities

The operator can select images and request them to be printed on a printer (out of choice list of configured printers). Each request is forwarded to the job queue and processed as individual request to Print Images. The print job consists of data describing the images and graphics to be printed as well as the requested layout and other parameters. One print job on Azurion R2.2 may result in a number of film sessions with the printer equal to the number of printed film sheets. Each film sheet within the print job is internally processed, converted to a STANDARD/1, 1 page and then an association towards the remote Print Server is established and the page image is sent to that Print Server. Once the transmission of the film sheet is completed, the association is closed. A sequence of interactions between the Azurion R2.2 and a remote AE to print one film sheet is presented in Figure 13.

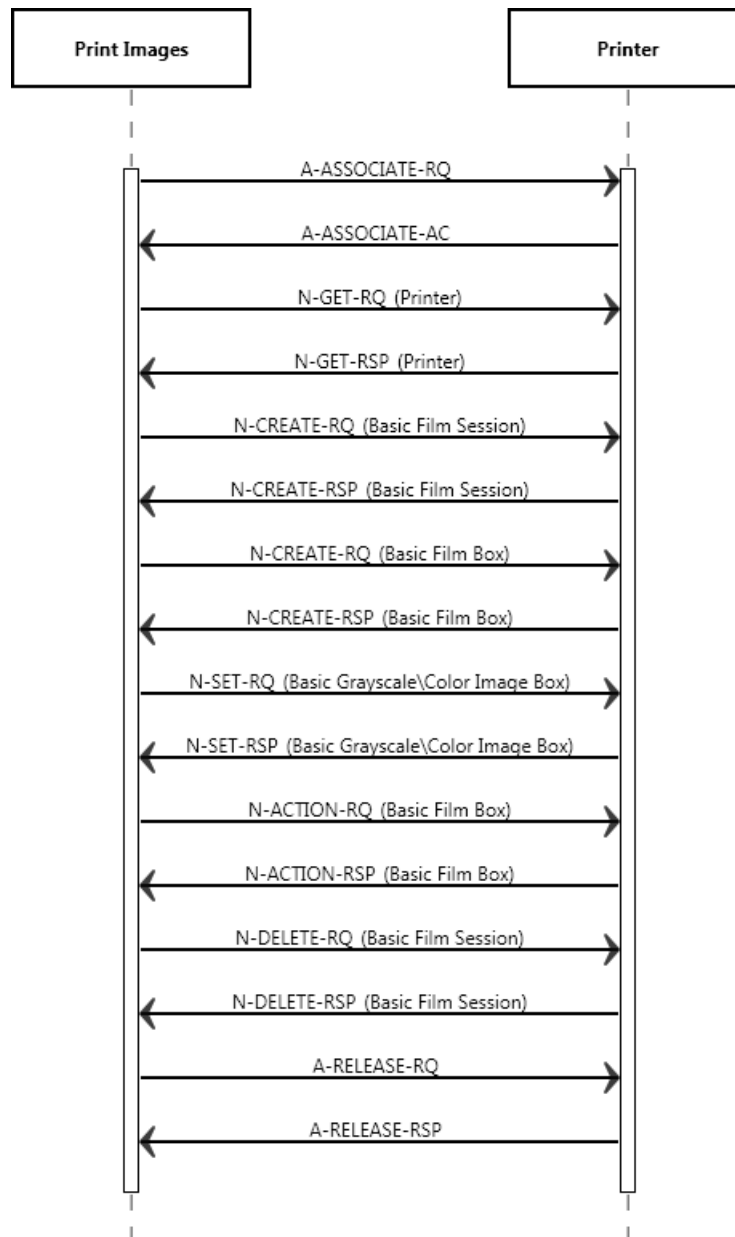

Figure 13: Sequencing of RWA Print Images

The following implementation remarks are important to achieve successful printing:

- Each film session will be in a single association with one or more film boxes and one or more film sheets
- The number of images per Film Box is one. The images to be printed on one film are rendered by the Azurion R2.2 into one logical image. This logical image is very large, depending on the pixel matrix size (pixels per line, lines per image). A rough indication is 20 Mbytes. One should take this into account when selecting the DICOM printer and the printer configuration (e.g. the amount of memory).
- The Azurion R2.2 will request for releasing the association when the print command is given (i.e. the N-ACTION Request). The association is not kept open for receiving N-EVENT-REPORTs of the Printer SOP Class.

Table 51: The Applied Order of Print Service Elements

Service Element of SOP Class	Description
N-GET of the Printer SOP Class	Purpose is to retrieve printer information.
N-CREATE of the Basic Film Session SOP Class	Specifies the DICOM Printer about some general presentation parameters, applicable for all films in the Film Session. Applied attributes are: Number of Copies, Print Priority, Medium Type, Film Destination
N-CREATE of the Basic Film Box SOP Class	Specifies the DICOM Printer about some general presentation parameters, applicable for all images in the Film Box. Applied attributes are: Film Orientation, Film Size ID, Magnification Type, Max. Density, Configuration Information, Trim.
N-SET of the Basic Grayscale Image Box SOP Class	Images to be printed. Applied attributes are: Polarity
N-ACTION of the Basic Film Box SOP Class	Triggers the DICOM Printer to print. This actual print action is done at film box level. No attributes are present.

Table 52: Media Services

Service Element of SOP Class	Description
N-EVENT-REPORT of the Printer SOP Class	When N-EVENT-REPORT is received, no printer status polling on a separate connection is executed.

4.2.1.16.1.2. Proposed Presentation Contexts

Each time an association is initiated, the Azurion R2.2 proposes presentation contexts to be used on that association. The presentation contexts proposed by the Azurion R2.2 for Print Images is defined in Table 53.

The implementation proposes the SOP Class only ones in the abstract syntax specifying all possible transfer syntaxes for that SOP Class. Due to the fact that the SCP has to react with a chosen transfer syntax, as per SOP Class used transfer syntax is forced by the SCP.

Table 53: Proposed Presentation Contexts for (Real-World) Activity – Print Management as SCU

Presentation Context Table					
Abstract Syntax		Transfer Syntax		Role	Extended Negotiation
Name	UID	Name	UID		
Basic Grayscale Print Management Meta SOP Class	1.2.840.10008.5.1.1.9	Implicit VR Little Endian	1.2.840.10008.1.2	SCU	None
		Explicit VR Little Endian	1.2.840.10008.1.2.1		
		Explicit VR Big Endian	1.2.840.10008.1.2.2		
>Basic Film Session SOP Class	1.2.840.10008.5.1.1.1	Implicit VR Little Endian	1.2.840.10008.1.2	SCU	None
		Explicit VR Little Endian	1.2.840.10008.1.2.1		
		Explicit VR Big Endian	1.2.840.10008.1.2.2		
>Basic Film Box SOP Class	1.2.840.10008.5.1.1.2	Implicit VR Little Endian	1.2.840.10008.1.2	SCU	None
		Explicit VR Little Endian	1.2.840.10008.1.2.1		
		Explicit VR Big Endian	1.2.840.10008.1.2.2		
>Basic Grayscale Image Box SOP Class	1.2.840.10008.5.1.1.4	Implicit VR Little Endian	1.2.840.10008.1.2	SCU	None
		Explicit VR Little Endian	1.2.840.10008.1.2.1		
		Explicit VR Big Endian	1.2.840.10008.1.2.2		
>Printer SOP Class	1.2.840.10008.5.1.1.16	Implicit VR Little Endian	1.2.840.10008.1.2	SCU	None
		Explicit VR Little Endian	1.2.840.10008.1.2.1		
		Explicit VR Big Endian	1.2.840.10008.1.2.2		
Basic Color Print	1.2.840.10008.5.1.1.18	Implicit VR Little Endian	1.2.840.10008.1.2	SCU	None

Presentation Context Table					
Abstract Syntax		Transfer Syntax		Role	Extended Negotiation
Name	UID	Name	UID		
Management Meta SOP Class		Explicit VR Little Endian	1.2.840.10008.1.2.1		
		Explicit VR Big Endian	1.2.840.10008.1.2.2		
>Basic Film Session SOP Class	1.2.840.10008.5.1.1.1	Implicit VR Little Endian	1.2.840.10008.1.2	SCU	None
		Explicit VR Little Endian	1.2.840.10008.1.2.1		
		Explicit VR Big Endian	1.2.840.10008.1.2.2		
>Basic Film Box SOP Class	1.2.840.10008.5.1.1.2	Implicit VR Little Endian	1.2.840.10008.1.2	SCU	None
		Explicit VR Little Endian	1.2.840.10008.1.2.1		
		Explicit VR Big Endian	1.2.840.10008.1.2.2		
>Basic Color Image Box SOP Class	1.2.840.10008.5.1.1.4.1	Implicit VR Little Endian	1.2.840.10008.1.2	SCU	None
		Explicit VR Little Endian	1.2.840.10008.1.2.1		
		Explicit VR Big Endian	1.2.840.10008.1.2.2		
>Printer SOP Class	1.2.840.10008.5.1.1.16	Implicit VR Little Endian	1.2.840.10008.1.2	SCU	None
		Explicit VR Little Endian	1.2.840.10008.1.2.1		
		Explicit VR Big Endian	1.2.840.10008.1.2.2		

4.2.1.16.1.3. SOP Specific Conformance for Basic Film Session SOP Class for Basic Grayscale Print Meta

The Azurion R2.2 provides standard conformance to the Basic Grayscale Print Management Meta SOP Class. A description and the applied optional (i.e. non-mandatory attributes as Print SCU) attributes in these Service Elements are specified as well. Note that the Service Elements order is not specified by the DICOM standard. Azurion R2.2 sends the N-DELETE request for the film session. Overlay, annotation (showing the values of some major identifying attributes) and shutter information is processed in the images sent to the printer, all the processing including annotations will be part of the image.

This section and sub-section include the manufacturer SOP and Dataset specific information as well the status codes and their corresponding behavior.

4.2.1.16.1.3.1. Dataset Specific Conformance for Basic Film Session SOP Class for Basic Grayscale Print Meta N-CREATE-SCU

Table 54: N-CREATE-RQ Dataset Specification.

Attribute Name	Tag	VR	Value	Presence of Value	Source	Comment
Number of Copies	2000,0010	IS	Between 1 and 100	ALWAYS	USER	
Print Priority	2000,0020	CS	MED	ALWAYS	AUTO	
Medium Type	2000,0030	CS	PAPER, BLUE FILM, CLEAR FILM	ALWAYS	USER	
Film Destination	2000,0040	CS	MAGAZINE, PROCESSOR	ALWAYS	AUTO	
Film Session Label	2000,0050	LO	Human readable label that identifies the film session	ANAP	AUTO	

The details regarding the response behaviour to status codes are provided in Table 55.

Table 55: Status Response

Service Status	Error Code	Further Meaning	Behavior
Success	0000	Successful operation	The print job continues.
Warning	0116	Any warning	The print job continues and the warning is logged.
Error	0105	Any error	The association is aborted using A-ABORT. The print job will keep resubmitting the failed sheets until the

			error is solved or the retry timeout is exceeded.
	0106	Any error	The association is aborted using A-ABORT. The print job will keep resubmitting the failed sheets until the error is solved or the retry timeout is exceeded.

4.2.1.16.1.4. SOP Specific Conformance for Basic Film Box SOP Class for Basic Grayscale Print Meta

4.2.1.16.1.4.1. Dataset Specific Conformance for Basic Film Box SOP Class for Basic Grayscale Print Meta N-CREATE-SCU

The behavior of the Azurion R2.2 for status codes in an N-CREATE response is summarized in Table 56.

Table 56: N-CREATE-RQ Dataset Specification.

Attribute Name	Tag	VR	Value	Presence of Value	Source	Comment
Image Display Format	2010,0010	ST	STANDARD\1,1			
Workstation Format	2010,0010	ST	STANDARD\C,R, CUSTOM\i	ANAP	AUTO	
Film Orientation	2010,0040	CS	PORTRAIT, LANDSCAPE	ANAP	USER	
Film Size ID	2010,0050	CS	DICOM specifies a number of Defined Terms; more values are possible and is print configuration dependent.	ANAP	USER	
Border Density	2010,0100	CS	BLACK			
Magnification Type	2010,0060	CS	Normally sent out, however sometimes send out empty Because some DICOM printers are not able to handle (Value NONE for) this attribute. Applied value(s): NONE	ANAP	AUTO	
Max Density	2010,0130	US	Maximum density of the images on the film, expressed in hundredths of OD. If Max Density is higher than maximum printer density than Max Density is set to maximum printer density.	ANAP	AUTO	
Trim	2010,0140	CS	NO	ANAP	AUTO	
Configuration Information	2010,0150	ST	Contains a vendor specific Lookup-table (LUT); should be applied by the DICOM printer if LUT data is present.	ANAP	AUTO	
Illumination	2010,015E	US		ANAP		
Reflected Ambient Light	2010,0160	US		ANAP		
Referenced Film Session Sequence	2010,0500	SQ		ANAP	AUTO	
>Referenced SOP Class UID	0008,1150	UI		ALWAYS		
>Referenced SOP Instance UID	0008,1155	UI		ALWAYS		
Referenced Presentation LUT Sequence	2050,0500	SQ		ANAP	AUTO	

The details regarding the response behaviour to status codes are provided in Table 57.

Table 57: Status Response

Service Status	Error Code	Further Meaning	Behavior
Success	0000	Successful operation	The print job continues.
Warning	0116	Any warning	The print job continues and the warning is logged.
Error	0105	Any error	The association is aborted using A-ABORT. The print job will keep resubmitting the failed sheets until the error is solved or the retry timeout is exceeded.
	0106	Any error	The association is aborted using A-ABORT. The print job will keep resubmitting the failed sheets until the error is solved or the retry timeout is exceeded.

4.2.1.16.1.5. SOP Specific Conformance for Basic Grayscale Image Box SOP Class for Basic Grayscale Print Meta

4.2.1.16.1.5.1. Dataset Specific Conformance for Basic Grayscale Image Box SOP Class for Basic Grayscale Print Meta N-SET-SCU

This application entity supports the attributes described in the table 58.

Table 58: N-SET-RQ Dataset Specification.

Attribute Name	Tag	VR	Value	Presence of Value	Source	Comment
SOP Class UID	0008,0016	UI		ALWAYS		
SOP Instance UID	0008,0018	UI		ALWAYS		
Image Box Position	2020,0010	US	1	ANAP	AUTO	
Polarity	2020,0020	CS	NORMAL	ANAP	AUTO	
Basic Grayscale Image Sequence	2020,0110	SQ		ANAP		
>Samples Per Pixel	0028,0002	US	1	ANAP	AUTO	
>Photometric Interpretation	0028,0004	CS	MONOCHROME2	ANAP	AUTO	
>Rows	0028,0010	US	Depending on the selected printer type and film size.	ANAP	AUTO	
>Columns	0028,0011	US	Depending on the selected printer type and film size.	ANAP	AUTO	
>Pixel Aspect Ratio	0028,0034	IS		ANAP		
>Bits Allocated	0028,0100	US	8 or 16	ANAP	AUTO	
>Bits Stored	0028,0101	US	8 or 12	ANAP	AUTO	
>High Bit	0028,0102	US	7 or 11	ANAP	AUTO	
>Pixel Representation	0028,0103	US	0X0000	ANAP	AUTO	
>Pixel Data	7FE0,0010	OW/OB		ANAP	AUTO	
Image Box Position	2020,0010	US		ALWAYS	AUTO	
Polarity	2020,0020	CS		ALWAYS	AUTO	
Basic Grayscale Image Sequence	2020,0110	SQ		ALWAYS	AUTO	

The details regarding the response behaviour to status codes are provided in Table 59.

Table 59: Status Response

Service Status	Error Code	Further Meaning	Behavior
Success	0000	Successful operation	The print job continues.
Warning	0107	Any warning	The print job continues and the warning is logged.

Error	0105	Any error	The association is aborted using A-ABORT. The print job will keep resubmitting the failed sheets until the error is solved or the retry timeout is exceeded.
	0106	Any error	The association is aborted using A-ABORT. The print job will keep resubmitting the failed sheets until the error is solved or the retry timeout is exceeded.

4.2.1.16.1.6. SOP Specific Conformance for Basic Grayscale Image Box SOP Class for Basic Grayscale Print Meta

4.2.1.16.1.6.1. Dataset Specific Conformance for Printer SOP Class for Basic Grayscale Print Meta N-GET-SCU

This application entity supports the attributes described in the Table 60.

Table 60: N-GET-RQ Dataset Specification.

Attribute Name	Tag	VR	Value	Presence of Value	Source	Comment
SOP Class UID	0008,0016	UI		ALWAYS	AUTO	
SOP Instance UID	0008,0018	UI		ALWAYS	AUTO	
Printer Status	2110,0010	CS		ANAP	AUTO	
Printer Status Info	2110,0020	CS		ANAP	AUTO	
Print Priority	2000,0020	CS		ALWAYS	AUTO	
Execution Status	2100,0020	CS		ALWAYS	AUTO	
Execution Status Info	2100,0030	CS		ALWAYS	AUTO	

4.2.1.16.1.6.2. Dataset Specific Conformance for Printer SOP Class for Basic Grayscale Print Meta N-EVENT-REPORT-SCP

This application entity supports the attributes described in the next table.

Table 61: N-EVENT-REPORT-RSP Dataset Specification.

Attribute Name	Tag	VR	Value	Presence of Value	Source	Comment
SOP Class UID	0008,0016	UI		ALWAYS	AUTO	
SOP Instance UID	0008,0018	UI		ALWAYS	AUTO	
Printer Status	2110,0010	CS		ANAP	AUTO	
Printer Status Info	2110,0020	CS		ANAP	AUTO	

4.2.1.16.1.7. SOP Specific Conformance for Basic Color Print Management Meta SOP Class

The Azurion R2.2 provides standard conformance to the Basic Color Print Management Meta SOP Class. A description and the applied optional (i.e. non-mandatory attributes as Print SCU) attributes in these Service Elements are specified as well. Note that the Service Elements order is not specified by the DICOM standard. Azurion R2.2 sends the N-DELETE request for the film session. Overlay, annotation (showing the values of some major identifying attributes) and shutter information is processed in the images sent to the printer, all the processing including annotations will be part of the image.

4.2.1.16.1.7.1. SOP Specific Conformance for Basic Film Session SOP Class for Basic Color Print Meta

4.2.1.16.1.7.1.1. Dataset Specific Conformance for Basic Film Session SOP Class for Basic Color Print Meta N-CREATE-SCU

This application entity supports the attributes described in the Table 62.

Table 62: N-CREATE-RQ Dataset Specification.

Attribute Name	Tag	VR	Value	Presence of Value	Source	Comment
Number of Copies	2000,0010	IS	Between 1 and 100	ALWAYS	USER	
Print Priority	2000,0020	CS	MED	ALWAYS	AUTO	

Medium Type	2000,0030	CS	PAPER, BLUE FILM, CLEAR FILM	ALWAYS	USER	
Film Destination	2000,0040	CS	MAGAZINE, PROCESSOR	ALWAYS	AUTO	
Film Session Label	2000,0050	LO	Human readable label that identifies the film session	ANAP	AUTO	

The details regarding the response behaviour to status codes are provided in Table 63.

Table 63: Status Response

Service Status	Error Code	Further Meaning	Behavior
Success	0000	Successful operation	The print job continues.
Warning	0107	Any warning	The print job continues and the warning is logged.
Error	0105	Any error	The association is aborted using A-ABORT. The print job will keep resubmitting the failed sheets until the error is solved or the retry timeout is exceeded.
	0106	Any error	The association is aborted using A-ABORT. The print job will keep resubmitting the failed sheets until the error is solved or the retry timeout is exceeded.

4.2.1.16.1.7.2. SOP Specific Conformance for Basic Film Box SOP Class for Basic Color Print Meta

4.2.1.16.1.7.2.1. Dataset Specific Conformance for Basic Film Box SOP Class for Basic Color Print Meta N-CREATE-SCU

The behavior of the Azurion R2.2 for status codes in an N-CREATE response is summarized in Table 64.

Table 64: N-CREATE-RQ Dataset Specification.

Attribute Name	Tag	VR	Value	Presence of Value	Source	Comment
SOP Class UID	0008,0016	UI		ALWAYS	AUTO	
SOP Instance UID	0008,0018	UI		ALWAYS	AUTO	
Workstation Format	2010,0010	ST	STANDARDIC, R, CUSTOMi	ALWAYS	AUTO	
Film Orientation	2010,0040	CS	PORTRAIT, LANDSCAPE	ALWAYS	USER	
Film Size ID	2010,0050	CS	DICOM specifies a number of Defined Terms; more values are possible and is print configuration dependent.	ALWAYS	USER	
Magnification Type	2010,0060	CS	Normally sent out, however sometimes send out empty Because some DICOM printers are not able to handle (Value NONE for) this attribute. Applied value(s): NONE	ALWAYS	AUTO	
Max Density	2010,0130	US	Maximum density of the images on the film, expressed in hundredths of OD. If Max Density is higher than maximum printer density than Max Density is set to maximum printer density.	ALWAYS	AUTO	
Trim	2010,0140	CS	NO	ALWAYS	AUTO	
Configuration Information	2010,0150	ST	Contains a vendor specific Lookup-table (LUT); should	ALWAYS	AUTO	

Attribute Name	Tag	VR	Value	Presence of Value	Source	Comment
			be applied by the DICOM printer if LUT data is present.			
Reflected Ambient Light	2010,0160	US		VNAP		
Referenced Film Session Sequence	2010,0500	SQ	Parent Film Session	ALWAYS	AUTO	
>Referenced SOP Class UID	0008,1150	UI	1.2.840.10008.5.1.1.1	ALWAYS	AUTO	
>Referenced SOP Instance UID	0008,1155	UI	UID of Parent Film Session	ALWAYS	AUTO	
Referenced Image Box Sequence	2010,0510	SQ		ALWAYS		
Referenced Basic Annotation Box Sequence	2010,0520	SQ		VNAP		
Referenced Presentation LUT Sequence	2050,0500	SQ		VNAP		

The details regarding the response behaviour to status codes are provided in Table 65.

Table 65: Status Response

Service Status	Error Code	Further Meaning	Behavior
Success	0000	Successful operation	The print job continues.
Warning	0107	Any warning	The print job continues and the warning is logged.
Error	0105	Any error	The association is aborted using A-ABORT. The print job will keep resubmitting the failed sheets until the error is solved or the retry timeout is exceeded.
	0106	Any error	The association is aborted using A-ABORT. The print job will keep resubmitting the failed sheets until the error is solved or the retry timeout is exceeded.

4.2.1.16.1.7.2.2. Dataset Specific Conformance for Basic Film Box SOP Class for Basic Color Print Meta N-ACTION-SCU

The behavior of the Azurion R2.2 for status codes in an N-ACTION response is summarized in Table 66.

Table 66: N-ACTION-RQ Dataset Specification.

Attribute Name	Tag	VR	Value	Presence of Value	Source	Comment
SOP Class UID	0008,0016	UI		ALWAYS	AUTO	
SOP Instance UID	0008,0018	UI		ALWAYS	AUTO	

4.2.1.16.1.7.3. SOP Specific Conformance for Basic Color Image Box SOP Class for Basic Color Print Meta

4.2.1.16.1.7.3.1. Dataset Specific Conformance for Basic Color Image Box SOP Class for Basic Color Print Meta N-SET-SCU

This application entity supports the attributes described in the Table 67.

Table 67: N-SET-RQ Dataset Specification.

Attribute Name	Tag	VR	Value	Presence of Value	Source	Comment
SOP Class UID	0008,0016	UI		ALWAYS	AUTO	

Attribute Name	Tag	VR	Value	Presence of Value	Source	Comment
SOP Instance UID	0008,0018	UI		ALWAYS	AUTO	
Image Box Position	2020,0010	US		ANAP	AUTO	
Polarity	2020,0020	CS		ANAP	AUTO	
Samples Per Pixel	0028,0002	US		ANAP	AUTO	
Photometric Interpretation	0028,0004	CS		ANAP	AUTO	
Rows	0028,0010	US		ANAP	AUTO	
Columns	0028,0011	US		ANAP	AUTO	
Pixel Aspect Ratio	0028,0034	IS		ANAP	AUTO	
Bits Allocated	0028,0100	US		ANAP	AUTO	
Bits Stored	0028,0101	US		ANAP	AUTO	
High Bit	0028,0102	US		ANAP	AUTO	
Pixel Representation	0028,0103	US		ANAP	AUTO	
Pixel Data	7FE0,0010	OW/OB		ANAP	AUTO	

The details regarding the response behaviour to status codes are provided in Table 68.

Table 68: Status Response

Service Status	Error Code	Further Meaning	Behavior
Success	0000	Successful operation	The print job continues.
Warning	0107	Any warning	The print job continues and the warning is logged.
Error	0105	Any error	The association is aborted using A-ABORT. The print job will keep resubmitting the failed sheets until the error is solved or the retry timeout is exceeded.
	0106	Any error	The association is aborted using A-ABORT. The print job will keep resubmitting the failed sheets until the error is solved or the retry timeout is exceeded.

4.2.1.16.1.7.4. SOP Specific Conformance for Basic Color Image Box SOP Class for Basic Color Print Meta

4.2.1.16.1.7.4.1. Dataset Specific Conformance for Printer SOP Class for Basic Color Print Meta N-EVENT-REPORT-SCP

This application entity supports the attributes described in the Table 69.

Table 69: N-EVENT-REPORT-RSP Dataset Specification.

Attribute Name	Tag	VR	Value	Presence of Value	Source	Comment
SOP Class UID	0008,0016	UI		ALWAYS	AUTO	
SOP Instance UID	0008,0018	UI		ALWAYS	AUTO	

4.2.1.17. Association Acceptance Policy

The Application Entity will respond to a received Association rejection as shown in the Table 70.

Table 70: Association Rejection response

Result	Source	Reason/Diagnosis	Behaviour
1-rejected-permanent	1-DICOM UL service-user	1-no-reason-given	Log entry

Result	Source	Reason/Diagnosis	Behaviour
		2-application-context-name-not-supported	Log entry
		3-calling-AE-title-not-recognized	Log entry
		7-called- AE-title-not-recognized	Log entry
	2-DICOM UL service-provider (ACSE related function)	1-no-reason-given	Log entry
		2-no-reason-given	Log entry
	3-DICOM UL service-provider (Presentation related function)	1-temporary-congestion	Log entry
		2-local-limit-exceeded	Log entry
2-rejected-transient	1-DICOM UL service-user	1-no-reason-given	Log entry
		2-application-context-name-not-supported	Log entry
		3-calling-AE-title-not-recognized	Log entry
		7-called- AE-title-not-recognized	Log entry
	2-DICOM UL service-provider (ACSE related function)	1-no-reason-given	Log entry
		2-no-reason-given	Log entry
	3-DICOM UL service-provider (Presentation related function)	1-temporary-congestion	Log entry
		2-local-limit-exceeded	Log entry

The behavior of the Azurion R2.2 during Abort Handling is summarized in Table 71.

Table 71: Association Abort Handling

Source	Reason/Diagnosis	Behaviour
0 – DICOM UL service-user	0 – reason-not-specified	Log entry
2 – DICOM UL service-provider	0 – reason-not-specified	Log entry
	1 – unrecognized-PDU	Log entry
	2 – unexpected-PDU	Log entry
	4 – unrecognized-PDU-parameter	Log entry
	5 – unexpected-PDU-parameter	Log entry
	6 – invalid-PDU-parameter-value	Log entry

4.2.1.18. (Real-World) Activity – Verification as SCP

4.2.1.18.1.1. Description and Sequencing of Activities

A remote system requests verification from Azurion R2.2 using the C-ECHO command.

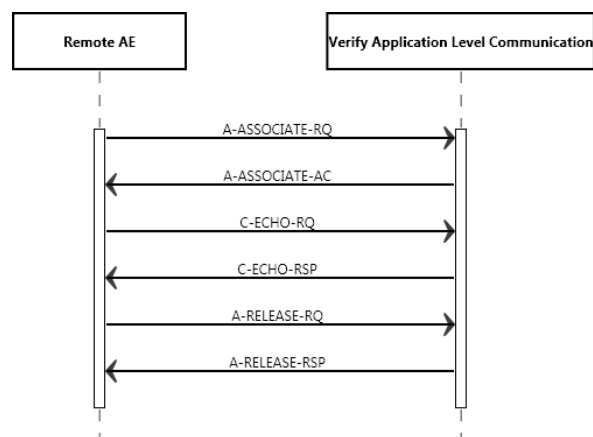

Figure 14: (Real World) Activity – Verification as SCP Accepted Presentation Contexts

The presentation contexts are defined in next table.

Table 72: Acceptable Presentation Contexts for (Real-World) Activity – Verification as SCP

Presentation Context Table					
Abstract Syntax		Transfer Syntax		Role	Extended Negotiation
Name	UID	Name List	UID List		
Verification SOP Class	1.2.840.10008.1.1	Explicit VR Little Endian	1.2.840.10008.1.2.1	SCP	None
		Implicit VR Little Endian	1.2.840.10008.1.2		

4.2.1.18.1.2. SOP Specific Conformance for Verification SOP Class

Azurion R2.2 (C-ECHO SCP) provides standard conformance to the DICOM V3.0 verification SOP Class.

4.2.1.18.1.2.1. Dataset Specific Conformance for Verification C-ECHO SCP

This part of the section includes the dataset specific behavior, i.e. error codes, error and exception handling, time-outs, etc.

Table 73: Status Response

Service Status	Error Code	Further Meaning	Behavior
Success	0000	Success	C-ECHO command was successful received.

4.2.1.19. (Real-World) Activity – Image Import

4.2.1.19.1.1. Description and Sequencing of Activities

The real world activity associated with the C-STORE operation is the storage of the image in the memory of the system upon which Azurion R2.2 is running in order to make it available for immediate processing by applications. Azurion R2.2 will issue a failure status if it is unable to store the image in the memory.

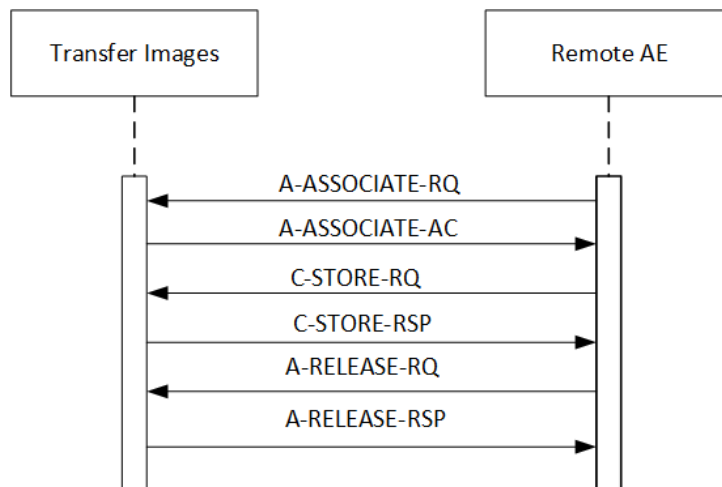

Figure 15: (Real World) Activity – Image Import.

4.2.1.19.1.2. Accepted Presentation Contexts

The presentation contexts are defined in the Table 74.

Table 74: Acceptable Presentation Contexts for (Real-World) Activity – Image Import

Presentation Context Table					
Abstract Syntax		Transfer Syntax		Role	Extended Negotiation
Name	UID	Name List	UID List		
Secondary Capture Image Storage SOP Class	1.2.840.10008.5.1.4.1.1.7	Implicit VR Little Endian	1.2.840.10008.1.2	SCP	None
		Explicit VR Little Endian	1.2.840.10008.1.2.1		
		Explicit VR Big Endian	1.2.840.10008.1.2.2		
		JPEG Lossless, Non-Hierarchical, First-Order Prediction (Process 14)	1.2.840.10008.1.2.4.70		
Grayscale Softcopy Presentation State Storage SOP Class	1.2.840.10008.5.1.4.1.1.11.1	Implicit VR Little Endian	1.2.840.10008.1.2	SCP	None
		Explicit VR Little Endian	1.2.840.10008.1.2.1		
		Explicit VR Big Endian	1.2.840.10008.1.2.2		
X-Ray Angiographic Image Storage SOP Class	1.2.840.10008.5.1.4.1.1.12.1	Implicit VR Little Endian	1.2.840.10008.1.2	SCP	None
		Explicit VR Little Endian	1.2.840.10008.1.2.1		
		Explicit VR Big Endian	1.2.840.10008.1.2.2		
		JPEG Lossless, Non-Hierarchical, First-Order Prediction (Process 14)	1.2.840.10008.1.2.4.70		

4.2.1.19.1.3. SOP Specific Conformance for Storage SOP Classes

This section and sub-section includes the manufacturer SOP and Dataset specific information as well the status codes and their corresponding behavior.

Azurion R2.2 provides standard conformance to the DICOM V3.0 Storage Service Class as a SCP. Azurion R2.2 conforms to the SOPs of the Storage Service Class at Level 2 (Full). In case of a successful C-STORE, the stored image may be accessed by the processing applications.

4.2.1.19.1.3.1. Dataset Specific Conformance for C-STORE-RSP

This includes the dataset specific behavior, i.e. error codes, error and exception handling, time-outs, etc.

Table 75: Status Response

Service Status	Error Code	Further Meaning	Behavior
Success	0000	Successful stored	Whenever the store operation succeeded.
Failure	Cxxx	Failed	Whenever the store operation failed.

4.3. Network Interfaces

4.3.1. Physical Network Interfaces

The System provides only DICOM V3.0 TCP/IP Network Communication Support as defined in PS 3.8 of the standard. TCP/IP is the only protocol stack supported.

Supported physical medium include:

- IEEE 802.3-1995, 10BASE-T
- IEEE 802.3-1995, 100BASE-TX (Fast Ethernet)
- IEEE 802.3, 1000BASE-X (Fiber Optic Gigabit Ethernet).

The TCP/IP Stack as supported by the underlying Operating System. The API is the WinSock 2 interface as supported by the underlying Operating System.

4.3.2. Additional Protocols

4.3.2.1. Basic TLS Secure Transport Connection Profile

Azurion R2.2 conforms to the Basic TLS Secure Transport Connection Profile.

4.3.2.2. Basic Application Level Confidentiality Profile

See Section 7.1.5.

4.3.3. Ipv4 and Ipv6 Support

Azurion R2.2 Supports Ipv4 and Ipv6.

4.4. Configuration

Any implementation's DICOM conformance may be dependent upon configuration, which takes place at the time of installation. Issues concerning configuration are addressed in this section.

4.4.1. AE Title/Presentation Address Mapping

An important installation issue is the translation from AE title to presentation address. How this is to be performed is described here.

4.4.1.1. Local AE Titles

The local AE title mapping and configuration are specified as:

Table 76: AE Title Configuration

Application Entity	Default AE Title	Default TCP/IP Port
IENGINE_SCU	IENGINE_SCU	29536

4.4.1.2. Remote AE Title/Presentation Address Mapping

All relevant remote applications that should be able to setup a DICOM association towards Azurion R2.2 and that should be able to accept a DICOM association from Azurion R2.2 must be configured during Azurion R2.2 configuration time.

4.4.2. Parameters

The specification of important operational parameters, their default value and range (if configurable) are specified here.

Table 77: Configuration Parameters

Parameter	Configurable	Default Value
AE Title	Yes	IENGINE_SCU
Port number	Yes	29536
IP host name/address	Yes	-

5. Media Interchange

5.1. Implementation model

The implementation model identifies the DICOM Application Entities for Media in specific implementation and relates the Application Entities to Real-World Activities.

5.1.1. Application Data Flow Diagram

As part of the implementation model, an application data flow diagram is included. The next Figure shows the media interchange application data flow as a functional overview of the Media AE for DICOM CD and DVD.



Figure 16: Application Data Flow Diagram

The Media AE acts as a FSC for CD-R and DVD, when writing the selected images in a patient folder onto the medium.

5.1.2. Functional Definitions of AE's

The Azurion R2.2 implements the following functions for DICOM media.

- Write a DICOM file-set onto the medium.
- Create a DICOMDIR file.

5.1.3. Sequencing of Real World Activities

Not applicable.

5.2. AE Specifications

This section in the DICOM Conformance Statement specifies a set of Media Application Entities.

5.2.1. Media Storage Media – Specification

This section contains general policies that apply to all of the Application Entities described in subsequent section. The Azurion R2.2 provides standard conformance to the DICOM interchange option of the media storage service class, and follows the specifications as defined in the DICOM standard – Media Storage and File Format for Data Interchange (PS 3.10) and Media Storage Application Profiles (PS 3.11).

The Azurion R2.2 supports multi-patient and multi-session for CD-R media (both reading and writing). For one or more Application Profiles, the following table shows the Real-World Activities and the roles of each of these Real-World Activities.

Table 78: AE Media Storage related Application Profiles, Real-World Activities and Roles

Supported Application Profile	Identifier	Real-World Activities	Roles
General Purpose CD-R Interchange	STD-GEN-CD	Create File-set	FSC/FSR
General Purpose Interchange on DVD-RAM Media	STD-GEN-DVD-RAM	Create File-set	FSC/FSR

5.2.1.1. File Meta Information for the Media AE

Table 79: Implementation Identifying Information

Property	Value
Implementation Class UID:	1.3.46.670589.7.29.2.2.1
Implementation Version Name:	Azurion

5.2.1.2. Real-World Activities

The AE specification contains a description of the Real-World Activities, which invoke the particular AE.

5.2.1.3. RWA – Read File-set

Azurion R2.2 can read SC, XA and GSPS objects.

5.2.1.3.1.1. Media Storage Application Profile

Refer to the table in section 5.2.1, Table 78.

5.2.1.3.1.1.1. Options

Not applicable.

5.2.1.4. RWA – Create File-set

This Media Application Entity has a File-set Creator functionality which is described here.

Write Images

The Azurion R2.2 acts as an FSC when writing DICOM objects onto DICOM media. The Azurion R2.2 can also store private attributes. When the Azurion R2.2 has to write objects to DICOM media, it can encounter the following situation.

The objects were previously received via C-STORE operations. Some attributes in the received images have a zero-length value (Type 2 attributes). However, the Application Profile specifies some of these attributes as type 1: they must have a value. In such cases the Azurion R2.2 supplies a value for the following attributes (if necessary):

- Patient ID;
- Study ID;
- Series Number;
- Instance number;
- Study Date;
- Study Time.

The mechanism of generating a value for Patient ID is to create a new value (i.e. Study Instance UID) for each new study written to the medium, even if this study belongs to a patient recorded earlier. Study ID is assigned the value of the first Requested Procedure ID (0040, 1001) encountered in the Request Attributes Sequence (0040, 0275).

5.2.1.4.1.1. Media Storage Application Profile

Refer to the table in section 5.2.1, Table 78.

5.2.1.4.1.1.1. Options

Not applicable.

5.2.1.5. RWA – Update File-set

Not applicable.

5.2.1.5.1.1. Media Storage Application Profile

Refer to the table in section 5.2.1, Table 78.

5.2.1.5.1.1.1. Options

Not applicable.

5.3. Augmented and Private Application Profiles

Not applicable

5.4. Media Configuration

Not applicable.

6. Support of Character Sets

Any support for character sets in Network and Media services is described here.

Table 80: Supported DICOM Character Sets

Character Set Description	Defined Term	ESC Sequence	ISO Registration Number	Code Element	Character Set
Latin alphabet No. 1	ISO_IR 100	-	ISO-IR 100	G1	Supplementary set of ISO 8859
		-	ISO-IR 6	G0	ISO 646
Japanese	ISO 2022 IR 159	ESC 02/04 02/0804/04	ISO-IR 159	G0	JIS X 0212: Supplementary Kanji set
Japanese	ISO 2022 IR 87	ESC 02/04 04/02	ISO-IR 87	G0	JIS X 0208: Kanji and Hiragana
Japanese	ISO 2022 IR 13	ESC 02/09 04/09	ISO-IR 13	G1	JIS X 0201: Katakana
		ESC 02/08 04/10	ISO-IR 14	G0	JIS X 0201: Romaji (only for the patient name)
Chinese	GB18030	-	GB18030	-	-

7. Security

7.1. Security Profiles

7.1.1. Security use Profiles

Not applicable

7.1.2. Security Transport Connection Profiles

Azurion R2.2 does not claim conformance to any DICOM Secure Transport Connection profile.

Azurion R2.2 supports Secure communication as a “mode of operation”. This functionality will be used by the DICOM nodes, which can authenticate each other before they exchange DICOM information. For secure communication the TLS protocol is used which provides message authentication, integrity, confidentiality, and replay protection. Confidentiality is optional and can be controlled by the encryption settings.

The Azurion R2.2 supports X.509 certificates. The following TLS Certification checks will be done (TLS Handshake). The machine (either server or client) that will send its certificate will:

- Choose the certificate according to Common Name (CN) value in the Subject-field.
- This name is case-sensitive. All present certificates should have unique CN names.

The server verifies:

- That the client certificate is a X.509 certificate which is not tampered with
- That the client certificate is in the list of trusted certificates
- That the client certificate is not expired (present time is between “Valid From” and “Valid To” fields of the X.509 certificate)
- That the client certificate has the correct purpose (at least the Client Authentication purpose)

The client verifies:

- That the server certificate is a X.509 certificate which is not tampered with
- That the server certificate is in the list of trusted certificates
- That the server certificate is not expired (present time is between “Valid From” and “Valid To” fields of the X.509 certificate)
- That the server certificate has the correct purpose (at least Server Authentication purpose)

No verification is done on:

- Revocation of certificates
- Limiting the connection to a limited set of IP-addresses

Node authentication with or without encryption is only possible when both nodes have:

- An access to their own private keys
- An access to a copy of the certificate of the other node containing its public key

The Azurion R2.2 can only read certificates from the certificate stores of the HKEY_LOCAL_MACHINE registry key. It is the responsibility of the Hospital to setup and maintain the certificate stores. This includes the removal of revoked certificates and certificate updates prior to their expiration. Since neither X.500 directories, Lightweight Directory Access Protocol (LDAP) nor Certificate Revocation Lists (CRLs) are supported, the whole certificate chain needs to be replaced after a security breach.

The following figure presents the message flow of TLS handshake supported.

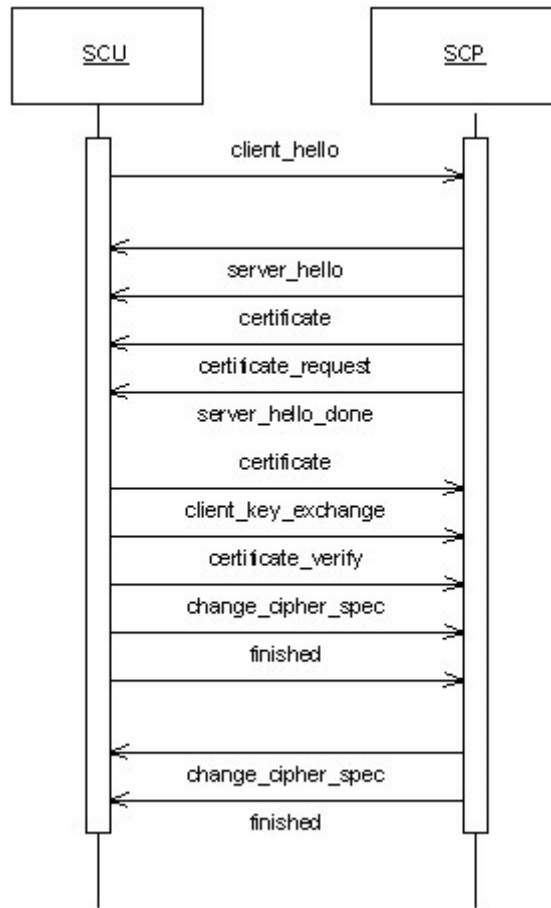

Figure 17: Message flow of TLS handshake

7.1.3. Digital Signature Profiles

Not applicable

7.1.4. Media Storage Security Profiles

Not applicable

7.1.5. Attribute Confidentiality Profiles

Azurion R2.2 conforms to the Basic Application Level Confidentiality Profile as a de-identifier. This functionality is targeted towards creating a special purpose, de-identified version of an already existing Data set.

Table presents all attributes that can be de-identified by the Azurion R2.2. Each Attribute to be protected has its value replaced by a different "replacement value" which does not allow identification of the patient.

Table 81: De-identified Attributes

Attribute Name	Tag	VR	Replacement Value
Patient Name	0010,0010	PN	Assign user-specified value
Patient ID	0010,0020	LO	Generate and provide a new ID
Patient's Birth Date	0010,0030	DA	Make Empty
Patient's Sex	0010,0040	CS	Make Empty
Other Patient Ids	0010,1000	LO	Make Empty
Patient's Size	0010,1020	DS	Make Empty
Patient Weight	0010,1030	DS	Make Empty

Attribute Name	Tag	VR	Replacement Value
Ethnic Group	0010,2160	SH	Make Empty
Additional Patient's History	0010,21B0	LT	Make Empty
Patient Comments	0010,4000	LT	Make Empty
SOP Instance UID	0008,0018	UI	Generate and provide new ID
Accession Number	0008,0050	SH	Make Empty
Institution Name	0008,0080	LO	Make Empty
Referring Physician's Name	0008,0090	PN	Make Empty
Device Serial Number	0008,1000	LO	Make Empty
Station Name	0008,1010	SH	Make Empty
Institutional Department Name	0008,1040	LO	Make Empty
Performing Physician's Name	0008,1050	PN	Make Empty
Operators' Name	0008,1070	PN	Make Empty
Referenced SOP Instance UID	0008,1155	UI	Generate and provide a new ID
Protocol Name	0018,1030	LO	Make Empty
Study ID	0020,0010	SH	Make Empty
Study Instance UID	0020,000D	UI	Generate and provide a new ID
Series Instance UID	0020,000E	UI	Generate and provide a new ID
Performed Procedure Step Description	0040,0254	LO	Make Empty
Request Attributes Sequence	0040,0275	SQ	Generate and provide dummy value

7.1.6. Network Address Management Profiles

Not applicable.

7.1.7. Time Synchronization Profiles

Azurion R2.2 conforms to the IHE Consistent Time Profile. It is possible to synchronize time with the NTP Timeserver using serviceability. The NTP Timeserver is an element of Hospital Infrastructure.

7.1.8. Application Configuration Management Profiles

Not applicable.

7.1.9. Audit Trail Profiles

The Audit Trail Component is a component of Azurion R2.2 and can create messages according to the ATNA, IHE defined standard. Actors are information systems or components of information systems that produce, manage, or act on categories of information required by operational activities in the enterprise. The Audit Trail Component allows security officers in an institution to audit activities, to detect non-compliant behavior in the enterprise, and to facilitate detection of improper creation, access, modification and deletion of Protected Health Information (PHI), where PHI data is considered as information records (Registration, Order, Study/Procedure, Reports and to a lesser degree Images/Presentation States), and not the flow of information between the systems. This includes information exported to and imported from every secured node in the "secured domain".

The messages will be created and sent to a syslog server according to the syslog protocol. The time that is used will be the local time of the system which is synchronized with the NTP Time Server. The timeserver and syslog server are elements of the Hospital infrastructure. The following messages will be created and sent to a central Audit Record Repository

- UserCreated
- UserDeleted
- UserUpdated
- UserGroupMappingChanged
- BeginTransferring
- DataExport
- DataImport
- InstancesTransferred
- StudyCreated

- EmergencyStudyCreated
- StudyUpdated
- StudyDeleted
- SeriesUpdated
- ProcedureOpenWith
- ProcedureStarted
- ProcedureComplete
- ProcedureSuspend
- SecurityAlert
- UserLogin
- UserLoggedOff
- NodeAdded
- NodeRemoved
- PatientDeleted
- ApplicationActivity

7.2. Association Level Security

The Azurion R2.2 accepts associations from unknown Aes but only for Storagecommit N-Event-Report, and C-Store as SCP. If Azurion R2.2 is configured to use secure mode, then the incoming associations (for Azurion R2.2 as SCP) should follow secure mode.

7.3. Application Level Security

The Azurion R2.2 allows the use of either a conventional (non-secure) DICOM communication or a secure DICOM communication based on the Transport Layer Security (TLS) protocol [TLS]. If configured, the Azurion R2.2 supports security

Measures for:

- Secure authentication of a node
- Integrity and confidentiality of transmitted data
- Replay protection
- Generation of audit trail records
- Access control and user authentication.

8. Annexes

8.1. IOD Contents

8.1.1. Created SOP Instances

This section specifies each IOD created by this application and specifies the content for each IOD created (including private IODs). For each attribute in the IOD the following information is supplied:

- Attribute name
- Tag
- VR – Value representation
- Value – specifies possible values
- Presence of value – specifies if attribute is always present or only under specific conditions
- Source of value – specifies the source of the value
- Comment – gives additional information on the attribute

Abbreviations used in the IOD tables for the column “Presence of Module” are:

- ALWAYS The module is always present.
 CONDITIONAL The module is used under specified condition.

Abbreviations used in the Module table for the column “Presence of Value” are:

- ALWAYS The attribute is always present with a value.
 EMPTY The attribute is always present without any value. (attribute sent zero length)
 VNAP The attribute is always present and its Value is Not Always Present.
 (attribute sent zero length if no value is present)
 ANAP The attribute is present under specified condition – if present then it will always have a value.

The abbreviations used in the Module table for the column “Source” are:

- AUTO The attribute value is generated automatically.
 CONFIG The attribute value source is a configurable parameter.
 COPY The attribute value source is another SOP instance.
 FIXED The attribute value is hard-coded in the application.
 IMPLICIT The attribute value source is a user-implicit setting.
 MPPS The attribute value is the same as that use for Modality Performed Procedure Step.
 MWL The attribute value source is a Modality Worklist.
 USER The attribute value source is explicit user input.

8.1.1.1. List of Created SOP Classes

Table 82: List of Created SOP Classes

SOP Class Name	SOP Class UID
Secondary Capture Image Storage SOP Class	1.2.840.10008.5.1.4.1.1.7
Grayscale Softcopy Presentation State Storage SOP Class	1.2.840.10008.5.1.4.1.1.11.1
X-Ray Angiographic Image Storage SOP Class	1.2.840.10008.5.1.4.1.1.12.1
X-Ray Radiation Dose Structured Report SOP Class	1.2.840.10008.5.1.4.1.1.88.67

8.1.1.2. Secondary Capture Image Storage SOP Class

Table 83: SOP Class Modules

Information Entity	Module	Presence
Patient	Patient Module	ALWAYS
Study	General Study Module	ALWAYS
	Patient Study Module	ALWAYS
Series	General Series Module	ALWAYS

Equipment	General Equipment Module	ALWAYS
	SC Equipment Module	ALWAYS
Image	General Image Module	ALWAYS
	Image Pixel Module	ALWAYS
	General Reference Module	User Defined
	SC Image Module	ALWAYS
	VOI LUT Module	ALWAYS
	SOP Common Module	ALWAYS

Table 84: Patient Module

Attribute Name	Tag	VR	Value	Presence of Value	Source	Comment
Referenced Patient Sequence	0008,1120	SQ		ANAP	MWL	
>Referenced SOP Class UID	0008,1150	UI		ALWAYS	MWL	
>Referenced SOP Instance UID	0008,1155	UI		ALWAYS	MWL	
Patient's Name	0010,0010	PN		VNAP	MWL,USER	
Patient ID	0010,0020	LO		VNAP	MWL,USER	
Patient's Birth Date	0010,0030	DA		VNAP	MWL,USER	
Patient's Sex	0010,0040	CS		VNAP	MWL,USER	
Other Patient IDs	0010,1000	LO		ANAP	MWL,USER	
Ethnic Group	0010,2160	SH		ANAP	MWL	
Patient Comments	0010,4000	LT		ANAP	MWL	

Table 85: General Study Module

Attribute Name	Tag	VR	Value	Presence of Value	Source	Comment
Study Date	0008,0020	DA		VNAP	AUTO	
Study Time	0008,0030	TM		VNAP	AUTO	
Accession Number	0008,0050	SH		VNAP	MWL	
Referring Physician's Name	0008,0090	PN		VNAP	MWL	
Study Description	0008,1030	LO		ANAP	USER,MWL	Copied from requested procedure
Procedure Code Sequence	0008,1032	SQ		ANAP	AUTO,MWL	
>Code Value	0008,0100	SH		ALWAYS	AUTO,MWL	
>Coding Scheme Designator	0008,0102	SH		ALWAYS	AUTO,MWL	
>Coding Scheme Version	0008,0103	SH		ALWAYS	AUTO,MWL	
>Code Meaning	0008,0104	LO		ALWAYS	AUTO,MWL	
Referenced Study Sequence	0008,1110	SQ		ALWAYS	AUTO,MWL	
>Referenced SOP Class UID	0008,1150	UI		ALWAYS	AUTO,MWL	
>Referenced SOP Instance UID	0008,1155	UI		ALWAYS	AUTO,MWL	
Study Instance UID	0020,000D	UI		ALWAYS	AUTO,MWL	
Study ID	0020,0010	SH		VNAP	AUTO,MWL,USER	In case Study ID is empty, accession number is used. If that is also empty then the

Attribute Name	Tag	VR	Value	Presence of Value	Source	Comment
						system generates a value for it

Table 86: Patient Study Module

Attribute Name	Tag	VR	Value	Presence of Value	Source	Comment
Patient's Size	0010,1020	DS		ANAP	MWL,USER	When received from the MWL SCP, the value can still be modified
Patient's Weight	0010,1030	DS		ANAP	MWL,USER	When received from the MWL SCP, the value can still be modified
Medical Alerts	0010,2000	LO		ANAP	MWL	
Allergies	0010,2110	LO		ANAP	MWL	
Additional Patient History	0010,21B0	LT		ANAP	MWL	

Table 87: General Series Module

Attribute Name	Tag	VR	Value	Presence of Value	Source	Comment
Series Date	0008,0021	DA		ANAP	AUTO	
Series Time	0008,0031	TM		ANAP	AUTO	
Modality	0008,0060	CS	OT	ALWAYS	AUTO	
Series Description	0008,103E	LO		ANAP	AUTO	
Performing Physicians' Name	0008,1050	PN		ANAP	MWL,USER	
Operators' Name	0008,1070	PN		ANAP	MWL, USER	
Referenced Performed Procedure Step Sequence	0008,1111	SQ	Identifies the MPPS SOP Instance to which this image is related	ANAP	AUTO, MPPS	
>Referenced SOP Class UID	0008,1150	UI	MPPS SOP Class UID	ALWAYS	MPPS	
>Referenced SOP Instance UID	0008,1155	UI	MPPS SOP Instance UID	ALWAYS	MPPS	
Protocol Name	0018,1030	LO		ANAP	AUTO	
Series Instance UID	0020,000E	UI		ALWAYS	AUTO	
Series Number	0020,0011	IS		VNAP	AUTO	
Laterality	0020,0060	CS		ANAP	AUTO	
Performed Procedure Step Start Date	0040,0244	DA		ANAP	AUTO	
Performed Procedure Step Start Time	0040,0245	TM		ANAP	AUTO	
Performed Procedure Step ID	0040,0253	SH		ANAP	AUTO, MWL	
Performed Procedure Step Description	0040,0254	LO		ANAP	MWL	
Request Attributes Sequence	0040,0275	SQ		ANAP	MWL	
>Accession Number	0008,0050	SH		ANAP	MWL	
>Requested Procedure Description	0032,1060	LO		ANAP	MWL	
>Requested Procedure Code Sequence	0032,1064	SQ		ANAP	MWL	
>>Code Value	0008,0100	SH		ALWAYS	MWL	

Attribute Name	Tag	VR	Value	Presence of Value	Source	Comment
>>Coding Scheme Designator	0008,0102	SH		ALWAYS	MWL	
>>Coding Scheme Version	0008,0103	SH		ALWAYS	MWL	
>>Code Meaning	0008,0104	LO		ALWAYS	MWL	
>Scheduled Procedure Step Description	0040,0007	LO		ALWAYS	MWL	
> Scheduled Protocol Code Sequence	0040,0008	SQ		ALWAYS	MWL	
>>Code Value	0008,0100	SH		ALWAYS	MWL	
>>Coding Scheme Designator	0008,0102	SH		ALWAYS	MWL	
>>Coding Scheme Version	0008,0103	SH		ALWAYS	MWL	
>>Code Meaning	0008,0104	LO		ALWAYS	MWL	
>Scheduled Procedure Step ID	0040,0009	SH		ANAP	MWL	
>Requested Procedure ID	0040,1001	SH		ANAP	MWL	

Table 88: General Equipment Module

Attribute Name	Tag	VR	Value	Presence of Value	Source	Comment
Manufacturer	0008,0070	LO	Philips	VNAP	AUTO	
Institution Name	0008,0080	LO		ANAP	CONFIG	
Station Name	0008,1010	SH		ANAP	CONFIG	
Institutional Department Name	0008,1040	LO		ANAP	AUTO	
Manufacturer's Model Name	0008,1090	LO	Azurion	ANAP	AUTO	
Device Serial Number	0018,1000	LO		ANAP	AUTO	
Software Versions	0018,1020	LO	2.2.0	ANAP	AUTO	

Table 89: SC Equipment Module

Attribute Name	Tag	VR	Value	Presence of Value	Source	Comment
Modality	0008,0060	CS	OT	ANAP	AUTO	
Conversion Type	0008,0064	CS	WSD	ALWAYS	AUTO	

Table 90: General Image Module

Attribute Name	Tag	VR	Value	Presence of Value	Source	Comment
Image Type	0008,0008	CS	DERIVEDPRIMARY	ALWAYS	AUTO	
Content Date	0008,0023	DA		ALWAYS	AUTO	
Content Time	0008,0033	TM		ALWAYS	AUTO	
Instance Number	0020,0013	IS		ALWAYS	AUTO	
Patient Orientation	0020,0020	CS		VNAP	AUTO	
Lossy Image Compression	0028,2110	CS	00	ALWAYS	AUTO	

Table 91: General Reference Module

Attribute Name	Tag	VR	Value	Presence of Value	Source	Comment
Derivation Description	0008,2111	ST		ANAP	AUTO	

Table 92: Image Pixel Module

Attribute Name	Tag	VR	Value	Presence of Value	Source	Comment
Samples per Pixel	0028,0002	US		ALWAYS	AUTO	
Photometric Interpretation	0028,0004	CS	RGB	ALWAYS	AUTO	
Planar Configuration	0028,0006	US		ANAP	AUTO	
Rows	0028,0010	US		ALWAYS	AUTO	
Columns	0028,0011	US		ALWAYS	AUTO	
Bits Allocated	0028,0100	US	8 or 16 Note: For Snapshot function, this number is 8	ALWAYS	AUTO	
Bits Stored	0028,0101	US	8 or 12 Note: For Snapshot function, this number is 8	ALWAYS	AUTO	
High Bit	0028,0102	US		ALWAYS	AUTO	
Pixel Representation	0028,0103	US	0000H	ALWAYS	AUTO	
Smallest Image Pixel Value	0028,0106	US/SS		ANAP	AUTO	
Largest Image Pixel Value	0028,0107	US/SS		ANAP	AUTO	
Pixel Data	7FE0,0010	OW/OB		ALWAYS	AUTO	

Table 93: SC Image Module

Attribute Name	Tag	VR	Value	Presence of Value	Source	Comment
Date of Secondary Capture	0018,1012	DA		ANAP	AUTO	
Time of Secondary Capture	0018,1014	TM		ANAP	AUTO	
Nominal Scanned Pixel Spacing	0018,2010	DS		ANAP	AUTO	
Pixel Spacing Calibration Type	0028,0A02	CS		ANAP	AUTO	

Table 94: VOI LUT Module

Attribute Name	Tag	VR	Value	Presence of Value	Source	Comment
Window Center	0028,1050	DS		ALWAYS	AUTO	
Window Width	0028,1051	DS		ALWAYS	AUTO	

Table 95: SOP Common Module

Attribute Name	Tag	VR	Value	Presence of Value	Source	Comment
Specific Character Set	0008,0005	CS		ANAP	AUTO	
Instance Creation Date	0008,0012	DA		ANAP	AUTO	
Instance Creation Time	0008,0013	TM		ANAP	AUTO	
SOP Class UID	0008,0016	UI	1.2.840.10008.5.1.4.1.1.7	ALWAYS	AUTO	
SOP Instance UID	0008,0018	UI		ALWAYS	AUTO	
Instance Number	0020,0013	IS		ANAP	AUTO	

8.1.1.3. Grayscale Softcopy Presentation State Storage SOP Class

Table 96: SOP Class Modules

Information Entity	Module	Presence
Patient	Patient Module	Always
Study	General Study Module	Always
	Patient Study Module	Always
Series	General Series Module	Always
	Presentation Series Module	Always
Equipment	General Equipment Module	Always
Presentation State	Presentation State Identification Module	Always
	Presentation State Relationship Module	Always
	Presentation State Shutter Module	Always
	Display Shutter Module	Always
	Bitmap Display Shutter Module	Always
	Displayed Area Module	Always
	Graphic Layer Module	Always
	Softcopy Presentation LUT Module	Always
	Softcopy VOI LUT module	Always
SOP Common Module	Always	

Table 97: Patient Module

Attribute Name	Tag	VR	Value	Presence of Value	Source	Comment
Referenced Patient Sequence	0008,1120	SQ		ANAP	MWL	
>Referenced SOP Class UID	0008,1150	UI		ALWAYS	MWL	
>Referenced SOP Instance UID	0008,1155	UI		ALWAYS	MWL	
Patient's Name	0010,0010	PN		VNAP	MWL,USER	
Patient ID	0010,0020	LO		VNAP	MWL,USER	
Patient's Birth Date	0010,0030	DA		VNAP	MWL,USER	
Patient's Sex	0010,0040	CS		VNAP	MWL,USER	
Other Patient IDs	0010,1000	LO		ANAP	MWL,USER	
Ethnic Group	0010,2160	SH		ANAP	MWL,USER	
Patient Comments	0010,4000	LT		ANAP	MWL,USER	

Table 98: General Study Module

Attribute Name	Tag	VR	Value	Presence of Value	Source	Comment
Study Date	0008,0020	DA		VNAP	AUTO	
Study Time	0008,0030	TM		VNAP	AUTO	
Accession Number	0008,0050	SH		VNAP	MWL	
Referring Physician's Name	0008,0090	PN		VNAP	MWL	
Study Description	0008,1030	LO		ANAP	AUTO	
Procedure Code Sequence	0008,1032	SQ		ANAP	MWL,AUTO	
>Code Value	0008,0100	SH		ALWAYS	MWL,AUTO	
>Coding Scheme Designator	0008,0102	SH		ALWAYS	MWL,AUTO	
>Coding Scheme Version	0008,0103	SH		ALWAYS	MWL,AUTO	
>Code Meaning	0008,0104	LO		ALWAYS	MWL,AUTO	
Referenced Study Sequence	0008,1110	SQ		ANAP	MWL	
>Referenced SOP Class UID	0008,1150	UI		ALWAYS	MWL	
>Referenced SOP Instance UID	0008,1155	UI		ALWAYS	MWL	
Study Instance UID	0020,000D	UI		ALWAYS	AUTO	

Study ID	0020,0010	SH		VNAP	AUTO, MWL, USER	In case Study ID is empty, accession number is used. If that is also empty then the system generates a value for it
----------	-----------	----	--	------	-----------------	---

Table 99: Patient Study Module

Attribute Name	Tag	VR	Value	Presence of Value	Source	Comment
Patient's Size	0010,1020	DS	In meters. When received from the MWL SCP, the value can still be modified	ANAP	MWL, USER	
Patient's Weight	0010,1030	DS	In kilograms. When received from the MWL SCP, the value can still be modified	ANAP	MWL, USER	
Medical Alerts	0010,2000	LO		ANAP	MWL	
Allergies	0010,2110	LO		ANAP	MWL	
Additional Patient History	0010,21B0	LT		ANAP	MWL	

Table 100: General Series Module

Attribute Name	Tag	VR	Value	Presence of Value	Source	Comment
Series Date	0008,0021	DA		ANAP	AUTO	
Series Time	0008,0031	TM		ANAP	AUTO	
Modality	0008,0060	CS	PR	ALWAYS	AUTO	
Series Description	0008,103E	LO		ALWAYS	AUTO	
Performing Physicians' Name	0008,1050	PN		ANAP	MWL, USER	
Operators' Name	0008,1070	PN		ANAP	MWL, USER	
Referenced Performed Procedure Step Sequence	0008,1111	SQ	Identifies the MPPS SOP Instance to which this image is related	ANAP	AUTO, MPPS	
>Referenced SOP Class UID	0008,1150	UI	MPPS SOP Class UID	ALWAYS	MWL	
>Referenced SOP Instance UID	0008,1155	UI	MPPS SOP Instance UID	ALWAYS	MWL	
Protocol Name	0018,1030	LO		ANAP	AUTO	
Series Instance UID	0020,000E	UI		ALWAYS	AUTO	
Series Number	0020,0011	IS		VNAP	AUTO	
Laterality	0020,0060	CS		EMPTY	AUTO	
Performed Procedure Step Start Date	0040,0244	DA		ALWAYS	AUTO	
Performed Procedure Step Start Time	0040,0245	TM		ALWAYS	AUTO	
Performed Procedure Step ID	0040,0253	SH	Same as MPPS	ALWAYS	AUTO,USER	
Performed Procedure Step Description	0040,0254	LO		ANAP	MWL	
Request Attributes Sequence	0040,0275	SQ		ANAP	MWL	

Attribute Name	Tag	VR	Value	Presence of Value	Source	Comment
>Accession Number	0008,0050	SH		ANAP	MWL	
>Issuer of Accession Number Sequence	0008,0051	SQ		ANAP	MWL	
>Referenced Study Sequence	0008,1110	SQ		ANAP	MWL	
>>Referenced SOP Class UID	0008,1150	UI		ALWAYS	MWL	
>>Referenced SOP Instance UID	0008,1155	UI		ALWAYS	MWL	
>Study Instance UID	0020,000D	UI		ANAP	MWL	
>Requested Procedure Description	0032,1060	LO		ANAP	MWL	
>Requested Procedure Code Sequence	0032,1064	SQ		ANAP	MWL	
>>Code Value	0008,0100	SH		ALWAYS	MWL	
>>Coding Scheme Designator	0008,0102	SH		ALWAYS	MWL	
>>Coding Scheme Version	0008,0103	SH		ALWAYS	MWL	
>>Code Meaning	0008,0104	LO		ALWAYS	MWL	
>Scheduled Protocol Code Sequence	0040,0008	SQ		ANAP	MWL	
>>Code Value	0008,0100	SH		ALWAYS	MWL	
>>Coding Scheme Designator	0008,0102	SH		ALWAYS	MWL	
>>Coding Scheme Version	0008,0103	SH		ALWAYS	MWL	
>>Code Meaning	0008,0104	LO		ALWAYS	MWL	
>>Protocol Context Sequence	0040,0440	SQ		ANAP	MWL	
>>>Value Type	0040,A040	CS		ALWAYS	MWL	
>>>Concept Name Code Sequence	0040,A043	SQ		ALWAYS	MWL	
>>>>Code Value	0008,0100	SH		ALWAYS	MWL	
>>>>Coding Scheme Designator	0008,0102	SH		ALWAYS	MWL	
>>>>Code Meaning	0008,0104	LO		ALWAYS	MWL	
>Reason for the Requested Procedure	0040,1002	LO		ANAP	MWL	
>Reason for Requested Procedure Code Sequence	0040,100A	SQ		ANAP	MWL	
>>Code Value	0008,0100	SH		ALWAYS	MWL	
>>Coding Scheme Designator	0008,0102	SH		ALWAYS	MWL	
>>Context Identifier	0008,010F	CS		ANAP	MWL	
>>Context UID	0008,0117	UI		ANAP	MWL	
>Scheduled Procedure Step ID	0040,0009	SH		ALWAYS	MWL	
>Requested Procedure ID	0040,1001	SH		ALWAYS	MWL	

Table 101: Presentation Series Module

Attribute Name	Tag	VR	Value	Presence of Value	Source	Comment
Modality	0008,0060	CS	PR	ALWAYS	AUTO	

Table 102: General Equipment Module

Attribute Name	Tag	VR	Value	Presence of Value	Source	Comment
Manufacturer	0008,0070	LO	Philips	VNAP	AUTO	

Institution Name	0008,0080	LO		ANAP	AUTO	
Station Name	0008,1010	SH		ANAP	AUTO	
Institutional Department Name	0008,1040	LO		ANAP	AUTO	
Manufacturer's Model Name	0008,1090	LO	Azurion	ANAP	AUTO	
Device Serial Number	0018,1000	LO		ANAP	AUTO	
Software Versions	0018,1020	LO	2.2.0	ANAP	AUTO	

Table 103: Presentation State Identification Module

Attribute Name	Tag	VR	Value	Presence of Value	Source	Comment
Instance Number	0020,0013	IS		ALWAYS	AUTO	
Content Label	0070,0080	CS	AS LAST SEEN	ALWAYS	AUTO	
Content Description	0070,0081	LO		VNAP	AUTO	
Presentation Creation Date	0070,0082	DA		ALWAYS	AUTO	
Presentation Creation Time	0070,0083	TM		ALWAYS	AUTO	
Content Creator's Name	0070,0084	PN		VNAP	AUTO	

Table 104: Presentation State Relationship Module

Attribute Name	Tag	VR	Value	Presence of Value	Source	Comment
Referenced Series Sequence	0008,1115	SQ		ALWAYS	AUTO	
>Referenced Image Sequence	0008,1140	SQ		ALWAYS	AUTO	
>>Referenced SOP Class UID	0008,1150	UI		ALWAYS	AUTO	
>>Referenced SOP Instance UID	0008,1155	UI		ALWAYS	AUTO	
>Series Instance UID	0020,000E	UI		ALWAYS	AUTO	

Table 105: Presentation State Shutter Module

Attribute Name	Tag	VR	Value	Presence of Value	Source	Comment
Shutter Presentation Value	0018,1622	US		ALWAYS	AUTO	

Table 106: Display Shutter Module

Attribute Name	Tag	VR	Value	Presence of Value	Source	Comment
Shutter Shape	0018,1600	CS	RECTANGULAR	ALWAYS	AUTO	
Shutter Left Vertical Edge	0018,1602	IS		ANAP	AUTO	
Shutter Right Vertical Edge	0018,1604	IS		ANAP	AUTO	
Shutter Upper Horizontal Edge	0018,1606	IS		ANAP	AUTO	
Shutter Lower Horizontal Edge	0018,1608	IS		ANAP	AUTO	
Shutter Presentation Value	0018,1622	US		ANAP	AUTO	

Table 107: Bitmap Display Shutter Module

Attribute Name	Tag	VR	Value	Presence of Value	Source	Comment
Shutter Shape	0018,1600	CS	RECTANGULAR	ALWAYS	AUTO	
Shutter Presentation Value	0018,1622	US		ANAP	AUTO	

Table 108: Displayed Area Module

Attribute Name	Tag	VR	Value	Presence of Value	Source	Comment
Displayed Area Selection Sequence	0070,005A	SQ		ALWAYS	AUTO	
>Referenced Image Sequence	0008,1140	SQ		ANAP	AUTO	
>>Referenced SOP Class UID	0008,1150	UI		ALWAYS	AUTO	
>>>Referenced SOP Instance UID	0008,1155	UI		ALWAYS	AUTO	
>Displayed Area Top Left Hand Corner	0070,0052	SL		ALWAYS	AUTO	calculated by the system but initiated by user i.e. without user zoom and pan displayed area does not have any meaning
>Displayed Area Bottom Right Hand Corner	0070,0053	SL		ALWAYS	AUTO	
>Presentation Size Mode	0070,0100	CS	SCALE TO FIT	ALWAYS	AUTO	
>Presentation Pixel Aspect Ratio	0070,0102	IS		ANAP	AUTO	

Table 109: Graphic Layer Module

Attribute Name	Tag	VR	Value	Presence of Value	Source	Comment
Graphic Layer Sequence	0070,0060	SQ		ALWAYS	AUTO	
>Graphic Layer	0070,0002	CS	GRAPHICS	ALWAYS	AUTO	
>Graphic Layer Order	0070,0062	IS	1	ALWAYS	AUTO	

Table 110: Softcopy Presentation LUT Module

Attribute Name	Tag	VR	Value	Presence of Value	Source	Comment
Presentation LUT Shape	2050,0020	CS	IDENTITY	ALWAYS	AUTO	

Table 111 : Softcopy VOI LUT Module

Attribute Name	Tag	VR	Value	Presence of Value	Source	Comment
Softcopy VOI LUT Sequence	0028,3110	SQ		ALWAYS	AUTO	
>Window Center	0028,1050	DS		ALWAYS	AUTO	
>Window Width	0028,1051	DS		ALWAYS	AUTO	

Table 112: SOP Common Module

Attribute Name	Tag	VR	Value	Presence of Value	Source	Comment
Specific Character Set	0008,0005	CS		ANAP	AUTO	
Instance Creation Date	0008,0012	DA		ANAP	AUTO	
Instance Creation Time	0008,0013	TM		ANAP	AUTO	
SOP Class UID	0008,0016	UI	1.2.840.10008.5.1.4.1.1.11.1	ALWAYS	AUTO	
SOP Instance UID	0008,0018	UI		ALWAYS	AUTO	
Instance Number	0020,0013	IS		ANAP	AUTO	

8.1.1.4. X-Ray Angiographic Image Storage SOP Class

Table 113: SOP Class Modules

Information Entity	Module	Presence
Patient	Patient Module	Always
Study	General Study Module	Always
	Patient Study Module	Always
Series	General Series Module	Always
Equipment	General Equipment Module	Always
Image	General Image Module	Always
	General Reference Module	User Defined
	Image Pixel Module	Always
	Contrast/Bolus Module	Always
	Cine Module	Always
	Multi-Frame Module	Always
	Display Shutter Module	Always
	X-Ray Image Module	Always
	X-Ray Acquisition Module	Always
	X-Ray Table Module	Always
	XA Positioner Module	Always
	DX Detector Module	Always
	Modality LUT Module	Always
	VOI LUT Module	Always
	Curve Module	User Defined This is present only when ECG signals are present in the data
SOP Common Module	Always	

Table 114: Patient Module

Attribute Name	Tag	VR	Value	Presence of Value	Source	Comment
Referenced Patient Sequence	0008,1120	SQ		ANAP	MWL	
>Referenced SOP Class UID	0008,1150	UI		ALWAYS	MWL	
>Referenced SOP Instance UID	0008,1155	UI		ALWAYS	MWL	
Patient's Name	0010,0010	PN		VNAP	MWL,USER	
Patient ID	0010,0020	LO		VNAP	MWL,USER	
Patient's Birth Date	0010,0030	DA		VNAP	MWL,USER	
Patient's Sex	0010,0040	CS		VNAP	MWL,USER	
Other Patient IDs	0010,1000	LO		ANAP	MWL,USER	
Ethnic Group	0010,2160	SH		ANAP	MWL,USER	
Patient Comments	0010,4000	LT		ANAP	MWL,USER	

Table 115: General Study Module

Attribute Name	Tag	VR	Value	Presence of Value	Source	Comment
Study Date	0008,0020	DA		VNAP	AUTO	
Study Time	0008,0030	TM		VNAP	AUTO	
Accession Number	0008,0050	SH		VNAP	MWL	
Referring Physician's Name	0008,0090	PN	Patient's referring physician.	VNAP	MWL	

Study Description	0008,1030	LO	Based on configuration Study Description is:-not exported –based on schedule procedure step description(WLM) –based on requested procedure step description(WLM) – internal generated performed procedure description	ANAP	AUTO,MWL	
Procedure Code Sequence	0008,1032	SQ		ANAP	MWL,AUTO	
>Code Value	0008,0100	SH		ALWAYS	MWL,AUTO	
>Coding Scheme Designator	0008,0102	SH		ALWAYS	MWL,AUTO	
> Coding Scheme Version	0008,0103	SH		ALWAYS	MWL,AUTO	
>Code Meaning	0008,0104	LO		ALWAYS	MWL, AUTO	
Referenced Study Sequence	0008,1110	SQ		ANAP	MWL	
>Referenced SOP Class UID	0008,1150	UI		ALWAYS	MWL	
>Referenced SOP Instance UID	0008,1155	UI		ALWAYS	MWL	
Study Instance UID	0020,000D	UI		ALWAYS	MWL	
Study ID	0020,0010	SH		VNAP	MWL	In case Study ID is empty, accession number is used. If that is also empty then the system generates a value for it

Table 116: Patient Study Module

Attribute Name	Tag	VR	Value	Presence of Value	Source	Comment
Patient's Size	0010,1020	DS	In meters. When received from the MWL SCP, the value can still be modified.	ANAP	MWL,USER	
Patient's Weight	0010,1030	DS	In kilograms. When received from the MWL SCP, the value can still be modified.	ANAP	MWL,USER	
Medical Alerts	0010,2000	LO		ANAP	MWL	
Allergies	0010,2110	LO		ANAP	MWL	
Additional Patient History	0010,21B0	LT		ANAP	MWL	

Table 117: General Series Module

Attribute Name	Tag	VR	Value	Presence of Value	Source	Comment
Series Date	0008,0021	DA		ANAP	AUTO	
Series Time	0008,0031	TM		ANAP	AUTO	
Modality	0008,0060	CS	XA	ALWAYS	AUTO	
Series Description	0008,103E	LO		ANAP	AUTO	
Performing Physicians' Name	0008,1050	PN		ANAP	MWL, USER	
Operators' Name	0008,1070	PN		ANAP	MWL, USER	
Referenced Performed Procedure Step Sequence	0008,1111	SQ	Identifies the MPPS SOP Instance to which this image is related	ANAP	AUTO, MPPS	
>Referenced SOP Class UID	0008,1150	UI	MPPS SOP Class UID	ALWAYS	MWL	
>Referenced SOP Instance UID	0008,1155	UI	MPPS SOP Instance UID	ALWAYS	MWL	

Attribute Name	Tag	VR	Value	Presence of Value	Source	Comment
Protocol Name	0018,1030	LO		ANAP	AUTO	
Series Instance UID	0020,000E	UI		ALWAYS	AUTO	
Series Number	0020,0011	IS		VNAP	AUTO	
Laterality	0020,0060	CS		EMPTY	AUTO	
Performed Procedure Step Start Date	0040,0244	DA		ANAP	AUTO,	
Performed Procedure Step Start Time	0040,0245	TM		ANAP	AUTO	
Performed Procedure Step ID	0040,0253	SH	Same as MPPS	ANAP	AUTO, USER	
Performed Procedure Step Description	0040,0254	LO	Same as MPPS	ANAP	AUTO, USER	
Request Attributes Sequence	0040,0275	SQ		ANAP	MWL	
>Accession Number	0008,0050	SH		ANAP	MWL	
>Issuer of Accession Number Sequence	0008,0051	SQ		ANAP	MWL	
>Referenced Study Sequence	0008,1110	SQ		ANAP	MWL	
>>Referenced SOP Class UID	0008,1150	UI		ALWAYS	MWL	
>>Referenced SOP Instance UID	0008,1155	UI		ALWAYS	MWL	
>Study Instance UID	0020,000D	UI		ANAP	MWL	
>Requested Procedure Description	0032,1060	LO		ANAP	MWL	
>Requested Procedure Code Sequence	0032,1064	SQ		ANAP	MWL	
>>Code Value	0008,0100	SH		ALWAYS	MWL	
>>Coding Scheme Designator	0008,0102	SH		ALWAYS	MWL	
>>Code Meaning	0008,0104	LO		ALWAYS	MWL	
>>Context Identifier	0008,010F	CS		ANAP	MWL	
>>Context UID	0008,0117	UI		ANAP	MWL	
>Scheduled Procedure Step Description	0040,0007	LO		ANAP	MWL	
>Scheduled Protocol Code Sequence	0040,0008	SQ		ANAP	MWL	
>>Code Value	0008,0100	SH		ALWAYS	MWL	
>>Coding Scheme Designator	0008,0102	SH		ALWAYS	MWL	
>>Code Meaning	0008,0104	LO		ALWAYS	MWL	
>>Context Identifier	0008,010F	CS		ANAP	MWL	
>>Context UID	0008,0117	UI		ANAP	MWL	
>>Protocol Context Sequence	0040,0440	SQ		ANAP	MWL	
>>>Content Item Modifier Sequence	0040,0441	SQ		ANAP	MWL	
>>>>Value Type	0040,A040	CS		ALWAYS	MWL	
>>>>Concept Name Code Sequence	0040,A043	SQ		ALWAYS	MWL	
>>>>>Code Value	0008,0100	SH		ALWAYS	MWL	
>>>>>Coding Scheme Designator	0008,0102	SH		ALWAYS	MWL	
>>>>>Code Meaning	0008,0104	LO		ALWAYS	MWL	
>>>>Value Type	0040,A040	CS		ALWAYS	MWL	
>>>>Concept Name Code Sequence	0040,A043	SQ		ALWAYS	MWL	
>>>>>Code Value	0008,0100	SH		ALWAYS	MWL	

Attribute Name	Tag	VR	Value	Presence of Value	Source	Comment
>>>>Coding Scheme Designator	0008,0102	SH		ALWAYS	MWL	
>>>>Code Meaning	0008,0104	LO		ALWAYS	MWL	
>>>>Context Identifier	0008,010F	CS		ANAP	MWL	
>>>>Context UID	0008,0117	UI		ANAP	MWL	
>Scheduled Procedure Step ID	0040,0009	SH		ANAP	MWL	
>Reason for Requested Procedure Code Sequence	0040,100A	SQ		ANAP	MWL	
>>Code Value	0008,0100	SH		ALWAYS	MWL	
>>Coding Scheme Designator	0008,0102	SH		ALWAYS	MWL	
>>Code Meaning	0008,0104	LO		ALWAYS	MWL	
>>Context Identifier	0008,010F	CS		ANAP	MWL	
>>Context UID	0008,0117	UI		ANAP	MWL	
>Requested Procedure ID	0040,1001	SH		ALWAYS	MWL	

Table 118: General Equipment Module

Attribute Name	Tag	VR	Value	Presence of Value	Source	Comment
Manufacturer	0008,0070	LO	Philips	VNAP	AUTO	
Institution Name	0008,0080	LO		ANAP	AUTO	
Station Name	0008,1010	SH		ANAP	AUTO	
Institutional Department Name	0008,1040	LO		ANAP	AUTO	
Manufacturer's Model Name	0008,1090	LO	Azurion	ANAP	AUTO	
Device Serial Number	0018,1000	LO		ANAP	AUTO	
Software Versions	0018,1020	LO	2.2.0	ANAP	AUTO	

Table 119: General Image Module

Attribute Name	Tag	VR	Value	Presence of Value	Source	Comment
Image Type	0008,0008	CS	Applied value(s):ORIGINAL or DERIVED(if subtraction has been processed into the image) Value 2: PRIMARY Value 3: SINGLE PLANE (if the image is a single plane acquisition) BIPLANE A (if the image is the first plane of a Bi-plane acquisition) BIPLANE B (if the image is the second plane of a Bi-plane acquisition) Value 4: SINGLE A (if the image is derived from plane A of a	ANAP	AUTO	

			biplane image and sent as a SINGLE PLANE image) SINGLE B (if the image is derived from plane B of a biplane image and sent as a SINGLE PLANE image)			
Acquisition Date	0008,0022	DA		ANAP	AUTO	
Content Date	0008,0023	DA		ANAP	AUTO	
Acquisition Time	0008,0032	TM		ANAP	AUTO	
Content Time	0008,0033	TM		ANAP	AUTO	
Irradiation Event UID	0008,3010	UI		ANAP	AUTO	
Referenced Image Sequence	0008,1140	SQ		ANAP	AUTO	
>Referenced SOP Class UID	0008,1150	UI		ALWAYS	AUTO	
>Referenced SOP Instance UID	0008,1155	UI		ALWAYS	AUTO	
Derivation Description	0008,2111	ST		ANAP	AUTO	
Instance Number	0020,0013	IS		VNAP	AUTO	
Patient Orientation	0020,0020	CS		ANAP	AUTO	
Lossy Image Compression	0028,2110	CS	00	ANAP	AUTO	
Presentation LUT Shape	2050,0020	CS	IDENTITY	ALWAYS	AUTO	

Table 120: General reference module

Attribute Name	Tag	VR	Value	Presence of Value	Source	Comment
Derivation Description	0008,2111	ST		VNAP	AUTO	
Source Image Sequence	0008,2112	SQ		ANAP	AUTO	
> Referenced SOP Class UID	0008,1150	UI		ALWAYS	AUTO	Documentation of source images for derived images. This will be present only for Derived images.
>Referenced SOP Instance UID	0008,1155	UI		ALWAYS	AUTO	
>Referenced Frame Number	0008,1160	IS		ALWAYS	AUTO	

Table 121: Image Pixel Module

Attribute Name	Tag	VR	Value	Presence of Value	Source	Comment
Samples per Pixel	0028,0002	US	1	ALWAYS	AUTO	
Photometric Interpretation	0028,0004	CS	MONOCHROME2: Upon import, only images with a photometric interpretation MONOCHROME1 or MONOCHROME2 are accepted.	ALWAYS	AUTO	
Rows	0028,0010	US		ALWAYS	AUTO	
Columns	0028,0011	US		ALWAYS	AUTO	
Bits Allocated	0028,0100	US	8 or 16 Note: For Snapshot function, this number is 8	ALWAYS	AUTO	

Bits Stored	0028,0101	US	8 or 12 Note: For Snapshot function, this number is 8	ALWAYS	AUTO	
High Bit	0028,0102	US	7	ALWAYS	AUTO	
Pixel Representation	0028,0103	US	0000H	ALWAYS	AUTO	
Pixel Data	7FE0,0010	OW/OB		ANAP	AUTO	

Table 122: Contrast/Bolus Module

Attribute Name	Tag	VR	Value	Presence of Value	Source	Comment
Contrast/Bolus Agent	0018,0010	LO		VNAP	AUTO	

Table 123: Cine Module

Attribute Name	Tag	VR	Value	Presence of Value	Source	Comment
Recommended Display Frame Rate	0008,2144	IS		ANAP	AUTO	
Cine Rate	0018,0040	IS		ANAP	AUTO	
Frame Time Vector	0018,1065	DS		ANAP	AUTO	
Frame Time	0018,1063	DS		ANAP	AUTO	Either frame time vector or Frame time will be present
Frame Delay	0018,1066	DS		ANAP	AUTO	

Table 124: Multi-Frame Module

Attribute Name	Tag	VR	Value	Presence of Value	Source	Comment
Number of Frames	0028,0008	IS		ALWAYS	AUTO	
Frame Increment Pointer	0028,0009	AT		ALWAYS	AUTO	

Table 125: Display Shutter Module

Attribute Name	Tag	VR	Value	Presence of Value	Source	Comment
Shutter Shape	0018,1600	CS	RECTANGULAR	ALWAYS	AUTO	
Shutter Left Vertical Edge	0018,1602	IS		ALWAYS	AUTO	
Shutter Right Vertical Edge	0018,1604	IS		ALWAYS	AUTO	
Shutter Upper Horizontal Edge	0018,1606	IS		ALWAYS	AUTO	
Shutter Lower Horizontal Edge	0018,1608	IS		ALWAYS	AUTO	

Table 126: X-Ray Image Module

Attribute Name	Tag	VR	Value	Presence of Value	Source	Comment
Image Type	0008,0008	CS		ALWAYS	AUTO	
Derivation Description	0008,2111	ST		ALWAYS	AUTO	
Scan Options	0018,0022	CS		ANAP	AUTO	ROTA
Referenced Image Sequence	0008,1140	SQ		ALWAYS	AUTO	
>Referenced SOP Class UID	0008,1150	UI		ALWAYS	AUTO	
>Referenced SOP Instance UID	0008,1155	UI		ALWAYS	AUTO	
Samples per Pixel	0028,0002	US	1	ALWAYS	AUTO	

Attribute Name	Tag	VR	Value	Presence of Value	Source	Comment
Photometric Interpretation	0028,0004	CS	MONOCHROME2 Upon import, only images with a photometric interpretation MONOCHROME1 or MONOCHROME2 are accepted.	ALWAYS	AUTO	
Frame Increment Pointer	0028,0009	AT		ALWAYS	AUTO	
Bits Allocated	0028,0100	US	8 or 16 Note: For Snapshot function, this number is 8	ALWAYS	AUTO	
Bits Stored	0028,0101	US	8 or 12 Note: For Snapshot function, this number is 8	ALWAYS	AUTO	
High Bit	0028,0102	US	11	ALWAYS	AUTO	
Pixel Representation	0028,0103	US	0000H	ALWAYS	AUTO	
Pixel Intensity Relationship	0028,1040	CS		ALWAYS	AUTO	
Lossy Image Compression	0028,2110	CS	00	ALWAYS	AUTO	

Table 127: X-Ray Acquisition Module

Attribute Name	Tag	VR	Value	Presence of Value	Source	Comment
KVP	0018,0060	DS		ALWAYS	AUTO	
Exposure Time	0018,1150	IS	Only sent if Exposure (0018, 1152) is not sent.	ANAP	AUTO	
X-Ray Tube Current	0018,1151	IS	Only sent if Exposure (0018, 1152) is not sent.	ANAP	AUTO	
Average Pulse Width	0018,1154	DS		ANAP	AUTO	
Exposure	0018,1152	IS	Only sent if Exposure Time (0018, 1150) and X-Ray Tube Current (0018, 1151) are not sent.	ANAP	AUTO	
Radiation Setting	0018,1155	CS		ALWAYS	AUTO	
Imager Pixel Spacing	0018,1164	DS		ANAP	AUTO	
X-Ray Tube Current in μ A	0018,8151	DS		ANAP	AUTO	

Table 128: X-Ray Table Module

Attribute Name	Tag	VR	Value	Presence of Value	Source	Comment
Table Motion	0018,1134	CS	STATIC, DYNAMIC	VNAP	AUTO	
Table Vertical Increment	0018,1135	DS	Incremental change (per frame) in vertical position relatively to the first frame of Multi-Frame image in mm	ANAP	AUTO	
Table Lateral Increment	0018,1136	DS	Incremental change (per frame) in lateral position relatively to the first frame of Multi-Frame image in mm	ANAP	AUTO	
Table Longitudinal Increment	0018,1137	DS	Incremental change (per frame) in longitudinal position relatively to the	ANAP	AUTO	

			first frame of Multi-Frame image in mm			
Table Angle	0018,1138	DS	Angle of table plane in degrees relative to horizontal plane (gravity plane). Positive values indicate that the head of the table is upwards.	ANAP	AUTO	

Table 129: XA Positioner Module

Attribute Name	Tag	VR	Value	Presence of Value	Source	Comment
Distance Source to Detector	0018,1110	DS		ALWAYS	AUTO	
Distance Source to Patient	0018,1111	DS		ALWAYS	AUTO	
Positioner Motion	0018,1500	CS	STATIC, DYNAMIC	ALWAYS	AUTO	
Positioner Primary Angle	0018,1510	DS		ALWAYS	AUTO	
Positioner Secondary Angle	0018,1511	DS		ALWAYS	AUTO	
Positioner Primary Angle Increment	0018,1520	DS	An array that contains the Positioner Primary Angle Increments between the n-th frame and the previous frame for a Multi-frame image.	ANAP	AUTO	
Positioner Secondary Angle Increment	0018,1521	DS	An array that contains the Positioner Secondary Angle Increments between the n-th frame and the previous frame for a Multi-frame image.	ANAP	AUTO	

Table 130: DX Detector Module

Attribute Name	Tag	VR	Value	Presence of Value	Source	Comment
Imager Pixel Spacing	0018,1164	DS		ALWAYS	AUTO	
Detector Type	0018,7004	CS		ANAP	AUTO	

Table 131: Modality LUT Module

Attribute Name	Tag	VR	Value	Presence of Value	Source	Comment
Modality LUT Sequence	0028,3000	SQ		ANAP	AUTO	
>LUT Descriptor	0028,3002	US/SS		ANAP	AUTO	
>Modality LUT Type	0028,3004	LO	US	ANAP	AUTO	
>LUT Data	0028,3006	UN		ANAP	AUTO	

Note: Modality LUT and pixel intensity “LOG” only when X-Ray Angiographic images are sent with unprocessed pixel data
-No Modality LUT and pixel intensity “LIN” when X-Ray Angiographic images are sent with processed pixel data.

Table 132: VOI LUT Module

Attribute Name	Tag	VR	Value	Presence of Value	Source	Comment
Window Center	0028,1050	DS	2085	ALWAYS	AUTO	
Window Width	0028,1051	DS	2409	ALWAYS	AUTO	

Table 133: Curve Module

Attribute Name	Tag	VR	Value	Presence of Value	Source	Comment
Curve Dimensions	5000,0005	US		ALWAYS	AUTO	
Number Of Points	5000,0010	US		ALWAYS	AUTO	
Type Of Data	5000,0020	CS		ALWAYS	AUTO	
Axis Units	5000,0030	SH	DPSPNONE	ALWAYS	AUTO	
Data Value Representation	5000,0103	US		ALWAYS	AUTO	
Minimum Coordinate Value	5000,0104	US		ALWAYS	AUTO	
Maximum Coordinate Value	5000,0105	US		ALWAYS	AUTO	
Curve Data Descriptor	5000,0110	US		ALWAYS	AUTO	
Coordinate Start Value	5000,0112	US		ALWAYS	AUTO	
Coordinate Step Value	5000,0114	US		VNAP	AUTO	
Curve Data	5000,3000	OW		ALWAYS	AUTO	

Table 134: SOP Common Module

Attribute Name	Tag	VR	Value	Presence of Value	Source	Comment
Specific Character Set	0008,0005	CS	-	ANAP	AUTO	
Instance Creation Date	0008,0012	DA		ALWAYS	AUTO	
Instance Creation Time	0008,0013	TM		ALWAYS	AUTO	
SOP Class UID	0008,0016	UI	1.2.840.10008.5.1.4.1.1.12.1	ALWAYS	AUTO	
SOP Instance UID	0008,0018	UI	Generated by device	ALWAYS	AUTO	
Instance Number	0020,0013	IS		ALWAYS	AUTO	

8.1.1.5. X-Ray Radiation Dose SR

Table 135: SOP Class Modules

Information Entity	Module	Presence
Patient	Patient Module	Always
Study	General Study Module	Always
	Patient Study Module	Always
Series	SR Document Series Module	Always
Equipment	General Equipment Module	Always
	Enhanced General Equipment Module	Always
Image	SR Document General Module	Always
	SR Document Content Module	Always
	SOP Common Module	Always

Table 136: Patient Module

Attribute Name	Tag	VR	Value	Presence of Value	Source	Comment
Referenced Patient Sequence	0008,1120	SQ		ANAP	MWL	
>Referenced SOP Class UID	0008,1150	UI		ALWAYS	MWL	
>Referenced SOP Instance UID	0008,1155	UI		ALWAYS	MWL	
Patient's Name	0010,0010	PN		ALWAYS	MWL, USER	
Patient ID	0010,0020	LO		VNAP	MWL, USER	
Patient's Birth Date	0010,0030	DA		VNAP	MWL, USER	

Patient's Sex	0010,0040	CS		VNAP	MWL, USER	
Other Patient IDs	0010,1000	LO		ANAP	MWL, USER	
Ethnic Group	0010,2160	SH		ANAP	MWL, USER	
Patient Comments	0010,4000	LT		ANAP	MWL, USER	

Table 137: General Study Module

Attribute Name	Tag	VR	Value	Presence of Value	Source	Comment
Study Date	0008,0020	DA		ALWAYS	MWL, AUTO	
Study Time	0008,0030	TM		ALWAYS	MWL, AUTO	
Accession Number	0008,0050	SH		ALWAYS	MWL	
Referring Physician's Name	0008,0090	PN		VNAP	MWL	
Study Description	0008,1030	LO		ANAP	MWL, AUTO	- based on configuration Study Description is not exported - based on schedule procedure step description (WLM) - based on requested procedure step description (WLM) - Internal generated performed procedure description.
Procedure Code Sequence	0008,1032	SQ		ANAP	MWL, AUTO	
Referenced Study Sequence	0008,1110	SQ		ANAP	MWL	
>Referenced SOP Class UID	0008,1150	UI		ALWAYS	MWL	
>Referenced SOP Instance UID	0008,1155	UI		ALWAYS	MWL	
Study Instance UID	0020,000D	UI		ALWAYS	AUTO	
Study ID	0020,0010	SH		VNAP	MWL, AUTO, USER	In case Study ID is empty, accession number is used. If that is also empty then the system generates a value for it

Table 138: Patient Study Module

Attribute Name	Tag	VR	Value	Presence of Value	Source	Comment
Patient's Weight	0010,1030	DS		ANAP	MWL, USER	When received from the MWL SCP, the value can still be modified.
Patient's Size	0010,1020	DS		ANAP	MWL, USER	
Medical Alerts	0010,2000	LO		ANAP	MWL, USER	
Allergies	0010,2110	LO		ANAP	MWL, USER	
Additional Patient History	0010,21B0	LT		ANAP	MWL	

Table 139 : SR Document Series Module

Attribute Name	Tag	VR	Value	Presence of Value	Source	Comment
Series Date	0008,0021	DA		ANAP	AUTO	

Series Time	0008,0031	TM		ANAP	AUTO	
Modality	0008,0060	CS	SR	ALWAYS	AUTO	
Series Description	0008,103E	LO	"Radiation Dose Information"	ANAP	AUTO	
Referenced Performed Procedure Step Sequence	0008,1111	SQ		VNAP	AUTO	
>Referenced SOP Class UID	0008,1150	UI		ALWAYS	AUTO	
>Referenced SOP Instance UID	0008,1155	UI		ALWAYS	AUTO	
Protocol Name	0018,1030	LO		ALWAYS	AUTO	
Series Instance UID	0020,000E	UI		ALWAYS	AUTO	
Series Number	0020,0011	IS		ALWAYS	AUTO	

Table 140: General Equipment Module

Attribute Name	Tag	VR	Value	Presence of Value	Source	Comment
Manufacturer	0008,0070	LO	Philips	VNAP	AUTO	
Institution Name	0008,0080	LO		ANAP	CONFIG	
Station Name	0008,1010	SH		ANAP	CONFIG	
Institutional Department Name	0008,1040	LO		ANAP	CONFIG	
Manufacturer's Model Name	0008,1090	LO	Azurion	ANAP	AUTO	
Device Serial Number	0018,1000	LO		ANAP	AUTO	
Software Versions	0018,1020	LO	2.2.0	ANAP	AUTO	

Table 141: Enhanced General Equipment Module

Attribute Name	Tag	VR	Value	Presence of Value	Source	Comment
Manufacturer	0008,0070	LO	Philips	ALWAYS	AUTO	
Manufacturer's Model Name	0008,1090	LO	Azurion	ALWAYS	AUTO	
Device Serial Number	0018,1000	LO		ALWAYS	AUTO	
Software Versions	0018,1020	LO	2.2.0	ALWAYS	AUTO	

Table 142: SR Document General Module

Attribute Name	Tag	VR	Value	Presence of Value	Source	Comment
Content Date	0008,0023	DA		ALWAYS	AUTO	
Content Time	0008,0033	TM		ALWAYS	AUTO	
Instance Number	0020,0013	IS		ALWAYS	AUTO	
Referenced Instance Sequence	0008,114A	SQ		ANAP	AUTO	
>Referenced SOP Class UID	0008,1150	UI	1.2.840.10008.5.1.4.1.1.12.1	ALWAYS	AUTO	
>Referenced SOP Instance UID	0008,1155	UI		ALWAYS	AUTO	
>Purpose of Reference Code Sequence	0040,A170	SQ		ALWAYS	AUTO	
>>Code Value	0008,0100	SH		ALWAYS	AUTO	
>>Coding Scheme Designator	0008,0102	SH		ALWAYS	AUTO	
>>Code Meaning	0008,0104	LO		ALWAYS	AUTO	
Instance Number	0020,0013	IS		ALWAYS	AUTO	
Referenced Request Sequence	0040,A370	SQ		ANAP	AUTO	
>Study Instance UID	0020,000D	UI		ALWAYS	MWL	
>Requested Procedure	0032,1060	LO		VNAP	AUTO	

Attribute Name	Tag	VR	Value	Presence of Value	Source	Comment
Description						
>Requested Procedure ID	0040,1001	SH		VNAP	AUTO	
>Reason for the Requested Procedure	0040,1002	LO		ANAP	AUTO	
>Placer Order Number/Imaging Service Request	0040,2016	LO		VNAP	AUTO	
>Filler Order Number/Imaging Service Request	0040,2017	LO		VNAP	AUTO	
Performed Procedure Code Sequence	0040,A372	SQ		VNAP	AUTO	
Current Requested Procedure Evidence Sequence	0040,A375	SQ		ANAP	AUTO	
>Referenced Series Sequence	0008,1115	SQ		ALWAYS	AUTO	
>>Referenced SOP Sequence	0008,1199	SQ		ALWAYS	AUTO	
>>>Referenced SOP Class UID	0008,1150	UI		ALWAYS	AUTO	
>>>Referenced SOP Instance UID	0008,1155	UI		ALWAYS	AUTO	
>>Series Instance UID	0020,000E	UI		ALWAYS	AUTO	
>Study Instance UID	0020,000D	UI		ALWAYS	AUTO	
Completion Flag	0040,A491	CS	COMPLETE	ALWAYS	AUTO	
Completion Flag Description	0040,A492	LO	"Complete X-Ray Radiation Dose Structured Report"	ANAP	AUTO	
Verification Flag	0040,A493	CS	UNVERIFIED	ALWAYS	AUTO	

Table 143 : SR Document Content Module

Attribute Name	Tag	VR	Value	Presence of Value	Source	Comment
Value Type	0040,A040	CS	CONTAINER	ALWAYS	AUTO	
Concept Name Code Sequence	0040,A043	SQ		ANAP	AUTO	
Content Template Sequence	0040,A504	SQ		ANAP	AUTO	
Content Sequence	0040,A730	SQ		ANAP	AUTO	
>Relationship Type	0040,A010	CS		ALWAYS	AUTO	
>Value Type	0040,A040	CS		ALWAYS	AUTO	
>Concept Name Code Sequence	0040,A043	SQ		ANAP	AUTO	
>>Code Value	0008,0100	SH		ALWAYS	AUTO	
>>Coding Scheme Designator	0008,0102	SH		ALWAYS	AUTO	
>>Code Meaning	0008,0104	LO		ALWAYS	AUTO	
>Referenced SOP Sequence	0008,1199	SQ		ALWAYS	AUTO	
>>Referenced SOP Class UID	0008,1150	UI		ALWAYS	AUTO	
>>Referenced SOP Instance UID	0008,1155	UI		ALWAYS	AUTO	
>Temporal Range Type	0040,A130	CS		ALWAYS	AUTO	
>Concept Code Sequence	0040,A168	SQ		ALWAYS	AUTO	
>>Code Value	0008,0100	SH		ALWAYS	AUTO	
>>Coding Scheme Designator	0008,0102	SH		ALWAYS	AUTO	
>>Code Meaning	0008,0104	LO		ALWAYS	AUTO	
>Graphic Data	0070,0022	FL		ALWAYS	AUTO	
>Graphic Type	0070,0023	CS		ALWAYS	AUTO	
>Referenced Frame of Reference UID	3006,0024	UI		ALWAYS	AUTO	

Table 144: SOP Common Module

Attribute Name	Tag	VR	Value	Presence of Value	Source	Comment
Specific Character Set	0008,0005	CS	-	ANAP	AUTO	
Instance Creation Date	0008,0012	DA		ANAP	AUTO	
Instance Creation Time	0008,0013	TM		ANAP	AUTO	
SOP Class UID	0008,0016	UI	1.2.840.10008.5.1.4.1.1.88.67	ALWAYS	AUTO	
SOP Instance UID	0008,0018	UI		ALWAYS	AUTO	
Instance Number	0020,0013	IS		ANAP	AUTO	

8.1.2. Attribute Mapping

Not applicable

8.1.3. Coerced/Modified Fields

Not applicable

8.2. Data Dictionary of Private Attributes

Not applicable

8.3. Coded Terminology and Templates

Not applicable

8.3.1. Context Group

Not applicable.

8.3.2. Template Specifications

X-RAY RADIATION DOSE STRUCTURED REPORT IOD TEMPLATES

The templates comply SCP the X-Ray Radiation Dose please refer the figure below:

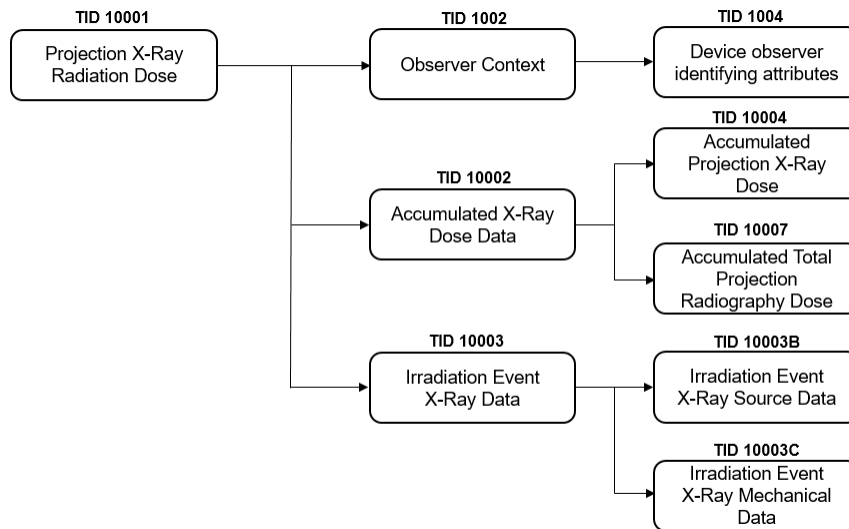

Figure 18: X-Ray Radiation Dose Structured Report IOD Template Structure

This section describes the content of all the templates used in the X-Ray Radiation Dose Reporting SR.

Table 145: Used Templates for X-Ray Radiation Dose Reporting

Template Name	Template ID
Projection X-Ray Radiation Dose	TID 10001
Accumulated X-Ray Dose	TID 10002
Irradiation Event X-Ray Data	TID 10003
Irradiation Event X-Ray Source Data (for Fluoroscopy Irradiation Event type)	TID 10003B
Irradiation Event X-Ray Source Data (for Stationary Acquisition Event type)	TID 10003B
Irradiation Event X-Ray Mechanical Data	TID 10003C
Accumulated Acquisition Projection X-Ray Dose (for Fluoroscopy Irradiation Event type)	TID 10004
Accumulated Acquisition Projection X-Ray Dose (for Stationary Acquisition Event type)	TID 10004
Accumulated Total Projection Radiography Dose	TID 10007
Observer Context	TID 1002
Device Observer Identifying Attributes	TID 1004

8.3.2.1. TID 10001 Projection X-Ray Radiation Dose

Table 146: Projection X-Ray Radiation Dose

NL	Relation with Parent	Concept Name	VT	VM	Presence of Value	Value
		EV (113701, DCM, "X-Ray Radiation Dose Report")	CONTAINER	1	ALWAYS	
>	HAS CONCEPT MOD	EV (121058, DCM, "Procedure reported")	CODE	1	ALWAYS	(113704, DCM, "Projection X-Ray")
>>	HAS CONCEPT MOD	EV (363703001, SCT, "Has Intent")	CODE	1	ALWAYS	R-002E9, SRT, "Combined Diagnostic and Therapeutic Procedure"
>	CONTAINS	EV (122142, DCM, « Acquisition Device Type »)	CODE	1	ALWAYS	113958, DCM, "Integrated Projection Radiography System"
>		DTID 1002 "Observer Context"	INCLUDE	1-n	ALWAYS	
>	HAS OBS CONTEXT	EV (113705, DCM, "Scope of Accumulation")	CODE	1	ALWAYS	(113016, DCM, "Performed Procedure Step")
>>	HAS PROPERTIES	121126, DCM, "Performed Procedure Step SOP Instance UID"	UIDREF	1	ALWAYS	
>	CONTAINS	DTID 10002 "Accumulated X-Ray Dose"	INCLUDE	1	MANDATORY CONDITIONAL	(113622, DCM, "Single Plane")
>	CONTAINS	DTID 10003 "Irradiation Event X-Ray Data"	INCLUDE	1-n	MANDATORY CONDITIONAL	
>	CONTAINS	EV (121106, DCM, "Comment")	TEXT	1	ALWAYS	X-Ray Radiation Dose Structured Report related to the Performed . . .
>	CONTAINS	EV (113854, DCM, "Source of Dose Information")	CODE	1-n	ALWAYS	(113856, DCM, Automated Data Collection)

8.3.2.2. TID 10002 Accumulated X-Ray Dose

Table 147: Accumulated X-Ray Dose

NL	Relation with Parent	Concept Name	VT	VM	Presence of Value	Value
		EV (113702, DCM, "Accumulated X-Ray Dose Data")	CONTAINER	1	ALWAYS	
>	HAS CONCEPT MOD	EV (113764, DCM, "Acquisition Plane")	CODE	1	ALWAYS	(113622, DCM, "Single Plane")
>	CONTAINS	EV (122505, DCM, "Calibration")	CONTAINER	1	USER OPTIONAL	
>>	HAS CONCEPT MOD	EV (113794, DCM, "Dose Measurement Device")	CODE	1	USER OPTIONAL	(A-2C090, SRT, "Dosimeter")
>>	CONTAINS	EV (113723, DCM, "Calibration DateTime")	DATETIME	1	USER OPTIONAL	
>>	CONTAINS	EV (122322, DCM, "Calibration Factor")	NUM	1	USER OPTIONAL	Units: 1, UCUM, "no units")
>>	CONTAINS	EV (113763, DCM, "Calibration Uncertainty")	NUM	1	USER OPTIONAL	Units: (%), UCUM, "Percent")
>>	CONTAINS	EV (113724, DCM, "Calibration Responsible Party")	TEXT	1	USER OPTIONAL	
>>	CONTAINS	EV (113720, DCM, "Calibration Protocol")	TEXT	1	USER OPTIONAL	
>	CONTAINS	(001, 99PHI-IXR-XPER, "Height of System")	NUM	1	ALWAYS	Units: (mm, UCUM, "mm")
>	CONTAINS	(002, 99PHI-IXR-XPER, "Focal Spot to ISO Center")	NUM	1	ALWAYS	Units: (mm, UCUM, "mm")
>	CONTAINS	DTID (10004) "Accumulated Projection X-Ray Dose"	INCLUDE	1	ALWAYS	
>	CONTAINS	DTID (10007) "Accumulated Total Projection Radiography Dose"	INCLUDE	1	CONDITIONAL	IFF TID (10001) Row 2 = (113704, DCM, "Projection X-Ray") and TID (10001) Row 4 is absent)

8.3.2.3. TID 10003 Irradiation Event X-Ray Data

Table 148: Irradiation Event X-Ray Data

NL	Relation with Parent	Concept Name	VT	VM	Presence of Value	Value
	CONTAINS	EV (113706, DCM, "Irradiation Event X-Ray Data")	CONTAINER	1	ALWAYS	
>	HAS CONCEPT MOD	EV (113764, DCM, "Acquisition Plane")	CODE	1	ALWAYS	(113622, DCM, "Single Plane")
>	CONTAINS	EV (113769, DCM, "Irradiation Event UID")	UIDREF	1	ALWAYS	-
>	CONTAINS	DT (111526, DCM, "DateTime Started")	DATETIME	1	ALWAYS	
>	CONTAINS	EV (113721, DCM, "Irradiation Event Type")	CODE	1	ALWAYS	(113611, DCM, "Stationary Acquisition") (P5-06000, SRT, "Fluoroscopy")
>	CONTAINS	EV (125203, DCM, "Acquisition Protocol")	TEXT	1	ALWAYS	-

>	CONTAINS	EV (113745, DCM, "Patient Table Relationship")	CODE	1	ALWAYS	-
>	CONTAINS	EV (113743, DCM, "Patient Orientation")	CODE	1	ALWAYS	-
>>	HAS CONCEPT MOD	EV (113744, DCM, « Patient Orientation Modifier »)	CODE	1	ALWAYS	-
>	CONTAINS	EV (123014, DCM, "Target Region")	CODE	1	ALWAYS	-
>	CONTAINS	EV (122130, DCM, "Dose Area Product")	NUM	1	ALWAYS	Units: (Gy.m2, UCUM, "Gy.m2")
>>>	CONTAINS	EV (111638, DCM, "Patient Equivalent Thickness")	NUM	1	USER OPTIONAL	
>	CONTAINS	EV (121106, DCM, "Comment")	TEXT	1	USER OPTIONAL	
>	CONTAINS	DTID 10003A "Irradiation Event X-Ray Detector Data"	INCLUDE	1	CONDITIONAL	IFF TID (10001) Row 8 is absent or has a value of (R-0038D, SRT, "Yes")
>	CONTAINS	DTID 10003B "Irradiation Event X-Ray Source Data"	INCLUDE	1	CONDITIONAL	IFF TID (10001) Row 9 is absent or has a value of (R-0038D, SRT, "Yes")
>	CONTAINS	DTID 10003C "Irradiation Event X-Ray Mechanical Data"	INCLUDE	1	CONDITIONAL	IFF TID (10001) Row 10 is absent or has a value of (R-0038D, SRT, "Yes")
>	CONTAINS	(003, 99PHI-IXR-XPER, "Number of Frames")	NUM	1	ALWAYS	Units: (1, UCUM, "no units")
>	CONTAINS	(004, 99PHI-IXR-XPER, "Subimages per Frame")	NUM	1	ALWAYS	Units: (1, UCUM, "no units")
>>	CONTAINS	(005, 99PHI-IXR-XPER, "Wedges and Shutters")	CONTAINER			
>>>	CONTAINS	(006, 99PHI-IXR-XPER, "Bottom Shutter")	NUM	1	ALWAYS	Units: (mm, UCUM, "mm")
>>>	CONTAINS	(007, 99PHI-IXR-XPER, "Left Shutter")	NUM	1	ALWAYS	Units: (mm, UCUM, "mm")
>>>	CONTAINS	(008, 99PHI-IXR-XPER, "Right Shutter")	NUM	1	ALWAYS	Units: (mm, UCUM, "mm")
>>>	CONTAINS	(009, 99PHI-IXR-XPER, "Top Shutter")	NUM	1	ALWAYS	Units: (mm, UCUM, "mm")
>>>	CONTAINS	(010, 99PHI-IXR-XPER, "Distance Wedge 1")	NUM	1	ALWAYS	Units: (mm, UCUM, "mm")
>>>	CONTAINS	(011, 99PHI-IXR-XPER, "Distance Wedge 2")	NUM	1	ALWAYS	Units: (mm, UCUM, "mm")
>>>	CONTAINS	(012, 99PHI-IXR-XPER, "Angle Wedge 1")	NUM	1	ALWAYS	Units: (deg, UCUM, "deg")
>>>	CONTAINS	(013, 99PHI-IXR-XPER, "Angle Wedge 2")	NUM	1	ALWAYS	Units: (deg, UCUM, "deg")
>>	CONTAINS	(014, 99PHI-IXR-XPER, "Beam Position")	CONTAINER			
>>>	CONTAINS	(015, 99PHI-IXR-XPER, "Longitudinal Beam Position")	NUM	1	ALWAYS	Units: (mm, UCUM, "mm")
>>>	CONTAINS	(016, 99PHI-IXR-XPER, "Lateral Beam Position")	NUM	1	ALWAYS	Units: (mm, UCUM, "mm")
>>>	CONTAINS	(017, 99PHI-IXR-XPER, "Beam Angle")	NUM	1	ALWAYS	Units: (deg, UCUM, "deg")
>	CONTAINS	(018, 99PHI-IXR-XPER, "Final Distance Source to Detector)	NUM	1	ALWAYS	Units: (mm, UCUM, "mm")
>	CONTAINS	(019, 99PHI-IXR-XPER, "Final Table Cradle Angle")	NUM	1	ALWAYS	Units: (deg, UCUM, "deg")

>	CONTAINS	(021, 99PHI-IXR-XPER, "Table Height Position")	NUM	1	ALWAYS	Units: (mm, UCUM, "mm")
>	CONTAINS	(022, 99PHI-IXR-XPER, "Final Table Tilt Angle")	NUM	1	ALWAYS	Units: (deg, UCUM, "deg")
>>	CONTAINS	(023, 99PHI-IXR-XPER, "Detector Field Size")	CONTAINER			
>>>	CONTAINS	(024, 99PHI-IXR-XPER, "X Side")	NUM	1	ALWAYS	Units: (mm, UCUM, "mm")
>>>	CONTAINS	(025, 99PHI-IXR-XPER, "Y Side")	NUM	1	ALWAYS	Units: (mm, UCUM, "mm")
>	CONTAINS	(026, 99PHI-IXR-XPER, "Object Thickness")	NUM	1	ALWAYS	Units: (mm, UCUM, "mm")
>	CONTAINS	(121114, DCM, "Performing Physician")	TEXT	1	ALWAYS	
>	CONTAINS	(029, 99PHI-IXR-XPER, "Application Name")	TEXT	1	ALWAYS	Left Coronary 15 fps Medium
>	CONTAINS	(030, 99PHI-IXR-XPER, "Fluoro Flavour")	TEXT	1	ALWAYS	Medium

8.3.2.4. TID 10003B Irradiation Event X-Ray Source Data (for Fluoroscopy Irradiation Event type)
Table 149: Irradiation Event X-Ray Source Data

NL	Relation with Parent	Concept Name	VT	VM	Presence of Value	Value
>	CONTAINS	EV (113738, DCM, "Dose (RP)")	NUM	1	ALWAYS	Units: (Gy, UCUM, "Gy")
>	CONTAINS	EV(113780, DCM, "Reference Point Definition")	TEXT	1	ALWAYS	15cm below BeamsIsocenter
>	CONTAINS	EV (113732, DCM, "Fluoro Mode")	CODE	1	USER CONDITIONAL	(113631, DCM, "Pulsed")
>	CONTAINS	EV (113768, DCM, "Number of Pulses")	NUM	1	ALWAYS	Units: (1, UCUM, "no units")
>	CONTAINS	EV (113793, DCM, "Pulse Width")	NUM	1	ALWAYS	Units: (ms, UCUM, "ms")
>	CONTAINS	EV (113742, DCM, "Irradiation Duration")	NUM	1	ALWAYS	Units: (s, UCUM, "s")
>	CONTAINS	EV (113733, DCM, "KVP")	NUM	1	ALWAYS	Units: (kV, UCUM, kV)
>	CONTAINS	EV (113734, DCM, "X-Ray Tube Current")	NUM	1	MANDATORY CONDITIONAL	Units: (mA, UCUM, mA)
>	CONTAINS	EV (113767, DCM, "Average X-Ray Tube Current")	NUM	1	ALWAYS	Units: (mA, UCUM, mA)
>	CONTAINS	EV (113736, DCM, "Exposure")	NUM	1	MANDATORY CONDITIONAL	Units: (uA.s, UCUM, uA.s)
>	CONTAINS	EV (113766, DCM, "Focal Spot Size")	NUM	1	OPTIONAL	Units: (mm, UCUM, mm)
>	CONTAINS	EV (113772, DCM, "X-Ray Filter Type")	CODE	1	ALWAYS	-
>	CONTAINS	EV (113757, DCM, "X-Ray Filter Material")	CODE	1	ALWAYS	(C-120F9, SRT, "Aluminum or Aluminum compound")
>	CONTAINS	EV (113758, DCM, "X-Ray Filter Thickness Minimum")	NUM	1	ALWAYS	Units: (mm, UCUM, mm)
>	CONTAINS	EV (113773, DCM, "X-Ray Filter Thickness Maximum")	NUM	1	ALWAYS	Units: (mm, UCUM, mm)
>	CONTAINS	EV (113790, DCM, "Collimated Field Area")	NUM	1	ALWAYS	Units: (m2, UCUM, m2)
>	CONTAINS	EV (113788, DCM, "Collimated Field Height")	NUM	1	OPTIONAL	Units: (mm, UCUM, mm)
>	CONTAINS	EV (113789, DCM, "Collimated Field Width")	NUM	1	OPTIONAL	Units: (mm, UCUM, mm)

8.3.2.5. TID 10003B Irradiation Event X-Ray Source Data (for Stationary Acquisition Irradiation Event type)
Table 150: Irradiation Event X-Ray Source Data

NL	Relation with Parent	Concept Name	VT	VM	Presence of Value	Value
>	CONTAINS	EV (113738, DCM, "Dose (RP)")	NUM	1	ALWAYS	Units: (Gy, UCUM, "Gy")
>	CONTAINS	EV(113780, DCM, "Reference Point Definition")	TEXT	1	ALWAYS	15cm below BeamIsocenter
>	CONTAINS	EV (113768, DCM, "Number of Pulses")	NUM	1	ALWAYS	Units: (1, UCUM, "no units")
>	CONTAINS	EV (113793, DCM, "Pulse Width")	NUM	1	ALWAYS	Units: (ms, UCUM, "ms")
>	CONTAINS	EV (113742, DCM, "Irradiation Duration")	NUM	1	ALWAYS	Units: (s, UCUM, "s")
>	CONTAINS	EV (113733, DCM, "KVP")	NUM	1	ALWAYS	Units: (kV, UCUM, kV)
>	CONTAINS	EV (113734, DCM, "X-Ray Tube Current")	NUM	1	MANDATORY CONDITIONAL	Units: (mA, UCUM, mA)
>	CONTAINS	EV (113767, DCM, "Average X-Ray Tube Current")	NUM	1	ALWAYS	Units: (mA, UCUM, mA)
>	CONTAINS	EV (113736, DCM, "Exposure")	NUM	1	MANDATORY CONDITIONAL	Units: (uA.s, UCUM, uA.s)
>	CONTAINS	EV (113766, DCM, "Focal Spot Size")	NUM	1	OPTIONAL	Units: (mm, UCUM, mm)
>	CONTAINS	EV (113772, DCM, "X-Ray Filter Type")	CODE	1	ALWAYS	-
>	CONTAINS	EV (113757, DCM, "X-Ray Filter Material")	CODE	1	ALWAYS	(C-120F9, SRT, "Aluminum or Aluminum compound")
>	CONTAINS	EV (113758, DCM, "X-Ray Filter Thickness Minimum")	NUM	1	ALWAYS	Units: (mm, UCUM, mm)
>	CONTAINS	EV (113773, DCM, "X-Ray Filter Thickness Maximum")	NUM	1	ALWAYS	Units: (mm, UCUM, mm)
>	CONTAINS	EV (113790, DCM, "Collimated Field Area")	NUM	1	ALWAYS	Units: (m2, UCUM, m2)
>	CONTAINS	EV (113788, DCM, "Collimated Field Height")	NUM	1	OPTIONAL	Units: (mm, UCUM, mm)
>	CONTAINS	EV (113789, DCM, "Collimated Field Width")	NUM	1	OPTIONAL	Units: (mm, UCUM, mm)

8.3.2.6. TID 10003C Irradiation Event X-Ray Mechanical Data

Table 151: Irradiation Event X-Ray Mechanical Data

NL	Relation with Parent	Concept Name	VT	VM	Presence of Value	Value
		EV (112011, DCM, "Positioner Primary Angle")	NUM	1	USER OPTION CONDITIONAL	Units: (deg, UCUM, deg)
		EV (112012, DCM, "Positioner Secondary Angle")	NUM	1	USER OPTION CONDITIONAL	Units: (deg, UCUM, deg)
		EV (113754, DCM, "Table Head Tilt Angle")	NUM	1	USER OPTION	Units: (deg, UCUM, deg)
		EV (113755, DCM, "Table Horizontal Rotation Angle")	NUM	1	USER OPTION	Units: (deg, UCUM, deg)
		EV (113756, DCM, "Table Cradle Tilt Angle")	NUM	1	USER OPTION	Units: (deg, UCUM, deg)
		(113748, DCM, "Distance Source to Isocenter")	NUM	1	USER OPTION	Units: (mm, UCUM, "mm")
		(113737, DCM, "Distance Source to Reference Point")	NUM	1	USER OPTION	Units: (mm, UCUM, "mm")
		(113750, DCM, "Distance Source to Detector")	NUM	1	USER OPTION	Units: (mm, UCUM, "mm")
		(113751, DCM, "Table Longitudinal Position")	NUM	1	USER OPTION	Units: (mm, UCUM, "mm")
		(113752, DCM, "Table Lateral Position")	NUM	1	USER OPTION	Units: (mm, UCUM, "mm")

(113753, DCM, "Table Height Position")	NUM	1	USER OPTION	Units: (mm, UCUM, "mm")
--	-----	---	-------------	-------------------------

8.3.2.7. TID 10004 Accumulated Projection X-Ray Dose (for Fluoroscopy Irradiation Event type)

Table 152: Accumulated Projection X-Ray Dose

NL	Relation with Parent	Concept Name	VT	VM	Presence of Value	Value
>>	CONTAINS	EV (113726, DCM, "Fluoro Dose Area Product Total")	NUM	1	ALWAYS	Units: (Gy.m2, UCUM, "Gy.m2")
>>	CONTAINS	EV (113728, DCM, "Fluoro Dose (RP) Total")	NUM	1	ALWAYS	Units: (Gy, UCUM, "Gy")
>>	CONTAINS	EV (113730, DCM, "Total Fluoro Time")	NUM	1	ALWAYS	Units: (s, UCUM, "s")

8.3.2.8. TID 10004 Accumulated Projection X-Ray Dose (for Stationary Acquisition Irradiation Event type)

Table 153: Accumulated Projection X-Ray Dose

NL	Relation with Parent	Concept Name	VT	VM	Presence of Value	Value
>>	CONTAINS	EV (113727, DCM, "Acquisition Dose Area Product Total")	NUM	1	ALWAYS	Units: (Gy.m2, UCUM, "Gy.m2")
>>	CONTAINS	EV (113729, DCM, « Acquisition Dose (RP) Total »)	NUM	1	CONDITIONAL	Units: (Gy, UCUM, "Gy")
>>	CONTAINS	EV (113855, DCM, "Total Acquisition Time")	NUM	1	ALWAYS	Units: (s, UCUM, "s")

8.3.2.9. TID 10007 Accumulated Total Projection Radiography Dose

Table 154: Accumulated Total Projection Radiography Dose

NL	Relation with Parent	Concept Name	VT	VM	Presence of Value	Value
>	CONTAINS	EV (113722, DCM, "Dose Area Product Total")	NUM	1	ALWAYS	Units: (Gy.m2, UCUM, Gy.m2)
>	CONTAINS	EV (113725, DCM, "Dose (RP) Total")	NUM	1	ALWAYS	Units: (Gy, UCUM, Gy)
>	CONTAINS	EV (113737, DCM, "Distance Source to Reference Point")	NUM	1	USER OPTION	Units: (mm, UCUM, "mm")
>	CONTAINS	EV (113731, DCM, "Total Number of Radiographic Frame")	NUM	1	USER OPTION	Units: (1, UCUM, no units)
>	CONTAINS	EV (113780, DCM, "Reference Point Definition")	TEXT	1	MANDATORY CONDITIONAL	15cm below BeamIsocenter

8.3.2.10. TID 1002 Observer Context

Table 155: Observer Context

NL	Relation with Parent	Concept Name	VT	VM	Presence of Value	Value
>	HAS OBS CONTEXT	EV (121005, DCM, "Observer Type")	CODE	1	ALWAYS	(121007, DCM, "Device")
	HAS OBS CONTEXT	DTID 1004 "Device Observer Identifying Attributes"	INCLUDE	1	ALWAYS	

8.3.2.11. TID 1004 Device Observer Identifying Attributes

Table 156: Device Observer Identifying Attributes

NL	Relation with Parent	Concept Name	VT	VM	Presence of Value	Value
>	HAS OBS CONTEXT	EV (121012, DCM, "Device Observer UID")	UIDREF	1	ALWAYS	
>	HAS OBS CONTEXT	EV (121013, DCM, "Device Observer Name")	TEXT	1	ALWAYS	
>	HAS OBS CONTEXT	EV (121014, DCM, "Device Observer Manufacturer")	TEXT	1	ALWAYS	Philips
>	HAS OBS CONTEXT	EV (121015, DCM, "Device Observer Model Name")	TEXT	1	ALWAYS	Azurion
>	HAS OBS CONTEXT	EV (121016, DCM, "Device Observer Serial Number")	TEXT	1	ALWAYS	

8.3.3. Private Code Definitions

Not applicable.

8.4. Grayscale Image Consistency

The monitors and printers attached to the product can be calibrated by using the Service Application.

8.5. Standard/Extended/Specialized/Private SOP Classes

Not applicable.

