DICOM

Conformance Statement

DigitalDiagnost 1.5.3



PHILIPS

Issued by:

Philips Medical Systems Nederland B.V.
CTO/ C&S - Interoperability Competence Center

Building QV-282
P.O. Box 10.000
5680 DA Best
The Netherlands

Email: dicom@philips.com

Internet: <http://www.medical.philips.com/connectivity>

Document Number: XBS 231-070745

Date: 9 April 2008

1. DICOM CONFORMANCE STATEMENT OVERVIEW

This document is the DICOM Conformance Statement for the Philips Medical Systems DigitalDiagnost Release 1.5.3, later referred to as DigitalDiagnost.

The DigitalDiagnost modality is a digital X-ray image generating system (DICOM image type is 'DX' and optionally also 'CR' and 'SC'). It contains an export function based on the DICOM image storage to transfer image data from the DigitalDiagnost system to a remote system. This DICOM export function and other functions of DigitalDiagnost are described in this document.

DigitalDiagnost in a DICOM Network

The figure below shows the position of DigitalDiagnost in a radiology environment.

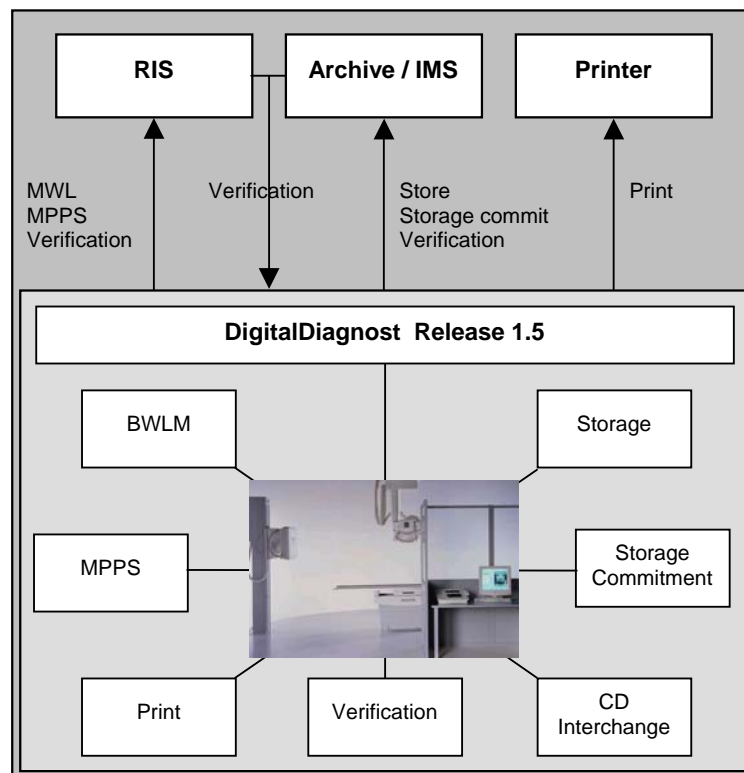

Figure 1: DigitalDiagnost in a DICOM Network

DigitalDiagnost is an embedded modality system for DICOM images. It provides, among other things, the following features:

- Verification of application level communication
- Basic Worklist Management (BWLM)
- Storage of images on a remote DICOM system
- Commitment of stored images on a remote DICOM system (Push Model)
- Study Management per Modality Performed Procedure Step (MPPS)
- Storage and retrieval of images per DICOM media (CD-R)
- Printing of hardcopies on a remote DICOM printer

A table of Supported Networking DICOM Service (SOP) Classes is provided with roles (User/Provider)

Table 1: Network Services

SOP Class		User of Service (SCU)	Provider of Service (SCP)
Name	UID		
Other			
Verification SOP Class	1.2.840.10008.1.1	Yes	Yes
Print Management			
Basic Grayscale Print Management Meta SOP Class	1.2.840.10008.5.1.1.9	Yes	No
>Basic Film Box SOP Class	1.2.840.10008.5.1.1.2	Yes	No
>Basic Film Session SOP Class	1.2.840.10008.5.1.1.1	Yes	No
>Basic Grayscale Image Box SOP Class	1.2.840.10008.5.1.1.4	Yes	No
>Printer SOP Class	1.2.840.10008.5.1.1.16	Yes	No
Presentation LUT SOP Class ¹	1.2.840.10008.5.1.1.23	Yes	No
Transfer			
Computed Radiography Image Storage SOP Class	1.2.840.10008.5.1.4.1.1.1	Yes	No
Digital X-Ray Image Storage – Presentation. SOP Class	1.2.840.10008.5.1.4.1.1.1.1	Yes	No
Secondary Capture Image Storage SOP Class	1.2.840.10008.5.1.4.1.1.7	Yes	No
Workflow Management			
Modality Performed Procedure Step SOP Class	1.2.840.10008.3.1.2.3.3	Yes	No
Modality Worklist Information Model - FIND SOP Class	1.2.840.10008.5.1.4.31	Yes	No
Storage Commitment Push Model	1.2.840.10008.1.20.1	Yes	No

The services can be specified as a SCU, SCP or as an Option, which means that it is either configurable or that it can be purchased separately.

A table of Supported Media Storage Application Profiles (with roles) is provided

Table 2: Media Services

Media Storage Application Profile	Write Files (FSC)	Write Files (FSU)	Read Files (FSR)
Compact Disk – Recordable			
General Purpose CD-R Interchange	Yes	Yes	Yes

Note:

- The storage service is configurable.
- All services can be purchased separately.
- Only Stitched images use the SOP Class Secondary Capture Images Storage.

¹ Configurable option

2. TABLE OF CONTENTS

1.	DICOM CONFORMANCE STATEMENT OVERVIEW	3
2.	TABLE OF CONTENTS	5
3.	INTRODUCTION	7
3.1.	REVISION HISTORY	7
3.2.	AUDIENCE	7
3.3.	REMARKS	7
3.4.	DEFINITIONS, TERMS AND ABBREVIATIONS	8
3.5.	REFERENCES	9
4.	NETWORKING	10
4.1.	IMPLEMENTATION MODEL	10
4.1.1.	Application Data Flow	10
4.1.2.	Functional Definition of AE's	11
4.1.2.1.	Functional Definition of DigitalDiagnost AE	11
4.1.3.	Sequencing of Real World Activities	13
4.2.	AE SPECIFICATIONS	16
4.2.1.	DigitalDiagnost AE	16
4.2.1.1.	SOP Classes	16
4.2.1.2.	Association Policies	16
4.2.1.2.1.	General	16
4.2.1.2.2.	Number of Associations	16
4.2.1.2.3.	Asynchronous Nature	17
4.2.1.2.4.	Implementation Identifying Information	17
4.2.1.2.5.	Communication Failure Handling	17
4.2.1.3.	Association Initiation Policy	17
4.2.1.3.1.	(Real-World) Activity – Verification as SCU	19
4.2.1.3.2.	(Real-World) Activity – Print Management as SCU	20
4.2.1.3.3.	(Real-World) Activity – Image Export	29
4.2.1.3.4.	(Real-World) Activity – Modality Performed Procedure Step As SCU	32
4.2.1.3.5.	(Real-World) Activity – Modality worklist As SCU	42
4.2.1.4.	Association Acceptance Policy	48
4.2.1.4.1.	(Real-World) Activity – Verification as SCP	49
4.2.1.4.2.	(Real-World) Activity – Storage Commitment as SCU	50
4.3.	NETWORK INTERFACES	52
4.3.1.	Physical Network Interfaces	52
4.3.2.	Additional Protocols	52
4.4.	CONFIGURATION	52
4.4.1.	AE Title/Presentation Address Mapping	52
4.4.1.1.	Local AE Titles	52
4.4.1.2.	Remote AE Title/Presentation Address Mapping	52
4.4.2.	Parameters	52
5.	MEDIA INTERCHANGE	56
5.1.	IMPLEMENTATION MODEL	56
5.1.1.	Application Data Flow Diagram	56
5.1.2.	Functional Definitions of AE's	56
5.1.3.	Sequencing of Real World Activities	56
5.1.4.	File Meta Information for Implementation Class and Version	57
5.2.	AE SPECIFICATIONS	57
5.2.1.	DigitalDiagnost AE - Specification	58
5.2.1.1.	File Meta Information for the DigitalDiagnost AE	58
5.2.1.2.	Real-World Activities	58
5.2.1.2.1.	Display Directory	58
5.2.1.2.2.	Write Images	58
5.2.1.2.3.	Read Images	59
5.3.	AUGMENTED AND PRIVATE APPLICATION PROFILES	59
5.3.1.	Augmented Application Profiles	59
5.3.2.	Private Application Profiles	60

5.4.	MEDIA CONFIGURATION	60
6.	SUPPORT OF CHARACTER SETS	61
7.	SECURITY	62
7.1.	SECURITY PROFILES	62
7.2.	ASSOCIATION LEVEL SECURITY.....	62
7.3.	APPLICATION LEVEL SECURITY	62
8.	ANNEXES OF APPLICATION "DIGITALDIAGNOST"	63
8.1.	IOD CONTENTS	63
8.1.1.	Created SOP Instance	63
8.1.1.1.	List of created SOP Classes	63
8.1.1.2.	Computed Radiography Image Storage SOP Class.....	64
8.1.1.3.	Digital X-Ray Image Storage - For Presentation SOP Class.....	71
8.1.1.4.	Digital X-Ray Image Storage - For Processing SOP Class	79
8.1.1.5.	Secondary Capture Image Storage SOP Class.....	87
8.1.2.	Usage of Attributes from Received IOD.....	95
8.1.3.	Attribute Mapping.....	95
8.1.4.	Coerced/Modified fields.....	96
8.2.	DATA DICTIONARY OF PRIVATE ATTRIBUTES	96
8.3.	CODED TERMINOLOGY AND TEMPLATES.....	99
8.4.	GRAYSCALE IMAGE CONSISTENCY	99
8.5.	STANDARD EXTENDED/SPECIALIZED/PRIVATE SOPS.....	99
8.5.1.	Standard Extended/Specialized/Private SOP i.....	99
8.6.	PRIVATE TRANSFER SYNTAXES.....	99

3. INTRODUCTION

The introduction specifies product and relevant disclaimers as well as any general information that the vendor feels is appropriate.

3.1. Revision History

The revision history provides dates and differences of the different releases.

Table 3: Revision History

Document Version	Date of Issue	Author	Description
00	10 October 2007	PH - HI - PII - IC2	First draft version of the Dicom Conformance Statement DigitalDiagnost 1.5.3 derived from DigitalDiagnost 1.5.1 of 21 June 2007 with doc number XBS231-060498
01	28 January 2008	PH - HI - PII - IC2	Proposal DICOM Conformance Statement DigitalDiagnost R1.5.3 after review updates
02	07 Februari 2008	PH - HI - PII - IC2	Final version of the DICOM Conformance Statement.
03	09 April 2008	PH - HI - PII - IC2	Final version. Updates done in table 35 for attribute Retrieve AE Title, Medium Type and Film Size ID

3.2. Audience

This Conformance Statement is intended for:

- (Potential) customers
- System integrators of medical equipment
- Marketing staff interested in system functionality
- Software designers implementing DICOM interfaces

It is assumed that the reader is familiar with the DICOM standard.

3.3. Remarks

The DICOM Conformance Statement is contained in chapter 4 through 8 and follows the contents and structuring requirements of DICOM PS 3.2.

This DICOM Conformance Statement by itself does not guarantee successful interoperability of Philips equipment with non-Philips equipment. The user (or user's agent) should be aware of the following issues:

- **Interoperability**
Interoperability refers to the ability of application functions, distributed over two or more systems, to work successfully together. The integration of medical devices into an IT environment may require application functions that are not specified within the scope of DICOM. Consequently, using only the information provided by this Conformance Statement does not guarantee interoperability of Philips equipment with non-Philips equipment.
It is the user's responsibility to analyze thoroughly the application requirements and to specify a solution that integrates Philips equipment with non-Philips equipment.
- **Validation**
Philips equipment has been carefully tested to assure that the actual implementation of the DICOM interface corresponds with this Conformance Statement.
Where Philips equipment is linked to non-Philips equipment, the first step is to compare the relevant Conformance Statements. If the Conformance Statements indicate that successful information exchange should be possible, additional validation tests will be necessary to ensure the functionality, performance,

accuracy and stability of image and image related data. It is the responsibility of the user (or user's agent) to specify the appropriate test suite and to carry out the additional validation tests.

- **New versions of the DICOM Standard**

The DICOM Standard will evolve in future to meet the user's growing requirements and to incorporate new features and technologies. Philips is actively involved in this evolution and plans to adapt its equipment to future versions of the DICOM Standard. In order to do so, Philips reserves the right to make changes to its products or to discontinue its delivery.

The user should ensure that any non-Philips provider linking to Philips equipment also adapts to future versions of the DICOM Standard. If not, the incorporation of DICOM enhancements into Philips equipment may lead to loss of connectivity (in case of networking) and incompatibility (in case of media).

3.4. Definitions, Terms and Abbreviations

DICOM definitions, terms and abbreviations are used throughout this Conformance Statement. For a description of these, see NEMA PS 3.3 and PS 3.4. The word Philips in this document refers to Philips Medical Systems.

The following acronyms and abbreviations are used in this document.

AE	Application Entity
ANSI	American National Standard Institute
AP	Application Profile
BWLM	Basic Worklist Mangement
CD	Compact Disc
CD-R	CD-Recordable
CR	Computed Radiography
DICOM	Digital Imaging and Communications in Medicine
DIMSE	DICOM Message Service Element
DIMSE-C	DIMSE-Composite
DIMSE-N	DIMSE-Normalized
DX	Digital X-Ray
EBE	DICOM Explicit VR Big Endian
ELE	DICOM Explicit VR Little Endian
FSC	File-set Creator
FSR	File-set Reader
FSU	File-set Updater
GUI	Graphic User Interface
HIS	Hospital Information System
HL7	Health Level Seven
ILE	DICOM Implicit VR Little Endian
IOD	Information Object Definition
MOD	Magneto-Optical Disk
MPPS	Modality Performed Procedure Step
NEMA	National Electrical Manufacturers Association
PDU	Protocol Data Unit
RIS	Radiology Information System
RWA	Real-World Activity
SC	Secondary Capture
SCP	Service Class Provider
SCU	Service Class User
SOP	Service Object Pair
TCP/IP	Transmission Control Protocol/ Internet Protocol
UID	Unique Identifier
WLM	Worklist Management

3.5. References

[DICOM] Digital Imaging and Communications in Medicine, Part 1 – 18
(NEMA PS 3.1– PS 3.18),
National Electrical Manufacturers Association (NEMA)
Publication Sales 1300 N. 17th Street, Suite 1847
Rosslyn, Virginia. 22209, United States of America
Internet: <http://medical.nema.org/>

Note that at any point in time the official standard consists of the most recent yearly edition of the base standard (currently 2007) plus all the supplements and correction items that have been approved as Final Text.

4. NETWORKING

This section contains the networking related services (vs. the media related ones).

4.1. Implementation model

The implementation model consists of three sections:

- The application data flow diagram, specifying the relationship between the Application Entities and the “external world” or Real-World Activities,
- A functional description of each Application Entity, and
- The sequencing constraints among them.

4.1.1. Application Data Flow

The DigitalDiagnost system consists of one single application entity only: the Digital DigitalDiagnost AE.

It incorporates the following functionality:

- The DigitalDiagnost AE can verify application level communication by using the -- Verification service both as SCU and SCP.
- The DigitalDiagnost AE can request a worklist by using the Basic Worklist Management service as SCU.
- The DigitalDiagnost AE can store image by using the Storage service as SCU.
- The DigitalDiagnost AE can request storage commitment for images by using the Storage Commitment service as SCU.
- The DigitalDiagnost AE can compose the modality performed procedure step by using the Study Management service as SCU.
- The DigitalDiagnost AE can print images by using the Print Management service as SCU.

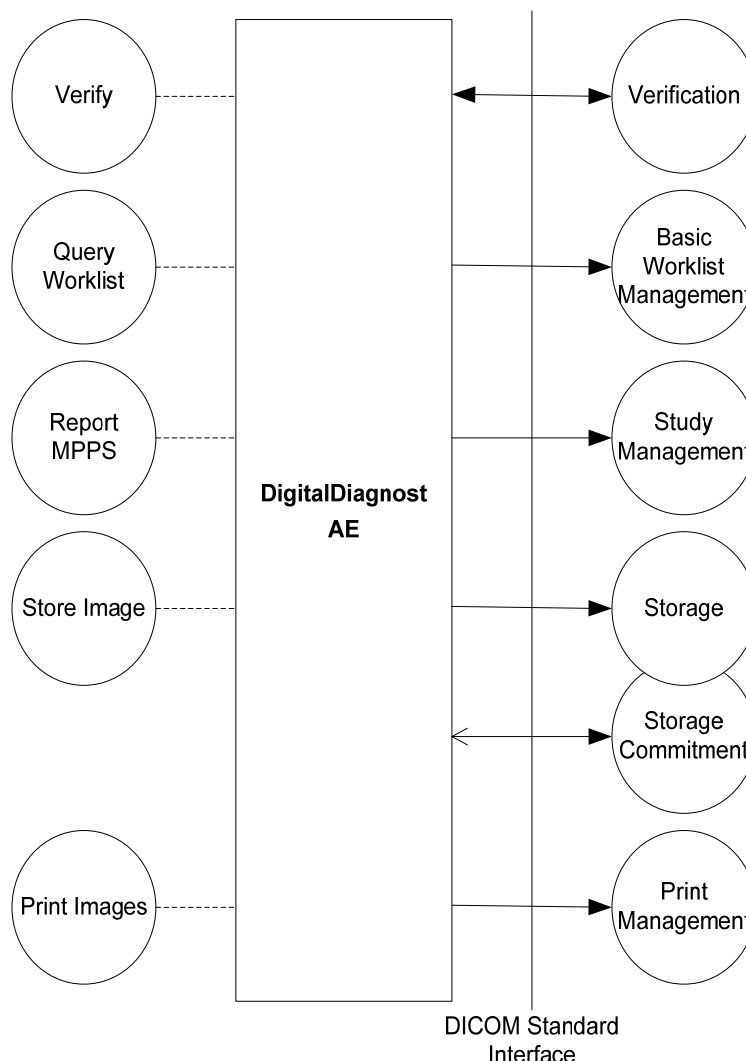

Figure 2: Application Data Flow Diagram

4.1.2. Functional Definition of AE's

This section contains a functional definition for each individual local Application Entity. This describes in general terms the functions to be performed by the AE, and the DICOM services used to accomplish these functions. In this sense, "DICOM services" refers not only to DICOM Service Classes, but also to lower level DICOM services, such as Association Services.

4.1.2.1. Functional Definition of DigitalDiagnost AE

The DigitalDiagnost AE is the one and only application entity within the DigitalDiagnost. It includes the following service classes.

Verification Service Class

The DigitalDiagnost AE provides the Verification service as SCP (RWA Verify).

A remote SCU shall request an association with the DigitalDiagnost AE for Verification SOP class. After accepting the association the DigitalDiagnost AE shall receive and respond to the Verification request and release the association when requested.

The DigitalDiagnost AE may use the Verification service as SCU (RWA Verify).

After initiating the Verify, the DigitalDiagnost AE shall request an association with the selected remote SCP for the Verification SOP class. After accepting the association the DigitalDiagnost AE shall send the verify request, wait for response, and then release the association.

The user interface shall inform on the status of the verification.

Basic Worklist Management Service Class

The DigitalDiagnost AE may use the Basic Worklist Management service as SCU (RWA Query Worklist).

After initiating the worklist query the DigitalDiagnost AE shall request an association with the configured remote Basic Worklist Management SCP. After accepting the association the DigitalDiagnost AE shall send the find request, wait for response, and then release the association.

The user interface shall be updated with the query results.

Storage Service Class

The DigitalDiagnost AE may use the Storage service as SCU (RWA Store Image).

After a performed procedure step the DigitalDiagnost AE shall store the related images at the configured Storage SCP. It shall request an association with the remote Storage SCP for the applicable Storage SOP classes. After accepting the association the DigitalDiagnost AE shall send the store request, wait for response, and then release the association.

Depending on the status of the store and the configuration the DigitalDiagnost AE may retry to store images.

After successful storage the user interface shall be updated accordingly.

Storage Commitment Service Class

The DigitalDiagnost AE may use the Storage Commitment service as SCU (RWA Commit Image).

If storage commitment is configured then, after Store images, the DigitalDiagnost AE shall automatically request commitment of images at the configured Storage Commitment SCP. It shall request an association with the remote Storage Commitment SCP for the Storage Commitment SOP class. After accepting the association the DigitalDiagnost AE shall send the action request, wait for response, and then release the association. Depending on the configuration the storage commitment report may be received either synchronous or asynchronous.

Depending on the status of the action and the configuration the DigitalDiagnost AE may retry to commit an image.

Basic Grayscale Print Management Service Class

The DigitalDiagnost AE may use the Basic Grayscale Print Management service as SCU (RWA Print Image).

After a performed procedure step, the DigitalDiagnost AE shall request printing of the images by the configured Print SCP. It shall request an association with the remote Print SCP for the Basic Grayscale Print Management SOP class. After accepting the association the DigitalDiagnost AE shall send the requests, wait for responses, and then release the association.

Depending on the status and the configuration the DigitalDiagnost AE may retry to print.

Study Management Service Class

The DigitalDiagnost AE may use the Study Management service as SCU (RWA Create Performed Procedure Step and RWA Set Performed Procedure Step).

After performing a procedure step the DigitalDiagnost AE shall request an association with the configured remote Study Management SCP. After accepting the association the DigitalDiagnost AE shall send a create request, wait for response, and then release the association.

Next the DigitalDiagnost AE shall request a new association to send a set request, and after response, release the association.

Depending on the status of creates and set and the configuration the DigitalDiagnost AE may perform a retry.

The user interface shall be updated with the performed procedure step status.

4.1.3. Sequencing of Real World Activities

The following sequences of Real-World activities are supported by the system.

Broad Query

The system requests a Worklist (initiates a BWLM request) either by the background "Broad Query" option or issued by the operator. If the query has been initiated by the operator, a result notification is given back. The user selects a patient from the patient list GUI and opens the Examination GUI.

Patient Query (optional)

The user requests a patient oriented worklist by entering matching values in the Patient Query GUI. After the patient related worklist items have been returned, the system directly opens the Examination GUI with the patient's examination context.

Default Acquisitions (Examination GUI)

The user starts the examination. When the user confirms the first acquisition of an examination, the DigitalDiagnost sets the MPPS status to "IN PROGRESS" and a DICOM N-CREATE message is sent to the RIS. At the same time the acquisition images may be sent from the Digit Diagnost to the configured archive and printer – as specified in the Examination GUI. If configured, a storage commitment request will be sent to the remote archive too. When the examination has been performed and the user returns to the patient list menu, an MPPS N-SET message (with status COMPLETED or DISCONTINUED) is sent to the RIS.

Re-Processing Acquisition Images (Viewer GUI)

If images of an examination have to be re-processed and re-exported with different post-processing, the user selects the images of the patient's examination in the Viewing tool GUI. When a new post-processing of an image is confirmed by the user then the system sets the MPPS status to "IN PROGRESS" and a DICOM N-CREATE message is sent to the RIS. When the user goes back to the Stamp View, an MPPS N-SET command (with status COMPLETED) is sent to the RIS.

In Stamp View the new image instances may be sent from the DigitalDiagnost to the configured archive and printer – as specified in the Examination GUI. If configured, a storage commitment request will be sent to the remote archive too.

Taking Non-Digital Acquisitions

The user starts an examination with acquisitions on the non-digital Registration Device (using conventional cassettes). When the acquisitions have been performed and the user goes back to the patient list menu, the system sets the MPPS status to "IN PROGRESS" and a DICOM N-CREATE message is sent back to the RIS, immediately followed by a MPPS N-SET command (with status COMPLETED or DISCONTINUED).

The MPPS messages show an empty referenced image sequence. No images are sent from DigitalDiagnost to a remote DICOM system.

At the time of closing the Examination (returning to the Patient List), the MPPS instance has no information whether this will stay a Non-Digital Acquisition, or PCR images will be linked with the exposure data at a later time.

Processing PCR Acquisition Images

DigitalDiagnost supports the optional reading and processing of PCR plates. After an examination has been started, the user either

- takes an acquisition on one of DigitalDiagnost's non-digital Registration Devices (Free RGDV or RGDV with a cassette loader), reads the image from the connected PCR cassette reader and links it to the selected examination and exposure data;
- reads an image (that has been exposed on a different system) from the connected PCR cassette reader and attaches it to an acquisition of the selected examination (in this case no exposure data is linked with the image).

Once the image data has been transferred from the reader to the DigitalDiagnost system, it is subject to the digital image processing, storage, print, and MPPS.

If (in either case) PCR images are entered to an Examination after it has been closed (i.e. the Examination has been re-opened for attaching the PCR images), the images are not MPPS registered.

Next figure below shows a typical sequence of an examination using a worklist.

- The user updates the worklist (Query Worklist) and then selects and opens an examination.
- After the user started the examination and confirmed the first acquisition (image (1)), the RIS is notified (Create Performed Procedure Step) and per default the image is sent to archive (Store Image and – if configured – Commit Image) and printer (Print Image) – all simultaneously.
- Any following acquisitions (image (n)) are sent to archive and printer – again simultaneously.
- Finally, when closing the examination, the RIS is notified to update the data of the examination (Set Performed Procedure Step).

Note that Print Image will sent images to the printer only when enough images were received to fulfill the configured print format or when the print job is flushed manually. When the examination is closed the print job will be flushed automatically.

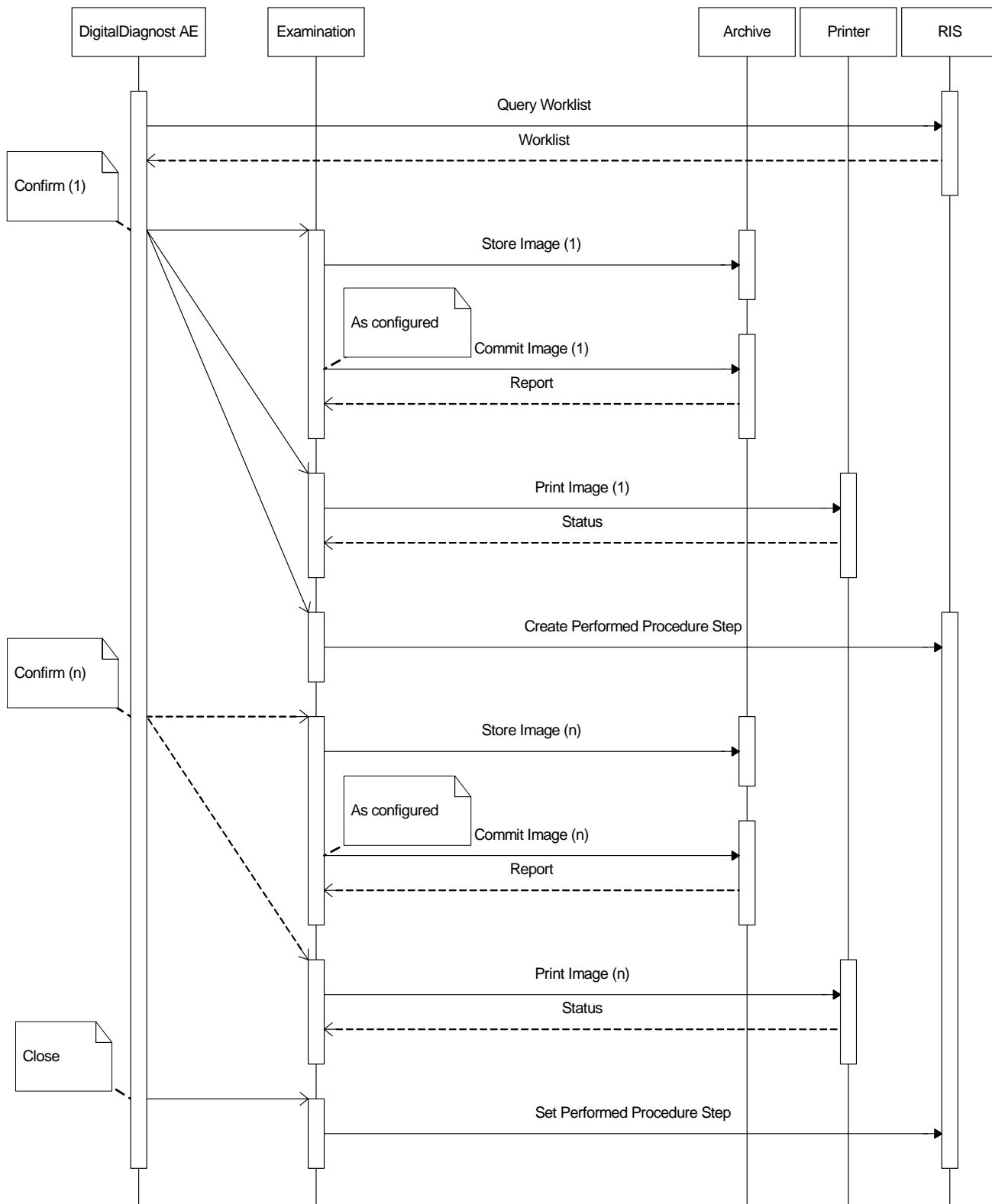

Figure 3: Sequencing of an examination

4.2. AE Specifications

The next section in the DICOM Conformance Statement contains the specification of the one and only DigitalDiagnost application Entity: DigitalDiagnost AE.

4.2.1. DigitalDiagnost AE

Every detail of this specific Application Entity shall be completely specified under this section.

4.2.1.1. SOP Classes

This Application Entity provides Standard Conformance to the following SOP Classes.

Table 4: SOP Classes for DigitalDiagnost AE

SOP Class Name	SOP Class UID	SCU	SCP
Computed Radiography Image Storage SOP Class	1.2.840.10008.5.1.4.1.1.1	Yes	No
Digital X-Ray Image Storage - Presentation. SOP Class	1.2.840.10008.5.1.4.1.1.1.1	Yes	No
Modality Performed Procedure Step SOP Class	1.2.840.10008.3.1.2.3.3	Yes	No
Modality Worklist Information Model - FIND SOP Class	1.2.840.10008.5.1.4.31	Yes	No
Secondary Capture Image Storage SOP Class	1.2.840.10008.5.1.4.1.1.7	Yes	No
Verification SOP Class	1.2.840.10008.1.1	Yes	Yes
Storage Commitment Push Model	1.2.840.10008.1.20.1	Yes	No
Basic Grayscale Print Management Meta SOP Class	1.2.840.10008.5.1.1.9	Yes	No
>Basic Film Box SOP Class	1.2.840.10008.5.1.1.2	Yes	No
>Basic Film Session SOP Class	1.2.840.10008.5.1.1.1	Yes	No
>Basic Grayscale Image Box SOP Class	1.2.840.10008.5.1.1.4	Yes	No
>Printer SOP Class	1.2.840.10008.5.1.1.16	Yes	No
Presentation LUT SOP Class ²	1.2.840.10008.5.1.1.23	Yes	No

Note: Any SOP specific behavior is documented later in the conformance statement in the applicable SOP specific conformance section.

4.2.1.2. Association Policies

Each AE specification contains a description of the general association establishment and acceptance policies of the AE.

4.2.1.2.1. General

The DICOM standard application context has specified.

Table 5: DICOM Application Context

Application Context Name	1.2.840.10008.3.1.1.1
--------------------------	-----------------------

4.2.1.2.2. Number of Associations

The number of simultaneous associations that an Application Entity may support as an Initiator or Acceptor is specified.

Table 6: Number of Associations as an Association Initiator for DigitalDiagnost AE

Maximum number of simultaneous associations	5
---	---

² Configurable option

Table 7: Number of Associations as an Association Acceptor for DigitalDiagnost AE

Maximum number of simultaneous associations	1
---	---

4.2.1.2.3. Asynchronous Nature

If the implementation supports negotiation of multiple outstanding transactions this is stated here, along with the maximum number of outstanding transactions supported.

Table 8: Asynchronous Nature as an Association Initiator for DigitalDiagnost AE

Maximum number of outstanding asynchronous transactions	N/A
---	-----

4.2.1.2.4. Implementation Identifying Information

The value supplied for Implementation Class UID and version name are documented here.

Table 9: DICOM Implementation Class and Version for DigitalDiagnost AE

Implementation Class UID	1.3.46.670589.26.1.5.3
Implementation Version Name	DigiDiagnost1.53

4.2.1.2.5. Communication Failure Handling

The behavior of the AE during communication failure is summarized in next table.

Table 10: Communication Failure Behavior

Exception	Behavior
Timeout	The association is aborted and the command is reported to the user as failed. The reason is logged. If applicable the command will be retried after a configured period of time and up to a configured number of times.
Association aborted	The command is reported to the user as failed. The reason is logged. If applicable the command will be retried after a configured period of time and up to a configured number of times.
Failed to connect	The user is notified (via pop-up). If applicable the command will be retried. Log entry.

4.2.1.3. Association Initiation Policy

This describes the conditions under which the AE will initiate an association.

The behavior of the AE during association rejection is summarized in next table
The DigitalDiagnost AE shall initiate associations as a result of the following events:

- The operator clicks the Verify button to initiate verification.
- The operator clicks the Worklist Query button or Patient Query confirm button to initiate a worklist query.
- The operator clicks the Confirm button to store (and commit) an image and create the performed procedure step.
- The operator clicks the Patient List button to end the examination and set the performed procedure steps.
- The operator clicks the Patient List button to end the examination and print the exam, or clicks the Print Now button to print an exam.
- The operator clicks the Store button in the Stamp View of the Viewer to store (and commit) the selected images, or clicks the Print button to print the selected images.
- The operator clicks the Create button of the Viewer to create a modified image instance and create a performed procedure step.

- The operator clicks the Stamp View button of the Viewer to set the performed procedure step.

The behavior of the AE during association rejection is summarized in next table

Table 11: DICOM Association Rejection Handling

Result	Source	Reason/Diagnosis	Behavior	
1 – rejected-permanent	1 – DICOM UL service-user	1 – no-reason-given	The user is notified (via pop-up). If applicable the command will be retried. Log entry.	
		2 – application-context-name-not-supported	The user is notified (via pop-up). If applicable the command will be retried. Log entry.	
		3 – calling-AE-title-not-recognized	The user is notified (via pop-up). If applicable the command will be retried. Log entry.	
		7 – called-AE-title-not-recognized	The user is notified (via pop-up). If applicable the command will be retried. Log entry.	
	2 – DICOM UL service-provider (ACSE related function)	1 – no-reason-given	The user is notified (via pop-up). If applicable the command will be retried. Log entry.	
		2 – protocol-version-not-supported	The user is notified (via pop-up). If applicable the command will be retried. Log entry.	
	3 – DICOM UL service-provider (presentation related function)	1 – temporary-congestion	The user is notified (via pop-up). If applicable the command will be retried. Log entry.	
		2 – local-limit-exceeded	The user is notified (via pop-up). If applicable the command will be retried. Log entry.	
	2 – rejected-transient	1 – DICOM UL service-user	1 – no-reason-given	The user is notified (via pop-up). If applicable the command will be retried. Log entry.
			2 – application-context-name-not-supported	The user is notified (via pop-up). If applicable the command will be retried. Log entry.
3 – calling-AE-title-not-recognized			The user is notified (via pop-up). If applicable the command will be retried. Log entry.	
7 – called-AE-title-not-recognized			The user is notified (via pop-up). If applicable the command will be retried. Log entry.	
2 – DICOM UL service-provider (ACSE related function)		1 – no-reason-given	The user is notified (via pop-up). If applicable the command will be retried. Log entry.	
		2 – protocol-version-not-supported	The user is notified (via pop-up). If applicable the command will be retried. Log entry.	
3 – DICOM UL service-provider (presentation related function)		1 – temporary-congestion	The user is notified (via pop-up). If applicable the command will be retried. Log entry.	
		2 – local-limit-exceeded	The user is notified (via pop-up). If applicable the command will be retried. Log entry.	

4.2.1.3.1. (Real-World) Activity – Verification as SCU

4.2.1.3.1.1. Description and Sequencing of Activities

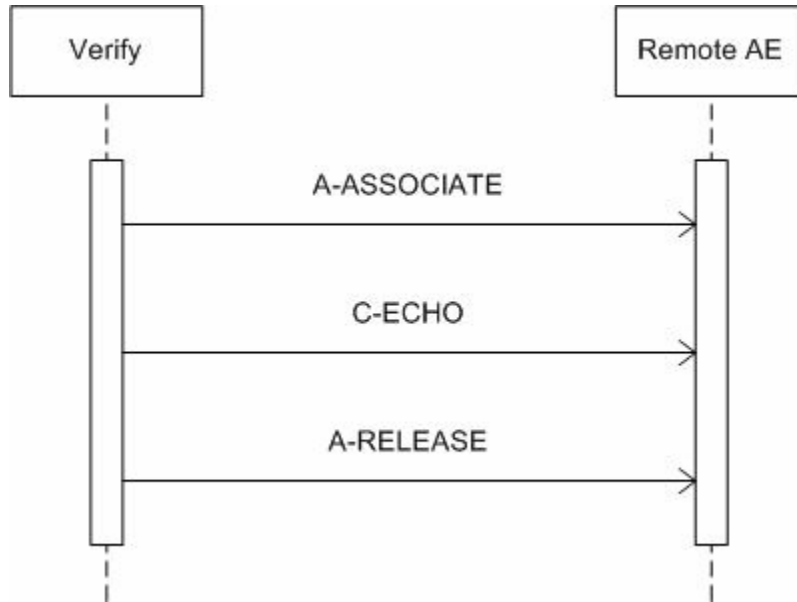

Figure 4: (Real World) Activity - Verification as SCU

When clicking the Verify button the DigitalDiagnost AE shall request an association with the selected external device (SCP) for the Verification SOP class. After accepting the association the DigitalDiagnost AE shall send the verify request, wait for response, and then release the association

4.2.1.3.1.2. Proposed Presentation Contexts

The presentation context proposed by the DigitalDiagnost AE for Verify is defined in next table.

Table 12: Proposed Presentation Contexts for (Real-World) Activity – Verification as SCU

Presentation Context Table					
Abstract Syntax		Transfer Syntax		Role	Extended Negotiation
Name	UID	Name List	UID List		
Verification SOP Class	1.2.840.10008.1.1	Explicit VR Big Endian	1.2.840.10008.1.2.2	SCU	None
		Explicit VR Little Endian	1.2.840.10008.1.2.1		
		Implicit VR Little Endian	1.2.840.10008.1.2		

4.2.1.3.1.3. SOP Specific Conformance for Verification SOP Class

4.2.1.3.1.3.1. Dataset Specific Conformance for Verification C-ECHO SCU

The DigitalDiagnost AE provides standard conformance to the DICOM Verification service class.

All details regarding the specific conformance, including response behavior to all status codes, both from an application level and communication errors are provided in

Table 13: C-ECHO-RQ Status Response

Service Status	Code	Further Meaning	Description
Success	0000	Verification is complete	The SCP has successfully received the verification request.

4.2.1.3.2. (Real-World) Activity – Print Management as SCU

4.2.1.3.2.1. Description and Sequencing of Activities

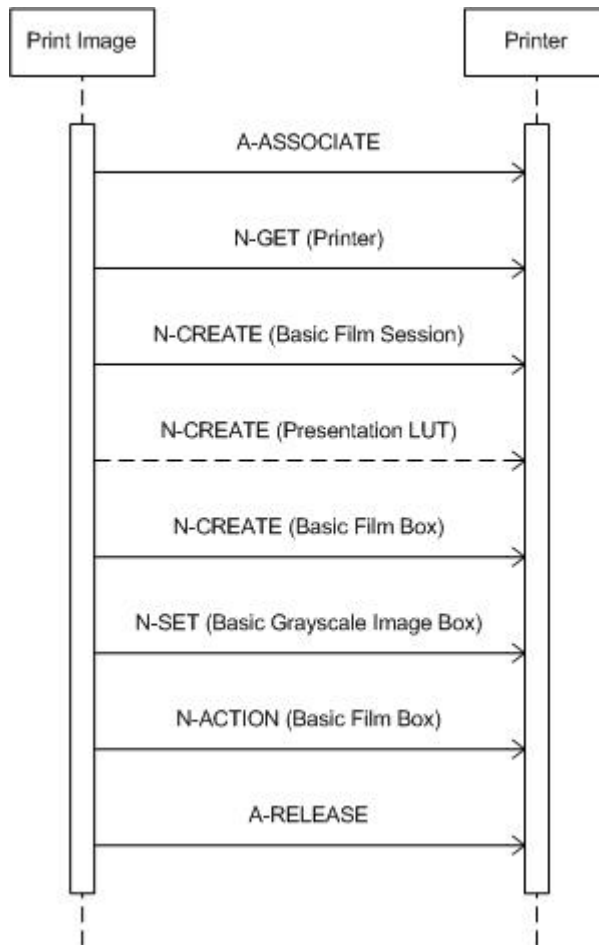

Figure 5: (Real World) Activity - Print Management as SCU

This RWA involves the printing of an image by sending the selected image data to a Print Management SCP (i.e. printer).
 The DigitalDiagnost AE cannot handle any N-EVENT-REPORT messages.

A print job (film session) comprises one single film box with one single image (that is composed of 1..N modality images).
 Print jobs are handled by Print queues.
 Each configured Printer has its specific job queue.
 All Printer queues share the same HCU GUI status button.

Print jobs may be generated in two modes:

- Auto Print
- Manual Print

In Auto Print mode, (1..N) modality images are composed to one logical film image (film page) according to a preconfigured Examination specific layout (size, orientation, image number, image position, scaling, overlay, annotation and shutter information, etc.).

If a preconfigured layout cannot be used (layout conflict), or the layout cannot be filled then a GUI with a preview pops up. The automatic GUI pop-up can also be forced by configuration.

In Manual Print mode, (1..N) modality images are composed on one film image by manual arrangement of the user, allowing for a print preview.

Depending on the response status and the configuration the DigitalDiagnost AE may perform a retry

4.2.1.3.2.2. Proposed Presentation Contexts

Table 14: Proposed Presentation Contexts for (Real-World) Activity – Print Management As SCU

Presentation Context Table					
Abstract Syntax		Transfer Syntax		Role	Extended Negotiation
Name	UID	Name List	UID List		
Basic Grayscale Print Management Meta SOP Class	1.2.840.10008.5.1.1.9	Explicit VR Little Endian	1.2.840.10008.1.2.2	SCU	None
		Implicit VR Little Endian	1.2.840.10008.1.2.1		
		Implicit VR Little Endian	1.2.840.10008.1.2		
>Basic Film Box SOP Class	1.2.840.10008.5.1.1.2	Explicit VR Little Endian	1.2.840.10008.1.2.2	SCU	None
		Implicit VR Little Endian	1.2.840.10008.1.2.1		
		Implicit VR Little Endian	1.2.840.10008.1.2		
>Basic Film Session SOP Class	1.2.840.10008.5.1.1.1	Explicit VR Big Endian	1.2.840.10008.1.2.2	SCU	None
		Explicit VR Little Endian	1.2.840.10008.1.2.1		
		Implicit VR Little Endian	1.2.840.10008.1.2		
>Basic Grayscale Image Box SOP Class	1.2.840.10008.5.1.1.4	Explicit VR Big Endian	1.2.840.10008.1.2.2	SCU	None
		Explicit VR Little Endian	1.2.840.10008.1.2.1		
		Implicit VR Little Endian	1.2.840.10008.1.2		
>Printer SOP Class	1.2.840.10008.5.1.1.16	Explicit VR Big Endian	1.2.840.10008.1.2.2	SCU	None
		Explicit VR Little Endian	1.2.840.10008.1.2.1		
		Implicit VR Little Endian	1.2.840.10008.1.2		
Presentation LUT SOP Class ³	1.2.840.10008.5.1.1.23	Explicit VR Big Endian	1.2.840.10008.1.2.2	SCU	None
		Explicit VR Little Endian	1.2.840.10008.1.2.1		
		Implicit VR Little Endian	1.2.840.10008.1.2		

This section specifies each IOD created (including private IOD's).

Abbreviations used in the Module table for the column "Presence of Value" are:

- ALWAYS The attribute is always present with a value
- EMPTY The attribute is always present without any value (attribute sent zero length)
- VNAP The attribute is always present and its Value is Not Always Present (attribute sent zero length if no value is present)
- ANAP The attribute is present under specified condition – if present then it will always have a value

³ Configurable option

VNAPCV	The attribute is present under specified condition – if present then its Value is Not Always Present (attribute sent zero length if condition applies and no value is present)
ANAPEV	The attribute is present under specified condition – if present then it will not have any value

The abbreviations used in the Module table for the column "Source" are:

AUTO	The attribute value is generated automatically
CONFIG	The attribute value source is a configurable parameter
COPY	The attribute value source is another SOP instance
FIXED	The attribute value is hard-coded in the application
IMPLICIT	The attribute value source is a user-implicit setting
MPPS	The attribute value is the same as that use for Modality Performed Procedure Step
MWL	The attribute value source is a Modality Worklist
USER	The attribute value source is explicit user input

4.2.1.3.2.3. SOP Specific Conformance for Basic Film Box SOP Class of the Basic Grayscale Print Management Meta SOP Class

All details regarding the specific conformance, including response behavior to all status codes, both from an application level and communication errors are provided in the next tables

All failures and warnings of unsolvable problems are treated the same way: the print job fails and is retried. After the configured number of retries the job will be removed from the Printer specific print queue and added again at the end of the queue. The HCU GUI button then indicates failure (red) until the next job in any print queue has succeeded.

Jobs failing repeatedly after re-queuing can be deleted manually by the operator.

4.2.1.3.2.3.1. Dataset Specific Conformance for Basic Film Box N-ACTION SCU

Table 15: N-ACTION-RQ Status Response

Service Status	Code	Further Meaning	Description
Success	0000	Successful operation	The print job continues.
Warning	B603	Film Box SOP Instance SOP instances (empty hierarchy does not contain image box page)	The print job continues.
	B604	Image size is larger than image box size, the image has been demagnified.	The print job continues.
	B609	Image size is larger than the image box size. The image has been cropped to fit.	The print job continues.
	B60A	Image size or combined print image size is larger than the image box size. Image or combined print image has been decimated to fit.	The print job continues.
Failure	0119	Class instance conflict	The print job fails and is retried.
	0210	Duplicate invocation	The print job fails and is retried.

Service Status	Code	Further Meaning	Description
	0115	Invalid argument value	The print job fails and is retried.
	0120	Missing attribute	The print job fails and is retried.
	0121	Missing attribute value	The print job fails and is retried.
	0212	Mistyped argument	The print job fails and is retried.
	0105	No such attribute	The print job fails and is retried.
	0118	No such SOP class	The print job fails and is retried.
	0110	Processing failure	The print job fails and is retried.
	0213	Resource limitation	The print job fails and is retried.
	0211	Unrecognized operation	The print job fails and is retried.
	0117	Invalid SOP instance (Invalid object instance)	The print job fails and is retried.
	0112	No such SOP instance (No such object instance)	The print job fails and is retried.
	C602	Unable to create print job SOP instance; print queue is full	The print job fails and is retried.
	C603	Image size is larger than image box size	The print job fails and is retried.
	C613	Combined print image size is larger than the image box size	The print job fails and is retried.

4.2.1.3.2.3.2. Dataset Specific Conformance for Basic Film Box N-CREATE SCU

Table 16: Basic Film Box Presentation Module

Attribute Name	Tag	VR	Value	Presence of Value	Source	Comment
Image Display Format	2010,0010	ST		ALWAYS	AUTO	CUSTOM\1, STANDARD\1,1
Film Orientation	2010,0040	CS	LANDSCAPE, PORTRAIT	ALWAYS	CONFIG	
Film Size ID	2010,0050	CS	10INX12IN, 10INX14IN, 11INX14IN, 11INX17IN, 14INX14IN, 14INX17IN, 24CMX24CM, 24CMX30CM, 8_5INX11IN, 8INX10IN, A3, A4	ALWAYS	CONFIG	
Magnification Type	2010,0060	CS	NONE	ALWAYS	AUTO	
Max Density	2010,0130	US	300	ALWAYS	AUTO	
Trim	2010,0140	CS	NO, YES	ALWAYS	AUTO	
Configuration Information	2010,0150	ST		ALWAYS	AUTO	Contains a vendor specific Lookup-table (LUT), should be applied by the DICOM Printer if LUT data is present

Table 17: Basic Film Box Relationship Module

Attribute Name	Tag	VR	Value	Presence of Value	Source	Comment
Referenced Film Session Sequence	2010,0500	SQ		ALWAYS	AUTO	Parent film session and Image Box session
>Referenced SOP Class UID	0008,1150	UI	1.2.840.10008.5.1.1.1	ALWAYS	AUTO	
>Referenced SOP Instance UID	0008,1155	UI	1.2.840.10008.5.1.1.1	ALWAYS	AUTO	

Referenced Image Box Sequence	2010,0510	SQ		ALWAYS	AUTO	
>Referenced SOP Class UID	0008,1150	UI	1.2.840.10008.5.1.1.4	ALWAYS	AUTO	
>Referenced SOP Instance UID	0008,1155	UI	1.2.840.10008.5.1.1.4	ALWAYS	AUTO	
Referenced Presentation LUT Sequence ⁴	2050,0500	SQ		VNAP	AUTO	A sequence which provides references to a Presentation LUT related SOP Class/Instance pairs. Only a single Item shall be included in this sequence.
>Referenced SOP Class UID	0008,1150	UI	1.2.840.10008.5.1.1.23	ALWAYS	AUTO	
>Referenced SOP Instance UID	0008,1155	UI		ALWAYS	AUTO	

Table 18: N-CREATE-RQ Status Response

Service Status	Code	Further Meaning	Description
Success	0000	Successful operation	The print job continues.
Warning	B605	Requested min or max. density outside of printer's operating range. Printer will use its resp. min/max. density instead	The print job continues.
Failure	0119	Class instance conflict	The print job fails and is retried.
	0210	Duplicate invocation	The print job fails and is retried.
	0111	Duplicate SOP instance	The print job fails and is retried.
	0106	Invalid attribute value	The print job fails and is retried.
	0120	Missing attribute	The print job fails and is retried.
	0121	Missing attribute value	The print job fails and is retried.
	0212	Mistyped argument	The print job fails and is retried.
	0105	No such attribute	The print job fails and is retried.
	0118	No such SOP class	The print job fails and is retried.
	0110	Processing failure	The print job fails and is retried.
	0213	Resource limitation	The print job fails and is retried.
	0211	Unrecognized operation	The print job fails and is retried.
	C616	There is an existing film box that has not been printed and N-ACTION at the film session level is not supported. A new film box will not be created when a previous film box has not been printed.	The print job fails and is retried.
	0117	Invalid SOP instance	The print job fails and is retried.
0112	No such SOP instance	The print job fails and is retried.	

4.2.1.3.2.4. SOP Specific Conformance for Basic Film Session SOP Class of the Basic Grayscale Print Management Meta SOP Class

All details regarding the specific conformance, including response behavior to all status codes, both from an application level and communication errors are provided in next tables.

All failures and warnings of unsolvable problems are treated the same way: the print job fails and is retried. After the configured number of retries the job will be removed

⁴ Configurable option

from the Printer specific print queue and added again at the end of the queue. The HCU GUI button then indicates failure (red) until the next job in any print queue has succeeded.

Jobs failing repeatedly after re-queuing can be deleted manually by the operator.

4.2.1.3.2.4.1. Dataset Specific Conformance for Basic Film Session N-CREATE SCU

Table 19: Basic Film Session Presentation Module

Attribute Name	Tag	VR	Value	Presence of Value	Source	Comment
Number of Copies	2000,0010	IS		ALWAYS	IMPLICIT	Applied values 1 to 99
Print Priority	2000,0020	CS	HIGH	ALWAYS	AUTO	
Medium Type	2000,0030	CS	BLUE FILM, CLEAR FILM, PAPER	ALWAYS	IMPLICIT	
Film Destination	2000,0040	CS	MAGAZINE, PROCESSOR	ALWAYS	AUTO	
Film Session Label	2000,0050	LO	Philips Medical Systems	ALWAYS	AUTO	

Table 20: N-CREATE-RQ Status Response

Service Status	Code	Further Meaning	Description
Success	0000	Successful operation	The print job continues.
Warning	B600	Memory allocation not supported	The print job continues.
Failure	0119	Class instance conflict	The print job fails and is retried.
	0210	Duplicate invocation	The print job fails and is retried.
	0111	Duplicate SOP instance	The print job fails and is retried.
	0106	Invalid attribute value	The print job fails and is retried.
	0120	Missing attribute	The print job fails and is retried.
	0121	Missing attribute value	The print job fails and is retried.
	0212	Mistyped argument	The print job fails and is retried.
	0105	No such attribute	The print job fails and is retried.
	0118	No such SOP class	The print job fails and is retried.
	0110	Processing failure	The print job fails and is retried.
	0213	Resource limitation	The print job fails and is retried.
	0211	Unrecognized operation	The print job fails and is retried.
	0117	Invalid SOP instance	The print job fails and is retried.
0112	No such SOP instance	The print job fails and is retried.	

4.2.1.3.2.5. SOP Specific Conformance for Presentation LUT SOP Class of the Basic Grayscale Print Management Meta SOP Class

All details regarding the specific conformance, including response behavior to all status codes, both from an application level and communication errors are provided in next tables.

All failures and warnings of unsolvable problems are treated the same way: the print job fails and is retried. After the configured number of retries the job will be removed from the Printer specific print queue and added again at the end of the queue. The HCU GUI button then indicates failure (red) until the next job in any print queue has succeeded.

Jobs failing repeatedly after re-queuing can be deleted manually by the operator.

4.2.1.3.2.5.1. Dataset Specific Conformance for Presentation LUT N-CREATE SCU

Table 21: Presentation LUT Module

Attribute Name	Tag	VR	Value	Presence of Value	Source	Comment
Presentation LUT Shape	2050,0020	CS	IDENTITY	ALWAYS	AUTO	

Table 22: N-CREATE-RQ Status Response

Service Status	Code	Further Meaning	Description
Success	0000	Successful operation	The print job continues.
Warning	B605	Requested Min Density or Max Density outside of printer's operating range. The printer will use its respective minimum or maximum density value instead	The print job continues. (Pieter, I think this Warning is not applicable with IDENTITY LUT, Heinrich)

4.2.1.3.2.6. SOP Specific Conformance for Basic Grayscale Image Box SOP Class of the Basic Grayscale Print Management Meta SOP Class

All details regarding the specific conformance, including response behavior to all status codes, both from an application level and communication errors are provided in next tables.

All failures and warnings of unsolvable problems are treated the same way: the print job fails and is retried. After the configured number of retries the job will be removed from the Printer specific print queue and added again at the end of the queue. The HCU GUI button then indicates failure (red) until the next job in any print queue has succeeded.

Jobs failing repeatedly after re-queuing can be deleted manually by the operator.

4.2.1.3.2.6.1. Dataset Specific Conformance for Basic Grayscale Image Box N-SET SCU

Table 23: Image Box Pixel Presentation Module

Attribute Name	Tag	VR	Value	Presence of Value	Source	Comment
Image Position	2020,0010	US	1	ALWAYS	AUTO	
Polarity	2020,0020	CS	NORMAL	ALWAYS	AUTO	
Basic Grayscale Image Sequence	2020,0110	SQ		ALWAYS	AUTO	
>Samples per Pixel	0028,0002	US	1	ALWAYS	AUTO	
>Photometric Interpretation	0028,0004	CS	MONOCHROME1, MONOCHROME2	ALWAYS	IMPLICIT	
>Rows	0028,0010	US		ALWAYS	IMPLICIT	Depending on the selected printer type and film size
>Columns	0028,0011	US		ALWAYS	IMPLICIT	Depending on the selected printer type and film size
>Bits Allocated	0028,0100	US	16, 8	ALWAYS	AUTO	
>Bits Stored	0028,0101	US	12, 8	ALWAYS	AUTO	
>High Bit	0028,0102	US	11, 7	ALWAYS	AUTO	
>Pixel Representation	0028,0103	US	0x0000	ALWAYS	AUTO	
>Pixel Data	7FE0,0010	O W/ OB		ALWAYS	AUTO	

Table 24: N-SET-RQ Status Response

Service Status	Code	Further Meaning	Description
Success	0000	Successful operation	The print job continues.
Warning	B604	Image size larger than image box, the image has been demagnified.	The print job continues.
	B605	Requested min dens. or max. density outside of printer's operating range. Printer uses its resp. min./max. density instead.	The print job continues.
	B609	Image size is larger than the Image Box size. The image has been cropped to fit.	The print job continues.
	B60A	Image size or combined print image size is larger than the image box size. The image or combined print image has been decimated to fit.	The print job continues.
Failure	0119	Class instance conflict	The print job fails and is retried.
	0210	Duplicate invocation	The print job fails and is retried.
	0106	Invalid attribute value	The print job fails and is retried.
	0212	Mistyped argument	The print job fails and is retried.
	0121	Missing attribute value	The print job fails and is retried.
	0105	No such attribute	The print job fails and is retried.
	0118	No such SOP class	The print job fails and is retried.
	0110	Processing failure	The print job fails and is retried.
	0213	Resource limitation	The print job fails and is retried.
	0211	Unrecognized operation	The print job fails and is retried.
	0117	Invalid SOP instance	The print job fails and is retried.
	0112	No such SOP instance	The print job fails and is retried.
	C603	Image size is larger than image box size	The print job fails and is retried.
	C605	Insufficient memory in printer to store the image	The print job fails and is retried.
C613	Combined print image size is larger than the image box size	The print job fails and is retried.	

4.2.1.3.2.7. SOP Specific Conformance for Printer SOP Class of the Basic Grayscale Print Management Meta SOP Class

All details regarding the specific conformance, including response behavior to all status codes, both from an application level and communication errors are provided in next tables.

All failures and warnings of unsolvable problems are treated the same way: the print job fails and is retried. After the configured number of retries the job will be removed from the Printer specific print queue and added again at the end of the queue. The HCU GUI button then indicates failure (red) until the next job in any print queue has succeeded.

Jobs failing repeatedly after re-queuing can be deleted manually by the operator.

4.2.1.3.2.7.1. Dataset Specific Conformance for Printer N-GET SCU

Table 25: Printer Module

Attribute Name	Tag	VR	Value	Presence of Value	Source	Comment
Printer Status Info	2110,0020	CS		ALWAYS	AUTO	

Table 26: N-GET-RQ Status Response

Service Status	Code	Further Meaning	Description
Success	0000	Successful operation	The print job continues.
Warning	0107	Attribute List Error	The print job fails and is retried.
	0001	Requested optional attributes are not supported	The print job fails and is retried.
Failure	0119	Class instance conflict	The print job fails and is retried.
	0210	Duplicate invocation	The print job fails and is retried.
	0212	Mistyped argument	The print job fails and is retried.
	0118	No such SOP class	The print job fails and is retried.
	0110	Processing failure	The print job fails and is retried.
	0213	Resource limitation	The print job fails and is retried.
	0211	Unrecognized operation	The print job fails and is retried.
	0117	Invalid SOP instance	The print job fails and is retried.
0112	No such SOP instance	The print job fails and is retried.	

4.2.1.3.2.7.2. Dataset Specific Conformance for Printer N-EVENT-REPORT SCP

Table 27: Printer Module

Attribute Name	Tag	VR	Value	Presence of Value	Source	Comment
Printer Status Info	2110,0020	CS		ALWAYS	AUTO	

Table 28: N-EVENT-REPORT-RSP Status Response

Service Status	Event Type ID	Description
Normal	1	The N-EVENT-REPORT-RSP is sent to the SCP with: Status = 0 Event Type ID = 1 Information is logged. The print job continues.
Warning	2	The N-EVENT-REPORT-RSP is sent to the SCP with: Status = 0 Event Type ID = 2 Warning is logged. The print job continues.
Failure	3	The N-EVENT-REPORT-RSP is sent to the SCP with: Status = 0 Event Type ID = 3 Error is logged. The print job fails and is retried.

4.2.1.3.3. (Real-World) Activity – Image Export

4.2.1.3.3.1. Description and Sequencing of Activities

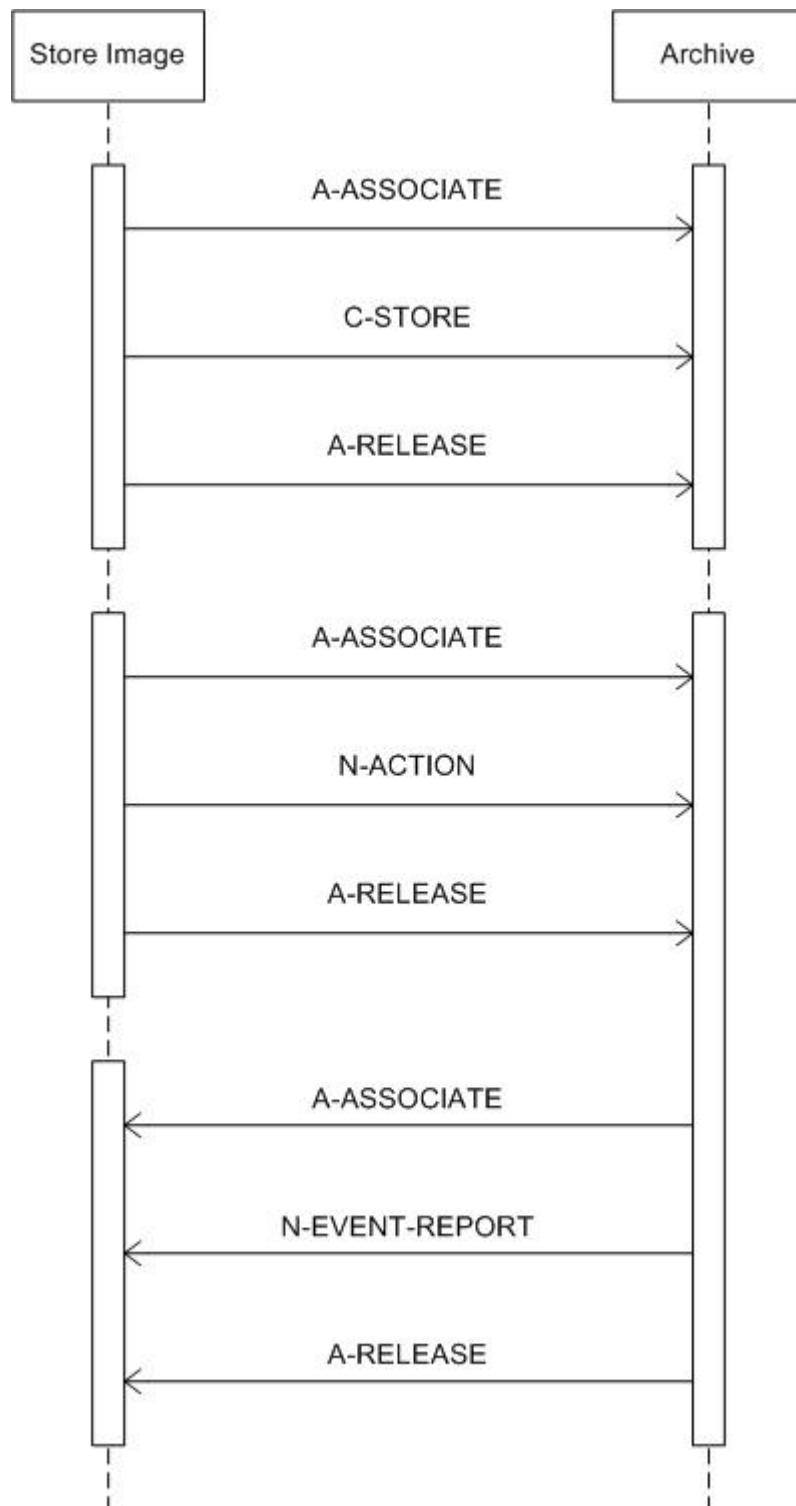

Figure 6: (Real World) Activity - Image Export

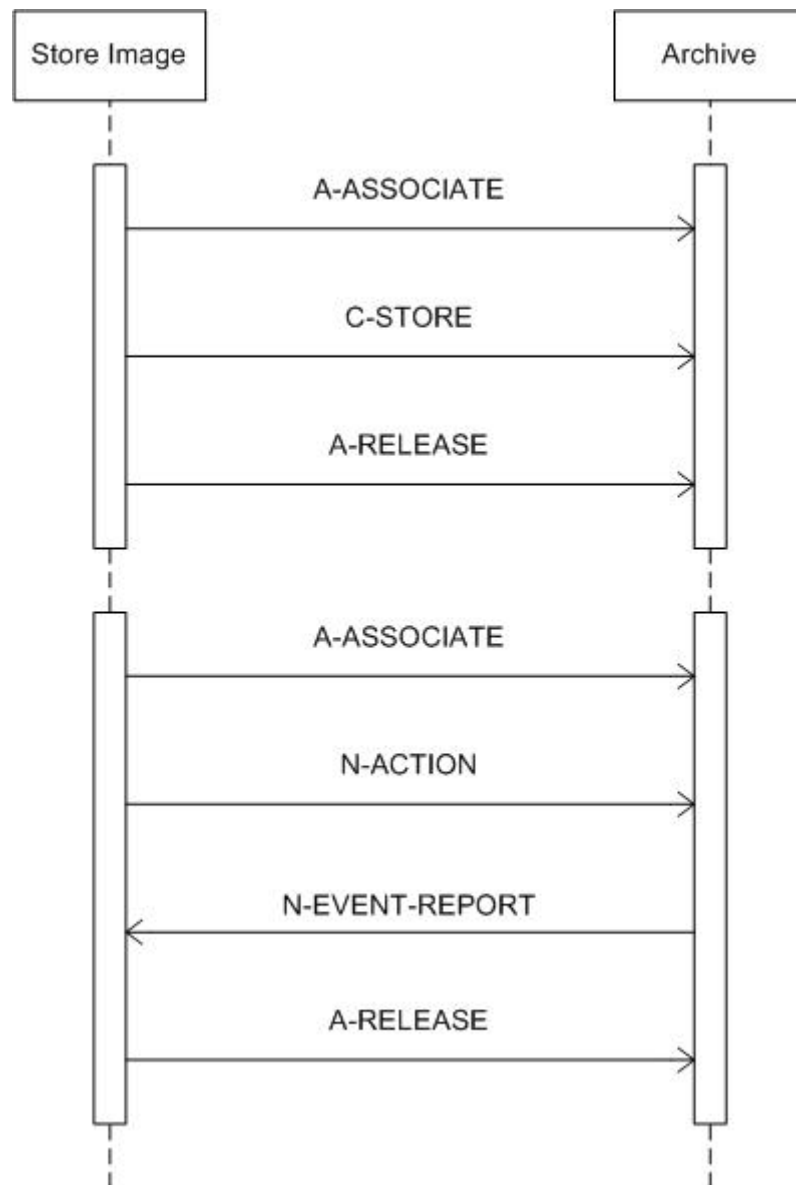

Figure 7: (Real World) Activity - Image Export

The storage commitment option of DigitalDiagnost requires that storage commitment is configured.

This RWA may be initiated in two ways.

- In the viewer, after clicking the Store button the DigitalDiagnost AE shall store the selected images at the selected Storage SCP (from the list of configured Storage SCP's).
- During an examination, after clicking the Confirm button the DigitalDiagnost AE shall automatically store the related images of the performed procedure step at the configured Storage SCP.

The DigitalDiagnost AE shall request an association with the remote Storage SCP for the applicable Storage SOP classes. After accepting the association the DigitalDiagnost AE shall send the store request, wait for response, and then release the association. The store response status may be inspected on the UI. The transferred image shall not be deleted from the system.

Depending on the status of the store and the configuration the DigitalDiagnost AE may queue store requests for retry. The queued store requests can be aborted from the UI.

After Store images the DigitalDiagnost AE shall automatically request commitment of images at the configured Storage Commitment SCP. For each stored image it shall request a new association with the remote Storage Commitment SCP for the Storage Commitment SOP class.

After accepting the association the DigitalDiagnost AE shall send the action request, wait for response, and then release the association. Depending on the configuration the storage commitment report may be received either synchronously or asynchronously.

The storage commitment results are displayed in the Patient List (“Number of successful commitments”) and in the Viewing tool per single image.

Depending on the status of the action and the configuration the DigitalDiagnost AE may retry to commit an image.

4.2.1.3.3.2. Proposed Presentation Contexts

Table 29: Proposed Presentation Contexts for (Real-World) Activity – Image Export

Presentation Context Table					
Abstract Syntax		Transfer Syntax		Role	Extended Negotiation
Name	UID	Name List	UID List		
Computed Radiography Image Storage SOP Class	1.2.840.10008.5.1.4.1.1.1	Explicit VR Big Endian	1.2.840.10008.1.2.2	SCU	None
		Explicit VR Little Endian	1.2.840.10008.1.2.1		
		Implicit VR Little Endian	1.2.840.10008.1.2		
Digital X-Ray Image Storage - Presentation. SOP	1.2.840.10008.5.1.4.1.1.1.1	Explicit VR Big Endian	1.2.840.10008.1.2.2	SCU	None
		Explicit VR Little Endian	1.2.840.10008.1.2.1		
		Implicit VR Little Endian	1.2.840.10008.1.2		
Secondary Capture Image Storage SOP Class	1.2.840.10008.5.1.4.1.1.7	Explicit VR Big Endian	1.2.840.10008.1.2.2	SCU	None
		Explicit VR Little Endian	1.2.840.10008.1.2.1		
		Implicit VR Little Endian	1.2.840.10008.1.2		

Note that Explicit VR Little Endian is the preferred transfer syntax.

4.2.1.3.3.3. SOP Specific Conformance for Storage SOP Classes

This section includes the SOP specific behavior, i.e. error codes, error and exception handling, time-outs, etc.

Behavior of an Application Entity SOP class are summarized as shown in next table. The standard as well as the manufacturer specific status codes and their corresponding behavior are specified.

Table 30: C-STORE-RQ Status Response

Service Status	Code	Further Meaning	Description
Success	0000	Storage is complete	Success is logged. The entry is removed from the export queue.

Service Status	Code	Further Meaning	Description
Failure	A7xx	Refused: Out of resources	The user is notified of the archive failure (via pop-up). The reason is logged. After a configured period of time the storage will be retried up to a configured number of times.
	A9xx	Error: Data set does not match SOP class	The user is notified of the archive failure (via pop-up). The reason is logged. After a configured period of time the storage will be retried up to a configured number of times.
	Cxxx	Error: Cannot understand	The user is notified of the archive failure (via pop-up). The reason is logged. After a configured period of time the storage will be retried up to a configured number of times.
Warning	B000	Coercion of data elements	The warning is logged. The entry is removed from the export queue.
	B006	Elements discarded	The warning is logged. The entry is removed from the export queue.
	B007	Data set does not match SOP class	The warning is logged. The entry is removed from the export queue.

The status can be inspected via the user interface

4.2.1.3.4. (Real-World) Activity – Modality Performed Procedure Step As SCU

4.2.1.3.4.1. Description and Sequencing of Activities

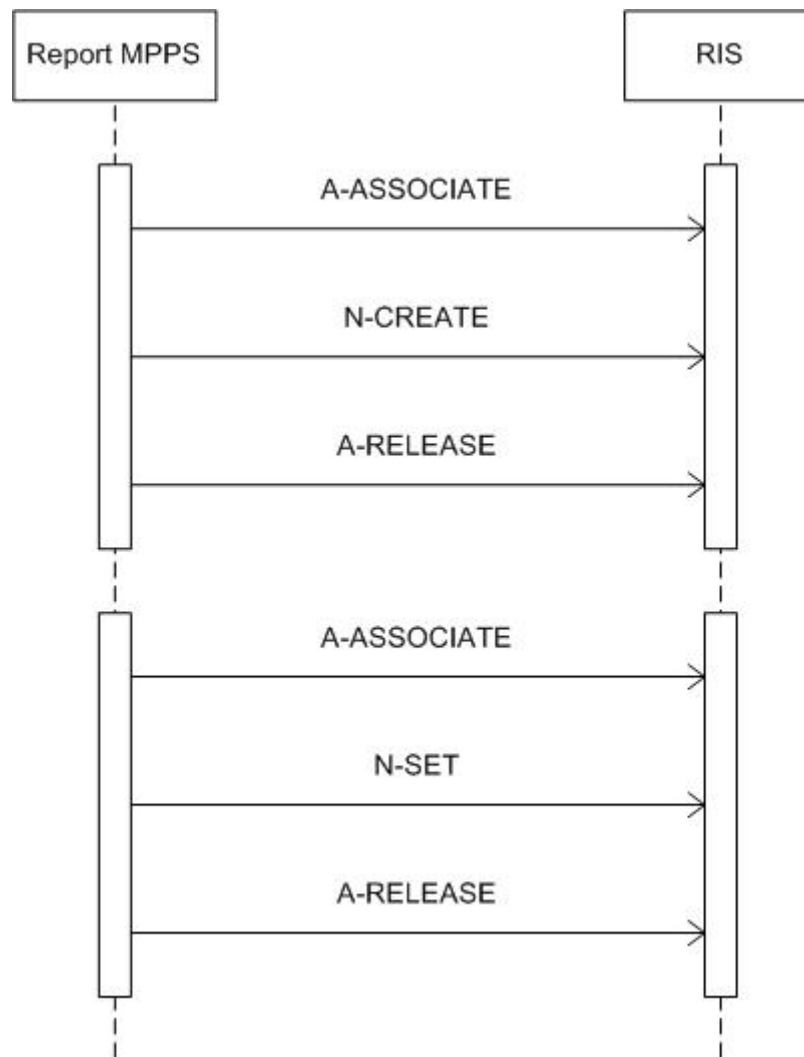

Figure 8: (Real World) Activity - Modality Performed Procedure Step As SCU

The MPPS option of DigitalDiagnost requires that the Basic Worklist Management option is enabled.

Description of Activities

A DigitalDiagnost Examination is regarded equivalent to a DICOM Procedure Step. It is scheduled or manually entered before an acquisition is taken, and performed by taking acquisitions. Since an examination may be re-opened after having been closed, and each examination workflow context is enclosed in one MPPS, one examination may result in 0 to <n> MPPS instances.

After the first acquisition for a Scheduled Procedure Step has been performed, the system sets the MPPS status of the related examination to "IN PROGRESS" and generates an initial MPPS IN PROGRESS message. The system does not generate intermediate MPPS IN PROGRESS messages for subsequent acquisitions of this Scheduled Procedure Step instance.

DigitalDiagnost also generates MPPS IN PROGRESS messages for images that are re-processed by the Viewing tool, i.e. outside an acquisition session. DigitalDiagnost does not generate MPPS messages for simple image re-export and image printing by the Viewing tool.

After finishing the appropriate acquisition(s) or reprocessing, when returning to the patient list the system will change the MPPS status of the related examination to "COMPLETED" and generate an MPPS COMPLETED message.

DigitalDiagnost also generates MPPS messages for unscheduled examinations.

The MPPS COMPLETED message will list the UID's of all related DICOM images and the number and format of (optionally) generated prints⁵.

After abandoning or discontinuing a procedure step, the operator may set the MPPS status of the related examination to "DISCONTINUED" and the system generates a MPPS DISCONTINUED message. The reason for abandoning or discontinuing a procedure step is not specified.

The operator may interchange the performed sequence order of scheduled procedure steps.

MPPS messages may interleave. Depending on the applicational workflow optimization by the user, an MPPS sequence like this may come up:

```
MPPS / SOP Instance UID 1: N-CREATE (IN PROGRESS)
MPPS / SOP Instance UID 2: N-CREATE (IN PROGRESS)
MPPS / SOP Instance UID 3: N-CREATE (IN PROGRESS)
...
MPPS / SOP Instance UID 2: N-SET (COMPLETED)
MPPS / SOP Instance UID 1: N-SET (COMPLETED)
MPPS / SOP Instance UID 3: N-SET (COMPLETED)
```

(i.e.: running multiple procedure steps 'in parallel').

Sequencing of Activities

After storing a performed procedure step the DigitalDiagnost AE shall request an association with the configured remote Study Management SCP. After accepting the association the DigitalDiagnost AE shall send a Create request, wait for response, and then release the association.

After performing an examination the DigitalDiagnost AE shall request an association with the configured remote Study Management SCP. After accepting the association the DigitalDiagnost AE shall send a set request, wait for response, and then release the association.

Depending on the response status and the configuration the DigitalDiagnost AE may perform retries.

4.2.1.3.4.2. Proposed Presentation Contexts

Table 31: Proposed Presentation Contexts for (Real-World) Activity – Modality Performed Procedure Step As SCU

Presentation Context Table					
Abstract Syntax		Transfer Syntax		Role	Extended Negotiation
Name	UID	Name List	UID List		
Modality Performed Procedure Step SOP Class	1.2.840.10008.3.1.2.3.3	Explicit VR Big Endian	1.2.840.10008.1.2.2	SCU	None
		Explicit VR Little Endian	1.2.840.10008.1.2.1		
		Implicit VR Little Endian	1.2.840.10008.1.2		

⁵ Not for prints of images re-processed by the Viewer.

Note that Explicit VR Little Endian is the preferred transfer syntax.

4.2.1.3.4.3. SOP Specific Conformance for Modality Performed Procedure Step SOP Class

When performing the first acquisition of a Scheduled or Unscheduled Procedure Step, DigitalDiagnost generates a MPPS IN PROGRESS message.

DigitalDiagnost does not generate intermediate IN PROGRESS (N-SET) messages.

DigitalDiagnost includes the Film Consumption Sequence, if Prints of images are sent to a Hardcopy unit or Printer server.

If, for application reasons, the operator decides to perform a Procedure Step (= Examination) not on the Digital Detector, but on the attached conventional device (film cassette), the resulting MPPS instance does not list image references.

If the operator decides to perform a Procedure Step partly by the Digital Detector and partly by the attached conventional film cassette, the result of this Procedure Step is reported by 2 separate MPPS instances: one for the digital part, the other for the conventional part.

An MPPS sequence like this comes up:

MPPS / SOP Instance UID 1 (digital part):	N-CREATE (IN PROGRESS)
MPPS / SOP Instance UID 2 (conventional part):	N-CREATE (IN PROGRESS)
MPPS / SOP Instance UID 1 (digital part):	N-SET (COMPLETED)
MPPS / SOP Instance UID 2 (conventional part):	N-SET (COMPLETED)

Assisted Acquisition Protocol Setting Option

DigitalDiagnost by default derives the specific acquisition protocol from the Scheduled Protocol Code Sequence Items. Any single Item results in an Examination.

DigitalDiagnost supports 3 more (configurable) 'mapping' relations, as shown below:

- Examination is selected from Scheduled Protocol Code Items->Code Value (0040,0008) (default)
- Examination is selected from Scheduled Procedure Step Description (0040,0007)
- Examination is selected from Requested Procedure Code Items->Code Value (0032,1064)
- Examination is selected from Requested Procedure Description (0032,1060)

DigitalDiagnost does not evaluate the attributes Coding Scheme Version (0008,0103), Coding Scheme Designator (0008,0102), Code Meaning (0008,0104), but only the Code Value (0008,0100), for mapping the examination settings. I.e. DigitalDiagnost expects that any used Code Value is unique (unambiguous) within a given RIS domain.

Per Scheduled Procedure Step, DigitalDiagnost is able to accept up to 99 items in the Scheduled Protocol Code Sequence and Requested Procedure Code Sequence, respectively. If more items are sent, the supernumerary items are dropped, and an operator alert is created.

Restrictions Depending on Number of Scheduled Protocol Code Items

If the Scheduled Procedure Step contains only 1 Item in the Scheduled Protocol Code Sequence, there is nothing special, and this case is recommended.

If the Scheduled Procedure Step contains <n> items in the Scheduled Protocol Code Sequence, the Scheduled Procedure Step is split into <n> examinations, where any

single examination shows only 1 of the Scheduled Protocol Code Items, but all the other attributes are the same.

When such an examination is returned via MPPS, also the Performed Protocol Code Sequence will show only 1 item. If all <n> Scheduled Procedure Step Code Items are performed, <n> MPPS instances will be sent back to the RIS, and the sum of all Performed Protocol Code Items will be <n>.

All details regarding the specific conformance, including response behavior to all status codes, both from an application level and communication errors are provided in next table.

4.2.1.3.4.3.1. Dataset Specific Conformance for Modality Performed Procedure Step N-CREATE SCU

This section includes the dataset specific behavior, i.e. error codes, error and exception handling, time-outs, etc.

Table 32: MPPS Request Identifiers for N-CREATE-RQ

Attribute Name	Tag	VR	Value	Comment
Performed Procedure Step Information Module				
Performed Station AE Title	0040,0241	AE		
Performed Procedure Step Start Date	0040,0244	DA		
Performed Procedure Step Start Time	0040,0245	TM		
Performed Procedure Step Status	0040,0252	CS	IN PROGRESS	
Performed Procedure Step ID	0040,0253	SH		
Performed Station Name	0040,0242	SH		Zero length
Performed Location	0040,0243	SH		Zero length
Performed Procedure Step End Date	0040,0250	DA		
Performed Procedure Step End Time	0040,0251	TM		
Performed Procedure Step Description	0040,0254	LO		By default copied from the scheduled Procedure Step Description. If the operator performed different Protocol the actually performed protocol is used. May be zero length if unscheduled.
Performed Procedure Type Description	0040,0255	LO		
Procedure Code Sequence	0008,1032	SQ		Zero length if unscheduled or operator changed the requested Procedure Code
>Code Value	0008,0100	SH		Value from worklist
>Coding Scheme Designator	0008,0102	SH		Value from worklist
>Coding Scheme Version	0008,0103	SH		Value provided by the RIS code table or else zero length
>Code Meaning	0008,0104	LO		Value provided by the RIS code table or else zero length
Comments on the Performed Procedure Step	0040,0280	ST		
Performed Procedure Step Discontinuation Reason Code Sequence	0040,0281	SQ		

Attribute Name	Tag	VR	Value	Comment
Radiation Dose Module				
Image and Fluoroscopy Area Dose Product	0018,115E	DS		
Total Number of Exposures	0040,0301	US		
Comments on Radiation Dose	0040,0310	ST		
Exposure Dose Sequence	0040,030E	SQ		
SOP Common Module				
Specific Character Set	0008,0005	CS	ISO_IR 100	
Performed Procedure Step Relationship Module				
Patient's Name	0010,0010	PN		
Patient ID	0010,0020	LO		
Issuer of Patient ID	0010,0021	LO		Name of authority that issued the Patient ID
Patient's Birth Date	0010,0030	DA		
Patient's Sex	0010,0040	CS	F, M, O	
Scheduled Step Attribute Sequence	0040,0270	SQ		
>Study Instance UID	0020,000D	UI		
>Accession Number	0008,0050	SH		Zero length if unscheduled
>Requested Procedure Description	0032,1060	LO		Zero length if unscheduled
>Scheduled Procedure Step Description	0040,0007	LO		Zero length if unscheduled
>Scheduled Procedure Step ID	0040,0009	SH		Zero length if unscheduled
>Requested Procedure ID	0040,1001	SH		Zero length if unscheduled
>Referenced Study Sequence	0008,1110	SQ		No items if unscheduled or if sent without item in BWLM
>>Referenced SOP Class UID	0008,1150	UI		Value from worklist
>>Referenced SOP Instance UID	0008,1155	UI		Value from worklist
>Scheduled Protocol Code Sequence	0040,0008	SQ		
Referenced Patient Sequence	0008,1120	SQ		Zero length
Image Acquisition Results Module				
Modality	0008,0060	CS	CR, DX	
Study ID	0020,0010	SH		If scheduled requested Procedure ID. Else equipment generated study identifier
Performed Protocol Code Sequence	0040,0260	SQ		Zero Length if unscheduled or modified or appended and RIS code table does not provide values
>Code Value	0008,0100	SH		Value from worklist or RIS code table
>Coding Scheme Designator	0008,0102	SH		Value from worklist or RIS code table
>Coding Scheme Version	0008,0103	SH		Value from worklist or RIS code table or else zero length
>Code Meaning	0008,0104	LO		Value from worklist or RIS code table or else zero length
Performed Series Sequence	0040,0340	SQ		
Billing And Material Management Code Module				
Film Consumption Sequence	0040,0321	SQ		Only present if a printer is attached to the system

Table 33: N-CREATE-RQ Status Response

Service Status	Code	Further Meaning	Description
Success	0000	Successful operation	The SCP has successfully received the modality performed procedure step create request. Log entry.
Failure	0105	No such attribute	The command is reported to the user as failed. The reason is logged. No retry.
	0106	Invalid attribute value	The command is reported to the user as failed. The reason is logged. No retry.
	0110	Processing failure	The command is reported to the user as failed. The reason is logged. No retry.
	0111	Duplicate SOP instance	The command is reported to the user as failed. The reason is logged. No retry.
	0112	No such object instance	The command is reported to the user as failed. The reason is logged. No retry.
	0117	Invalid object instance	The command is reported to the user as failed. The reason is logged. No retry.
	0118	No such SOP class	The command is reported to the user as failed. The reason is logged. No retry.
	0119	Class-instance conflict	The command is reported to the user as failed. The reason is logged. No retry.
	0120	Missing attribute	The command is reported to the user as failed. The reason is logged. No retry.
	0121	Missing attribute value	The command is reported to the user as failed. The reason is logged. No retry.
	0210	Duplicate invocation	The command is reported to the user as failed. The reason is logged. No retry.
	0211	Unrecognized operation	The command is reported to the user as failed. The reason is logged. No retry.
	0212	Mistyped argument	The command is reported to the user as failed. The reason is logged. No retry.
	0213	Resource limitation	The command is reported to the user as failed. The reason is logged. After a configured period of time the storage will be retried up to a configured number of times.

Table 34: DICOM Command Communication Failure Behavior

4.2.1.3.4.3.2. Dataset Specific Conformance for Modality Performed Procedure Step N-SET SCU

This section includes the dataset specific behavior, i.e. error codes, error and exception handling, time-outs, etc.

Table 35: MPPS Request Identifiers for N-SET-RQ

Attribute Name	Tag	VR	Value	Comment
Performed Procedure Step Information Module				
Performed Procedure Step End Date	0040,0250	DA		
Performed Procedure Step End Time	0040,0251	TM		
Performed Procedure Step Status	0040,0252	CS	COMPLETED, DISCONTINUED	
Performed Procedure Step Description	0040,0254	LO		By default copied from the scheduled Procedure Step description. If the operator performed different Protocol the actually performed

Attribute Name	Tag	VR	Value	Comment
				protocol is used. May be zero length if unscheduled
Performed Procedure Type Description	0040,0255	LO		Zero length
Procedure Code Sequence	0008,1032	SQ		Zero length if unscheduled or operator changed the Requested Procedure Code
>Code Value	0008,0100	SH		Value from worklist
>Coding Scheme Designator	0008,0102	SH		Value from worklist
>Coding Scheme Version	0008,0103	SH		Value provided by the RIS code table or else zero length
>Code Meaning	0008,0104	LO		Value provided by the RIS code table or else zero length
Comments on the Performed Procedure Step	0040,0280	ST		Applied Value: '<n> rejected image(s) not referenced'
Performed Procedure Step Discontinuation Reason Code Sequence	0040,0281	SQ		Zero length if status is COMPLETED
>Code Value	0008,0100	SH	110513	
>Coding Scheme Designator	0008,0102	SH	DCM	
>Coding Scheme Version	0008,0103	SH		Zero length
>Code Meaning	0008,0104	LO		Applied Value: 'Discontinued for unspecified reason'
Radiation Dose Module				
Image and Fluoroscopy Area Dose Product	0018,115E	DS		Accumulated over all exposures of this MPPS inst. Not including reprocessed images. Include repeated exposures. Zero length if PCR plates were exposed on other system, or Discontinued without exposure
Total Number of Exposures	0040,0301	US		Not counting: reprocessed images. Including repeated exposures so may be greater than number of items in Referenced Image Sequence.
Comments on Radiation Dose	0040,0310	ST		Concatenated string of exposure values. Each exposure is described in one line of format: <index>, <acquisition name>, <int>kV, <float>mAs, <EI <int>, <filter name>, <float>dGycm2, <repeated exposure>, \r\n Note that names and numbers do not contain any commas. Incomplete values if PCR plates exposed on other system. No value if no exposure made.
Exposure Dose Sequence	0040,030E	SQ		No value for PCR plates exposed on other system, or

Attribute Name	Tag	VR	Value	Comment
				DISCONTINUED without exposure.
>KVP	0018,0060	DS		
>Exposure Time	0018,1150	IS		
>Radiation Mode	0018,115A	CS	PULSED	
>X-Ray Tube Current in uA	0018,8151	DS		
Image Acquisition Results Module				
Performed Protocol Code Sequence	0040,0260	SQ		Zero length if unscheduled or modified or appended and RIS code table does not provide values
>Code Value	0008,0100	SH		Value from worklist or RIS code table
>Coding Scheme Designator	0008,0102	SH		Value form worklist or RIS code table
>Coding Scheme Version	0008,0103	SH		Value from worklist or RIS code table or else zero length
>Code Meaning	0008,0104	LO		Value form worklist or RIS code table or else zero length
Performed Series Sequence	0040,0340	SQ		
>Protocol Name	0018,1030	LO		Name of the examination item that maps the Performed Protocol Code Value
>Series Instance UID	0020,000E	UI		
>Retrieve AE Title	0008,0054	AE		Value always zero length
>Series Description	0008,103E	LO		
>Performing Physician's Name	0008,1050	PN		
>Operators' Name	0008,1070	PN		Multi-value: zero length if no name entered, PCR plates were exposed on other system or Discontinued without expose
>Referenced Image Sequence	0008,1140	SQ		In Non-Tomo/Non-Stitching and CR examinations n items. Missing after conventional acquisition. No items from rejected exposures.
>>Referenced SOP Class UID	0008,1150	UI		
>>Referenced SOP Instance UID	0008,1155	UI	1.2.840.10008.5.1.4.1.1.1, 1.2.840.10008.5.1.4.1.1.1.1, 1.2.840.10008.5.1.4.1.1.7	
>Referenced Non-Image Composite SOP Instance Sequence	0040,0220	SQ		Zero length
Billing And Material Management Code Module				
Film Consumption Sequence	0040,0321	SQ		Only present if a printer is attached to the system and acquisitions were made on digital medium. Multiple items may be of same type and size
>Medium Type	2000,0030	CS		
>Film Size ID	2010,0050	CS		
>Number of Films	2100,0170	IS		

Table 36: N-SET-RQ Status Response

Service Status	Code	Further Meaning	Description
Success	0000	Successful operation	The SCP has successfully received the modality performed procedure step create request. Log entry.
Failure	0105	No such attribute	The command is reported to the user as failed. The reason is logged. No retry.
	0106	Invalid attribute value	The command is reported to the user as failed. The reason is logged. No retry.
	0110	Processing failure	The command is reported to the user as failed. The reason is logged. No retry.
	0111	Duplicate SOP instance	The command is reported to the user as failed. The reason is logged. No retry.
	0112	No such object instance	The command is reported to the user as failed. The reason is logged. No retry.
	0117	Invalid object instance	The command is reported to the user as failed. The reason is logged. No retry.
	0118	No such SOP class	The command is reported to the user as failed. The reason is logged. No retry.
	0119	Class-instance conflict	The command is reported to the user as failed. The reason is logged. No retry.
	0120	Missing attribute	The command is reported to the user as failed. The reason is logged. No retry.
	0121	Missing attribute value	The command is reported to the user as failed. The reason is logged. No retry.
	0210	Duplicate invocation	The command is reported to the user as failed. The reason is logged. No retry.
	0211	Unrecognized operation	The command is reported to the user as failed. The reason is logged. No retry.
	0212	Mistyped argument	The command is reported to the user as failed. The reason is logged. No retry.
	0213	Resource limitation	The command is reported to the user as failed. The reason is logged. After a configured period of time the storage will be retried up to a configured number of times.

4.2.1.3.5. (Real-World) Activity – Modality worklist As SCU

4.2.1.3.5.1. Description and Sequencing of Activities

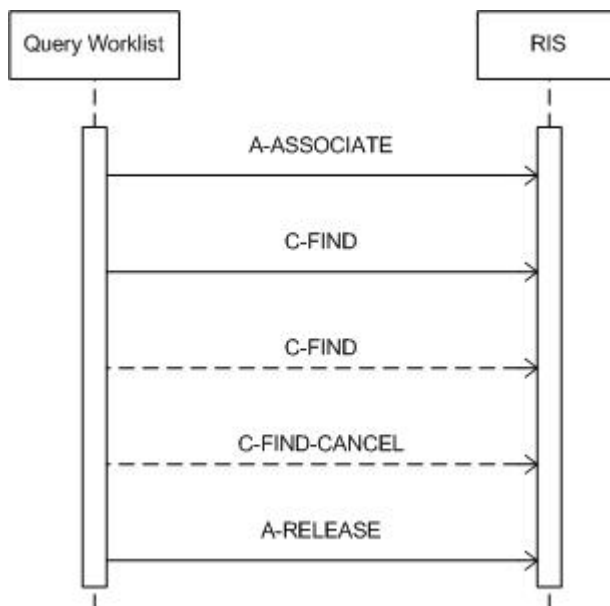

Figure 9: (Real World) Activity - Modality worklist As SCU

This RWA may be initiated in two ways.

- After clicking the Query Worklist button the DigitalDiagnost AE shall request an association with the configured remote Basic Worklist Management SCP. When the association is accepted the DigitalDiagnost AE shall send the broad query find request, wait for response, and then release the association.
- After clicking the Patient Query button - entering and confirming the matching key values - the DigitalDiagnost AE shall request an association with the configured remote Basic Worklist Management SCP. When the association is accepted the DigitalDiagnost AE shall send the patient query find request, wait for response, and then release the association.

Broad Query

Typically the patient/examination list is updated after a manual Broad Query with pre-configured matching keys. The operator shall initiate the Broad Query from the Patient List user interface. Eventually the operator shall receive a result notification.

Optionally the Broad Query may also be performed automatically in the system background. The time interval between subsequent background queries is configurable. Manual and automatic background queries are serialized and do not interfere with another.

The Broad Query will be cancelled automatically by C-FIND-CANCEL request after a configurable maximum number of returned Worklist items. After cancellation a notification is generated, for possible modification of the query key(s) or the key value(s) or the configured maximum number of Worklist items.

Patient Query

Typically the operator shall initiate the optional Patient Query when a patient arrives at the system for examination. DigitalDiagnost expects the operator to enter the value(s)

of the matching key(s). The matching key entry fields are individually (de)activated per configuration. At least one of the key entry fields must be filled when issuing a query.

4.2.1.3.5.2. Proposed Presentation Contexts

Table 37: Proposed Presentation Contexts for (Real-World) Activity – Modality worklist As SCU

Presentation Context Table					
Abstract Syntax		Transfer Syntax		Role	Extended Negotiation
Name	UID	Name List	UID List		
Modality Worklist Information Model - FIND SOP Class	1.2.840.10008.5.1.4.31	Explicit VR Big Endian	1.2.840.10008.1.2.2	SCU	None
		Explicit VR Little Endian	1.2.840.10008.1.2.1		
		Implicit VR Little Endian	1.2.840.10008.1.2		

4.2.1.3.5.3. SOP Specific Conformance for Modality Worklist Information Model - FIND SOP Class

This section includes the SOP specific behavior, i.e. error codes, error and exception handling, time-outs, etc.

4.2.1.3.5.3.1. Dataset Specific Conformance for Modality Worklist Information Model - FIND C-FIND SCU

The table below gives an overview of the matching keys for a Broad Query.

Table 38: Matching Keys for a Broad Query

Attribute Name	Tag	Note
Modality	0008,0060	This key may be used if the Worklist is generated for a "modality pool"; DigitalDiagnost may query for CR or DX modality, or both
Scheduled Station AE Title	0040,0001	DigitalDiagnost individual AE Title; default matching key
Scheduled Procedure Step Start Date	0040,0002	Configurable one of: date of <today> date of <today> and subsequent dates date of prior to and incl. <today> This key is used combined with AE Title or Modality type.

A virtual Wildcard matching (e.g. "DIDI*") in Scheduled AE Title may be configured on the DigitalDiagnost Application Entity. In this case the DICOM query is performed with universal matching (Scheduled AET value has zero length), and the filtering is done by local means.

In case of single value matching (e.g. "DIDI_ROOM1"), the returned Scheduled Station AE Title (0040,0001) may contain 1 single value only. The DigitalDiagnost AE cannot handle multiple values in this attribute and treats this case as 'not scheduled for local AET'.

The problem can be avoided by virtual Wildcard Matching (e.g. "DIDI_ROOM*"; this will accept e.g. "DIDI_ROOM1\DIDI_ROOM2"; see explanation above).

The date matching without any other key is not supported. When date matching is configured, the date value is continuously generated from local system time.

The modality query may be used for environments that do not schedule per individual modality's AE Title, but for a modality pool. Modality matching for both CR and DX may be configured on the DigitalDiagnost Application Entity. In this case the DICOM query typically is performed with universal matching (Modality value has zero length), and the filtering ("CR" OR "DX") is done by local means. Depending on further matching keys, the Query may also be performed by 2 subsequent C-FIND-Requests on the same association: the first with matching key value 'CR', the second with value 'DX'. The combined response items are returned to the user.

The table below gives an overview of the matching keys for a Patient Query.

Table 39: Matching Keys for a Patient Query

Attribute Name	Tag	Note
Accession Number	0008,0050	Identified from admission form or bar-code field
Modality	0008,0060	This key may be optionally added by the system (default: not added). Its value is configurable: CR (default), or DX, or both.
Patient's Name	0010,0010	Identified from admission form or bar code field.
Patient ID	0010,0020	Identified from admission form or bar-code field
Scheduled Station AE Title	0040,0001	This key may be optionally added by the system (default: not added). Its value is the DigitalDiagnost individual AE Title or else the optionally configured wildcard expression (e.g. DIDI_ROOM*)
Scheduled Procedure Step Start Date	0040,0002	This key may be optionally added by the system (default: not added). Its configurable value is one of: date of <today> date of <today> and subsequent dates date of prior to and incl. <today>
Requested Procedure ID	0040,1001	Identified from admission form or bar-code field

For Patient's Name wildcard matching support and input format are configurable, i.e.:

- Single field in DICOM notation;
- Two fields (last name, first name).

The table below should be read as follows:

Attribute Name: Attributes supported to build a Modality Worklist Request Identifier.

Tag: DICOM tag for this attribute.

VR: DICOM VR for this attribute.

M: Matching Keys for (automatic) Worklist Update.

R: Return Keys. An "X" will indicate that this attribute as Return Key with

zero length for Universal Matching.

Q: Interactive Query Key. An "X" will indicate that this attribute as matching key can be used.

D: Displayed Keys. An "X" indicates that this Worklist attribute is displayed to the user during a patient registration dialog.

IOD: An "X" indicates that this Worklist attribute is included into all object Instances created during performance of the related Procedure

Step.

Type of matching: The following types of matching exist:

- Single Value Matching
- List of UID Matching
- Wild Card Matching
- Range Matching

- Sequence Matching
- Universal Matching

Table 40: Worklist Request Identifier

Attribute Name	Tag	VR	M	R	Q	D	IOD	Type of Matching	Comment
SOP Common Module									
Specific Character Set	0008,0005	CS							Applied Value: ISO_IR 100
Patient Identification Module									
Patient's Name	0010,0010	PN			X	X		Single Value, Universal, WildCard	Optional matching key for patient query
Patient ID	0010,0020	LO			X	X		Single Value, Universal, WildCard	Optional matching key for patient query
Issuer of Patient ID	0010,0021	LO							
Other Patient IDs	0010,1000	LO							Evaluation requires optional GUI configuration
Patient Demographic Module									
Patient's Birth Date	0010,0030	DA				X			
Patient's Sex	0010,0040	CS				X			Defined values F, M, O
Patient's Age	0010,1010	AS							Not evaluated
Patient's Size	0010,1020	DS							Evaluation requires optional GUI configuration
Patient's Weight	0010,1030	DS							Evaluation requires optional GUI configuration
Ethnic Group	0010,2160	SH							
Patient Comments	0010,4000	LT							Truncated to 256 char; \n and \r replaced by ' '; Lading & trailing white space ignored.
Confidentiality Contrain on Patient Data Description	0040,3001	LO							
Patient Medical Module									
Medical Alerts	0010,2000	LO				X			Total length truncated to 64 char; \n and \r replaced by ' '; Lading & trailing white space ignored.
Contrast Allergies	0010,2110	LO				X			Total length truncated to 64 char; \n and \r replaced by ' '; Lading & trailing white space ignored.
Additional Patient History	0010,21B0	LT							Truncated to 256 char; \n and \r replaced by ' '; Lading & trailing white space ignored.
Pregnancy Status	0010,21C0	US				X			
Special Needs	0038,0050	LO				X			
Patient State	0038,0500	LO							
Visit Identification Module									
Admission ID	0038,0010	LO							Evaluation requires optional GUI configuration
Visit Status Module									
Current Patient Location	0038,0300	LO							
Scheduled Procedure Step Module									
Scheduled Procedure Step	0040,0100	SQ							

Attribute Name	Tag	VR	M	R	Q	D	IOD	Type of Matching	Comment
Sequence									
>Modality	0008,0060	CS	X		X	X		Single Value, Universal	Optional matching key; evaluation requires optional GUI configuration. Applied Value(s): CR, DX
>Requested Contrast Agent	0032,1070	LO				X			Evaluation requires optional GUI configuration
>Scheduled Station AE Title	0040,0001	AE	X		X			Single Value	DigitalDiagnost individual AE Title: default matching key
>Scheduled Procedure Step Start Date	0040,0002	DA	X		X	X		Single Value, Range	Configurable one of: date of <today>, date of <today> and subsequent dates, date of prior to and incl. <today>. This key is used combined with AE Title or Modality type.
>Scheduled Procedure Step Start Time	0040,0003	TM				X			Time input format: hhmmss.frac. The .frac part is removed from the returned value
>Scheduled Procedure Step End Date	0040,0004	DA							Not evaluated
>Scheduled Procedure Step End Time	0040,0005	TM							Not evaluated
>Scheduled Performing Physician's Name	0040,0006	PN							Evaluation requires optional GUI configuration
>Scheduled Procedure Step Description	0040,0007	LO				X			
>Scheduled Procedure Step ID	0040,0009	SH							
>Scheduled Station Name	0040,0010	SH							Evaluation requires optional GUI configuration
>Scheduled Procedure Step Location	0040,0011	SH							Evaluation requires optional GUI configuration
>Pre-Medication	0040,0012	LO							Evaluation requires optional GUI configuration
>Scheduled Procedure Step Status	0040,0020	CS							Evaluation requires optional GUI configuration
>Comments on the Scheduled Procedure Step	0040,0400	LT							Truncated to 256 char; \n and \r replaced by ' '; Lading & trailing white space ignored
>Scheduled Protocol Code Sequence	0040,0008	SQ							
>>Code Value	0008,0100	SH							
>>Coding Scheme Designator	0008,0102	SH							Not evaluated
>>Coding Scheme Version	0008,0103	SH							Not evaluated
>>Code Meaning	0008,0104	LO							Not evaluated
Requested Procedure Module									
Study Instance UID	0020,000D	UI							
Requested Procedure Description	0032,1060	LO				X			
Requested Procedure ID	0040,1001	SH			X	X		Single Value, Universal	Identified from admission form or bar code field Optional matching key for patient query
Requested Procedure Priority	0040,1003	SH							Evaluation requires

Attribute Name	Tag	VR	M	R	Q	D	IOD	Type of Matching	Comment
									optional GUI configuration
Patient Transport Arrangements	0040,1004	LO							Evaluation requires optional GUI configuration
Names of Intended Recipients of Results	0040,1010	PN							Not evaluated
Requested Procedure Comments	0040,1400	LT							Truncated to 256 char; \n and \r replaced by ' '; Lading & trailing white space ignored
Referenced Study Sequence	0008,1110	SQ							
>Referenced SOP Class UID	0008,1150	UI							
>Referenced SOP Instance UID	0008,1155	UI							
Requested Procedure Code Sequence	0032,1064	SQ							
>Code Value	0008,0100	SH							
>Coding Scheme Designator	0008,0102	SH							Not evaluated
>Coding Scheme Version	0008,0103	SH							Not evaluated
>Code Meaning	0008,0104	LO							Not evaluated
Imaging Service Request Module									
Accession Number	0008,0050	SH			X	X		Single, Universal	Identified from admission form or bar code field Optional matching key for patient query
Referring Physician's Name	0008,0090	PN				X			
Requesting Physician	0032,1032	PN							Evaluation requires optional GUI configuration
Requesting Service	0032,1033	LO							Evaluation requires optional GUI configuration
Imaging Service Request Comments	0040,2400	LT							Not evaluated

Table 41: C-FIND-RQ Status Response

Service Status	Code	Further Meaning	Description
Success	0000	Matching is complete	The matching information is shown on the GUI.
Failure	A700	Refused: Out of resources	The user is notified of the query failure (via pop-up). The reason is logged.
	A900	Failed: Identifier does not match SOP class	The user is notified of the query failure (via pop-up). The reason is logged.
	Cxxx	Failed: Unable to process	The user is notified of the query failure (via pop-up). The reason is logged.
Cancel	FE00	Matching terminated due to Cancel request	The matching information is shown on the GUI and the user is notified of the cancellation; log entry.
Pending	FF00	Matches are continuing, current match is supplied	Pending status and intermediate number of matches is indicated to the operator.
	FF01	Matches are continuing, warning that one or more optional keys were not supported	Pending status and intermediate number of matches is indicated to the operator.

4.2.1.4. Association Acceptance Policy

This describes the conditions under which the AE will initiate an association.

The behavior of the AE during association rejection is summarized in next table

Table 42: DICOM Association Rejection Handling

Result	Source	Reason/Diagnosis	Behavior
1 – rejected-permanent	1 – DICOM UL service-user	1 – no-reason-given	If applicable the command will be retried. Log entry. The user is notified via pop-up (in preview mode only).
		2 – application-context-name-not-supported	If applicable the command will be retried. Log entry. The user is notified via pop-up (in preview mode only).
		3 – calling-AE-title-not-recognized	If applicable the command will be retried. Log entry. The user is notified via pop-up (in preview mode only).
		7 – called-AE-title-not-recognized	If applicable the command will be retried. Log entry. The user is notified via pop-up (in preview mode only).
	2 – DICOM UL service-provider (ACSE related function)	1 – no-reason-given	If applicable the command will be retried. Log entry. The user is notified via pop-up (in preview mode only).
		2 – protocol-version-not-supported	If applicable the command will be retried. Log entry. The user is notified via pop-up (in preview mode only).
	3 – DICOM UL service-provider (presentation related function)	1 – temporary-congestion	If applicable the command will be retried. Log entry. The user is notified via pop-up (in preview mode only).
		2 – local-limit-exceeded	If applicable the command will be retried. Log entry. The user is notified via pop-up (in preview mode only).
	2 – rejected-transient	1 – DICOM UL service-user	1 – no-reason-given
2 – application-context-name-not-supported			If applicable the command will be retried. Log entry. The user is notified via pop-up (in preview mode only).
3 – calling-AE-title-not-recognized			If applicable the command will be retried. Log entry. The user is notified via pop-up (in preview mode only).
7 – called-AE-title-not-recognized			If applicable the command will be retried. Log entry. The user is notified via pop-up (in preview mode only).
2 – DICOM UL service-provider (ACSE related function)		1 – no-reason-given	If applicable the command will be retried. Log entry. The user is notified via pop-up (in preview mode only).
		2 – protocol-version-not-supported	If applicable the command will be retried. Log entry. The user is notified via pop-up (in preview mode only).
3 – DICOM UL service-provider (presentation related function)		1 – temporary-congestion	If applicable the command will be retried. Log entry. The user is notified via pop-up (in preview mode only).

Result	Source	Reason/Diagnosis	Behavior
		2 – local-limit-exceeded	If applicable the command will be retried. Log entry. The user is notified via pop-up (in preview mode only).

4.2.1.4.1. (Real-World) Activity – Verification as SCP

4.2.1.4.1.1. Description and Sequencing of Activities

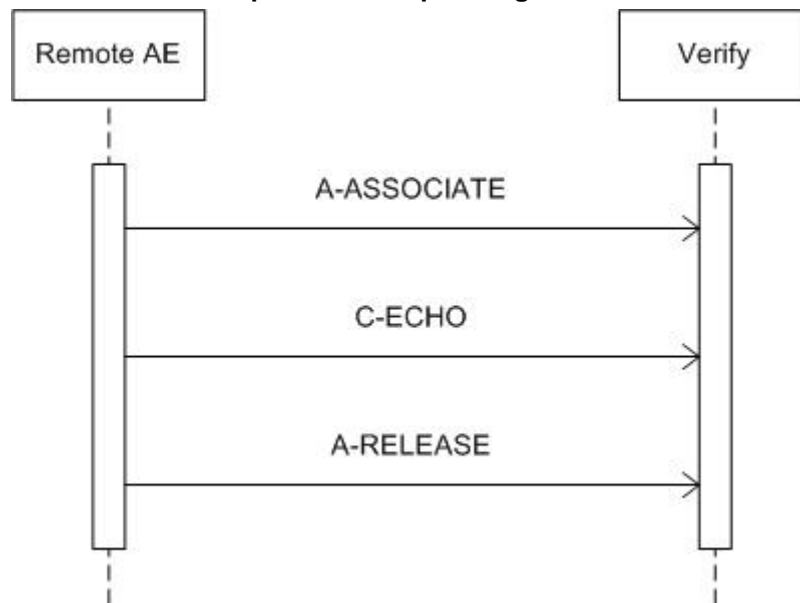

Figure 10: (Real World) Activity - Verification as SCP

The DigitalDiagnost AE accepts associations from systems that wish to verify application level communication using the C-ECHO command.

4.2.1.4.1.2. Accepted Presentation Contexts

Table 43: Acceptable Presentation Contexts for (Real-World) Activity – Verification as SCP

Presentation Context Table					
Abstract Syntax		Transfer Syntax		Role	Extended Negotiation
Name	UID	Name List	UID List		
Verification SOP Class	1.2.840.10008.1.1	Explicit VR Big Endian	1.2.840.10008.1.2.2	SCP	None
		Explicit VR Little Endian	1.2.840.10008.1.2.1		
		Implicit VR Little Endian	1.2.840.10008.1.2		

The DigitalDiagnost AE accepts all contexts in the intersection of the proposed and acceptable Presentation Contexts. This means that multiple Proposed Presentation Contexts with the same SOP Class but different Transfer Syntaxes are accepted. Nevertheless ELE is the preferred Transfer Syntax. There is no check for duplicate contexts, and these are therefore accepted.

4.2.1.4.1.3. SOP Specific Conformance for Verification SOP Class

This section includes the SOP specific behavior, i.e. error codes, error and exception handling, time-outs, etc.

4.2.1.4.1.3.1. Dataset Specific Conformance for Verification C-ECHO SCP

DigitalDiagnost provides standard conformance to the DICOM Verification Service Class.

Table 44: C-ECHO-RSP Status Response

Service Status	Code	Further Meaning	Description
Success	0000	Verification is complete	The DigitalDiagnost has successfully received the verification request.

4.2.1.4.2. (Real-World) Activity – Storage Commitment as SCU

4.2.1.4.2.1. Description and Sequencing of Activities

The DigitalDiagnost AE accepts (only from configured systems) associations that are to report asynchronous Storage Commitment events.

4.2.1.4.2.2. Accepted Presentation Contexts

Table 45: Acceptable Presentation Contexts for (Real-World) Activity – Storage Commitment SCP

Presentation Context Table					
Abstract Syntax		Transfer Syntax		Role	Extended Negotiation
Name	UID	Name List	UID List		
Storage Commitment Push Model	1.2.840.10008.1.20.1	Explicit VR Big Endian	1.2.840.10008.1.2.2	SCU	None
		Explicit VR Little Endian	1.2.840.10008.1.2.1		
		Implicit VR Little Endian	1.2.840.10008.1.2		

The DigitalDiagnost AE accepts all contexts in the intersection of the proposed and acceptable Presentation Contexts. This means that multiple Proposed Presentation Contexts with the same SOP Class but different Transfer Syntaxes are accepted. Nevertheless ELE is the preferred Transfer Syntax. There is no check for duplicate contexts, and these are therefore accepted.

4.2.1.4.2.3. SOP Specific Conformance for Storage Commitment Push Model SOP Class

This section includes the SOP specific behavior, i.e. error codes, error and exception handling, time-outs, etc.

4.2.1.4.2.3.1. Dataset Specific Conformance for Storage Commitment N-EVENT-REPORT as SCU

The DigitalDiagnost AE provides standard conformance to the DICOM Storage Commitment Push Model Class.

On receiving a storage commitment result with Event Type ID 1 (Storage Commitment Request Successful) the DigitalDiagnost patient list shall be updated by incrementing the number of committed images and by marking the icon of the related image committed in the Viewing Tool browser.

On receiving a storage commitment result with Event Type ID 2 (Storage Commitment Request Complete – Failures Exist) the DigitalDiagnost AE shall behave as summarized in next table.

The storage commitment result is entered in the log

Table 46: Storage Commitment N-EVENT-REPORT Failure Handling Behavior

Service Status	Code	Further Meaning	Description
Failure	0110	Processing failure	The user is notified via pop-up. Retry storage commitment request. Log entry.
	0112	No such object instance	The user is notified via pop-up. Retry store and storage commitment request. Log entry.
	0119	Class / Instance conflict	The user is notified via pop-up. No retry. Log entry.
	0122	Referenced SOP class not supported	The user is notified via pop-up. No retry. Log entry.
	0131	Duplicate transaction UID	The user is notified via pop-up. No retry. Log entry.
	0213	Resource limitation	The user is notified via pop-up. Retry storage commitment request. Log entry.

Table 47: N-EVENT-REPORT-RSP Status Response

Service Status	Code	Further Meaning	Description
Success	0000	Verification is complete	The DigitalDiagnost has successfully received the verification request.

4.3. Network Interfaces

4.3.1. Physical Network Interfaces

The DigitalDiagnost provides DICOM 3.0 TCP/IP Network Communication Support as defined in Part 8 of the DICOM 3.0 Standard.

The DigitalDiagnost system supports ISO 8802-3 10BASE-T and 100Base-TX Ethernet.

4.3.2. Additional Protocols

NTP

As a configurable option, DigitalDiagnost maintains the correct time by synchronizing the time with an NTP Time Server.

4.4. Configuration

Any implementation's DICOM conformance may be dependent upon configuration, which takes place at the time of installation. Issues concerning configuration is addressed in this section.

4.4.1. AE Title/Presentation Address Mapping

An important installation issue is the translation from AE title to presentation address. How this is to be performed shall be described in this section

4.4.1.1. Local AE Titles

The local AE title mapping and configuration are specified.

Table 48: AE Title Configuration Table

Application Entity	Default AE Title	Default TCP/IP Port
DigitalDiagnost AE	digitalDIAGNOST	3000

4.4.1.2. Remote AE Title/Presentation Address Mapping

All remote applications to be selected as destination (SCP) are configurable for the following items:

- The Application Entity Title of the remote application.
- The Presentation Address of where the remote application should accept association requests.
- A user readable ('logical') name for any single configured AET to facilitate user selection.

4.4.2. Parameters

The specification of important operational parameters, their default value and range (if configurable) is specified here.

Table 49: Configuration Parameters table

Parameter	Configurable	Default Value
General Parameters		
Time-out waiting for acceptance or rejection Response to an Association Open Request. (Application Level timeout)	Yes	20 [s]

Parameter	Configurable	Default Value
General DIMSE level time-out values (Verification, Storage, Storage Commitment)	Yes	15 [s]
Time-out waiting for response to TCP/IP connect request. (Low-level timeout)	Yes	20 [s]
Time-out waiting for acceptance of a TCP/IP message over the network. (Low-level timeout)	Yes	20 [s]
Time-out for waiting for data between TCP/IP packets. (Low-level timeout)	Yes	20 [s]
Any changes to default TCP/IP settings, such as configurable stack parameters.	No	-
AE Specific Parameters		
Size constraint in maximum object size	No	-
Maximum PDU size the AE can receive	Yes	28k
Maximum PDU size the AE can send	No	16k for BWLM and MPPS 28k for Verification, Storage and Storage Commitment 64k for Print
AE specific DIMSE level time-out values	No	-
Number of simultaneous Associations by Service and/or SOP Class	No	1
GUI user readable string for remote AE titles	Yes	-
Storage Specific Parameters		
Automatic Transfer (On, Off)	Yes	On
Export Filter ¹	Yes	"none"
Bits Stored attribute value (implies Bits Allocated and High Bit) (8, 10, 12, 15)	Yes	15
Photometric Interpretation attribute value (MONOCHROME1, MONOCHROME2)	Yes	MONOCHROME1
Mode ² (Full Range, Film-like, Grayscale Display Function Standard, Measured)	Yes	Grayscale Display Function Standard
Content of study description attribute (The DigitalDiagnost internal examination name, value of scheduled procedure step description)	Yes	-
IODType (CR, DX) ³	Yes	DX
Confidentiality	Yes	no
Export private Attributes	Yes	Yes
Storage Commitment Specific Parameters		
StCommitNEventTimeout ⁴	Yes	0 [s]
StCommitRetryCount ⁵	Yes	-1 (unlimited)
StCommitNActionDelay ⁶	Yes	0 [s]
StCommitRetryTimeout ⁷	Yes	30 [s]
Basic Worklist Management Specific Parameters		
BackgroundQuery	Yes	No
BackgrdQueryTimeInterval	Yes	60 [s]
BroadQueryMaxItems (Limit before Cancellation, range 1..1200)	Yes	1000
BroadQueryWithDate (as matching key)	Yes	No
DateRange (Today, Today or earlier, Today or later)	Yes	Today
BroadQueryWithAET (as matching key)	Yes	Yes
AETWildcard ⁸	Yes	No
AETWildcardExpr (wildcard value using '*' and/or '?')	Yes	-
QueryModalityType (CR, or DX, or CR+DX) The combination of CR and DX may result in 2 C-FIND Requests on 1 association.	Yes	CR

Parameter	Configurable	Default Value
BroadQueryWithModality (as matching key)	Yes	No
PatientQueryMaxItems (Limit before Cancellation, range 1..1200)	Yes	100
PatientQueryWithDate (as matching key)	Yes	No
PatientQueryWithAET (as matching key)	Yes	Yes
PatientQueryWithModality (as matching key)	Yes	No
PatientQueryWithAccessionNo (optional matching key value)	Yes	Yes
PatientQueryWithName (optional matching key value)	Yes	Yes
PatientNameWithWildcard (optional wildcard value using '*' and/or '?')	Yes	No
PatientQueryWithID (optional matching key value)	Yes	Yes
PatientQueryWithReqProclD (optional matching key value)	Yes	Yes
Print Management Specific Parameters		
Retries ⁹	Yes	2
Delay between retries	Yes	60 [s]
Use Presentation LUT (per individual Printer)	Yes	Yes

Note 1: The DigitalDiagnost system stores images internally with 15-bit depth, MONOCHROME1 format. The pixel values are 10000 times that of the optical density, which these pixels should have on film. The Export Filter converts the DigitalDiagnost pixel data into data fitting the requirements of the receiving station. To meet the different requirements of different receiving stations, it is possible to create one Configuration for every SCP.

Note 2: Full Range - The source data range is mapped to the full destination range.

Advantage: Uses the maximum precision of the output range.

Disadvantage: There is the possibility that consecutive images are harder to compare.

It is possible to apply an additional non-linear pixel transformation.

Film-like - The number of bits is reduced by the division through a constant factor.

Advantage: Consecutive images are easier to compare.

Disadvantage: Reduced precision, compared to that of full range mode.

It is possible to apply an additional non-linear pixel transformation.

Grayscale Display Function Standard (p-Values) - The DigitalDiagnost image pixel values represent optical densities on a film according to DICOM PS 3.14. An image is a kind of virtual film, which can be put in front of a virtual light box. The result is a range of luminescence values. These values are transformed into perceptual linear values using the whole output range which is defined by the "Bits stored" parameter. These values are exported. The viewing station should be able to display these values in a perceptual linear manner. This means in most cases a non-linear mapping between the input pixel and the data sent to the graphic card.

Advantage: Very good quality, if the viewing station supports the Grayscale Standard Display Function.

Disadvantage: There are viewing stations not supporting the Grayscale Standard Display Function.

Measured - In addition to the processing described before, a second pixel transformation is calculated by using measured luminescence values of the viewing device. This results in a perceptual linear behavior of the viewing device.

Advantage: It is possible to achieve results similar to the results of a viewing Station supporting the Grayscale Display Function Standard (p-values).

Disadvantage: Changing brightness and contrast at the viewing station, the calibration has to be redone and the Export Filter settings must be adapted. Changing window center/window width at the viewing station can produce results below optimum.

- Note 3: *The IOD type (CR, DX) is configurable per single C-Store SCP. PCR images are always exported as CR. The export to an interoperating EasyVision is always done as CR. - The export of SC images is not affected by this parameter.*
- Note 4: *Enable and set (in seconds) or disable the possibility to accept N-EVENT Reports in the same association the N-ACTION request is sent. Equal to "0": don't accept in the same association Equal to ">0": accept for given seconds (Note: This is an important parameter at installation time that has to be carefully committed with the hospital DICOM-Officer).*
- Note 5: *Set the number of retries if a Storage Commitment request failed. Equal to "-1": retry forever (Note: If the value is set to ">0" the related SOP Instances may get deleted after retry count has expired).*
- Note 6: *Number of seconds to delay a Storage Commitment request. (Note: Use this parameter if the Image Manager is not able to serve a Storage Commitment request immediately after a C-Store.)*
- Note 7: *Set the time (in seconds) between retries of a Storage Commitment request.*
- Note 8: *AET wildcard matching is performed locally, not with DICOM means. In the query C-FIND request the scheduled station AE title is left empty (universal matching).*
- Note 9: *Retries per job. If the configured number of retries per job is exhausted, the job is re-entered at the end of the job list.*

5. MEDIA INTERCHANGE

5.1. Implementation Model

The implementation model shall identify the DICOM Application Entities in a specific implementation and relate the Application Entities to Real-World Activities.

5.1.1. Application Data Flow Diagram

The DigitalDiagnost system consists of one single application entity only: the DigitalDiagnost Application Entity (DigitalDiagnost AE).

DigitalDiagnost AE shows the Media Interchange application data flow as a functional overview of the DigitalDiagnost AE.

The DigitalDiagnost AE will act as a FSR when reading the directory of the medium. The DigitalDiagnost AE will act as a FSC/FSU when writing the selected images in a patient folder onto the CD-R medium.

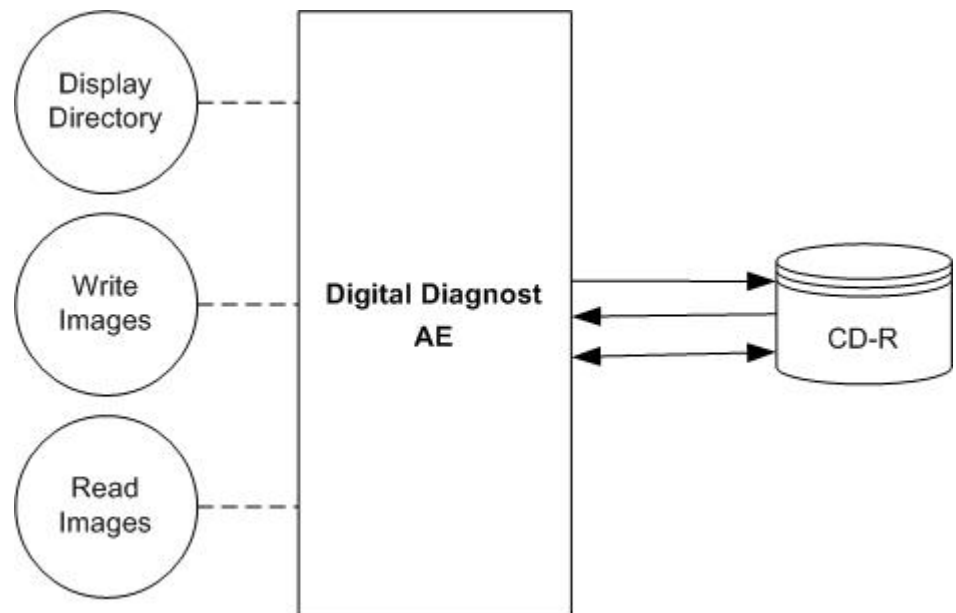

Figure 11: Media Interchange Application Data Flow Diagram

5.1.2. Functional Definitions of AE's

This section shall describe in general terms the functions to be performed by the AE, and the DICOM services used to accomplish these functions.

The DigitalDiagnost AE is the one and only application class within the DigitalDiagnost. It includes the following service class.

Media Storage Service Class

The DigitalDiagnost AE can perform the Media Storage service as SCU, with capabilities for RWA Display Directory (as FSR), RWA Write Images (as FSC/FSU), and RWA Read Images (as FSR).

5.1.3. Sequencing of Real World Activities

The following sequence of Real-World activities is supported by the system.

DICOM Media Usage

Whenever a CD-R has to be written the DigitalDiagnost AE first tries to read the DICOMDIR. The DigitalDiagnost AE will compile the updated DICOMDIR and any required DICOM images into a CD session image; this CD session image will be written to CD-R.

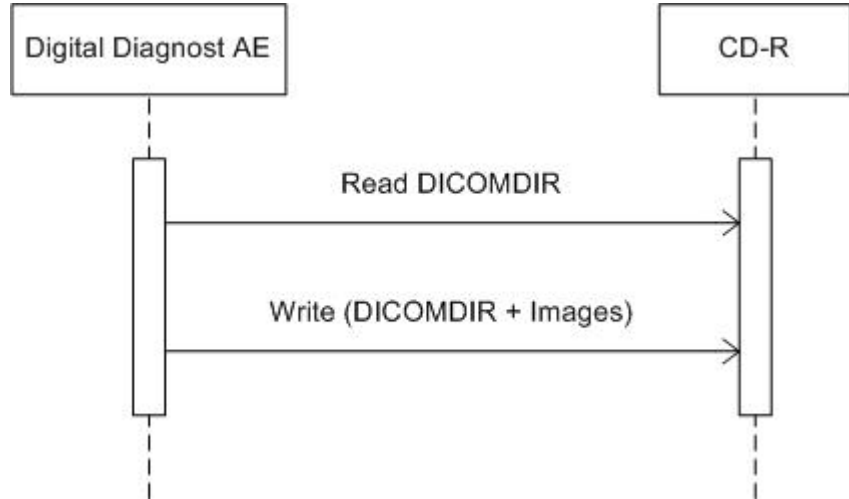

Figure 12: Sequencing of RWA Write Image

The user may optionally store Post, Pre and Stamp images onto CD-R's. This can either be done during the Image Verification (Examination GUI), or in the Viewer GUI.

An overview of patients and images on a CD-R generated by DigitalDiagnost can be displayed in the Patient List GUI, and Post, Pre and Stamp images can be retrieved from CD-R in the Viewer GUI.

For viewing the images on Windows systems a copy of the MxLiteView DICOM Viewer is stored on any single CD.

5.1.4. File Meta Information for Implementation Class and Version

This section shall list the values assigned to the File Meta Information attributes (ref. [DICOM] PS 3.10) that pertain to the Implementation Class and Version.

The Implementation Class UID and the Implementation Version Name in the File Meta Header are as specified for Networking.

Table 50: AE Related Application Profiles, Real-World Activities, and Roles

File Meta Information attributes	Value
File Meta Information Version	00, 01
Implementation Class UID	1.3.46.670589.26.1.5.3
Implementation Version Name	DigiDiagnost1.53

5.2. AE Specifications

The next section contains the specification of the one and only DigitalDiagnost Application Entity: DigitalDiagnost AE.

5.2.1. DigitalDiagnost AE - Specification

The DigitalDiagnost AE provides Standard Conformance to the DICOM Media Storage Service and File Format ([DICOM] PS 3.10) and the Media Storage Application Profiles STD-GEN-CD ([DICOM] PS 3.11) for reading and writing.

DigitalDiagnost supports multi-patient and multi-session CD-R disks, both for reading and writing.

The supported Application Profiles, their Roles and the Service Class (SC) options, all defined in DICOM terminology, are listed in next table.

Only adding on of instances is supported for the FSU, deleting is not supported.

Table 51: AE Related Application Profiles, Real-World Activities, and Roles

Supported Application Profile	Real-World Activity	Roles	SC Option
STD-GEN-CD	Display Directory	FSR	Interchange
	Write Images	FSC, FSU	Interchange
	Read Images	FSR	Interchange

5.2.1.1. File Meta Information for the DigitalDiagnost AE

In the file Meta information that pertains to the Application Entity the Source Application Entity Title is set to "DigitalDiagnost".

5.2.1.2. Real-World Activities

This section describes the real-world activities for the roles and Media Storage Service Class options supported by the DigitalDiagnost AE as listed in above table.

5.2.1.2.1. Display Directory

The AE specification shall contain a description of the Real-World Activities that invoke the particular AE. There will be one section (5.2.x.2.i where i increments for each RWA) per Real-World Activity.

5.2.1.2.1.1. Media Storage Application Profile

The DigitalDiagnost AE supports the RWA Display Directory for the STD-GEN-CD Application Profile.

5.2.1.2.1.1.1. Options

The mandatory DICOMDIR keys are required for the correct display of directory information. The display is structured according the DICOM Composite Information Model: Patient, Study, Series, and Image.

5.2.1.2.2. Write Images

When an image transfer to CD-R is initiated then the DigitalDiagnost AE acts as an FSC or FSU using the interchange option to export SOP Instances from the local database to a CD-R medium.

5.2.1.2.2.1. Media Storage Application Profile

The DigitalDiagnost AE supports the RWA Write Images for the STD-GEN-CD Application Profile.

5.2.1.2.2.1.1. Options

The DICOMDIR file will be extended when new images are written. In case some attributes are not present in an image but are specified as mandatory in the DICOMDIR definition in DICOM Media, a generated value will be filled in.

Implementation remarks and restrictions

When writing the DICOMDIR records, key values are generated when no value of the corresponding attribute is supplied, according to the following table.

Table 52: Generated Keys

Key	Tag	Generated Value
Patient Keys		
Patient ID	(0010,0020)	At import the DigitalDiagnost each time creates a new value based on the Study Instance UID for each new study written to the CD-R (even if this study belongs to a patient recorded earlier). Otherwise the default-generated value shall be a succession of "UNKNOWN", the Patient's Name, the Patient's Birth Date, and the Patient's Sex, concatenated by using underscore characters. If no Patient ID is present in the image, the mandatory patient number of the internal database is used as Patient ID.

The DigitalDiagnost can write created image to media of the following listed SOP Classes.

Table 53: AE related storage SOP Classes for Media

SOP Class Name	SOP Class UID
Computed Radiography Image Storage SOP Class	1.2.840.10008.5.1.4.1.1.1
Digital X-Ray Image Storage - Presentation. SOP Class	1.2.840.10008.5.1.4.1.1.1.1
Digital X-Ray Image Storage – Processing SOP Class	1.2.840.10008.5.1.4.1.1.1.1.1
Secondary Capture Image Storage SOP Class	1.2.840.10008.5.1.4.1.1.7

5.2.1.2.3. Read Images

When an image transfer from CD-R is initiated then the DigitalDiagnost AE acts as an FSR using the interchange option to import SOP Instances from the CD-R medium.

5.2.1.2.3.1. Media Storage Application Profile

The DigitalDiagnost AE supports the RWA Read Images for the STD-GEN-CD Application Profile.

5.2.1.2.3.1.1. Options

The DigitalDiagnost only reads CD-R's written by a DigitalDiagnost system.

5.3. Augmented and Private Application Profiles

This section shall be used for the description of augmented and private Application Profiles.

5.3.1. Augmented Application Profiles

None

5.3.2. Private Application Profiles

None

5.4. Media Configuration

This section specifies important operational parameters and, if configurable, their default value and range.

Table 54: Configuration Parameters

Parameter	Configurable	Default Value
General Parameters		
Source AE Title	No	DigitalDiagnost
Customization Parameters		
Institution Name	Yes	-
Institutional Department Name	Yes	-
IOD type (CR, DX) ¹	Yes	DX

Note 1: The Media storage of SC images is not affected by this parameter.

6. SUPPORT OF CHARACTER SETS

Any support for character sets beyond the default character repertoire in Network and Media services is described here.

Table 55: Supported DICOM Character Sets of DigitalDiagnost

Character Set Description	Defined Term	ESC Sequence	ISO Registration Number	Code Element	Character Set
Latin alphabet No. 1	ISO_IR 100	-	ISO-IR 6	G0	ISO 646
		-	ISO-IR 100	G1	Supplementary set of ISO 8859

The DigitalDiagnost supports the supplementary character set ISO-IR 100. There are no limitations within the ISO-IR 100 domain.

ISO-IR 100 characters are passed between DICOM services without conversion. In internal log files, characters beyond the 7-bit ASCII set may be displayed using the escape character '\', or in Hex representation.

The use of ISO-IR 100 characters in matching key values is fully supported.

There is no support for character sets beyond the default character repertoire in Network and Media services. Characters of unsupported character sets will be displayed as question marks "?".

7. SECURITY

7.1. Security Profiles

Not applicable.

7.2. Association Level Security

Not applicable.

7.3. Application Level Security

Not applicable.

8. ANNEXES OF APPLICATION "DIGITALDIAGNOST"

8.1. IOD Contents

8.1.1. Created SOP Instance

This section specifies each IOD created (including private IOD's). It should specify the attribute name, tag, VR, and value. The value should specify the range and source (e.g. user input, Modality Worklist, automatically generated, etc.). For content items in templates, the range and source of the concept name and concept values should be specified. Whether the value is always present or not shall be specified.

Abbreviations used in the IOD tables for the column "Presence of Module" are:

ALWAYS The module is always present
 CONDITIONAL The module is used under specified condition

Abbreviations used in the Module table for the column "Presence of Value" are:

ALWAYS The attribute is always present with a value
 EMPTY The attribute is always present without any value (attribute sent zero length)
 VNAP The attribute is always present and its Value is Not Always Present (attribute sent zero length if no value is present)
 ANAP The attribute is present under specified condition – if present then it will always have a value
 ANAPCV The attribute is present under specified condition – if present then its Value is Not Always Present (attribute sent zero length if condition applies and no value is present)
 ANAPEV The attribute is present under specified condition – if present then it will not have any value

The abbreviations used in the Module table for the column "Source" are:

AUTO The attribute value is generated automatically
 CONFIG The attribute value source is a configurable parameter
 COPY The attribute value source is another SOP instance
 FIXED The attribute value is hard-coded in the application
 IMPLICIT The attribute value source is a user-implicit setting
 MPPS The attribute value is the same as that use for Modality Performed Procedure Step
 MWL The attribute value source is a Modality Worklist
 USER The attribute value source is explicit user input

8.1.1.1. List of created SOP Classes

Table 56: List of created SOP Classes

SOP Class Name	SOP Class UID
Computed Radiography Image Storage SOP Class	1.2.840.10008.5.1.4.1.1.1
Digital X-Ray Image Storage - For Pres. SOP	1.2.840.10008.5.1.4.1.1.1.1
Digital X-Ray Image Storage - For Proc. SOP ¹	1.2.840.10008.5.1.4.1.1.1.1.1
Secondary Capture Image Storage SOP Class	1.2.840.10008.5.1.4.1.1.7

¹ On DICOM Media only

8.1.1.2. Computed Radiography Image Storage SOP Class

Table 57: IOD of Created Computed Radiography Image Storage SOP Class Instances

Information Entity	Module	Presence Of Module
Patient	Patient Module	ALWAYS
Study	Patient Study Module	CONDITIONAL
Study	General Study Module	ALWAYS
Series	General Series Module	ALWAYS
Series	CR Series Module	ALWAYS
Equipment	General Equipment Module	ALWAYS
Image	General Image Module	ALWAYS
Image	CR Image Module	ALWAYS
Image	Image Pixel Module	ALWAYS
Image	SOP Common Module	ALWAYS
Image	VOI LUT Module	ALWAYS
	Additional Module	CONDITIONAL

Table 58: Patient Module (CR)

Attribute Name	Tag	VR	Value	Presence of Value	Source	Comment
Patient's Name	0010,0010	PN		VNAP	MWL/ USER	Value present if received from RIS or entered by user
Patient ID	0010,0020	LO		VNAP	MWL/ USER	Primary hospital identification number or code for the patient. Value present if received from RIS or entered by user
Patient's Birth Date	0010,0030	DA		VNAP	MWL/ USER	Value present if received from RIS or entered by user
Patient's Sex	0010,0040	CS	F, M, O	VNAP	MWL/ USER	Value present if received from RIS or entered by user
Issuer of Patient ID	0010,0021	LO		ANAP	MWL	Name of authority that issued the Patient ID. Attribute present if value received from RIS
Other Patient Ids	0010,1000	LO		ANAP	MWL	Attribute present if value received from RIS
Ethnic Group	0010,2160	SH		ANAP	MWL	Attribute present if value received from RIS
Patient Comments	0010,4000	LT		ANAP	MWL	Attribute present if value received from RIS

Table 59: Patient Study Module (CR)

Attribute Name	Tag	VR	Value	Presence of Value	Source	Comment
Patient's Size	0010,1020	DS		ANAP	MWL	Attribute present if value received from RIS
Patient's Weight	0010,1030	DS		ANAP	MWL	Attribute present if value received from RIS

Table 60: General Study Module (CR)

Attribute Name	Tag	VR	Value	Presence of Value	Source	Comment
Study Instance UID	0020,000D	UI		ALWAYS	MWL/AUTO	Unique identifier for the Study. Value received from RIS or auto-generated if not received from RIS
Study Date	0008,0020	DA		ALWAYS	AUTO	
Study Time	0008,0030	TM		ALWAYS	AUTO	
Accession Number	0008,0050	SH		VNAP	MWL/USER	Value present if received from RIS or entered by user
Referring Physician's Name	0008,0090	PN		VNAP	MWL/USER	Value present if received from RIS or entered by user
Study ID	0020,0010	SH		VNAP	MPPS/AUTO	User or equipment generated Study identifier. Value received from RIS or auto-generated if not received from RIS
Study Description	0008,1030	LO		ANAP	MWL/AUTO	Configurable to either empty, Examination Name, or Scheduled Procedure Step Description. Attribute present if export via network and value not empty
Physician(s) of Record	0008,1048	PN		ANAP	MWL	Attribute present if value received from RIS
Referenced Study Sequence	0008,1110	SQ		ANAP	MWL	A sequence providing reference to a study SOP Class/Instance pair. Attribute present if value received from RIS (1 item).
>Referenced SOP Class UID	0008,1150	UI	1.2.840.10008.3.1.2.3.1	ALWAYS	FIXED	
>Referenced SOP Instance UID	0008,1155	UI		ALWAYS	MWL	Uniquely identifies the referenced SOP Instance
Procedure Code Sequence	0008,1032	SQ		VNAP	MWL	A sequence that conveys the (single) type of procedure performed. Only a single item shall be permitted in this sequence. Value present for scheduled procedures
>Code Value	0008,0100	SH		ALWAYS	MWL	
>Coding Scheme Designator	0008,0102	SH		ALWAYS	MWL	
>Code Meaning	0008,0104	LO		ALWAYS	MWL	
>Coding Scheme Version	0008,0103	SH		ANAP	MWL	Attribute present if the value of the Coding Scheme Designator is not sufficient to identify the code Value unambiguously

Table 61: General Series Module (CR)

Attribute Name	Tag	VR	Value	Presence of Value	Source	Comment
Modality	0008,0060	CS	CR	ALWAYS	FIXED	
Series Instance UID	0020,000E	UI		ALWAYS	MPPS/AUTO	Unique identifier of the series
Series Number	0020,0011	IS		ALWAYS	AUTO	
Laterality	0020,0060	CS	L, R	VNAP	AUTO	Value present if value configured for acquisition

Series Date	0008,0021	DA		ALWAYS	AUTO	
Series Time	0008,0031	TM		ALWAYS	AUTO	
Series Description	0008,103E	LO		ALWAYS	AUTO	User provided description of the series
Operators' Name	0008,1070	PN		ANAP	MPPS/ USER	The technologist(s) supporting the series. Attribute present if entered by user
Protocol Name	0018,1030	LO		ANAP	MPPS/ AUTO	Name of the examination item that maps the Performed Protocol Code Value
Performed Procedure Step Start Date	0040,0244	DA		ALWAYS	MPPS	
Performed Procedure Step Start Time	0040,0245	TM		ALWAYS	MPPS	
Performed Procedure Step ID	0040,0253	SH		ANAP	MPPS	Attribute present if MPPS option is active.
Performed Procedure Step Description	0040,0254	LO		ANAPCV	MWL	Attribute present if MPPS option is active and value is present if received from RIS.
Referenced Performed Procedure Step Sequence	0008,1111	SQ		ANAP	AUTO	Uniquely identifies the Modality Performed Procedure Step SOP Instance to which the series is related. Present if MPPS option is active
>Referenced SOP Class UID	0008,1150	UI	1.2.840.10008.3.1.2.3.3	ALWAYS	FIXED	
>Referenced SOP Instance UID	0008,1155	UI		ALWAYS	AUTO	Uniquely identifies the referenced SOP Instance
Performed Protocol Code Sequence	0040,0260	SQ		VNAP	MWL	Value(s) present if MPPS option active.
>Code Value	0008,0100	SH		ALWAYS	MWL	
>Coding Scheme Designator	0008,0102	SH		ALWAYS	MWL	
>Code Meaning	0008,0104	LO		ALWAYS	MWL	
>Coding Scheme Version	0008,0103	SH		ANAP	MWL	Attribute present if the value of the Coding Scheme Designator is not sufficient to identify the code Value unambiguously
Request Attributes Sequence	0040,0275	SQ		VNAP	MWL	Value(s) present if MPPS option active.
>Scheduled Procedure Step ID	0040,0009	SH		ALWAYS	MWL	
>Requested Procedure ID	0040,1001	SH		ALWAYS	MWL	
>Scheduled Procedure Step Description	0040,0007	LO		ALWAYS	MWL	
>Scheduled Protocol Code Sequence	0040,0008	SQ		VNAP	MWL	If a Procedure Step has not been scheduled by the RIS but entered locally (e.g. as Emergency Case) then this sequence contains an empty item.
>>Code Value	0008,0100	SH		ALWAYS	MWL	
>>Coding Scheme Designator	0008,0102	SH		ALWAYS	MWL	
>>Code Meaning	0008,0104	LO		ALWAYS	MWL	
>>Coding Scheme Version	0008,0103	SH		ANAP	MWL	Attribute present if the value of the Coding Scheme Designator is not sufficient to identify the code Value unambiguously

Table 62: CR Series Module

Attribute Name	Tag	VR	Value	Presence of Value	Source	Comment
Body Part Examined	0018,0015	CS	ABDOMEN, ANKLE, ARM, BREAST, CHEST, CLAVICLE, COCCYX, CSPINE, ELBOW, EXTREMITY, FOOT, HAND, HEAD, HEART, HIP, JAW, KNEE, LEG, LSPINE, NECK, PELVIS, SHOULDER, SKULL, SSPINE, TSPINE	ALWAYS	AUTO	
View Position	0018,5101	CS	AP, LL, LLD, LLO, PA, RL, RLD, RLO	ALWAYS	AUTO	Radiographic view
Filter Type	0018,1160	SH	0.1Cu, 1AL, 0.2Cu, 1AL, 0mmAL, 2mmAL, unknown	ALWAYS	AUTO	
Collimator/Grid Name	0018,1180	SH		ALWAYS	AUTO	
Focal Spot(s)	0018,1190	DS		ALWAYS	AUTO	
Plate Type	0018,1260	SH		ALWAYS	AUTO	

Table 63: General Equipment Module (CR)

Attribute Name	Tag	VR	Value	Presence of Value	Source	Comment
Manufacturer	0008,0070	LO	Philips Medical Systems	ALWAYS	FIXED	
Institution Name	0008,0080	LO		VNAP	CONFIG	Value present if configured
Station Name	0008,1010	SH		VNAP	CONFIG	Value present if configured
Institutional Department Name	0008,1040	LO		VNAP	CONFIG	Value present if configured
Manufacturer's Model Name	0008,1090	LO	digital DIAGNOST	ALWAYS	FIXED	
Device Serial Number	0018,1000	LO		ALWAYS	AUTO	
Software Version(s)	0018,1020	LO	Version 1.5.3	ALWAYS	FIXED	
Date of Last Calibration	0018,1200	DA		ALWAYS	AUTO	
Time of Last Calibration	0018,1201	TM		ALWAYS	AUTO	

Table 64: General Image Module (CR)

Attribute Name	Tag	VR	Value	Presence of Value	Source	Comment
Instance Number	0020,0013	IS		ALWAYS	AUTO	= 0 for unprocessed images, > 0 for processed images
Content Date	0008,0023	DA		ALWAYS	AUTO	
Content Time	0008,0033	TM		ALWAYS	AUTO	
Patient Orientation	0020,0020	CS	A, P, R, L, H, F	ALWAYS	AUTO	
Image Type	0008,0008	CS	DERIVED, ORIGINAL, PRIMARY	ALWAYS	AUTO	'ORIGINAL\PRIMARY' for unprocessed images, 'DERIVED\PRIMARY' for processed images
Acquisition Number	0020,0012	IS		VNAP	MWL/ USER	
Image Comments	0020,4000	LT		ALWAYS	AUTO	

Table 65: CR Image Module

Attribute Name	Tag	VR	Value	Presence of Value	Source	Comment
KVP	0018,0060	DS		ALWAYS	MPPS/ AUTO	
Distance Source to Detector	0018,1110	DS		ALWAYS	AUTO	

Exposure Time	0018,1150	IS		ALWAYS	MPPS/ AUTO	
Exposure	0018,1152	IS		ALWAYS	AUTO	
Imager Pixel Spacing	0018,1164	DS		ALWAYS	AUTO	
Generator Power	0018,1170	IS		ALWAYS	AUTO	
Acquisition Device Processing Description	0018,1400	LO		ANAP	AUTO	Describes device specific processing associated with the image. Attribute present in processed images.
Sensitivity	0018,6000	DS		ANAP	AUTO	Read out sensitivity. Attribute present in processed images.

Table 66: Image Pixel Module

Attribute Name	Tag	VR	Value	Presence of Value	Source	Comment
Samples per Pixel	0028,0002	US	1	ALWAYS	AUTO	
Photometric Interpretation	0028,0004	CS	MONOCHROME1, MONOCHROME2	ALWAYS	AUTO	For media storage: only 'MONOCHROME1'
Rows	0028,0010	US		ALWAYS	AUTO	
Columns	0028,0011	US		ALWAYS	AUTO	
Bits Allocated	0028,0100	US	8, 16	ALWAYS	AUTO	For media storage: only 16
Bits Stored	0028,0101	US	8, 10, 12, 15	ALWAYS	AUTO	For media storage: only 15
High Bit	0028,0102	US	7, 9, 11, 14	ALWAYS	AUTO	For media storage: only 14
Pixel Representation	0028,0103	US	0	ALWAYS	AUTO	
Pixel Data	7FE0,0010	O W/ OB		ALWAYS	AUTO	

Table 67: SOP Common Module

Attribute Name	Tag	VR	Value	Presence of Value	Source	Comment
Specific Character Set	0008,0005	CS	ISO_IR 100	ALWAYS	FIXED	
SOP Class UID	0008,0016	UI	1.2.840.10008.5.1.4.1.1.1	ALWAYS	FIXED	
SOP Instance UID	0008,0018	UI		ALWAYS	MPPS/ AUTO	

Table 68: VOI LUT Module

Attribute Name	Tag	VR	Value	Presence of Value	Source	Comment
Window Center	0028,1050	DS		ALWAYS	AUTO	
Window Width	0028,1051	DS		ALWAYS	AUTO	

Table 69: Additional Module

Attribute Name	Tag	VR	Value	Presence of Value	Source	Comment
Medical Alerts	0010,2000	LO		VNAP	MWL	Conditions to which medical staff should be alerted (e.g. contagious condition, drug allergies, etc). Value present if received from RIS
Contrast Allergies	0010,2110	LO		VNAP	MWL	Value present if received from RIS
Additional Patient History	0010,21B0	LT		ANAP	MWL	Attribute present if value received from RIS

Pregnancy Status	0010,21C0	US	0001, 0002, 0003, 0004	ANAP	MWL	Applied Values: 0001 = not pregnant 0002 = possible pregnant 0003 = definitely pregnant 0004 = unknown. Value present if received from RIS
Image and Fluoroscopy Area Dose Product	0018,115E	DS		ALWAYS	MPPS/AUTO	
Grid	0018,1166	CS	IN, NONE	ALWAYS	AUTO	Applied values: IN = A Grid is positioned NONE = No Grid is used
Processing Function	0018,5020	LO		ALWAYS	AUTO	This attribute has been added for Thoravision (declared as "extend CR-Image attribute") and has been used since
Postprocessing Function	0018,5021	LO		ALWAYS	AUTO	This attribute has been added for Thoravision (declared as "extend CR-Image attribute") and has been used since
Pixel Spacing	0028,0030	DS		VNAP	AUTO	
Requesting Service	0032,1033	LO		ANAP	MWL	Attribute present if value received from RIS
Requested Procedure Description	0032,1060	LO		ANAP	MWL	Attribute present if media storage and value received from RIS.
Special Needs	0038,0050	LO		ANAP	MWL	Medical and social needs (e.g. wheelchair, oxygen, non-English-speaking etc.) Attribute present if value received from RIS
Patient State	0038,0500	LO		ANAP	MWL	Description of patient state (comatose, disoriented, vision impaired etc.) Attribute present if value received from RIS
Scan Options	0018,0022	CS	TOMO	ANAP	AUTO	Only for tomo acquisitions
Tomo Layer Height	0018,1460	DS		ANAP	AUTO	Only for tomo acquisitions
Tomo Angle	0018,1470	DS		ANAP	AUTO	Only for tomo acquisitions
Tomo Time	0018,1480	DS		ANAP	AUTO	Only for tomo acquisitions
Private Creator Group 0019 Block 12	0019,0012	LO	SPI-P-Private-DiDi Release 1	ANAP	FIXED	Attribute present if media storage.
Private Creator Group 0019 Block 19	0019,0019	LO	DIDI TO PCR 1.1	ALWAYS	FIXED	
Post Mode String	0019,1200	LT		ANAP	AUTO	Attribute present if media storage and postprocessed image.
Post Data	0019,1201	LT		ANAP	AUTO	Attribute present if media storage and postprocessed image.
Image Header	0019,1210	LT		ANAP	AUTO	Attribute present if media storage.
Route AET	0019,1922	LO		ANAP	AUTO	Attribute present if image is sent to EasyVision for being printed.
PCR Print Scale	0019,1923	DS		ALWAYS	AUTO	
PCR Print Job End	0019,1924	ST		ANAP	AUTO	Attribute present if image is sent to EasyVision for being printed.
PCR No Film Copies	0019,1925	IS		ALWAYS	AUTO	
PCR Film Layout Position	0019,1926	IS		ALWAYS	AUTO	

PCR Print Report Name	0019,1927	ST		ANAP	AUTO	Attribute present if image is sent to EasyVision for being printed.
RAD Protocol Printer	0019,1970	ST		ANAP	AUTO	Attribute present if image is sent to EasyVision for being printed.
RAD Protocol Medium	0019,1971	ST		ANAP	AUTO	Attribute present if image is sent to EasyVision for being printed.
Stitching	0019,1982	LT	ON, OFF	ALWAYS	AUTO	
Exposure Index	0019,1989	IS		ANAP	AUTO	If media storage.
Collimator X	0019,198A	IS		ANAP	AUTO	If media storage.
Collimator Y	0019,198B	IS		ANAP	AUTO	If media storage.
Print Marker	0019,198C	LO		ANAP	AUTO	If media storage.
RGDV Name	0019,198D	LO		ANAP	AUTO	If media storage.
Acqd Sensitivity	0019,198E	LO		ANAP	AUTO	If media storage.
Processing Category	0019,198F	LO		ANAP	AUTO	If media storage and image is unprocessed
Unprocessed Flag	0019,1990	LO	no, yes	ALWAYS	AUTO	
Key Values	0019,1991	DS		ANAP	AUTO	Required if Unprocessed Flag = yes.
Destination Postprocessing Function	0019,1992	LO		ANAP	AUTO	Required if Unprocessed Flag = yes.
Version	0019,19A0	LO	0.2	ANAP	AUTO	Required if image was created with 'Unique' option switched on and Unprocessed Flag = yes.
Ranging Mode	0019,19A1	LO	AUTO2, FIXED, MANUAL, READER, SEMI	ANAP	AUTO	Required if Unprocessed Flag = yes and Version = '0.2'.
Abdomen Brightness	0019,19A2	DS		ANAP	AUTO	Required if Unprocessed Flag = yes and Version = '0.2'.
Fixed Brightness	0019,19A3	DS		ANAP	AUTO	Required if Unprocessed Flag = yes and Version = '0.2'.
Detail Contrast	0019,19A4	DS		ANAP	AUTO	Required if Unprocessed Flag = yes and Version = '0.2'.
Contrast Balance	0019,19A5	DA		ANAP	AUTO	Required if Unprocessed Flag = yes and Version = '0.2'.
Structure Boost	0019,19A6	DS		ANAP	AUTO	Required if Unprocessed Flag = yes and Version = '0.2'.
Structure Preference	0019,19A7	DS		ANAP	AUTO	Required if Unprocessed Flag = yes and Version = '0.2'.
Noise Robustness	0019,19A8	DS		ANAP	AUTO	Required if Unprocessed Flag = yes and Version = '0.2'.
Noise Dose Limit	0019,19A9	DS		ANAP	AUTO	Required if Unprocessed Flag = yes and Version = '0.2'.
Noise Dose Step	0019,19AA	DS		ANAP	AUTO	Required if Unprocessed Flag = yes and Version = '0.2'.
Noise Frequency Limit	0019,19AB	DS		ANAP	AUTO	Required if Unprocessed Flag = yes and Version = '0.2'.
Weak Contrast Limit	0019,19AC	DS		ANAP	AUTO	Required if Unprocessed Flag = yes and Version = '0.2'.
Strong Contrast Limit	0019,19AD	DS		ANAP	AUTO	Required if Unprocessed Flag = yes and Version = '0.2'.

Structure Boost Offset	0019,19AE	DS		ANAP	AUTO	Required if Unprocessed Flag = yes and Version = '0.2'.
Smooth Gain	0019,19AF	LO	NO, YES	ANAP	AUTO	Required if Unprocessed Flag = yes and Version = '0.2'.
Measure Field 1	0019,19B0	LO	FULLFIELD, HALFFIELD, QUARTERFIELD, SPLITFIELD	ANAP	AUTO	Required if Unprocessed Flag = yes and Version = '0.2'.
Measure Field 2	0019,19B1	LO	FULLFIELD, HALFFIELD, QUARTERFIELD, SPLITFIELD	ANAP	AUTO	Required if Unprocessed Flag = yes and Version = '0.2'.
Key Percentile 1	0019,19B2	IS		ANAP	AUTO	Required if Unprocessed Flag = yes and Version = '0.2'.
Key Percentile 2	0019,19B3	IS		ANAP	AUTO	Required if Unprocessed Flag = yes and Version = '0.2'.
Density LUT	0019,19B4	IS	0, 1, 2, 3, 4	ANAP	AUTO	Required if Unprocessed Flag = yes and Version = '0.2'.
Brightness	0019,19B5	DS		ANAP	AUTO	Required if Unprocessed Flag = yes.
Gamma	0019,19B6	DS		ANAP	AUTO	Required if Unprocessed Flag = yes.
Private Creator Group 0089 Block 10	0089,0010	LO	DIDI TO PCR 1.1	ALWAYS	FIXED	Stamp image
Stamp Image Sequence	0089,1010	SQ		ALWAYS	AUTO	
>Samples per Pixel	0028,0002	US	1	ALWAYS	FIXED	
>Photometric Interpretation	0028,0004	CS	MONOCHROME1	ALWAYS	AUTO	
>Rows	0028,0010	US		ALWAYS	AUTO	
>Columns	0028,0011	US		ALWAYS	AUTO	
>Bits Allocated	0028,0100	US	8	ALWAYS	FIXED	
>Bits Stored	0028,0101	US	8	ALWAYS	FIXED	
>High Bit	0028,0102	US	7	ALWAYS	FIXED	
>Pixel Representation	0028,0103	US	0000	ALWAYS	FIXED	
>Pixel Data	7FE0,0010	OW		ALWAYS	AUTO	

8.1.1.3. Digital X-Ray Image Storage - For Presentation SOP Class

Table 70: IOD of Created Digital X-Ray Image Storage - For Pres. SOP Instances

Information Entity	Module	Presence Of Module
Patient	Patient Module	ALWAYS
Study	Patient Study Module	CONDITIONAL
Study	General Study Module	ALWAYS
Series	General Series Module	ALWAYS
Series	DX Series Module	ALWAYS
Equipment	General Equipment Module	ALWAYS
Waveform	Acquisition Context Module	ALWAYS
Image	General Image Module	ALWAYS
Image	Image Pixel Module	ALWAYS
Image	X-Ray Acquisition Dose Module	ALWAYS
Image	X-Ray Generation Module	ALWAYS
Image	X-Ray Grid Module	ALWAYS
Image	DX Anatomy Imaged Module	ALWAYS
Image	DX Detector Module	ALWAYS
Image	DX Image Module	ALWAYS
Image	DX Positioning Module	ALWAYS
Image	X-Ray Tomography Acquisition Module	CONDITIONAL
Image	SOP Common Module	ALWAYS

Image	VOI LUT Module	ALWAYS
	Additional Module	CONDITIONAL

Table 71: Patient Module (DX For Pres.)

Attribute Name	Tag	VR	Value	Presence of Value	Source	Comment
Patient's Name	0010,0010	PN		VNAP	MWL/ USER	Value present if received from RIS or entered by user
Patient ID	0010,0020	LO		VNAP	MWL/ USER	Primary hospital identification number or code for the patient. Value present if received from RIS or entered by user
Patient's Birth Date	0010,0030	DA		VNAP	MWL/ USER	Value present if received from RIS or entered by user
Patient's Sex	0010,0040	CS	F, M, O	VNAP	MWL/ USER	Value present if received from RIS or entered by user
Issuer of Patient ID	0010,0021	LO		ANAP	MWL	Name of authority that issued the Patient ID. Attribute present if value received from RIS
Other Patient Ids	0010,1000	LO		ANAP	MWL	Attribute present if value received from RIS
Ethnic Group	0010,2160	SH		ANAP	MWL	Attribute present if value received from RIS
Patient Comments	0010,4000	LT		ANAP	MWL	Attribute present if value received from RIS

Table 72: Patient Study Module (DX For Pres.)

Attribute Name	Tag	VR	Value	Presence of Value	Source	Comment
Patient's Size	0010,1020	DS		ANAP	MWL	Attribute present if value received from RIS
Patient's Weight	0010,1030	DS		ANAP	MWL	Attribute present if value received from RIS

Table 73: General Study Module (DX For Pres.)

Attribute Name	Tag	VR	Value	Presence of Value	Source	Comment
Study Instance UID	0020,000D	UI		ALWAYS	MWL/ AUTO	Unique identifier for the Study. Value received from RIS or auto-generated if not received from RIS
Study Date	0008,0020	DA		ALWAYS	AUTO	
Study Time	0008,0030	TM		ALWAYS	AUTO	
Accession Number	0008,0050	SH		VNAP	MWL/ USER	Value present if received from RIS or entered by user
Referring Physician's Name	0008,0090	PN		VNAP	MWL/ USER	Value present if received from RIS or entered by user
Study ID	0020,0010	SH		VNAP	MPPS/ AUTO	User or equipment generated Study identifier. Value received from RIS or auto-generated if not received from RIS

Study Description	0008,1030	LO		ANAP	MWL/AUTO	Configurable to either empty, Examination Name, or Scheduled Procedure Step Description. Attribute present if export via network and value not empty
Physician(s) of Record	0008,1048	PN		ANAP	MWL	Attribute present if value received from RIS
Referenced Study Sequence	0008,1110	SQ		ANAP	MWL	A sequence providing reference to a study SOP Class/Instance pair. Attribute present if value received from RIS (1 item).
>Referenced SOP Class UID	0008,1150	UI	1.2.840.10008.3.1.2.3.1	ALWAYS	FIXED	
>Referenced SOP Instance UID	0008,1155	UI		ALWAYS	MWL	Uniquely identifies the referenced SOP Instance
Procedure Code Sequence	0008,1032	SQ		VNAP	MWL	A sequence that conveys the (single) type of procedure performed. Only a single item shall be permitted in this sequence. Value present for scheduled procedures
>Code Value	0008,0100	SH		ALWAYS	MWL	
>Coding Scheme Designator	0008,0102	SH		ALWAYS	MWL	
>Code Meaning	0008,0104	LO		ALWAYS	MWL	
>Coding Scheme Version	0008,0103	SH		ANAP	MWL	Attribute present if the value of the Coding Scheme Designator is not sufficient to identify the code Value unambiguously

Table 74: General Series Module (DX For Pres.)

Attribute Name	Tag	VR	Value	Presence of Value	Source	Comment
Series Instance UID	0020,000E	UI		ALWAYS	MPPS/AUTO	Unique identifier of the series
Series Number	0020,0011	IS		ALWAYS	AUTO	
Series Date	0008,0021	DA		ALWAYS	AUTO	
Series Time	0008,0031	TM		ALWAYS	AUTO	
Series Description	0008,103E	LO		ALWAYS	AUTO	User provided description of the series
Operators' Name	0008,1070	PN		ANAP	MPPS/USER	The technologist(s) supporting the series. Attribute present if entered by user
Protocol Name	0018,1030	LO		ANAP	MPPS/AUTO	Name of the examination item that maps the Performed Protocol Code Value
Performed Procedure Step Start Date	0040,0244	DA		ALWAYS	MPPS	
Performed Procedure Step Start Time	0040,0245	TM		ALWAYS	MPPS	
Performed Procedure Step ID	0040,0253	SH		ANAP	MPPS	Attribute present if MPPS option is active.
Performed Procedure Step Description	0040,0254	LO		ANAPCV	MWL	Attribute present if MPPS option is active and value is present if received from RIS.

Referenced Performed Procedure Step Sequence	0008,1111	SQ		ANAP	AUTO	Uniquely identifies the Modality Performed Procedure Step SOP Instance to which the series is related. Present if MPPS option is active
>Referenced SOP Class UID	0008,1150	UI	1.2.840.10008.3.1.2.3.3	ALWAYS	FIXED	
>Referenced SOP Instance UID	0008,1155	UI		ALWAYS	AUTO	Uniquely identifies the referenced SOP Instance
Performed Protocol Code Sequence	0040,0260	SQ		VNAP	MWL	Value(s) present if MPPS option active.
>Code Value	0008,0100	SH		ALWAYS	MWL	
>Coding Scheme Designator	0008,0102	SH		ALWAYS	MWL	
>Code Meaning	0008,0104	LO		ALWAYS	MWL	
>Coding Scheme Version	0008,0103	SH		ANAP	MWL	Attribute present if the value of the Coding Scheme Designator is not sufficient to identify the code Value unambiguously
Request Attributes Sequence	0040,0275	SQ		VNAP	MWL	Value(s) present if MPPS option active.
>Scheduled Procedure Step ID	0040,0009	SH		ALWAYS	MWL	
>Requested Procedure ID	0040,1001	SH		ALWAYS	MWL	
>Scheduled Procedure Step Description	0040,0007	LO		ALWAYS	MWL	
>Scheduled Protocol Code Sequence	0040,0008	SQ		VNAP	MWL	If a Procedure Step has not been scheduled by the RIS but entered locally (e.g. as Emergency Case) then this sequence contains an empty item.
>>Code Value	0008,0100	SH		ALWAYS	MWL	
>>Coding Scheme Designator	0008,0102	SH		ALWAYS	MWL	
>>Code Meaning	0008,0104	LO		ALWAYS	MWL	
>>Coding Scheme Version	0008,0103	SH		ANAP	MWL	Attribute present if the value of the Coding Scheme Designator is not sufficient to identify the code Value unambiguously

Table 75: DX Series Module (For Pres.)

Attribute Name	Tag	VR	Value	Presence of Value	Source	Comment
Modality	0008,0060	CS	DX	ALWAYS	FIXED	
Presentation Intent Type	0008,0068	CS	FOR PRESENTATION	ALWAYS	FIXED	All processed Images are marked as 'FOR PRESENTATION'.

Table 76: General Equipment Module (DX For Pres.)

Attribute Name	Tag	VR	Value	Presence of Value	Source	Comment
Manufacturer	0008,0070	LO	Philips Medical Systems	ALWAYS	FIXED	
Institution Name	0008,0080	LO		VNAP	CONFIG	Value present if configured
Station Name	0008,1010	SH		VNAP	CONFIG	Value present if configured
Institutional Department Name	0008,1040	LO		VNAP	CONFIG	Value present if configured
Manufacturer's Model Name	0008,1090	LO	digital DIAGNOST	ALWAYS	FIXED	
Device Serial Number	0018,1000	LO		ALWAYS	AUTO	
Software Version(s)	0018,1020	LO	Version 1.5.3	ALWAYS	FIXED	
Date of Last Calibration	0018,1200	DA		ALWAYS	AUTO	

Time of Last Calibration	0018,1201	TM		ALWAYS	AUTO	
--------------------------	-----------	----	--	--------	------	--

Table 77: Acquisition Context Module (DX For Pres.)

Attribute Name	Tag	VR	Value	Presence of Value	Source	Comment
Acquisition Context Sequence	0040,0555	SQ		ANAPEV	AUTO	Always empty

Table 78: General Image Module (DX For Pres.)

Attribute Name	Tag	VR	Value	Presence of Value	Source	Comment
Instance Number	0020,0013	IS		ALWAYS	AUTO	> 1
Content Date	0008,0023	DA		ALWAYS	AUTO	
Content Time	0008,0033	TM		ALWAYS	AUTO	
Patient Orientation	0020,0020	CS	A, P, R, L, H, F	ALWAYS	AUTO	
Image Type	0008,0008	CS	DERIVED\PRIMARY	ALWAYS	FIXED	
Acquisition Number	0020,0012	IS		VNAP	MWL	
Image Comments	0020,4000	LT		ALWAYS	AUTO	

Table 79: Image Pixel Module (DX For Pres.)

Attribute Name	Tag	VR	Value	Presence of Value	Source	Comment
Rows	0028,0010	US		ALWAYS	AUTO	
Columns	0028,0011	US		ALWAYS	AUTO	
Pixel Data	7FE0,0010	O W/ OB		ALWAYS	AUTO	

Table 80: X-Ray Acquisition Dose Module (DX For Pres.)

Attribute Name	Tag	VR	Value	Presence of Value	Source	Comment
KVP	0018,0060	DS		ALWAYS	MPPS/ AUTO	
Distance Source to Detector	0018,1110	DS		ALWAYS	AUTO	
Exposure Time	0018,1150	IS		ALWAYS	MPPS/ AUTO	
Exposure	0018,1152	IS		ALWAYS	AUTO	
Exposure in uAs	0018,1153	IS		ALWAYS	AUTO	
Image and Fluoroscopy Area Dose Product	0018,115E	DS		ALWAYS	AUTO	
Exposure Time in uS	0018,8150	DS		ALWAYS	AUTO	

Table 81: X-Ray Generation Module (DX For Pres.)

Attribute Name	Tag	VR	Value	Presence of Value	Source	Comment
Focal Spot(s)	0018,1190	DS		ALWAYS	AUTO	

Table 82: X-Ray Grid Module (DX For Pres.)

Attribute Name	Tag	VR	Value	Presence of Value	Source	Comment
Grid	0018,1166	CS	FOCUSED\RECIPROCAT ING\PARALLEL	ALWAYS	FIXED	

Table 83: DX Anatomy Imaged Module (For Pres.)

Attribute Name	Tag	VR	Value	Presence of Value	Source	Comment
Image Laterality	0020,0062	CS	R, L, U, B	ALWAYS	AUTO	
Anatomic Region Sequence	0008,2218	SQ		ALWAYS	FIXED	Sequence with empty item

Table 84: DX Detector Module (For Pres.)

Attribute Name	Tag	VR	Value	Presence of Value	Source	Comment
Imager Pixel Spacing	0018,1164	DS		ALWAYS	AUTO	
Detector Type	0018,7004	CS		VNAP	AUTO	Always empty
Sensitivity	0018,6000	DS		ALWAYS	AUTO	Read out sensitivity

Table 85: DX Image Module (For Pres.)

Attribute Name	Tag	VR	Value	Presence of Value	Source	Comment
Samples per Pixel	0028,0002	US	1	ALWAYS	FIXED	
Photometric Interpretation	0028,0004	CS	MONOCHROME1, MONOCHROME2	ALWAYS	IMPLICIT/AUTO	
Bits Allocated	0028,0100	US	8, 16	ALWAYS	IMPLICIT/AUTO	
Bits Stored	0028,0101	US	8, 10, 12, 15	ALWAYS	IMPLICIT/AUTO	
High Bit	0028,0102	US	7, 9, 11, 14	ALWAYS	IMPLICIT/AUTO	
Pixel Representation	0028,0103	US	0	ALWAYS	IMPLICIT/AUTO	
Burned In Annotation	0028,0301	CS	YES, NO	ALWAYS	AUTO	
Pixel Intensity Relationship	0028,1040	CS	LOG	ALWAYS	FIXED	
Pixel Intensity Relationship Sign	0028,1041	SS	-1, 1	ALWAYS	IMPLICIT/AUTO	
Rescale Intercept	0028,1052	DS	0	ALWAYS	FIXED	
Rescale Slope	0028,1053	DS	1	ALWAYS	FIXED	
Rescale Type	0028,1054	LO	US	ALWAYS	FIXED	
Lossy Image Compression	0028,2110	CS	00	ALWAYS	FIXED	
Presentation LUT Shape	2050,0020	CS	IDENTITY, INVERSE	ALWAYS	IMPLICIT/AUTO	
Acquisition Device Processing Description	0018,1400	LO		VNAP	AUTO	Describes device specific processing associated with the image

Table 86: DX Positioning Module (For Pres.)

Attribute Name	Tag	VR	Value	Presence of Value	Source	Comment
Positioner Type	0018,1508	CS		VNAP	AUTO	Always empty
View Position	0018,5101	CS		ALWAYS	AUTO	

Table 87: X-Ray Tomography Acquisition Module (DX For Pres.)

Attribute Name	Tag	VR	Value	Presence of Value	Source	Comment
Tomo Layer Height	0018,1460	DS		ALWAYS	AUTO	
Tomo Angle	0018,1470	DS		ALWAYS	AUTO	
Tomo Time	0018,1480	DS		ALWAYS	AUTO	

Table 88: SOP Common Module (DX For Pres.)

Attribute Name	Tag	VR	Value	Presence of Value	Source	Comment
Specific Character Set	0008,0005	CS	ISO_IR 100	ALWAYS	FIXED	
SOP Class UID	0008,0016	UI	1.2.840.10008.5.1.4.1.1.1.1	ALWAYS	FIXED	
SOP Instance UID	0008,0018	UI		ALWAYS	MPPS/AUTO	

Table 89: VOI LUT Module (DX For Pres.)

Attribute Name	Tag	VR	Value	Presence of Value	Source	Comment
Window Center	0028,1050	DS		ALWAYS	AUTO	
Window Width	0028,1051	DS		ALWAYS	AUTO	

Table 90: Additional Module (DX For Pres.)

Attribute Name	Tag	VR	Value	Presence of Value	Source	Comment
Medical Alerts	0010,2000	LO		VNAP	MWL	Conditions to which medical staff should be alerted (e.g. contagious condition, drug allergies, etc). Value present if received from RIS
Contrast Allergies	0010,2110	LO		VNAP	MWL	Value present if received from RIS
Additional Patient History	0010,21B0	LT		ANAP	MWL	Attribute present if value received from RIS
Pregnancy Status	0010,21C0	US	0001, 0002, 0003, 0004	ANAP	MWL	Applied Values: 0001 = not pregnant 0002 = possible pregnant 0003 =definitely pregnant 0004 = unknown. Value present if received from RIS
Image and Fluoroscopy Area Dose Product	0018,115E	DS		ALWAYS	MPPS/AUTO	
Grid	0018,1166	CS	IN, NONE	ALWAYS	AUTO	Applied values: IN = A Grid is positioned NONE = No Grid is used
Processing Function	0018,5020	LO		ALWAYS	AUTO	This attribute has been added for Thoravision (declared as "extend CR-Image attribute") and has been used since
Postprocessing Function	0018,5021	LO		ALWAYS	AUTO	This attribute has been added for Thoravision (declared as "extend CR-Image attribute") and has been used since
Pixel Spacing	0028,0030	DS		VNAP	AUTO	
Requesting Service	0032,1033	LO		ANAP	MWL	Attribute present if value received from RIS
Requested Procedure Description	0032,1060	LO		ANAP	MWL	Attribute present if media storage and value received from RIS.
Special Needs	0038,0050	LO		ANAP	MWL	Medical and social needs (e.g. wheelchair, oxygen, non-English-speaking etc.) Attribute present if value received from RIS
Patient State	0038,0500	LO		ANAP	MWL	Description of patient state (comatose, disoriented, vision impaired etc.) Attribute present if value received from RIS
Scan Options	0018,0022	CS	TOMO	ANAP	AUTO	Only for tomo acquisitions
Private Creator Group 0019 Block 12	0019,0012	LO	SPI-P-Private-DiDi Release 1	ANAP	FIXED	Attribute present if media storage.
Private Creator Group 0019 Block 19	0019,0019	LO	DIDI TO PCR 1.1	ALWAYS	FIXED	
Post Mode String	0019,1200	LT		ANAP	AUTO	Attribute present if media storage and postprocessed image.

Post Data	0019,1201	LT		ANAP	AUTO	Attribute present if media storage and postprocessed image.
Image Header	0019,1210	LT		ANAP	AUTO	Attribute present if media storage.
Route AET	0019,1922	LO		ANAP	AUTO	Attribute present if image is sent to EasyVision for being printed.
PCR Print Scale	0019,1923	DS		ALWAYS	AUTO	
PCR Print Job End	0019,1924	ST		ANAP	AUTO	Attribute present if image is sent to EasyVision for being printed.
PCR No Film Copies	0019,1925	IS		ALWAYS	AUTO	
PCR Film Layout Position	0019,1926	IS		ALWAYS	AUTO	
PCR Print Report Name	0019,1927	ST		ANAP	AUTO	Attribute present if image is sent to EasyVision for being printed.
RAD Protocol Printer	0019,1970	ST		ANAP	AUTO	Attribute present if image is sent to EasyVision for being printed.
RAD Protocol Medium	0019,1971	ST		ANAP	AUTO	Attribute present if image is sent to EasyVision for being printed.
Stitching	0019,1982	LT	ON, OFF	ALWAYS	AUTO	
Exposure Index	0019,1989	IS		ANAP	AUTO	If media storage.
Collimator X	0019,198A	IS		ANAP	AUTO	If media storage.
Collimator Y	0019,198B	IS		ANAP	AUTO	If media storage.
Print Marker	0019,198C	LO		ANAP	AUTO	If media storage.
RGDV Name	0019,198D	LO		ANAP	AUTO	If media storage.
Acqd Sensitivity	0019,198E	LO		ANAP	AUTO	If media storage.
Processing Category	0019,198F	LO		ANAP	AUTO	If media storage and image is unprocessed
Unprocessed Flag	0019,1990	LO	no, yes	ALWAYS	AUTO	
Key Values	0019,1991	DS		ANAP	AUTO	Required if Unprocessed Flag = yes.
Destination Postprocessing Function	0019,1992	LO		ANAP	AUTO	Required if Unprocessed Flag = yes.
Version	0019,19A0	LO	0.2	ANAP	AUTO	Required if image was created with 'Unique' option switched on and Unprocessed Flag = yes.
Ranging Mode	0019,19A1	LO	AUTO2, FIXED, MANUAL, READER, SEMI	ANAP	AUTO	Required if Unprocessed Flag = yes and Version = '0.2'.
Abdomen Brightness	0019,19A2	DS		ANAP	AUTO	Required if Unprocessed Flag = yes and Version = '0.2'.
Fixed Brightness	0019,19A3	DS		ANAP	AUTO	Required if Unprocessed Flag = yes and Version = '0.2'.
Detail Contrast	0019,19A4	DS		ANAP	AUTO	Required if Unprocessed Flag = yes and Version = '0.2'.
Contrast Balance	0019,19A5	DA		ANAP	AUTO	Required if Unprocessed Flag = yes and Version = '0.2'.
Structure Boost	0019,19A6	DS		ANAP	AUTO	Required if Unprocessed Flag = yes and Version = '0.2'.
Structure Preference	0019,19A7	DS		ANAP	AUTO	Required if Unprocessed Flag = yes and Version = '0.2'.
Noise Robustness	0019,19A8	DS		ANAP	AUTO	Required if Unprocessed Flag = yes and Version = '0.2'.

Noise Dose Limit	0019,19A9	DS		ANAP	AUTO	Required if Unprocessed Flag = yes and Version = '0.2'.
Noise Dose Step	0019,19AA	DS		ANAP	AUTO	Required if Unprocessed Flag = yes and Version = '0.2'.
Noise Frequency Limit	0019,19AB	DS		ANAP	AUTO	Required if Unprocessed Flag = yes and Version = '0.2'.
Weak Contrast Limit	0019,19AC	DS		ANAP	AUTO	Required if Unprocessed Flag = yes and Version = '0.2'.
Strong Contrast Limit	0019,19AD	DS		ANAP	AUTO	Required if Unprocessed Flag = yes and Version = '0.2'.
Structure Boost Offset	0019,19AE	DS		ANAP	AUTO	Required if Unprocessed Flag = yes and Version = '0.2'.
Smooth Gain	0019,19AF	LO	NO, YES	ANAP	AUTO	Required if Unprocessed Flag = yes and Version = '0.2'.
Measure Field 1	0019,19B0	LO	FULLFIELD, HALFFIELD, QUARTERFIELD, SPLITFIELD	ANAP	AUTO	Required if Unprocessed Flag = yes and Version = '0.2'.
Measure Field 2	0019,19B1	LO	FULLFIELD, HALFFIELD, QUARTERFIELD, SPLITFIELD	ANAP	AUTO	Required if Unprocessed Flag = yes and Version = '0.2'.
Key Percentile 1	0019,19B2	IS		ANAP	AUTO	Required if Unprocessed Flag = yes and Version = '0.2'.
Key Percentile 2	0019,19B3	IS		ANAP	AUTO	Required if Unprocessed Flag = yes and Version = '0.2'.
Density LUT	0019,19B4	IS	0, 1, 2, 3, 4	ANAP	AUTO	Required if Unprocessed Flag = yes and Version = '0.2'.
Brightness	0019,19B5	DS		ANAP	AUTO	Required if Unprocessed Flag = yes.
Gamma	0019,19B6	DS		ANAP	AUTO	Required if Unprocessed Flag = yes.
Private Creator Group 0089 Block 10	0089,0010	LO	DIDI TO PCR 1.1	ALWAYS	FIXED	Stamp image
Stamp Image Sequence	0089,1010	SQ		ALWAYS	AUTO	
>Samples per Pixel	0028,0002	US	1	ALWAYS	FIXED	
>Photometric Interpretation	0028,0004	CS	MONOCHROME1	ALWAYS	AUTO	
>Rows	0028,0010	US		ALWAYS	AUTO	
>Columns	0028,0011	US		ALWAYS	AUTO	
>Bits Allocated	0028,0100	US	8	ALWAYS	FIXED	
>Bits Stored	0028,0101	US	8	ALWAYS	FIXED	
>High Bit	0028,0102	US	7	ALWAYS	FIXED	
>Pixel Representation	0028,0103	US	0000	ALWAYS	FIXED	
>Pixel Data	7FE0,0010	OW		ALWAYS	AUTO	

8.1.1.4. Digital X-Ray Image Storage - For Processing SOP Class

Table 91: IOD of Created Digital X-Ray Image Storage - For Proc. SOP Instances

Information Entity	Module	Presence Of Module
Patient	Patient Module	ALWAYS
Patient	Patient Study Module	CONDITIONAL
Study	General Study Module	ALWAYS
Series	General Series Module	ALWAYS
Series	DX Series Module	ALWAYS

Equipment	General Equipment Module	ALWAYS
Waveform	Acquisition Context Module	ALWAYS
Image	General Image Module	ALWAYS
Image	Image Pixel Module	ALWAYS
Image	DX Anatomy Imaged Module	ALWAYS
Image	DX Detector Module	ALWAYS
Image	DX Image Module	ALWAYS
Image	DX Positioning Module	ALWAYS
Image	X-Ray Acquisition Dose Module	ALWAYS
Image	X-Ray Generation Module	ALWAYS
Image	X-Ray Grid Module	ALWAYS
Image	X-Ray Tomography Acquisition Module	CONDITIONAL
Image	SOP Common Module	ALWAYS
	Additional Module	CONDITIONAL

Table 92: Patient Module (DX For Proc.)

Attribute Name	Tag	VR	Value	Presence of Value	Source	Comment
Patient's Name	0010,0010	PN		VNAP	MWL/USER	Value present if received from RIS or entered by user
Patient ID	0010,0020	LO		VNAP	MWL/USER	Primary hospital identification number or code for the patient. Value present if received from RIS or entered by user
Patient's Birth Date	0010,0030	DA		VNAP	MWL/USER	Value present if received from RIS or entered by user
Patient's Sex	0010,0040	CS	F, M, O	VNAP	MWL/USER	Value present if received from RIS or entered by user
Issuer of Patient ID	0010,0021	LO		ANAP	MWL	Name of authority that issued the Patient ID. Attribute present if value received from RIS
Other Patient Ids	0010,1000	LO		ANAP	MWL	Attribute present if value received from RIS
Ethnic Group	0010,2160	SH		ANAP	MWL	Attribute present if value received from RIS
Patient Comments	0010,4000	LT		ANAP	MWL	Attribute present if value received from RIS

Table 93: Patient Study Module (DX For Proc.)

Attribute Name	Tag	VR	Value	Presence of Value	Source	Comment
Patient's Size	0010,1020	DS		ANAP	MWL	Attribute present if value received from RIS
Patient's Weight	0010,1030	DS		ANAP	MWL	Attribute present if value received from RIS

Table 94: General Study Module (DX For Proc.)

Attribute Name	Tag	VR	Value	Presence of Value	Source	Comment
Study Instance UID	0020,000D	UI		ALWAYS	MWL/AUTO	Unique identifier for the Study. Value received from RIS or auto-generated if not received from RIS
Study Date	0008,0020	DA		ALWAYS	AUTO	
Study Time	0008,0030	TM		ALWAYS	AUTO	

Accession Number	0008,0050	SH		VNAP	MWL/ USER	Value present if received from RIS or entered by user
Referring Physician's Name	0008,0090	PN		VNAP	MWL/ USER	Value present if received from RIS or entered by user
Study ID	0020,0010	SH		VNAP	MPPS/ AUTO	User or equipment generated Study identifier. Value received from RIS or auto-generated if not received from RIS
Study Description	0008,1030	LO		ANAP	MWL/ AUTO	Configurable to either empty, Examination Name, or Scheduled Procedure Step Description. Attribute present if export via network and value not empty
Physician(s) of Record	0008,1048	PN		ANAP	MWL	Attribute present if value received from RIS
Referenced Study Sequence	0008,1110	SQ		ANAP	MWL	A sequence providing reference to a study SOP Class/Instance pair. Attribute present if value received from RIS (1 item).
>Referenced SOP Class UID	0008,1150	UI	1.2.840.10008.3.1.2.3.1	ALWAYS	FIXED	
>Referenced SOP Instance UID	0008,1155	UI		ALWAYS	MWL	Uniquely identifies the referenced SOP Instance
Procedure Code Sequence	0008,1032	SQ		VNAP	MWL	A sequence that conveys the (single) type of procedure performed. Only a single item shall be permitted in this sequence. Value present for scheduled procedures
>Code Value	0008,0100	SH		ALWAYS	MWL	
>Coding Scheme Designator	0008,0102	SH		ALWAYS	MWL	
>Code Meaning	0008,0104	LO		ALWAYS	MWL	
>Coding Scheme Version	0008,0103	SH		ANAP	MWL	Attribute present if the value of the Coding Scheme Designator is not sufficient to identify the code Value unambiguously

Table 95: General Series Module (DX For Proc.)

Attribute Name	Tag	VR	Value	Presence of Value	Source	Comment
Series Instance UID	0020,000E	UI		ALWAYS	MPPS/ AUTO	Unique identifier of the series
Series Number	0020,0011	IS		ALWAYS	AUTO	
Series Date	0008,0021	DA		ALWAYS	AUTO	
Series Time	0008,0031	TM		ALWAYS	AUTO	
Series Description	0008,103E	LO		ALWAYS	AUTO	User provided description of the series
Operators' Name	0008,1070	PN		ANAP	MPPS/ USER	The technologist(s) supporting the series. Attribute present if entered by user
Protocol Name	0018,1030	LO		ANAP	MPPS/ AUTO	Name of the examination item that maps the Performed Protocol Code Value
Performed Procedure Step Start Date	0040,0244	DA		ALWAYS	MPPS	

Performed Procedure Step Start Time	0040,0245	TM		ALWAYS	MPPS	
Performed Procedure Step ID	0040,0253	SH		ANAP	MPPS	Attribute present if MPPS option is active.
Performed Procedure Step Description	0040,0254	LO		ANAPCV	MWL	Attribute present if MPPS option is active and value is present if received from RIS.
Referenced Performed Procedure Step Sequence	0008,1111	SQ		ANAP	AUTO	Uniquely identifies the Modality Performed Procedure Step SOP Instance to which the series is related. Present if MPPS option is active
>Referenced SOP Class UID	0008,1150	UI	1.2.840.10008.3.1.2.3.3	ALWAYS	FIXED	
>Referenced SOP Instance UID	0008,1155	UI		ALWAYS	AUTO	Uniquely identifies the referenced SOP Instance
Performed Protocol Code Sequence	0040,0260	SQ		VNAP	MWL	Value(s) present if MPPS option active.
>Code Value	0008,0100	SH		ALWAYS	MWL	
>Coding Scheme Designator	0008,0102	SH		ALWAYS	MWL	
>Code Meaning	0008,0104	LO		ALWAYS	MWL	
>Coding Scheme Version	0008,0103	SH		ANAP	MWL	Attribute present if the value of the Coding Scheme Designator is not sufficient to identify the code Value unambiguously
Request Attributes Sequence	0040,0275	SQ		VNAP	MWL	Value(s) present if MPPS option active.
>Scheduled Procedure Step ID	0040,0009	SH		ALWAYS	MWL	
>Requested Procedure ID	0040,1001	SH		ALWAYS	MWL	
>Scheduled Procedure Step Description	0040,0007	LO		ALWAYS	MWL	
>Scheduled Protocol Code Sequence	0040,0008	SQ		VNAP	MWL	If a Procedure Step has not been scheduled by the RIS but entered locally (e.g. as Emergency Case) then this sequence contains an empty item.
>>Code Value	0008,0100	SH		ALWAYS	MWL	
>>Coding Scheme Designator	0008,0102	SH		ALWAYS	MWL	
>>Code Meaning	0008,0104	LO		ALWAYS	MWL	
>>Coding Scheme Version	0008,0103	SH		ANAP	MWL	Attribute present if the value of the Coding Scheme Designator is not sufficient to identify the code Value unambiguously

Table 96: DX Series Module (For Proc.)

Attribute Name	Tag	VR	Value	Presence of Value	Source	Comment
Modality	0008,0060	CS	DX	ALWAYS	FIXED	
Presentation Intent Type	0008,0068	CS	FOR PROCESSING	ALWAYS	FIXED	All preimages and Unprocessed UNIQUE images will be marked as 'FOR PROCESSING'.

Table 97: General Equipment Module (DX For Proc.)

Attribute Name	Tag	VR	Value	Presence of Value	Source	Comment
Manufacturer	0008,0070	LO	Philips Medical Systems	ALWAYS	FIXED	
Institution Name	0008,0080	LO		VNAP	CONFIG	Value present if configured

Station Name	0008,1010	SH		VNAP	CONFIG	Value present if configured
Institutional Department Name	0008,1040	LO		VNAP	CONFIG	Value present if configured
Manufacturer's Model Name	0008,1090	LO	digital DIAGNOST	ALWAYS	FIXED	
Device Serial Number	0018,1000	LO		ALWAYS	AUTO	
Software Version(s)	0018,1020	LO	Version 1.5.3	ALWAYS	FIXED	
Date of Last Calibration	0018,1200	DA		ALWAYS	AUTO	
Time of Last Calibration	0018,1201	TM		ALWAYS	AUTO	

Table 98: Acquisition Context Module (DX For Proc.)

Attribute Name	Tag	VR	Value	Presence of Value	Source	Comment
Acquisition Context Sequence	0040,0555	SQ		ANAPEV	AUTO	Always empty

Table 99: General Image Module (DX For Proc.)

Attribute Name	Tag	VR	Value	Presence of Value	Source	Comment
Instance Number	0020,0013	IS	1	ALWAYS	FIXED	
Content Date	0008,0023	DA		ALWAYS	AUTO	
Content Time	0008,0033	TM		ALWAYS	AUTO	
Acquisition Number	0020,0012	IS		VNAP	MWL	
Image Comments	0020,4000	LT		ALWAYS	AUTO	

Table 100: Image Pixel Module (DX For Proc.)

Attribute Name	Tag	VR	Value	Presence of Value	Source	Comment
Rows	0028,0010	US		ALWAYS	AUTO	
Columns	0028,0011	US		ALWAYS	AUTO	
Pixel Data	7FE0,0010	O W/ OB		ALWAYS	AUTO	

Table 101: DX Anatomy Imaged Module (For Proc.)

Attribute Name	Tag	VR	Value	Presence of Value	Source	Comment
Image Laterality	0020,0062	CS	R, L, U, B	ALWAYS	AUTO	
Anatomic Region Sequence	0008,2218	SQ		ALWAYS	AUTO	Sequence without items

Table 102: DX Detector Module (For Proc.)

Attribute Name	Tag	VR	Value	Presence of Value	Source	Comment
Imager Pixel Spacing	0018,1164	DS		ALWAYS	AUTO	
Detector Type	0018,7004	CS		VNAP	AUTO	Always empty

Table 103: DX Image Module (For Proc.)

Attribute Name	Tag	VR	Value	Presence of Value	Source	Comment
Image Type	0008,0008	CS	'ORIGINAL\PRIMARY'	ALWAYS	FIXED	
Patient Orientation	0020,0020	CS	A, P, R, L, H, F	ALWAYS	AUTO	
Samples per Pixel	0028,0002	US	1	ALWAYS	FIXED	
Photometric Interpretation	0028,0004	CS	MONOCHROME1	ALWAYS	FIXED	
Bits Allocated	0028,0100	US	16	ALWAYS	FIXED	
Bits Stored	0028,0101	US	15	ALWAYS	FIXED	
High Bit	0028,0102	US	14	ALWAYS	FIXED	
Pixel Representation	0028,0103	US	0	ALWAYS	FIXED	
Burned In Annotation	0028,0301	CS	NO	ALWAYS	FIXED	

Pixel Intensity Relationship	0028,1040	CS	LOG	ALWAYS	FIXED	
Pixel Intensity Relationship Sign	0028,1041	SS	1	ALWAYS	FIXED	
Rescale Intercept	0028,1052	DS	0	ALWAYS	FIXED	
Rescale Slope	0028,1053	DS	1	ALWAYS	FIXED	
Rescale Type	0028,1054	LO	US	ALWAYS	FIXED	
Lossy Image Compression	0028,2110	CS	00	ALWAYS	FIXED	

Table 104: DX Positioning Module (For Proc.)

Attribute Name	Tag	VR	Value	Presence of Value	Source	Comment
Positioner Type	0018,1508	CS		VNAP	AUTO	Always empty
View Position	0018,5101	CS		ALWAYS	AUTO	

Table 105: X-Ray Acquisition Dose Module (DX For Proc.)

Attribute Name	Tag	VR	Value	Presence of Value	Source	Comment
KVP	0018,0060	DS		ALWAYS	MPPS/ AUTO	
Distance Source to Detector	0018,1110	DS		ALWAYS	AUTO	
Exposure Time	0018,1150	IS		ALWAYS	MPPS/ AUTO	
Exposure	0018,1152	IS		ALWAYS	AUTO	
Exposure in uAs	0018,1153	IS		ALWAYS	AUTO	
Image and Fluoroscopy Area Dose Product	0018,115E	DS		ALWAYS	AUTO	
Exposure Time in uS	0018,8150	DS		ALWAYS	AUTO	

Table 106: X-Ray Generation Module (DX For Proc.)

Attribute Name	Tag	VR	Value	Presence of Value	Source	Comment
Focal Spot(s)	0018,1190	DS		ALWAYS	AUTO	

Table 107: X-Ray Grid Module (DX For Proc.)

Attribute Name	Tag	VR	Value	Presence of Value	Source	Comment
Grid	0018,1166	CS	FOCUSED\RECIPROCAT ING\PARALLEL	ALWAYS	FIXED	

Table 108: X-Ray Tomography Acquisition Module (DX For Proc.)

Attribute Name	Tag	VR	Value	Presence of Value	Source	Comment
Tomo Layer Height	0018,1460	DS		ALWAYS	AUTO	
Tomo Angle	0018,1470	DS		ALWAYS	AUTO	
Tomo Time	0018,1480	DS		ALWAYS	AUTO	

Table 109: SOP Common Module (DX For Proc.)

Attribute Name	Tag	VR	Value	Presence of Value	Source	Comment
Specific Character Set	0008,0005	CS	ISO_IR 100	ALWAYS	FIXED	
SOP Class UID	0008,0016	UI	1.2.840.10008.5.1.4.1.1.1.1	ALWAYS	FIXED	
SOP Instance UID	0008,0018	UI		ALWAYS	MPPS/ AUTO	

Table 110: Additional Module (DX For Proc.)

Attribute Name	Tag	VR	Value	Presence of Value	Source	Comment
Medical Alerts	0010,2000	LO		VNAP	MWL	Conditions to which medical staff should be alerted (e.g. contagious condition, drug allergies, etc). Value present if received from RIS
Contrast Allergies	0010,2110	LO		VNAP	MWL	Value present if received from RIS
Additional Patient History	0010,21B0	LT		ANAP	MWL	Attribute present if value received from RIS
Pregnancy Status	0010,21C0	US	0001, 0002, 0003, 0004	ANAP	MWL	Applied Values: 0001 = not pregnant 0002 = possible pregnant 0003 =definitely pregnant 0004 = unknown. Value present if received from RIS
Image and Fluoroscopy Area Dose Product	0018,115E	DS		ALWAYS	MPPS/AUTO	
Grid	0018,1166	CS	IN, NONE	ALWAYS	AUTO	Applied values: IN = A Grid is positioned NONE = No Grid is used
Processing Function	0018,5020	LO		ALWAYS	AUTO	This attribute has been added for Thoravision (declared as "extend CR-Image attribute") and has been used since
Postprocessing Function	0018,5021	LO		ALWAYS	AUTO	This attribute has been added for Thoravision (declared as "extend CR-Image attribute") and has been used since
Pixel Spacing	0028,0030	DS		VNAP	AUTO	
Requesting Service	0032,1033	LO		ANAP	MWL	Attribute present if value received from RIS
Requested Procedure Description	0032,1060	LO		ANAP	MWL	Attribute present if media storage and value received from RIS.
Special Needs	0038,0050	LO		ANAP	MWL	Medical and social needs (e.g. wheelchair, oxygen, non-English-speaking etc.) Attribute present if value received from RIS
Patient State	0038,0500	LO		ANAP	MWL	Description of patient state (comatose, disoriented, vision impaired etc.) Attribute present if value received from RIS
Scan Options	0018,0022	CS	TOMO	ANAP	AUTO	Only for tomo acquisitions
Private Creator Group 0019 Block 12	0019,0012	LO	SPI-P-Private-DiDi Release 1	ANAP	FIXED	Attribute present if media storage.
Private Creator Group 0019 Block 19	0019,0019	LO	DIDI TO PCR 1.1	ALWAYS	FIXED	
Post Mode String	0019,1200	LT		ANAP	AUTO	Attribute present if media storage and postprocessed image.
Post Data	0019,1201	LT		ANAP	AUTO	Attribute present if media storage and postprocessed image.
Image Header	0019,1210	LT		ANAP	AUTO	Attribute present if media storage.

Route AET	0019,1922	LO		ANAP	AUTO	Attribute present if image is sent to EasyVision for being printed.
PCR Print Scale	0019,1923	DS		ALWAYS	AUTO	
PCR Print Job End	0019,1924	ST		ANAP	AUTO	Attribute present if image is sent to EasyVision for being printed.
PCR No Film Copies	0019,1925	IS		ALWAYS	AUTO	
PCR Film Layout Position	0019,1926	IS		ALWAYS	AUTO	
PCR Print Report Name	0019,1927	ST		ANAP	AUTO	Attribute present if image is sent to EasyVision for being printed.
RAD Protocol Printer	0019,1970	ST		ANAP	AUTO	Attribute present if image is sent to EasyVision for being printed.
RAD Protocol Medium	0019,1971	ST		ANAP	AUTO	Attribute present if image is sent to EasyVision for being printed.
Stitching	0019,1982	LT	ON, OFF	ALWAYS	AUTO	
Exposure Index	0019,1989	IS		ANAP	AUTO	If media storage.
Collimator X	0019,198A	IS		ANAP	AUTO	If media storage.
Collimator Y	0019,198B	IS		ANAP	AUTO	If media storage.
Print Marker	0019,198C	LO		ANAP	AUTO	If media storage.
RGDV Name	0019,198D	LO		ANAP	AUTO	If media storage.
Acqd Sensitivity	0019,198E	LO		ANAP	AUTO	If media storage.
Processing Category	0019,198F	LO		ANAP	AUTO	If media storage and image is unprocessed
Unprocessed Flag	0019,1990	LO	no, yes	ALWAYS	AUTO	
Key Values	0019,1991	DS		ANAP	AUTO	Required if Unprocessed Flag = yes.
Destination Postprocessing Function	0019,1992	LO		ANAP	AUTO	Required if Unprocessed Flag = yes.
Version	0019,19A0	LO	0.2	ANAP	AUTO	Required if image was created with 'Unique' option switched on and Unprocessed Flag = yes.
Ranging Mode	0019,19A1	LO	AUTO2, FIXED, MANUAL, READER, SEMI	ANAP	AUTO	Required if Unprocessed Flag = yes and Version = '0.2'.
Abdomen Brightness	0019,19A2	DS		ANAP	AUTO	Required if Unprocessed Flag = yes and Version = '0.2'.
Fixed Brightness	0019,19A3	DS		ANAP	AUTO	Required if Unprocessed Flag = yes and Version = '0.2'.
Detail Contrast	0019,19A4	DS		ANAP	AUTO	Required if Unprocessed Flag = yes and Version = '0.2'.
Contrast Balance	0019,19A5	DA		ANAP	AUTO	Required if Unprocessed Flag = yes and Version = '0.2'.
Structure Boost	0019,19A6	DS		ANAP	AUTO	Required if Unprocessed Flag = yes and Version = '0.2'.
Structure Preference	0019,19A7	DS		ANAP	AUTO	Required if Unprocessed Flag = yes and Version = '0.2'.
Noise Robustness	0019,19A8	DS		ANAP	AUTO	Required if Unprocessed Flag = yes and Version = '0.2'.
Noise Dose Limit	0019,19A9	DS		ANAP	AUTO	Required if Unprocessed Flag = yes and Version = '0.2'.
Noise Dose Step	0019,19AA	DS		ANAP	AUTO	Required if Unprocessed Flag = yes and Version = '0.2'.

Noise Frequency Limit	0019,19AB	DS		ANAP	AUTO	Required if Unprocessed Flag = yes and Version = '0.2'.
Weak Contrast Limit	0019,19AC	DS		ANAP	AUTO	Required if Unprocessed Flag = yes and Version = '0.2'.
Strong Contrast Limit	0019,19AD	DS		ANAP	AUTO	Required if Unprocessed Flag = yes and Version = '0.2'.
Structure Boost Offset	0019,19AE	DS		ANAP	AUTO	Required if Unprocessed Flag = yes and Version = '0.2'.
Smooth Gain	0019,19AF	LO	NO, YES	ANAP	AUTO	Required if Unprocessed Flag = yes and Version = '0.2'.
Measure Field 1	0019,19B0	LO	FULLFIELD, HALFFIELD, QUARTERFIELD, SPLITFIELD	ANAP	AUTO	Required if Unprocessed Flag = yes and Version = '0.2'.
Measure Field 2	0019,19B1	LO	FULLFIELD, HALFFIELD, QUARTERFIELD, SPLITFIELD	ANAP	AUTO	Required if Unprocessed Flag = yes and Version = '0.2'.
Key Percentile 1	0019,19B2	IS		ANAP	AUTO	Required if Unprocessed Flag = yes and Version = '0.2'.
Key Percentile 2	0019,19B3	IS		ANAP	AUTO	Required if Unprocessed Flag = yes and Version = '0.2'.
Density LUT	0019,19B4	IS	0, 1, 2, 3, 4	ANAP	AUTO	Required if Unprocessed Flag = yes and Version = '0.2'.
Brightness	0019,19B5	DS		ANAP	AUTO	Required if Unprocessed Flag = yes.
Gamma	0019,19B6	DS		ANAP	AUTO	Required if Unprocessed Flag = yes.
Private Creator Group 0089 Block 10	0089,0010	LO	DIDI TO PCR 1.1	ALWAYS	FIXED	Stamp image
Stamp Image Sequence	0089,1010	SQ		ALWAYS	AUTO	
>Samples per Pixel	0028,0002	US	1	ALWAYS	FIXED	
>Photometric Interpretation	0028,0004	CS	MONOCHROME1	ALWAYS	AUTO	
>Rows	0028,0010	US		ALWAYS	AUTO	
>Columns	0028,0011	US		ALWAYS	AUTO	
>Bits Allocated	0028,0100	US	8	ALWAYS	FIXED	
>Bits Stored	0028,0101	US	8	ALWAYS	FIXED	
>High Bit	0028,0102	US	7	ALWAYS	FIXED	
>Pixel Representation	0028,0103	US	0000	ALWAYS	FIXED	
>Pixel Data	7FE0,0010	OW		ALWAYS	AUTO	

8.1.1.5. Secondary Capture Image Storage SOP Class

Table 111: IOD of Created Secondary Capture Image Storage SOP Class Instances

Information Entity	Module	Presence Of Module
Patient	Patient Module	ALWAYS
Study	Patient Study Module	ALWAYS
Study	General Study Module	ALWAYS
Series	General Series Module	ALWAYS
Equipment	General Equipment Module	ALWAYS
Equipment	SC Equipment Module	ALWAYS
Image	General Image Module	ALWAYS
Image	Image Pixel Module	ALWAYS
Image	SC Image Module	ALWAYS

Image	SOP Common Module	ALWAYS
Image	VOI LUT Module	ALWAYS
	Additional Module	ALWAYS

Table 112: Patient Module (SC)

Attribute Name	Tag	VR	Value	Presence of Value	Source	Comment
Patient's Name	0010,0010	PN		VNAP	MWL/USER	Value present if received from RIS or entered by user
Patient ID	0010,0020	LO		VNAP	MWL/USER	Primary hospital identification number or code for the patient. Value present if received from RIS or entered by user
Patient's Birth Date	0010,0030	DA		VNAP	MWL/USER	Value present if received from RIS or entered by user
Patient's Sex	0010,0040	CS	F, M, O	VNAP	MWL/USER	Value present if received from RIS or entered by user
Issuer of Patient ID	0010,0021	LO		ANAP	MWL	Name of authority that issued the Patient ID. Attribute present if value received from RIS
Other Patient Ids	0010,1000	LO		ANAP	MWL	Attribute present if value received from RIS
Ethnic Group	0010,2160	SH		ANAP	MWL	Attribute present if value received from RIS
Patient Comments	0010,4000	LT		ANAP	MWL	Attribute present if value received from RIS

Table 113: Patient Study Module (SC)

Attribute Name	Tag	VR	Value	Presence of Value	Source	Comment
Patient's Size	0010,1020	DS		ANAP	MWL	Attribute present if value received from RIS
Patient's Weight	0010,1030	DS		ANAP	MWL	Attribute present if value received from RIS

Table 114: General Study Module (SC)

Attribute Name	Tag	VR	Value	Presence of Value	Source	Comment
Study Instance UID	0020,000D	UI		ALWAYS	MWL/AUTO	Unique identifier for the Study. Value received from RIS or auto-generated if not received from RIS
Study Date	0008,0020	DA		ALWAYS	AUTO	
Study Time	0008,0030	TM		ALWAYS	AUTO	
Accession Number	0008,0050	SH		VNAP	MWL/USER	Value present if received from RIS or entered by user
Referring Physician's Name	0008,0090	PN		VNAP	MWL/USER	Value present if received from RIS or entered by user
Study ID	0020,0010	SH		VNAP	MPPS/AUTO	User or equipment generated Study identifier. Value received from RIS or auto-generated if not received from RIS

Study Description	0008,1030	LO		ANAP	MWL/AUTO	Configurable to either empty, Examination Name, or Scheduled Procedure Step Description. Attribute present if export via network and value not empty
Physician(s) of Record	0008,1048	PN		ANAP	MWL	Attribute present if value received from RIS
Referenced Study Sequence	0008,1110	SQ		ANAP	MWL	A sequence providing reference to a study SOP Class/Instance pair. Attribute present if value received from RIS (1 item).
>Referenced SOP Class UID	0008,1150	UI	1.2.840.10008.3.1.2.3.1	ALWAYS	FIXED	
>Referenced SOP Instance UID	0008,1155	UI		ALWAYS	MWL	Uniquely identifies the referenced SOP Instance
Procedure Code Sequence	0008,1032	SQ		VNAP	MWL	A sequence that conveys the (single) type of procedure performed. Only a single item shall be permitted in this sequence. Value present for scheduled procedures
>Code Value	0008,0100	SH		ALWAYS	MWL	
>Coding Scheme Designator	0008,0102	SH		ALWAYS	MWL	
>Code Meaning	0008,0104	LO		ALWAYS	MWL	
>Coding Scheme Version	0008,0103	SH		ANAP	MWL	Attribute present if the value of the Coding Scheme Designator is not sufficient to identify the code Value unambiguously

Table 115: General Series Module (SC)

Attribute Name	Tag	VR	Value	Presence of Value	Source	Comment
Series Instance UID	0020,000E	UI		ALWAYS	MPPS/AUTO	Unique identifier of the series
Series Number	0020,0011	IS		ALWAYS	AUTO	
Laterality	0020,0060	CS	L, R	VNAP	AUTO	Value present if value configured for acquisition
Series Date	0008,0021	DA		ALWAYS	AUTO	
Series Time	0008,0031	TM		ALWAYS	AUTO	
Series Description	0008,103E	LO		ALWAYS	AUTO	User provided description of the series
Operators' Name	0008,1070	PN		ANAP	MPPS/USER	The technologist(s) supporting the series. Attribute present if entered by user
Protocol Name	0018,1030	LO		ANAP	MPPS/AUTO	Name of the examination item that maps the Performed Protocol Code Value
Performed Procedure Step Start Date	0040,0244	DA		ALWAYS	MPPS	
Performed Procedure Step Start Time	0040,0245	TM		ALWAYS	MPPS	
Performed Procedure Step ID	0040,0253	SH		ANAP	MPPS	Attribute present if MPPS option is active.
Performed Procedure Step Description	0040,0254	LO		ANAPCV	MWL	Attribute present if MPPS option is active and value is present if received from RIS.

Referenced Performed Procedure Step Sequence	0008,1111	SQ		ANAP	AUTO	Uniquely identifies the Modality Performed Procedure Step SOP Instance to which the series is related. Present if MPPS option is active
>Referenced SOP Class UID	0008,1150	UI	1.2.840.10008.3.1.2.3.3	ALWAYS	FIXED	
>Referenced SOP Instance UID	0008,1155	UI		ALWAYS	AUTO	Uniquely identifies the referenced SOP Instance
Performed Protocol Code Sequence	0040,0260	SQ		VNAP	MWL	Value(s) present if MPPS option active.
>Code Value	0008,0100	SH		ALWAYS	MWL	
>Coding Scheme Designator	0008,0102	SH		ALWAYS	MWL	
>Code Meaning	0008,0104	LO		ALWAYS	MWL	
>Coding Scheme Version	0008,0103	SH		ANAP	MWL	Attribute present if the value of the Coding Scheme Designator is not sufficient to identify the code Value unambiguously
Request Attributes Sequence	0040,0275	SQ		VNAP	MWL	Value(s) present if MPPS option active.
>Scheduled Procedure Step ID	0040,0009	SH		ALWAYS	MWL	
>Requested Procedure ID	0040,1001	SH		ALWAYS	MWL	
>Scheduled Procedure Step Description	0040,0007	LO		ALWAYS	MWL	
>Scheduled Protocol Code Sequence	0040,0008	SQ		VNAP	MWL	If a Procedure Step has not been scheduled by the RIS but entered locally (e.g. as Emergency Case) then this sequence contains an empty item.
>>Code Value	0008,0100	SH		ALWAYS	MWL	
>>Coding Scheme Designator	0008,0102	SH		ALWAYS	MWL	
>>Code Meaning	0008,0104	LO		ALWAYS	MWL	
>>Coding Scheme Version	0008,0103	SH		ANAP	MWL	Attribute present if the value of the Coding Scheme Designator is not sufficient to identify the code Value unambiguously

Table 116: General Equipment Module (SC)

Attribute Name	Tag	VR	Value	Presence of Value	Source	Comment
Manufacturer	0008,0070	LO	Philips Medical Systems	ALWAYS	FIXED	
Institution Name	0008,0080	LO		VNAP	CONFIG	Value present if configured
Station Name	0008,1010	SH		VNAP	CONFIG	Value present if configured
Institutional Department Name	0008,1040	LO		VNAP	CONFIG	Value present if configured
Manufacturer's Model Name	0008,1090	LO	digital DIAGNOST	ALWAYS	FIXED	
Device Serial Number	0018,1000	LO		ALWAYS	AUTO	
Software Version(s)	0018,1020	LO	Version 1.5.3	ALWAYS	FIXED	
Date of Last Calibration	0018,1200	DA		ALWAYS	AUTO	
Time of Last Calibration	0018,1201	TM		ALWAYS	AUTO	

Table 117: SC Equipment Module

Attribute Name	Tag	VR	Value	Presence of Value	Source	Comment
Conversion Type	0008,0064	CS	WSD	ALWAYS	FIXED	
Modality	0008,0060	CS	CR, DX	ALWAYS	AUTO	

Table 118: General Image Module (SC)

Attribute Name	Tag	VR	Value	Presence of Value	Source	Comment
Content Date	0008,0023	DA		ALWAYS	AUTO	
Content Time	0008,0033	TM		ALWAYS	AUTO	
Patient Orientation	0020,0020	CS	A, P, R, L, H, F	ALWAYS	AUTO	
Image Type	0008,0008	CS	DERIVED\SECONDARY	ALWAYS	FIXED	
Acquisition Number	0020,0012	IS		VNAP	MWL/ USER	
Image Comments	0020,4000	LT		ALWAYS	AUTO	

Table 119: Image Pixel Module (SC)

Attribute Name	Tag	VR	Value	Presence of Value	Source	Comment
Samples per Pixel	0028,0002	US	1	ALWAYS	FIXED	
Photometric Interpretation	0028,0004	CS	MONOCHROME1, MONOCHROME2	ALWAYS	AUTO	for media storage: only 'MONOCHROME1'
Rows	0028,0010	US		ALWAYS	AUTO	
Columns	0028,0011	US		ALWAYS	AUTO	
Bits Allocated	0028,0100	US	8, 16	ALWAYS	AUTO	for media storage: only 16
Bits Stored	0028,0101	US	8, 10, 12, 15	ALWAYS	AUTO	for media storage: only 15
High Bit	0028,0102	US	7, 9, 11, 14	ALWAYS	AUTO	for media storage: only 14
Pixel Representation	0028,0103	US	0	ALWAYS	FIXED	
Pixel Data	7FE0,0010	O W/ OB		ALWAYS	AUTO	

Table 120: SC Image Module

Attribute Name	Tag	VR	Value	Presence of Value	Source	Comment
Date of Secondary Capture	0018,1012	DA		ALWAYS	AUTO	
Time of Secondary Capture	0018,1014	TM		ALWAYS	AUTO	

Table 121: SOP Common Module (SC)

Attribute Name	Tag	VR	Value	Presence of Value	Source	Comment
Specific Character Set	0008,0005	CS	ISO_IR 100	ALWAYS	FIXED	
SOP Class UID	0008,0016	UI	1.2.840.10008.5.1.4.1.1.7	ALWAYS	FIXED	
SOP Instance UID	0008,0018	UI		ALWAYS	MPPS/ AUTO	

Table 122: VOI LUT Module (SC)

Attribute Name	Tag	VR	Value	Presence of Value	Source	Comment
Window Center	0028,1050	DS		ALWAYS	AUTO	
Window Width	0028,1051	DS		ALWAYS	AUTO	

Table 123: Additional Module (SC)

Attribute Name	Tag	VR	Value	Presence of Value	Source	Comment
Medical Alerts	0010,2000	LO		VNAP	MWL	
Contrast Allergies	0010,2110	LO		VNAP	MWL	
Additional Patient History	0010,21B0	LT		ANAP	MWL	

Pregnancy Status	0010,21C0	US	0001, 0002, 0003, 0004	ANAP	MWL	Applied values: 0001 = not pregnant 0002 = possible pregnant 0003 = definitely pregnant 0004 = unknown
Pixel Spacing	0028,0030	DS		VNAP	AUTO	
Burned in Annotation	0028,0301	CS		ANAP	AUTO	
Lossy Image Compression	0028,2110	CS	YES, NO	ALWAYS	AUTO	always 'NO'
Requesting Service	0032,1033	LO		ANAP	MWL	
Requested Procedure Description	0032,1060	LO		ANAP	MWL	
Special Needs	0038,0050	LO		ANAP	MWL	
Patient State	0038,0500	LO		ANAP	MWL	
Private Creator Group 0019 Block 12	0019,0012	LO	SPI-P-Private-DiDi Release 1	ANAP	AUTO	If media storage.
Private Creator Group 0019 Block 19	0019,0019	LO	DIDI TO PCR 1.1	ALWAYS	AUTO	
Post Mode String	0019,1200	LT		ANAP	AUTO	If media storage and Instance Number >= 1.
Post Data	0019,1201	LT		ANAP	AUTO	If media storage and Instance Number >= 1.
Image Header	0019,1210	LT		ANAP	AUTO	If media storage.
SCPreName	0019,1220	LT		ANAP	AUTO	if media storage and post image
SCPostNo	0019,1221	IS		ANAP	AUTO	if media storage and post image
SCSOPInstanceUID	0019,1222	LT		ANAP	AUTO	if media storage and post image
SCCreationDate	0019,1223	LT		ANAP	AUTO	if media storage and post image
SCProcessingCategory	0019,1224	LT		ANAP	AUTO	if media storage and post image
SCPostMethod	0019,1225	LT		ANAP	AUTO	if media storage and post image
SCPostString	0019,1226	LT		ANAP	AUTO	if media storage and post image
SCPostString2	0019,1227	LT		ANAP	AUTO	if media storage and post image
SCMode	0019,1228	LT		ANAP	AUTO	if media storage and post image
SCStCommit	0019,1229	IS		ANAP	AUTO	if media storage and post image
SCExported	0019,122A	IS		ANAP	AUTO	if media storage and post image
SCPrinted	0019,122B	IS		ANAP	AUTO	if media storage and post image
SCOperator	0019,122C	LT		ANAP	AUTO	if media storage and post image
SCPreName	0019,1240	LT		ANAP	AUTO	if media storage
SCPreType	0019,1241	IS		ANAP	AUTO	if media storage
PPASOPInstanceUID	0019,1242	LT		ANAP	AUTO	if media storage
PAPrelImage1	0019,1243	LT		ANAP	AUTO	if media storage
PA1_rotation,	0019,1244	DS		ANAP	AUTO	if media storage
PA1_Mirrored,	0019,1245	IS		ANAP	AUTO	if media storage
PAPrelImage2	0019,1246	LT		ANAP	AUTO	if media storage
PA2_rotation	0019,1247	DS		ANAP	AUTO	if media storage
PA2_Mirrored	0019,1248	IS		ANAP	AUTO	if media storage
PAPrelImage3	0019,1249	LT		ANAP	AUTO	if media storage
PA3_rotation	0019,124A	DS		ANAP	AUTO	if media storage
PA3_Mirrored	0019,124B	IS		ANAP	AUTO	if media storage
Join1x1	0019,124C	IS		ANAP	AUTO	if media storage
Join1y1	0019,124D	IS		ANAP	AUTO	if media storage
Join1x2	0019,124E	IS		ANAP	AUTO	if media storage
Join1y2	0019,124F	IS		ANAP	AUTO	if media storage

Join2x1	0019,1250	IS		ANAP	AUTO	if media storage
Join2y1	0019,1251	IS		ANAP	AUTO	if media storage
Join2x2	0019,1252	IS		ANAP	AUTO	if media storage
Join2y2	0019,1253	IS		ANAP	AUTO	if media storage
PPACreationDate	0019,1254	LT		ANAP	AUTO	if media storage
PPAProcessingCategory	0019,1255	LT		ANAP	AUTO	if media storage
PPAPostMethod	0019,1256	LT		ANAP	AUTO	if media storage
PPAMode	0019,1257	LT		ANAP	AUTO	if media storage
PPARejected	0019,1258	IS		ANAP	AUTO	if media storage
PPARejectReason	0019,1259	LT		ANAP	AUTO	if media storage
PPAOperator	0019,125A	LT		ANAP	AUTO	if media storage
PPAJoinOrder	0019,125B	LT		ANAP	AUTO	if media storage
StitchingParameters	0019,125C	LT		ANAP	AUTO	if media storage
SCAcqData0	0019,125D	LT		ANAP	AUTO	if media storage
SCAcqData1	0019,125E	LT		ANAP	AUTO	if media storage
SCAcqData2	0019,125F	LT		ANAP	AUTO	if media storage
PPAStitchingMode	0019,1260	LO		ANAP	AUTO	if media storage
Route AET	0019,1922	LO		ANAP	AUTO	Present if image is sent to EasyVision for being printed.
PCR Print Scale	0019,1923	DS		ALWAYS	AUTO	
PCR Print Job End	0019,1924	ST		ANAP	AUTO	Present if image is sent to EasyVision for being printed.
PCR No Film Copies	0019,1925	IS		ANAP	AUTO	
PCR Film Layout Position	0019,1926	IS		ANAP	AUTO	
PCR Print Report Name	0019,1927	ST		ANAP	AUTO	Present if image is sent to EasyVision for being printed.
RAD Protocol Printer	0019,1970	ST		ANAP	AUTO	Present if image is sent to EasyVision for being printed.
RAD Protocol Medium	0019,1971	ST		ANAP	AUTO	Present if image is sent to EasyVision for being printed.
Stitching	0019,1982	LT		ANAP	AUTO	
Exposure Index	0019,1989	IS		ANAP	AUTO	If media storage.
Collimator X	0019,198A	IS		ANAP	AUTO	If media storage.
Collimator Y	0019,198B	IS		ANAP	AUTO	If media storage.
Print Marker	0019,198C	LO		ANAP	AUTO	If media storage.
RGDV Name	0019,198D	LO		ANAP	AUTO	If media storage.
Acqd Sensitivity	0019,198E	LO		ANAP	AUTO	If media storage.
Processing Category	0019,198F	LO		ANAP	AUTO	If media storage and image is unprocessed (Instance Number = -1).
Unprocessed Flag	0019,1990	LO		ANAP	AUTO	Applied values: no, yes
Key Values	0019,1991	DS		ANAP	AUTO	Required if Unprocessed Flag = yes.
Destination Postprocessing Function	0019,1992	LO		ANAP	AUTO	Required if Unprocessed Flag = yes.
Version	0019,19A0	LO	0.2	ANAP	AUTO	Required if image was created with 'Unique' option switched on and Unprocessed Flag = yes.
Ranging Mode	0019,19A1	LO	AUTO2, FIXED, MANUAL, READER, SEMI	ANAP	AUTO	Required if Unprocessed Flag = yes and Version = '0.2'.
Abdomen Brightness	0019,19A2	DS		ANAP	AUTO	Required if Unprocessed Flag = yes and Version = '0.2'.
Fixed Brightness	0019,19A3	DS		ANAP	AUTO	Required if Unprocessed Flag = yes and Version = '0.2'.

Detail Contrast	0019,19A4	DS		ANAP	AUTO	Required if Unprocessed Flag = yes and Version = '0.2'.
Contrast Balance	0019,19A5	DA		ANAP	AUTO	Required if Unprocessed Flag = yes and Version = '0.2'.
Structure Boost	0019,19A6	DS		ANAP	AUTO	Required if Unprocessed Flag = yes and Version = '0.2'.
Structure Preference	0019,19A7	DS		ANAP	AUTO	Required if Unprocessed Flag = yes and Version = '0.2'.
Noise Robustness	0019,19A8	DS		ANAP	AUTO	Required if Unprocessed Flag = yes and Version = '0.2'.
Noise Dose Limit	0019,19A9	DS		ANAP	AUTO	Required if Unprocessed Flag = yes and Version = '0.2'.
Noise Dose Step	0019,19AA	DS		ANAP	AUTO	Required if Unprocessed Flag = yes and Version = '0.2'.
Noise Frequency Limit	0019,19AB	DS		ANAP	AUTO	Required if Unprocessed Flag = yes and Version = '0.2'.
Weak Contrast Limit	0019,19AC	DS		ANAP	AUTO	Required if Unprocessed Flag = yes and Version = '0.2'.
Strong Contrast Limit	0019,19AD	DS		ANAP	AUTO	Required if Unprocessed Flag = yes and Version = '0.2'.
Structure Boost Offset	0019,19AE	DS		ANAP	AUTO	Required if Unprocessed Flag = yes and Version = '0.2'.
Smooth Gain	0019,19AF	LO	NO, YES	ANAP	AUTO	Required if Unprocessed Flag = yes and Version = '0.2'.
Measure Field 1	0019,19B0	LO	FULLFIELD, HALFFIELD, QUARTERFIELD, SPLITFIELD	ANAP	AUTO	Required if Unprocessed Flag = yes and Version = '0.2'.
Measure Field 2	0019,19B1	LO	FULLFIELD, HALFFIELD, QUARTERFIELD, SPLITFIELD	ANAP	AUTO	Required if Unprocessed Flag = yes and Version = '0.2'.
Key Percentile 1	0019,19B2	IS		ANAP	AUTO	Required if Unprocessed Flag = yes and Version = '0.2'.
Key Percentile 2	0019,19B3	IS		ANAP	AUTO	Required if Unprocessed Flag = yes and Version = '0.2'.
Density LUT	0019,19B4	IS	0, 1, 2, 3, 4	ANAP	AUTO	Required if Unprocessed Flag = yes and Version = '0.2'.
Brightness	0019,19B5	DS		ANAP	AUTO	Required if Unprocessed Flag = yes.
Gamma	0019,19B6	DS		ANAP	AUTO	Required if Unprocessed Flag = yes.
Private Creator Group 0089 Block 10	0089,0010	LO	DIDI TO PCR 1.1	ALWAYS	AUTO	
Stamp Image Sequence	0089,1010	SQ		ALWAYS	AUTO	
>Samples per Pixel	0028,0002	US	1	ALWAYS	AUTO	
>Photometric Interpretation	0028,0004	CS	MONOCHROME1	ALWAYS	AUTO	
>Rows	0028,0010	US		ALWAYS	AUTO	
>Columns	0028,0011	US		ALWAYS	AUTO	
>Bits Allocated	0028,0100	US	8	ALWAYS	AUTO	
>Bits Stored	0028,0101	US	8	ALWAYS	AUTO	
>High Bit	0028,0102	US	7	ALWAYS	AUTO	
>Pixel Representation	0028,0103	US	0000	ALWAYS	AUTO	
>Pixel Data	7FE0,0010	O W		ALWAYS	AUTO	

8.1.2. Usage of Attributes from Received IOD

The DigitalDiagnost AE does not receive SOP instances. The usage of attributes received via Modality Worklist is described in section 4

8.1.3. Attribute Mapping

The following table shows the relation between BWLM and MPPS and image storage attributes.

Table 124: Attribute Mapping during Modality Workflow

Name	BWLM Tag	MPPS		Image IOD Tag
		Create Tag	Set Tag	
Accession Number	0008,0050	0008,0050	-	0008,0050
Modality	-	0008,0060	-	0008,0060
Referring Physician's Name	0008,0090	-	-	0008,0090
Operators' Name	-	-	0008,1070	0008,1070
Referenced Study Sequence	0008,1110	0008,1110	-	0008,1110
Referenced Image Sequence	-	-	(0008,1140)	-
> Referenced SOP Class UID	-	-	0008,1150	0008,0016
SOP Class UID	-	-	-	-
> Referenced SOP Instance UID	-	-	0008,1155	0008,0018
SOP Instance UID	-	-	-	-
Patient's Name	0010,0010	0010,0010	-	0010,0010
Patient ID	0010,0020	0010,0020	-	0010,0020
Issuer of Patient ID	0010,0021	0010,0021	-	0010,0021
Patient's Birth Date	0010,0030	0010,0030	-	0010,0030
Patient's Sex	0010,0040	0010,0040	-	0010,0040
Other Patient IDs	0010,1000	0010,1000	-	0010,1000
Patient's Size	0010,1020	-	-	0010,1020
Patient's Weight	0010,1030	-	-	0010,1030
Medical Alerts	0010,2000	-	-	0010,2000
Contrast Allergies	0010,2110	-	-	0010,2110
Ethnic group	0010,2160	-	-	0010,2160
Additional Patient History	0010,21B0	-	-	0010,21B0
Pregnancy Status	0010,21C0	-	-	0010,21C0
Patient Comments	0010,4000	-	-	0010,4000
KVP	-	-	0018,0060	0018,0060
Protocol Name	-	-	0018,1030	0018,1030
Exposure Time	-	-	0018,1150	0018,1150
Image Area Dose Product	-	-	(0018,115E) ¹	(0018,115E) ²
Study Instance UID	0020,000D	0020,000D	-	0020,000D
Series Instance UID	-	-	0020,000E	0020,000E
Study ID	-	0020,0010	-	0020,0010
Requesting Service	0032,1033	-	-	0032,1033
Requested Procedure Description	0032,1060	0032,1060	-	-
Requested Procedure Code Sequence ³	0032,1064	0008,1032	0008,1032	0008,1032
Performed Procedure Code Sequence	-	-	-	-
Special Needs	0038,0050	-	-	0038,0050
Patient State	0038,0500	-	-	0038,0500
Scheduled Procedure Step Description ⁴	0040,0007	0040,0007	-	0040,0007
Performed Procedure Step Description ⁵	-	0040,0254	0040,0254	0040,0254
Scheduled Protocol Code Sequence ⁴	0040,0008	0040,0260	0040,0260	0040,0008
Performed Protocol Code Sequence ⁶	-	-	-	0040,0260
Scheduled Procedure Step ID	0040,0009	0040,0009	-	0040,0009
Performed Procedure Step Start Date	-	0040,0244	-	0040,0244
Performed Procedure Step Start Time	-	0040,0245	-	0040,0245

Name	BWLM Tag	MPPS		Image IOD Tag
		Create Tag	Set Tag	
Performed Procedure Step ID	-	0040,0253	-	0040,0253
Requested Procedure ID	0040,1001	0040,1001	-	0040,1001

Note 1: Value accumulated from all acquisitions performed in this step, including rejected acquisitions.

Note 2: Image related specific value.

Note 3: If procedure is performed as requested.

Note 4: If protocol is performed as scheduled.

Note 5: If description has been mapped on an Examination.

Note 6: If Protocol Code has been mapped on an Examination.

8.1.4. Coerced/Modified fields

The user may change the attribute values of the following attributes.

Table 125: Coerced/Modified Attributes

Name	Tag	Comment
Patient Module		
Patient's Name	0010,0010	Patient's full name.
Patient ID	0010,0020	Primary hospital identification number or code for the patient.
Patient's Birth Date	0010,0030	Birth data of the patient.
Patient's Sex	0010,0040	Sex of the patient. Applied values: F, M, O
General Study Module		
Accession Number	0008,0050	A RIS generated number that identifies the order of the study.

Optionally the user may modify other patient attribute values of attributes that have been configured accessible in the Patient Data Entry GUI.

The user may also modify the scheduled acquisition protocol according to actual conditions or medical advice. In this case the Scheduled Protocol Code will differ from the Performed Protocol Code.

Note that default names and Patient ID domains for emergency patients are configurable.

8.2. Data Dictionary of Private Attributes

The DigitalDiagnost may use the following private attributes.

Table 126: Private Attributes

Name	Tag	VR	VM	Comment
Private Creator Group 0019 Block 12	0019,0012	LO	1	Private creator data element.
Private Creator Group 0019 Block 19	0019,0019	LO	1	Private creator data element.
Post Mode String	0019,1200	LT	1	-
Post Data	0019,1201	LT	1	-
Image Header	0019,1210	LT	1	-
SCPreName	0019,1220	LT	1	-
SCPostNo	0019,1221	IS	1	-
SCSOPInstanceUID	0019,1222	LT	1	-
SCCreationDate	0019,1223	LT	1	-
SCProcessingCategory	0019,1224	LT	1	-
SCPostMethod	0019,1225	LT	1	-

Name	Tag	VR	VM	Comment
SCPostString	0019,1226	LT	1	-
SCPostString2	0019,1227	LT	1	-
SCMode	0019,1228	LT	1	-
SCStCommit	0019,1229	IS	1	-
SCExported	0019,122A	IS	1	-
SCPrinted	0019,122B	IS	1	-
SCOperator	0019,122C	LT	1	-
SCPreName	0019,1240	LT	1	-
SCPreType	0019,1241	IS	1	-
PPASOPInstanceUID	0019,1242	LT	1	-
PAPrelImage1	0019,1243	LT	1	-
PA1_rotation,	0019,1244	DS	1	-
PA1_Mirrored,	0019,1245	IS	1	-
PAPrelImage2	0019,1246	LT	1	-
PA2_rotation	0019,1247	DS	1	-
PA2_Mirrored	0019,1248	IS	1	-
PAPrelImage3	0019,1249	LT	1	-
PA3_rotation	0019,124A	DS	1	-
PA3_Mirrored	0019,124B	IS	1	-
Join1x1	0019,124C	IS	1	-
Join1y1	0019,124D	IS	1	-
Join1x2	0019,124E	IS	1	-
Join1y2	0019,124F	IS	1	-
Join2x1	0019,1250	IS	1	-
Join2y1	0019,1251	IS	1	-
Join2x2	0019,1252	IS	1	-
Join2y2	0019,1253	IS	1	-
PPACreationDate	0019,1254	LT	1	-
PPAProcessingCategory	0019,1255	LT	1	-
PPAPostMethod	0019,1256	LT	1	-
PPAMode	0019,1257	LT	1	-
PPARejected	0019,1258	IS	1	-
PPARejectReason	0019,1259	LT	1	-
PPAOperator	0019,125A	LT	1	-
PPAJoinOrder	0019,125B	LT	1	-
StitchingParameters	0019,125C	LT	1	-
SCAcqData0	0019,125D	LT	1	-
SCAcqData1	0019,125E	LT	1	-
SCAcqData2	0019,125F	LT	1	-
PPASTitchingMode	0019,1260	LO	1	-
Route AET	0019,1922	LO	1	-
PCR Print Scale	0019,1923	DS	1	-
PCR Print Job End	0019,1924	ST	1	-
PCR No Film Copies	0019,1925	IS	1	-
PCR Film Layout Position	0019,1926	IS	1	-
PCR Print Report Name	0019,1927	ST	1	-
RAD Protocol Printer	0019,1970	ST	1	-
RAD Protocol Medium	0019,1971	ST	1	-
Original Filename	0019,1980	LO	1	-
Filter Type	0019,1981	SH	1	-
Stitching	0019,1982	LT	1	-
Exposure Index	0019,1989	IS	1	-
Collimator X	0019,198A	IS	1	-
Collimator Y	0019,198B	IS	1	-
Print Marker	0019,198C	LO	1	-
RGDV Name	0019,198D	LO	1	-
Acqd Sensitivity	0019,198E	LO	1	-
Processing Category	0019,198F	LO	1	-

Name	Tag	VR	VM	Comment
Unprocessed Flag	0019,1990	LO	1	-
Key Values	0019,1991	DS	2	-
Destination Postprocessing Function	0019,1992	LO	1	-
Version	0019,19A0	LO	1	-
Ranging Mode	0019,19A1	LO	1	-
Abdomen Brightness	0019,19A2	DS	1	-
Fixed Brightness	0019,19A3	DS	1	-
Detail Contrast	0019,19A4	DS	1	-
Contrast Balance	0019,19A5	DA	1	-
Structure Boost	0019,19A6	DS	1	-
Structure Preference	0019,19A7	DS	1	-
Noise Robustness	0019,19A8	DS	1	-
Noise Dose Limit	0019,19A9	DS	1	-
Noise Dose Step	0019,19AA	DS	1	-
Noise Frequency Limit	0019,19AB	DS	1	-
Weak Contrast Limit	0019,19AC	DS	1	-
Strong Contrast Limit	0019,19AD	DS	1	-
Structure Boost Offset	0019,19AE	DS	1	-
Smooth Gain	0019,19AF	LO	1	-
Measure Field 1	0019,19B0	LO	1	-
Measure Field 2	0019,19B1	LO	1	-
Key Percentile 1	0019,19B2	IS	1	-
Key Percentile 2	0019,19B3	IS	1	-
Density LUT	0019,19B4	IS	1	-
Brightness	0019,19B5	DS	1	-
Gamma	0019,19B6	DS	1	-
Private Creator Group 0089 Block 10	0089,0010	LO	1	Private creator data element.
Stamp Image Sequence	0089,1010	SQ	1	-
>Samples per Pixel	0028,0002	US	1	Number of samples (planes) in this image.
>Photometric Interpretation	0028,0004	CS	1	Specifies the intended interpretation of the pixel data.
>Rows	0028,0010	US	1	Number of rows in the image.
>Columns	0028,0011	US	1	Number of columns in the image.
>Bits Allocated	0028,0100	US	1	Number of bits allocated for each pixel sample.
>Bits Stored	0028,0101	US	1	Number of bits stored for each pixel sample.
>High Bit	0028,0102	US	1	Most significant bit for pixel sample data.
>Pixel Representation	0028,0103	US	1	Data representation of the pixel samples.
>Pixel Data	7FE0,0010	OW	1	A data stream of pixel samples that comprise the image.

8.3. Coded Terminology and Templates

The DigitalDiagnost provides tables for configuring the codes for the Modality Assisted Acquisition Protocol Setting capability. These tables allow for mapping of local examination types on RIS scheduled codes. No defaults are provided.

Local Examinations can be mapped on 1 of: a) Requested Procedure Description; b) Requested Procedure Code Item (Code Value); c) Scheduled Procedure Step Description; d) Scheduled Protocol Code Item (Code Value)

If these tables are not configured, or if the RIS sends an unknown code, or if the RIS omits the code, the user must select the appropriate Examination type from an anatomic menu manually.

Table 127: Examination Code Mapping

Requested Procedure Description	Requested Procedure Code Item	Scheduled Procedure Step Description	Scheduled Protocol Code Item	Corresponding DigitalDiagnost Examination Type
RIS defined value for 0032,1060	Item of 0032,1064 with RIS defined values for: 0008,0100 0008,0102 0008,0103 0008,0104	0040,0007	Item of 0040,0008 with RIS defined values for: 0008,0100 0008,0102 0008,0103 0008,0104	Example: 'Thorax', with routinet acquisition settings for PA and LAT, plus optional acq. settings.

8.4. Grayscale Image consistency

The DigitalDiagnost image pixel values represent optical densities on a film according to DICOM Standard PS 3.14. An image is a kind of virtual film that can be put in front of a virtual light box. The result is a range of luminescence values. These values are transformed into perceptual linear values using the whole output range as defined by the "Bits stored" parameter. These values are exported.

8.5. Standard Extended/Specialized/Private SOPs

No specialized or private SOP classes are supported.

8.5.1. Standard Extended/Specialized/Private SOP i

The Storage SOP classes are extended to create a standard extended SOP class by addition of standard and private attributes to the created SOP Instances.

8.6. Private Transfer Syntaxes

None.