DICOM

Conformance Statement

Allura Xper FD20/10 Release 1.0
Allura Xper FD20 Release 2.0



Issued by:

Philips Medical Systems Nederland B.V.
Digital Imaging Systems-CardioVascular

Building HOF-127
P.O. Box 10.000
5680 DA Best
The Netherlands

email: <mailto:dicom@philips.com>
Internet: <http://www.medical.philips.com/>

Document Number: XDB040-052532
Date: 25 November 2005

1. DICOM CONFORMANCE STATEMENT OVERVIEW

Allura Xper is an image acquisition modality. It provides the following DICOM data exchange features: (see Figure 1):

- Query the Department System Scheduler for a Modality Worklist (MWL)
- Update the Performed Procedure Step Manager with information about Performed Procedure Steps (MPPS)
- Transfer of DICOM Images to the Image Archive or Image Displays
- Transfer of requests for storage commitment to the Image Archive (for the safekeeping of the previously transmitted images) and handling the storage commitment notifications received from the Image Archive
- Query/Retrieve the Image Archive or Image Displays for a list of entries representing Series of DICOM Images
- Store DICOM Images sent from the Image Archive or Image Displays
- Print Images on DICOM Printers

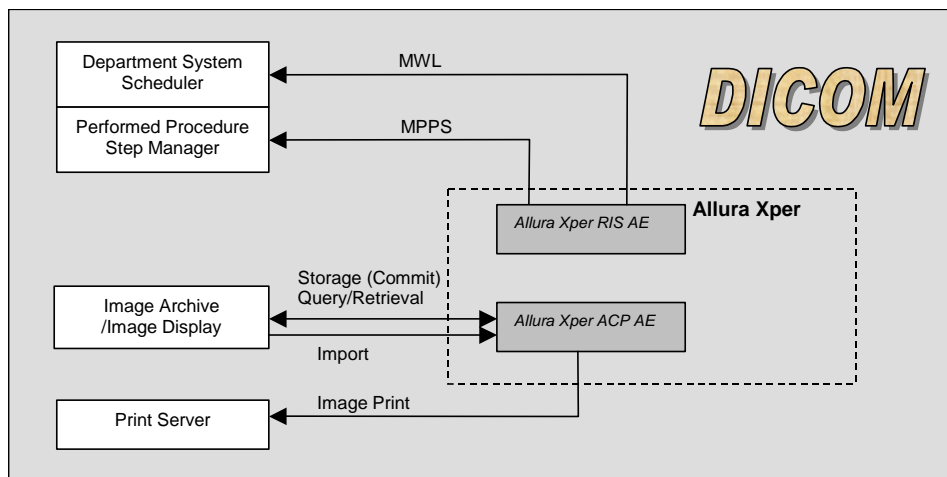

Figure 1 Data Flow of Allura Xper in a DICOM network

Table 1 presents an overview of all supported by Allura Xper networking DICOM Service (SOP) Classes with roles (User/Provider), organized in four categories:

- Transfer
- Query/Retrieve
- Workflow Management
- Print Management

Table 1: Network Services

SOP Class		User of Service (SCU)	Provider of Service (SCP)
Name	UID		
Transfer			
Secondary Capture Image Storage	1.2.840.10008.5.1.4.1.1.7	Yes	Yes
X-Ray Angiographic Image Storage	1.2.840.10008.5.1.4.1.1.12.1	Yes	Yes

SOP Class		User of Service (SCU)	Provider of Service (SCP)
Name	UID		
Query/Retrieve			
Patient Root Query/Retrieve Information Model – FIND	1.2.840.10008.5.1.4.1.2.1.1	Yes	No
Patient Root Query/Retrieve Information Model – MOVE	1.2.840.10008.5.1.4.1.2.1.2	Yes	No
Study Root Query/Retrieve Information Model – FIND	1.2.840.10008.5.1.4.1.2.2.1	Yes	No
Study Root Query/Retrieve Information Model – MOVE	1.2.840.10008.5.1.4.1.2.2.2	Yes	No
Workflow Management			
Storage Commitment Push Model	1.2.840.10008.1.20.1	Yes	No
Modality Performed Procedure Step	1.2.840.10008.3.1.2.3.3	Yes	No
Modality Worklist Information Model – FIND	1.2.840.10008.5.1.4.31	Yes	No
Print Management			
Basic Grayscale Print Management (Meta)	1.2.840.10008.5.1.1.9	Yes	No
>Basic Film Session	1.2.840.10008.5.1.1.1	Yes	No
>Basic Film Box	1.2.840.10008.5.1.1.2	Yes	No
>Basic Grayscale Image Box	1.2.840.10008.5.1.1.4	Yes	No
> Printer SOP Class	1.2.840.10008.5.1.1.16	Yes	No

2. TABLE OF CONTENTS

1.	DICOM CONFORMANCE STATEMENT OVERVIEW	3
2.	TABLE OF CONTENTS	5
3.	INTRODUCTION	7
3.1.	Revision History	7
3.2.	Audience	7
3.3.	Remarks	8
3.4.	Definitions, Terms and Abbreviations	8
3.5.	References	10
4.	NETWORKING	11
4.1.	Implementation model	11
4.1.1.	Application Data Flow	11
4.1.2.	Functional Definition of AE's	13
4.1.2.1.	Functional Definition of RIS AE	13
4.1.2.2.	Functional Definition of ACP AE	13
4.1.3.	Sequencing of Real World Activities	14
4.2.	AE Specifications	16
4.2.1.	RIS AE	16
4.2.1.1.	SOP Classes	17
4.2.1.2.	Association Policies	17
4.2.1.3.	Association Initiation Policy	18
4.2.1.4.	Association Acceptance Policy	30
4.2.2.	ACP AE	30
4.2.2.1.	SOP Classes	30
4.2.2.2.	Association Policies	31
4.2.2.3.	Association Initiation Policy	32
4.2.2.4.	Association Acceptance Policy	54
4.3.	Network Interfaces	57
4.3.1.	Physical Network Interface	57
4.3.2.	Additional Protocols	57
4.3.2.1.	Basic TLS Secure Transport Connection Profile	57
4.3.2.2.	Basic Time Synchronization Profile	57
4.3.2.3.	Basic Application Level Confidentiality Profile	57
4.4.	Configuration	57
4.4.1.	AE Title/Presentation Address Mapping	58
4.4.1.1.	Local AE Titles	58
4.4.1.2.	Remote AE Title/Presentation Address Mapping	58
4.4.2.	Parameters	58
5.	MEDIA INTERCHANGE	60
6.	SUPPORT OF CHARACTER SETS	61
7.	SECURITY	62
7.1.	Association Level Security	62
7.2.	Application Level Security	62
7.2.1.	DICOM Basic TLS Secure Transport Connection Profile	62
7.2.2.	Generation of Audit Records	64
7.2.3.	Basic Application Level Confidentiality Profile	64
8.	ANNEXES	66
8.1.	IOD Contents	66
8.1.1.	Created SOP Instances	66
8.1.1.1.	Secondary Capture Image Storage SOP Class - C-STORE-RQ	66
8.1.1.2.	X-Ray Angiographic Image Storage SOP Class – C-STORE RQ	70
8.1.2.	Usage of Attributes from Received IOD's	78
8.1.3.	Attribute Mapping	78
8.1.4.	Coerced/Modified fields	79

8.2.	Data Dictionary of Private Attributes	79
8.3.	Coded Terminology and Templates	79
8.4.	Grayscale Image consistency	79
8.5.	Standard Extended/Specialized/Private SOPs	79
8.6.	Private Transfer Syntaxes	80

3. INTRODUCTION

3.1. Revision History

The revision history provides dates and differences of the different releases.

Table 2: Revision History

Document Version	Date of Issue	Author	Description
00	27 August 2004	PMS DIS-C/V	New version of conformance for Allura Xper
01	8 October 2004	PMS DIS-C/V	Rework after the review XDB044-042885
02	7 December 2004	PMS DIS-C/V	IHE requirements: <ul style="list-style-type: none"> For local examinations, MPPS N-CREATE message should be sent right after the selection for acquisition (XPER00007525) Performed protocol code sequence should be filled in MPPS (XPER00004858) Scheduled protocol code sequence needed in image IOD (XPER00007932) Scheduled Procedure Step Description (XPER00007926)
03	5 April 2005	PMS DIS-C/V	Added import limitations to Conformance Statement (XPER00003810) Added Application Entity parameter Network Reply time out (XPER00013404) Rewritten Description and Sequencing of Activities for MPPS (XPER00014248)
04	13 May 2005	PMS DIS-C/V	Update the document according to Philips template (XPER00013409)
05	13 May 2005	PMS DIS-C/V	Add semantics/corectness to Curve Module (XPER00017264)
06	10 June 2005	PMS DIS-C/V	Support of Basic Application Level Confidentiality Profile and Basic Time Synchronization Profile (XPER00019369)
07	16 June 2005	PMS DIS-C/V	Update of C-STORE Response Status Handling Update of N-CREATE Response Status Handling Update of N-SET Response Status Handling
08	11 July 2005	PMS DIS-C/V	Performed Action Item Code Sequence not part of the image IOD (XPER00023161)
09	8 August 2005	PMS DIS-C/V	Modality Lut module added (XPER00023766)
10	12 August 2005	PMS DIS-C/V	Attributes extended with VR (XPER00000305)
11	22 August 2005	PMS DIS-C/V	Image type not correct for subtracted images (XPER00023512)
12	3 October 2005	PMS DIS-C/V	Derivation Description not complete (XPER00027338)
13	25 November 2005	PMS DIS-C/V	IP address and Port number not configurable for RIS AE (Local System) (XPER00036767)

3.2. Audience

This Conformance Statement is intended for:

- (potential) customers
- system integrators of medical equipment

- marketing staff interested in system functionality
- software designers implementing DICOM interfaces

It is assumed that the reader is familiar with the DICOM standard.

3.3. Remarks

The DICOM Conformance Statement is contained in chapter 4 through 8 and follows the contents and structuring requirements of [DICOM] PS 3.2.

This DICOM Conformance Statement by itself does not guarantee successful interoperability of Philips equipment with non-Philips equipment. The user (or user's agent) should be aware of the following issues:

- **Interoperability**
Interoperability refers to the ability of application functions, distributed over two or more systems, to work successfully together. The integration of medical devices into an IT environment may require application functions that are not specified within the scope of DICOM. Consequently, using only the information provided by this Conformance Statement does not guarantee interoperability of Philips equipment with non-Philips equipment. It is the user's responsibility to analyze thoroughly the application requirements and to specify a solution that integrates Philips equipment with non-Philips equipment.
- **Validation**
Philips equipment has been carefully tested to assure that the actual implementation of the DICOM interface corresponds with this Conformance Statement. Where Philips equipment is linked to non-Philips equipment, the first step is to compare the relevant Conformance Statements. If the Conformance Statements indicate that successful information exchange should be possible, additional validation tests will be necessary to ensure the functionality, performance, accuracy and stability of image and image related data. It is the responsibility of the user (or user's agent) to specify the appropriate test suite and to carry out the additional validation tests.
- **New versions of the DICOM Standard**
The DICOM Standard will evolve in future to meet the user's growing requirements and to incorporate new features and technologies. Philips is actively involved in this evolution and plans to adapt its equipment to future versions of the DICOM Standard. In order to do so, Philips reserves the right to make changes to its products or to discontinue its delivery.
The user should ensure that any non-Philips provider linking to Philips equipment also adapts to future versions of the DICOM Standard. If not, the incorporation of DICOM enhancements into Philips equipment may lead to loss of connectivity (in case of networking) and incompatibility (in case of media).

3.4. Definitions, Terms and Abbreviations

DICOM definitions, terms and abbreviations are used throughout this Conformance Statement. For a description of these, see [DICOM] PS 3.3 and PS 3.4.

The word Philips in this document refers to Philips Medical Systems.

The following acronyms are used in this document.

ACN	Application Context Name
ACP	Archiving/Connectivity and Print
AE	Application Entity
AP	Application Profile
BSD	Berkeley Software Distribution
BWLM	Basic Worklist Management
CRL	Certificate Revocation List
DICOM	Digital Imaging and Communications in Medicine
DIMSE	DICOM Message Service Element
CN	Common Name
EBE	DICOM Explicit VR Big Endian
ELE	DICOM Explicit VR Little Endian
IHE	Integrating the Healthcare Enterprise
ISO	International Organization for Standardization
JPEG	Joint Photographic Experts Group
ILE	DICOM Implicit VR Little Endian
IOD	Information Object Definition
LDAP	Lightweight Directory Access Protocol
MWL	Modality Worklist Management
MPPS	Modality Performed Procedure Step
NEMA	National Electrical Manufacturers Association
NTP	Network Time Protocol
N.A.	Not Applicable
PDU	Protocol Data Unit
PHI	Protected Health Information
RIS	Radiology Information System
RWA	Real-World Activity
SC	Secondary Capture
SCP	Service Class Provider
SCU	Service Class User
SOP	Service Object Pair
TCP/IP	Transmission Control Protocol/Internet Protocol
TLS	Transport Layer Security
UID	Unique Identifier
XA	X-Ray Angiographic
xxx	Any status code
*	Any

The following terms are used in this document.

Audit Record Repository

A system unit that receives and collects audit records from multiple systems [IHE].

Image Archive

A system that provides long term storage of images, presentation states, Key Image Notes and Evidence Documents [IHE].

Image Display

A system that offers browsing of patients' studies. In addition, it may support the retrieval and display of selected sets of images, presentation states, Key Image Notes, and Evidence Documents [IHE].

Department System Scheduler

A department-based information system that provides functions related to the management of orders received from external systems or through the department system's user interface. Upon a defined workflow action, makes procedures available for charge posting. The actor defines the action/event that actually causes charges to post [IHE].

Performed Procedure Step Manager

A system that re-distribute the Modality Performed Procedure Step Information from the Acquisition Modality or image Creator to the Department System Scheduler/Order Filler and Image Manager [IHE].

Print Server

A system that accepts and processes DICOM print requests as a DICOM Print SCP and performs image rendering on hardcopy media. The system must support pixel rendering according to the DICOM Grayscale Standard Display Function [IHE].

Protected Health Information

Protected Health Information is considered as information records, and not the flow of information between the systems [IHE].

Time Server

A system unit that knows, maintains and distributes the correct time in the enterprise [IHE].

3.5. References

- [DICOM] Digital Imaging and Communications in Medicine (DICOM), Part 1 – 18 (NEMA PS 3.1-XXXX – PS 3.18- XXXX), National Electrical Manufacturers Association (NEMA) Publication Sales 1300 N. 17th Street, Suite 1847 Rosslyn, Virginia. 22209, United States of America
- [IHE] Integrating the Healthcare Enterprise
(IHE) Cardiology Technical Framework Year 2004-2005:
Radiological Society of North America (RSNA), Inc.
820 Jorie Boulevard, Oak Brook, IL, United States of America
- [NTP] RFC 1305: Network Time Protocol Version 3.
- [SYSLOG] RFC 3164: The BSD Syslog Protocol.
- [TLS] RFC 2246: Transport Layer Security protocol (TLS) v1.0.

4. NETWORKING

This section contains the networking related services.

4.1. Implementation model

The implementation model consists of three sections:

- the application data flow diagram, specifying the relationship between the Allura Xper Application Entities and the “external world” or Real-World Activities
- a functional description of each Application Entity
- sequencing constraints among the Application Entities

4.1.1. Application Data Flow

Allura Xper has two Application Entities in its implementation, namely RIS Application Entity (RIS AE) and ACP AE Application Entity (ACP AE). Figure 2 shows the Networking application data flow as a functional overview of these application entities. On the left-hand side, the local Real-World Activities are presented, whereas on the right-hand side, the remote Real-World Activities are presented.

As depicted in Figure 2, the RIS AE and ACP AE incorporate the following functionality:

- After RWA Request Modality Worklist, the RIS AE as SCU uses the remote Modality Worklist Information Model SCP functionality to query for Modality Worklist.
- After RWA Create and Set Modality Performed Procedure Step, the RIS AE as SCU uses the remote Modality Performed Procedure Step SOP Class functionality to Report Modality Performed Procedure Step.
- After RWA Verify Application Level Communication (in the service mode), the RIS AE as SCU uses the remote Request Verification SCP functionality to verify communication.
- After RWA Transfer Images, the ACP AE as SCU uses the remote SCP Storage Service Class functionality to store local images in a remote database.
- After RWA Import Images, the ACP AE as SCP provides standard Storage Service Class functionality to the requesting SCU.
- After RWA Find Remote Images, the ACP AE as SCU uses the remote SCP Query/Retrieve Service Class functionality to query for remote Series of Images.
- After RWA Move Remote Images, the ACP AE as SCU uses the remote SCP Query/Retrieve Service Class functionality to import remote Series of Images.
- After RWA Request Storage Commitment, the ACP AE as SCU uses the remote SCP Storage Commitment Service Class functionality to commit remote images.
- After RWA Print Images, the ACP AE as SCU uses the remote Print Management Service Class to request the remote printer status and to print local images on that printer.

- After RWA Get Printer Status (in the service mode), the ACP AE as SCU uses the remote Print Management Service Class to request the remote printer status.
- After RWA Verify Application Level Communication, the ACP AE as SCU uses the remote Request Verification SCP functionality to verify communication.
- After RWA Request Verification (in the service mode), the ACP AE as SCP provides standard Verification Service Class functionality to the requesting SCU.

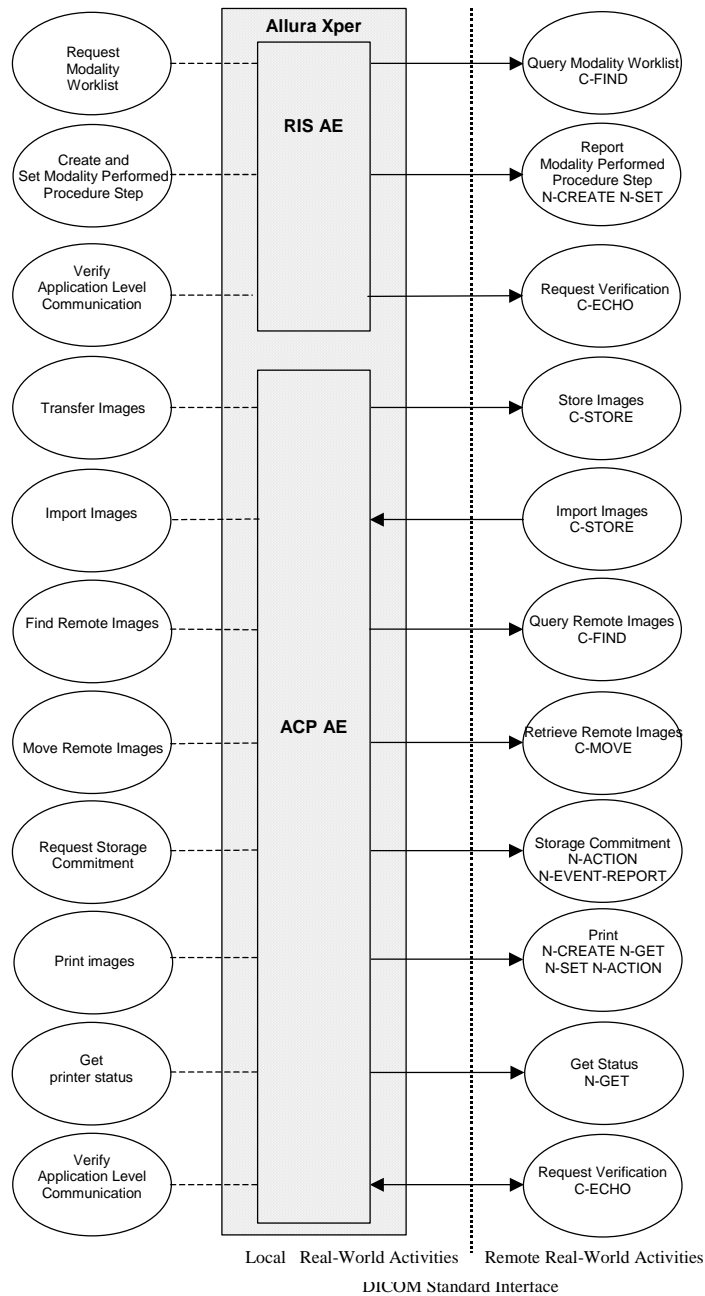

As documented in the PS 3.4, the arrows in the diagram have the following meanings:
 - An arrow pointing to the right indicates the local application entity initiates an association.
 - An arrow pointing to the left indicates the local application entity accepts an association.

Figure 2 Allura Xper application data flow diagram

© Koninklijke Philips Electronics N.V. 2005
 Allura Xper FD20

4.1.2. Functional Definition of AE's

This section describes in general terms the functions performed by RIS AE and ACP AE.

4.1.2.1. Functional Definition of RIS AE

4.1.2.1.1. Basic Worklist Management Service Class

The RIS AE can perform (only to the pre-configured Department System Scheduler) the Basic Worklist Management service as SCU (RWA Request Modality Worklist), triggered by the operator. The RIS AE shall request an association. When the association is accepted, the RIS AE shall send the Worklist request, receive the Worklist responses, and request for releasing the association.

4.1.2.1.2. Study Management Service Class

The RIS AE can perform (only to the pre-configured Performed Procedure Step Manager) the Study Management service as SCU (RWA Create and Set Modality Performed Procedure Step), triggered by the selection of an examination for acquisition or closing or deletion of an examination. The RIS AE shall request an association. When the association is accepted, the RIS AE shall send the create and set requests, receive the responses, and request for releasing the association.

4.1.2.1.3. Verification Service Class

The RIS AE can perform (only to pre-configured systems) the Verification service as SCU (triggered by the operator in the service mode). The RIS AE shall request an association. When the association is accepted, the RIS AE shall send the Verification request, receive the Verification response, and request for releasing the association.

4.1.2.2. Functional Definition of ACP AE

4.1.2.2.1. Storage Service Class

The ACP AE accepts (only from pre-configured systems) associations from systems that wish to store images using the C-STORE command (RWA Import Images). A remote SCU shall request an association with the ACP AE for Storage SOP class. After accepting the association, the ACP AE shall receive and respond to the Storage requests, and release the association when requested.

The ACP AE can perform (only to pre-configured systems) the Storage service as SCU (RWA Transfer Images), triggered by the operator or by an event in the system, e.g. closing of an examination, acquisition of images). The ACP AE shall request an association with the selected remote SCP for all applicable Storage SOP classes. When the association is accepted, the ACP AE shall send the Storage requests (including data from local database), receive the Storage responses and act accordingly, and finally request for releasing the association.

4.1.2.2.2. Query/Retrieve Service Class

The ACP AE can perform (only to pre-configured systems) the Query/Retrieve service as SCU (RWA Find Remote Images and Move Remote Images), triggered by the operator. The ACP AE shall request an association with the selected remote SCP for the applicable Query/Retrieve SOP class. When the association is accepted, the ACP AE shall send the Query/Retrieve requests, receive the Query/Retrieve responses and act accordingly, and finally request for releasing the association.

The ACP AE fully supports the Cancel functionality.

Limitations: For Import jobs only C-MOVE-RQ's are done for Series with Images (not for Series with Grayscale Softcopy Presentation States objects). As a result, Softcopy Presentation States object created on the remote side are not imported.

4.1.2.2.3. Storage Commitment Service Class

The ACP AE can perform (only to the Image Archive) the Storage Commitment service as SCU (RWA Request Storage Commitment), triggered by the closing of an examination event in the Allura Xper. The ACP AE shall request an association with the Image Archive SCP for the Storage Commitment Push Model SOP class. When the association is accepted, the ACP AE shall send the Storage Commitment request, receive the Storage Commitment request responses and act accordingly. The ACP AE shall wait for a synchronous report for a specified amount of time and after that, it shall request for releasing the association. As a result, the Storage Commit SCP must then request a new association to confirm the storage commit asynchronously. After accepting that association, the ACP AE shall receive the Storage Commitment reports, and release the association when requested.

4.1.2.2.4. Print Management Service Class

The ACP AE can perform the Print service as SCU (RWA Print Images), triggered by the operator. For each printed sheet, the ACP AE shall request an association with the selected remote SCP (i.e., a Print Server) for all applicable SOP classes of the applicable Print Management Meta SOP class. When the association is accepted, the ACP AE shall send the Print requests including data from local database (the N-GET-RQ message to get the printer status, the N-CREATE-RQ message to create the FilmSession and the FilmBox, the N-SET-RQ message to set the Image Box on the printer, finally, the N-ACTION-RQ message to give printer the command to print), receive the Print responses and act accordingly, and finally request for releasing the association.

The ACP AE can perform the Print service as SCU (RWA Get Printer Status), triggered by the operator in the service mode. The ACP AE shall request an association with the selected remote SCP (Print Server) for the Printer SOP class. When the association is accepted, the ACP AE shall send the N-Get request, receive the responses from the Print Server and act accordingly, and finally request for releasing the association.

4.1.2.2.5. Verification Service Class

The ACP AE accepts (only from pre-configured systems) associations from systems that wish to verify application level communication using the C-ECHO command (RWA Request Verification). A remote SCU shall request an association with the ACP AE for Verification SOP class. After accepting the association, the ACP AE shall receive and respond to the Verification request, and release the association when requested.

The ACP AE can perform (only to pre-configured systems) the Verification service as SCU (triggered by the operator in the service mode). The ACP AE shall request an association. When the association is accepted, the ACP AE shall send the Verification request, receive the Verification response, and request for releasing the association.

4.1.3. Sequencing of Real World Activities

The following sequence of Real World activities are supported by the Allura Xper:

- The clinical user queries the Department System Scheduler for a (specific) Worklist representing the list of Scheduled Procedure Steps (with

demographic information). Based on that query entered at the Allura Xper, it sends the BWLM C-FIND-RQ message with the query criteria.

- The clinical user starts the examination. As a result, the Allura Xper notifies the Performed Procedure Step Manager of the start of a new Procedure Step, i.e. it sends the MPPS N-CREATE-RQ message with the "IN PROCESS" status of the examination.
- The clinical user acquires images with a certain procedure. As a result, if background image transfer is configured, the Allura Xper sends automatically the acquired images to the Image Archive and/or the Image Display, i.e., it sends the C-STORE-RQ messages containing the image information.
- The clinical user completes the examination. As a result, if auto-transfer is configured, the Allura Xper sends images to the Image Archive and/or Image Display (background image transfer), i.e., it sends the C-STORE-RQ messages containing the image information.
- When all images, which were to be automatically transferred to the Image Archive, have been transferred and if Image Archive supports storage-commit, the Allura Xper asks the Image Archive to take responsibility for the images that it has stored that originate from the examination, i.e., it sends the N-ACTION-RQ message containing the request for storage commit.
- The Allura Xper notifies the Performed Procedure Step Manager of the completion of a Procedure Step, i.e., it sends the N-SET-RQ message with the "COMPLETED" status of the examination.

Additionally to the basic flow of activities, the clinical user may also perform the following steps:

- The clinical user manually transfers images to the Image Archive and/or Image Display. As a result, the Allura Xper sends the C-STORE-RQ messages containing the image information.
- The clinical user manually prints selected images. As a result, the Allura Xper sends the N-GET-RQ message to get the printer status, the N-CREATE-RQ message to create the FilmSession and the FilmBox, the N-SET-RQ message to set the Image Box on the printer. Finally, it sends the N-ACTION-RQ message to give printer the command to print.
- The clinical user queries the Image Archive or Image Display for Series entities. As a result, the Allura Xper sends a number of C-FIND-RQ messages containing the query criteria. The results received from the Image Archive or Image Display (i.e., Series entities) are presented to the clinical user as a list of entries, where each entry represents a set of Series entities with the same Study Instance UID (0020,000D), Protocol Name (0018,1030), and Performing Physician's Name (0008,1050).
- The clinical user asks for the retrieval of one entry from the Image Archive or Image Display. As a result, the Allura Xper sends the C-MOVE-RQ messages containing the identification of the Series of images to be imported.
- The clinical user may delete an examination. As a result, if it is a Worklist examination, an association is established for transmitting an N-SET request with the "DISCONTINUED" status.

Figure 3 presents normal scheduled workflow. Other workflow situations (e.g., unscheduled procedure steps) will have other sequencing constraints. For example, printing could equally take place after the acquired images have been stored or after the examination have been closed or could be omitted completely. Query for images could take place before images have been acquired or could be omitted completely.

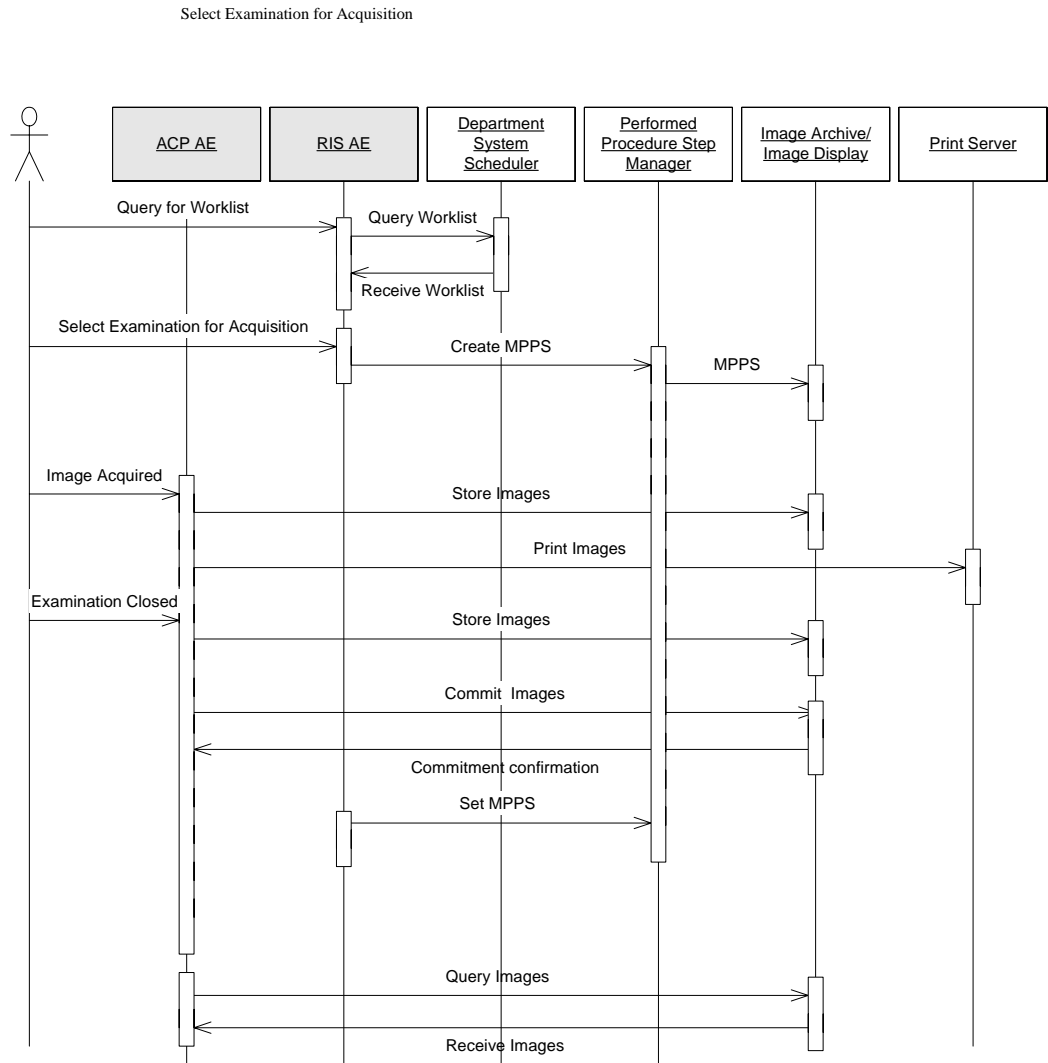

Figure 3 Allura Xper Sequencing constraints

4.2. AE Specifications

The next section contains entity specifications for each application entity.

4.2.1. RIS AE

Every detail of the RIS AE shall be completely specified under this section.

4.2.1.1. SOP Classes

The RIS AE provides Standard Conformance to the SOP Classes presented in Table 3.

Table 3: SOP Classes for RIS AE

SOP Class Name	SOP Class UID	SCU	SCP
Modality Worklist Information Model – FIND	1.2.840.10008.5.1.4.31	Yes	No
Modality Performed Procedure Step	1.2.840.10008.3.1.2.3.3	Yes	No
Verification	1.2.840.10008.1.1	Yes	No

Note: Any SOP specific behavior is documented later in the conformance statement in the applicable SOP specific conformance section.

4.2.1.2. Association Policies

This section contains a description of the general association establishment and acceptance policies of the RIS AE.

4.2.1.2.1. General

The RIS AE always proposes the DICOM Application Context Name (ACN) presented in Table 4. The maximum PDU length for receiving data can be configured. The minimum PDU size is 4 Kbytes (4kB) and the maximum PDU length is 2¹⁵ Bytes. The PDU length for sending data is unrestricted.

Table 4: DICOM Application Context

Application Context Name	1.2.840.10008.3.1.1.1
--------------------------	-----------------------

4.2.1.2.2. Number of Associations

The RIS AE supports a maximum of two simultaneous associations as SCU. The associations can be either for the execution of Modality Worklist query, or for the execution of Modality Performed Procedure Step (MPPS), or for the execution of Verification of Application Level Communication.

The RIS AE does not handle incoming associations.

Table 5: Number of Associations as an Association Initiator for RIS AE

Maximum number of simultaneous associations	2
---	---

Table 6: Number of Associations as an Association Acceptor for RIS AE

Maximum number of simultaneous associations	N.A.
---	------

4.2.1.2.3. Asynchronous Nature

The RIS AE does not support asynchronous operations and will not perform asynchronous window negotiation.

Table 7: Asynchronous Nature as an Association Initiator for RIS AE

Maximum number of outstanding asynchronous transactions	N.A.
---	------

4.2.1.2.4. Implementation Identifying Information

The value supplied for Implementation Class UID is presented in Table 8.

Table 8: DICOM Implementation Class and Version for RIS AE

Implementation Class UID	1.3.46.670589.7.28.4.1.0
Implementation Version Name	AlluraXper40RIS

4.2.1.3. Association Initiation Policy

The RIS AE initiates associations as a result of the following events:

- The operator queries for the Worklist (see Section 4.2.1.3.1)
- The operator selects a Worklist-based examination for acquisition (see Section 4.2.1.3.2)
- The operator cancels, removes or closes an examination (see Section 4.2.1.3.2)
- In the service mode, the operator verifies application level communication (see Section 4.2.1.3.3).

4.2.1.3.1. Request Modality Worklist

4.2.1.3.1.1. Description and Sequencing of Activities

For each Broad or Specific Worklist request, the RIS AE opens an association towards the Basic Worklist Management SCP and sends a C-FIND request. After retrieval of all responses containing matching Worklist items, the association is closed (see Figure 4). All returned Worklist items are displayed to the operator who can select an item from the Worklist and perform an examination.

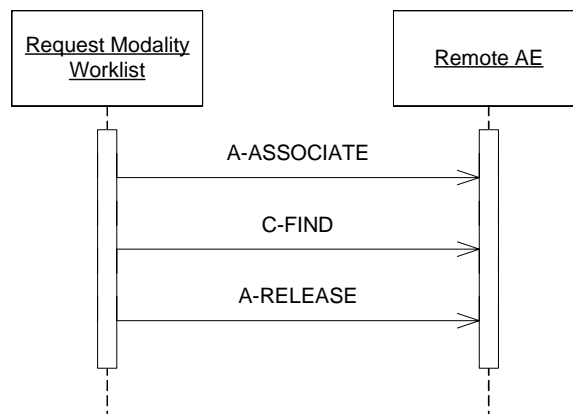
**Figure 4 Sequencing of RWA Request Modality Worklist**

The clinical user may cancel the query to the Department System Scheduler. As a result, the Allura Xper sends a C-FIND Cancel Request to the Department System Scheduler.

4.2.1.3.1.2. Proposed Presentation Contexts

Each time an association is initiated, the RIS AE proposes one presentation contexts to be used on that association. The presentation context proposed by the RIS AE for Request Modality Worklist is defined in Table 9.

Table 9: Proposed Presentation Contexts for RIS AE Request Modality Worklist

Presentation Context Table					
Abstract Syntax		Transfer Syntax		Role	Extended Negotiation
Name	UID	Name List	UID List		
Modality Worklist Information Model – FIND	1.2.840.10008.5.1.4.31	ILE ELE EBE	1.2.840.10008.1.2 1.2.840.10008.1.2.1 1.2.840.10008.1.2.2	SCU	None

The implementation chooses ELE transfer syntax in case multiple transfer syntaxes are accepted in the association acceptance.

4.2.1.3.1.3. SOP Specific Conformance for SOP Classes

Two kinds of queries can be done with the RIS AE: a broad query and a specific query.

A broad query for the Worklist is initiated by the operator without filling in any search criteria (the search criteria are based on system configuration). The Matching Keys are presented in Table 10.

A specific Worklist request is initiated by the operator after filling in search criteria in the Graphical User Interface. At least one key should be specified. No verification of query results in relation to the original query criteria is done. The Matching Keys are presented in Table 11.

A received Worklist entry is validated. The entry will be discarded, and an error will be reported when a type-one or type-two attribute is missing, or when the translation of a type-one attribute fails (this includes individual attributes within a sub-sequence).

Attributes shown in the C-FIND response are configurable.

Table 10 Matching Table MWL Information Model – Broad Query

Attribute Name	Tag	Matching Key
Scheduled Station AE Title	(0040,0001)	Single value matching
Scheduled Procedure Step Start Date	(0040,0002)	Universal matching or range matching
Scheduled Procedure Step Start Time	(0040,0003)	Universal matching or range matching
Modality	(0008,0060)	Fixed value matching (always "XA")

Table 11 Matching Table MWL Information Model – Specific Query

Attribute Name	Tag	Matching Key
Scheduled Station AE Title	(0040,0001)	Universal matching or single value matching
Scheduled Procedure Step Start Date	(0040,0002)	Universal matching or range matching
Modality	(0008,0060)	Universal matching or single value matching
Patient's Name	(0010,0010)	Universal matching or single value matching or wild card matching
Patient ID	(0010,0020)	Universal matching or single value matching
Accession Number	(0008,0050)	Universal matching or single value matching
Requested Procedure ID	(0040,1001)	Universal matching or single value matching

Worklist request identifier of the RIS AE queries is presented in Table 12 up till Table 20.

Table 12: Worklist request identifier: Patient Identification Module

Attribute Name	Tag	VR	Note
Patient's Name	0010,0010	PN	
Patient ID	0010,0020	LO	
Other Patient IDs	0010,1000	LO	

Table 13: Worklist request identifier: Patient Demographic Module

Attribute Name	Tag	VR	Note
Patient's Birth Date	0010,0030	DA	
Patient's Birth Time	0010,0032	TM	
Patient's Sex	0010,0040	CS	Applied Value(s): F, M, O
Patient's Size ¹	0010,1020	DS	
Patient's Weight	0010,1030	DS	
Ethnic Group	0010,2160	SH	
Patient Comments	0010,4000	LT	
Patient Data Confidentiality Constraint Description	0040,3001	LO	

Table 14: Worklist request identifier: Patient Medical Module

Attribute Name	Tag	VR	Note
Medical Alerts	0010,2000	LO	
Contrast Allergies	0010,2110	LO	
Additional Patient History	0010,21B0	LT	
Pregnancy Status	0010,21C0	US	Applied Value(s): 0001, 0002, 0003, 0004
Patient State	0038,0500	LO	

Table 15: Worklist request identifier: Visit Relationship Module

Attribute Name	Tag	VR	Note
Referenced Patient Sequence	0008,1120	SQ	
>Referenced SOP Class UID	0008,1150	UI	
>Referenced SOP Instance UID	0008,1155	UI	

Table 16: Worklist request identifier: Visit Status Module

Attribute Name	Tag	VR	Note
Current Patient Location	0038,0300	LO	

Table 17: Worklist request identifier: Scheduled Procedure Step Module

Attribute Name	Tag	VR	Note
Scheduled Procedure Step Sequence	0040,0100	SQ	
>Modality	0008,0060	CS	
>Requested Contrast Agent	0032,1070	LO	
>Scheduled Station AE Title	0040,0001	AE	
>Scheduled Procedure Step Start Date	0040,0002	DA	
>Scheduled Procedure Step Start Time	0040,0003	TM	
>Scheduled Performing Physician's Name	0040,0006	PN	
>Scheduled Procedure Step Description	0040,0007	LO	

¹ When received from the RIS, values for Patient's Size and Patient Weight can be modified. All other attributes received from the RIS cannot be modified.

Attribute Name	Tag	VR	Note
>Scheduled Protocol Code Sequence	0040,0008	SQ	
>>Code Value	0008,0100	SH	
>>Coding Scheme Designator	0008,0102	SH	
>>Code Meaning	0008,0104	LO	
>Scheduled Procedure Step ID	0040,0009	SH	
>Scheduled Procedure Step Location	0040,0011	SH	
>Pre-Medication	0040,0012	LO	

Table 18: Worklist request identifier: Requested Procedure Module

Attribute Name	Tag	VR	Note
Referenced Study Sequence	0008,1110	SQ	
>Referenced SOP Class UID	0008,1150	UI	
>Referenced SOP Instance UID	0008,1155	UI	
Study Instance UID	0020,000D	UI	
Requested Procedure Description	0032,1060	LO	
Requested Procedure Code Sequence	0032,1064	SQ	
>Code Value	0008,0100	SH	
>Coding Scheme Designator	0008,0102	SH	
>Code Meaning	0008,0104	LO	
Requested Procedure ID	0040,1001	SH	
Reason for the Requested Procedure	0040,1002	LO	
Requested Procedure Priority	0040,1003	SH	
Patient Transport Arrangements	0040,1004	LO	
Requested Procedure Location	0040,1005	LO	
Names of Intended Recipients of Results	0040,1010	PN	
Requested Procedure Comments	0040,1400	LT	

Table 19: Worklist request identifier: Imaging Service Request Module

Attribute Name	Tag	VR	Note
Accession Number	0008,0050	SH	
Referring Physician's Name	0008,0090	PN	
Requesting Physician	0032,1032	PN	
Requesting Service	0032,1033	LO	
Reason for the Imaging Service Request	0040,2001	LT	
Issue Date of Imaging Service Request	0040,2004	DA	
Issue Time of Imaging Service Request	0040,2005	TM	
Imaging Service Request Comments	0040,2400	LT	

Table 20: Worklist request identifier: SOP Common Module

Attribute Name	Tag	VR	Note
Specific Character Set	0008,0005	CS	ISO_IR 100, ISO_IR 13, ISO_IR 14, ISO_IR 87 or ISO_IR 159

The behavior of the RIS AE for status codes in a Modality Worklist C-FIND response is presented in Table 21.

Table 21: Modality Worklist C-FIND Response Status Handling Behavior

Service Status	Error Code	Further Meaning	Behavior
Success	0000	Matching is complete - No final Identifier is supplied.	The result is reported to the user and is logged.
Refused	A700	Out of Resources	Stops with processing the C-Find Response(s) from the SCP. The reason is logged and the failure is reported to the user.
Failed	A900	Identifier Does Not Match SOP Class	Stops with processing the C-Find Response(s) from the SCP. The reason is logged and the failure is reported to the user. The responses received before the failure are displayed to the user.
	C001	Unable to process	Stops with processing the C-Find Response(s) from the SCP. The reason is logged and the failure is reported to the user. The responses received before the failure are displayed to the user.
Cancel	FE00	Matching terminated due to Cancel Match request	Stops with processing the C-Find Response(s) from the SCP. The responses received before the cancel are displayed to the user.
Pending	FF00	Matches are continuing - Current Match is supported in the same manner as supplied and any Optional Keys were Required Keys.	Continues with processing of the C-Find Response(s) from the SCP
	FF01	Matches are continuing - Warning that one or more Optional Keys were not supported for existence for this Identifier.	Continues with processing of the C-Find Response(s) from the SCP.
*	Any other status code	*	The association is aborted using A-ABORT. The reason is logged and the failure is reported to the user. The responses received earlier are displayed to the user.

The behavior of the RIS AE during communication failure is presented in Table 22.

Table 22: Modality Worklist Communication Failure Behavior

Exception	Behavior
Timeout	The query is marked as failed. The association is aborted using A-ABORT. The reason is logged and reported to the user. The RIS AE stops processing the C-FIND Response(s) from the SCP.
Association aborted	If the association is aborted using A-ABORT, the query is marked as failed. The reason is logged and failure is reported to the user. Stops with processing the C-FIND Response(s) from the SCP.
Association rejected	The query is marked as failed. The reason is logged and failure is reported to the user. No C-FIND request performed.

4.2.1.3.2. Create and Set Modality Performed Procedure Step

4.2.1.3.2.1. Description and Sequencing of Activities

For each MPPS Job, a new association towards the modality Performed Procedure Step is established and closed when the MPPS Job has been transmitted. There are three kinds of MPPS Jobs:

- MPPS Create Job. Only a N-CREATE request with status “IN PROGRESS” is transmitted. Once the response is received, the association is closed. The MPPS Create Job is submitted when:
 - A Worklist examination is selected for acquisition;
 - A local examination is selected for acquisition and the system is configured to be connected to an IHE compatible RIS.
- MPPS Set Job. Only a N-SET request is transmitted. The status field will respectively be set to “DISCONTINUED” or “COMPLETED”. Once the response is received, the association is closed. The MPPS Set Job is submitted when:
 - An examination is discontinued/deleted/restored to solve patient mixing or closed and the MPPS Create Job is already handled (transmitted).
- MPPS Create & Set Job. Over the same association both the N-CREATE request and the N-SET request corresponding to the same examination are transmitted. The MPPS Create & Set Job is submitted when:
 - A local examination is discontinued/deleted/restored to solve patient mixing or closed and the system is configured to be connected to a non-IHE compatible RIS.
 - An examination is discontinued/deleted/restored to solve patient mixing or closed and the MPPS Create Job is not already handled (not transmitted). In such case the MPPS Create & Set Job replaces the MPPS Create Job.

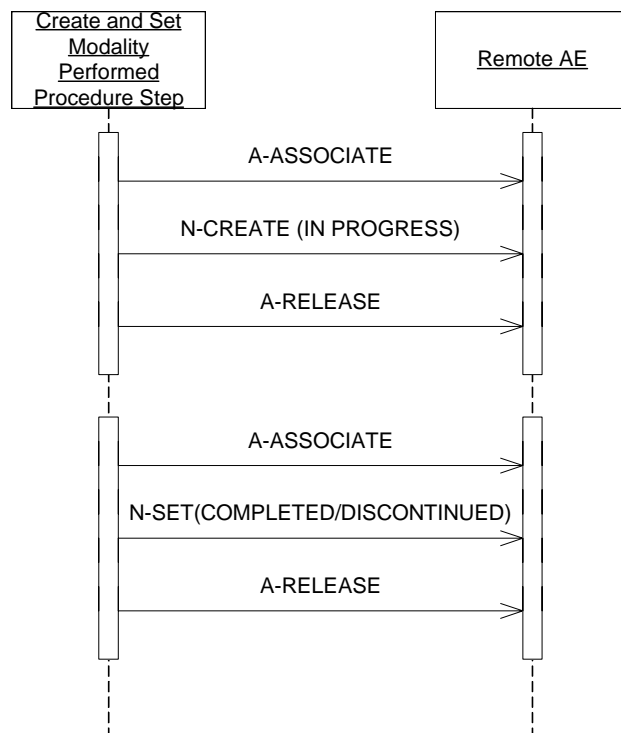

Figure 5 Sequencing of RWA separate MPPS Create and separate MPPS Set Job (e.g. for a Worklist examination)

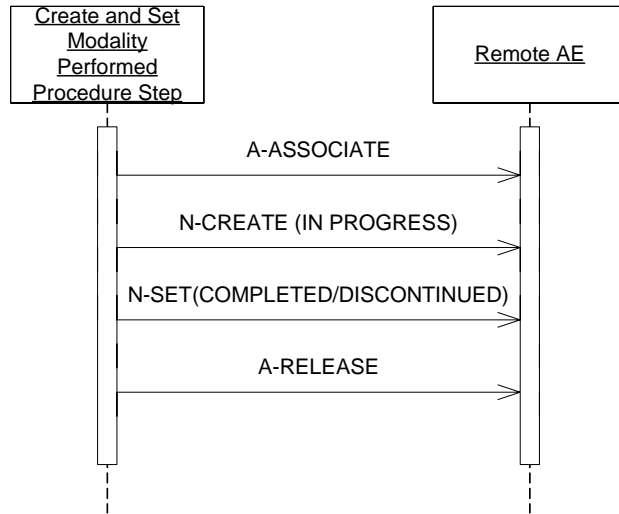

Figure 6 Sequencing of RWA MPPS Create and Set Job (e.g. if configured, for a local examination)

4.2.1.3.2.2. Proposed Presentation Contexts

Each time an association is initiated, the RIS AE proposes one presentation context to be used on that association. The presentation context proposed by the RIS AE for Create and Set Modality Performed Procedure Step is defined in Table 23.

Table 23 Proposed Presentation Contexts for RIS AE Create and Set Modality Performed Procedure Step

Presentation Context Table					
Abstract Syntax		Transfer Syntax		Role	Extended Negotiation
Name	UID	Name List	UID List		
Modality Performed Procedure Step SOP Class	1.2.840.10008.3.1.2.3.3	ILE ELE EBE	1.2.840.10008.1.2 1.2.840.10008.1.2.1 1.2.840.10008.1.2.2	SCU	None

The implementation chooses ELE transfer syntax in case multiple transfer syntaxes are accepted in the association acceptance.

All details regarding the specific conformance, including response behavior to all status codes, both from an application level and communication errors are provided in Table 35 Table 36, and Table 37.

4.2.1.3.2.3. SOP Specific Conformance for SOP Classes

The set of attributes within an N-CREATE and N-SET messages is fixed and it does not depend on configuration settings. In an N-CREATE message, all possible attributes and attribute sequences used in the N-SET are forecasted by defining the attributes and settings their values to NULL. When an N-SET message is transmitted, it may occur that a forecasted attribute isn't actually used. Table 24 up till Table 29 indicate whether or not an attribute and attribute value is sent during N-CREATE. Table 30 up till Table 34 indicate whether or not an attribute and attribute value is sent during MPPS N-SET.

Table 24: N-CREATE MPPS Request Identifier: SOP Common Module

Attribute Name	Tag	VR	Note
Specific Character Set	0008,0005	SQ	ISO_IR 100, ISO_IR 13, ISO_IR 14, ISO_IR 87 or ISO_IR 159

Table 25: N-CREATE MPPS Request Identifier: Image Acquisition Results Module

Attribute Name	Tag	VR	Note
Modality	0008,0060	CS	Applied Value(s): XA
Study ID	0020,0010	SH	If no Study ID is known, the Accession Number will be used as value.
Performed Action Item Code Sequence	0040,0260	SQ	
>Code Value	0008,0100	SH	
>Coding Scheme Designator	0008,0102	SH	
>Code Meaning	0008,0104	LO	
Performed Series Sequence	0040,0340	SQ	Sequence will be empty when there are no images to report

Table 26: N-CREATE MPPS Request Identifier: Performed Procedure Step Information Module

Attribute Name	Tag	VR	Note
Procedure Code Sequence	0008,1032	SQ	
>Code Value	0008,0100	SH	
>Coding Scheme Designator	0008,0102	SH	
>Code Meaning	0008,0104	LO	
Performed Station AE Title	0040,0241	AE	AE Title as configured by the RIS/CIS unit.
Performed Station Name	0040,0242	SH	
Performed Location	0040,0243	SH	Always Empty
Performed Procedure Step Start Date	0040,0244	DA	
Performed Procedure Step Start Time	0040,0245	TM	
Performed Procedure Step End Date	0040,0250	DA	
Performed Procedure Step End Time	0040,0251	TM	
Performed Procedure Step Status	0040,0252	CS	
Performed Procedure Step ID	0040,0253	SH	
Performed Procedure Step Description	0040,0254	LO	
Performed Procedure Type Description	0040,0255	LO	

Table 27: N-CREATE MPPS Request Identifier: Performed Procedure Step Relationship Module

Attribute Name	Tag	VR	Note
Referenced Patient Sequence	0008,1120	SQ	
>Referenced SOP Class UID	0008,1150	UI	
>Referenced SOP Instance UID	0008,1155	UI	
Patient's Name	0010,0010	PN	
Patient ID	0010,0020	LO	
Patient's Birth Date	0010,0030	DA	
Patient's Sex	0010,0040	CS	
Scheduled Step Attribute Sequence	0040,0270	SQ	
>Accession Number	0008,0050	SH	
>Referenced Study Sequence	0008,1110	SQ	

Attribute Name	Tag	VR	Note
>>Referenced SOP Class UID	0008,1150	UI	
>>Referenced SOP Instance UID	0008,1155	UI	
>Study Instance UID	0020,000D	UI	
>Requested Procedure Description	0032,1060	LO	
>Scheduled Procedure Step Description	0040,0007	LO	
>Scheduled Action Item Code Sequence	0040,0008	SQ	
>>Code Value	0008,0100	SH	
>>Coding Scheme Designator	0008,0102	SH	
>>Code Meaning	0008,0104	LO	
>Scheduled Procedure Step ID	0040,0009	SH	
>Requested Procedure ID	0040,1001	SH	

Table 28: N-CREATE MPPS Request Identifier: Billing and Material Management Codes Module

Attribute Name	Tag	VR	Note
Film Consumption Sequence	0040,0321	SQ	Always empty

Table 29: N-CREATE MPPS Request Identifier: Radiation Dose Module

Attribute Name	Tag	VR	Note
Image Area Dose Product	0018,115E	DS	
Total Time of Fluoroscopy	0040,0300	US	
Total Number of Exposures	0040,0301	US	
Entrance Dose	0040,0302	US	
Entrance Dose in mGy	0040,8302	DS	

Table 30: N-SET MPPS Request Identifier: Image Acquisition Results Module

Attribute Name	Tag	VR	Note
Performed Action Item Code Sequence	0040,0260	SQ	Sequence remains empty
>Code Value	0008,0100	SH	
>Coding Scheme Designator	0008,0102	SH	
>Code Meaning	0008,0104	LO	
Performed Series Sequence	0040,0340	SQ	May empty when no images to be reported
>Performing Physician's Name	0008,1050	PN	
>Operators Name	0008,1070	PN	
>Protocol Name	0018,1030	LO	
>Series Instance UID	0020,000E	UI	
>Series Description	0008,103E	LO	
>Retrieve AE Title	0008,0054	AE	
>Referenced Image Sequence	0008,1140	SQ	
>>Referenced SOP Class UID	0008,1150	UI	
>>Referenced SOP Instance UID	0008,1155	UI	
>Referenced Standalone SOP Instance Sequence	0040,0220	SQ	Refers to Dicom Object that were transferred to the Image Archive.
>>Referenced SOP Class UID	0008,1150	UI	
>>Referenced SOP Instance UID	0008,1155	UI	

Table 31: N-SET MPPS Request Identifier: Performed Procedure Step Information Module

Attribute Name	Tag	VR	Note
Procedure Code Sequence	0008,1032	SQ	
>Code Value	0008,0100	SH	

Attribute Name	Tag	VR	Note
>Coding Scheme Designator	0008,0102	SH	
>Code Meaning	0008,0104	LO	
Performed Procedure Step End Date	0040,0250	DA	
Performed Procedure Step End Time	0040,0251	TM	
Performed Procedure Step Status	0040,0252	CS	Applied Values: COMPLETED or DISCONTINUED
Performed Procedure Step Description	0040,0254	LO	
Performed Procedure Type Description	0040,0255	LO	

Table 32: N-SET MPPS Request Identifier: Radiation Dose Module

Attribute Name	Tag	VR	Note
Image Area Dose Product	0018,115E	DS	
Total Time of Fluoroscopy	0040,0300	US	
Total Number of Exposures	0040,0301	US	
Entrance Dose	0040,0302	US	In dGy
Entrance Dose in mGy	0040,8302	DS	In mGy

Table 33: N-SET MPPS Request Identifier: Billing and Material Management Codes Module

Attribute Name	Tag	VR	Note
Film Consumption Sequence	0040,0321	SQ	
>Medium Type	2000,0030	CS	
>Film Size ID	2010,0050	CS	DICOM defined terms are extended with the "ANY FILM" term
>Number of Films	2100,0170	IS	

Table 34: N-SET MPPS Request Identifier: SOP Common Module

Attribute Name	Tag	VR	Note
Specific Character Set	0008,0005	CS	ISO_IR 100, ISO_IR 13, ISO_IR 14, ISO_IR 87 or ISO_IR 159

Note: The SOP Common Module is also send during the N-SET Request

Referenced Image Sequence (0008,1140) and to Referenced Standalone SOP Instance Sequence (0040,0220) report all Image Series which have been transferred to the Image Archive.

The behavior of the RIS AE for status codes in an MPPS N-CREATE response and N-SET response is presented in Table 35 and Table 36 respectively. In case of the retransmission attempt each message stored in the persistent queue is sent over a separate association.

Table 35: MPPS N-CREATE Response Status Handling Behavior

Service Status	Error Code	Further Meaning	Behavior
Success	0000	Successful operation.	The notify status of the related examination is updated (set to inprogress). The examination status is not changed (e.g. still in progress).

Service Status	Error Code	Further Meaning	Behavior
Failure	0213	Resource limitation	The message contents is made persistent and the message is added to the persistent queue and waits for the next retransmission attempt. The examination status is not changed (e.g. still in progress).
*	Any other status code	*	If the response status is reported during initial transmission the message contents is made persistent and the message is added to the persistent queue. If this response status is the result of the retransmission attempt related examination is updated to the state as if the transmission succeeded. This means that the notify status of the related examination is updated (set to inprogress) and if this response status is the result of the retransmission attempt message is removed from the persistent queue. The examination status is not changed (e.g. still in progress).The response status is logged as a warning.

Table 36: MPPS N-SET Response Status Handling Behavior

Service Status	Error Code	Further Meaning	Behavior
Success	0000	Successful operation.	The notify status of the related examination is updated (set to notified). The examination status is set to COMPLETED and it is logged.
Failure	0213	Resource limitation	The message contents is made persistent and the message is added to the persistent queue and waits for the next retransmission attempt. The examination status is set to CLOSED.
*	Any other status code	*	If this response status is reported during initial transmission the message contents is made persistent and the message is added to the persistent queue. If this response status is the result of the retransmission attempt related examination is updated to the state as if the transmission succeeded and the message is removed from the persistent queue. Than the notify status of the related examination is updated (set to notified). The response status is logged as a warning. The examination status is set to COMPLETED.

The behavior of the RIS AE during communication failure is summarized in Table 37.

Table 37: MPPS Communication Failure Behavior (N-SET, N_CREATE)

Exception	Behavior
Timeout	The Association is aborted using A-ABORT. The reason is logged and reported to the user. The message content is made persistent and the message is added to the persistent queue and waits for the next retransmission attempt. The examination status is set to CLOSED.
Association aborted	The command is marked as failed. The reason is logged and reported to the user. The message content is made persistent and the message is added to the persistent queue and waits for the next retransmission attempt. The examination status is set to CLOSED.
Association rejected	The command is marked as failed. The reason is logged and reported to the user. The message content is made persistent and the message is added to the persistent queue and waits for the next retransmission attempt. The examination status is set to CLOSED.

4.2.1.3.3. Verify Application Level Communication

4.2.1.3.3.1. Description and Sequencing of Activities

For each Verify Application Level Communication request, an association towards the remote system is established and a C-ECHO request is transmitted. Once the response is received, the association is closed.

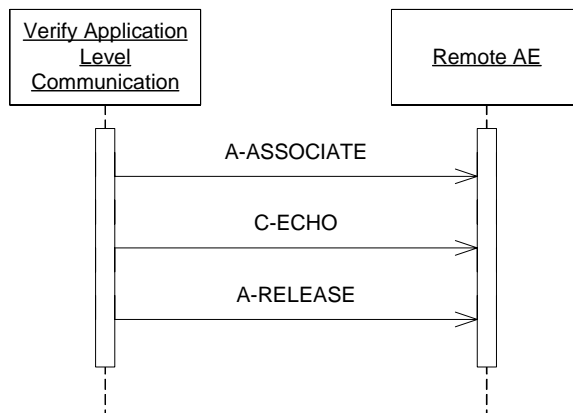

Figure 7 Sequencing of RWA Verify Application Level Communication

4.2.1.3.3.2. Proposed Presentation Contexts

Each time an association is initiated, the RIS AE proposes one presentation contexts to be used on that association. The presentation context proposed by the RIS AE for Verify Application Level Communication is defined in Table 38.

Table 38: Proposed Presentation Contexts for RIS AE Verify Application Level Communication

Presentation Context Table					
Abstract Syntax		Transfer Syntax		Role	Extended Negotiation
Name	UID	Name List	UID List		
Verification	1.2.840.10008.1.1	ILE ELE EBE	1.2.840.10008.1.2 1.2.840.10008.1.2.1 1.2.840.10008.1.2.2	SCU	None

The implementation chooses ELE transfer syntax in case multiple transfer syntaxes are accepted in the association acceptance.

4.2.1.3.3.3. SOP Specific Conformance for SOP Classes

The behavior of the RIS AE for status codes in an Verification response is summarized in Table 39.

Table 39: Verification C-ECHO Response Status Handling Behavior

Service Status	Error Code	Further Meaning	Behavior
Success	0000	Successful operation.	The success is reported to the operator.
*	Any other status code	*	The failure is reported to the operator.

The behavior of the RIS AE during communication failure is summarized in Table 40.

Table 40: Verification Communication Failure Behavior

Exception	Behavior
Timeout	The association is aborted using A-ABORT. The reason is logged and reported to the user.
Association aborted	The reason is logged and failure is reported to the user.
Association rejected	The reason is logged and failure is reported to the user.

4.2.1.4. Association Acceptance Policy

The RIS AE does not accept associations.

4.2.2. ACP AE

Every detail of the ACP AE shall be completely specified under this section.

4.2.2.1. SOP Classes

The ACP AE provides Standard Conformance to the SOP Classes presented in Table 41.

Table 41: SOP Classes for ACP AE

SOP Class Name	SOP Class UID	SCU	SCP
Secondary Capture Image Storage	1.2.840.10008.5.1.4.1.1.7	Yes	Yes
X-Ray Angiographic Image Storage	1.2.840.10008.5.1.4.1.1.12.1	Yes	Yes

SOP Class Name	SOP Class UID	SCU	SCP
Patient Root Query/Retrieve Information Model – FIND	1.2.840.10008.5.1.4.1.2.1.1	Yes	No
Patient Root Query/Retrieve Information Model – MOVE	1.2.840.10008.5.1.4.1.2.1.2	Yes	No
Study Root Query/Retrieve Information Model – FIND	1.2.840.10008.5.1.4.1.2.2.1	Yes	No
Study Root Query/Retrieve Information Model – MOVE	1.2.840.10008.5.1.4.1.2.2.2	Yes	No
Storage Commitment Push Model	1.2.840.10008.1.20.1	Yes	No
Basic Grayscale Print Management (Meta)	1.2.840.10008.5.1.1.9	Yes	No
>Basic Film Session	1.2.840.10008.5.1.1.1	Yes	No
>Basic Film Box	1.2.840.10008.5.1.1.2	Yes	No
>Basic Grayscale Image Box	1.2.840.10008.5.1.1.4	Yes	No
>Printer	1.2.840.10008.5.1.1.16	Yes	No
Verification	1.2.840.10008.1.1	Yes	Yes

Note: Any SOP specific behavior is documented later in the conformance statement in the applicable SOP specific conformance section.

4.2.2.2. Association Policies

This section contains a description of the general association establishment and acceptance policies of the ACP AE.

4.2.2.2.1. General

The ACP AE always proposes the DICOM Application Context Name (ACN) presented in Table 42. The maximum PDU length for receiving data is unrestricted and can be configured (0 < max. PDU < 2³² -1 Bytes). The PDU length for sending data is unrestricted.

Table 42: DICOM Application Context

Application Context Name	1.2.840.10008.3.1.1.1
--------------------------	-----------------------

4.2.2.2.2. Number of Associations

As a result of local activities, the ACP AE (SCU) can initialize a maximum of six simultaneous associations. One association may be used to issue storage commitment or transfer images requests, another association may be used to find remote Series of Images, another association may be used to move remote Series of Images, another association may be used to print images, another association may be used to handle storage commitment notifications, and finally another association may be used to verify application level communication.

The maximum number of simultaneous associations supported by the ACP AE (SCP) is unlimited by default and can be configured.

Table 43: Number of Associations as an Association Initiator for ACP AE

Maximum number of simultaneous associations	6
---	---

Table 44: Number of Associations as an Association Acceptor for ACP AE

Maximum number of simultaneous associations	Unlimited
---	-----------

4.2.2.2.3. **Asynchronous Nature**

The ACP AE does not support asynchronous operations except for storage commitment. After the storage commitment N-ACTION request is transmitted, storage commitment notification may be handled on another association.

Table 45: Asynchronous Nature as an Association Initiator for ACP AE

Maximum number of outstanding asynchronous transactions	1
---	---

4.2.2.2.4. **Implementation Identifying Information**

The value supplied for Implementation Class UID is presented in Table 46.

Table 46: DICOM Implementation Class UID and Version Name for ACP AE

Implementation Class UID	1.3.46.670589.7.28.4.1.1
Implementation Version Name	AlluraXper40ACP

4.2.2.3. **Association Initiation Policy**

The ACP AE initiate associations as a result of the following events:

- Images are transferred from the Allura Xper to a remote system (see Section 4.2.2.3.1).
- The operator queries for remote Series of Images (see Section 4.2.2.3.2).
- The operator requests import of remote Series of Images (see Section 4.2.2.3.3).
- A storage commitment for archived images is requested (see Section 4.2.2.3.4).
- The operator prints local images (see Section 4.2.2.3.5).
- In the service mode, the operator verifies printer status (see Section 4.2.2.3.6).
- In the service mode, the operator verifies application level communication (see Section 4.2.2.3.7).

4.2.2.3.1. **Transfer Images**

4.2.2.3.1.1. **Description and Sequencing of Activities**

The operator can select images and request them to be sent to (pre-configured) multiple destinations. Each request is forwarded to the job queue and processed as individual request to Transfer Images. If background image transfer is configured, the ACP AE sends automatically the acquired images. It can be configured which instances will be automatically marked and the destinations where the instances are automatically sent to. The background image transfer is triggered by the image acquisition event and/or by the close examination event in the Allura Xper.

For each request to Transfer Images (i.e., transfer job), one association towards the remote system is established. Within the association, for each image, a C-STORE request is transmitted. Once the responses are received, the association is closed. A possible sequence of interactions between the ACP AE and a remote AE with only one C-STORE request is presented in Figure 8.

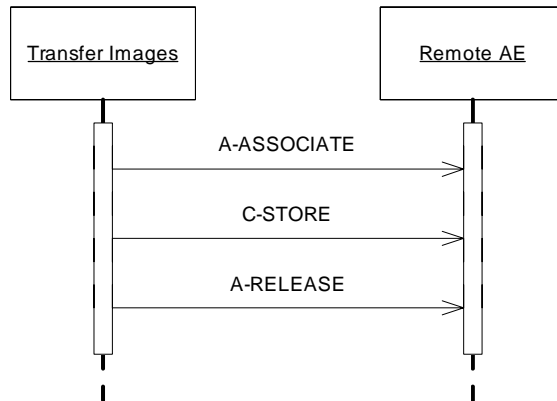

Figure 8 Sequencing of RWA Transfer Images

4.2.2.3.1.2. Proposed Presentation Contexts

Each time an association is initiated, the ACP AE proposes two presentation contexts to be used on that association. The presentation context proposed by the ACP AE for Transfer Images is defined in Table 47.

Table 47: Proposed Presentation Contexts for Transfer Images

Presentation Context Table					
Abstract Syntax		Transfer Syntax		Role	Extended Negotiation
Name	UID	Name List	UID List		
Secondary Capture Image Storage SOP Class	1.2.840.10008.5.1.4.1.1.7	ILE ELE EBE FOP ^{Note 1}	1.2.840.10008.1.2 1.2.840.10008.1.2.1 1.2.840.10008.1.2.2 1.2.840.10008.1.2.4.70	SCU	None
X-Ray Angiographic Image Storage SOP Class	1.2.840.10008.5.1.4.1.1.12.1	ILE ELE EBE FOP ^{Note 1}	1.2.840.10008.1.2 1.2.840.10008.1.2.1 1.2.840.10008.1.2.2 1.2.840.10008.1.2.4.70	SCU	None

Note 1: Lossless, Non-Hierarchical, first-order prediction JPEG compression.

The implementation proposes each SOP Class only ones in the abstract syntax specifying all possible transfer syntaxes for that SOP Class. Due to the fact that the SCP has to react with a chosen transfer syntax, the per SOP Class used transfer syntax is forced by the SCP.

4.2.2.3.1.3. SOP Specific Conformance for SOP Classes

The ACP AE can exchange image data in the following formats:

- Standard Extended X-Ray Angiographic (1.2.840.10008.5.1.4.1.1.12.1)
- Standard Secondary Capture (1.2.840.10008.5.1.4.1.1.7)

X-Ray Angiographic images can either be sent with raw pixel data or processed pixel data.

The contents of Standard Extended X-Ray Angiographic Image Storage SOP Instances and Standard Secondary Capture Image Storage SOP Instances created by ACP AE conform to the DICOM X-Ray Angiographic Image IOD and Standard Secondary Capture Image IOD respectively (see Section 8.1.1.2 and Section 8.1.1.1).

The behavior of the ACP AE for status codes in an C-STORE response is summarized in Table 48.

Table 48: Storage C-STORE Response Status Handling Behavior

Service Status	Error Code	Further Meaning	Behavior
Success	0000	Successful operation	The SCP has successfully stored the SOP Instances. If all SOP Instances in a send job have status success then the job is marked as completed. Success is logged.
Refused	A700-A7FF	Out of Resources	The association is aborted using A-ABORT and the send job is marked as failed. The failure reason is logged.
Error	A900-A9FF	Data Set does not match SOP Class	The association is aborted using A-ABORT and the send job is marked as failed. The failure reason is logged.
	C000-CFFF	Cannot Understand	The association is aborted using A-ABORT and the send job is marked as failed. The failure reason is logged.
Warning	B000	Coercion of Data Elements	The SCP has successfully stored the SOP Instances. If all SOP Instances in a send job have status success then the job is marked as completed. The Warning is logged.
	B006	Elements discarded	The SCP has successfully stored the SOP Instances. If all SOP Instances in a send job have status success then the job is marked as completed. The Warning is logged.
	B007	Data set does not match SOP class	The SCP has successfully stored the SOP Instances. If all SOP Instances in a send job have status success then the job is marked as completed. The Warning is logged.
*	Any other status code	*	The association is aborted using A-ABORT and the send job is marked as failed. The failure reason is logged.

The behavior of the ACP AE during communication failure is summarized in Table 49.

Table 49: Storage Communication Failure Behavior

Exception	Behavior
Timeout	The association is aborted using A-ABORT and the send job is marked as failed. The failure reason is logged.
Association aborted	The association is aborted using A-ABORT and the send job is marked as failed. The failure reason is logged.
Association rejected	The association is aborted using A-ABORT and the send job is marked as failed. The failure reason is logged.

4.2.2.3.2. Find Remote Images

4.2.2.3.2.1. Description and Sequencing of Activities

The operator is able to query a (pre-configured) remote database. The ACP AE initiates an association to the selected Remote AE and uses it to send C-FIND

requests (and receive the associated find replies). For each query a number of C-FIND requests is established in one association to the peer entity, which is released when all query results are received. An example sequencing of Activities is presented in Figure 9 and Figure 10.

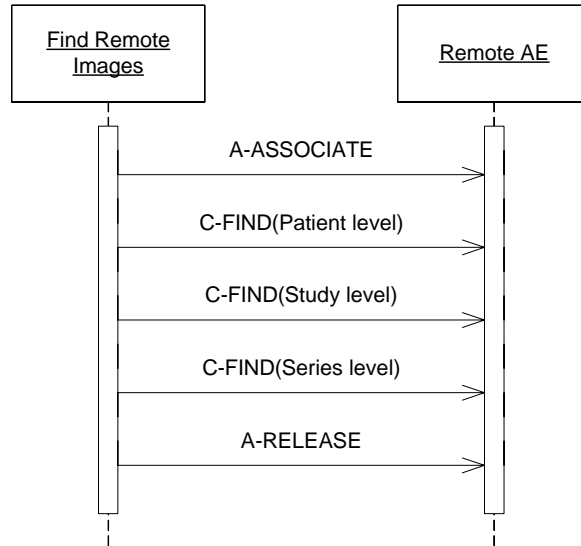

Figure 9 Sequencing of RWA Find Remote Images (Patient Root Q/R Information Model)

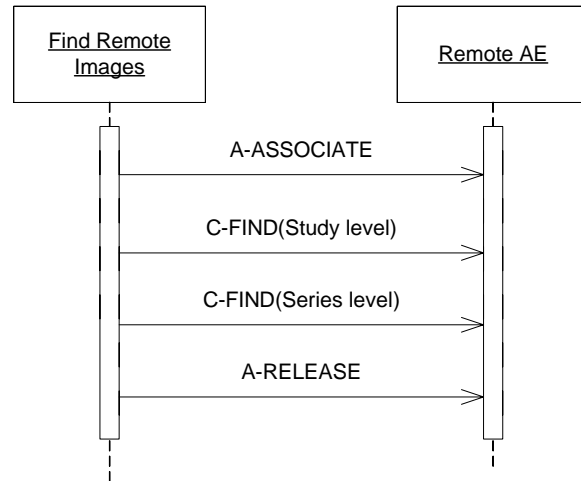

Figure 10 Sequencing of RWA Find Remote Images (Study Root Q/R Information Model)

The clinical user may cancel the query to the Image Archive or Image Display. As a result, the Allura Xper sends a C-FIND Cancel Request to the Image Archive or Image Display.

4.2.2.3.2.2. Proposed Presentation Contexts

Each time an association is initiated, the ACP AE proposes two presentation contexts to be used on that association. The presentation context proposed by the ACP AE for Find Remote Images is defined in Table 50.

Table 50: Proposed Presentation Contexts for Find Remote Images

Presentation Context Table					
Abstract Syntax		Transfer Syntax		Role	Extended Negotiation
Name	UID	Name List	UID List		
Pat. Root Q/R Inf. Model-FIND SOP Class	1.2.840.10008.5.1.4.1.2.1.1	ILE ELE EBE	1.2.840.10008.1.2 1.2.840.10008.1.2.1 1.2.840.10008.1.2.2	SCU	None
Study Root Q/R Inf. Model-FIND SOP Class	1.2.840.10008.5.1.4.1.2.2.1	ILE ELE EBE	1.2.840.10008.1.2 1.2.840.10008.1.2.1 1.2.840.10008.1.2.2	SCU	None

The implementation proposes each SOP Class only ones in the abstract syntax specifying all possible transfer syntaxes for that SOP Class. Due to the fact that the SCP has to react with a chosen transfer syntax, the per SOP Class used transfer syntax is forced by the SCP.

4.2.2.3.2.3. SOP Specific Conformance for SOP Classes

With the Allura Xper one can query for Series of Images. Series of Images which have the same Study Instance UID (0020,000D), Protocol Name (0018,1030), and Performing Physician's Name (0008,1050), will be presented as one query result. The Allura Xper interprets this as one query result belonging to the same examination.

A query can be done with one of the DICOM attributes presented in Table 51 up till Table 55.

Table 51: Patient Root Query/Retrieve Information Model – FIND SOP Class: Patient level keys

Attribute Name	Tag	VR	Matching type
Patient's Name	0010,0010	PN	Single value matching or wild card matching or universal matching
Patient ID	0010,0020	LO	Single value matching or universal matching
Patient's Birth Date	0010,0030	DA	Single value matching or universal matching
Patient's Sex	0010,0040	CS	Universal matching only

Table 52: Patient Root Query/Retrieve Information Model – FIND SOP Class :Study level keys

Attribute Name	Tag	VR	Matching type
Study Date	0008,0020	DA	Range matching or universal matching
Study Time	0008,0030	TM	Universal matching only
Accession Number	0008,0050	SH	Single value matching or wild card matching or universal matching
Study ID	0020,0010	SH	Universal matching only
Study Instance UID	0020,000D	UI	Universal matching only
Patient ID	0010,0020	LO	Single value matching or universal matching

**Table 53: Patient Root Query/Retrieve Information Model – FIND SOP Class:
Series level keys**

Attribute Name	Tag	VR	Matching type
Modality	0008,0060	CS	Universal matching only
Series Number	0020,0011	IS	Universal matching only
Series Instance UID	0020,000E	UI	Universal matching only
Performing Physician's Name	0008,1050	PN	Universal matching only
Protocol Name	0018,1030	LO	Single value matching or universal matching
Patient ID	0010,0020	LO	Single value matching or universal matching
Study Instance UID	0020,000D	UI	Single value matching only

**Table 54: Study Root Query/Retrieve Information Model – FIND SOP Class:
Study level keys**

Attribute Name	Tag	VR	Matching type
Study Date	0008,0020	DA	Range matching or universal matching
Study Time	0008,0030	TM	Universal matching only
Accession Number	0008,0050	SH	Value matching or wild card matching or universal matching
Patient's Name	0010,0010	PN	Single value matching or wild card matching or universal matching
Patient ID	0010,0020	LO	Single value matching or universal matching
Patient's Birth Date	0010,0030	DA	Single value matching or universal matching
Patient's Sex	0010,0040	CS	Universal matching only
Study ID	0020,0010	SH	Universal matching only
Study Instance UID	0020,000D	UI	Universal matching only

**Table 55: Study Root Query/Retrieve Information Model – FIND SOP Class:
Series level keys**

Attribute Name	Tag	VR	Matching type
Modality	0008,0060	CS	Universal matching only
Performing Physician's Name	0008,1050	PN	Universal matching only
Protocol Name	0018,1030	LO	Single value matching or universal matching
Study Instance UID	0020,000D	UI	Single value matching only
Series Instance UID	0020,000E	UI	Universal matching only
Series Number	0020,0011	IS	Universal matching only

The behavior of the ACP AE for status codes in an C-FIND response is summarized in Table 56.

Table 56: Query C-FIND Response Status Handling Behavior

Service Status	Error Code	Further Meaning	Behavior
Refused	A700	Out of Resources	Stops with processing the C-Find Response(s) from the SCP. The reason is logged and the failure is reported to the user.
Failed	A900	Identifier Does Not Match SOP Class	Stops with processing the C-Find Response(s) from the SCP. The reason is logged and the failure is reported to the user.

Service Status	Error Code	Further Meaning	Behavior
	Cxxx	Unable to process	Stops with processing the C-Find Response(s) from the SCP. The reason is logged and the failure is reported to the user.
Cancel	FE00	Matching terminated due to Cancel Match request	Stops with processing the C-Find Response(s) from the SCP. Results already received up to that point are displayed to the operator.
Success	0000	Matching is complete - No final Identifier is supplied.	Stops with processing the C-Find Response(s) from the SCP. All results are displayed to the operator.
Pending	FF00	Matches are continuing - Current Match is supported in the same manner as supplied and any Optional Keys were Required Keys.	Continues with processing of the C-Find Response(s) from the SCP
	FF01	Matches are continuing - Warning that one or more Optional Keys were not supported for existence for this Identifier.	Continues with processing of the C-Find Response(s) from the SCP.
*	Any other status code	*	The association is aborted using A-ABORT. The reason is logged and the failure is reported to the user.

The behavior of the ACP AE during communication failure is presented in Table 57.

Table 57: Query Communication Failure Behavior

Exception	Behavior
Timeout	The query is marked as failed. The association is aborted using A-ABORT. The reason is logged and reported to the user. The ACP AE stops processing the C-FIND Response(s) from the SCP.
Association aborted	If the association is aborted using A-ABORT, the query is marked as failed. The reason is logged and failure is reported to the user. Stops with processing the C-FIND Response(s) from the SCP.
Association rejected	The query is marked as failed. The reason is logged and failure is reported to the user. No C-FIND request performed.

4.2.2.3.3. Move Remote Images

4.2.2.3.3.1. Description and Sequencing of Activities

The request to Move Remote Images is forwarded to the job queue. For each move job, one association towards the remote system is established, and C-MOVE requests are transmitted. Once the responses are received, the association is closed. An example of sequencing of activities is presented in Figure 11.

C-MOVE requests are done on the series level.

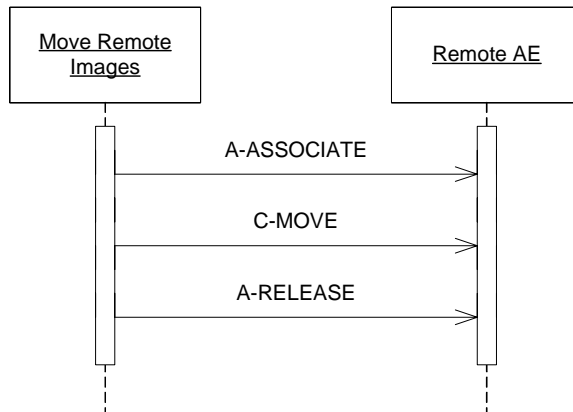

Figure 11 Sequencing of RWA Move Remote Images

The clinical user may cancel the move operation. As a result, the Allura Xper sends a C-MOVE Cancel Request to the Image Archive or Image Display.

4.2.2.3.3.2. Proposed Presentation Contexts

Each time an association is initiated, the ACP AE proposes two presentation contexts to be used on that association. The presentation context proposed by the ACP AE for Move Remote Images is defined in Table 58.

Table 58: Proposed Presentation Contexts for Move Remote Images

Presentation Context Table					
Abstract Syntax		Transfer Syntax		Role	Extended Negotiation
Name	UID	Name List	UID List		
Patient Root Query/Retrieve Information Model-MOVE SOP Class	1.2.840.10008.5.1.4.1.2.1.2	ILE ELE EBE	1.2.840.10008.1.2 1.2.840.10008.1.2.1 1.2.840.10008.1.2.2	SCU	None
Study Root Query/Retrieve Information Model-MOVE SOP Class	1.2.840.10008.5.1.4.1.2.2.2	ILE ELE EBE	1.2.840.10008.1.2 1.2.840.10008.1.2.1 1.2.840.10008.1.2.2	SCU	None

The implementation proposes each SOP Class only ones in the abstract syntax specifying all possible transfer syntaxes for that SOP Class. Due to the fact that the SCP has to react with a chosen transfer syntax, the per SOP Class used transfer syntax is forced by the SCP.

4.2.2.3.3.3. SOP Specific Conformance for SOP Classes

Selecting a query result can retrieve only whole examinations. It is not possible to retrieve information if Patient ID contains the sign "greater than" or "less than" (> or <). A C-MOVE can be done with the keys presented in Table 59 or Table 60.

Table 59: Patient Root Query/Retrieve Information Model – MOVE SOP Class: Series level attributes

Attribute Name	Tag	VR	Matching type
Patient ID	0010,0020	PN	Single value matching or universal

			matching
Study Instance UID	0020,000D	UI	Single value
Series Instance UID	0020,000E	UI	Single value

Table 60: Study Root Query/Retrieve Information Model – MOVE SOP Class: Series level attributes

Attribute Name	Tag	VR	Matching type
Series Instance UID	0020,000E	UI	Single value
Study Instance UID	0020,000D	UI	Single value

The behavior of the ACP AE for status codes in an C-MOVE response is summarized in Table 61.

Table 61: Query C-MOVE Response Status Handling Behavior

Service Status	Error Code	Further Meaning	Behavior
Refused	A701	Out of Resources – Unable to calculate number of matches	The move job is marked as failed. The association is released. The reason is logged and reported to the user.
	A702	Out of Resources – Unable to perform suboperations	The move job is marked as failed. The association is released. The reason is logged and reported to the user.
	A801	Move Destination Unknown	The move job is marked as failed. The association is released. The reason is logged and reported to the user.
Failed	A900	Identifier Does Not Match SOP Class	The move job is marked as failed. The association is released. The reason is logged and reported to the user.
	Cxxx	Unable to process	The move job is marked as failed. The association is released. The reason is logged and reported to the user.
Cancel	FE00	Sub-operations terminated due to Cancel Indication	The move job is marked as cancelled. The association is released. The reason is logged and reported to the user.
Success	0000	Sub-operations Complete – No Failures	The move job is marked as completed. The association is released. Success is logged.
Warning	B000	Sub-operations Complete – One or more Failures	The move job is marked as failed. The association is released. The reason is logged and reported to the user.
Pending	FF00	Sub-operations are continuing	The move job continues.
*	Any other status code	*	The association is aborted using A-ABORT. The reason is logged and the failure is reported to the user.

The behavior of the ACP AE during MOVE Communication failure is presented in Table 62.

Table 62: Move Communication Failure Behavior

Exception	Behavior
Timeout	The query is marked as failed. The association is aborted using A-ABORT. The reason is logged and reported to the user. The ACP AE stops processing the C-FIND Response(s) from the SCP.
Association aborted	If the association is aborted using A-ABORT, the query is marked as failed. The reason is logged and failure is reported to the user. Stops with processing the C-FIND Response(s) from the SCP.
Association rejected	The query is marked as failed. The reason is logged and failure is reported to the user. No C-FIND request performed.

4.2.2.3.4. Request Storage Commitment

4.2.2.3.4.1. Description and Sequencing of Activities

If the Remote AE is configured as an Image Archive and images have been sent to that Image Archive, the ACP AE will request storage commitment for instances of these images before it closes the examination. The request is forwarded to the job queue and processed as individual request to Request Storage Commitment. Only if a corresponding storage commitment notification is successfully received, the examination is completed.

For each request to Request Storage Commitment, one association towards the remote system is established, and the N-ACTION request is transmitted. The storage commitment request (N-ACTION) and confirmation (N-EVENT-REPORT) can be handled either in a synchronous (see Figure 12) or asynchronous (see Figure 13) way (a configurable item). The ACP AE can wait for synchronous report for a specified amount of time (configurable) and after that, it will request for releasing the association. As a result, the Storage Commit SCP must then request a new association to confirm the storage commit asynchronously.

The successful completion of the storage commitment request job only indicates that the N-ACTION request has been successfully transmitted to the Remote AE. In case of a synchronous storage commitment, the examination is marked as completed right after the successful completion of the storage commitment request job. In case of a asynchronous storage commitment, the examination is marked as completed only if a corresponding storage commitment notification from the Remote AE has been successfully received.

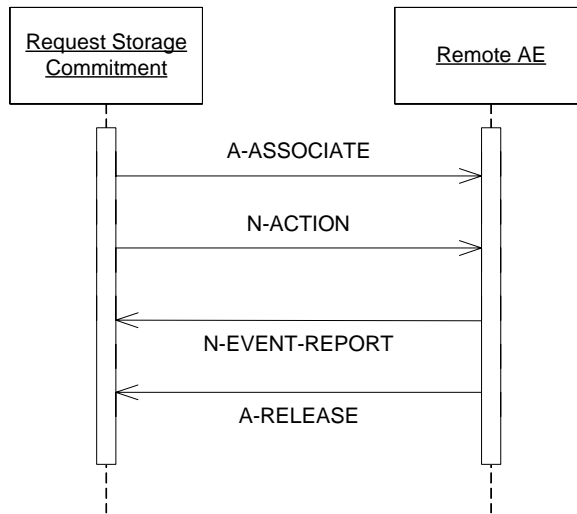

Figure 12 Sequencing of RWA Request Storage Commitment (synchronous)

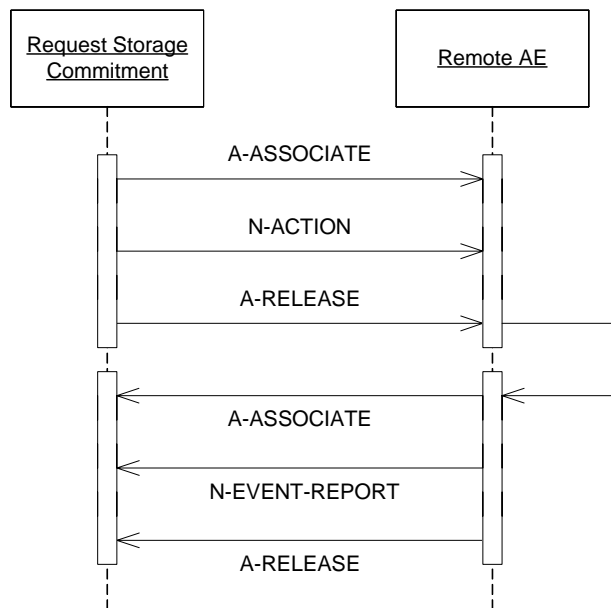

Figure 13 Sequencing of RWA Request Storage Commitment (asynchronous)

4.2.2.3.4.2. Proposed Presentation Contexts

Each time an association is initiated, the ACP AE proposes one presentation context to be used on that association. The presentation context proposed by the ACP AE for Request Storage Commitment is defined in Table 63.

Table 63: Proposed Presentation Contexts for Request Storage Commitment

Presentation Context Table					
Abstract Syntax		Transfer Syntax		Role	Extended Negotiation
Name	UID	Name List	UID List		
Storage Commit Push Model	1.2.840.10008.1.20.1.1	ILE ELE EBE	1.2.840.10008.1.2 1.2.840.10008.1.2.1 1.2.840.10008.1.2.2	SCU	None

The implementation proposes the SOP Class only ones in the abstract syntax specifying all possible transfer syntaxes for that SOP Class. Due to the fact that the SCP has to react with a chosen transfer syntax, the per SOP Class used transfer syntax is forced by the SCP.

4.2.2.3.4.3. SOP Specific Conformance for SOP Classes

4.2.2.3.4.3.1. Storage Commitment Operations (N-ACTION)

The behavior of the ACP AE for status codes in the N-ACTION response is summarized in Table 64.

Table 64: Storage Commitment N-ACTION Response Status Handling Behavior

Service Status	Error Code	Further Meaning	Behavior
Success	0000	Successful operation	The storage commitment request has been successfully sent. The storage commitment request job is marked as completed. Success is logged.
*	Any other status code	*	The association is aborted using A-ABORT. The storage commitment request job is marked as failed. The failure is also logged.

The behavior of the ACP AE during communication failure is summarized in Table 65.

Table 65: Storage Commitment Communication Failure Behavior

Exception	Behavior
Timeout	The association is aborted using A-ABORT and the storage commitment request job is marked as failed. The examination remains not completed. The failure reason is logged.
Association aborted	The association is aborted using A-ABORT and the storage commitment request job is marked as failed. The examination remains not completed. The failure reason is logged.
Association rejected	The association is aborted using A-ABORT and the storage commitment request job is marked as failed. The examination remains not completed. The failure reason is logged.

4.2.2.3.4.3.2. Storage Commitment Operations (N- EVENT-REPORT)

The behavior of the ACP AE for event types within N-ACTION is presented in Table 66.

Table 66: Storage Commitment N-EVENT-REPORT Behavior

Event Type	Event Type ID	Behavior
Storage Commitment Request Successful	1	The Examination is marked as completed and it becomes a candidate for an automatic deletion from the local database if local resources become scarce.
Storage Commitment Request Complete - Failures Exist	2	The failure is reported to the operator by not marking the examination as completed. The operator may re-transfer the image data (which was previously transferred to the Image Archive).

The behavior of the ACP AE for status codes in the N-EVENT-REPORT response is summarized in Table 67.

Table 67: Storage Commitment N-EVENT-REPORT Response Status Handling Behavior

Service Status	Error Code	Further Meaning	Behavior
Success	0000	Successful operation	The storage commitment result has been successfully received. The SCP has successfully stored the SOP Instances. The examination is marked as completed.
*	Any other status code	*	The association is aborted using A-ABORT. The examination remains not completed. The failure is also logged.

4.2.2.3.5. *Print Images*

4.2.2.3.5.1. **Description and Sequencing of Activities**

The operator can select images and request them to be printed on a printer (out of choice list of configured printers). Each request is forwarded to the job queue and processed as individual request to Print Images.

The print job consists of data describing the images and graphics to be printed as well as the requested layout and other parameters. One print job on the Allura Xper may result in a number of film sessions with the printer equal to the number of printed film sheets. Each film sheet within the print job is internally processed, converted to a STANDARD/1,1 page and then an association towards the remote Print Server is established and the page image is sent to that Print Server. Once the transmission of the film sheet is completed, the association is closed. A sequence of interactions between the ACP AE and a remote AE to print one film sheet is presented in Figure 14.

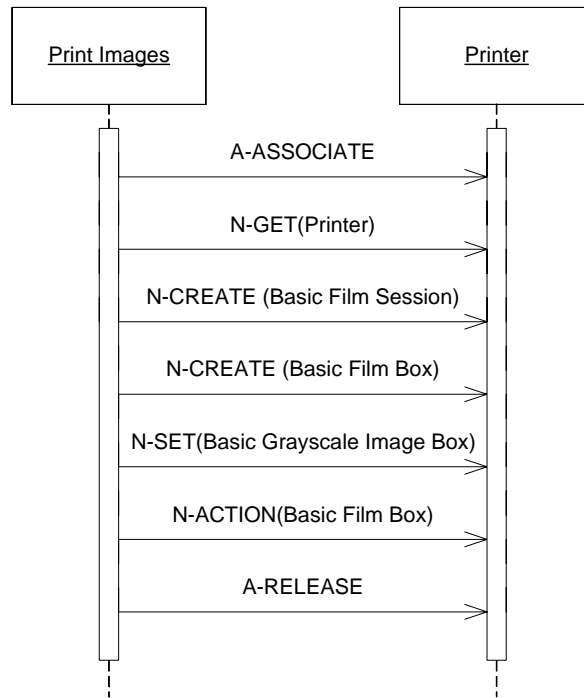

Figure 14 Sequencing of RWA Print Images

The following implementation remarks are important to achieve successful printing:

- Each film sheet is printed in a separate association
- The number of Film Boxes per Film Session is one.
- The number of images per Film Box is one. The images to be printed on one film are rendered by the ACP AE into one logical image. This logical image is very large, depending on the pixel matrix size (pixels per line, lines per image). A rough indication is 20 Mbytes. One should take this into account when selecting the DICOM printer and the printer configuration (e.g. the amount of memory).
- The ACP AE will request for releasing the association when the print command is given (i.e. the N-ACTION Request); the association is not kept open for receiving N-EVENT-REPORTs of the Printer SOP Class.

4.2.2.3.5.2. Proposed Presentation Contexts

Each time an association is initiated, the ACP AE proposes presentation contexts to be used on that association. The presentation contexts proposed by the ACP AE for Print Images is defined in Table 68.

Table 68: Proposed Presentation Contexts for Print Images

Presentation Context Table					
Abstract Syntax		Transfer Syntax		Role	Extended Negotiation
Name	UID	Name List	UID List		
Basic Grayscale Print Mgmt.Meta SOP Class	1.2.840.10008.5.1.1.9	ILE ELE EBE	1.2.840.10008.1.2 1.2.840.10008.1.2.1 1.2.840.10008.1.2.2	SCU	None
> Basic Film Session SOP Class	1.2.840.10008.5.1.1.1	ILE ELE EBE	1.2.840.10008.1.2 1.2.840.10008.1.2.1 1.2.840.10008.1.2.2	SCU	None
> Basic Film Box SOP Class	1.2.840.10008.5.1.1.2	ILE ELE EBE	1.2.840.10008.1.2 1.2.840.10008.1.2.1 1.2.840.10008.1.2.2	SCU	None
> Basic Grayscale Image Box SOP Class	1.2.840.10008.5.1.1.4	ILE ELE EBE	1.2.840.10008.1.2 1.2.840.10008.1.2.1 1.2.840.10008.1.2.2	SCU	None
> Printer SOP Class	1.2.840.10008.5.1.1.16	ILE ELE EBE	1.2.840.10008.1.2 1.2.840.10008.1.2.1 1.2.840.10008.1.2.2	SCU	None

The implementation proposes the SOP Class only ones in the abstract syntax specifying all possible transfer syntaxes for that SOP Class. Due to the fact that the SCP has to react with a chosen transfer syntax, the per SOP Class used transfer syntax is forced by the SCP.

4.2.2.3.5.3. SOP Specific Conformance for SOP Classes

The ACP AE provides standard conformance to the Basic Grayscale Print Management Meta SOP Class. The applied order of Print Service Elements (DIMSE's) is specified in Table 69. A description and the applied optional (i.e. non-mandatory attributes as Print SCU) attributes in these Service Elements are specified as well. Note that the Service Elements order is not specified by the DICOM standard. The ACP AE does not do an explicit N-DELETE request on the created instances; these are deleted implicitly when releasing the association. Overlay, annotation (showing the values of some major identifying attributes) and shutter information is processed in the images sent to the printer.

Table 69: The Applied Order of Print Service Elements

Service Element of SOP Class	Description
N-GET of the Printer SOP Class	Purpose is to retrieve printer information.
N-CREATE of the Basic Film Session SOP Class	Specifies the DICOM Printer about some general presentation parameters, applicable for all films in the Film Session. Applied attributes are: Number of Copies, Print Priority, Medium Type, Film Destination
N-CREATE of the Basic Film Box SOP Class	Specifies the DICOM Printer about some general presentation parameters, applicable for all images in the Film Box. Applied attributes are: Film Orientation, Film Size ID, Magnification Type, Max. Density, Configuration Information, Trim.
N-SET of the Basic Grayscale Image Box SOP Class	Images to be printed. Applied attributes are: Polarity
N-ACTION of the Basic Film Box SOP Class	Triggers the DICOM Printer to print. This actual print action is done at film box level. No attributes are present.

Table 70 specifies the supported Service Elements, which may be generated by the Printer at any time during the association.

Table 70: The Applied Seq. of Print Service Elements and its Optional Attributes

Service Element of SOP Class	Note
N-EVENT-REPORT of the Printer SOP Class	When N-EVENT-REPORT is received, no printer status polling on a separate connection is executed.

An overview of the applied attributes in the applied Service Elements of the supported SOP Classes is presented in Table 71 up till Table 76. The tables use a number of abbreviations. The abbreviations used in the "Presence of ..." column are:

- ALWAYS Always Present
- NEVER Never Present

The abbreviations used in the "Source" column:

- USER the attribute value source is from User input
- AUTO the attribute value is generated automatically

Table 71: N-GET-RQ Printer Module

Attribute Name	Tag	VR	Value	Presence of Value	Source
Printer Status	2110,0010	CS	FAILURE, NORMAL or WARNING Polling is not supported.	ALWAYS	Printer
Printer Status Info	2110,0020	CS	FILM JAM, RECEIVER FULL, SUPPLY EMPTY or SUPPLY LOW	ALWAYS	Printer

Table 72: N-CREATE-RQ Basic Film Session Presentation Module

Attribute Name	Tag	VR	Value	Presence of Value	Source
Number of Copies	2000,0010	IS	Between 1 and 99.	ALWAYS	USER
Print Priority	2000,0020	CS	HIGH	ALWAYS	AUTO
Medium Type	2000,0030	CS	BLUE FILM, CLEAR FILM or PAPER	ALWAYS	USER
Film Session Label	2000,0050	LO	Human readable label that identifies the film session	ALWAYS	AUTO
Film Destination	2000,0040	CS	MAGAZINE or PROCESSOR	ALWAYS	AUTO

Table 73: N-CREATE Basic Film Box Presentation Module

Attribute Name	Tag	VR	Value	Presence of Value	Source
Image Display Format	2010,0010	ST	The applied value below indicates that one (large) image is contained in a Film Box. STANDARD\1,1 or CUSTOM\1 (1 is a vendor specific index applied if the Standard Image Display Format does not result in acceptable films. Purpose of this value is to use the film surface as much as possible for image printing (and avoid large margins). This should be agreed per printer vendor.)	ALWAYS	AUTO
Film Orientation	2010,0040	CS	LANDSCAPE or PORTRAIT	ALWAYS	USER
Film Size ID	2010,0050	CS	DICOM specifies a number of Defined Terms; more values are possible and is print configuration dependent.	ALWAYS	USER
Magnification Type	2010,0060	CS	Normally sent out, however sometimes send out empty Because some DICOM printers are not able to handle (Value NONE for) this attribute. Applied value(s): NONE	ALWAYS	AUTO
Trim	2010,0140	CS	No	ALWAYS	AUTO
Configuration Information	2010,0150	ST	Contains a vendor specific Lookup-table (LUT); should be applied by the DICOM printer if LUT data is present.	ALWAYS	AUTO
Max Density	2010,0130	US	Maximum density of the images on the film, expressed in hundredths of OD. If Max Density is higher than maximum printer density than Max Density is set to maximum printer density.	ALWAYS	AUTO

Table 74: N-CREATE-RQ Basic Film Box Relationship Module

Attribute Name	Tag	VR	Value	Presence of Value	Source
Referenced Film Session Sequence	2010,0500	SQ	Parent Film Session	ALWAYS	AUTO
> Referenced SOP Class UID	0008,1150	UI	1.2.840.10008.5.1.1.1	ALWAYS	AUTO
> Referenced SOP Instance UID	0008,1155	UI	UID of Parent Film Session	ALWAYS	AUTO

Table 75: Modules of the Basic Grayscale Image Box SOP Class

Information Entity	Module Name	Usage
Image	SOP Common Module	NEVER
Printer	Image Box Pixel Presentation Module	ALWAYS

Table 76: N-SET-RQ Image Box Pixel Presentation Module

Attribute Name	Tag	VR	Value	Presence of Value	Source
Image Position	2020,0010	US	1	ALWAYS	AUTO
Polarity	2020,0020	CS	NORMAL	ALWAYS	AUTO
Preformatted Grayscale Image Sequence	2020,0110	SQ		ALWAYS	AUTO
> Samples per Pixel	0028,0002	US	1	ALWAYS	AUTO
> Photometric Interpretation	0028,0004	CS	MONOCHROME2	ALWAYS	AUTO
> Rows	0028,0010	US	Depending on the selected printer type and film size.	ALWAYS	AUTO
> Columns	0028,0011	US	Depending on the selected printer type and film size.	ALWAYS	AUTO
> Bits Allocated	0028,0100	US	16, 8	ALWAYS	AUTO
> Bits Stored	0028,0101	US	12 or 8	ALWAYS	AUTO
> High Bit	0028,0102	US	11 or 7	ALWAYS	AUTO
> Pixel Representation	0028,0103	US	0x0000	ALWAYS	AUTO
> Pixel Data	7FE0, 0010	OW		ALWAYS	AUTO

The behavior of the ACP AE for status codes in an N-GET response is summarized in Table 77.

Table 77: Printer N-GET Response Status Handling Behavior

Service Status	Error Code	Further Meaning	Behavior
Success	0000	Successful operation	The print job continues.
Warning	Xxx	Any warning	The print job continues and the warning is logged.
Error	Xxx	Any error	The association is aborted using A-ABORT and the print job is marked as failed. The failure reason is logged.

The behavior of the ACP AE for status codes in an N-CREATE response is summarized in Table 78.

Table 78: Basic Film Session N-CREATE Response Status Handling Behavior

Service Status	Error Code	Further Meaning	Behavior
Success	0000	Successful operation	The print job continues.
Warning	xxx	Any warning	The print job continues and the warning is logged.
Error	xxx	Any error	The association is aborted using A-ABORT. The print job will keep resubmitting the failed sheets until the error is solved or the retry time-out is exceeded.

The behavior of the ACP AE for status codes in an N-CREATE response is summarized in Table 79.

Table 79: Basic Film Box N-CREATE Response Status Handling Behavior

Service Status	Error Code	Further Meaning	Behavior
Success	0000	Successful operation	The print job continues.
Warning	xxx	Any warning	The print job continues and the warning is logged.
Error	xxx	Any error	The association is aborted using A-ABORT. The print job will keep resubmitting the failed sheets until the error is solved or the retry time-out is exceeded.

The behavior of the ACP AE for status codes in an N-SET response is summarized in Table 80.

Table 80: Basic Grayscale Image Box N-SET Response Status Handling Behavior

Service Status	Error Code	Further Meaning	Behavior
Success	0000	Successful operation	The print job continues.
Warning	xxx	Any warning	The print job continues and the warning is logged.
Error	xxx	Any error	The association is aborted using A-ABORT. The print job will keep resubmitting the failed sheets until the error is solved or the retry time-out is exceeded.

The behavior of the ACP AE for status codes in an N-ACTION response is summarized in Table 81.

Table 81: Basic Film Box N-ACTION Response Status Handling Behavior

Service Status	Error Code	Further Meaning	Behavior
Success	0000	Successful operation	The print job continues.
Warning	xxx	Any warning	The print job continues and the warning is logged.
Error	xxx	Any error	The association is aborted using A-ABORT. The print job will keep resubmitting the failed sheets until the error is solved or the retry time-out is exceeded.

The behavior of the ACP AE for status codes in an N-EVENT-REPORT response is summarized in Table 82.

Table 82: Printer SOP Class - N-EVENT-REPORT Behavior

Attribute Name	Tag	Note
Printer Status Info	2110,0020	Conditionally sent by the Printer. This status information will be ignored. However, polling this status via the N-GET Service Element is done.

The behavior of the ACP AE during communication failure is presented in Table 83.

Table 83: Printer Communication Failure Behavior

Exception	Behavior
Retry time-out	The print job fails. The reason is logged and reported to the user.
Any other exception	A retry to resubmit the failed sheets is repeated until the error is solved, the print job is cancelled or the retry time-out is exceeded.

4.2.2.3.6. Get Printer Status

4.2.2.3.6.1. Description and Sequencing of Activities

The operator (in the service mode) can select a DICOM printer (out of choice list of configured printers) and test its status. A sequence of interactions between the ACP AE and a remote AE to check the DICOM printer status is presented in Figure 15.

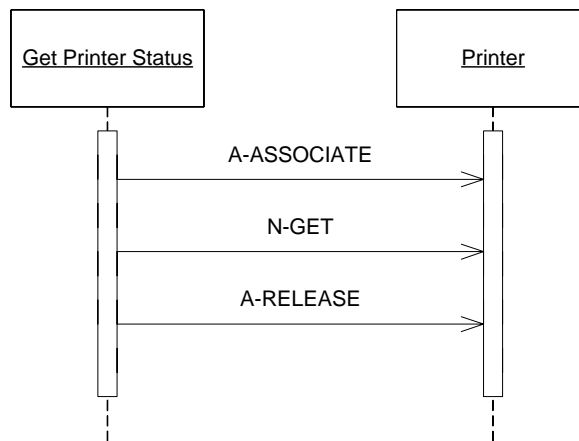

Figure 15 Sequencing of RWA Transfer Images

4.2.2.3.6.2. Proposed Presentation Contexts

Each time an association is initiated, the ACP AE proposes presentation contexts to be used on that association. The presentation contexts proposed by the ACP AE for Get Printer Status is defined in Table 84.

Table 84: Proposed Presentation Contexts for Transfer Images

Presentation Context Table					
Abstract Syntax		Transfer Syntax		Role	Extended Negotiation
Name	UID	Name List	UID List		
Basic Grayscale Print Mgmt.Meta SOP Class	1.2.840.10008.5.1.1.9	ILE ELE EBE	1.2.840.10008.1.2 1.2.840.10008.1.2.1 1.2.840.10008.1.2.2	SCU	None
> Printer SOP Class	1.2.840.10008.5.1.1.16	ILE ELE EBE	1.2.840.10008.1.2 1.2.840.10008.1.2.1 1.2.840.10008.1.2.2	SCU	None

The implementation proposes the SOP Class only ones in the abstract syntax specifying all possible transfer syntaxes for that SOP Class. Due to the fact that the SCP has to react with a chosen transfer syntax, the per SOP Class used transfer syntax is forced by the SCP.

4.2.2.3.6.3. SOP Specific Conformance for SOP Classes

The ACP AE provides standard conformance to the Basic Grayscale Print Management Meta SOP Class. The behavior of the ACP AE for status codes in an N-GET response is summarized in Table 85.

Table 85: Printer N-GET Response Status Handling Behavior

Service Status	Error Code	Further Meaning	Behavior
Success	0000	Successful operation	Success is reported to the user and is logged.
Warning	xxx	Any warning	Success is reported to the user and the warning is logged.
Error	xxx	Any error	Failure is reported to the user. The association is aborted using A-ABORT and the failure is logged.

The behavior of the ACP AE during communication failure is presented in Table 86.

Table 86: Printer Communication Failure Behavior

Exception	Behavior
Retry time-out	The print status job fails. The reason is logged and reported to the user.
Any other exception	A retry to resubmit the request for the printer status is repeated until the error is solved, the request is cancelled or the retry time-out is exceeded.

4.2.2.3.7. Verify Application Level Communication

4.2.2.3.7.1. Description and Sequencing of Activities

For each Verify Application Level Communication request, an association towards the remote system is established and a C-ECHO request is transmitted. Once the response is received, the association is closed.

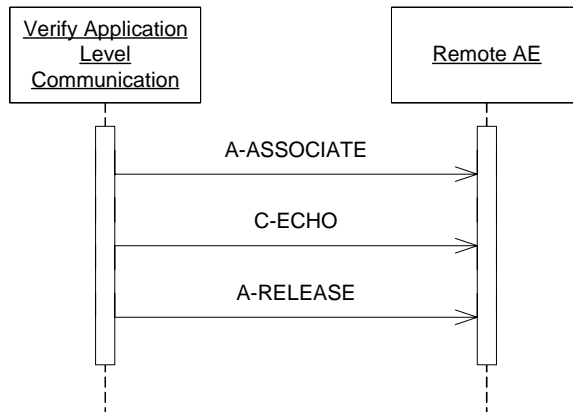

Figure 16 Sequencing of RWA Verify Application Level Communication

4.2.2.3.7.2. Proposed Presentation Contexts

Each time an association is initiated, the ACP AE proposes one presentation contexts to be used on that association. The presentation context proposed by the ACP AE for Verify Application Level Communication is defined in Table 87.

Table 87: Proposed Presentation Contexts for ACP AE Verify Application Level Communication

Presentation Context Table					
Abstract Syntax		Transfer Syntax		Role	Extended Negotiation
Name	UID	Name List	UID List		
Verification	1.2.840.10008.1.1	ILE ELE EBE	1.2.840.10008.1.2 1.2.840.10008.1.2.1 1.2.840.10008.1.2.2	SCU	None

The implementation proposes the SOP Class only ones in the abstract syntax specifying all possible transfer syntaxes for that SOP Class. Due to the fact that the SCP has to react with a chosen transfer syntax, the per SOP Class used transfer syntax is forced by the SCP.

4.2.2.3.7.3. SOP Specific Conformance for SOP Classes

The behavior of the ACP AE for status codes in an Verification response is summarized in Table 88.

Table 88: Verification C-ECHO Response Status Handling Behavior

Service Status	Error Code	Further Meaning	Behavior
Success	0000	Successful operation.	The success is reported to the operator.
*	Any other status code	*	The failure is reported to the operator.

The behavior of the ACP AE for status codes in an Verification response is summarized in Table 89.

Table 89: Verification Communication Failure Behavior

Exception	Behavior
Timeout	The association is aborted using A-ABORT. The reason is logged and reported to the user.
Association aborted	The reason is logged and failure is reported to the user.
Association rejected	The reason is logged and failure is reported to the user.

4.2.2.4. Association Acceptance Policy

The ACP AE accepts associations for the following purposes:

- To allow remote applications to store images on the Allura Xper (see Section 4.2.2.4.1)
- To allow remote applications to verify application level communication with the ACP AE
- To receive the Storage Commitment Notification

The ACP AE provides standard conformance to the rejection of an association. The ACP AE shall reject association requests from unknown applications, i.e. applications that offer an unknown “calling AE title”. An application is known if – and only if – it is defined during configuration of the ACP AE. The ACP AE shall reject association requests from applications that do not address the ACP AE, i.e. applications that offer a wrong “called AE title”. The ACP AE title is defined during configuration of the Allura Xper.

4.2.2.4.1. Import Images

4.2.2.4.1.1. Description and Sequencing of Activities

The ACP AE shall accept associations from systems that wish to store images in the Allura Xper database using the C-STORE command (see Figure 17).

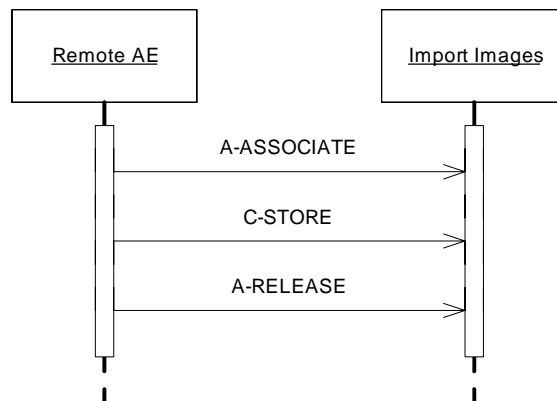

Figure 17 Sequencing of RWA Import Images

4.2.2.4.1.2. Accepted Presentation Contexts

Table 90: Acceptable Presentation Contexts for Import Images

Presentation Context Table					
Abstract Syntax		Transfer Syntax		Role	Extended Negotiation
Name	UID	Name List	UID List		
Secondary Capture Image Storage SOP Class	1.2.840.10008.5.1.4.1.1.7	ILE ELE EBE FOP ^{Note}	1.2.840.10008.1.2 1.2.840.10008.1.2.1 1.2.840.10008.1.2.2 1.2.840.10008.1.2.4.70	SCP	None
X-Ray Angiographic Image Storage SOP Class	1.2.840.10008.5.1.4.1.1.12.1	ILE ELE EBE FOP ^{Note}	1.2.840.10008.1.2 1.2.840.10008.1.2.1 1.2.840.10008.1.2.2 1.2.840.10008.1.2.4.70	SCP	None

Note: Lossless, Non-Hierarchical, First-Order Prediction JPEG compression.

The ACP AE accepts all contexts in the intersection of the proposed and acceptable Presentation Contexts. This means that the ACP AE accepts multiple Proposed Presentation Contexts with the same SOP Class but different Transfer Syntaxes. There is no check for duplicate contexts and are therefore accepted.

4.2.2.4.1.3. SOP Specific Conformance for SOP Classes

The ACP AE provides standard conformance to the error handling of image import. All error messages occur in a C-STORE response. It provides level 2 (full) conformance.

The behavior of the ACP AE for status codes in an C-STORE response is summarized in Table 91.

Table 91: Storage C-STORE Response Status Handling Behavior

Service Status	Error Code	Further Meaning	Behavior
Success	0000	Successful operation	The images shall be stored in the Allura Xper local database. Success shall be logged.
Refused	A700-A7FF	Out of Resources	The Allura Xper local database is full – recovery from this condition is left to the SCU. The ACP AE shall send a notification, and abort the association. The failure reason is logged.
Error	A900	Data Set does not match SOP Class	SOP class of the image(s) does not match the negotiated abstract syntax. The ACP AE shall send a notification and abort the association. The failure reason is logged.
	C000	Cannot Understand	The image(s) cannot be parsed. The ACP AE shall send a notification and abort the association. The failure reason is logged.
Warning	B000	Coercion of Data Elements	The association is aborted using A-ABORT and the send job is marked as failed. The failure reason is logged.

Service Status	Error Code	Further Meaning	Behavior
	B006	Elements discarded	The association is aborted using A-ABORT and the send job is marked as failed. The failure reason is logged.
	B007	Data set does not match SOP class	The association is aborted using A-ABORT and the send job is marked as failed. The failure reason is logged.

4.2.2.4.1.4. Import limitations

The ACP AE has the following import limitations:

- Images with a non square pixel matrix (e.g. 800x700) are ignored
- Images with a pixel depth (bits stored) not equal to 8 or 10 bits are rejected.
- Images with a photometric interpretation other than monochrome (e.g RGB) are rejected.

4.2.2.4.2. Request Verification

4.2.2.4.2.1. Description and Sequencing of Activities

The ACP AE shall accept associations from systems that wish to verify application level communication to the Allura Xper (see Figure 18).

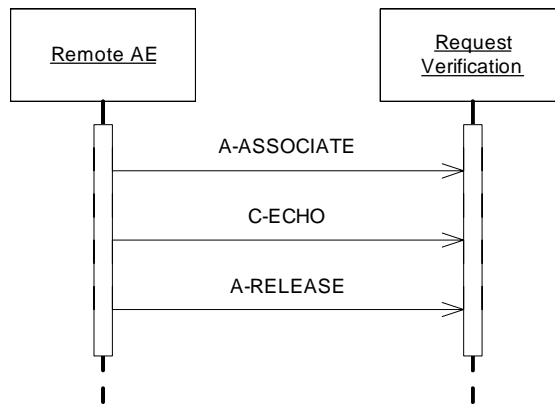

Figure 18 Sequencing of RWA Request Verification

4.2.2.4.2.2. Accepted Presentation Contexts

Table 92: Acceptable Presentation Contexts for Request Verification

Presentation Context Table					
Abstract Syntax		Transfer Syntax		Role	Extended Negotiation
Name	UID	Name List	UID List		
Verification	1.2.840.10008.1.1	ILE ELE EBE	1.2.840.10008.1.2 1.2.840.10008.1.2.1 1.2.840.10008.1.2.2	SCP	None

4.2.2.4.2.3. SOP Specific Conformance for SOP Classes

The ACP AE provides standard conformance to the DICOM Verification Service Class.

The behavior of the ACP AE for status codes in an Verification response is summarized in Table 93.

Table 93: Verification C-ECHO Response Status Handling Behavior

Service Status	Error Code	Further Meaning	Behavior
N.A.	N.A.	N.A.	N.A.

The behavior of the ACP AE for status codes in an Verification response is summarized in Table 94.

Table 94: Verification Communication Failure Behavior

Exception	Behavior
Timeout	The association is aborted using A-ABORT. The reason is logged and reported to the user.
Association aborted	The reason is logged and failure is reported to the user.
Association rejected	The reason is logged and failure is reported to the user.

4.3. Network Interfaces

4.3.1. Physical Network Interface

The Allura Xper provides DICOM V3.0 TCP/IP Network Communication. The TCP/IP stack is inherited from the .Net Framework/Windows XP operating system.

The Allura Xper supports a single network interface: Ethernet ISO.8802-3. Standard AUI, optional twisted pair 10/100-BaseT.

4.3.2. Additional Protocols

4.3.2.1. Basic TLS Secure Transport Connection Profile

The Allura Xper conforms to the Basic TLS Secure Transport Connection Profile (for details see Section 7.2.1: DICOM Basic TLS Secure Transport Connection Profile).

4.3.2.2. Basic Time Synchronization Profile

The Allura Xper conforms to the Basic Time Synchronization Profile as an NTP Client implementing the Maintain Time transaction.

4.3.2.3. Basic Application Level Confidentiality Profile

See Section 7.2.3.

4.4. Configuration

The Allura Xper RIS AE and ACP AE are configured by means of a Service Application. This Service Application is password protected and intended to be used by Philips Customer Support Service Engineers only. Configuration is stored in a configuration repository.

4.4.1. AE Title/Presentation Address Mapping

4.4.1.1. Local AE Titles

All local applications use the AE Titles and TCP/IP Ports configured via the Service Application. Default AE Titles are provided. The local AE title mapping and configuration are presented in Table 95.

Table 95: AE Title Configuration Table

Application Entity	Default AE Title	Default TCP/IP Port
RIS AE	AE_ALLURA_RIS	N.A.
ACP AE	AE_ALLURA_ACP	5101

4.4.1.2. Remote AE Title/Presentation Address Mapping

All relevant remote applications that should be able to setup a DICOM association towards Allura Xper and that should be able to accept a DICOM association from Allura Xper must be configured during the Allura Xper configuration time.

4.4.2. Parameters

The parameters that apply to each Application Entity are specified in separate sections specific to each AE (see Table 96).

Table 96: Configuration Parameters table

Parameter	Configurable	Default Value
RIS AE (Local System)		
AE title	Yes	AE_ALLURA_RIS
Association time out (Time-out waiting for acceptance or rejection Response to an Association Open Request)	Yes	15 seconds
ARTIM time out	Yes	30 seconds
Message time out (Time-out waiting for acceptance of a TCP/IP message over the network)	Yes	15 seconds
Network reply time out (time out waiting for any data (dimse level) exchange over the network)	No	3600 seconds
Maximum PDU size	Yes	16384
RIS AE (Basic Worklist Management)		
AE title	Yes	BWLM_SCP_AE
Port number	Yes	104
IP host name/address	Yes	BWLM-SCP-HN
Time span backwards/forwards (the time span before/after the current time and date for which scheduling information is needed)	Yes	2880 minutes (48h)
Is a Secure Node	Yes	No
Encryption On/Off	Yes	Off
Name of Private key-Certificate pair	Yes	BWLM-SCP-CN
RIS AE (Modality Performed Procedure Step)		
AE title	Yes	MPPS_SCP_AE
Port number	Yes	104
IP host name/address	Yes	MPPS-SCP-HN
Expiration time (the time after which the message will expire)	Yes	10080 minutes (1 week)
Retry time	Yes	60 minutes (1h)
Is a Secure Node	Yes	No
Encryption On/Off	Yes	Off

Parameter	Configurable	Default Value
Name of Private key-Certificate pair	Yes	MPPS-SCP-CN
Delay MPPS for local examinations	Yes	Yes
ACP AE (Local System)		
AE title	Yes	AE_localnode
Port number	Yes	5101
IP host name/address	Yes	Localnode
ARTIM time out	Yes	60 seconds
Message time out (Time-out waiting for acceptance of a TCP/IP message over the network)	No	60 seconds
Maximum PDU size (receiving)	Yes	16384
Maximum PDU size (sending)	No	16384
Maximum number of incoming associations	Yes	0
Is a Secure Node	Yes	No
Encryption On/Off	Yes	Off
Name of Private key-Certificate pair	Yes	-
ACP AE (Remote Network Node)		
AE title	Yes	Depends on the type of a configured network node
Port number	Yes	9999
IP host name/address	Yes	Depends on the type of a configured network
Human Readable Name	Yes	Depends on the type of a configured network
ARTIM time out	Yes	60 seconds
Message time out (Time-out waiting for acceptance of a TCP/IP message over the network)	Yes	3600 seconds for export or import network nodes 300 seconds for storage commitment or query/retrieve nodes
Supported transfer syntaxes and preferred order as SCU and SCP	Yes	Depends on the type of a configured network
Supported SOP classes as SCU and SCP	Yes	Depends on the type of a configured network
Archive/Storage commitment settings	Yes	No
Automatic conversion settings (e.g., pure, extended DICOM)	Yes	FULL
Is a Secure Node	Yes	No
Encryption On/Off	Yes	Off
Name of Private key-Certificate pair	Yes	-
ACP AE (Remote DICOM Printer)		
AE title	Yes	Depends on the configured printer
Port number	Yes	9999
IP host name/address	Yes	Depends on the configured printer
Human Readable Name	Yes	Depends on the configured printer
ARTIM time out	Yes	60
Message time out (Time-out waiting for acceptance of a TCP/IP message over the network)	Yes	3600 seconds
Print medium type		Depends on the configured printer
Is a Secure Node	Yes	No
Encryption On/Off	Yes	Off
Gray level transformation	Yes	STANDARD
Automatic conversion settings (e.g., pure, extended DICOM)	Yes	FULL

5. MEDIA INTERCHANGE

The Allura Xper does not support Media Storage.

6. SUPPORT OF CHARACTER SETS

Besides the DICOM default character repertoire, ISO 646 Latin Alphabet (ISO_IR 6), the following character sets are supported:

- ISO 8859 Western Europe Supplementary Set 1 (ISO_IR 100)
- JIS X 0201 Japanese Katakana and Romaji (ISO_IR 13 and ISO_IR 14) (only for the patient name)
- JIS X 0208 Japanese Kanji and Hiragana (ISO_IR 87) (only for the patient name)
- JIS X 0212 Japanese Kanji supplementary set (ISO_IR 159) (only for the patient name)

The strings in Allura Xper are represented in UNICODE.

When an unsupported character set is received, the image data shall be rejected.

7. SECURITY

7.1. Association Level Security

The Allura Xper shall reject association requests from unknown applications, i.e. applications that offer an unknown "calling AE title". An application is known if – and only if – it is defined during configuration of the Allura Xper. The Allura Xper shall reject association requests from applications that do not address its ACP AE, i.e. applications that offer a wrong "called AE title". The ACP AE title is defined during configuration of the Allura Xper.

7.2. Application Level Security

The Allura Xper allows the use of either a conventional (non-secure) DICOM communication or a secure DICOM communication based on the Transport Layer Security (TLS) protocol [TLS]. If configured, the Allura Xper supports security measures for:

- secure authentication of a node
- integrity and confidentiality of transmitted data
- replay protection
- generation of audit trail records
- access control and user authentication.

7.2.1. DICOM Basic TLS Secure Transport Connection Profile

Secure communication is a "mode of operation" of the Allura Xper supported by the implementation of the DICOM Basic TLS Secure Transport Connection Profile. This functionality will be used by the nodes that can authenticate each other before they exchange DICOM information. For secure communication the TLS protocol v1.0 is used which provides message authentication, integrity, confidentiality, and replay protection. Confidentiality is optional and can be controlled by the encryption settings.

The Allura Xper may communicate using the following Cipher Suites:

- TLS_RSA_WITH_NULL_SHA (Node authentication without encryption)
- TLS_RSA_WITH_3DES_SHA (Node authentication with encryption)

The Allura Xper supports X.509 certificates. The following TLS Certification checks will be done (TLS Handshake). The machine (either server or client) that will send its certificate will:

- Choose the certificate according to Common Name (CN) value in the Subject-field. This name is case-sensitive. All present certificates should have unique CN names.
- The server verifies
 - that the client certificate is a X.509 certificate which is not tampered with
 - that the client certificate is in the list of trusted certificates
 - that the client certificate is not expired (present time is between "Valid From" and "Valid To" fields of the X.509 certificate)
 - that the client certificate has the correct purpose (at least the Client Authentication purpose)

- The client verifies
 - that the server certificate is a X.509 certificate which is not tampered with
 - that the server certificate is in the list of trusted certificates
 - that the server certificate is not expired (present time is between "Valid From" and "Valid To" fields of the X.509 certificate)
 - that the server certificate has the correct purpose (at least Server Authentication purpose)

No verification is done on:

- revocation of certificates
- limiting the connection to a limited set of IP-addresses.

Node authentication with or without encryption is only possible when both nodes have:

- an access to their own private keys
- an access to a copy of the certificate of the other node containing its public key

The Allura Xper can only read certificates from the certificate stores of the HKEY_LOCAL_MACHINE registry key. It is the responsibility of the Hospital to setup and maintain the certificate stores. This includes the removal of revoked certificates and certificate updates prior to their expiration. Since neither X.500 directories, Lightweight Directory Access Protocol (LDAP) nor Certificate Revocation Lists (CRLs) are supported, the whole certificate chain needs to be replaced after a security breach.

Figure 19 presents the message flow of TLS handshake supported by the Allura Xper.

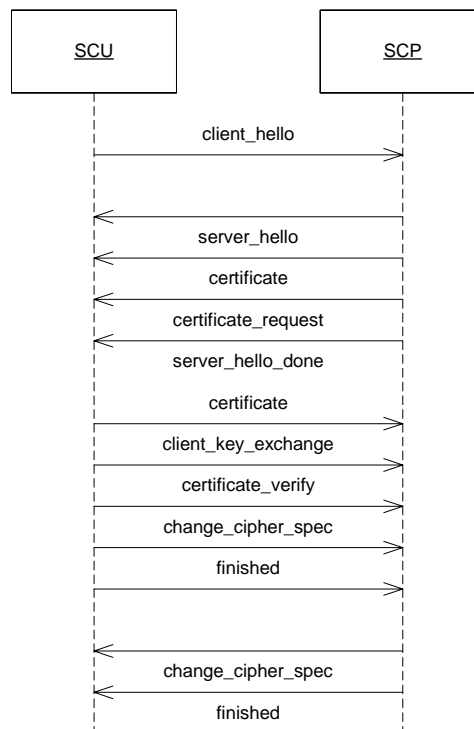

Figure 19 Message flow of TLS handshake

7.2.2. Generation of Audit Records

The Allura Xper can create audit messages according to the IHE Basic Security Integration Profile [IHE] to audit activities, to detect non-compliant behavior in the enterprise, and to facilitate detection of improper creation, access, modification and deletion of Protected Health Information (PHI). These messages may contain information that identifies the patient. The following messages will be created and sent to a central Audit Record Repository according to the Syslog protocol [SYSLOG]:

- ActorConfig (when security or networking configuration of the Allura Xper is modified via the field service functionality)
- ActorStartStop (when the Allura Xper starts or shuts down)
- Export (when an examination is saved to a file for field service purposes or printed on a film/paper)
- BeginStoringInstances (when an examination is transferred from the Allura Xper to a remote network node)
- DICOMInstancesDeleted (when an examination is deleted and it is not scheduled, prepared, or imported)
- DICOMInstancesUsed (when an examination is selected for acquisition)
- UserAuthenticated (when the user logs in or logs out)
- SecurityAlert (when an authentication of a secure node during TLS negotiation [TLS] fails, e.g. Due to an invalid certificate)

If the central Audit Record Repository is not available, the audit trail record will be stored by the Allura Xper in a local buffer. Once the central Audit Record Repository is available again, the content of that buffer will be transferred to the central Audit Record Repository. The time that is part of the audit message will be the local time of the Allura Xper. This time will be synchronized with a Time Server. The Time Server and central Audit Record Repository are elements of the Hospital infrastructure.

7.2.3. Basic Application Level Confidentiality Profile

The Allura Xper conforms to the Basic Application Level Confidentiality Profile as a de-identifier without encryption. This functionality is targeted toward creating a special purpose, de-identified version of an already-existing Data Set. The de-identified SOP Instances are useful, for example, in creating teaching or research files, where the identity of the patient should be protected.

The Allura Xper does not create instances of the Encrypted Attributes Data Set, therefore, reconstruction of the original Data Set will not be possible.

Table 97 presents all attributes that can be deidentified by the The Allura Xper. Each Attribute to be protected has its value replaced by a different “replacement value” which does not allow identification of the patient. Integrity of dummy values for references (such as SOP Instance UID, etc.) if multiple SOP instances are protected is ensured within the scope of one job.

The Allura Xper does not ensure that identifying information that is burned in to the image pixel data is “blackened” (removed).

Table 97: Deidentified attributes

Attribute Name	Tag	Replacement value
SOP Instance UID	0008,0018	New UID ^{Note 1}
Accession Number	0008,0050	Empty value
Institution Name	0008,0080	Empty value
Referring Physician's Name	0008,0090	Empty value

Attribute Name	Tag	Replacement value
Station Name	0008,1010	Empty value
Series Description	0008,103E	Empty value
Performing Physicians' Name	0008,1050	Empty value
Operators' Name	0008,1070	Empty value
Referenced SOP Instance UID	0008,1155	New UID ^{Note 1}
Patient's Name	0010,0010	Value provided by the user
Patient ID	0010,0020	New ID unique within the Hospital ^{Note 2}
Patient's Birth Date	0010,0030	Empty value
Patient's Sex	0010,0040	Empty value
Other Patient Ids	0010,1000	Empty value
Patient's Size	0010,1020	Empty value
Patient's Weight	0010,1030	Empty value
Ethnic Group	0010,2160	Empty value
Additional Patient's History	0010,21B0	Empty value
Patient Comments	0010,4000	Empty value
Device Serial Number	0018,1000	Empty value
Protocol Name	0018,1030	Empty value
Study Instance UID	0020,000D	New UID ^{Note 1}
Series Instance UID	0020,000E	New UID ^{Note 1}
Study ID	0020,0010	Empty value
Request Attributes Sequence	0040,0275	Empty value

Note 1: New values of SOP Instance UID consist of the constant prefix 1.3.46.670589.28. which is followed by the number derived from (1) Media Access Control (MAC) address of the Ethernet adapter configured on the Allura Xper and (2) the current date and time when the de-identification takes place.

Note 2: The new value of Patient ID is created as a concatenation of the system identification and the current date and time when the de-identification takes place.

8. ANNEXES

8.1. IOD Contents

The details of the applied modules are given in the tables below. The situation that an attribute is present conditionally/optionally or that an attribute may contain a zero length value is indicated too. Conditions and Defined/Enumerated Values of DICOM 3.0 are applicable but are not shown in the tables. The specified attributes are present and filled except for what is specified in the notes.

Several attribute values in the MPPS or Images are either received via Basic Worklist Management (BWLM) or entered by the user locally. The user locally cannot change attributes values, which are received via BWLM, as long as a RIS/CIS connection is established.

8.1.1. Created SOP Instances

The following tables use a number of abbreviations. The abbreviations used in the "Presence of ..." column are:

- VNAP Value Not Always Present (attribute sent zero length if no value is present)
- ANAP Attribute Not Always Present
- ALWAYS Always Present
- NEVER Never Present
- EMPTY Attribute is sent without a value

The abbreviations used in the "Source" column:

- MWL the attribute value source Modality Worklist
- USER the attribute value source is from User input
- AUTO the attribute value is generated automatically
- MPPS the attribute value is the same as that used for Modality Performed Procedure Step
- CONFIG the attribute value source is a configurable parameter

8.1.1.1. Secondary Capture Image Storage SOP Class - C-STORE-RQ

Table 98: Modules of the Secondary Capture Image Storage SOP Class

Information Entity	Module Name	Reference	Presence of Module
Patient	Patient	Table 99	ALWAYS
Study	General Study	Table 100	ALWAYS
	Patient Study	Table 101	ALWAYS
Series	General Series	Table 102	ALWAYS
Equipment	General Equipment	Table 103	ALWAYS
	SC Equipment	Table 104	ALWAYS
Image	General Image	Table 105	ALWAYS
	Image Pixel	Table 106	ALWAYS
	SC Image	-	NEVER
	Overlay Plane	-	NEVER
	Modality LUT	-	NEVER
	VOI LUT	Table 107	ALWAYS
	SOP common	Table 108	ALWAYS

Table 99: Patient Module

Attribute Name	Tag	VR	Value	Presence of Value	Source
Referenced Patient Sequence	0008,1120	SQ		ANAP	MWL
>Referenced SOP Class UID	0008,1150	UI		ANAP	MWL
>Referenced SOP Instance UID	0008,1155	UI		ANAP	MWL
Patient's Name	0010,0010	PN		ALWAYS	MWL/USER
Patient ID	0010,0020	LO		ALWAYS	MWL/USER
Patient's Birth Date	0010,0030	DA	<yyyymmdd>	VNAP	MWL/USER
Patient's Sex	0010,0040	CS		VNAP	MWL/USER
Other Patient Ids	0010,1000	LO		ANAP	MWL
Ethnic Group	0010,2160	SH		ANAP	MWL/USER
Patient Comments	0010,4000	LT		ANAP	MWL/USER

Table 100: General Study Module

Attribute Name	Tag	VR	Value	Presence of Value	Source
Study Date	0008,0020	DA	<yyyymmdd>	ALWAYS	AUTO
Study Time	0008,0030	TM	<hhmmss>	ALWAYS	AUTO
Accession Number	0008,0050	SH		ALWAYS	MWL/USER/AUTO
Referring Physician's Name	0008,0090	PN		VNAP	MWL
Referenced Study Sequence	0008,1110	SQ		ANAP	MWL
>Referenced SOP Class UID	0008,1150	UI		ANAP	MWL
>Referenced SOP Instance UID	0008,1155	UI		ANAP	MWL
Study Instance UID	0020,000D	UI		ALWAYS	AUTO
Study ID	0020,0010	SH	In case the Study ID is empty the accession number will be assigned. In case Study ID and Accession Number are the same, the Study ID will be left empty.	VNAP	MWL/USER/AUTO

Table 101: Patient Study Module

Attribute Name	Tag	VR	Value	Presence of Value	Source
Patient's Size	0010,1020	DS	In meters. When received from the Department System Scheduler, the value can still be modified.	ANAP	MWL/USER
Patient's Weight	0010,1030	DS	In kilograms. When received from the Department System Scheduler, the value can still be modified.	ANAP	MWL/USER
Additional Patient History	0010,21B0	LT		ANAP	MWL

Table 102: General Series Module

Attribute Name	Tag	VR	Value	Presence of Value	Source
Series Date	0008,0021	DA	<yyyymmdd>	ALWAYS	AUTO
Series Time	0008,0031	TM	<hhmmss>	ALWAYS	AUTO
Modality	0008,0060	CS	OT	ALWAYS	AUTO
Series Description	0008,103E	LO		ALWAYS	AUTO
Performing Physician's Name	0008,1050	PN		ANAP	MWL/USER
Operator's Name	0008,1070	PN		ANAP	MWL/USER
Referenced Performed Procedure Step Sequence	0008,1111	SQ	Identifies the MPPS SOP Instance to which this image is related	ANAP	AUTO/MPPS
>Referenced SOP Class UID	0008,1150	UI	MPPS SOP Class UID	ANAP	MWL
>Referenced SOP Instance UID	0008,1155	UI	MPPS SOP Instance UID	ANAP	MWL
Protocol Name	0018,1030	LO		ALWAYS	AUTO
Series Instance UID	0020,000E	UI		ALWAYS	AUTO
Series Number	0020,0011	IS		ALWAYS	AUTO
Laterality	0020,0060	CS		EMPTY	AUTO
Performed Procedure Step Start Date	0040,0244	DA	<yyyymmdd> Same as MPPS	ALWAYS	AUTO/MPPS
Performed Procedure Step Start Time	0040,0245	TM	<hhmmss> Same as MPPS	ALWAYS	AUTO/MPPS
Performed Procedure Step ID	0040,0253	SH	Same as MPPS	ALWAYS	AUTO/USER/MPPS
Performed Procedure Step Description	0040,0254	LO	Same as MPPS	ANAP	MWL/MPPS
Request Attributes Sequence	0040,0275	SQ		ALWAYS	MWL
>Scheduled Procedure Step ID	0040,0009	SH		ALWAYS	MWL
>Scheduled Procedure Step Description	0040,0007	LO		ALWAYS	MWL
>Requested Procedure ID	0040,1001	SH		ALWAYS	MWL
>Scheduled Protocol Code Sequence	0040,0008	SQ		ANAP	MWL
>>Code Value	0008,0100	SH		ANAP	MWL
>>Coding Scheme Designator	0008,0102	SH		ANAP	MWL
>>Code Meaning	0008,0104	LO		ANAP	MWL

Table 103: General Equipment Module

Attribute Name	Tag	VR	Value	Presence of Value	Source
Manufacturer	0008,0070	LO	Philips Medical Systems	ALWAYS	AUTO
Institution Name	0008,0080	LO		ALWAYS	CONFIG
Station Name	0008,1010	SH		ALWAYS	CONFIG
Manufacturer's Model Name	0008,1090	LO	AlluraXper	ALWAYS	AUTO
Device Serial Number	0018,1000	LO		ALWAYS	AUTO
Software Version(s)	0018,1020	LO		ALWAYS	AUTO

Table 104: SC Image Equipment Module

Attribute Name	Tag	VR	Value	Presence of Value	Source
Conversion Type	0008,0064	CS	WSD	ALWAYS	AUTO

Table 105: General Image Module

Attribute Name	Tag	VR	Value	Presence of Value	Source
Content Date	0008,0023	DA	<yyyymmdd>	ALWAYS	AUTO
Content Time	0008,0033	TM	<hhmmss>	ALWAYS	AUTO
Instance Number	0020,0013	IS		ALWAYS	AUTO
Patient Orientation	0020,0020	CS		VNAP	AUTO
Lossy Image Compression	0028,2110	CS	00	ALWAYS	AUTO
Image Type	0008,0008	CS	Value 1: DERIVED Value 2: PRIMARY	ALWAYS	AUTO
Derivation Description	0008,2111	ST	"SUBTRACTION" Sent if subtraction has been processed into the exported image.	ANAP	AUTO

Table 106: Image Pixel Module

Attribute Name	Tag	VR	Value	Presence of Value	Source
Samples per Pixel	0028,0002	US	1	ALWAYS	AUTO
Photometric Interpretation	0028,0004	CS	MONOCHROME2 Upon import, only images with a photometric interpretation MONOCHROME1 or MONOCHROME2 are accepted.	ALWAYS	AUTO
Rows	0028,0010	US	1024 The pixel matrix is always square. Upon import, only images with a square pixel matrix are accepted.	ALWAYS	AUTO
Columns	0028,0011	US	1024 The pixel matrix is always square. Upon import, only images with a square pixel matrix are accepted.	ALWAYS	AUTO
Bits Allocated	0028,0100	US	16	ALWAYS	AUTO
Bits Stored	0028,0101	US	10 Upon import, only images with bits stored equal to 8 or 10 bits are accepted.	ALWAYS	AUTO
High Bit	0028,0102	US		ALWAYS	AUTO
Pixel Representation	0028,0103	US	0000H	ALWAYS	AUTO
Pixel Data	7FE0,0010	OW		ALWAYS	AUTO

Table 107: VOI Lut Module

Attribute Name	Tag	VR	Value	Presence of Value	Source
Window Center	0028,1050	DS	Not sent if image is inverted.	ANAP	AUTO
Window Width	0028,1051	DS	Not sent if image is	ANAP	AUTO

Attribute Name	Tag	VR	Value	Presence of Value	Source
VOI LUT Sequence	0028,3010		inverted. Sent if image is inverted.	ANAP	AUTO
>LUT Descriptor	0028,3002	SS	Sent if image is inverted. [value 1]=1024 [value 2]=0 [value 3]=10	ANAP	AUTO
>Modality LUT Type	0028,3004	LO	US Sent if image is inverted.	ANAP	AUTO
>LUT Data	0028,3006	OW	Sent if image is inverted.	ANAP	AUTO

Table 108: SOP Common Module

Attribute Name	Tag	VR	Value	Presence of Value	Source
Specific Character Set	0008,0005	CS	ISO_IR 100, ISO_IR 13, ISO_IR 14, ISO_IR 87 or ISO_IR 159	ALWAYS	AUTO
SOP Class UID	0008,0016	UI	1.2.840.10008.5.1.4. 1.1.7	ALWAYS	AUTO
SOP Instance UID	0008,0018	UI	Generated by device	ALWAYS	AUTO

8.1.1.2. X-Ray Angiographic Image Storage SOP Class – C-STORE RQ

Table 109: Modules of the X-Ray Angiographic Image Storage SOP Class

Information Entity	Module Name	Reference	Presence of Module
Patient	Patient		ALWAYS
		Table 110	
Study	General Study	Table 111	ALWAYS
	Patient Study	Table 112	ALWAYS
Series	General Series	Table 113	ALWAYS
Equipment	General Equipment	Table 114	ALWAYS
Image	General Image	Table 115	ALWAYS
	Image Pixel	Table 116	ALWAYS
	Contrast/bolus	Table 117	ALWAYS
	Cine	Table 118	ALWAYS
	Multi-Frame	Table 119	ALWAYS
	Frame Pointers	-	NEVER
	Mask	-	NEVER
	Display Shutter	Table 120	ALWAYS
	Device	-	NEVER
	Therapy	-	NEVER
	X-Ray Image	Table 121	ALWAYS
	X-Ray Acquisition	Table 122	ALWAYS
	X-Ray Collimator	-	NEVER
	X-Ray Table	-	NEVER
XA Positioner	Table 123	ALWAYS	

Information Entity	Module Name	Reference	Presence of Module
	Overlay Plane	-	NEVER
	Multi-frame Overlay	-	NEVER
	Curve	Table 124	Only if physiological signals are acquired together with the X-Ray images.
	Modality LUT	Table 125	Only if raw pixel data is sent
	VOI LUT	Table 126	ALWAYS
	SOP common	Table 127	ALWAYS

Table 110: Patient Module

Attribute Name	Tag	VR	Value	Presence of Value	Source
Referenced Patient Sequence	0008,1120	SQ		ANAP	MWL
>Referenced SOP Class UID	0008,1150	UI		ANAP	MWL
>Referenced SOP Instance UID	0008,1155	UI		ANAP	MWL
Patient's Name	0010,0010	PN		ALWAYS	MWL/USER
Patient ID	0010,0020	LO		ALWAYS	MWL/USER
Patient's Birth Date	0010,0030	DA	<yyyymmdd>	VNAP	MWL/USER
Patient's Sex	0010,0040	CS		VNAP	MWL/USER
Other Patient Ids	0010,1000	LO		ANAP	MWL
Ethnic Group	0010,2160	SH		ANAP	MWL/USER
Patient Comments	0010,4000	LT		ANAP	MWL/USER

Table 111: General Study Module

Attribute Name	Tag	VR	Value	Presence of Value	Source
Study Date	0008,0020	DA	<yyyymmdd>	ALWAYS	AUTO
Study Time	0008,0030	TM	<hhmmss>	ALWAYS	AUTO
Accession Number	0008,0050	SH		ALWAYS	MWL/USER/AUTO
Referring Physician's Name	0008,0090	PN	Patient's referring physician.	VNAP	MWL
Referenced Study Sequence	0008,1110	SQ		ANAP	MWL
>Referenced SOP Class UID	0008,1150	UI		ANAP	MWL
>Referenced SOP Instance UID	0008,1155	UI		ANAP	MWL
Study Instance UID	0020,000D	UI		ALWAYS	AUTO
Study ID	0020,0010	SH	In case the Study ID is empty the accession number will be assigned. In case Study ID and Accession Number are the same, the Study ID will be left empty.	VNAP	MWL/USER/AUTO

Table 112: Patient Study Module

Attribute Name	Tag	VR	Value	Presence of Value	Source
Patient's Size	0010,1020	DS	In meters. When received from the Department System Scheduler, the value	ANAP	MWL/USER

Attribute Name	Tag	VR	Value	Presence of Value	Source
Patient's Weight	0010,1030	DS	can still be modified. In kilograms. When received from the Department System Scheduler, the value can still be modified.	ANAP	MWL/USER
Additional Patient History	0010,21B0	LT		ANAP	MWL

Table 113: General Series Module

Attribute Name	Tag	VR	Value	Presence of Value	Source
Series Date	0008,0021	DA	<yyyymmdd>	ALWAYS	AUTO
Series Time	0008,0031	TM	<hhmmss>	ALWAYS	AUTO
Modality	0008,0060	CS	XA	ALWAYS	AUTO
Series Description	0008,103E	LO		ALWAYS	AUTO
Performing Physician's Name	0008,1050	PN		ANAP	MWL/USER
Operator's Name	0008,1070	PN		ANAP	MWL/USER
Referenced Performed Procedure Step Sequence	0008,1111	SQ	Identifies the MPPS SOP Instance to which this image is related	ANAP	AUTO/MPPS
>Referenced SOP Class UID	0008,1150	UI	MPPS SOP Class UID	ANAP	MWL
>Referenced SOP Instance UID	0008,1155	UI	MPPS SOP Instance UID	ANAP	MWL
Protocol Name	0018,1030	LO		ALWAYS	AUTO
Series Instance UID	0020,000E	UI		ALWAYS	AUTO
Series Number	0020,0011	IS		ALWAYS	AUTO
Laterality	0020,0060	CS		EMPTY	AUTO
Performed Procedure Step Start Date	0040,0244	DA	<yyyymmdd> Same as MPPS	ALWAYS	AUTO/MPPS
Performed Procedure Step Start Time	0040,0245	TM	<hhmmss> Same as MPPS	ALWAYS	AUTO/MPPS
Performed Procedure Step ID	0040,0253	SH	Same as MPPS	ALWAYS	AUTO/USER/MPPS
Performed Procedure Step Description	0040,0254	LO	Same as MPPS	ANAP	MWL/MPPS
Request Attributes Sequence	0040,0275	SQ		ALWAYS	MWL
>Scheduled Procedure Step ID	0040,0009	SH		ALWAYS	MWL
>Scheduled Procedure Step Description	0040,0007	LO		ALWAYS	MWL
>Requested Procedure ID	0040,1001	SH		ALWAYS	MWL
>Scheduled Protocol Code Sequence	0040,0008	SQ		ANAP	MWL
>>Code Value	0008,0100	SH		ANAP	MWL
>>Coding Scheme Designator	0008,0102	SH		ANAP	MWL
>>Code Meaning	0008,0104	LO		ANAP	MWL

Table 114: General Equipment Module

Attribute Name	Tag	VR	Value	Presence of Value	Source
Manufacturer	0008,0070	LO	Philips Medical Systems	ALWAYS	AUTO
Institution Name	0008,0080	LO		ALWAYS	CONFIG
Station Name	0008,1010	SH		ALWAYS	CONFIG
Manufacturer's Model Name	0008,1090	LO	AlluraXper	ALWAYS	AUTO

Attribute Name	Tag	VR	Value	Presence of Value	Source
Device Serial Number	0018,1000	LO		ALWAYS	AUTO
Software Version(s)	0018,1020	LO		ALWAYS	AUTO

Table 115: General Image Module

Attribute Name	Tag	VR	Value	Presence of Value	Source
Content Date	0008,0023	DA	<yyyymmdd>	ALWAYS	AUTO
Content Time	0008,0033	TM	<hhmmss>	ALWAYS	AUTO
Instance Number	0020,0013	IS		ALWAYS	AUTO
Patient Orientation	0020,0020	CS		VNAP	AUTO
Lossy Image Compression	0028,2110	CS	00	ALWAYS	AUTO
Image Type	0008,0008	CS	Applied value(s): Value 1: ORIGINAL DERIVED(if subtraction has been processed into the image) Value 2: PRIMARY Value 3: SINGLE PLANE (if the image is a single plane acquisition) BIPLANE A (if the image is the first plane of a Bi-plane acquisition) BIPLANE B (if the image is the second plane of a Bi-plane acquisition) Value 4: SINGLE A (if the image is derived from plane A of a biplane image and sent as a SINGLE PLANE image) SINGLE B (if the image is derived from plane B of a biplane image and sent as a SINGLE PLANE image)	ALWAYS	AUTO
Derivation Description	0008,2111	ST	“SUBTRACTION” Sent if subtraction has been processed into the exported image “FRAME_SELECTION” Sent if the exported image consists of a subset of original frames. The terms are concatenated using the semi-colon (;) as a separator. No	ANAP	AUTO

Attribute Name	Tag	VR	Value	Presence of Value	Source
			separator allowed at the first position.		

Table 116: Image Pixel Module

Attribute Name	Tag	VR	Value	Presence of Value	Source
Samples per Pixel	0028,0002	US	1	ALWAYS	AUTO
Photometric Interpretation	0028,0004	CS	MONOCHROME2 Upon import, only images with a photometric interpretation MONOCHROME1 or MONOCHROME2 are accepted.	ALWAYS	AUTO
Rows	0028,0010	US	2048, 1024 or 512 The pixel matrix is always square. Upon import, only images with a square pixel matrix are accepted.	ALWAYS	AUTO
Columns	0028,0011	US	2048, 1024 or 512 The pixel matrix is always square. Upon import, only images with a square pixel matrix are accepted.	ALWAYS	AUTO
Bits Allocated	0028,0100	US	16 or 8	ALWAYS	AUTO
Bits Stored	0028,0101	US	10 or 8 Upon import, only images with bits stored equal to 8 or 10 bits are accepted.	ALWAYS	AUTO
High Bit	0028,0102	US		ALWAYS	AUTO
Pixel Representation	0028,0103	US	0000H	ALWAYS	AUTO
Pixel Data	7FE0,0010	OW		ALWAYS	AUTO

Table 117: Contrast/bolus Module

Attribute Name	Tag	VR	Value	Presence of Value	Source
Contrast/Bolus Agent	0018,0010	LO		ALWAYS	AUTO

Table 118: Cine Module

Attribute Name	Tag	VR	Value	Presence of Value	Source
Recommended Display Frame Rate	0008,2144	IS		ALWAYS	AUTO
Cine Rate	0018,0040	IS		ALWAYS	AUTO
Frame Time	0018,1063	DS		ALWAYS	AUTO
Frame Time Vector	0018,1065	DS		ALWAYS	AUTO
Frame Delay	0018,1066	DS		ALWAYS	AUTO

Table 119: Multi-Frame Module

Attribute Name	Tag	VR	Value	Presence of Value	Source
Number of Frames	0028,0008	IS		ANAP	AUTO
Frame Increment Pointer	0028,0009	AT	0x00181065 or 0x00181063	ALWAYS	AUTO

Table 120: Display Shutter Module

Attribute Name	Tag	VR	Value	Presence of Value	Source
Shutter Shape	0018,1600	CS	RECTANGULAR	ALWAYS	AUTO
Shutter Left Vertical Edge	0018,1602	IS		ALWAYS	AUTO
Shutter Right Vertical Edge	0018,1604	IS		ALWAYS	AUTO
Shutter Upper Horizontal Edge	0018,1606	IS		ALWAYS	AUTO
Shutter Lower Horizontal Edge	0018,1608	IS		ALWAYS	AUTO

Table 121: X-ray Image Module

Attribute Name	Tag	VR	Value	Presence of Value	Source
Image Type	0008,0008	CS	Value 1: ORIGINAL Value 2: PRIMARY Value 3: SINGLE PLANE (if the image is a single plane acquisition) BIPLANE A (if the image is the first plane of a Bi-plane acquisition) BIPLANE B (if the image is the second plane of a Bi-plane acquisition) Value 4: SINGLE A (if the image is derived from plane A of a biplane image and sent as a SINGLE PLANE image) SINGLE B (if the image is derived from plane B of a biplane image and sent as a SINGLE PLANE image)	ALWAYS	AUTO
Samples per Pixel	0028,0002	US	1	ALWAYS	AUTO
Photometric Interpretation	0028,0004	CS	MONOCHROME2 Upon import, only images with a photometric interpretation MONOCHROME1 or MONOCHROME2 are accepted.	ALWAYS	AUTO
Bits Allocated	0028,0100	US	16 or 8	ALWAYS	AUTO
Bits Stored	0028,0101	US	10 or 8 Upon import, only	ALWAYS	AUTO

Attribute Name	Tag	VR	Value	Presence of Value	Source
			images with bits stored equal to 8 or 10 bits are accepted.		
High Bit	0028,0102	US		ALWAYS	AUTO
Pixel Representation	0028,0103	US	0000H	ALWAYS	AUTO
Pixel Intensity Relationship	0028,1040	CS	LIN	ALWAYS	AUTO
Reference Image Sequence	0008,1140	SQ	Only used to relate each plane of a Biplane acquisition if Image Type (0008,0008) Value 3 is BIPLANE A or BIPLANE B.	ANAP	AUTO
> Reference SOP Class UID	0008,1150	UI		ANAP	AUTO
> Reference SOP Instance UID	0008,1155	UI		ANAP	AUTO

Table 122: X-ray Acquisition Module

Attribute Name	Tag	VR	Value	Presence of Value	Source
KVP	0018,0060	DS		ALWAYS	AUTO
Exposure Time	0018,1150	IS	Only sent if Exposure (0018,1152) is not sent.	ANAP	AUTO
X-Ray Tube Current	0018,1151	IS	Only sent if Exposure (0018,1152) is not sent.	ANAP	AUTO
Exposure	0018,1152	IS	Only sent if Exposure Time (0018,1150) and X-Ray Tube Current (0018,1151) are not sent.	ANAP	AUTO
Radiation Setting	0018,1155	CS		ALWAYS	AUTO
Imager Pixel Spacing	0018,1164	DS		ALWAYS	AUTO
Distance Source to Entrance	0040,0306	DS		ALWAYS	AUTO

Table 123: XA Positioner Module

Attribute Name	Tag	VR	Value	Presence of Value	Source
Distance Source to Detector	0018,1110	DS		ALWAYS	AUTO
Distance Source to Patient	0018,1111	DS		ALWAYS	AUTO
Positioner Motion	0018,1500	CS	STATIC or DYNAMIC	ALWAYS	AUTO
Positioner Primary Angle	0018,1510	DS		ALWAYS	AUTO
Positioner Secondary Angle	0018,1511	DS		ALWAYS	AUTO
Positioner Primary Angle Increment	0018,1520	DS	An array that contains the Positioner Primary Angle Increments between the n-th frame and the previous frame for a Multi-frame image. Only sent if Positioner Motion is	ANAP	AUTO

Attribute Name	Tag	VR	Value	Presence of Value	Source
			DYNAMIC.		
Positioner Secondary Angle Increment	0018,1521	DS	An array that contains the Positioner Secondary Angle Increments between the n-th frame and the previous frame for a Multi-frame image. Only sent if Positioner Motion is DYNAMIC.	ANAP	AUTO

Table 124: Curve Module²

Attribute Name	Tag	VR	Value	Presence of Value	Source
Curve Dimensions	50xx,0005	US	2	ANAP	AUTO
Number of Points	50xx,0010	US		ANAP	AUTO
Type of Data	50xx,0020	CS		ANAP	AUTO
Axis Units	50xx,0030	SH	For X: DPPS ³ For Y: NONE	ANAP	AUTO
Data Value Representation	50xx,0103	US	0000H	ANAP	AUTO
Minimum Coordinate Value	50xx,0104	US		ANAP	AUTO
Maximum Coordinate Value	50xx,0105	US		ANAP	AUTO
Curve Data Descriptor	50xx,0110	US	For X: 0000H For Y: 0001H	ANAP	AUTO
Coordinate Start Value	50xx,0112	US		ANAP	AUTO
Coordinate Step Value	50xx,0114	US	Number of data points stored for 1 second	ANAP	AUTO
Curve Data	50xx,3000	OW		ANAP	AUTO

Table 125: Modality LUT Module

Attribute Name	Tag	VR	Value	Presence of Value	Source
Modality LUT Sequence	0028,3000	SQ		ANAP	AUTO
>LUT Descriptor	0028,3002	SS	If 8 bits stored: [value 1]=256 [value 2]=0 [value 3]=8 If 10 bits stored: [value 1]=1024 [value 2]=0 [value 3]=10	ANAP	AUTO
>Modality LUT Type	0028,3004	LO	US	ANAP	AUTO
>LUT Data	0028,3006	OW		ANAP	AUTO

² For each (repeating) group 50xx, xx is determined based on the order of the (internal) image channels corresponding to the curves.

³ DPPS means Data Points Per Second

Table 126: VOI Lut Module

Attribute Name	Tag	VR	Value	Presence of Value	Source
Window Center	0028,1050	DS	Not sent if image is inverted.	ANAP	AUTO
Window Width	0028,1051	DS	Not sent if image is inverted.	ANAP	AUTO
VOI LUT Sequence	0028,3010		Sent if image is inverted.	ANAP	AUTO
>LUT Descriptor	0028,3002	SS	Sent if image is inverted. [value 1]=1024 [value 2]=0 [value 3]=10	ANAP	AUTO
>Modality LUT Type	0028,3004	LO	US Sent if image is inverted.	ANAP	AUTO
>LUT Data	0028,3006	OW	Sent if image is inverted.	ANAP	AUTO

Table 127: SOP Common Module

Attribute Name	Tag	VR	Value	Presence of Value	Source
Specific Character Set	0008,0005	CS	ISO_IR 100, ISO_IR 13, ISO_IR 14, ISO_IR 87 or ISO_IR 159	ALWAYS	AUTO
SOP Class UID	0008,0016	UI	1.2.840.10008.5.1.4. 1.1.12.1	ALWAYS	AUTO
SOP Instance UID	0008,0018	UI	Generated by device	ALWAYS	AUTO

8.1.2. Usage of Attributes from Received IOD's

No SOP class specific fields are required.

8.1.3. Attribute Mapping

Table 128: Attribute mapping between Modality Worklist, Image IOD and MPPS IOD

Modality Worklist	Image IOD	MPPS IOD
Patient Name	Patient Name	Patient Name
Patient ID	Patient ID	Patient ID
Other Patient Ids		----
Patient's Birth Date	Patient's Birth Date	Patient's Birth Date
Patient's Birth Time		----
Patient's Sex	Patient's Sex	Patient's Sex
Patient's Size		----
Patient's Weight	Patient's Weight	----
Ethnic Group	Ethnic Group	----
Patient Comments	Patient Comments	----
Referring Physician's Name	Referring Physician's Name	----
----	----	Scheduled Step Attributes Sequence
Study Instance UID	Study Instance UID	>Study Instance UID
Referenced Study Sequence	Referenced Study Sequence	>Referenced Study Sequence

Modality Worklist	Image IOD	MPPS IOD
Accession Number	Accession Number	>Accession Number
----	----	----
----	Request Attributes Sequence	----
Requested Procedure ID	>Requested Procedure ID	>Requested Procedure ID
Requested Procedure Description		>Requested Procedure Description
Scheduled Procedure Step Sequence	----	----
>Scheduled Procedure Step ID	>Scheduled Procedure Step ID	>Scheduled Procedure Step ID
>Scheduled Action Item Code Sequence		>Scheduled Action Item Code Sequence
>Scheduled Procedure Step Description	>Scheduled Procedure Step Description	>Scheduled Procedure Step Description
Scheduled Protocol Code Sequence	>Scheduled Protocol Code Sequence	----
----	----	Performed Protocol Code Sequence
----	Study ID	Study ID
----	Performed Procedure Step ID	Performed Procedure Step ID
----	Performed Procedure Step Start Date	Performed Procedure Step Start Date
----	Performed Procedure Step Start Time	Performed Procedure Step Start Time
----	Performed Procedure Step Description	Performed Procedure Step Description
----	----	Performed Series Sequence
>Scheduled Performing Physician's Name	Performing Physician's Name	>Performing Physician's Name
	Series Instance UID	>Series Instance UID
Requested Procedure Code Sequence	----	Procedure Code Sequence
----	Protocol Name	Protocol Name

8.1.4. Coerced/Modified fields

Allura Xper re-exports earlier imported images with a new Series Instance UID and Image SOP Instance UID.

8.2. Data Dictionary of Private Attributes

N.A.

8.3. Coded Terminology and Templates

N.A.

8.4. Grayscale Image consistency

The monitors and printers attached to the product can be calibrated by using the Service Application.

8.5. Standard Extended/Specialized/Private SOPs

N.A.

8.6. Private Transfer Syntaxes

N.A.