DICOM

Conformance Statement

PCR Eleva Release 1.2.3



Issued by:
Philips Healthcare

P.O. Box 10.000
5680 DA Best
The Netherlands

Document Number: PIIOffc.0001356
Date: 16-May-2013

1. DICOM CONFORMANCE STATEMENT OVERVIEW

This document is the DICOM Conformance Statement for the Philips Medical Systems PCR ELEVA.

The PCR Eleva system is a workstation for cassette-based digital radiography. It contains an export function based on the DICOM image storage to transfer image data from the PCR Eleva system to a remote system. This DICOM export function and other functions of PCR Eleva are described in this document.

PCR ELEVA in a DICOM network.

The figure below shows the position of PCR Eleva in a radiology environment.

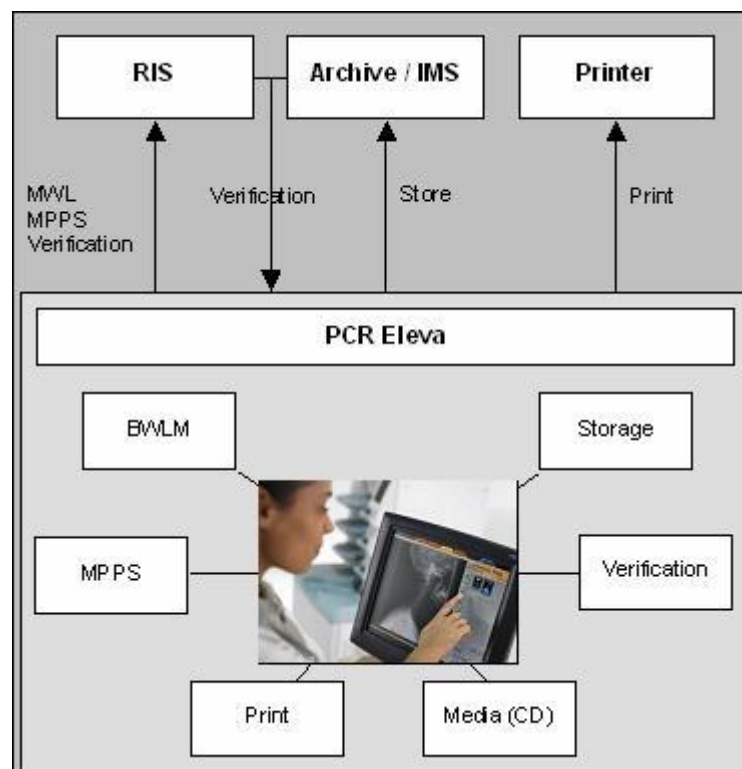

Figure 1: PCR Eleva in a DICOM network

PCR Eleva is an embedded modality system for DICOM images. It provides, among other things, the following features:

- Verification of application level communication.
- Basic Worklist Management (BWLM).
- Storage of images on a remote DICOM system.
- Study Management per Modality Performed Procedure Step (MPPS).
- Printing of hardcopies on a remote DICOM printer.
- Storage of images per DICOM media only on Compact Disc (CD).

Table 1: Network Services

SOP Class		User of Service (SCU)	Provider of Service (SCP)
Name	UID		
Other			
Verification SOP Class	1.2.840.10008.1.1	No	Yes
Print Management			
Basic Grayscale Print Management Meta SOP Class	1.2.840.10008.5.1.1.9	Yes	No
>Basic Film Box SOP Class	1.2.840.10008.5.1.1.2	Yes	No
>Basic Film Session SOP Class	1.2.840.10008.5.1.1.1	Yes	No
>Basic Grayscale Image Box SOP Class	1.2.840.10008.5.1.1.4	Yes	No
>Printer SOP Class	1.2.840.10008.5.1.1.16	Yes	No
Transfer			
Computed Radiography Image Storage SOP Class	1.2.840.10008.5.1.4.1.1.1	Yes	No
Digital Mammography X-Ray Image Storage - Pres. SOP	1.2.840.10008.5.1.4.1.1.1.2	Yes	No
Digital Mammography X-Ray Image Storage - Proc. SOP	1.2.840.10008.5.1.4.1.1.1.2.1	Yes	No
Digital X-Ray Image Storage - For Pres. SOP	1.2.840.10008.5.1.4.1.1.1.1	Yes	No
Digital X-Ray Image Storage - For Proc. SOP	1.2.840.10008.5.1.4.1.1.1.1.1	Yes	No
Secondary Capture Image Storage SOP Class	1.2.840.10008.5.1.4.1.1.7	Yes	No
Workflow Management			
Modality Performed Procedure Step SOP Class	1.2.840.10008.3.1.2.3.3	Yes	No
Modality Worklist Information Model - FIND SOP Class	1.2.840.10008.5.1.4.31	Yes	No
Storage Commitment Push Model SOP Class	1.2.840.10008.1.20.1	Yes	No

Note: Verification SCU (C-ECHO) is supported, but is only available for the service engineer during configuration. An auto configuration of a DICOM node using an A-ASSOCIATE-RQ can be initiated as well.

A table of Supported Media Storage Application Profiles (with roles) is provided.

Table 2: Media Services

Media Storage Application Profile	File-set Creator (FSC)	File-set Updater (FSU)	File-set Reader (FSR)	Display Directory (FSR)
Compact Disk-Recordable				
General Purpose CD-R Interchange	Yes	Yes	No	Yes

2. TABLE OF CONTENTS

1.	DICOM CONFORMANCE STATEMENT OVERVIEW	3
2.	TABLE OF CONTENTS	5
3.	INTRODUCTION	7
3.1.	REVISION HISTORY	7
3.2.	AUDIENCE	7
3.3.	REMARKS	7
3.4.	DEFINITIONS, TERMS AND ABBREVIATIONS	8
3.5.	REFERENCES	9
4.	NETWORKING	10
4.1.	IMPLEMENTATION MODEL	10
4.1.1.	Application Data Flow	10
4.1.2.	Functional Definition of AE's	11
4.1.2.1.	Functional Definition of Eleva	11
4.1.3.	Sequencing of Real World Activities	13
4.2.	AE SPECIFICATIONS	14
4.2.1.	Eleva	14
4.2.1.1.	SOP Classes	14
4.2.1.2.	Association Policies	14
4.2.1.2.1.	General	14
4.2.1.2.2.	Number of Associations	15
4.2.1.2.3.	Asynchronous Nature	15
4.2.1.2.4.	Implementation Identifying Information	15
4.2.1.2.5.	Communication Failure Handling	15
4.2.1.3.	Association Initiation Policy	16
4.2.1.3.1.	(Real-World) Activity – Modality worklist as SCU	18
4.2.1.3.2.	(Real-World) Activity – Modality Performed Procedure Step As SCU	26
4.2.1.3.3.	(Real-World) Activity – Storage Commitment Push Model AS SCU	32
4.2.1.3.4.	(Real-World) Activity – Image Export	34
4.2.1.3.5.	(Real-World) Activity – Print Management as SCU	38
4.2.1.4.	Association Acceptance Policy	43
4.2.1.4.1.	(Real-World) Activity – Verification as SCP	45
4.3.	NETWORK INTERFACES	46
4.3.1.	Physical Network Interfaces	46
4.3.2.	Additional Protocols	46
4.4.	CONFIGURATION	46
4.4.1.	AE Title/Presentation Address Mapping	46
4.4.1.1.	Local AE Titles	46
4.4.1.2.	Remote AE Title/Presentation Address Mapping	46
4.4.2.	Parameters	47
5.	MEDIA INTERCHANGE	48
5.1.	IMPLEMENTATION MODEL	48
5.1.1.	Application Data Flow Diagram	48
5.1.2.	Functional Definitions of AE's	48
5.1.2.1.	Functional Definition of Eleva	48
5.1.3.	Sequencing of Real World Activities	48
5.2.	AE SPECIFICATIONS	49
5.2.1.	Eleva Media – Specification	49
5.2.1.1.	File Meta Information for the Eleva Media	49
5.2.1.2.	Real-World Activities	49
5.2.1.2.1.	RWA - Create File-set	50
5.2.1.2.2.	RWA - Update File-set	50
5.2.1.2.3.	RWA - Display Directory	50
5.3.	AUGMENTED AND PRIVATE APPLICATION PROFILES	50
5.3.1.	Sequencing of Real World Activities	51
5.3.2.	Private Application Profiles	51
5.4.	MEDIA CONFIGURATION	51
6.	SUPPORT OF CHARACTER SETS	52

7.	SECURITY	53
7.1.	SECURITY TRANSPORT CONNECTION PROFILES	53
7.2.	ATTRIBUTE CONFIDENTIALITY PROFILES	53
8.	ANNEXES OF APPLICATION "ELEVA"	55
8.1.	IOD CONTENTS	55
8.1.1.	Created SOP Instance	55
8.1.1.1.	List of created SOP Classes	55
8.1.1.2.	Computed Radiography Image Storage SOP Class	56
8.1.1.3.	Secondary Capture Image Storage SOP Class	61
8.1.1.4.	Digital X-Ray Image Storage - For Pres. SOP	66
8.1.1.5.	Digital X-Ray Image Storage - For Proc. SOP	72
8.1.1.6.	Digital Mammography X-Ray Image Storage - Proc. SOP	78
8.1.1.7.	Digital Mammography X-Ray Image Storage - Pres. SOP	84
8.1.2.	Usage of Attributes from Received IOD	89
8.1.3.	Attribute Mapping	90
8.1.4.	Coerced/Modified fields	91
8.2.	DATA DICTIONARY OF PRIVATE ATTRIBUTES	91
8.3.	CODED TERMINOLOGY AND TEMPLATES	91
8.3.1.	Context Groups	91
8.3.2.	Template Specifications	91
8.3.3.	Private code definitions	91
8.4.	GRAYSCALE IMAGE CONSISTENCY	91
8.5.	STANDARD EXTENDED/SPECIALIZED/PRIVATE SOPS	91
8.6.	PRIVATE TRANSFER SYNTAXES	91

3. INTRODUCTION

The introduction specifies product and relevant disclaimers as well as any general information that the vendor feels is appropriate.

3.1. Revision History

The revision history provides dates and differences of the different releases.

Table 3: Revision History

Document Version	Date of Issue	Status	Description
00	26-August-2008	Proposal	Initial version
01	17 September 2008	Approved	Updated version after review.
02	24 September 2008	Approved	Changed Session 7
03	10 July 2009	Approved	Final version after update change GXRCQ00018648
04	3 August 2009	Approved	Review update on Final version.
05	19-June-2012	Approved	Updated for Release 1.2.2
06	16-May-2013	Approved	Updated for Release 1.2.3

3.2. Audience

This Conformance Statement is intended for:

- Potential customers
- System integrators of medical equipment
- Marketing staff interested in system functionality
- Software designers implementing DICOM interfaces

It is assumed that the reader is familiar with the DICOM standard.

3.3. Remarks

The DICOM Conformance Statement is contained in chapter 4 through 8 and follows the contents and structuring requirements of DICOM PS 3.2.

This DICOM Conformance Statement by itself does not guarantee successful interoperability of Philips equipment with non-Philips equipment. The user (or user's agent) should be aware of the following issues:

- **Interoperability**

Interoperability refers to the ability of application functions, distributed over two or more systems, to work successfully together. The integration of medical devices into an IT environment may require application functions that are not specified within the scope of DICOM. Consequently, using only the information provided by this Conformance Statement does not guarantee interoperability of Philips equipment with non-Philips equipment.

It is the user's responsibility to analyze thoroughly the application requirements

and to specify a solution that integrates Philips equipment with non-Philips equipment.

- **Validation**

Philips equipment has been carefully tested to assure that the actual implementation of the DICOM interface corresponds with this Conformance Statement.

Where Philips equipment is linked to non-Philips equipment, the first step is to compare the relevant Conformance Statements. If the Conformance Statements indicate that successful information exchange should be possible, additional validation tests will be necessary to ensure the functionality, performance, accuracy and stability of image and image related data. It is the responsibility of the user (or user's agent) to specify the appropriate test suite and to carry out the additional validation tests.

- **New versions of the DICOM Standard**

The DICOM Standard will evolve in future to meet the user's growing requirements and to incorporate new features and technologies. Philips is actively involved in this evolution and plans to adapt its equipment to future versions of the DICOM Standard. In order to do so, Philips reserves the right to make changes to its products or to discontinue its delivery.

The user should ensure that any non-Philips provider linking to Philips equipment also adapts to future versions of the DICOM Standard. If not, the incorporation of DICOM enhancements into Philips equipment may lead to loss of connectivity (in case of networking) and incompatibility (in case of media).

3.4. Definitions, Terms and Abbreviations

AE	Application Entity
CD	Compact Disc
CD-R	CD-Recordable
CR	Computed Radiography
DICOM	Digital Imaging and Communications in Medicine
DX	Digital X-Ray
EBE	DICOM Explicit VR Big Endian
ELE	DICOM Explicit VR Little Endian
FSC	File-set Creator
FSR	File-set Reader
FSU	File-set Updater
GUI	Graphic User Interface
ILE	DICOM Implicit VR Little Endian
IOD	Information Object Definition
MG	Mammography
MPPS	Modality Performed Procedure Step
NEMA	National Electrical Manufacturers Association
NM	Nuclear Medicine
PDU	Protocol Data Unit
RF	X-Ray Radiofluoroscopic
RIS	Radiology Information System
RWA	Real-World Activity
SC	Secondary Capture
SCP	Service Class Provider
SCU	Service Class User

SOP	Service Object Pair
TCP/IP	Transmission Control Protocol/ Internet Protocol
UID	Unique Identifier
US	Ultrasound
WLM	Worklist Management
XA	X-Ray Angiographic

3.5. References

- [DICOM] Digital Imaging and Communications in Medicine, Part 1 - 18 (NEMA PS 3.1- PS 3.18), National Electrical Manufacturers Association (NEMA) Publication Sales 1300 N. 17th Street, Suite 1847 Rosslyn, Virginia. 22209, United States of America Internet: <http://medical.nema.org/>
Note that at any point in time the official standard consists of the most recent yearly edition of the base standard (currently 2008) plus all the supplements and correction items that have been approved as Final Text.

4. NETWORKING

This section contains the networking related services (vs. the media related ones).

4.1. Implementation model

The implementation model consists of three sections:

- The application data flow diagram, specifying the relationship between the Application Entities and the "external world" or Real-World Activities,
- A functional description of each Application Entity, and
- The sequencing constraints among them.

4.1.1. Application Data Flow

The PCR Eleva system consists of one single application entity only the Eleva Application Entity (Eleva AE)

It incorporates the following functionality.

- The Eleva AE can verify application level communication by using the verification service as SCP.
- The Eleva AE can request a worklist by using the Basic Worklist Management service as SCU.
- The Eleva AE can store images by using the Storage service as SCU and use the Storage-Commit SOP-Class perform storage-commit as SCU.
- The Eleva AE can compose the modality performed procedure step by using the Study Management service as SCU.
- The Eleva AE can print images by using the Print Management service as SCU Eleva AE.

The figure bellows shows the networking application data flow as a functional overview of the Eleva AE.

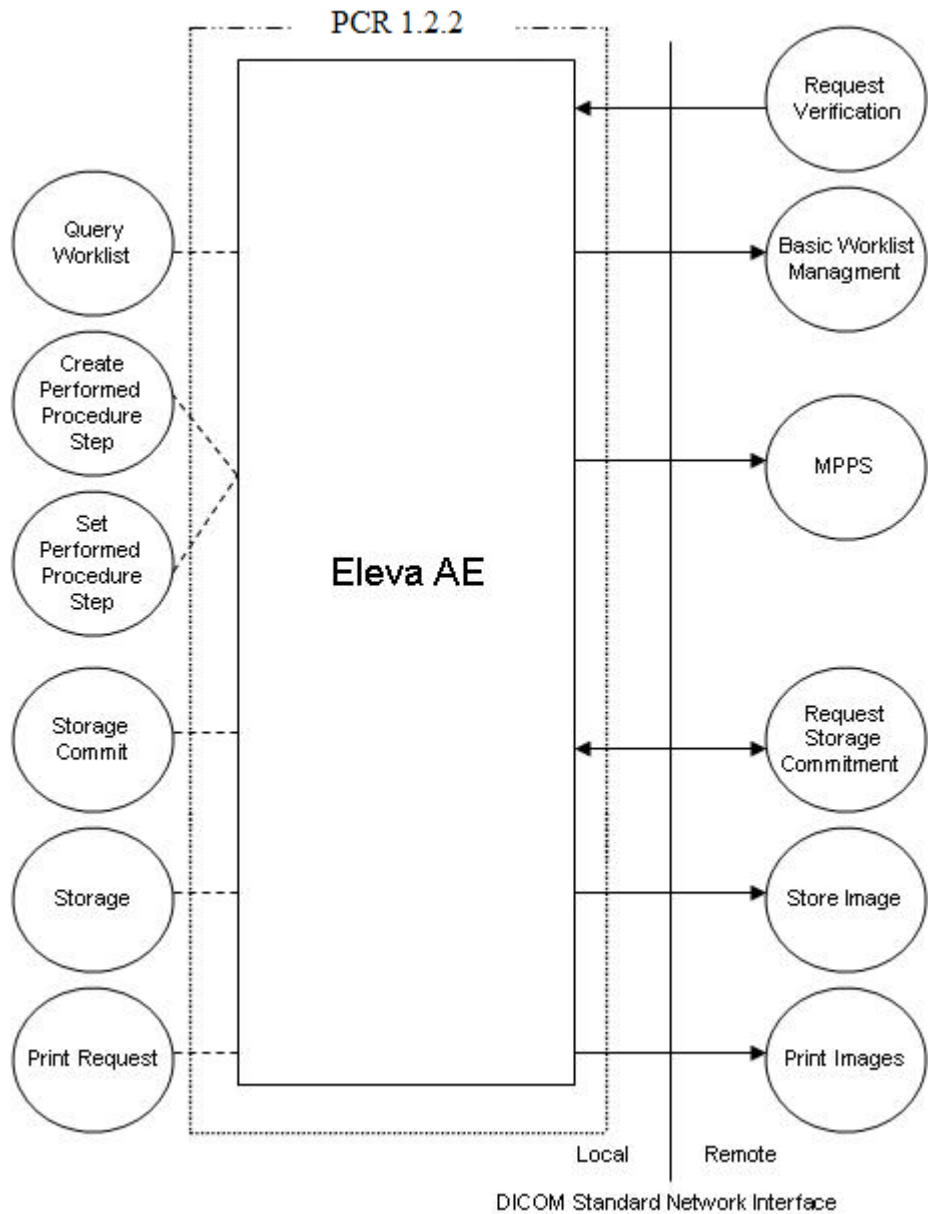

Figure 2: Application Data Flow Diagram

4.1.2. Functional Definition of AE's

This section contains a functional definition for each individual local Application Entity.

4.1.2.1. Functional Definition of Eleva

The Eleva AE is the one and only application entity within the PCR Eleva. It includes the following service classes.

Verification Service Class

The Eleva AE provides the Verification service as SCP.

A remote SCU shall request an association with the Eleva AE for Verification SOP class. After accepting the association the Eleva AE shall receive and respond to the Verification request and release the association when requested.

Basic Worklist Management Service Class

The Eleva AE may use the Basic Worklist Management service as SCU.

After initiating the worklist query the Eleva AE shall request an association with the configured remote Basic Worklist Management SCP. After accepting the association the Eleva AE shall send the find request, wait for response, and then release the association.

The user interface shall be updated with the query results.

Storage Service Class

The Eleva AE may use the Storage service as SCU.

After a performed procedure step the Eleva AE shall store the related images at the configured Storage SCP. It shall request an association with the remote Storage SCP for the applicable Storage SOP classes. After accepting the association the Eleva AE shall send the store request, wait for response, and then release the association.

After successful storage the user interface shall be updated accordingly.

After successful storage, if selected, the ELEV A AE shall request storage commitment per Storage Commitment service (ref. Storage Commitment Service Class)

Storage Commitment Service Class

The ELEV A AE can perform the Storage Commitment service as SCU.

The ELEV A AE shall request an association with the selected remote SCP for the Storage Commitment Push Model SOP class. When the association is accepted, the ELEV A AE shall send the Storage Commitment requests, receive the Storage Commitment responses and act accordingly, and release the association. When the remote commitment actions have been finished, the remote SCP should request an association with the ELEV A AE (still SCU). After accepting the association, the ELEV A AE shall receive the Storage Commitment reports, and release the association when requested.

The Storage Commitment Service can be done synchronously and asynchronously.

Study Management Service Class

The Eleva AE may use the Study Management service as SCU.

Before performing a procedure step the Eleva AE shall request an association with the configured remote Study Management SCP. After accepting the association the Eleva AE shall send a create request, wait for response, and then release the association.

After performing a procedure step the Eleva AE shall request a new association to send a set request, and after response, release the association. Depending on the status of creates and set and the configuration the Eleva AE may perform a retry. The user interface shall be updated with the performed procedure step status.

Basic Grayscale Print Management Meta Class

The Eleva AE may use the Basic Grayscale Print Management service as SCU.

After a performed procedure step the Eleva AE shall print the related images on the configured Printer. It shall request an association with the remote Basic Grayscale Print Management SCP for the applicable Basic Grayscale Print Management SOP class. After accepting the association the Eleva AE shall send the print request, wait for response, and then release the association.

After successful printing the user interface shall be updated accordingly.

4.1.3. Sequencing of Real World Activities

The figure below shows a typical sequence of an examination using a worklist. The user updates the worklist (query Worklist) and then selects and opens an examination. When the user starts the examination (acquiring the first image), the RIS is notified (Create Performed Procedure Step). After the user confirmed each acquisition (image 1-N) per default the image is sent to archive (Store Image) and printer (Print Image) simultaneously. Finally, when closing the examination, the RIS is notified to update the data of the examination (Set Performed Procedure Step).

Note that Print Image will send images to the printer only when enough images were received to fulfill the configured printer format or when the print job is flushed manually. When the last image of an examination is received the print job will be flushed automatically.

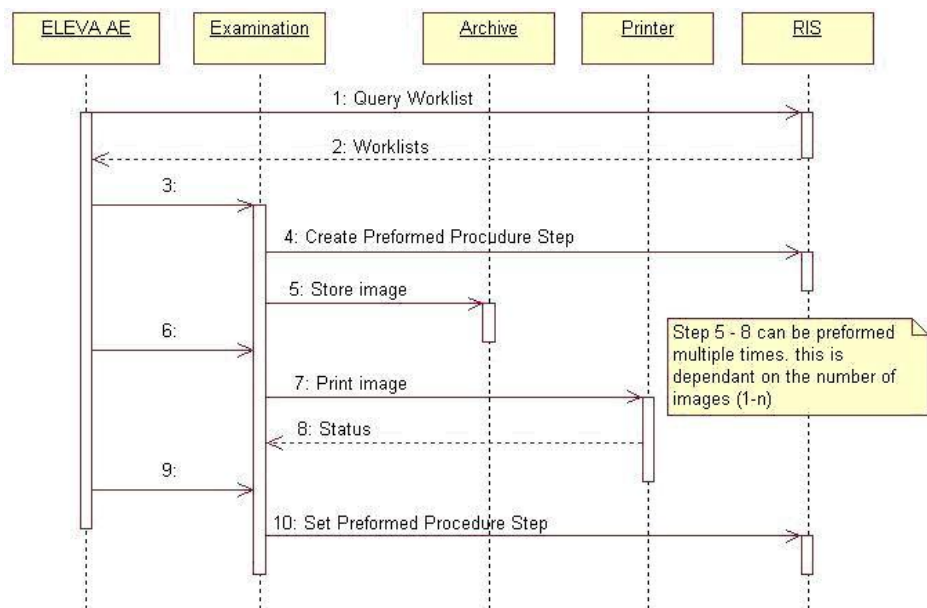

Figure 3: Sequence of an examination

4.2. AE Specifications

This section in the DICOM Conformance Statement is a set of application entity specifications. There are as many of these subsections as there are different AE's in the implementation.

4.2.1. Eleva

Detail of this specific Application Entity is specified in this section.

4.2.1.1. SOP Classes

This Application Entity provides Standard Conformance to the following SOP Classes.

Table 4: SOP Classes for Eleva

SOP Class Name	SOP Class UID	SCU	SCP
Computed Radiography Image Storage SOP Class	1.2.840.10008.5.1.4.1.1.1	Yes	No
Digital Mammography X-Ray Image Storage - Pres. SOP	1.2.840.10008.5.1.4.1.1.1.2	Yes	No
Digital Mammography X-Ray Image Storage - Proc. SOP	1.2.840.10008.5.1.4.1.1.1.2.1	Yes	No
Digital X-Ray Image Storage - For Pres. SOP	1.2.840.10008.5.1.4.1.1.1.1	Yes	No
Digital X-Ray Image Storage - For Proc. SOP	1.2.840.10008.5.1.4.1.1.1.1.1	Yes	No
Modality Performed Procedure Step SOP Class	1.2.840.10008.3.1.2.3.3	Yes	No
Modality Worklist Information Model - FIND SOP Class	1.2.840.10008.5.1.4.31	Yes	No
Secondary Capture Image Storage SOP Class	1.2.840.10008.5.1.4.1.1.7	Yes	No
Storage Commitment Push Model SOP Class	1.2.840.10008.1.20.1	Yes	No
Verification SOP Class	1.2.840.10008.1.1	No	Yes
Basic Grayscale Print Management Meta SOP Class	1.2.840.10008.5.1.1.9	Yes	No
>Basic Film Box SOP Class	1.2.840.10008.5.1.1.2	Yes	No
>Basic Film Session SOP Class	1.2.840.10008.5.1.1.1	Yes	No
>Basic Grayscale Image Box SOP Class	1.2.840.10008.5.1.1.4	Yes	No
>Printer SOP Class	1.2.840.10008.5.1.1.16	Yes	No

Note: Any SOP specific behavior is documented later in the conformance statement in the applicable SOP specific conformance section.

4.2.1.2. Association Policies

Each AE specification contains a description of the general association establishment and acceptance policies of the AE.

4.2.1.2.1. General

The DICOM standard application context has specified.

Table 5: DICOM Application Context

Description	Value
Application Context Name	1.2.840.10008.3.1.1.1

4.2.1.2.2. Number of Associations

The number of simultaneous associations that an Application Entity may support as a Initiator or Acceptor is specified.

Table 6: Number of associations as an Association Initiator for this AE

Description	Value
Maximum number of simultaneous associations	2

Table 7: Number of associations as an Association Acceptor for this AE

Description	Value
Maximum number of simultaneous associations	1

4.2.1.2.3. Asynchronous Nature**Table 8: Asynchronous nature as an Association Initiator for this AE**

Description	Value
Maximum number of outstanding asynchronous transactions	0

Asynchronous nature as an association Initiator is not supported by the Eleva AE.

4.2.1.2.4. Implementation Identifying Information

The value supplied for Implementation Class UID and version name are documented here.

Table 9: DICOM Implementation Class and Version for Eleva

Implementation Class UID	1.3.46.670589.30.1.6
Implementation Version Name	PMS_ELEVA_PA_2.4

4.2.1.2.5. Communication Failure Handling

The behavior of the AE during communication failure is summarized in next table.

Table 10: Communication Failure Behavior

Exception	Behavior
Timeout	The Association is aborted using A-ABORT and command marked as failed. The reason is logged and reported to the user.
Association aborted	The command is marked as failed. The reason is logged and reported to the user.
RIS query timeout(default 240 seconds)	The association is aborted using A-ABORT and command marked as failed. The reason is logged and reported to the user.

4.2.1.3. Association Initiation Policy

The Application Entity will response on a received reject Association attempts as shown in next table.

Table 11: Association Rejection response

Result	Source	Reason/Diagnosis	Explanation
1 - rejected-permanent	1 - DICOM UL service-user	1 - no-reason-given	Association is not established. The following error is logged. Association rejected by peer (1: REJECT_RESULT_permanent,1: REJECT_SOURCE_dul_user,1: REJECT_REASON_no_reason_given)
		2 - applicaton-context-name-not supported	Association is not established. The following error is logged. Association rejected by peer (1: REJECT_RESULT_permanent, 1: REJECT_SOURCE_dul_user, 2: REJECT_RESON_application_context_not_support)
		3 - calling-AE-title-not-recognized	Association is not established. The following error is logged. Association rejected by peer (1: REJECT_RESULT_permanent, 1: REJECT_SOURCE_dul_user, 3: REJECT_REASON_calling_aetitle_not_recognized)
		7 - called-AE-title-not-recognized	Association is not established. The following error is logged. Association rejected by peer (1: REJECT_RESULT_permanent, 1: REJECT_SOURCE_dul_user, 7: REJECT_REASON_called_aetitle_not_recognized)
	2 - DICOM UL service-provider (ACSE related function)	1 - no-reason-given	Association is not established. The following error is logged. Error: UserRecoverable: impl.dicom.access.PEER: Association rejected by peer (1: REJECT_RESULT_permanent, 2: REJECT_SOURCE_dul_provider (acse), 1: REJECT_REASON_no_reason_given)
		2 - protocol-version-not-supported	Association is not established. The following error is logged. Association rejected by peer (1: REJECT_RESULT_permanent, 2: REJECT_SOURCE_dul_provider (acse), 2: REJECT_REASON_application_context_not_support)
	3 - DICOM UL service-provider(Presentation related function)	1 - tempory-congestion	Association is not established. The following error is logged. Association rejected by peer (1: REJECT_RESULT_permanent, 3: REJECT_SOURCE_dul_provider (presentation), 1: REJECT_REASON_no_reason_given)
		2 - Local-limit-exceeded	Association is not established. The following error is logged. Association rejected by peer (1: REJECT_RESULT_permanent, 3: REJECT_SOURCE_dul_provider (presentation), 2: REJECT_REASON_application_context_not_support)
2 - rejected-transient	1 - DICOM UL service-user	1 - no-reason-given	Association is not established. The following error is logged. Association rejected by peer (2: REJECT_RESULT_transient, 1: REJECT_SOURCE_dul_user, 1: REJECT_REASON_no_reason_given)

Result	Source	Reason/Diagnosis	Explanation
		2 - application-context-name-not-supported	Association is not established. The following error is logged. Association rejected by peer (2: REJECT_RESULT_transient, 1: REJECT_SOURCE_dul_user, 2: REJECT_REASON_application_context_not_support)
		3 - calling-AE-title-not-recognized	Association is not established. The following error is logged. Association rejected by peer (2: REJECT_RESULT_transient, 1: REJECT_SOURCE_dul_user, 3: REJECT_REASON_calling_aetitle_not_recognized)
		7 - called-AE-title-not-recognized	Association is not established. The following error is logged. Association rejected by peer (2: REJECT_RESULT_transient, 1: REJECT_SOURCE_dul_user, 7: REJECT_REASON_called_aetitle_not_recognized)
	2 - DICOM UL service-provider (ACSE related function)	1 - no-reason-given	Association is not established. The following error is logged. Association rejected by peer (2: REJECT_RESULT_transient, 2: REJECT_SOURCE_dul_provider (acse), 1: REJECT_REASON_no_reason_given)
		2 - protocol-version-not-supported	Association is not established. The following error is logged. Association rejected by peer (2: REJECT_RESULT_transient, 2: REJECT_SOURCE_dul_provider (acse), 2: REJECT_REASON_application_context_not_support)
	3 - DICOM UL service-provider (Presentation related function)	1 - temporary congestion	Association is not established. The following error is logged. Association rejected by peer (2: REJECT_RESULT_transient, 3: REJECT_SOURCE_dul_provider (presentation), 1: REJECT_REASON_no_reason_given)
		2 - local-limit-exceeded	Association is not established. The following error is logged. Association rejected by peer (2: REJECT_RESULT_transient, 3: REJECT_SOURCE_dul_provider (presentation), 2: REJECT_REASON_application_context_not_support)

The behavior of the AE on receiving an association abort is summarized in next table.

Table 12: Association Abort Handling

Source	Reason/Diagnosis	behavior
0 - DICOM UL service-user (initiated abort)	0 - reason-not-specified	When received, the PCR Eleva terminates the connection with the following log: Association ABORTED by peer (0: ABORT_SOURCE_dul_user,0: ABORT_REASON_not_specified).
2 - DICOM UL service-provider (initiated abort)	0 - reason-not-specified	When received, the PCR Eleva terminates the connection with the following log: Association ABORTED by peer (2: ABORT_SOURCE_dul_provider, 0: ABORT_REASON_not_specified).

Source	Reason/Diagnosis	behavior
	1- unrecognized-PDU	When received, the PCR Eleva terminates the connection with the following log: Association ABORTED by peer (2: ABORT_SOURCE_dul_provider, 1: ABORT_REASON_unrecognized_pdu).
	2 - unexpected-PDU	When received, the PCR Eleva terminates the connection with the following log: Association ABORTED by peer 2: ABORT_SOURCE_dul_provider, 2: ABORT_REASON_unexpected_pdu).
	4 - unrecognized-PDU parameter	When received, the PCR Eleva terminates the connection with the following log: Association ABORTED by peer (2: ABORT_SOURCE_dul_provider, 4: ABORT_REASON_unrecognized_pdu_parameter).
	5 - unexpecte-PDU parameter	When received, the PCR Eleva terminates the connection with the following log: Association ABORTED by peer (2: ABORT_SOURCE_dul_provider, 5: ABORT_REASON_unexpected_pdu_parameter).
	6 - invalid-PDU-parameter value	When received, the PCR Eleva terminates the connection with the following log: Association ABORTED by peer (2: ABORT_SOURCE_dul_provider, 6: ABORT_REASON_invalid_pdu_parameter).

4.2.1.3.1. (Real-World) Activity – Modality worklist as SCU

4.2.1.3.1.1. Description and Sequencing of Activities

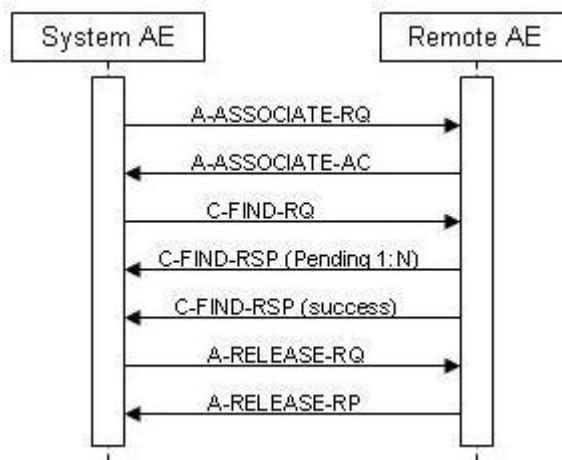

Figure 4: (Real World) Activity - Modality worklist as SCU

For each Broad or specific Worklist request, an association towards the Basic Worklist Management SCP is established and a C-FIND request is transmitted. The Broad query can be configured with a combination of the Matching Keys:

- Scheduled Station AE Title
- Scheduled Procedure Step Start Date
- Modality

Each of the matching keys is optional. The association will be closed on reception of the last C-FIND response. The Worklist Query result is displayed in the Patient List. The query is interruptible if it was triggered by the user.

After clicking the Query Worklist button the ELEVA AE shall request an association

with the configured remote Basic Worklist Management SCP. When the association is accepted the ELEVA AE shall send the broad query find request, wait for response, and then release the association.

This RWA may be initiated in two ways.

After clicking the Query Worklist button the ELEVA AE shall request an association with the configured remote Basic Worklist Management SCP. When the association is accepted the ELEVA AE shall send the Broad Query find request, wait for response, and then release the association.

After clicking the Patient Query button - entering and confirming the matching key values - the ELEVA AE shall request an association with the configured remote Basic Worklist Management SCP. When the association is accepted the ELEVA AE shall send the patient query find request, wait for response, and then release the association.

Optionally the Broad Query may also be performed automatically in the system background. The time interval between subsequent background queries is configurable. Manual and automatic background queries are serialized and do not interfere with another.

4.2.1.3.1.2. Proposed Presentation Contexts

The presentation contexts are defined in next table.

Table 13: Proposed Presentation Contexts for (Real-World) Activity – Modality worklist As SCU

Presentation Context Table					
Abstract Syntax		Transfer Syntax		Role	Extended Negotiation
Name	UID	Name List	UID List		
Modality Worklist Information Model - FIND SOP Class	1.2.840.10008.5.1.4.31	Implicit VR Little Endian	1.2.840.10008.1.2	SCU	None
		Explicit VR Big Endian	1.2.840.10008.1.2.2		
		Explicit VR Little Endian	1.2.840.10008.1.2.1		

4.2.1.3.1.3. SOP Specific Conformance for Modality Worklist Information Model - FIND SOP Class

This section and sub-section includes the manufacturer SOP and Dataset specific information as well the status codes and their corresponding behavior.

4.2.1.3.1.3.1. Dataset Specific Conformance for Modality Worklist (Patient query) C-FIND SCU

Detail regarding the Dataset Specific response behavior will be reported in this section. The table below should be read as follows:

- Attribute Name: Attributes supported to build a Modality Worklist Request Identifier.
- Tag: DICOM tag for this attribute.
- VR: DICOM VR for this attribute.
- M: Matching Keys for (automatic) Worklist Update.
- R: Return Keys. An "X" will indicate that this attribute as Return Key with zero length for Universal Matching.
- Q: Interactive Query Key. An "X" will indicate that this attribute as matching key can be used.

D: Displayed Keys. An "X" indicates that this Worklist attribute is displayed to the user during a patient registration dialog.

IOD: An "X" indicates that this Worklist attribute is included into all object Instances created during performance of the related Procedure Step.

Type of matching: The following types of matching exists:
 Single Value Matching
 List of UID Matching
 Wild Card Matching
 Range Matching
 Sequence Matching
 Universal Matching

Table 14: Worklist Request Identifier

Attribute Name	Tag	VR	M	R	Q	D	IOD	Type of Matching	Comment
SOP Common Module									
Specific Character Set	0008,0005	CS							
Patient Identification Module									
Issuer of Patient ID	0010,0021	LO		X					
Other Patient IDs	0010,1000	LO		X					
Patient ID	0010,0020	LO	X	X	X	X		Single Value, Universal	
Patient's Name	0010,0010	PN	X	X	X	X		Single Value, Universal, WildCard	
Patient Demographic Module									
Confidentiality Constraint on Patient Data Description	0040,3001	LO							
Ethnic Group	0010,2160	SH		X		X			
Patient Comments	0010,4000	LT		X		X			
Patient's Age	0010,1010	AS							
Patient's Birth Date	0010,0030	DA		X		X			
Patient's Sex	0010,0040	CS		X		X			
Patient's Size	0010,1020	DS		X		X			
Patient's Weight	0010,1030	DS		X		X			
Patient Medical Module									
Additional Patient History	0010,21B0	LT		X		X			
Contrast Allergies	0010,2110	LO		X		X			
Medical Alerts	0010,2000	LO		X		X			
Pregnancy Status	0010,21C0	US		X		X			
Special Needs	0038,0050	LO		X					
Visit Status Module									
Current Patient Location	0038,0300	LO		X					
Scheduled Procedure Step Module									
Scheduled Procedure Step Sequence	0040,0100	SQ		X					
>Comments on the Scheduled Procedure Step	0040,0400	LT		X					
>Modality	0008,0060	CS	X	X	X			Single Value, Universal	SOP Classes: CR, DX, OT, US, MG, RF, XA, PX, NM
>Pre-Medication	0040,0012	LO		X					
>Requested Contrast Agent	0032,1070	LO		X					
>Scheduled Performing Physician's Name	0040,0006	PN		X					
>Scheduled Procedure Step Description	0040,0007	LO		X		X			
>Scheduled Procedure Step End Date	0040,0004	DA		X					

Attribute Name	Tag	VR	M	R	Q	D	IOD	Type of Matching	Comment
>Scheduled Procedure Step End Time	0040,0005	TM		X					
>Scheduled Procedure Step ID	0040,0009	SH		X					
>Scheduled Procedure Step Location	0040,0011	SH		X					
>Scheduled Procedure Step Start Date	0040,0002	DA	X	X	X	X		Single Value, Universal	Value: All, Today, Tomorrow, Yesterday
>Scheduled Procedure Step Start Time	0040,0003	TM		X		X			
>Scheduled Procedure Step Status	0040,0020	CS		X					
>Scheduled Station AE Title	0040,0001	AE	X	X	X			Single Value, Universal	
>Scheduled Station Name	0040,0010	SH		X					
>Scheduled Protocol Code Sequence	0040,0008	SQ		X					
>>Code Meaning	0008,0104	LO		X					
>>Code Value	0008,0100	SH		X					
>>Coding Scheme Designator	0008,0102	SH		X					
>>Coding Scheme Version	0008,0103	SH		X					
Requested Procedure Module									
Names of Intended Recipients of Results	0040,1010	PN							
Patient Transport Arrangements	0040,1004	LO							
Reason for the Requested Procedure	0040,1002	LO							
Requested Procedure Comments	0040,1400	LT							
Requested Procedure Description	0032,1060	LO		X		X			
Requested Procedure ID	0040,1001	SH	X					Single Value, Universal	
Requested Procedure Priority	0040,1003	SH							
Study Instance UID	0020,000D	UI		X					
Referenced Study Sequence	0008,1110	SQ		X					
>Referenced SOP Class UID	0008,1150	UI		X					
>Referenced SOP Instance UID	0008,1155	UI		X					
Requested Procedure Code Sequence	0032,1064	SQ		X					
>Code Meaning	0008,0104	LO		X					
>Code Value	0008,0100	SH		X					
>Coding Scheme Designator	0008,0102	SH		X					
>Coding Scheme Version	0008,0103	SH		X					
Imaging Service Request Module									
Accession Number	0008,0050	SH	X	X	X	X		Single Value, Universal	
Imaging Service Request Comments	0040,2400	LT							
Issue Date of Imaging Service Request	0040,2004	DA							
Reason for the Imaging Service Request (RETIRED)	0040,2001	LO		X					
Referring Physician's Name	0008,0090	PN		X					
Requesting Physician	0032,1032	PN		X					
Requesting Service	0032,1033	LO							

This part of the section includes the dataset specific behavior, i.e. error codes, error and exception handling, time-outs, etc.

Table 15: Status Response

Service Status	Code	Further Meaning	Behavior
Success	0000	Matching is complete	The worklist is updated.
Failure	A700	Refused – Out of resources	The association is released. The reason is logged.
	A900	Failed – Identifier does not match SOP class	The association is released. The reason is logged.
	Cxxx	Failed – Unable to process	The association is released. The reason is logged.
Cancel	FE00	Matching terminated due to Cancel request	The association is released. The reason is logged.
Pending	FF00	Matches are continuing – Current match is supplied and any optional keys were supported in the same manner as required keys	The Query Worklist job continues.
	FF01	Matches are continuing – Warning that one or more optional keys were not supported for existence and/or matching for this identifier	The Query Worklist job continues.

4.2.1.3.1.3.2. Patient and Study Merge

The ELEVA AE looks in its internal database for a Study with the same Study Instance UID (0020,000D) as given in the Scheduled Procedure Step.

If a Study Instance UID match was not found, it looks for a Patient with the same Patient ID (0010,0020) as given in the Scheduled Procedure Step. If no Patient match is found, a new Patient is created, using attributes from Scheduled Procedure Step. If Patient with a matching Patient ID was found, attributes are updated for the internal Patient, based on the attributes as given in the Scheduled Procedure Step. A new Study with a Study Instance UID as given in the Scheduled Procedure Step is created.

If a Study Instance UID match was found, all Patient attributes as given in the Scheduled Procedure Step are updated in the internal database for the parent patient of this study. Study attributes are updated for the internal study based on the attributes as given in the Scheduled Procedure Step.

4.2.1.3.1.3.3. Scheduled Procedure Step (= Examination) Merge

If the ELEVA AE's internal database contains no SPS with Scheduled Procedure Step ID (0040,0009) identifying an incoming Scheduled Procedure Step, it creates a new one and creates an corresponding Examination referencing this Scheduled Procedure Step ID.

If the ELEVA AE's internal database contains already an SPS with the Scheduled Procedure Step ID (0040,0009) identifying an incoming Scheduled Procedure Step, the behavior depends on the corresponding Examination state.

If the Examination is still "scheduled", the SPS attributes are compared to the attributes sent with the most recent WLM query. If at least one attribute differs, the scheduled Examination is deleted and re-scheduled. Manual changes the user might have performed on this Examination are lost.

If the Examination has already started, no changes are performed, and the potential changes of the incoming Scheduled Procedure Step are disregarded.

4.2.1.3.1.3.4. Dataset Specific Conformance for Modality Worklist (Broadcast Query) C-FIND SCU

Detail regarding the Dataset Specific response behavior will be reported in this section. The table below should be read as follows:

- Attribute Name: Attributes supported to build a Modality Worklist Request Identifier.
 - Tag: DICOM tag for this attribute.
 - VR: DICOM VR for this attribute.
 - M: Matching Keys for (automatic) Worklist Update.
 - R: Return Keys. An "X" will indicate that this attribute as Return Key with zero length for Universal Matching.
 - Q: Interactive Query Key. An "X" will indicate that this attribute as matching key can be used.
 - D: Displayed Keys. An "X" indicates that this Worklist attribute is displayed to the user during a patient registration dialog.
 - IOD: An "X" indicates that this Worklist attribute is included into all object Instances created during performance of the related Procedure Step.
- Type of matching: The following types of matching exists:
- Single Value Matching
 - List of UID Matching
 - Wild Card Matching
 - Range Matching
 - Sequence Matching
 - Universal Matching

Table 16: Worklist Request Identifier

Attribute Name	Tag	VR	M	R	Q	D	IOD	Type of Matching	Comment
SOP Common Module									
Specific Character Set	0008,0005	CS							
Patient Identification Module									
Issuer of Patient ID	0010,0021	LO							
Other Patient IDs	0010,1000	LO							
Patient ID	0010,0020	LO				X			
Patient's Name	0010,0010	PN				X			Last name, First name, Prefix, Middle name, Suffix
Patient Demographic Module									
Confidentiality Constraint on Patient Data Description	0040,3001	LO							
Ethnic Group	0010,2160	SH							
Patient Comments	0010,4000	LT							
Patient's Age	0010,1010	AS							
Patient's Birth Date	0010,0030	DA				X			
Patient's Sex	0010,0040	CS				X			
Patient's Size	0010,1020	DS							
Patient's Weight	0010,1030	DS				X			
Patient Medical Module									
Additional Patient History	0010,21B0	LT							
Contrast Allergies	0010,2110	LO							
Medical Alerts	0010,2000	LO				X			
Pregnancy Status	0010,21C0	US				X			
Special Needs	0038,0050	LO							

Attribute Name	Tag	VR	M	R	Q	D	IOD	Type of Matching	Comment
Visit Status Module									
Current Patient Location	0038,0300	LO							
Scheduled Procedure Step Module									
Scheduled Procedure Step Sequence	0040,0100	SQ							
>Comments on the Scheduled Procedure Step	0040,0400	LT							
>Modality	0008,0060	CS							
>Pre-Medication	0040,0012	LO							
>Requested Contrast Agent	0032,1070	LO							
>Scheduled Performing Physician's Name	0040,0006	PN				X			
>Scheduled Procedure Step Description	0040,0007	LO							
>Scheduled Procedure Step End Date	0040,0004	DA							
>Scheduled Procedure Step End Time	0040,0005	TM							
>Scheduled Procedure Step ID	0040,0009	SH							
>Scheduled Procedure Step Location	0040,0011	SH							
>Scheduled Procedure Step Start Date	0040,0002	DA							
>Scheduled Procedure Step Start Time	0040,0003	TM							
>Scheduled Procedure Step Status	0040,0020	CS							
>Scheduled Station AE Title	0040,0001	AE							
>Scheduled Station Name	0040,0010	SH							
>Scheduled Protocol Code Sequence	0040,0008	SQ							
>>Code Meaning	0008,0104	LO							
>>Code Value	0008,0100	SH							
>>Coding Scheme Designator	0008,0102	SH							
>>Coding Scheme Version	0008,0103	SH							
Requested Procedure Module									
Names of Intended Recipients of Results	0040,1010	PN							
Patient Transport Arrangements	0040,1004	LO							
Reason for the Requested Procedure	0040,1002	LO							
Requested Procedure Comments	0040,1400	LT							
Requested Procedure Description	0032,1060	LO							
Requested Procedure ID	0040,1001	SH							
Requested Procedure Priority	0040,1003	SH							
Study Instance UID	0020,000D	UI							
Referenced Study Sequence	0008,1110	SQ							
>Referenced SOP Class UID	0008,1150	UI							
>Referenced SOP Instance UID	0008,1155	UI							
Requested Procedure Code Sequence	0032,1064	SQ							
>Code Meaning	0008,0104	LO							
>Code Value	0008,0100	SH							
>Coding Scheme Designator	0008,0102	SH							
>Coding Scheme Version	0008,0103	SH							
Imaging Service Request Module									
Accession Number	0008,0050	SH				X			

Attribute Name	Tag	VR	M	R	Q	D	IOD	Type of Matching	Comment
Imaging Service Request Comments	0040,2400	LT							
Issue Date of Imaging Service Request	0040,2004	DA							
Reason for the Imaging Service Request (RETIRED)	0040,2001	LO							
Referring Physician's Name	0008,0090	PN				X			
Requesting Physician	0032,1032	PN				X			
Requesting Service	0032,1033	LO							

This part of the section includes the dataset specific behavior, i.e. error codes, error and exception handling, time-outs, etc.

Table 17: Status Response

Service Status	Code	Further Meaning	Behavior
Success	0000	Matching is complete	The worklist is updated.
Failure	A700	Refused – Out of resources	The association is released. The reason is logged.
	A900	Failed – Identifier does not match SOP class	The association is released. The reason is logged.
	Cxxx	Failed – Unable to process	The association is released. The reason is logged.
Cancel	FE00	Matching terminated due to Cancel request	The association is released. The reason is logged.
Pending	FF00	Matches are continuing – Current match is supplied and any optional keys were supported in the same manner as required keys	The Query Worklist job continues.
	FF01	Matches are continuing – Warning that one or more optional keys were not supported for existence and/or matching for this identifier	The Query Worklist job continues.

4.2.1.3.1.3.5. Dataset Specific Conformance for Modality Worklist Information Model - FIND C-CANCEL SCU

Detail regarding the Dataset Specific response behavior will be reported in this section.

There is no specific DICOM information available for the C-CANCEL dataset.

4.2.1.3.2. (Real-World) Activity – Modality Performed Procedure Step As SCU

4.2.1.3.2.1. Description and Sequencing of Activities

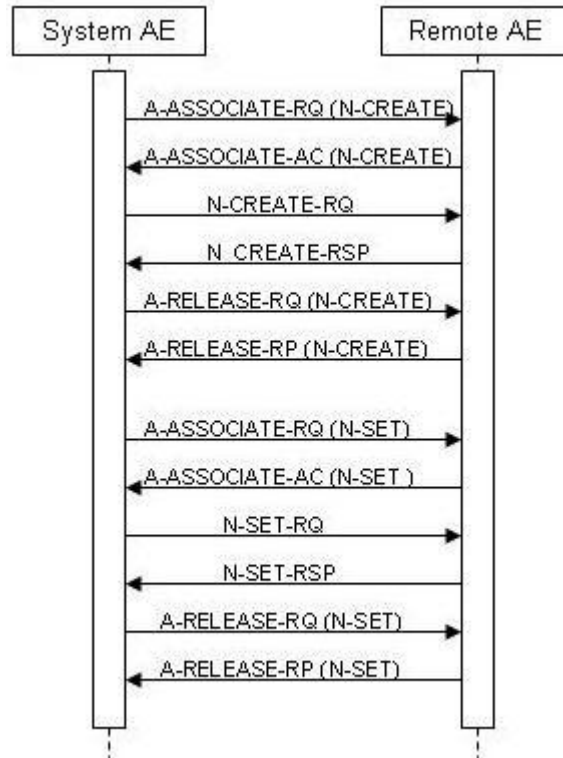

Figure 5: (Real World) Activity - Modality Performed Procedure Step as SCU

Description of Activities

An PCR Eleva "Examination" is regarded equivalent to a DICOM Procedure Step. It is scheduled or manually entered before an acquisition is taken, and performed by taking acquisitions. If scheduled by the RIS, one Examination is the result of one Scheduled Procedure Step. Since an examination may not be re-opened after having been closed, and each examination workflow context is enclosed in one MPPS, one examination may result in 0:1 MPPS instances. However, image archiving after the examination's closure leads to 1:n MPPS instances per examination (append case).

After the image for a Scheduled Procedure Step has been acquired, the system sets the MPPS status of the related examination to "IN PROGRESS" and generates an initial MPPS IN PROGRESS message. The system does not generate intermediate MPPS IN PROGRESS messages for subsequent acquisitions of this Scheduled Procedure Step instance.

After finishing the appropriate acquisition(s), the system will change the MPPS status of the related examination to "COMPLETED" and generate an MPPS N-SET-FINAL message.

PCR Eleva also generates MPPS messages for unscheduled examinations.

The MPPS COMPLETED message will list the UID's of all related DICOM archived images and the format of (optionally) generated direct prints.

After abandoning or discontinuing a procedure step, the operator may set the MPPS status of the related examination to "DISCONTINUED" and the system generates a MPPS DISCONTINUED message. The reason for abandoning or discontinuing a

procedure step is unspecified.

The operator may interchange the performed sequence order of scheduled procedure steps.

MPPS messages may interleave. Depending on the application workflow optimization by the user, an MPPS sequence like this may come up:

MPPS / SOP Instance UID 1: N-CREATE (IN PROGRESS)
 MPPS / SOP Instance UID 2: N-CREATE (IN PROGRESS)
 MPPS / SOP Instance UID 3: N-CREATE (IN PROGRESS)
 ...
 MPPS / SOP Instance UID 2: N-SET (COMPLETED)
 MPPS / SOP Instance UID 1: N-SET (COMPLETED)
 MPPS / SOP Instance UID 3: N-SET (COMPLETED)
 (i.e.: running multiple procedure steps 'in parallel').

Sequencing of Activities

After storing a performed procedure step the ELEVA AE shall request an association with the configured remote Study Management SCP. After accepting the association the ELEVA AE shall send a Create request, wait for response, and then release the association.

4.2.1.3.2.2. Proposed Presentation Contexts

The presentation contexts are defined in next table.

Table 18: Proposed Presentation Contexts for (Real-World) Activity – Modality Performed Procedure Step As SCU

Presentation Context Table					
Abstract Syntax		Transfer Syntax		Role	Extended Negotiation
Name	UID	Name List	UID List		
Modality Performed Procedure Step SOP Class	1.2.840.10008.3.1.2.3.3	Implicit VR Little Endian	1.2.840.10008.1.2	SCU	None
		Explicit VR Big Endian	1.2.840.10008.1.2.2		
		Explicit VR Little Endian	1.2.840.10008.1.2.1		

4.2.1.3.2.3. SOP Specific Conformance for Modality Performed Procedure Step SOP Class

This section and sub-section includes the manufacturer SOP and Dataset specific information as well the status codes and their corresponding behavior. When acquiring the first image of a Scheduled or Unscheduled Procedure Step, PCR Eleva generates a MPPS IN PROGRESS message. PCR Eleva does not generate intermediate IN PROGRESS (N-SET) messages and does not support the Performed Procedure Step Exception Management Option. PCR Eleva has no Billing Code Tables and does not support the Performed Procedure Step Billing and Material Management Option, except default values for Medium Type (2000,0030) and Film Size ID (2010,0050), if optional Local Print is configured.

Assisted Acquisition Protocol Setting Option

ELEVA AE by default derives the specific acquisition protocol from the Scheduled Protocol Code Sequence Items. Any single Item results in an Examination. ELEVA AE supports 3 more (configurable) mapping relations, as shown below:

- Examination is selected from Scheduled Protocol Code Items->Code Value (0040,0008) (default)

- Examination is selected from Scheduled Procedure Step Description (0040,0007)
- Examination is selected from Requested Procedure Code Items->Code Value (0032,1064)
- Examination is selected from Requested Procedure Description (0032,1060)

ELEVA AE does not evaluate the attributes Coding Scheme Version (0008,0103), Coding Scheme Designator (0008,0102), Code Meaning (0008,0104), but only the Code Value (0008,0100), for mapping the examination settings. I.e. ELEVA AE expects that any used Code Value is unique (unambiguous) within a given RIS domain.

Restrictions Depending on Number of Scheduled Protocol Code Items

It is highly recommended that the Scheduled Procedure Step contains only 1 Item in the Scheduled Protocol Code Sequence.

If the Scheduled Procedure Step contains <n> items in the Scheduled Protocol Code Sequence, the Scheduled Procedure Step is split into <n> examinations, where any single examination shows only 1 of the Scheduled Protocol Code Items, but all the other attributes are the same.

When such an examination is returned back via MPPS, also the Performed Protocol Code Sequence will show only 1 item. If all <n> Scheduled Procedure Step Code Items are performed, <n> MPPS instances will be sent back to the RIS, and the sum of all Performed Protocol Code Items will be <n>.

4.2.1.3.2.3.1. Dataset Specific Conformance for Modality Performed Procedure Step N-CREATE SCU

Detail regarding the Dataset Specific response behavior will be reported in this section.

Table 19: MPPS Request Identifiers for N-CREATE-RQ

Attribute Name	Tag	VR	Value	Comment
Performed Procedure Step Information Module				
Performed Location	0040,0243	SH		EMPTY
Performed Procedure Step Description	0040,0254	LO		
Performed Procedure Step End Date	0040,0250	DA		Finish of the examination
Performed Procedure Step End Time	0040,0251	TM		Finish of the examination
Performed Procedure Step ID	0040,0253	SH		
Performed Procedure Step Start Date	0040,0244	DA		Start of the examination
Performed Procedure Step Start Time	0040,0245	TM		Start of the examination
Performed Procedure Step Status	0040,0252	CS		
Performed Procedure Type Description	0040,0255	LO		
Performed Station AE Title	0040,0241	AE	Eleva	
Performed Station Name	0040,0242	SH		EMPTY
Procedure Code Sequence	0008,1032	SQ		
>Code Meaning	0008,0104	LO		
>Code Value	0008,0100	SH		
>Coding Scheme Designator	0008,0102	SH		
>Coding Scheme Version	0008,0103	SH		
Radiation Dose Module				
Entrance Dose	0040,0302	US		

Attribute Name	Tag	VR	Value	Comment
Image and Fluoroscopy Area Dose Product	0018,115E	DS		Hot sent in case of appended MPPS Instances
Total Number of Exposures	0040,0301	US		
Total Time of Fluoroscopy	0040,0300	US		
Exposure Dose Sequence	0040,030E	SQ		
SOP Common Module				
Specific Character Set	0008,0005	CS		Optional
Performed Procedure Step Relationship Module				
Patient ID	0010,0020	LO		
Patient's Birth Date	0010,0030	DA		
Patient's Name	0010,0010	PN		
Patient's Sex	0010,0040	CS		
Referenced Patient Sequence	0008,1120	SQ		
Scheduled Step Attributes Sequence	0040,0270	SQ		
>Accession Number	0008,0050	SH		
>Requested Procedure Description	0032,1060	LO		
>Requested Procedure ID	0040,1001	SH		
>Scheduled Procedure Step Description	0040,0007	LO		
>Scheduled Procedure Step ID	0040,0009	SH		
>Study Instance UID	0020,000D	UI		
>Referenced Study Sequence	0008,1110	SQ		
>>Referenced SOP Class UID	0008,1150	UI		
>>Referenced SOP Instance UID	0008,1155	UI		
>Scheduled Protocol Code Sequence	0040,0008	SQ		
>>Code Meaning	0008,0104	LO		
>>Code Value	0008,0100	SH		
>>Coding Scheme Designator	0008,0102	SH		
Image Acquisition Results Module				
Modality	0008,0060	CS		
Study ID	0020,0010	SH		
Performed Protocol Code Sequence	0040,0260	SQ		
>Code Meaning	0008,0104	LO		
>Code Value	0008,0100	SH		
>Coding Scheme Designator	0008,0102	SH		
>Coding Scheme Version	0008,0103	SH		
Performed Series Sequence	0040,0340	SQ		
Billing And Material Management Code Module				
Film Consumption Sequence	0040,0321	SQ		
Additional Module				
Issuer of Patient ID	0010,0021	LO		

This part of the section includes the dataset specific behavior, i.e. error codes, error and exception handling, time-outs, etc.

Table 20: Status Response

Service Status	Code	Further Meaning	Behavior
Success	0000	Successful operation	The SCP has successfully received the modality performed procedure step create request. Log entry.
Failure	0213	Resource limitation	The command is reported to the user as failed. The reason is logged. After a configured period of time the storage will be retried up to a configured number of times.
	xxxx	Any failure accept	The command is reported to the user as failed. The reason is logged. No retry.

4.2.1.3.2.3.2. Dataset Specific Conformance for Modality Performed Procedure Step N-SET SCU

Detail regarding the Dataset Specific response behavior will be reported in this section.

Table 21: MPPS Request Identifiers for N-SET-RQ

Attribute Name	Tag	VR	Value	Comment
Performed Procedure Step Information Module				
Performed Procedure Step Description	0040,0254	LO		
Performed Procedure Step End Date	0040,0250	DA		
Performed Procedure Step End Time	0040,0251	TM		
Performed Procedure Step Status	0040,0252	CS		
Procedure Code Sequence	0008,1032	SQ		
>Code Meaning	0008,0104	LO		
>Code Value	0008,0100	SH		
>Coding Scheme Designator	0008,0102	SH		
Radiation Dose Module				
Entrance Dose	0040,0302	US		
Image and Fluoroscopy Area Dose Product	0018,115E	DS		Not accumulating: re-processed images, non-digital images. Not sent in case of appended MPPS instances.
Total Number of Exposures	0040,0301	US		Not accumulating: re-processed images, non-digital images. Not sent in case of appended MPPS instances.
Total Time of Fluoroscopy	0040,0300	US		
Exposure Dose Sequence	0040,030E	SQ		
Image Acquisition Results Module				
Performed Protocol Code Sequence	0040,0260	SQ		
>Code Meaning	0008,0104	LO		
>Code Value	0008,0100	SH		
>Coding Scheme Designator	0008,0102	SH		
Performed Series Sequence	0040,0340	SQ		
>Operators' Name	0008,1070	PN		N-Values
>Performing Physician's Name	0008,1050	PN		
>Protocol Name	0018,1030	LO		Copied from Perf. Act. Item code Value.

Attribute Name	Tag	VR	Value	Comment
>Retrieve AE Title	0008,0054	AE		
>Series Description	0008,103E	LO		
>Series Instance UID	0020,000E	UI		
>Referenced Image Sequence	0008,1140	SQ		In No-Tome Examinations 1 item only. In Tome-Examinations N items. Missing after conventional acquisition.
>Referenced Non-Image Composite SOP Instance Sequence	0040,0220	SQ		
Billing And Material Management Code Module				
Film Consumption Sequence	0040,0321	SQ		
>Film Size ID	2010,0050	CS		
>Medium Type	2000,0030	CS		
>Number of Films	2100,0170	IS		

This part of the section includes the dataset specific behavior, i.e. error codes, error and exception handling, time-outs, etc.

Table 22: Status Response

Service Status	Code	Further Meaning	Behavior
Success	0000	Confirmation	The association is released.
Failure	0110	Processing failure – performed procedure step object may no longer be updated	The reason is logged.
	xxxx	(any other failure)	The reason is logged.

4.2.1.3.3. (Real-World) Activity – Storage Commitment Push Model AS SCU

4.2.1.3.3.1. Description and Sequencing of Activities

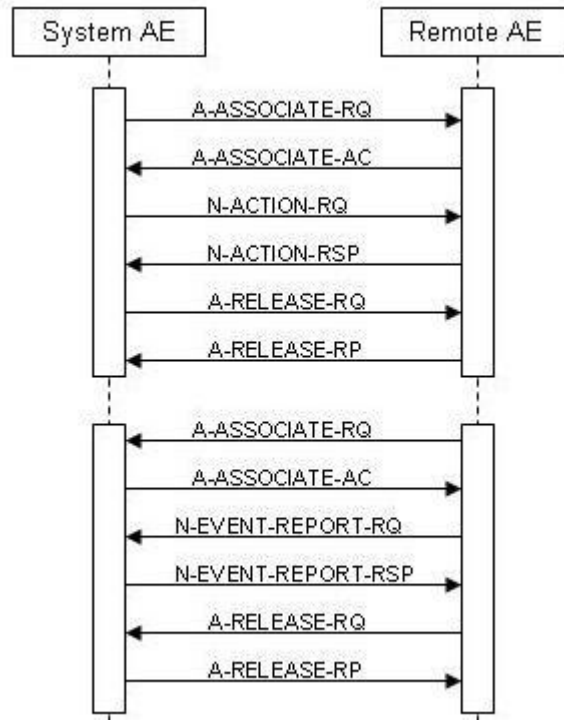

Figure 6: (Real World) Activity - Asynchronous Storage Commitment Push model as SCU

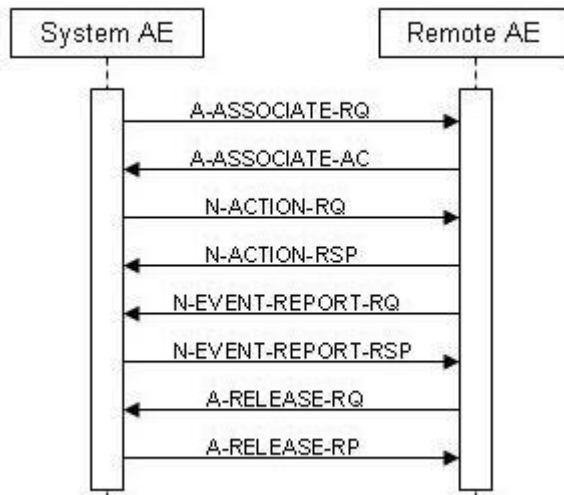

Figure 7: (Real World) Activity - Synchronous Storage Commitment Push model as SCU

Archive means that PCR Eleva stores images with Storage Commitment. This RWA may be initiated in two ways.

- Manually in the viewer, after clicking the Store button the ELEVA AE will store the selected images at the selected Storage SCP.

- Automatically during an examination, after clicking the Confirm button the ELEVA AE will automatically store the related images of the performed procedure step at the configured Storage SCP.

The ELEVA AE will request an association with the remote Storage SCP for the applicable Storage SOP classes. After accepting the association the ELEVA AE will send the store request, wait for response, and then release the association. The store response status may be inspected on the UI. The transferred image shall not be deleted from the system until the Storage Commit N-Event is received.

Depending on the status of the store the ELEVA AE may queue store requests for retries. The queued store requests can be cancelled from the UI.

When an archive supports DICOM Storage Commitment, this node can be configured for it. For each image that is sent to this node, also a Storage Commitment Request is sent. The image is delete-protected until the Storage Commit Response has been received. The current status is shown in the Image Info Panel.

In case of a wrong configuration (an archive is configured to support Storage Commitment, but does not really do so), the MIP component recognizes this, and our application sees a successful Storage Commitment.

4.2.1.3.3.2. Proposed Presentation Contexts

The presentation contexts are defined in next table.

Table 23: Proposed Presentation Contexts for (Real-World) Activity – Storage Commitment Push Model AS SCU

Presentation Context Table					
Abstract Syntax		Transfer Syntax		Role	Extended Negotiation
Name	UID	Name List	UID List		
Storage Commitment Push Model SOP Class	1.2.840.10008.1.20.1	Implicit VR Little Endian	1.2.840.10008.1.2	SCU	None
		Explicit VR Big Endian	1.2.840.10008.1.2.2		
		Explicit VR Little Endian	1.2.840.10008.1.2.1		

4.2.1.3.3.3. SOP Specific Conformance for Storage Commitment Push Model SOP Class

This section and sub-section includes the manufacturer SOP and Dataset specific information as well the status codes and their corresponding behavior.

4.2.1.3.3.3.1. Dataset Specific Conformance for Storage Commitment Push Model N-ACTION SCU

Detail regarding the Dataset Specific response behavior will be reported in this section.

Table 24: Storage Commitment Attribute for N-ACTION-RQ

Attribute Name	Tag	Comment
Storage Commitment Module		
Transaction UID	0008,1195	
Referenced SOP Sequence	0008,1199	
>Referenced SOP Class UID	0008,1150	
>Referenced SOP Instance UID	0008,1155	

This part of the section includes the dataset specific behavior, i.e. error codes, error and exception handling, time-outs, etc.

Table 25: Status Response

Service Status	Code	Further Meaning	Behavior
Success	0000	Storage is complete	UI status is updated
Refused	A7xx	Out of resources	The association is released. The reason is logged. The user is informed.
Error	A9xx	Data set does not match SOP class	The association is released. The reason is logged. The user is informed.
	Cxxx	Cannot understand	The association is released. The reason is logged. The user is informed.
Warning	B000	Coercion of data elements	The association is released. The reason is logged. The user is informed.
	B006	Elements discarded	The association is released. The reason is logged. The user is informed.
	B007	Data set does not match SOP class	The association is released. The reason is logged. The user is informed.

4.2.1.3.3.3.2. Dataset Specific Conformance for Storage Commitment Push Model N-EVENT-REPORT SCP

Detail regarding the Dataset Specific response behavior will be reported in this section.

No specific information available

4.2.1.3.4. (Real-World) Activity – Image Export

4.2.1.3.4.1. Description and Sequencing of Activities

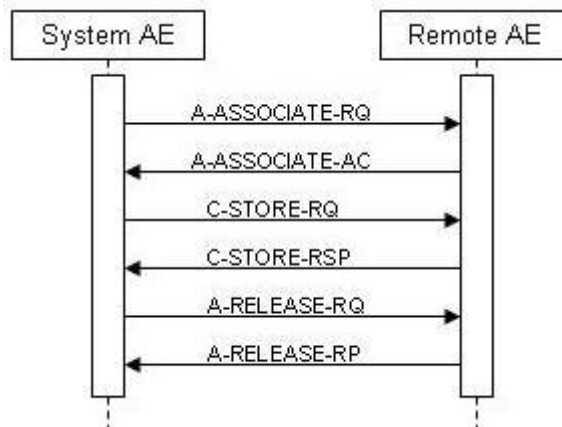

Figure 8: (Real World) Activity - Image Export

Export means that PCR Eleva stores images without Storage Commitment. This RWA may be initiated in two ways.

- Manually in the viewer, after clicking the Store button the ELEVA AE will store the selected images at the selected Storage SCP.
- Automatically during an examination, after clicking the Confirm button the ELEVA AE will automatically store the related images of the performed procedure step at the configured Storage SCP.

The ELEVA AE will request an association with the remote Storage SCP for the applicable Storage SOP classes. After accepting the association the ELEVA AE will send the store request, wait for response, and then release the association. The store response status may be inspected on the UI.

Depending on the status of the store the ELEVA AE may queue store requests for retries. The queued store requests can be cancelled from the UI.

4.2.1.3.4.2. Proposed Presentation Contexts

The presentation contexts are defined in next table.

Table 26: Proposed Presentation Contexts for (Real-World) Activity – Image Export

Presentation Context Table					
Abstract Syntax		Transfer Syntax		Role	Extended Negotiation
Name	UID	Name List	UID List		
Computed Radiography Image Storage SOP Class	1.2.840.10008.5.1.4.1.1.1	Implicit VR Little Endian	1.2.840.10008.1.2	SCU	None
		Explicit VR Big Endian	1.2.840.10008.1.2.2		
		Explicit VR Little Endian	1.2.840.10008.1.2.1		
Digital Mammography X-Ray Image Storage - Pres. SOP	1.2.840.10008.5.1.4.1.1.1.2	Explicit VR Big Endian	1.2.840.10008.1.2.2	SCU	None
		Explicit VR Little Endian	1.2.840.10008.1.2.1		
		Implicit VR Little Endian	1.2.840.10008.1.2		
Digital Mammography X-Ray Image Storage - Proc. SOP	1.2.840.10008.5.1.4.1.1.1.2.1	Explicit VR Big Endian	1.2.840.10008.1.2.2	SCU	None
		Explicit VR Little Endian	1.2.840.10008.1.2.1		
		Implicit VR Little Endian	1.2.840.10008.1.2		
Digital X-Ray Image Storage - For Pres. SOP	1.2.840.10008.5.1.4.1.1.1.1	Explicit VR Big Endian	1.2.840.10008.1.2.2	SCU	None
		Explicit VR Little Endian	1.2.840.10008.1.2.1		
		Implicit VR Little Endian	1.2.840.10008.1.2		
Digital X-Ray Image Storage - For Proc. SOP	1.2.840.10008.5.1.4.1.1.1.1.1	Explicit VR Big Endian	1.2.840.10008.1.2.2	SCU	None
		Explicit VR Little Endian	1.2.840.10008.1.2.1		
		Implicit VR Little Endian	1.2.840.10008.1.2		
Secondary Capture Image Storage SOP Class	1.2.840.10008.5.1.4.1.1.7	Implicit VR Little Endian	1.2.840.10008.1.2	SCU	None
		Explicit VR Big Endian	1.2.840.10008.1.2.2		
		Explicit VR Little Endian	1.2.840.10008.1.2.1		

By default, all images are DICOM Stored according to the SOP Class Digital XRay. CR Image attributes that are undefined for DX Images are stored in private attributes.

As a configurable choice, Images can be stored as Computed Radiology SOP Class. This capability is required to be compatible with installed radiology equipment. DX Image attributes that are undefined for CR Images are then stored in private attributes.

For DICOM CR images there is a constraint that a change in position, detector, body part or laterality implies a new series. This has been relaxed for DX images through the use of the 'DX Anatomy Imaged' and 'DX Positioning' Modules, which define attributes at image level.

The DX Image IOD is used in two SOP Classes as defined in the DICOM Standard, a SOP Class for storage of images intended for Presentation, and a SOP Class for storage of images intended for further Processing before presentation. These are distinguished by their SOP Class UID and by the Enumerated Value of the mandatory Attribute in the DX Series Module, Presentation Intent Type (0008,0068).

Another choice can be DICOM Stored according to Secondary Capture SOP Class. This capability is required to be compatible with installed radiology equipment. Optionally only the attributes defined for Secondary Capture Images or all attributes are stored.

The PCR Eleva Release 1.2 can also create Mammography Images by the Digital Mammography X-Ray Image IOD. Same as the DX Image IOD is this used in two SOP classes. For storage of images intended for Presentation and a SOP Class for storage of images intended for further Processing before presentation. These are distinguished by their SOP Class UID and by the Enumerated Value of the mandatory Attribute in the DX Series Module, Presentation Intent Type (0008,0068).

It is possible to export / store one single image first as a DICOM CR and secondly as a DICOM DX object, therefore the SOP Instance UIDs of both DICOM image instances have to be different.

The Numbering Scheme shall support 'Hanging Protocols' of PACS systems & Viewing Stations, in case of the CR as well as the DX model:

1. The Series Number shall start with 1 for the first Series of every Study Instance, identified by StudyInstanceUID.
2. The Series Number shall increase by 1 for every new Series Instance within the same Study Instance, by the timely order, the Series Instances are created.
3. The Image Number shall start with 1 for every new Series Instance.
4. The Image Number shall increase by 1 for every new Image Instance within the same Series Instance, by the timely order, the Images are created.

For DX SOP Class is in the DICOM Standard defined:

The Digital X-Ray (DX) Image Information Object Definition specifies an image that has been created by a digital projection radiography imaging device.

Notes:

- This includes but is not limited to: chest radiography, linear and multi-directional tomography, orthopantomography and skeletal radiography. Acquisition of image data may include but is not limited to: CCD-based sensors, stimulable phosphor imaging plates, amorphous selenium, scintillation based amorphous silicon and secondary capture of film-based images.
- Specific IODs are defined for intra-oral radiography and mammography that further specialization of the DX IOD.

A DX image shall consist of the result of a single X-Ray exposure, in order to ensure that the anatomical and orientation attributes are meaningful for the image, permitting safe annotation, appropriate image processing and appropriate dissemination.

Notes:

- The requirement for the PCR Eleva specifically deprecates the common film/screen and Computed Radiography practice of making multiple exposures on different areas of a cassette or plate by using lead occlusion between exposures. Such acquisitions could be separated and transformed into multiple DX images during an appropriate quality assurance step by an operator.
- The requirement for the PCR Eleva does not deprecate the acquisition of multiple paired structures during a single exposure, provided that they can be described by the relevant orientation attributes. For example, an AP or PA projection of both hands side by side is typically obtained in a single exposure, and can be described by a Patient Orientation (0020,0020) of R\H or L\H since both hands are in the same traditional Anatomical Position.

4.2.1.3.4.3. SOP Specific Conformance for Storage SOP Classes

This section and sub-section includes the manufacturer SOP and Dataset specific information as well the status codes and their corresponding behavior.

4.2.1.3.4.3.1. Dataset Specific Conformance for C-STORE-RQ

Detail regarding the Dataset Specific response behavior will be reported in this section. This includes the dataset specific behavior, i.e. error codes, error and exception handling, time-outs, etc.

Table 27: Status Response

Service Status	Error code	Further Meaning	Behavior
Success	0000	Storage is complete	UI status is updated.
Failure	A7xx	Refused: Out of Resources	The association is released. The reason is logged. The user is informed.
	A9xx	Error: Data Set does not match SOP Class	The association is released. The reason is logged. The user is informed.
	Cxxx	Error: cannot understand	The association is released. The reason is logged. The user is informed.
Warning	B000	Coercion of Data Elements	The association is released. The reason is logged. The user is informed.
	B007	Data Set does not match SOP Class	The association is released. The reason is logged. The user is informed.
	B006	Elements Discarded	The association is released. The reason is logged. The user is informed.

The status can be inspected via the user interface.

4.2.1.3.5. (Real-World) Activity – Print Management as SCU

4.2.1.3.5.1. Description and Sequencing of Activities

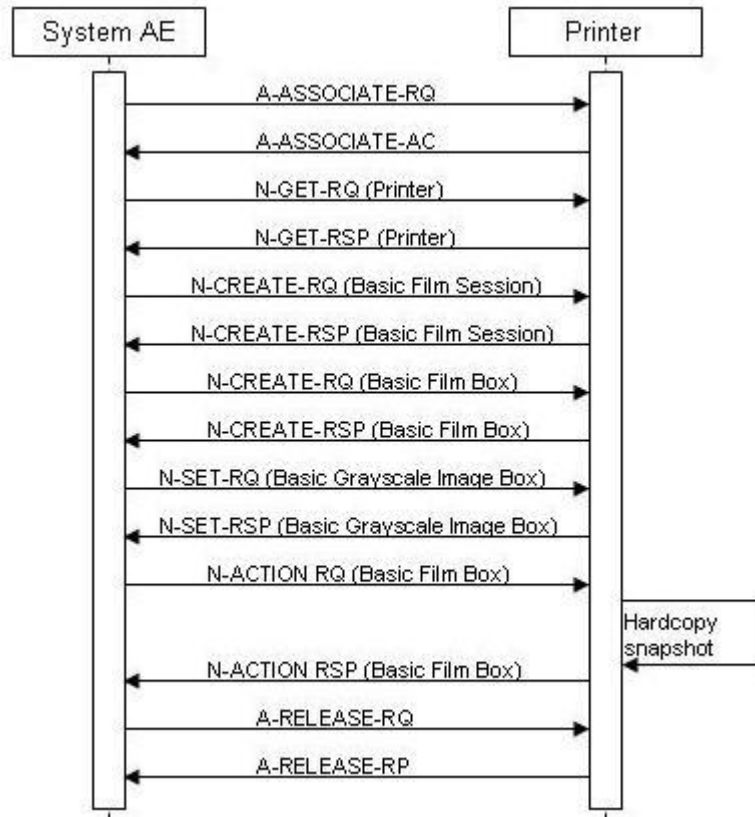

Figure 9: (Real World) Activity - Print Management as SCU

The Eleva AE cannot handle any N-EVENT-REPORT messages.

A print job (film session) comprises one single film box with one single image (that is composed of 1..N modality images).

The print component in PCR Eleva supports a highly automated print from acquisition operation mode, which does not interrupt the clinical acquisition workflow.

Supplementary to that is the manual print operation mode that is to be used as advanced interactive print preview and as reprint facility.

There shall be two modes of configuration for automatic printing: auto and easy print. In auto print mode conflicting and incomplete print jobs are either printed "as is" or must be manually corrected and confirmed.

In easy print mode all automatically started print jobs have to be confirmed manually. The behavior of the print GUI on entry is dependent on the configuration not on the workflow context.

The three different print modes are:

- No auto print jobs active: Screen is empty.
- Auto print configured: All incomplete pages and conflict jobs are seen for that patient.
- Easy print configured: All current print jobs are seen for that patient.

By Manual Printing the basic composition of films is possible with click and point functions.

To allow for more automation, auto-arranging (AA) is required.

AA takes the configured defaults (2x1P 14x17) and loads the images automatically.

User can make multiple selections of images or all images select/deselect and pressed

"arrange". Images are taken for AA in the order they have been selected, if this is relevant for the Templates if ALL images are selected, then they are taken in order from top left to lower right in rows. After AA the result can be modified manually.

By Auto Print the operation mode the handling of conflicts between configuration and operation is configurable. This means:
 If the collimation and thus the image are larger as originally configured it can be configured if the image shall be cut, scaled or the print job with the conflict shall be manually corrected and confirmed.
 If the operator omits one of the routine views configured and a page is thus left half-filled it can be configured if the page is going to be printed half-filled, if a layout suitable for the number of available images is chosen instead or if the page must be manually changed and confirmed.
 In case of a manual check configured conflict jobs are sent to the print GUI and handled like the Easy Print. Outstanding jobs are shown to the user by:

- An icon in the patient list at every affected patient / study
- User guidance giving patient name of unprinted film at the time the film ready to be printed

By Easy Print all print jobs are sent to the Print UI for checking first. The user is not forced to go there, but outstanding jobs are shown to the user by:

- An icon in the patient list at every affected patient / study
- User guidance giving patient name of unprinted film at the time the film ready to be printed

Depending on the response status of set and the configuration the Eleva AE may perform a retry.

4.2.1.3.5.2. Proposed Presentation Contexts

The presentation contexts are defined in next table.

Table 28: Proposed Presentation Contexts for (Real-World) Activity – Print Management As SCU

Presentation Context Table					
Abstract Syntax		Transfer Syntax		Role	Extended Negotiation
Name	UID	Name List	UID List		
Basic Grayscale Print Management Meta SOP Class	1.2.840.10008.5.1.1.9			SCU	None
>Basic Film Box SOP Class	1.2.840.10008.5.1.1.2	Explicit VR Big Endian	1.2.840.10008.1.2.2	SCU	None
		Explicit VR Little Endian	1.2.840.10008.1.2.1		
		Implicit VR Little Endian	1.2.840.10008.1.2		
>Basic Film Session SOP Class	1.2.840.10008.5.1.1.1	Explicit VR Big Endian	1.2.840.10008.1.2.2	SCU	None
		Explicit VR Little Endian	1.2.840.10008.1.2.1		
		Implicit VR Little Endian	1.2.840.10008.1.2		
>Basic Grayscale Image Box SOP Class	1.2.840.10008.5.1.1.4	Explicit VR Big Endian	1.2.840.10008.1.2.2	SCU	None
		Explicit VR Little Endian	1.2.840.10008.1.2.1		
		Implicit VR Little Endian	1.2.840.10008.1.2		
>Printer SOP Class	1.2.840.10008.5.1.1.16	Implicit VR Little Endian	1.2.840.10008.1.2	SCU	None
		Explicit VR Big Endian	1.2.840.10008.1.2.2		
		Explicit VR Little Endian	1.2.840.10008.1.2.1		

Table 29: DICOM Command Response Status Handling behavior for Grayscale Print Management Meta SOP Class

Service Status	Error Code	Further Meaning	Behavior
Success	0000	Successful operation	The print job continues.
Failure	xxxx	Any failure	In the AutoPrint mode a GUI is invoked. The status panel of this GUI displays a message based on the 'Further Meaning'. The warning or failure response of a print request that is invoked by the Manual Print Composer GUI will be displayed by a pop-up window (if the user has not closed the GUI before the printer status was delivered).
Warning	xxxx	Any warning	In the AutoPrint mode a GUI is invoked. The status panel of this GUI displays a message based on the 'Further Meaning'. The warning or failure response of a print request that is invoked by the Manual Print Composer GUI will be displayed by a pop-up window (if the user has not closed the GUI before the printer status was delivered).

The behavior of the Application Entity during communication failure for printing is summarized in next table.

Table 30: DICOM Command Communication Failure Behavior for Printing SCU

Exception	Behavior
Timeout	The Association is aborted using A-ABORT and the command is marked as failed. The reason is logged. After a maximum number of retries the user is notified via pop-up (in preview mode only).
Association aborted	The command is marked as failed. The reason is logged. After a maximum number of retries the user is notified via pop-up (in preview mode only)
Failed to connect	Log entry. After a maximum number of retries the user is notified via pop-up (in preview mode only).

This section specifies each IOD created (including private IOD's).

Abbreviations used in the Module table for the column "Presence of Value" are:

ALWAYS	The attribute is always present with a value
EMPTY	The attribute is always present without any value (attribute sent zero length)
VNAP	The attribute is always present and its Value is Not Always Present (attribute sent zero length if no value is present)
ANAP	The attribute is present under specified condition – if present then it will always have a value
VNAPCV	The attribute is present under specified condition – if present then its Value is Not Always Present (attribute sent zero length if condition applies and no value is present)
ANAPEV	The attribute is present under specified condition – if present then it will not have any value

The abbreviations used in the Module table for the column "Source" are:

AUTO	The attribute value is generated automatically
CONFIG	The attribute value source is a configurable parameter
COPY	The attribute value source is another SOP instance
FIXED	The attribute value is hard-coded in the application
IMPLICIT	The attribute value source is a user-implicit setting
MPPS	The attribute value is the same as that use for Modality Performed Procedure Step
MWL	The attribute value source is a Modality Worklist
USER	The attribute value source is explicit user input

4.2.1.3.5.3. SOP Specific Conformance for Basic Film Box SOP Class of the Basic Grayscale Print Management Meta SOP Class

This section and sub-section includes the manufacturer SOP and Dataset specific information as well the status codes and their corresponding behavior.

4.2.1.3.5.3.1. Dataset Specific Conformance for Basic Film Box N-CREATE SCU

Detail regarding the Dataset Specific response behavior will be reported in this section.

Table 31: Basic Film Box Presentation Module

Attribute Name	Tag	VR	Value	Presence of Value	Source	Comment
Configuration Information	2010,0150	ST		ALWAYS	CONFIG	
Film Orientation	2010,0040	CS		ALWAYS	CONFIG	
Film Size ID	2010,0050	CS		ALWAYS	CONFIG	
Image Display Format	2010,0010	ST		ALWAYS	CONFIG	
Magnification Type	2010,0060	CS		ALWAYS	CONFIG	
Max Density	2010,0130	US		ALWAYS	CONFIG	
Trim	2010,0140	CS		ALWAYS	CONFIG	

Table 32: Basic Film Box Relationship Module

Attribute Name	Tag	VR	Value	Presence of Value	Source	Comment
Referenced Film Session Sequence	2010,0500	SQ		ALWAYS	AUTO	
>Referenced SOP Class UID	0008,1150	UI		ALWAYS	AUTO	
>Referenced SOP Instance UID	0008,1155	UI	1.2.840.10008.5.1.1	ALWAYS	AUTO	

4.2.1.3.5.3.2. Dataset Specific Conformance for Basic Film Box N-ACTION SCU

Detail regarding the Dataset Specific response behavior will be reported in this section.

No DICOM information available.

4.2.1.3.5.4. SOP Specific Conformance for Basic Film Session SOP Class of the Basic Grayscale Print Management Meta SOP Class

This section and sub-section includes the manufacturer SOP and Dataset specific information as well the status codes and their corresponding behavior.

4.2.1.3.5.4.1. Dataset Specific Conformance for Basic Film Session N-CREATE SCU

Detail regarding the Dataset Specific response behavior will be reported in this section.

Table 33: Basic Film Session Presentation Module

Attribute Name	Tag	VR	Value	Presence of Value	Source	Comment
Film Destination	2000,0040	CS		ALWAYS	CONFIG	
Film Session Label	2000,0050	LO		ALWAYS	AUTO	
Medium Type	2000,0030	CS		ALWAYS	USER	
Number of Copies	2000,0010	IS		ALWAYS	AUTO	
Print Priority	2000,0020	CS		ALWAYS	AUTO	

4.2.1.3.5.5. SOP Specific Conformance for Basic Grayscale Image Box SOP Class of the Basic Grayscale Print Management Meta SOP Class

This section and sub-section includes the manufacturer SOP and Dataset specific information as well the status codes and their corresponding behavior.

4.2.1.3.5.5.1. Dataset Specific Conformance for Basic Grayscale Image Box N-SET SCU

Detail regarding the Dataset Specific response behavior will be reported in this section.

Table 34: Image Box Pixel Presentation Module

Attribute Name	Tag	VR	Value	Presence of Value	Source	Comment
Image Position	2020,0010	US		ALWAYS	AUTO	
Polarity	2020,0020	CS		ALWAYS	AUTO	
Basic Grayscale Image Sequence	2020,0110	SQ		ALWAYS	AUTO	
>Bits Allocated	0028,0100	US	16, 8	ALWAYS	AUTO	
>Bits Stored	0028,0101	US	12, 8	ALWAYS	IMPLICIT	
>Columns	0028,0011	US		ALWAYS	IMPLICIT	Depending on the selected printer type and film size.
>High Bit	0028,0102	US	11, 7	ALWAYS	AUTO	
>Photometric Interpretation	0028,0004	CS	MONOCHROME1, MONOCHROME2	ALWAYS	CONFIG	
>Pixel Data	7FE0,0010	O W/ OB		ALWAYS	AUTO	
>Pixel Representation	0028,0103	US	0x0000	ALWAYS	AUTO	
>Rows	0028,0010	US		ALWAYS	IMPLICIT	Depending on the selected printer type and film size.
>Samples per Pixel	0028,0002	US	1	ALWAYS	AUTO	

4.2.1.3.5.6. SOP Specific Conformance for Printer SOP Class of the Basic Grayscale Print Management Meta SOP Class

This section and sub-section includes the manufacturer SOP and Dataset specific information as well the status codes and their corresponding behavior.

4.2.1.3.5.6.1. Dataset Specific Conformance for Printer N-EVENT-REPORT SCP

Detail regarding the Dataset Specific response behavior will be reported in this section.

No specific DICOM information available

4.2.1.4. Association Acceptance Policy

ELEVA AE accepts associations to allow remote applications to verify application level communication.

The ELEVA AE rejects association requests from unknown applications, i.e. applications that offer an unknown "calling AE title". An application is known if and only if it is defined per configuration.

The ELEVA AE rejects association requests from applications that do not address the ELEVA AE, i.e. that offer a wrong "called AE title".

The Application Entity may reject Association attempts as shown in the table below.

Table 35: Association Reject Reasons

Result	Source	Reason/Diag	Explanation
1 - rejected permanent	1 - DICOM UL service-user	1 - no-Reason-given	Association is not established due to any problem other than that specified in the rows below. (Example: Problem while decoding the DICOM stream).
		2 - application-context-name-not-supported	An application context name other than 1.2.840.3.1.1.1 is requested by the SCU during association.
		3 - calling-AE-title-not-recognized	The configuration does not contain a repository having the calling AE Title as per the association request. There is a problem in the configuration (related to composing the configuration from the SCU and the SCP configuration).
		7 - called-AE-title-not-recognized	The called AE Title in the association request does not match the AE Title as per the configuration.
	2 - DICOM UL service provider (ACSE related function)	1 - no-reason-given	Not used.
		2 - protocol-version-not-supported	Not used.
	3 - DICOM UL service provider (Presentation related function)	1 - temporary-congestion	Not used.
		2 - local-limit-exceeded	Not used.
	2 - Rejected-transient	1 - DICOM UL service-user	1 - no-Reason-given
2 - application-context-name-not-supported			Not used.
3 - calling-AE-title-not-recognized			Not used.
7 - called-AE-title-not-recognized			Not used.
2 - DICOM UL service provider (ACSE related function)		1 - no-reason-given	Maximum number of associations is exceeded and an association request is received.
		2 - protocol-version-not-supported	Not used.
3 - DICOM UL service provider (Presentation related function)		1 - temporary-congestion	Not used.
		2 - local-limit-exceeded	Not used.

The behavior of the AE for sending an association abort is summarized in next table

Table 36: Association Abort Policies

Source	Reason/Diagnosis	Behavior
0 - DICOM UL service-user (initiated abort)	0 - reason-not-specified	When received, the PCR Eleva terminates the connection with the following log: Association ABORTED by peer (0: ABORT_SOURCE_dul_user, 0: ABORT_REASON_not_specified). Sent when: Association times out due to inactivity. Any other problem than ones specified in the rows below. (examples: Problem while decoding the DICOM stream, Invalid request, Echo SCP was unable to send the Response to SCU, Error writing to SCU stream).
2 - DICOM UL service-provider (initiated abort)	0 - reason-not-specified	When received, the PCR Eleva terminates the connection with the following log: Association ABORTED by peer (2: ABORT_SOURCE_dul_provider, 0: ABORT_REASON_not_specified).
	1 - unrecognized-PDU	When received, the PCR Eleva terminates the connection with the following log: Association ABORTED by peer (2: ABORT_SOURCE_dul_provider, 1: ABORT_REASON_unrecognized_pdu). Sent when: An unrecognized PDU is received.
	2 - unexpected-PDU	When received, the PCR Eleva terminates the connection with the following log: Association ABORTED by peer (2: ABORT_SOURCE_dul_provider, 2: ABORT_REASON_unexpected_pdu). Sent when: The received PDU type is not expected in the current state of connection.
	4 - unrecognized-PDU parameter	When received, the PCR Eleva terminates the connection with the following log: Association ABORTED by peer (2: ABORT_SOURCE_dul_provider, 4: ABORT_REASON_unrecognized_pdu_parameter). Sent when: An unrecognized Associate PDU item is received.
	5 - unexpected-PDU parameter	When received, the PCR Eleva terminates the connection with the following log: Association ABORTED by peer (2: ABORT_SOURCE_dul_provider, 5: ABORT_REASON_unexpected_pdu_parameter). Sent when: One of the Associate PDU items is received more than once. One of the Associate PDU items is received unexpectedly.
	6 - invalid-PDU-parameter value	When received, the PCR Eleva terminates the connection with the following log: Association ABORTED by peer (2: ABORT_SOURCE_dul_provider, 6: ABORT_REASON_invalid_pdu_parameter). Sent when: One of the Associate PDU items is received more than once. One of the Associate PDU items is not received Empty Called AE Title String (space-only) is received. Empty Calling AE Title String (space-only) is received. Unknown abstract syntax is received. The length or the format of the received PDU item is invalid.

4.2.1.4.1. (Real-World) Activity – Verification as SCP

4.2.1.4.1.1. Description and Sequencing of Activities

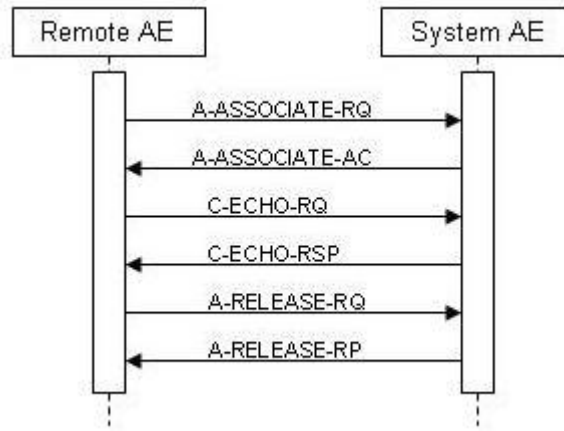

Figure 10: (Real World) Activity - Verification as SCP

The Eleva AE accepts associations from systems that which to verify application level communication using the C-ECHO command.

4.2.1.4.1.2. Accepted Presentation Contexts

The presentation contexts are defined in next table.

Table 37: Acceptable Presentation Contexts for (Real-World) Activity – Verification as SCP

Presentation Context Table					
Abstract Syntax		Transfer Syntax		Role	Extended Negotiation
Name	UID	Name List	UID List		
Verification SOP Class	1.2.840.10008.1.1	Explicit VR Big Endian	1.2.840.10008.1.2.2	SCP	None
		Explicit VR Little Endian	1.2.840.10008.1.2.1		
		Implicit VR Little Endian	1.2.840.10008.1.2		

4.2.1.4.1.3. SOP Specific Conformance for Verification SOP Class

This section and sub-section includes the manufacturer SOP and Dataset specific information as well the status codes and their corresponding behavior.

4.2.1.4.1.3.1. Dataset Specific Conformance for Verification C-ECHO SCP

Detail regarding the Dataset Specific response behavior will be reported in this section.

This part of the section includes the dataset specific behavior, i.e. error codes, error and exception handling, time-outs, etc.

Table 38: Status Response

Service Status	Code	Further Meaning	Behavior
Success	0000	Verification is complete	The PCR Eleva has successfully received the verification request.

4.3. Network Interfaces

4.3.1. Physical Network Interfaces

The System provides only DICOM V3.0 TCP/IP Network Communication Support as defined in PS 3.8 of the standard.

Supported physical medium include:
 IEEE 802.3-1995 10BASE-T
 IEEE 802.3-1995 100BASE-TX (Fast Ethernet)

The TCP/IP Stack as supported by the underlying Operating System.
 The API is the WinSock 2 interface as supported by the underlying Operating System.

4.3.2. Additional Protocols

No additional protocols are used.

4.4. Configuration

Any implementation's DICOM conformance may be dependent upon configuration, which takes place at the time of installation. Issues concerning configuration is addressed in this section.

4.4.1. AE Title/Presentation Address Mapping

An important installation issue is the translation from AE title to presentation address. How this is to be performed is describe here.

4.4.1.1. Local AE Titles

The local AE title mapping and configuration are specified as:

Table 39: AE Title configuration table

Application Entity	Default AE Title	Default TCP/IP Port
ELEVA AE	ELEVA	3010

4.4.1.2. Remote AE Title/Presentation Address Mapping

Specified is here the configuration of the remote application.

No specified DICOM information available.

4.4.2. Parameters

The specification of important operational parameters, their default value and range (if configurable) is specified here.

Table 40: Configuration Parameters Table

Parameter	Configurable	Default Value
General Parameter		
Artim Timeout Specifies the time in seconds of the ARTIM (Association Request/Reject/Release Timer). Allowed values: 0: unlimited waiting time 0 < n: real time in seconds	Yes	60 seconds
Maximum number of simultaneous associations	Yes	2
Maximum PDU size the AE can receive	No	-
Maximum PDU size the AE can send	Yes	16384
Automatic Association Timeout Specifies the association inactivity timeout in seconds after which the association is closed automatically. Allowed values: -1: immediate timeout 0: unlimited waiting time 0 < n: real time in seconds	Yes	0 [unlimited]
Transfer Syntax support: ILE, ELE, EBE	Yes	ILE, ELE, EBE
Storage Specific Parameters		
Automatic export to a configurable destination	Yes	-
Storage Commitment Specific Parameters		
Storage Commit Max Reply Waiting Time. Specifies the time in seconds that is waited for a storage commitment event report message. After this time the association will be terminated. Allow values: -1: immediate timeout 0: unlimited waiting time 0 < n: real time in seconds	Yes	-1 [asynchronous]
Basic Worklist Management Specific Parameters		
RIS query timeout Specifies the time after which the query is automatically aborted Allowed values: 1 - 300 minutes	Yes	240 [minutes]
Background broad query time interval Specifies the time until the background query will be repeated. Allowed values: 0: no broad query 0 < n: real time in minutes	Yes	0 [no broad query]
Print Management Specific Parameters		
Automatic print to a configurable destination	Yes	-

5. MEDIA INTERCHANGE

5.1. Implementation model

The implementation model identifies the DICOM Application Entities for Media in specific implementation and relates the Application Entities to Real-World Activities.

5.1.1. Application Data Flow Diagram

The PCR Eleva system consists of one single application entity only: the Eleva AE.

Next figure shows the Media Interchange application data flow as a functional overview of the Eleva AE.

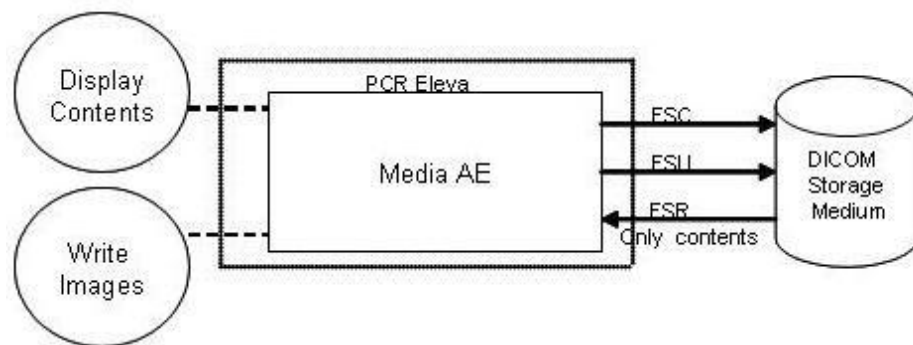

Figure 11: Media Intechange Application Data Flow Diagram

The ELEV A AE will act as a FSR when reading the directory of the medium. The ELEV A AE will act as FSC/FSU when writing the selected images in a patient folder onto the CD-R medium only for the SOP Classes:

- Computer Radiography Image Storage
- Digital X-Ray Image Storage – For Presentation
- Digital X-Ray Image Storage – For Processing
- Secondary Capture Image Storage.

5.1.2. Functional Definitions of AE's

This section contains the functional definition of each individual local Media Application Entity.

5.1.2.1. Functional definition of Eleva.

The Eleva AE is the one and only application entity within the PCR Eleva. It includes the following service class.

Media Storage Service Class.

The Eleva AE can perform the Media Storage Service as SCU, with capabilities for RWA Display Directory (as FSR) and RWA Write Images (as FSC/FSU).

5.1.3. Sequencing of Real World Activities

This section contains a description of sequencing of Real-World Activities that the Media Application Entities require.

Write images can be initiated by selecting a proper destination, selecting requested images and clicking the export button.

Whenever a CD-R has been written the ELEVA AE first tries to read the DICOMDIR. The Eleva AE will compile the updated DICOMDIR and any DICOM images into a CD session image; this CD session image will be written to CD-R.

5.2. AE Specifications

This section in the DICOM Conformance Statement specifies a set of Media Application Entities.

5.2.1. Eleva Media – Specification

This section contains general policies that apply to all of the Application Entities described in subsequent section.

The ELEVA AE provides Standard Conformance to the DICOM Media Storage Service and File Format ([DICOM] PS 3.10) and the Media Storage Application Profiles STD-GEN-CD ([DICOM] PS 3.11) for reading.

ELEVA AE supports multi-patient and multi-session CD-R disks.

Only adding on of instances is supported for the FSU, deleting is not supported.

The following table shows that for one or more Application Profiles there Real-World Activities and the roles of each of these Real-World Activities.

Table 41: AE Eleva Media related Application Profiles, RWA activities and roles

Supported Application Profile	Identifier	Real-World Activities	Roles
General Purpose CD-R Interchange	STD-GEN-CD	Update File-set	FSU
		Create File-set	FSC
		Display Directory	FSR

5.2.1.1. File Meta Information for the Eleva Media

The section describes the real-world activities for the roles and Media Storage Service Class options supported by the ELEVA AE.

Table 42: File Meta Information for the Eleva Media

File Meta Information Version	00,01
Implementation Class UID	1.3.46.670589.30.1.6
Implementation Version Name	PMS_ELEVA_PA_2.4

5.2.1.2. Real-World Activities

The AE specification contains a description of the Real-World Activities, which invoke the particular AE.

5.2.1.2.1. RWA - Create File-set

When an image transfer to CD-R is initiated then the ELEVA AE acts as an FSC or FSU using the interchange option to export SOP Instances from the local database to a CD-R medium.

5.2.1.2.1.1. Media Storage Application Profile

The ELEVA AE supports the RWA Write Images for the STD-GEN-CD Application profile.

5.2.1.2.1.1.1. Options

The DICOMDIR file will be extended when new images are written. In case some attributes are not present in an image but are specified as mandatory in the DICOMDIR definition in DICOM Media, a generated value will be filled in.

5.2.1.2.2. RWA - Update File-set

When an image transfer to CD-R is initiated then the ELEVA AE acts as an FSC or FSU using the interchange option to export SOP Instances from the local database to a CD-R medium.

5.2.1.2.2.1. Media Storage Application Profile

The ELEVA AE supports the RWA Write Images for the STD-GEN-CD Application Profile.

5.2.1.2.2.1.1. Options

The DICOMDIR file will be extended when new images are written. In case some attributes are not present in an image but are specified as mandatory in the DICOMDIR definition in DICOM Media, a generated value will be filled in.

5.2.1.2.3. RWA - Display Directory

The ELEVA AE will act as a FSR when reading the directory of the medium. This will result in an overview of the images on the PCR Eleva screen.

5.2.1.2.3.1. Media Storage Application Profile

The ELEVA AE supports the RWA Display Directory for the STD-GEN-CD Application Profile.

5.2.1.2.3.1.1. Options

Not applicable.

5.3. Augmented and Private Application Profiles

This section is used for the description of augmented and Private Application Profiles.

5.3.1. Sequencing of Real World Activities

Any Augmented Application Profiles used by the Application Entity is described in this section. The rules governing the structure of an Augmented Application Profile are described.

5.3.2. Private Application Profiles

Not applicable

5.4. Media Configuration

By anonymous patient on CD the following DICOM attributes will be changed.

Table 43: Anonymous patient by Media

Attribute Name	Tag	Change to
Media Storage SOP Instance UID	0002,0003	New UID
Referenced SOP Instance UID in File	0004,1511	New UID
SOP Instance UID	0008,0016	New UID
Accession Number	0008,0050	[empty]
Institution Name	0008,0080	[empty]
Institution Address	0008,0081	[empty]
Referring Physician's Name	0008,0090	[empty]
Station Name	0008,1010	[empty]
Study Description	0008,1030	[empty]
Series Description	0008,103E	[empty]
Institutional Department Name	0008,1040	[empty]
Performing Physician's Name	0008,1050	[empty]
Operators' Name	0008,1070	[empty]
Patient Name	0010,0010	[empty]
Patient ID	0010,0020	New ID
Patient's Birth Date	0010,0030	[empty]
Patient's Sex	0010,0040	[empty]
Other Patient IDs	0010,1000	[empty]
Patient's Size	0010,1020	[empty]
Patient Weight	0010,1030	[empty]
Device Serial Number	0018,1000	New ID
Study Instance UID	0020,000D	New UID
Series Instance UID	0020,000E	New UID
Study ID	0020,0010	New ID
Requesting Physician	0032,1032	[empty]
Request Attributes Sequence	0040,0270	[empty sequence]
Requested Procedure ID	0040,1001	New ID

6. SUPPORT OF CHARACTER SETS

Any support for character sets beyond the default character repertoire in Network and Media services is described here.

Table 44: Supported DICOM Character Sets of PCR Eleva

Character Set Description	Defined Term	ESC Sequence	ISO Registration Number	Code Element	Character Set
Latin alphabet No. 1	ISO_IR 100	-	ISO-IR 6	G0	ISO 646
		-	ISO-IR 100	G1	Supplementary set of ISO 8859

7. SECURITY

7.1. Security Transport Connection Profiles

The Basic TLS Secure Transport Connection Profile

PCR Eleva conforms to the Basic TLS Secure Transport Connection Profile.

Since PCR Eleva acts only as SCU (except Verify) no IP port is specified to accept TLS connections.

PCR Eleva provides a service accessible tool to configure private keys and certificates of the local and remote DICOM nodes.

7.2. Attribute Confidentiality Profiles

The Basic Application Level Confidentiality Profile

PCR Eleva conforms to the Basic Application Level Confidentiality Profile as de-identifier.

De-identified SOP Instances will be created on DICOM Media if specified by the user.

No instances of the Encrypted Attributes Data Set are created. No Transfer Syntaxes are supported for encoding/decoding of Encrypted Attributes Data Sets.

Table below lists the protected attributes. The terms used to describe the replacement value can be read as follows:

empty	The attribute will have a value of zero length.
n. a.	Not applicable, the attribute is not contained in the standard IOD of XD-S.
anon string	The original value is mapped onto a string with a length of max 12 characters UID using the procedure described below.
anon UID	The original value is mapped onto a syntactically valid DICOM UID using the procedure described below.

The above mentioned mapping procedure works as follows:

- The original value is taken as a string of arbitrary length.
- This string is mapped onto a 16-byte value using MD5 hash.
- From this value only the first 8 bytes are used further.
- To create an anon string these first 8 bytes are mapped onto a 12 characters long string using base 64.
- To create an anon UID the 8 bytes are read as two integers which are used to create a valid DICOM UID:
(ImplClassUID).(DevSerialNu).2.Integer(byte[0-3]).Integer(byte[4-7])

MD5 hash makes practically sure that different strings are mapped to different 16-byte values. So the whole procedure ensures that the relationship between SOP Instances by the means of their UIDs remains consistent.

Table 45: Basic Application Level Confidentiality Profile Attributes

Attribute Name	Tag	Replacement Value
Instance Creator UID	0008,0014	anon UID
SOP Instance UID	0008,0018	anon UID
Accession Number	0008,0050	empty
Institution Name	0008,0080	empty

Attribute Name	Tag	Replacement Value
Institution Address	0008,0081	empty
Referring Physician's Name	0008,0090	empty
Referring Physician's Telephone Number	0008,0092	n.a.
Station Name	0008,0094	n.a.
Study Description	0008,1010	empty
Series Description	0008,1030	empty
Institutional Department Name	0008,103E	empty
Physician(s) of Recored	0008,1040	empty
Performed Physicians' Name	0008,1048	empty
Name of Physician(s) Reading Study	0008,1050	empty
Operators' Name	0008,1060	empty
Admitting Diagnoses Description	0008,1070	empty
Referenced SOP Instance UID	0008,1155	anon UID
Derivation Description	0008,2111	empty
Patient's Name	0010,0010	empty
Patient ID	0010,0020	anon string
Patient's Birth Date	0010,0030	empty
Patient's Birth Time	0010,0032	empty
Patient's Sex	0010,0040	empty
Other Patient IDs	0010,1000	empty
Other Patient Names	0010,1001	empty
Patient's Age	0010,1010	empty
Patient's Size	0010,1020	empty
Patient's Weight	0010,1030	empty
Medical Record Locator	0010,1090	n.a.
Ethnic Group	0010,2160	empty
Occupation	0010,2180	empty
Additional Patient's History	0010,21B0	empty
Patient Comments	0010,4000	empty
Device Serial Number	0018,1000	anon string
Protocol Name	0018,1030	empty
Study Instance UID	0020,000D	anon UID
Series Instance UID	0020,000E	anon UID
Study ID	0020,0010	anon string
Frame of Reference UID	0020,0052	anon UID
Synchronization Frame of Reference UID	0020,0200	n.a.
Image Comments	0020,4000	empty
Requested Attributes Sequence	0040,0275	empty
UID	0040,A124	anon UID
Content Sequence	0040,A730	empty
Storage Media File-set UID	0088,0140	anon UID
Referenced Frame of Reference UID	3006,0024	n.a.
Releated Frame of Reference UID	3006,00C2	n.a.

No attributes or attribute values are inserted.

8. ANNEXES OF APPLICATION "ELEVA"

8.1. IOD Contents

8.1.1. Created SOP Instance

This section specifies each created IOD by this application.

This section specifies each IOD created (including private IOD's). It should specify the attribute name, tag, VR, and value. The value should specify the range and source (e.g. user input, Modality Worklist, automatically generated, etc.). For content items in templates, the range and source of the concept name and concept values should be specified. Whether the value is always present or not shall be specified.

Abbreviations used in the IOD tables for the column "Presence of Module" are:

ALWAYS The module is always present
CONDITIONAL The module is used under specified condition

Abbreviations used in the Module table for the column "Presence of Value" are:

ALWAYS The attribute is always present with a value
EMPTY The attribute is always present without any value (attribute sent zero length)
VNAP The attribute is always present and its Value is Not Always Present (attribute sent zero length if no value is present)
ANAP The attribute is present under specified condition – if present then it will always have a value
ANAPCV The attribute is present under specified condition – if present then its Value is Not Always Present (attribute sent zero length if condition applies and no value is present)
ANAPEV The attribute is present under specified condition – if present then it will not have any value

The abbreviations used in the Module table for the column "Source" are:

AUTO The attribute value is generated automatically
CONFIG The attribute value source is a configurable parameter
COPY The attribute value source is another SOP instance
FIXED The attribute value is hard-coded in the application
IMPLICIT The attribute value source is a user-implicit setting
MPPS The attribute value is the same as that use for Modality Performed Procedure Step
MWL The attribute value source is a Modality Worklist
USER The attribute value source is explicit user input

8.1.1.1. List of created SOP Classes

Table 46: List of created SOP Classes

SOP Class Name	SOP Class UID
Computed Radiography Image Storage SOP Class	1.2.840.10008.5.1.4.1.1.1
Secondary Capture Image Storage SOP Class	1.2.840.10008.5.1.4.1.1.7
Digital X-Ray Image Storage - For Pres. SOP	1.2.840.10008.5.1.4.1.1.1.1
Digital X-Ray Image Storage - For Proc. SOP	1.2.840.10008.5.1.4.1.1.1.1.1
Digital Mammography X-Ray Image Storage - Proc. SOP	1.2.840.10008.5.1.4.1.1.1.2.1
Digital Mammography X-Ray Image Storage - Pres. SOP	1.2.840.10008.5.1.4.1.1.1.2

8.1.1.2. Computed Radiography Image Storage SOP Class

Table 47: IOD of Created Computed Radiography Image Storage SOP Class Instances

Information Entity	Module	Presence Of Module
Patient	Patient Module	ALWAYS
Study	General Study Module	ALWAYS
Study	Patient Study Module	CONDITIONAL
Series	General Series Module	ALWAYS
Series	CR Series Module	ALWAYS
Equipment	General Equipment Module	ALWAYS
Image	General Image Module	ALWAYS
Image	Contrast/Bolus Module	CONDITIONAL
Image	CR Image Module	ALWAYS
Image	Image Pixel Module	ALWAYS
Image	SOP Common Module	ALWAYS
Image	Overlay Plane Module	CONDITIONAL
Image	Modality LUT Module	CONDITIONAL
Image	VOI LUT Module	ALWAYS
	Additional Module	ALWAYS

Table 48: Patient Module

Attribute Name	Tag	VR	Value	Presence of Value	Source	Comment
Ethnic Group	0010,2160	SH		ANAP	AUTO	
Issuer of Patient ID	0010,0021	LO		ANAP	USER, MWL	
Other Patient IDs	0010,1000	LO		ANAP	USER, MWL	
Patient Comments	0010,4000	LT		ANAP	USER, MWL	
Patient ID	0010,0020	LO		ALWAYS	AUTO, MWL	
Patient's Birth Date	0010,0030	DA		VNAP	USER, MWL	
Patient's Name	0010,0010	PN		VNAP	USER, MWL	
Patient's Sex	0010,0040	CS	F, M, O	VNAP	USER, MWL	

Table 49: General Study Module

Attribute Name	Tag	VR	Value	Presence of Value	Source	Comment
Accession Number	0008,0050	SH		VNAP	USER, MWL	
Referring Physician's Name	0008,0090	PN		VNAP	USER, MWL	
Study Date	0008,0020	DA		VNAP	AUTO	
Study Description	0008,1030	LO		ANAP	USER, MWL	
Study ID	0020,0010	SH		VNAP	AUTO, MWL	
Study Instance UID	0020,000D	UI		ALWAYS	AUTO, MWL	
Study Time	0008,0030	TM		VNAP	AUTO	
Procedure Code Sequence	0008,1032	SQ		ANAP	MWL	
>Code Meaning	0008,0104	LO		ALWAYS	MWL	
>Code Value	0008,0100	SH		ALWAYS	MWL	
>Coding Scheme Designator	0008,0102	SH		ALWAYS	MWL	

Referenced Study Sequence	0008,1110	SQ		ANAP	MWL	
>Referenced SOP Class UID	0008,1150	UI		ANAPEV	MWL	
>Referenced SOP Instance UID	0008,1155	UI		ANAPEV	MWL	

Table 50: Patient Study Module

Attribute Name	Tag	VR	Value	Presence of Value	Source	Comment
Additional Patient History	0010,21B0	LT		ANAP	USER, MWL	
Patient's Size	0010,1020	DS		ANAP	USER, MWL	
Patient's Weight	0010,1030	DS		ANAP	USER, MWL	

Table 51: General Series Module

Attribute Name	Tag	VR	Value	Presence of Value	Source	Comment
Laterality	0020,0060	CS		VNAP	CONFIG	
Modality	0008,0060	CS	CR	ALWAYS	CONFIG	
Operators' Name	0008,1070	PN		ALWAYS	USER, MPPS	
Performed Procedure Step Description	0040,0254	LO		ANAP	AUTO, MPPS	
Performed Procedure Step ID	0040,0253	SH		ANAP	AUTO,	
Performed Procedure Step Start Date	0040,0244	DA		ANAP	AUTO, MPPS	
Performed Procedure Step Start Time	0040,0245	TM		ANAP	AUTO, MPPS	
Performing Physician's Name	0008,1050	PN		ANAP	USER, MPPS	
Protocol Name	0018,1030	LO		ALWAYS	USER, MWL	
Series Date	0008,0021	DA		ANAP	AUTO	
Series Description	0008,103E	LO		ANAP	USER, MPPS	
Series Instance UID	0020,000E	UI		ALWAYS	AUTO, MPPS	
Series Number	0020,0011	IS		ALWAYS	AUTO, MPPS	
Series Time	0008,0031	TM		ANAP	AUTO	
Performed Protocol Code Sequence	0040,0260	SQ		ANAP	MWL	
>Code Meaning	0008,0104	LO		ALWAYS	MWL	
>Code Value	0008,0100	SH		ALWAYS	MWL	
>Coding Scheme Designator	0008,0102	SH		ALWAYS	MWL	
Referenced Performed Procedure Step Sequence	0008,1111	SQ		ALWAYS	AUTO	
>Referenced SOP Class UID	0008,1150	UI		ALWAYS	AUTO	
>Referenced SOP Instance UID	0008,1155	UI		ALWAYS	AUTO	
Request Attributes Sequence	0040,0275	SQ		ANAP	MWL	
>Requested Procedure ID	0040,1001	SH		ANAPEV	MWL	
>Scheduled Procedure Step Description	0040,0007	LO		ANAP	MWL	
>Scheduled Procedure Step ID	0040,0009	SH		ANAPEV	MWL	
>Scheduled Protocol Code Sequence	0040,0008	SQ		ANAP	MWL	
>>Code Meaning	0008,0104	LO		ALWAYS	MWL	
>>Code Value	0008,0100	SH		ALWAYS	MWL	
>>Coding Scheme Designator	0008,0102	SH		ALWAYS	MWL	

Table 52: CR Series Module

Attribute Name	Tag	VR	Value	Presence of Value	Source	Comment
Body Part Examined	0018,0015	CS		VNAP	USER, MPPS	
View Position	0018,5101	CS		VNAP	AUTO	

Table 53: General Equipment Module

Attribute Name	Tag	VR	Value	Presence of Value	Source	Comment
Device Serial Number	0018,1000	LO		ALWAYS	CONFIG	
Institution Address	0008,0081	ST		ALWAYS	CONFIG	
Institution Name	0008,0080	LO		ALWAYS	CONFIG	
Institutional Department Name	0008,1040	LO		ALWAYS	CONFIG	
Manufacturer	0008,0070	LO	Philips Medical Systems	ALWAYS	AUTO	
Manufacturer's Model Name	0008,1090	LO	PCR Eleva	ALWAYS	AUTO	
Software Version(s)	0018,1020	LO		ALWAYS	AUTO	
Spatial Resolution	0018,1050	DS		ALWAYS	AUTO	
Station Name	0008,1010	SH		ALWAYS	CONFIG	

Table 54: General Image Module

Attribute Name	Tag	VR	Value	Presence of Value	Source	Comment
Acquisition Date	0008,0022	DA		ALWAYS	AUTO	
Acquisition Time	0008,0032	TM		ALWAYS	AUTO	
Burned In Annotation	0028,0301	CS		ALWAYS	AUTO	
Content Date	0008,0023	DA		ALWAYS	AUTO	
Content Time	0008,0033	TM		ALWAYS	AUTO	
Image Type	0008,0008	CS	ORIGINAL, PRIMARY	ALWAYS	AUTO	
Instance Number	0020,0013	IS		ALWAYS	AUTO	
Lossy Image Compression	0028,2110	CS	00	ANAP	AUTO	
Patient Orientation	0020,0020	CS		VNAP	AUTO	
Presentation LUT Shape	2050,0020	CS	IDENTITY	ALWAYS	AUTO	

Table 55: Contrast/Bolus Module

Attribute Name	Tag	VR	Value	Presence of Value	Source	Comment
Contrast/Bolus Agent	0018,0010	LO		VNAP	AUTO	

Table 56: CR Image Module

Attribute Name	Tag	VR	Value	Presence of Value	Source	Comment
Acquisition Device Processing Description	0018,1400	LO		ANAP	AUTO	
Distance Source to Detector	0018,1110	DS		ANAP	AUTO	
Exposure	0018,1152	IS		ANAP	AUTO	
Exposure Time	0018,1150	IS		ANAP	AUTO	
Imager Pixel Spacing	0018,1164	DS		ALWAYS	AUTO	
KVP	0018,0060	DS		ANAP	AUTO	
Photometric Interpretation	0028,0004	CS	MONOCHROME2	ALWAYS	AUTO	
Relative X-ray Exposure	0018,1405	IS		ANAP	AUTO	
X-ray Tube Current	0018,1151	IS		ANAP	AUTO	

Table 57: Image Pixel Module

Attribute Name	Tag	VR	Value	Presence of Value	Source	Comment
Bits Allocated	0028,0100	US	16	ALWAYS	AUTO	
Bits Stored	0028,0101	US	10, 15, 12	ALWAYS	AUTO	
Columns	0028,0011	US		ALWAYS	AUTO	
High Bit	0028,0102	US	9, 11, 14	ALWAYS	AUTO	
Pixel Aspect Ratio	0028,0034	IS	1, 1	ALWAYS	AUTO	
Pixel Data	7FE0,0010	O W/ OB		ALWAYS	AUTO	
Pixel Representation	0028,0103	US	0000	ALWAYS	AUTO	
Rows	0028,0010	US		ALWAYS	AUTO	
Samples per Pixel	0028,0002	US	1	ALWAYS	AUTO	

Table 58: SOP Common Module

Attribute Name	Tag	VR	Value	Presence of Value	Source	Comment
SOP Class UID	0008,0016	UI		ALWAYS	AUTO	
SOP Instance UID	0008,0018	UI	1.2.840.10008.5.1.4.1.1.1	ALWAYS	AUTO	
Specific Character Set	0008,0005	CS		ANAPCV	AUTO	

Table 59: Overlay Plane Module

Attribute Name	Tag	VR	Value	Presence of Value	Source	Comment
Overlay Bit Position	6000,0102	US		ANAP	AUTO	
Overlay Bits Allocated	6000,0100	US		ANAP	AUTO	
Overlay Columns	6000,0011	US		ANAP	AUTO	
Overlay Data	6000,3000	O W/ OB		ANAP	AUTO	
Overlay Origin	6000,0050	SS		ANAP	AUTO	
Overlay Rows	6000,0010	US		ANAP	AUTO	
Overlay Type	6000,0040	CS		ANAP	AUTO	

Table 60: Modality LUT Module

Attribute Name	Tag	VR	Value	Presence of Value	Source	Comment
Rescale Intercept	0028,1052	DS		ALWAYS	AUTO	
Rescale Slope	0028,1053	DS		ALWAYS	AUTO	
Rescale Type	0028,1054	LO	US	ALWAYS	AUTO	

Table 61: VOI LUT Module

Attribute Name	Tag	VR	Value	Presence of Value	Source	Comment
Window Center	0028,1050	DS	2047.0	ALWAYS	AUTO	
Window Width	0028,1051	DS	4095.0	ALWAYS	AUTO	

Table 62: Additional Module

Attribute Name	Tag	VR	Value	Presence of Value	Source	Comment
Medical Alerts	0010,2000	LO		VNAP	USER, MWL	
Contrast Allergies	0010,2110	LO		VNAP	USER, MWL	
Pregnancy Status	0010,21C0	US		VNAP	USER, MWL	

Image and Fluoroscopy Area Dose Product	0018,115E	DS		VNAP	AUTO	
Requesting Physician	0032,1032	PN		VNAP	USER, MWL	
Requesting Service	0032,1033	LO		VNAP	USER, MWL	
Requested Procedure Description	0032,1060	LO		VNAP	USER, MWL	
Special Needs	0038,0050	LO		VNAP	USER, MWL	
Patient State	0038,0500	LO		VNAP	USER, MWL	
Performed Station AE Title	0040,0241	AE		VNAP	AUTO, MPPS	
Performed Procedure Step End Date	0040,0250	DA		VNAP	AUTO, MPPS	
Performed Procedure Step End Time	0040,0251	TM		VNAP	AUTO, MPPS	
Performed Procedure Step Status	0040,0252	CS		VNAP	AUTO, MPPS	
Total Time of Fluoroscopy	0040,0300	US		VNAP	AUTO	
Total Number of Exposures	0040,0301	US		VNAP	AUTO	
Entrance Dose	0040,0302	US		VNAP	AUTO	
Requested Procedure ID	0040,1001	SH		VNAP	USER, MWL	
Reason for the Requested Procedure	0040,1002	LO		VNAP	USER, MWL	
Requested Procedure Priority	0040,1003	SH		VNAP	USER, MWL	
Patient Transport Arrangements	0040,1004	LO		VNAP	USER, MWL	
Names of Intended Recipients of Results	0040,1010	PN		VNAP	USER, MWL	
Requested Procedure Comments	0040,1400	LT		VNAP	USER, MWL	
Reason for the Imaging Service Request (RETIRED)	0040,2001	LO		VNAP	MWL	
Issue Date of Imaging Service Request	0040,2004	DA		VNAP	USER, MWL	
Imaging Service Request Comments	0040,2400	LT		VNAP	USER, MWL	
Requested Procedure Code Sequence	0032,1064	SQ		VNAP	MWL	
>Code Value	0008,0100	SH		VNAP	MWL	
>Coding Scheme Designator	0008,0102	SH		VNAP	MWL	
>Code Meaning	0008,0104	LO		VNAP	MWL	
Exposure Dose Sequence	0040,030E	SQ		VNAP	AUTO	
>KVP	0018,0060	DS		VNAP	AUTO	
>Exposure Time	0018,1150	IS		VNAP	AUTO	
>Radiation Mode	0018,115A	CS		VNAP	AUTO	
>Filter Type	0018,1160	SH		VNAP	AUTO	
>Filter Material	0018,7050	CS		VNAP	AUTO	
>X-Ray Tube Current in uA	0018,8151	DS		VNAP	AUTO	
Film Consumption Sequence	0040,0321	SQ		VNAP	AUTO	
>Medium Type	2000,0030	CS		VNAP	AUTO	
>Film Size ID	2010,0050	CS		VNAP	AUTO	
>Number of Films	2100,0170	IS		VNAP	AUTO	

8.1.1.3. Secondary Capture Image Storage SOP Class

Table 63: IOD of Created Secondary Capture Image Storage SOP Class Instances

Information Entity	Module	Presence Of Module
Patient	Patient Module	ALWAYS
Study	General Study Module	ALWAYS
Study	Patient Study Module	CONDITIONAL
Series	General Series Module	ALWAYS
Equipment	General Equipment Module	ALWAYS
Equipment	SC Equipment Module	ALWAYS
Image	General Image Module	ALWAYS
Image	Image Pixel Module	ALWAYS
Image	SC Image Module	ALWAYS
Image	SOP Common Module	ALWAYS
Image	Modality LUT Module	CONDITIONAL
Image	VOI LUT Module	CONDITIONAL
	Additional Module	ALWAYS

Table 64: Patient Module

Attribute Name	Tag	VR	Value	Presence of Value	Source	Comment
Ethnic Group	0010,2160	SH		ANAP	USER, MWL	
Issuer of Patient ID	0010,0021	LO		ANAP		
Other Patient IDs	0010,1000	LO		ANAP	USER, MWL	
Patient Comments	0010,4000	LT		ANAP	USER, MWL	
Patient ID	0010,0020	LO		ALWAYS	USER, MWL	
Patient's Birth Date	0010,0030	DA		VNAP	USER, MWL	
Patient's Name	0010,0010	PN		VNAP	USER, MWL	
Patient's Sex	0010,0040	CS		VNAP	USER, MWL	

Table 65: General Study Module

Attribute Name	Tag	VR	Value	Presence of Value	Source	Comment
Accession Number	0008,0050	SH		VNAP	USER, MWL	
Referring Physician's Name	0008,0090	PN		VNAP	USER, MWL	
Study Date	0008,0020	DA		VNAP	AUTO	
Study Description	0008,1030	LO		ANAP	USER, MWL	
Study ID	0020,0010	SH		VNAP	AUTO, MWL	
Study Instance UID	0020,000D	UI		ALWAYS	AUTO, MWL	
Study Time	0008,0030	TM		VNAP	AUTO	
Procedure Code Sequence	0008,1032	SQ		ANAP	MWL	
>Code Meaning	0008,0104	LO		ALWAYS	MWL	
>Code Value	0008,0100	SH		ALWAYS	MWL	
>Coding Scheme Designator	0008,0102	SH		ALWAYS	MWL	
Referenced Study Sequence	0008,1110	SQ		ANAP	MWL	
>Referenced SOP Class UID	0008,1150	UI		ANAPEV	MWL	
>Referenced SOP Instance UID	0008,1155	UI		ANAPEV	MWL	

Table 66: Patient Study Module

Attribute Name	Tag	VR	Value	Presence of Value	Source	Comment
Additional Patient History	0010,21B0	LT		VNAP	AUTO, MWL	
Patient's Size	0010,1020	DS		ANAP	AUTO, MWL	
Patient's Weight	0010,1030	DS		VNAP	AUTO, MWL	

Table 67: General Series Module

Attribute Name	Tag	VR	Value	Presence of Value	Source	Comment
Body Part Examined	0018,0015	CS		VNAP	USER, MPPS	
Laterality	0020,0060	CS		VNAP	CONF I G	
Operators' Name	0008,1070	PN		ALWAYS	USER, MPPS	
Performed Procedure Step Description	0040,0254	LO		ANAP	AUTO, MPPS	
Performed Procedure Step ID	0040,0253	SH		ANAP	AUTO, MPPS	
Performed Procedure Step Start Date	0040,0244	DA		ANAP	AUTO, MPPS	
Performed Procedure Step Start Time	0040,0245	TM		ANAP	AUTO, MPPS	
Performing Physician's Name	0008,1050	PN		ANAP	USER, MPPS	
Protocol Name	0018,1030	LO		ALWAYS	USER, MWL	
Series Date	0008,0021	DA		ANAP	AUTO	
Series Description	0008,103E	LO		ANAP	USER, MPPS	
Series Instance UID	0020,000E	UI		ALWAYS	AUTO, MPPS	
Series Number	0020,0011	IS		ALWAYS	AUTO, MPPS	
Series Time	0008,0031	TM		ANAP	AUTO	
Performed Protocol Code Sequence	0040,0260	SQ		ANAP	MWL	
>Code Meaning	0008,0104	LO		ALWAYS	MWL	
>Code Value	0008,0100	SH		ALWAYS	MWL	
>Coding Scheme Designator	0008,0102	SH		ALWAYS	MWL	
Referenced Performed Procedure Step Sequence	0008,1111	SQ		ALWAYS	AUTO	
>Referenced SOP Class UID	0008,1150	UI		ALWAYS	AUTO	
>Referenced SOP Instance UID	0008,1155	UI		ALWAYS	AUTO	
Request Attributes Sequence	0040,0275	SQ		ANAP	MWL	
>Requested Procedure ID	0040,1001	SH		ANAPEV	MWL	
>Scheduled Procedure Step Description	0040,0007	LO		ANAP	MWL	
>Scheduled Procedure Step ID	0040,0009	SH		ANAPEV	MWL	
>Scheduled Protocol Code Sequence	0040,0008	SQ		ANAP	MWL	
>>Code Meaning	0008,0104	LO		ALWAYS	MWL	
>>Code Value	0008,0100	SH		ALWAYS	MWL	
>>Coding Scheme Designator	0008,0102	SH		ALWAYS	MWL	

Table 68: General Equipment Module

Attribute Name	Tag	VR	Value	Presence of Value	Source	Comment
Device Serial Number	0018,1000	LO		ANAP	CONFIG	
Institution Address	0008,0081	ST		ALWAYS	CONFIG	
Institution Name	0008,0080	LO		ALWAYS	CONFIG	
Institutional Department Name	0008,1040	LO		ALWAYS	CONFIG	
Manufacturer	0008,0070	LO		ALWAYS	AUTO	
Manufacturer's Model Name	0008,1090	LO		ALWAYS	AUTO	
Software Version(s)	0018,1020	LO		ALWAYS	AUTO	
Spatial Resolution	0018,1050	DS		ALWAYS	AUTO	
Station Name	0008,1010	SH		ALWAYS	CONFIG	

Table 69: SC Equipment Module

Attribute Name	Tag	VR	Value	Presence of Value	Source	Comment
Conversion Type	0008,0064	CS	WSD	ALWAYS	AUTO	
Modality	0008,0060	CS	CR	ALWAYS	AUTO	

Table 70: General Image Module

Attribute Name	Tag	VR	Value	Presence of Value	Source	Comment
Acquisition Date	0008,0022	DA		ALWAYS	AUTO	
Acquisition Time	0008,0032	TM		ALWAYS	AUTO	
Burned In Annotation	0028,0301	CS		ALWAYS	AUTO	
Content Date	0008,0023	DA		ALWAYS	AUTO	
Content Time	0008,0033	TM		ALWAYS	AUTO	
Image Type	0008,0008	CS		ALWAYS	AUTO	
Instance Number	0020,0013	IS		ALWAYS	AUTO	
Lossy Image Compression	0028,2110	CS		ANAP	AUTO	
Patient Orientation	0020,0020	CS		VNAP	USER	

Table 71: Image Pixel Module

Attribute Name	Tag	VR	Value	Presence of Value	Source	Comment
Bits Allocated	0028,0100	US	16	ALWAYS	AUTO	
Bits Stored	0028,0101	US	10, 12, 15	ALWAYS	AUTO	
Columns	0028,0011	US		ALWAYS	AUTO	
High Bit	0028,0102	US	9, 11, 14	ALWAYS	AUTO	
Photometric Interpretation	0028,0004	CS	MONOCHROME2	ALWAYS	AUTO	
Pixel Aspect Ratio	0028,0034	IS	1/1	ALWAYS	AUTO	
Pixel Data	7FE0,0010	O W/ OB		ALWAYS	AUTO	
Pixel Representation	0028,0103	US	0000	ALWAYS	AUTO	
Planar Configuration	0028,0006	US		ALWAYS	AUTO	
Rows	0028,0010	US		ALWAYS	AUTO	
Samples per Pixel	0028,0002	US	1	ALWAYS	AUTO	

Table 72: SC Image Module

Attribute Name	Tag	VR	Value	Presence of Value	Source	Comment
Date of Secondary Capture	0018,1012	DA		ALWAYS	AUTO	
Time of Secondary Capture	0018,1014	TM		ALWAYS	AUTO	

Table 73: SOP Common Module

Attribute Name	Tag	VR	Value	Presence of Value	Source	Comment
SOP Class UID	0008,0016	UI		ALWAYS	AUTO	
SOP Instance UID	0008,0018	UI		ALWAYS	AUTO	
Specific Character Set	0008,0005	CS		ANAPCV	AUTO	

Table 74: Modality LUT Module

Attribute Name	Tag	VR	Value	Presence of Value	Source	Comment
Rescale Intercept	0028,1052	DS		ALWAYS	AUTO	
Rescale Slope	0028,1053	DS		ALWAYS	AUTO	
Rescale Type	0028,1054	LO		ALWAYS	AUTO	

Table 75: VOI LUT Module

Attribute Name	Tag	VR	Value	Presence of Value	Source	Comment
Window Center	0028,1050	DS		ALWAYS	AUTO	
Window Width	0028,1051	DS		ALWAYS	AUTO	

Table 76: Additional Module

Attribute Name	Tag	VR	Value	Presence of Value	Source	Comment
Presentation Intent Type	0008,0068	CS		VNAP	AUTO	
Medical Alerts	0010,2000	LO		VNAP	USER, MWL	
Contrast Allergies	0010,2110	LO		VNAP	USER, MWL	
Pregnancy Status	0010,21C0	US		VNAP	USER, MWL	
Contrast/Bolus Agent	0018,0010	LO		VNAP	AUTO	
KVP	0018,0060	DS		VNAP	AUTO	
Distance Source to Detector	0018,1110	DS		VNAP	AUTO	
Exposure Time	0018,1150	IS		VNAP	AUTO	
X-ray Tube Current	0018,1151	IS		VNAP	AUTO	
Exposure	0018,1152	IS		VNAP	AUTO	
Radiation Setting	0018,1155	CS		VNAP	AUTO	
Image and Fluoroscopy Area Dose Product	0018,115E	DS		VNAP	AUTO	
Imager Pixel Spacing	0018,1164	DS		VNAP	AUTO	
Acquisition Device Processing Description	0018,1400	LO		VNAP	AUTO	
Relative X-ray Exposure	0018,1405	IS		VNAP	AUTO	
Tomo Layer Height	0018,1460	DS		VNAP	AUTO	
Positioner Motion	0018,1500	CS		VNAP	AUTO	
Positioner Type	0018,1508	CS		VNAP	AUTO	
Positioner Primary Angle	0018,1510	DS		VNAP	AUTO	
Positioner Secondary Angle	0018,1511	DS		VNAP	AUTO	
Positioner Primary Angle Increment	0018,1520	DS		VNAP	AUTO	
Positioner Secondary Angle Increment	0018,1521	DS		VNAP	AUTO	
Collimator Shape	0018,1700	CS		VNAP	AUTO	
Collimator Left Vertical Edge	0018,1702	IS		VNAP	AUTO	
Collimator Right Vertical Edge	0018,1704	IS		VNAP	AUTO	
Collimator Upper Horizontal Edge	0018,1706	IS		VNAP	AUTO	
Collimator Lower Horizontal Edge	0018,1708	IS		VNAP	AUTO	

Center of Circular Collimator	0018,1710	IS		VNAP	AUTO	
Radius of Circular Collimator	0018,1712	IS		VNAP	AUTO	
Vertices of the Polygonal Collimator	0018,1720	IS		VNAP	AUTO	
View Position	0018,5101	CS		VNAP	AUTO	
Detector Type	0018,7004	CS		VNAP	AUTO	
Date of Last Detector Calibration	0018,700C	DA		VNAP	AUTO	
Time of Last Detector Calibration	0018,700E	TM		VNAP	AUTO	
Field of View Origin	0018,7030	DS		VNAP	AUTO	
Field of View Rotation	0018,7032	DS		VNAP	AUTO	
Field of View Horizontal Flip	0018,7034	CS		VNAP	AUTO	
Image Laterality	0020,0062	CS		VNAP	AUTO	
Pixel Intensity Relationship	0028,1040	CS		VNAP	AUTO	
Pixel Intensity Relationship Sign	0028,1041	SS		VNAP	AUTO	
Requesting Physician	0032,1032	PN		VNAP	USER, MWL	
Requesting Service	0032,1033	LO		VNAP	USER, MWL	
Requested Procedure Description	0032,1060	LO		VNAP	USER, MWL	
Special Needs	0038,0050	LO		VNAP	USER, MWL	
Patient State	0038,0500	LO		VNAP	USER, MWL	
Performed Station AE Title	0040,0241	AE		VNAP	AUTO, MPPS	
Performed Procedure Step End Date	0040,0250	DA		VNAP	AUTO, MPPS	
Performed Procedure Step End Time	0040,0251	TM		VNAP	AUTO, MPPS	
Performed Procedure Step Status	0040,0252	CS		VNAP	AUTO, MPPS	
Total Time of Fluoroscopy	0040,0300	US		VNAP	AUTO	
Total Number of Exposures	0040,0301	US		VNAP	AUTO	
Entrance Dose	0040,0302	US		VNAP	AUTO	
Requested Procedure ID	0040,1001	SH		VNAP	USER, MWL	
Reason for the Requested Procedure	0040,1002	LO		VNAP	USER, MWL	
Requested Procedure Priority	0040,1003	SH		VNAP	USER, MWL	
Patient Transport Arrangements	0040,1004	LO		VNAP	USER, MWL	
Names of Intended Recipients of Results	0040,1010	PN		VNAP	AUTO	
Requested Procedure Comments	0040,1400	LT		VNAP	MWL	
Reason for the Imaging Service Request (RETIRED)	0040,2001	LO		VNAP	MWL	
Issue Date of Imaging Service Request	0040,2004	DA		VNAP	USER, MWL	
Imaging Service Request Comments	0040,2400	LT		VNAP	USER, MWL	
Requested Procedure Code Sequence	0032,1064	SQ		VNAP	MWL	
>Code Value	0008,0100	SH		VNAP	MWL	
>Coding Scheme Designator	0008,0102	SH		VNAP	MWL	
>Code Meaning	0008,0104	LO		VNAP	MWL	
Exposure Dose Sequence	0040,030E	SQ		VNAP	AUTO	
Film Consumption Sequence	0040,0321	SQ		VNAP	AUTO	
>Medium Type	2000,0030	CS		VNAP	AUTO	
>Film Size ID	2010,0050	CS		VNAP	AUTO	

>Number of Films	2100,0170	IS		VNAP	AUTO	
Acquisition Context Sequence	0040,0555	SQ		VNAP	AUTO	

8.1.1.4. Digital X-Ray Image Storage - For Pres. SOP

Table 77: IOD of Created Digital X-Ray Image Storage - For Pres. SOP Instances

Information Entity	Module	Presence Of Module
Patient	Patient Module	ALWAYS
Study	General Study Module	ALWAYS
Study	Patient Study Module	CONDITIONAL
Series	General Series Module	ALWAYS
Series	DX Series Module	ALWAYS
Equipment	General Equipment Module	ALWAYS
Image	Contrast/Bolus Module	CONDITIONAL
Image	Display Shutter Module	CONDITIONAL
Image	Acquisition Context Module	ALWAYS
Image	General Image Module	ALWAYS
Image	Image Pixel Module	ALWAYS
Image	X-Ray Tomography Acquisition Module	CONDITIONAL
Image	X-Ray Collimator Module	CONDITIONAL
Image	SOP Common Module	ALWAYS
Image	Overlay Plane Module	CONDITIONAL
Image	DX Anatomy Imaged Module	ALWAYS
Image	DX Detector Module	ALWAYS
Image	DX Image Module	ALWAYS
Image	DX Positioning Module	CONDITIONAL
Image	X-Ray Acquisition Dose Module	CONDITIONAL
	Additional Module	ALWAYS

Table 78: DX Anatomy Imaged Module

Attribute Name	Tag	VR	Value	Presence of Value	Source	Comment
Image Laterality	0020,0062	CS		ALWAYS	AUTO	
Anatomic Region Sequence	0008,2218	SQ		VNAP	AUTO	

Table 79: DX Detector Module

Attribute Name	Tag	VR	Value	Presence of Value	Source	Comment
Date of Last Detector Calibration	0018,700C	DA		ANAP	AUTO	
Detector Type	0018,7004	CS		VNAP	AUTO	
Field of View Horizontal Flip	0018,7034	CS		ANAPEV	AUTO	
Field of View Origin	0018,7030	DS		ANAPEV	AUTO	
Field of View Rotation	0018,7032	DS		ANAPEV	AUTO	
Imager Pixel Spacing	0018,1164	DS		ALWAYS	AUTO	
Time of Last Detector Calibration	0018,700E	TM		ANAP	AUTO	

Table 80: DX Image Module

Attribute Name	Tag	VR	Value	Presence of Value	Source	Comment
Acquisition Device Processing Description	0018,1400	LO		ANAP	AUTO	
Bits Allocated	0028,0100	US	16	ALWAYS	AUTO	
Bits Stored	0028,0101	US	10, 12, 15	ALWAYS	CONFIG	
Burned In Annotation	0028,0301	CS		ALWAYS	CONFIG	
High Bit	0028,0102	US	11, 14, 9	ALWAYS	AUTO	

Image Type	0008,0008	CS	ORIGINAL, PRIMARY	ALWAYS	AUTO	
Lossy Image Compression	0028,2110	CS	00	ALWAYS	AUTO	
Patient Orientation	0020,0020	CS		ALWAYS	AUTO	
Photometric Interpretation	0028,0004	CS	MONOCHROME2	ALWAYS	AUTO	
Pixel Intensity Relationship	0028,1040	CS	LOG	ALWAYS	AUTO	
Pixel Intensity Relationship Sign	0028,1041	SS	1	ALWAYS	AUTO	
Pixel Representation	0028,0103	US	0	ALWAYS	AUTO	
Presentation LUT Shape	2050,0020	CS	IDENTITY	ALWAYS	AUTO	
Rescale Intercept	0028,1052	DS		ALWAYS	AUTO	
Rescale Slope	0028,1053	DS		ALWAYS	AUTO	
Rescale Type	0028,1054	LO		ALWAYS	AUTO	
Samples per Pixel	0028,0002	US	1	ALWAYS	AUTO	
Window Center	0028,1050	DS	2047.0	ANAPEV	AUTO	
Window Width	0028,1051	DS	4095.0	ANAPEV	AUTO	

Table 81: DX Positioning Module

Attribute Name	Tag	VR	Value	Presence of Value	Source	Comment
Distance Source to Detector	0018,1110	DS		ANAP	AUTO	
Positioner Primary Angle	0018,1510	DS		ANAP	AUTO	
Positioner Primary Angle Increment	0018,1520	DS		ANAP	AUTO	
Positioner Secondary Angle	0018,1511	DS		ANAP	AUTO	
Positioner Secondary Angle Increment	0018,1521	DS		ANAP	AUTO	
Positioner Type	0018,1508	CS		VNAP	AUTO	
View Position	0018,5101	CS		ANAP	AUTO	

Table 82: DX Series Module

Attribute Name	Tag	VR	Value	Presence of Value	Source	Comment
Modality	0008,0060	CS	DX	ALWAYS	CONFIG	
Presentation Intent Type	0008,0068	CS	FOR PRESENTATION	ALWAYS	AUTO	

Table 83: X-Ray Acquisition Dose Module

Attribute Name	Tag	VR	Value	Presence of Value	Source	Comment
Entrance Dose	0040,0302	US		ANAP	AUTO	
Exposure	0018,1152	IS		ANAP	AUTO	
Exposure Time	0018,1150	IS		ANAP	AUTO	
Image and Fluoroscopy Area Dose Product	0018,115E	DS		ANAP	AUTO	
KVP	0018,0060	DS		ANAP	AUTO	
Relative X-ray Exposure	0018,1405	IS		ANAP	AUTO	
X-ray Tube Current	0018,1151	IS		ANAP	AUTO	

Table 84: Patient Module

Attribute Name	Tag	VR	Value	Presence of Value	Source	Comment
Ethnic Group	0010,2160	SH		ANAP	USER, MWL	
Issuer of Patient ID	0010,0021	LO		ANAP	USER, MWL	
Other Patient IDs	0010,1000	LO		ANAP	USER, MWL	
Patient Comments	0010,4000	LT		ANAP	USER, MWL	
Patient ID	0010,0020	LO		VNAP	USER, MWL	

Patient's Birth Date	0010,0030	DA		VNAP	USER, MWL	
Patient's Name	0010,0010	PN		VNAP	USER, MWL	
Patient's Sex	0010,0040	CS		VNAP	USER, MWL	

Table 85: General Study Module

Attribute Name	Tag	VR	Value	Presence of Value	Source	Comment
Accession Number	0008,0050	SH		VNAP	USER, MWL	
Referring Physician's Name	0008,0090	PN		VNAP	USER, MWL	
Study Date	0008,0020	DA		VNAP	MPPS	
Study Description	0008,1030	LO		ANAP	USER, MWL	
Study ID	0020,0010	SH		VNAP	AUTO, MPPS	
Study Instance UID	0020,000D	UI		ALWAYS	AUTO, MPPS	
Study Time	0008,0030	TM		VNAP	MPPS	
Procedure Code Sequence	0008,1032	SQ		ANAP	MWL	
>Code Meaning	0008,0104	LO		ALWAYS	MWL	
>Code Value	0008,0100	SH		ALWAYS	MWL	
>Coding Scheme Designator	0008,0102	SH		ALWAYS	MWL	
Referenced Study Sequence	0008,1110	SQ		ANAP	MWL	
>Referenced SOP Class UID	0008,1150	UI		ALWAYS	MWL	
>Referenced SOP Instance UID	0008,1155	UI		ALWAYS	MWL	

Table 86: Patient Study Module

Attribute Name	Tag	VR	Value	Presence of Value	Source	Comment
Additional Patient History	0010,21B0	LT		ANAP	USER, MWL	
Patient's Size	0010,1020	DS		ANAP	USER, MWL	
Patient's Weight	0010,1030	DS		ANAP	USER, MWL	

Table 87: General Series Module

Attribute Name	Tag	VR	Value	Presence of Value	Source	Comment
Body Part Examined	0018,0015	CS		ANAP	USER, MPPS	
Laterality	0020,0060	CS		ANAPCV	CONFIG	
Operators' Name	0008,1070	PN		ANAP	USER, MPPS	
Performed Procedure Step Description	0040,0254	LO		ANAP	AUTO, MPPS	
Performed Procedure Step ID	0040,0253	SH		ANAP	AUTO, MPPS	
Performed Procedure Step Start Date	0040,0244	DA		ANAP	AUTO, MPPS	
Performed Procedure Step Start Time	0040,0245	TM		ANAP	AUTO, MPPS	
Performing Physician's Name	0008,1050	PN		ANAP	USER, MPPS	
Protocol Name	0018,1030	LO		ANAP	USER, MWL	
Series Date	0008,0021	DA		ANAP	MPPS	

Series Description	0008,103E	LO		ANAP	USER, MPPS	
Series Instance UID	0020,000E	UI		ALWAYS	AUTO, MPPS	
Series Number	0020,0011	IS		VNAP	AUTO, MPPS	
Series Time	0008,0031	TM		ANAP	MPPS	
Performed Protocol Code Sequence	0040,0260	SQ		ANAP	MWL	
>Code Meaning	0008,0104	LO		ALWAYS	MWL	
>Code Value	0008,0100	SH		ALWAYS	MWL	
>Coding Scheme Designator	0008,0102	SH		ALWAYS	MWL	
Request Attributes Sequence	0040,0275	SQ		ANAP	MWL	
>Requested Procedure ID	0040,1001	SH		ANAPEV	MWL	
>Scheduled Procedure Step Description	0040,0007	LO		ANAP	MWL	
>Scheduled Procedure Step ID	0040,0009	SH		ANAPEV	MWL	
>Scheduled Protocol Code Sequence	0040,0008	SQ		ANAP	MWL	
>>Code Meaning	0008,0104	LO		ALWAYS	MWL	
>>Code Value	0008,0100	SH		ALWAYS	MWL	
>>Coding Scheme Designator	0008,0102	SH		ALWAYS	MWL	

Table 88: General Equipment Module

Attribute Name	Tag	VR	Value	Presence of Value	Source	Comment
Device Serial Number	0018,1000	LO		ANAP	CONFIG	
Institution Address	0008,0081	ST		ANAP	CONFIG	
Institution Name	0008,0080	LO		ANAP	CONFIG	
Institutional Department Name	0008,1040	LO		ANAP	CONFIG	
Manufacturer	0008,0070	LO	Philips Medical Systems	VNAP	AUTO	
Manufacturer's Model Name	0008,1090	LO	PCR Eleva	ANAP	AUTO	
Software Version(s)	0018,1020	LO		ANAP	AUTO	
Spatial Resolution	0018,1050	DS		ANAP	AUTO	
Station Name	0008,1010	SH		ANAP	CONFIG	

Table 89: Contrast/Bolus Module

Attribute Name	Tag	VR	Value	Presence of Value	Source	Comment
Contrast/Bolus Agent	0018,0010	LO		VNAP	AUTO	

Table 90: Display Shutter Module

Attribute Name	Tag	VR	Value	Presence of Value	Source	Comment
Center of Circular Shutter	0018,1610	IS		ANAPEV	AUTO	
Radius of Circular Shutter	0018,1612	IS		ANAPEV	AUTO	
Shutter Left Vertical Edge	0018,1602	IS		ANAPEV	AUTO	
Shutter Lower Horizontal Edge	0018,1608	IS		ANAPEV	AUTO	
Shutter Right Vertical Edge	0018,1604	IS		ANAPEV	AUTO	
Shutter Shape	0018,1600	CS		ALWAYS	AUTO	
Shutter Upper Horizontal Edge	0018,1606	IS		ANAPEV	AUTO	
Vertices of the Polygonal Shutter	0018,1620	IS		ANAPEV	AUTO	

Table 91: Acquisition Context Module

Attribute Name	Tag	VR	Value	Presence of Value	Source	Comment
Acquisition Context Sequence	0040,0555	SQ		VNAP	AUTO	

Table 92: General Image Module

Attribute Name	Tag	VR	Value	Presence of Value	Source	Comment
Acquisition Date	0008,0022	DA		ANAP	AUTO	
Acquisition Time	0008,0032	TM		ANAP	AUTO	
Content Date	0008,0023	DA		ANAPCV	AUTO	
Content Time	0008,0033	TM		ANAPCV	AUTO	
Instance Number	0020,0013	IS		VNAP	AUTO	

Table 93: Image Pixel Module

Attribute Name	Tag	VR	Value	Presence of Value	Source	Comment
Columns	0028,0011	US		ALWAYS	AUTO	
Pixel Aspect Ratio	0028,0034	IS	1, 1	ANAPEV	AUTO	
Pixel Data	7FE0,0010	O W/ OB		ALWAYS	AUTO	
Rows	0028,0010	US		ALWAYS	AUTO	

Table 94: X-Ray Tomography Acquisition Module

Attribute Name	Tag	VR	Value	Presence of Value	Source	Comment
Tomo Layer Height	0018,1460	DS		ALWAYS	AUTO	

Table 95: X-Ray Collimator Module

Attribute Name	Tag	VR	Value	Presence of Value	Source	Comment
Center of Circular Collimator	0018,1710	IS		ANAPEV	AUTO	
Collimator Left Vertical Edge	0018,1702	IS		ANAPEV	AUTO	
Collimator Lower Horizontal Edge	0018,1708	IS		ANAPEV	AUTO	
Collimator Right Vertical Edge	0018,1704	IS		ANAPEV	AUTO	
Collimator Shape	0018,1700	CS		ALWAYS	AUTO	
Collimator Upper Horizontal Edge	0018,1706	IS		ANAPEV	AUTO	
Radius of Circular Collimator	0018,1712	IS		ANAPEV	AUTO	
Vertices of the Polygonal Collimator	0018,1720	IS		ANAPEV	AUTO	

Table 96: SOP Common Module

Attribute Name	Tag	VR	Value	Presence of Value	Source	Comment
SOP Class UID	0008,0016	UI		ANAPEV	AUTO	
SOP Instance UID	0008,0018	UI	1.2.840.10008.5.1.4.1.1.1.1	ANAPEV	AUTO	
Specific Character Set	0008,0005	CS		ANAPEV	AUTO	

Table 97: Overlay Plane Module

Attribute Name	Tag	VR	Value	Presence of Value	Source	Comment
Overlay Bit Position	6000,0102	US		ALWAYS	AUTO	
Overlay Bits Allocated	6000,0100	US		ALWAYS	AUTO	
Overlay Columns	6000,0011	US		ALWAYS	AUTO	
Overlay Data	6000,3000	O W/ OB		ANAPEV	AUTO	
Overlay Origin	6000,0050	SS		ALWAYS	AUTO	
Overlay Rows	6000,0010	US		ALWAYS	AUTO	

Overlay Type	6000,0040	CS		ALWAYS	AUTO	
--------------	-----------	----	--	--------	------	--

Table 98: Additional Module

Attribute Name	Tag	VR	Value	Presence of Value	Source	Comment
Medical Alerts	0010,2000	LO		VNAP	USER, MWL	
Contrast Allergies	0010,2110	LO		VNAP	USER, MWL	
Pregnancy Status	0010,21C0	US		VNAP	USER, MWL	
Radiation Setting	0018,1155	CS		VNAP	AUTO	
Positioner Motion	0018,1500	CS		VNAP	AUTO	
Pixel Spacing	0028,0030	DS		VNAP	AUTO	
Requesting Physician	0032,1032	PN		VNAP	USER, MWL	
Requesting Service	0032,1033	LO		VNAP	USER, MWL	
Requested Procedure Description	0032,1060	LO		VNAP	USER, MWL	
Special Needs	0038,0050	LO		VNAP	USER, MWL	
Patient State	0038,0500	LO		VNAP	USER, MWL	
Performed Station AE Title	0040,0241	AE		VNAP	AUTO, MPPS	
Performed Procedure Step End Date	0040,0250	DA		VNAP	AUTO, MPPS	
Performed Procedure Step End Time	0040,0251	TM		VNAP	AUTO, MPPS	
Performed Procedure Step Status	0040,0252	CS		VNAP	AUTO, MPPS	
Total Time of Fluoroscopy	0040,0300	US		VNAP	AUTO	
Total Number of Exposures	0040,0301	US		VNAP	AUTO	
Requested Procedure ID	0040,1001	SH		VNAP	AUTO, MWL	
Requested Procedure Priority	0040,1003	SH		VNAP	MWL	
Patient Transport Arrangements	0040,1004	LO		VNAP	USER, MWL	
Names of Intended Recipients of Results	0040,1010	PN		VNAP	AUTO	
Requested Procedure Comments	0040,1400	LT		VNAP	MWL	
Reason for the Imaging Service Request (RETIRED)	0040,2001	LO		VNAP	MWL	
Issue Date of Imaging Service Request	0040,2004	DA		VNAP	AUTO	
Imaging Service Request Comments	0040,2400	LT		VNAP	USER, MWL	
Film Consumption Sequence	0040,0321	SQ		VNAP	AUTO	
>Medium Type	2000,0030	CS		ALWAYS	AUTO	
>Film Size ID	2010,0050	CS		ALWAYS	AUTO	
>Number of Films	2100,0170	IS		ALWAYS	AUTO	

8.1.1.5. Digital X-Ray Image Storage - For Proc. SOP

Table 99: IOD of Created Digital X-Ray Image Storage - For Proc. SOP Instances

Information Entity	Module	Presence Of Module
Patient	Patient Module	ALWAYS
Study	General Study Module	ALWAYS
Study	Patient Study Module	CONDITIONAL
Series	DX Series Module	ALWAYS
Series	General Series Module	ALWAYS
Equipment	General Equipment Module	ALWAYS
Image	Contrast/Bolus Module	CONDITIONAL
Image	Display Shutter Module	CONDITIONAL
Image	Acquisition Context Module	ALWAYS
Image	General Image Module	ALWAYS
Image	Image Pixel Module	ALWAYS
Image	X-Ray Tomography Acquisition Module	CONDITIONAL
Image	X-Ray Collimator Module	CONDITIONAL
Image	SOP Common Module	ALWAYS
Image	Overlay Plane Module	CONDITIONAL
Image	DX Anatomy Imaged Module	ALWAYS
Image	DX Detector Module	ALWAYS
Image	DX Image Module	ALWAYS
Image	DX Positioning Module	CONDITIONAL
Image	X-Ray Acquisition Dose Module	CONDITIONAL
	Additional Module	ALWAYS

Table 100: DX Anatomy Imaged Module

Attribute Name	Tag	VR	Value	Presence of Value	Source	Comment
Image Laterality	0020,0062	CS		ALWAYS	AUTO	
Anatomic Region Sequence	0008,2218	SQ		VNAP	AUTO	

Table 101: DX Detector Module

Attribute Name	Tag	VR	Value	Presence of Value	Source	Comment
Date of Last Detector Calibration	0018,700C	DA		ANAP	AUTO	
Detector Type	0018,7004	CS		VNAP	AUTO	
Field of View Horizontal Flip	0018,7034	CS		ANAPEV	AUTO	
Field of View Origin	0018,7030	DS		ANAPEV	AUTO	
Field of View Rotation	0018,7032	DS		ANAPEV	AUTO	
Imager Pixel Spacing	0018,1164	DS		ALWAYS	AUTO	
Time of Last Detector Calibration	0018,700E	TM		ANAP	AUTO	

Table 102: DX Image Module

Attribute Name	Tag	VR	Value	Presence of Value	Source	Comment
Acquisition Device Processing Description	0018,1400	LO		ANAP	AUTO	
Bits Allocated	0028,0100	US	16	ALWAYS	AUTO	
Bits Stored	0028,0101	US	10, 12, 15	ALWAYS	CONFIG	
Burned In Annotation	0028,0301	CS		ALWAYS	CONFIG	
High Bit	0028,0102	US	11, 14, 9	ALWAYS	AUTO	
Image Type	0008,0008	CS	ORIGINAL, PRIMARY	ALWAYS	AUTO	
Lossy Image Compression	0028,2110	CS	00	ALWAYS	AUTO	

Patient Orientation	0020,0020	CS		ALWAYS	AUTO	
Photometric Interpretation	0028,0004	CS	MONOCHROME1	ALWAYS	AUTO	
Pixel Intensity Relationship	0028,1040	CS	LOG	ALWAYS	AUTO	
Pixel Intensity Relationship Sign	0028,1041	SS	1	ALWAYS	AUTO	
Pixel Representation	0028,0103	US		ALWAYS	AUTO	
Presentation LUT Shape	2050,0020	CS	INVERSE	ALWAYS	AUTO	
Rescale Intercept	0028,1052	DS		ALWAYS	AUTO	
Rescale Slope	0028,1053	DS		ALWAYS	AUTO	
Rescale Type	0028,1054	LO		ALWAYS	AUTO	
Samples per Pixel	0028,0002	US		ALWAYS	AUTO	

Table 103: DX Positioning Module

Attribute Name	Tag	VR	Value	Presence of Value	Source	Comment
Distance Source to Detector	0018,1110	DS		ANAP	AUTO	
Positioner Primary Angle	0018,1510	DS		ANAP	AUTO	
Positioner Primary Angle Increment	0018,1520	DS		ANAP	AUTO	
Positioner Secondary Angle	0018,1511	DS		ANAP	AUTO	
Positioner Secondary Angle Increment	0018,1521	DS		ANAP	AUTO	
Positioner Type	0018,1508	CS		VNAP	AUTO	
View Position	0018,5101	CS		ANAP	AUTO	

Table 104: DX Series Module

Attribute Name	Tag	VR	Value	Presence of Value	Source	Comment
Modality	0008,0060	CS	DX	ALWAYS	CONFIG	
Presentation Intent Type	0008,0068	CS	FOR PROCESSING	ALWAYS	AUTO	
Referenced Performed Procedure Step Sequence	0008,1111	SQ		ANAPEV	AUTO	

Table 105: X-Ray Acquisition Dose Module

Attribute Name	Tag	VR	Value	Presence of Value	Source	Comment
Entrance Dose	0040,0302	US		ANAP	AUTO	
Exposure	0018,1152	IS		ANAP	AUTO	
Exposure Time	0018,1150	IS		ANAP	AUTO	
Image and Fluoroscopy Area Dose Product	0018,115E	DS		ANAP	AUTO	
KVP	0018,0060	DS		ANAP	AUTO	
Relative X-ray Exposure	0018,1405	IS		ANAP	AUTO	
X-ray Tube Current	0018,1151	IS		ANAP	AUTO	

Table 106: Patient Module

Attribute Name	Tag	VR	Value	Presence of Value	Source	Comment
Ethnic Group	0010,2160	SH		ANAP	USER, MWL	
Issuer of Patient ID	0010,0021	LO		ANAP	USER, MWL	
Other Patient IDs	0010,1000	LO		ANAP	USER, MWL	
Patient Comments	0010,4000	LT		ANAP	USER, MWL	
Patient ID	0010,0020	LO		ALWAYS	USER, MWL	
Patient's Birth Date	0010,0030	DA		VNAP	USER, MWL	

Patient's Name	0010,0010	PN		VNAP	USER, MWL	
Patient's Sex	0010,0040	CS	F, M, O	VNAP	USER, MWL	

Table 107: General Study Module

Attribute Name	Tag	VR	Value	Presence of Value	Source	Comment
Accession Number	0008,0050	SH		VNAP	USER, MWL	
Referring Physician's Name	0008,0090	PN		VNAP	USER, MWL	
Study Date	0008,0020	DA		ALWAYS	MPPS	
Study Description	0008,1030	LO		ANAP	USER, MWL	
Study ID	0020,0010	SH		ALWAYS	AUTO, MPPS	
Study Instance UID	0020,000D	UI		ALWAYS	AUTO, MPPS	
Study Time	0008,0030	TM		ALWAYS	MPPS	
Procedure Code Sequence	0008,1032	SQ		ANAP	MWL	
>Code Meaning	0008,0104	LO		ALWAYS	MWL	
>Code Value	0008,0100	SH		ALWAYS	MWL	
>Coding Scheme Designator	0008,0102	SH		ALWAYS	MWL	
Referenced Study Sequence	0008,1110	SQ		ANAP	MWL	
>Referenced SOP Class UID	0008,1150	UI		ANAPEV	MWL	
>Referenced SOP Instance UID	0008,1155	UI		ANAPEV	MWL	

Table 108: Patient Study Module

Attribute Name	Tag	VR	Value	Presence of Value	Source	Comment
Additional Patient History	0010,21B0	LT		ANAP	USER, MWL	
Patient's Size	0010,1020	DS		ANAP	USER, MWL	
Patient's Weight	0010,1030	DS		ANAP	USER, MWL	

Table 109: General Series Module

Attribute Name	Tag	VR	Value	Presence of Value	Source	Comment
Body Part Examined	0018,0015	CS		ANAP	USER, MPPS	
Laterality	0020,0060	CS		ANAPCV	CONFIG	
Operators' Name	0008,1070	PN		ANAP	USER, MPPS	
Performed Procedure Step Description	0040,0254	LO		ANAP	AUTO, MPPS	
Performed Procedure Step ID	0040,0253	SH		ANAP	AUTO, MPPS	
Performed Procedure Step Start Date	0040,0244	DA		ANAP	AUTO, MPPS	
Performed Procedure Step Start Time	0040,0245	TM		ANAP	AUTO, MPPS	
Performing Physician's Name	0008,1050	PN		ANAP	USER, MPPS	
Protocol Name	0018,1030	LO		ANAP	USER, MWL	
Series Date	0008,0021	DA		ANAP	MPPS	
Series Description	0008,103E	LO		ANAP	USER, MPPS	

Series Instance UID	0020,000E	UI		ALWAYS	AUTO, MPPS	
Series Number	0020,0011	IS		VNAP	AUTO, MPPS	
Series Time	0008,0031	TM		ANAP	MPPS	
Performed Protocol Code Sequence	0040,0260	SQ		ANAP	MWL	
>Code Meaning	0008,0104	LO		ALWAYS	MWL	
>Code Value	0008,0100	SH		ALWAYS	MWL	
>Coding Scheme Designator	0008,0102	SH		ALWAYS	MWL	
Request Attributes Sequence	0040,0275	SQ		ANAP	MWL	
>Requested Procedure ID	0040,1001	SH		ANAPEV	MWL	
>Scheduled Procedure Step Description	0040,0007	LO		ANAP	MWL	
>Scheduled Procedure Step ID	0040,0009	SH		ANAPEV	MWL	
>Scheduled Protocol Code Sequence	0040,0008	SQ		ANAP	MWL	
>>Code Meaning	0008,0104	LO		ALWAYS	MWL	
>>Code Value	0008,0100	SH		ALWAYS	MWL	
>>Coding Scheme Designator	0008,0102	SH		ALWAYS	MWL	

Table 110: General Equipment Module

Attribute Name	Tag	VR	Value	Presence of Value	Source	Comment
Device Serial Number	0018,1000	LO		ALWAYS	CONFIG	
Institution Address	0008,0081	ST		ALWAYS	CONFIG	
Institution Name	0008,0080	LO		ALWAYS	CONFIG	
Institutional Department Name	0008,1040	LO		ALWAYS	CONFIG	
Manufacturer	0008,0070	LO	Philips Medical Systems	ALWAYS	AUTO	
Manufacturer's Model Name	0008,1090	LO	PCR Eleva	ALWAYS	AUTO	
Software Version(s)	0018,1020	LO		ALWAYS	AUTO	
Spatial Resolution	0018,1050	DS		ALWAYS	AUTO	
Station Name	0008,1010	SH		ALWAYS	CONFIG	

Table 111: Contrast/Bolus Module

Attribute Name	Tag	VR	Value	Presence of Value	Source	Comment
Contrast/Bolus Agent	0018,0010	LO		VNAP	AUTO	

Table 112: Display Shutter Module

Attribute Name	Tag	VR	Value	Presence of Value	Source	Comment
Center of Circular Shutter	0018,1610	IS		ANAPEV	AUTO	
Radius of Circular Shutter	0018,1612	IS		ANAPEV	AUTO	
Shutter Left Vertical Edge	0018,1602	IS		ANAPEV	AUTO	
Shutter Lower Horizontal Edge	0018,1608	IS		ANAPEV	AUTO	
Shutter Right Vertical Edge	0018,1604	IS		ANAPEV	AUTO	
Shutter Shape	0018,1600	CS		ALWAYS	AUTO	
Shutter Upper Horizontal Edge	0018,1606	IS		ANAPEV	AUTO	
Vertices of the Polygonal Shutter	0018,1620	IS		ANAPEV	AUTO	

Table 113: Acquisition Context Module

Attribute Name	Tag	VR	Value	Presence of Value	Source	Comment
Acquisition Context Sequence	0040,0555	SQ		VNAP	AUTO	

Table 114: General Image Module

Attribute Name	Tag	VR	Value	Presence of Value	Source	Comment
Acquisition Date	0008,0022	DA		ALWAYS	AUTO	
Acquisition Time	0008,0032	TM		ALWAYS	AUTO	
Content Date	0008,0023	DA		ALWAYS	AUTO	
Content Time	0008,0033	TM		ALWAYS	AUTO	
Instance Number	0020,0013	IS		VNAP	AUTO	

Table 115: Image Pixel Module

Attribute Name	Tag	VR	Value	Presence of Value	Source	Comment
Columns	0028,0011	US		ALWAYS	AUTO	
Pixel Aspect Ratio	0028,0034	IS	1, 1	ANAPEV	AUTO	
Pixel Data	7FE0,0010	O W/ OB		ALWAYS	AUTO	
Rows	0028,0010	US		ALWAYS	AUTO	

Table 116: X-Ray Tomography Acquisition Module

Attribute Name	Tag	VR	Value	Presence of Value	Source	Comment
Tomo Layer Height	0018,1460	DS		ALWAYS	AUTO	

Table 117: X-Ray Collimator Module

Attribute Name	Tag	VR	Value	Presence of Value	Source	Comment
Center of Circular Collimator	0018,1710	IS		ANAPEV	AUTO	
Collimator Left Vertical Edge	0018,1702	IS		ANAPEV	AUTO	
Collimator Lower Horizontal Edge	0018,1708	IS		ANAPEV	AUTO	
Collimator Right Vertical Edge	0018,1704	IS		ANAPEV	AUTO	
Collimator Shape	0018,1700	CS		ALWAYS	AUTO	
Collimator Upper Horizontal Edge	0018,1706	IS		ANAPEV	AUTO	
Radius of Circular Collimator	0018,1712	IS		ANAPEV	AUTO	
Vertices of the Polygonal Collimator	0018,1720	IS		ANAPEV	AUTO	

Table 118: SOP Common Module

Attribute Name	Tag	VR	Value	Presence of Value	Source	Comment
SOP Class UID	0008,0016	UI		ANAPEV	AUTO	
SOP Instance UID	0008,0018	UI		ANAPEV	AUTO	
Specific Character Set	0008,0005	CS		ANAPEV	AUTO	

Table 119: Overlay Plane Module

Attribute Name	Tag	VR	Value	Presence of Value	Source	Comment
Overlay Bit Position	6000,0102	US	0	ALWAYS	AUTO	
Overlay Bits Allocated	6000,0100	US	1	ALWAYS	AUTO	
Overlay Columns	6000,0011	US		ALWAYS	AUTO	
Overlay Data	6000,3000	O W/ OB		ANAPEV	AUTO	
Overlay Origin	6000,0050	SS	1	ALWAYS	AUTO	
Overlay Rows	6000,0010	US		ALWAYS	AUTO	

Overlay Type	6000,0040	CS	G	ALWAYS	AUTO	
--------------	-----------	----	---	--------	------	--

Table 120: Additional Module

Attribute Name	Tag	VR	Value	Presence of Value	Source	Comment
Medical Alerts	0010,2000	LO		VNAP	USER, MWL	
Contrast Allergies	0010,2110	LO		VNAP	USER, MWL	
Pregnancy Status	0010,21C0	US		VNAP	USER, MWL	
Radiation Setting	0018,1155	CS		VNAP	AUTO	
Positioner Motion	0018,1500	CS		VNAP	AUTO	
Pixel Spacing	0028,0030	DS		VNAP	AUTO	
Requesting Physician	0032,1032	PN		VNAP	USER, MWL	
Requesting Service	0032,1033	LO		VNAP	USER, MWL	
Requested Procedure Description	0032,1060	LO		VNAP	USER, MWL	
Special Needs	0038,0050	LO		VNAP	USER, MWL	
Patient State	0038,0500	LO		VNAP	USER, MWL	
Performed Station AE Title	0040,0241	AE		VNAP	AUTO, MPPS	
Performed Procedure Step End Date	0040,0250	DA		VNAP	AUTO, MPPS	
Performed Procedure Step End Time	0040,0251	TM		VNAP	AUTO, MPPS	
Performed Procedure Step Status	0040,0252	CS		VNAP	AUTO, MPPS	
Total Time of Fluoroscopy	0040,0300	US		VNAP	AUTO	
Total Number of Exposures	0040,0301	US		VNAP	AUTO	
Requested Procedure ID	0040,1001	SH		VNAP	AUTO, MWL	
Reason for the Requested Procedure	0040,1002	LO		VNAP	MWL	
Requested Procedure Priority	0040,1003	SH		VNAP	MWL	
Patient Transport Arrangements	0040,1004	LO		VNAP	USER, MWL	
Names of Intended Recipients of Results	0040,1010	PN		VNAP	AUTO	
Requested Procedure Comments	0040,1400	LT		VNAP	MWL	
Reason for the Imaging Service Request (RETIRED)	0040,2001	LO		VNAP	MWL	
Issue Date of Imaging Service Request	0040,2004	DA		VNAP	AUTO	
Imaging Service Request Comments	0040,2400	LT		VNAP	USER, MWL	
Film Consumption Sequence	0040,0321	SQ		VNAP	AUTO	

8.1.1.6. Digital Mammography X-Ray Image Storage - Proc. SOP

Table 121: IOD of Created Digital Mammography X-Ray Image Storage - Proc. SOP Instances

Information Entity	Module	Presence Of Module
Patient	Patient Module	ALWAYS
Study	General Study Module	ALWAYS
Study	Patient Study Module	CONDITIONAL
Series	General Series Module	ALWAYS
Series	Mammography Series Module	ALWAYS
Series	DX Series Module	ALWAYS
Equipment	General Equipment Module	ALWAYS
Image	Contrast/Bolus Module	CONDITIONAL
Image	Display Shutter Module	CONDITIONAL
Image	Acquisition Context Module	ALWAYS
Image	General Image Module	ALWAYS
Image	Image Pixel Module	ALWAYS
Image	X-Ray Tomography Acquisition Module	0
Image	X-Ray Collimator Module	CONDITIONAL
Image	SOP Common Module	ALWAYS
Image	Overlay Plane Module	CONDITIONAL
Image	DX Anatomy Imaged Module	ALWAYS
Image	DX Detector Module	ALWAYS
Image	DX Image Module	ALWAYS
Image	Mammography Image Module	ALWAYS
Image	X-Ray Acquisition Dose Module	CONDITIONAL
Image	DX Positioning Module	CONDITIONAL
	Additional Module	ALWAYS

Table 122: DX Anatomy Imaged Module

Attribute Name	Tag	VR	Value	Presence of Value	Source	Comment
Anatomic Region Sequence	0008,2218	SQ		ALWAYS	AUTO	

Table 123: DX Detector Module

Attribute Name	Tag	VR	Value	Presence of Value	Source	Comment
Detector Type	0018,7004	CS		VNAP	AUTO	
Imager Pixel Spacing	0018,1164	DS		ALWAYS	AUTO	
Sensitivity	0018,6000	DS		VNAP	AUTO	

Table 124: DX Image Module

Attribute Name	Tag	VR	Value	Presence of Value	Source	Comment
Acquisition Device Processing Description	0018,1400	LO		ANAPCV	AUTO	
Bits Allocated	0028,0100	US	16	ALWAYS	AUTO	
Bits Stored	0028,0101	US	10, 12, 15	ALWAYS	CONFIG	
Burned In Annotation	0028,0301	CS		ALWAYS	CONFIG	
Calibration Image	0050,0004	CS		ALWAYS	AUTO	
High Bit	0028,0102	US	11, 14, 9	ALWAYS	AUTO	
Image Type	0008,0008	CS	ORIGINAL, PRIMARY	ALWAYS	AUTO	
Lossy Image Compression	0028,2110	CS	00	ALWAYS	AUTO	
Patient Orientation	0020,0020	CS		ALWAYS	AUTO	
Photometric Interpretation	0028,0004	CS	MONOCHROME1	ALWAYS	AUTO	

Pixel Intensity Relationship	0028,1040	CS	LOG	ALWAYS	AUTO	
Pixel Intensity Relationship Sign	0028,1041	SS	1	ALWAYS	AUTO	
Pixel Representation	0028,0103	US		ALWAYS	AUTO	
Presentation LUT Shape	2050,0020	CS	INVERSE	ALWAYS	AUTO	
Rescale Intercept	0028,1052	DS		ALWAYS	AUTO	
Rescale Slope	0028,1053	DS		ALWAYS	AUTO	
Rescale Type	0028,1054	LO		ALWAYS	AUTO	
Samples per Pixel	0028,0002	US		ALWAYS	AUTO	

Table 125: Mammography Image Module

Attribute Name	Tag	VR	Value	Presence of Value	Source	Comment
Image Laterality	0020,0062	CS		ALWAYS	AUTO	
Organ Exposed	0040,0318	CS	BREAST	ALWAYS	AUTO	
Positioner Primary Angle	0018,1510	DS		ANAPCV	AUTO	
Positioner Secondary Angle	0018,1511	DS		ANAPCV	AUTO	
Positioner Type	0018,1508	CS	NONE	ALWAYS	AUTO	
Anatomic Region Sequence	0008,2218	SQ		ALWAYS	AUTO	
View Code Sequence	0054,0220	SQ		ALWAYS	AUTO	Filled with mapping of Viewposition according to DICOM-table Context ID 4014
>View Modifier Code Sequence	0054,0222	SQ		EMPTY	AUTO	Always empty
>Code Meaning	0008,0104	LO		ALWAYS	AUTO	
>Code Value	0008,0100	SH		ALWAYS	AUTO	
>Coding Scheme Designator	0008,0102	SH		ALWAYS	AUTO	

Table 126: Mammography Series Module

Attribute Name	Tag	VR	Value	Presence of Value	Source	Comment
Modality	0008,0060	CS	MG	ALWAYS	AUTO	

Table 127: X-Ray Acquisition Dose Module

Attribute Name	Tag	VR	Value	Presence of Value	Source	Comment
Comments on Radiation Dose	0040,0310	ST		ANAP	AUTO	
Image and Fluoroscopy Area Dose Product	0018,115E	DS		ANAP	AUTO	
Relative X-ray Exposure	0018,1405	IS		ANAP	AUTO	

Table 128: DX Series Module

Attribute Name	Tag	VR	Value	Presence of Value	Source	Comment
Presentation Intent Type	0008,0068	CS	FOR PROCESSING	ALWAYS	AUTO	
Referenced Performed Procedure Step Sequence	0008,1111	SQ		ANAPEV	AUTO	
>Referenced SOP Class UID	0008,1150	UI		ANAPEV	AUTO	
>Referenced SOP Instance UID	0008,1155	UI		ANAPEV	AUTO	

Table 129: DX Positioning Module

Attribute Name	Tag	VR	Value	Presence of Value	Source	Comment
Positioner Type	0018,1508	CS		VNAP	AUTO	
View Position	0018,5101	CS		ANAP	AUTO	

Table 130: Patient Module

Attribute Name	Tag	VR	Value	Presence of Value	Source	Comment
Ethnic Group	0010,2160	SH		ANAP	MWL, USER	
Issuer of Patient ID	0010,0021	LO		ANAP	MWL, USER	
Other Patient IDs	0010,1000	LO		ANAP	MWL, USER	
Patient Comments	0010,4000	LT		ANAP	MWL, USER	
Patient ID	0010,0020	LO		ALWAYS	MWL, USER	
Patient's Birth Date	0010,0030	DA		VNAP	MWL, USER	
Patient's Name	0010,0010	PN		VNAP	MWL, USER	
Patient's Sex	0010,0040	CS		VNAP	MWL, USER	

Table 131: General Study Module

Attribute Name	Tag	VR	Value	Presence of Value	Source	Comment
Accession Number	0008,0050	SH		VNAP	MWL, USER	
Referring Physician's Name	0008,0090	PN		VNAP	MWL, USER	
Study Date	0008,0020	DA		ALWAYS	MPPS	
Study Description	0008,1030	LO		ANAP	MWL, USER	
Study ID	0020,0010	SH		VNAP	AUTO, MPPS	
Study Instance UID	0020,000D	UI		ALWAYS	AUTO, MPPS	
Study Time	0008,0030	TM		ALWAYS	MPPS	
Procedure Code Sequence	0008,1032	SQ		ANAP	MWL	
>Code Meaning	0008,0104	LO		ALWAYS	MWL	
>Code Value	0008,0100	SH		ALWAYS	MWL	
>Coding Scheme Designator	0008,0102	SH		ALWAYS	MWL	
>Coding Scheme Version	0008,0103	SH		ANAP	MWL	

Table 132: Patient Study Module

Attribute Name	Tag	VR	Value	Presence of Value	Source	Comment
Additional Patient History	0010,21B0	LT		ANAP	MWL, USER	
Patient's Size	0010,1020	DS		ANAP	MWL, USER	
Patient's Weight	0010,1030	DS		ANAP	MWL, USER	

Table 133: General Series Module

Attribute Name	Tag	VR	Value	Presence of Value	Source	Comment
Body Part Examined	0018,0015	CS		ANAP	MPPS, USER	
Comments on the Performed Procedure Step	0040,0280	ST		ANAP	AUTO	
Operators' Name	0008,1070	PN		ANAP	MPPS, USER	

Performed Procedure Step Description	0040,0254	LO		ANAP	AUTO, MPPS	
Performed Procedure Step ID	0040,0253	SH		ANAP	AUTO, MPPS	
Performed Procedure Step Start Date	0040,0244	DA		ANAP	AUTO, MPPS	
Performed Procedure Step Start Time	0040,0245	TM		ANAP	AUTO, MPPS	
Performing Physician's Name	0008,1050	PN		ANAP	MPPS, USER	
Protocol Name	0018,1030	LO		ANAP	MWL, USER	
Series Date	0008,0021	DA		ANAP	MPPS	
Series Description	0008,103E	LO		ANAP	MPPS, USER	
Series Instance UID	0020,000E	UI		ALWAYS	AUTO, MPPS	
Series Number	0020,0011	IS		VNAP	AUTO, MPPS	
Series Time	0008,0031	TM		ANAP	MPPS	
Performed Protocol Code Sequence	0040,0260	SQ		ANAP	MWL	
>Code Meaning	0008,0104	LO		ALWAYS	MWL	
>Code Value	0008,0100	SH		ALWAYS	MWL	
>Coding Scheme Designator	0008,0102	SH		ALWAYS	MWL	
>Coding Scheme Version	0008,0103	SH		ANAP	MWL	

Table 134: General Equipment Module

Attribute Name	Tag	VR	Value	Presence of Value	Source	Comment
Device Serial Number	0018,1000	LO		ALWAYS	CONFIG	
Institution Address	0008,0081	ST		ALWAYS	CONFIG	
Institution Name	0008,0080	LO		ALWAYS	CONFIG	
Institutional Department Name	0008,1040	LO		ALWAYS	CONFIG	
Manufacturer	0008,0070	LO	Philips Medical Systems	ALWAYS	AUTO	
Manufacturer's Model Name	0008,1090	LO	PCR Eleva	ALWAYS	AUTO	
Software Version(s)	0018,1020	LO		ALWAYS	AUTO	
Spatial Resolution	0018,1050	DS		ALWAYS	AUTO	
Station Name	0008,1010	SH		ALWAYS	CONFIG	

Table 135: Contrast/Bolus Module

Attribute Name	Tag	VR	Value	Presence of Value	Source	Comment
Contrast/Bolus Agent	0018,0010	LO		VNAP	AUTO	

Table 136: Display Shutter Module

Attribute Name	Tag	VR	Value	Presence of Value	Source	Comment
Center of Circular Shutter	0018,1610	IS		ANAPEV	AUTO	
Radius of Circular Shutter	0018,1612	IS		ANAPEV	AUTO	
Shutter Left Vertical Edge	0018,1602	IS		ANAPEV	AUTO	
Shutter Lower Horizontal Edge	0018,1608	IS		ANAPEV	AUTO	
Shutter Right Vertical Edge	0018,1604	IS		ANAPEV	AUTO	
Shutter Shape	0018,1600	CS		ALWAYS	AUTO	
Shutter Upper Horizontal Edge	0018,1606	IS		ANAPEV	AUTO	
Vertices of the Polygonal Shutter	0018,1620	IS		ANAPEV	AUTO	

Table 137: Acquisition Context Module

Attribute Name	Tag	VR	Value	Presence of Value	Source	Comment
Acquisition Context Sequence	0040,0555	SQ		VNAP	AUTO	

Table 138: General Image Module

Attribute Name	Tag	VR	Value	Presence of Value	Source	Comment
Acquisition Date	0008,0022	DA		ALWAYS	AUTO	
Acquisition Time	0008,0032	TM		ALWAYS	AUTO	
Content Date	0008,0023	DA		ALWAYS	AUTO	
Content Time	0008,0033	TM		ALWAYS	AUTO	
Instance Number	0020,0013	IS		VNAP	AUTO	

Table 139: Image Pixel Module

Attribute Name	Tag	VR	Value	Presence of Value	Source	Comment
Columns	0028,0011	US		ALWAYS	AUTO	
Pixel Aspect Ratio	0028,0034	IS	1, 1	ANAP	AUTO	
Pixel Data	7FE0,0010	OW /OB		ALWAYS	AUTO	
Rows	0028,0010	US		ALWAYS	AUTO	

Table 140: X-Ray Tomography Acquisition Module

Attribute Name	Tag	VR	Value	Presence of Value	Source	Comment
Tomo Layer Height	0018,1460	DS		ALWAYS	AUTO	

Table 141: X-Ray Collimator Module

Attribute Name	Tag	VR	Value	Presence of Value	Source	Comment
Collimator Left Vertical Edge	0018,1702	IS		ANAPEV	AUTO	
Collimator Lower Horizontal Edge	0018,1708	IS		ANAPEV	AUTO	
Collimator Right Vertical Edge	0018,1704	IS		ANAPEV	AUTO	
Collimator Shape	0018,1700	CS		ALWAYS	AUTO	
Collimator Upper Horizontal Edge	0018,1706	IS		ANAPEV	AUTO	

Table 142: SOP Common Module

Attribute Name	Tag	VR	Value	Presence of Value	Source	Comment
SOP Class UID	0008,0016	UI		ANAPEV	AUTO	
SOP Instance UID	0008,0018	UI		ANAPEV	AUTO	
Specific Character Set	0008,0005	CS		ANAPEV	AUTO	

Table 143: Overlay Plane Module

Attribute Name	Tag	VR	Value	Presence of Value	Source	Comment
Overlay Bit Position	6000,0102	US		ALWAYS	AUTO	
Overlay Bits Allocated	6000,0100	US		ALWAYS	AUTO	
Overlay Columns	6000,0011	US		ALWAYS	AUTO	
Overlay Data	6000,3000	O W/ OB		ANAPEV	AUTO	
Overlay Origin	6000,0050	SS		ALWAYS	AUTO	

Overlay Rows	6000,0010	US		ALWAYS	AUTO	
Overlay Type	6000,0040	CS		ALWAYS	AUTO	

Table 144: Additional Module

Attribute Name	Tag	VR	Value	Presence of Value	Source	Comment
Medical Alerts	0010,2000	LO		VNAP	MWL, USER	
Contrast Allergies	0010,2110	LO		VNAP	MWL, USER	
Pregnancy Status	0010,21C0	US		VNAP	MWL, USER	
Pixel Spacing	0028,0030	DS		VNAP	AUTO	
Requesting Physician	0032,1032	PN		VNAP	MWL, USER	
Requesting Service	0032,1033	LO		VNAP	MWL, USER	
Requested Procedure Description	0032,1060	LO		VNAP	MWL, USER	
Special Needs	0038,0050	LO		VNAP	MWL, USER	
Patient State	0038,0500	LO		VNAP	MWL, USER	
Performed Station AE Title	0040,0241	AE		VNAP	AUTO, MPPS	
Performed Procedure Step End Date	0040,0250	DA		VNAP	AUTO, MPPS	
Performed Procedure Step End Time	0040,0251	TM		VNAP	AUTO, MPPS	
Performed Procedure Step Status	0040,0252	CS		VNAP	AUTO, MPPS	
Total Time of Fluoroscopy	0040,0300	US		VNAP	AUTO	
Total Number of Exposures	0040,0301	US		VNAP	AUTO	
Requested Procedure ID	0040,1001	SH		VNAP	AUTO, MWL	
Reason for the Requested Procedure	0040,1002	LO		VNAP	MWL	
Requested Procedure Priority	0040,1003	SH		VNAP	MWL	
Patient Transport Arrangements	0040,1004	LO		VNAP	MWL, USER	
Names of Intended Recipients of Results	0040,1010	PN		VNAP	AUTO	
Requested Procedure Comments	0040,1400	LT		VNAP	MWL	
Reason for the Imaging Service Request (RETIRED)	0040,2001	LO		ALWAYS	MWL	
Issue Date of Imaging Service Request	0040,2004	DA		ANAP	AUTO	
Imaging Service Request Comments	0040,2400	LT		ALWAYS	MWL, USER	
Film Consumption Sequence	0040,0321	SQ		VNAP	AUTO	

8.1.1.7. Digital Mammography X-Ray Image Storage - Pres. SOP

Table 145: IOD of Created Digital Mammography X-Ray Image Storage - Pres. SOP Instances

Information Entity	Module	Presence Of Module
Patient	Patient Module	ALWAYS
Study	General Study Module	ALWAYS
Study	Patient Study Module	CONDITIONAL
Series	General Series Module	ALWAYS
Series	DX Series Module	ALWAYS
Series	Mammography Series Module	ALWAYS
Equipment	General Equipment Module	ALWAYS
Image	General Image Module	ALWAYS
Image	Image Pixel Module	ALWAYS
Image	Contrast/Bolus Module	CONDITIONAL
Image	Display Shutter Module	CONDITIONAL
Image	Acquisition Context Module	ALWAYS
Image	X-Ray Tomography Acquisition Module	CONDITIONAL
Image	X-Ray Collimator Module	CONDITIONAL
Image	Overlay Plane Module	CONDITIONAL
Image	SOP Common Module	ALWAYS
Image	DX Detector Module	ALWAYS
Image	DX Image Module	ALWAYS
Image	DX Positioning Module	CONDITIONAL
Image	Mammography Image Module	ALWAYS
Image	X-Ray Acquisition Dose Module	CONDITIONAL
	Additional Module	ALWAYS

Table 146: DX Detector Module

Attribute Name	Tag	VR	Value	Presence of Value	Source	Comment
Detector Type	0018,7004	CS		VNAP	AUTO	
Imager Pixel Spacing	0018,1164	DS		ALWAYS	AUTO	
Sensitivity	0018,6000	DS		VNAP	AUTO	

Table 147: DX Image Module

Attribute Name	Tag	VR	Value	Presence of Value	Source	Comment
Acquisition Device Processing Description	0018,1400	LO		ANAP	AUTO	
Bits Allocated	0028,0100	US	16	ALWAYS	AUTO	
Bits Stored	0028,0101	US	10, 12, 15	ALWAYS	CONFIG	
Burned In Annotation	0028,0301	CS		ALWAYS	CONFIG	
Calibration Image	0050,0004	CS		VNAP	AUTO	
High Bit	0028,0102	US	11, 14, 9	ALWAYS	AUTO	
Image Type	0008,0008	CS	ORIGINAL, PRIMARY	ALWAYS	AUTO	
Lossy Image Compression	0028,2110	CS	00	ALWAYS	AUTO	
Patient Orientation	0020,0020	CS		ALWAYS	AUTO	
Photometric Interpretation	0028,0004	CS	MONOCHROME2	ALWAYS	AUTO	
Pixel Intensity Relationship	0028,1040	CS	LOG	ALWAYS	AUTO	
Pixel Intensity Relationship Sign	0028,1041	SS	1	ALWAYS	AUTO	
Pixel Representation	0028,0103	US		ALWAYS	AUTO	
Presentation LUT Shape	2050,0020	CS	IDENTITY	ALWAYS	AUTO	
Rescale Intercept	0028,1052	DS		ALWAYS	AUTO	
Rescale Slope	0028,1053	DS		ALWAYS	AUTO	
Rescale Type	0028,1054	LO		ALWAYS	AUTO	

Samples per Pixel	0028,0002	US		ALWAYS	AUTO	
Window Center	0028,1050	DS	2047.0	ANAP	AUTO	
Window Width	0028,1051	DS	4095.0	ANAP	AUTO	

Table 148: DX Series Module

Attribute Name	Tag	VR	Value	Presence of Value	Source	Comment
Presentation Intent Type	0008,0068	CS	FOR PRESENTATION	ALWAYS	AUTO	
Referenced Performed Procedure Step Sequence	0008,1111	SQ		ANAP	AUTO	
>Referenced SOP Class UID	0008,1150	UI	1.2.840.10008.3.1.2.3.3	ANAP	AUTO	
>Referenced SOP Instance UID	0008,1155	UI		ANAP	AUTO	

Table 149: DX Positioning Module

Attribute Name	Tag	VR	Value	Presence of Value	Source	Comment
View Position	0018,5101	CS		ANAP	AUTO	

Table 150: Mammography Image Module

Attribute Name	Tag	VR	Value	Presence of Value	Source	Comment
Image Laterality	0020,0062	CS		ALWAYS	AUTO	
Organ Exposed	0040,0318	CS	BREAST	ALWAYS	AUTO	
Positioner Type	0018,1508	CS	NONE	ALWAYS	AUTO	
Anatomic Region Sequence	0008,2218	SQ		ALWAYS	AUTO	
>Code Meaning	0008,0104	LO		ALWAYS	AUTO	
>Code Value	0008,0100	SH		ALWAYS	AUTO	
>Coding Scheme Designator	0008,0102	SH		ALWAYS	AUTO	
View Code Sequence	0054,0220	SQ		ALWAYS	AUTO	Filled with mapping of View position according to DICOM-table Context ID 4014
>View Modifier Code Sequence	0054,0222	SQ		EMPTY	AUTO	Always empty
>Code Meaning	0008,0104	LO		ALWAYS	AUTO	
>Code Value	0008,0100	SH		ALWAYS	AUTO	
>Coding Scheme Designator	0008,0102	SH		ALWAYS	AUTO	

Table 151: Mammography Series Module

Attribute Name	Tag	VR	Value	Presence of Value	Source	Comment
Modality	0008,0060	CS	MG	ALWAYS	AUTO	

Table 152: X-Ray Acquisition Dose Module

Attribute Name	Tag	VR	Value	Presence of Value	Source	Comment
Comments on Radiation Dose	0040,0310	ST		ANAP	AUTO	
Image and Fluoroscopy Area Dose Product	0018,115E	DS		ANAP	AUTO	
Relative X-ray Exposure	0018,1405	IS		ANAP	AUTO	

Table 153: Patient Module

Attribute Name	Tag	VR	Value	Presence of Value	Source	Comment
Ethnic Group	0010,2160	SH		ANAP	MWL, USER	
Issuer of Patient ID	0010,0021	LO		ANAP	MWL, USER	

Other Patient IDs	0010,1000	LO		ANAP	MWL, USER	
Patient Comments	0010,4000	LT		ANAP	MWL, USER	
Patient ID	0010,0020	LO		ALWAYS	MWL, USER	
Patient's Birth Date	0010,0030	DA		VNAP	MWL, USER	
Patient's Name	0010,0010	PN		VNAP	MWL, USER	
Patient's Sex	0010,0040	CS	F, M, O	VNAP	MWL, USER	

Table 154: General Study Module

Attribute Name	Tag	VR	Value	Presence of Value	Source	Comment
Accession Number	0008,0050	SH		VNAP	MWL, USER	
Referring Physician's Name	0008,0090	PN		VNAP	MWL, USER	
Study Date	0008,0020	DA		VNAP	MPPS	
Study Description	0008,1030	LO		ANAPCV	MWL, USER	
Study ID	0020,0010	SH		VNAP	AUTO, MPPS	
Study Instance UID	0020,000D	UI		ALWAYS	AUTO, MPPS	
Study Time	0008,0030	TM		VNAP	MPPS	
Procedure Code Sequence	0008,1032	SQ		ANAP	MWL	
>Code Meaning	0008,0104	LO		ALWAYS	MWL	
>Code Value	0008,0100	SH		ALWAYS	MWL	
>Coding Scheme Designator	0008,0102	SH		ALWAYS	MWL	
>Coding Scheme Version	0008,0103	SH		ANAP		

Table 155: Patient Study Module

Attribute Name	Tag	VR	Value	Presence of Value	Source	Comment
Additional Patient History	0010,21B0	LT		ANAP	MWL, USER	
Patient's Size	0010,1020	DS		ANAP	MWL, USER	
Patient's Weight	0010,1030	DS		ANAP	MWL, USER	

Table 156: General Series Module

Attribute Name	Tag	VR	Value	Presence of Value	Source	Comment
Body Part Examined	0018,0015	CS		ANAP	MPPS, USER	
Comments on the Performed Procedure Step	0040,0280	ST		ANAP	AUTO	
Operators' Name	0008,1070	PN		ANAP	MPPS, USER	
Performed Procedure Step Description	0040,0254	LO		ANAP	AUTO, MPPS	
Performed Procedure Step ID	0040,0253	SH		ANAP	AUTO, MPPS	
Performed Procedure Step Start Date	0040,0244	DA		ANAP	AUTO, MPPS	
Performed Procedure Step Start Time	0040,0245	TM		ANAP	AUTO, MPPS	

Performing Physician's Name	0008,1050	PN		ANAP	MPPS, USER	
Protocol Name	0018,1030	LO		ANAP	MWL, USER	
Series Date	0008,0021	DA		ANAP	MPPS	
Series Description	0008,103E	LO		ANAP	MPPS, USER	
Series Instance UID	0020,000E	UI		ALWAYS	AUTO, MPPS	
Series Number	0020,0011	IS		VNAP	AUTO, MPPS	
Series Time	0008,0031	TM		ANAP	MPPS	
Performed Protocol Code Sequence	0040,0260	SQ		ANAP	MWL	
>Code Meaning	0008,0104	LO		ALWAYS	MWL	
>Code Value	0008,0100	SH		ALWAYS	MWL	
>Coding Scheme Designator	0008,0102	SH		ALWAYS	MWL	
>Coding Scheme Version	0008,0103	SH		ANAP	MWL	

Table 157: General Equipment Module

Attribute Name	Tag	VR	Value	Presence of Value	Source	Comment
Device Serial Number	0018,1000	LO		ALWAYS	CONFIG	
Institution Address	0008,0081	ST		ALWAYS	CONFIG	
Institution Name	0008,0080	LO		ALWAYS	CONFIG	
Institutional Department Name	0008,1040	LO		ALWAYS	CONFIG	
Manufacturer	0008,0070	LO	Philips Medical Systems	ALWAYS	AUTO	
Manufacturer's Model Name	0008,1090	LO	PCR Eleva	ALWAYS	AUTO	
Software Version(s)	0018,1020	LO		ALWAYS	AUTO	
Spatial Resolution	0018,1050	DS		ALWAYS	AUTO	
Station Name	0008,1010	SH		ALWAYS	CONFIG	

Table 158: General Image Module

Attribute Name	Tag	VR	Value	Presence of Value	Source	Comment
Acquisition Date	0008,0022	DA		ALWAYS	AUTO	
Acquisition Time	0008,0032	TM		ALWAYS	AUTO	
Content Date	0008,0023	DA		ALWAYS	AUTO	
Content Time	0008,0033	TM		ALWAYS	AUTO	
Instance Number	0020,0013	IS		VNAP	AUTO	

Table 159: Image Pixel Module

Attribute Name	Tag	VR	Value	Presence of Value	Source	Comment
Columns	0028,0011	US		ALWAYS	AUTO	
Pixel Aspect Ratio	0028,0034	IS		ANAPEV	AUTO	
Pixel Data	7FE0,0010	O W/ OB		ALWAYS	AUTO	
Rows	0028,0010	US		ALWAYS	AUTO	

Table 160: Contrast/Bolus Module

Attribute Name	Tag	VR	Value	Presence of Value	Source	Comment
Contrast/Bolus Agent	0018,0010	LO		VNAP	AUTO	

Table 161: Display Shutter Module

Attribute Name	Tag	VR	Value	Presence of Value	Source	Comment
Center of Circular Shutter	0018,1610	IS		ANAPEV	AUTO	
Radius of Circular Shutter	0018,1612	IS		ANAPEV	AUTO	
Shutter Left Vertical Edge	0018,1602	IS		ANAPEV	AUTO	
Shutter Lower Horizontal Edge	0018,1608	IS		ANAPEV	AUTO	
Shutter Right Vertical Edge	0018,1604	IS		ANAPEV	AUTO	
Shutter Shape	0018,1600	CS		ALWAYS	AUTO	
Shutter Upper Horizontal Edge	0018,1606	IS		ANAPEV	AUTO	
Vertices of the Polygonal Shutter	0018,1620	IS		ANAPEV	AUTO	

Table 162: Acquisition Context Module

Attribute Name	Tag	VR	Value	Presence of Value	Source	Comment
Acquisition Context Sequence	0040,0555	SQ		VNAP	AUTO	

Table 163: X-Ray Tomography Acquisition Module

Attribute Name	Tag	VR	Value	Presence of Value	Source	Comment
Tomo Layer Height	0018,1460	DS		ALWAYS	AUTO	

Table 164: X-Ray Collimator Module

Attribute Name	Tag	VR	Value	Presence of Value	Source	Comment
Collimator Left Vertical Edge	0018,1702	IS		ANAPEV	AUTO	
Collimator Lower Horizontal Edge	0018,1708	IS		ANAPEV	AUTO	
Collimator Right Vertical Edge	0018,1704	IS		ANAPEV	AUTO	
Collimator Shape	0018,1700	CS		ALWAYS	AUTO	
Collimator Upper Horizontal Edge	0018,1706	IS		ANAPEV	AUTO	

Table 165: Overlay Plane Module

Attribute Name	Tag	VR	Value	Presence of Value	Source	Comment
Overlay Bit Position	6000,0102	US		ALWAYS	AUTO	
Overlay Bits Allocated	6000,0100	US		ALWAYS	AUTO	
Overlay Columns	6000,0011	US		ALWAYS	AUTO	
Overlay Data	6000,3000	O W/ OB		ANAPEV	AUTO	
Overlay Origin	6000,0050	SS		ALWAYS	AUTO	
Overlay Rows	6000,0010	US		ALWAYS	AUTO	
Overlay Type	6000,0040	CS		ALWAYS	AUTO	

Table 166: SOP Common Module

Attribute Name	Tag	VR	Value	Presence of Value	Source	Comment
SOP Class UID	0008,0016	UI		ALWAYS	AUTO	
SOP Instance UID	0008,0018	UI		ALWAYS	AUTO	
Specific Character Set	0008,0005	CS		ANAPEV	AUTO	

Table 167: Additional Module

Attribute Name	Tag	VR	Value	Presence of Value	Source	Comment
Medical Alerts	0010,2000	LO		VNAP	MWL, USER	
Contrast Allergies	0010,2110	LO		VNAP	MWL, USER	
Pregnancy Status	0010,21C0	US		VNAP	MWL, USER	
Pixel Spacing	0028,0030	DS		VNAP	AUTO	
Requesting Physician	0032,1032	PN		VNAP	MWL, USER	
Requesting Service	0032,1033	LO		VNAP	MWL, USER	
Requested Procedure Description	0032,1060	LO		VNAP	MWL, USER	
Special Needs	0038,0050	LO		VNAP	MWL, USER	
Patient State	0038,0500	LO		VNAP	MWL, USER	
Performed Station AE Title	0040,0241	AE		VNAP	AUTO, MPPS	
Performed Procedure Step End Date	0040,0250	DA		VNAP	AUTO, MPPS	
Performed Procedure Step End Time	0040,0251	TM		VNAP	AUTO, MPPS	
Performed Procedure Step Status	0040,0252	CS		VNAP	AUTO, MPPS	
Total Number of Exposures	0040,0301	US		VNAP	AUTO	
Requested Procedure ID	0040,1001	SH		VNAP	AUTO, MWL	
Reason for the Requested Procedure	0040,1002	LO		VNAP	MWL	
Requested Procedure Priority	0040,1003	SH		VNAP	MWL	
Patient Transport Arrangements	0040,1004	LO		VNAP	MWL, USER	
Names of Intended Recipients of Results	0040,1010	PN		VNAP	AUTO	
Requested Procedure Comments	0040,1400	LT		VNAP	MWL	
Reason for the Imaging Service Request (RETIRED)	0040,2001	LO		VNAP	MWL	
Issue Date of Imaging Service Request	0040,2004	DA		VNAP	AUTO	
Imaging Service Request Comments	0040,2400	LT		VNAP	MWL, USER	
Film Consumption Sequence	0040,0321	SQ		VNAP	AUTO	

8.1.2. Usage of Attributes from Received IOD

The PCR Eleva has only an export side. The modality cannot read/view images from a CD or by import.

8.1.3. Attribute Mapping

In this section is specified the mapping between the Modality Worklist, Storage and Modality Performed Procedure Step.

Table 168: Attribute mapping during Modality Workflow

Name	WLM tag	MPPS Create tag	MPPS Set tag	Image IOD tag
Accession Number	0008,0050	0008,0050	-	0008,0050
Modality	-	0008,0060	-	0008,0060
Referring Physician's Name	0008,0090	-	-	0008,0090
Operator's Name	-	-	0008,1070	0008,1070
Referenced Study Sequence	0008,1110	0008,1110	-	0008,1110
Referenced Image Sequence (0008,1140)>Referenced SOP Class UID	-	-	0008,1150	0008,0016
SOP Class UID				
Referenced Image Sequence (0008,1140)>Referenced SOP Instance UID	-	-	0008,1155	0008,0018
SOP Instance UID				
Patient's Name	0010,0010	0010,0010	-	0010,0010
Patient ID	0010,0020	0010,0020	-	0010,0020
Issuer of Patient ID	0010,0021	0010,0021	-	0010,0021
Patient's Birth Date	0010,0030	0010,0030	-	0010,0030
Patient's Sex	0010,0040	0010,0040	-	0010,0040
Other Patient IDs	0010,1000	0010,1000	-	0010,1000
Medical Alerts	0010,2000	-	-	0010,2000
Contrast Allergies	0010,2110	-	-	0010,2110
Ethnic group	0010,2160	-	-	0010,2160
Additional Patient History	0010,21B0	-	-	0010,21B0
Pregnancy Status	0010,21C0	-	-	0010,21C0
Patient Comments	0010,4000	-	-	0010,4000
Protocol Name	-	-	0018,1030	0018,1030
Study Instance UID	0020,000D	0020,000E	-	0020,000D
Series Instance UID	-	-	0020,000E	0020,000E
Study ID	-	0020,0010	-	0020,0010
Requesting Service	0032,1033	-	-	0032,1033
Requested Procedure Description	0032,1060	0032,1060	-	-
Requested Procedure Code Sequence ³	0032,1064	0008,1032	0008,1032	0008,1032
Performed Procedure Code Sequence				
Special Needs	0038,0050	-	-	0038,0050
Patient State	0038,0500	-	-	0038,0500
Scheduled Procedure Step Description ⁴	0040,0007	0040,007	-	0040,0007
Performed Procedure Step Description		0040,0254		0040,0254
Scheduled Protocol Code Sequence ⁴	0040,0008	0040,0260	0040,0260	0040,0008
Performed Protocol Code Sequence				0040,0260
Scheduled Procedure Step ID	0040,0009	0040,0009	-	0040,0009
Performed Procedure Step Start Date	-	0040,0244	-	0040,0244
Performed Procedure Step Start Time	-	0040,0245	-	0040,0245
Performed Procedure Step ID	-	0040,0253	-	0040,0253
Request Procedure ID	0040,1001	0040,1001	-	0040,1001

Note 1: Value accumulated from all performed acquisitions including dropped (repeated) acquisitions.

Note 2: Images related specific value.

Note 3: If procedure is performed as requested.

Note 4: If protocol is performed as scheduled.

8.1.4. Coerced/Modified fields

Not applicable

8.2. Data Dictionary of Private Attributes

Not applicable

8.3. Coded Terminology and Templates

This application support the following Coded Terminology and templates as described in the sub-sections.

8.3.1. Context Groups

Not applicable

8.3.2. Template Specifications

Not applicable

8.3.3. Private code definitions

Not applicable

8.4. Grayscale Image consistency

The monitor of PCR Eleva system can be calibrated according Grayscale Display Function standard.

The pixel values exported and printed should be interpreted as P-Value. If the export destination or the printer does not support GSDF, PCR Eleva provides calibration tools to adapt to this device to afford grayscale images consistency. The calibration takes into account ambient luminance and lightbox luminance.

8.5. Standard Extended/Specialized/Private SOPs

Not applicable

8.6. Private Transfer Syntaxes

Not applicable