

DICOM Conformance Statement

BV Vectra



Issued by:

Philips Medical Systems Nederland BV, a Philips Healthcare company,

P.O. Box 10.000
5680 DA Best
The Netherlands

Email: dicom@philips.com

Internet: <http://www.healthcare.philips.com/connectivity>

Document Number: PIIOffc.0001460

Date : 17-November-2014

1. DICOM Conformance Statement Overview

BV Vectra is interoperable with systems providing a DICOM interface. Clinical users can select patient image data for data transfer or print. BV Vectra stores new acquired medical data in its local storage. The local storage has a limited capacity and is not intended for long term archiving purposes. Long term storage will be done by either printing the data, exporting data to removable media or exporting the data to a PACS.

Table 1: Network Services

SOP Class		User of Service (SCU)	Provider of Service (SCP)	Display
Name	UID			
Other				
Verification SOP Class	1.2.840.10008.1.1	Yes	Yes	N/A
Print Management				
Basic Grayscale Print Management Meta SOP Class	1.2.840.10008.5.1.1.9	Yes	No	N/A
>Basic Film Box SOP Class	1.2.840.10008.5.1.1.2	Yes	No	N/A
>Basic Film Session SOP Class	1.2.840.10008.5.1.1.1	Yes	No	N/A
>Basic Grayscale Image Box SOP Class	1.2.840.10008.5.1.1.4	Yes	No	N/A
>Printer SOP Class	1.2.840.10008.5.1.1.16	Yes	No	N/A
Query/Retrieve				
Patient Root QR Information Model - FIND SOP Class	1.2.840.10008.5.1.4.1.2.1.1	Yes	No	N/A
Patient Root QR Information Model - MOVE SOP Class	1.2.840.10008.5.1.4.1.2.1.2	Yes	No	N/A
PatientStudy Only QR Info. Model - FIND SOP Class (Retired)	1.2.840.10008.5.1.4.1.2.3.1	Yes	No	N/A
PatientStudy Only QR Info. Model - MOVE SOP Class (Retired)	1.2.840.10008.5.1.4.1.2.3.2	Yes	No	N/A
Study Root QR Information Model - FIND SOP Class	1.2.840.10008.5.1.4.1.2.2.1	Yes	No	N/A
Study Root QR Information Model - MOVE SOP Class	1.2.840.10008.5.1.4.1.2.2.2	Yes	No	N/A
Transfer				
Grayscale Softcopy Presentation State Storage SOP Class	1.2.840.10008.5.1.4.1.1.11.1	Yes	Yes	N/A
Multi-frame Grayscale Word SC Image Storage SOP Class	1.2.840.10008.5.1.4.1.1.7.3	Yes	Yes	N/A
Secondary Capture Image Storage SOP Class	1.2.840.10008.5.1.4.1.1.7	Yes	Yes	N/A
X-Ray Angiographic Image Storage SOP Class	1.2.840.10008.5.1.4.1.1.12.1	Yes	Yes	N/A
X-Ray Radiation Dose SR SOP Class	1.2.840.10008.5.1.4.1.1.88.67	Yes	No	N/A
Workflow Management				
Storage Commitment Push Model SOP Class	1.2.840.10008.1.20.1	Yes	No	N/A

*Only import of data created by BV Vectra itself is supported. For other SC/XA data, quality of imported data is not guaranteed. A table of Supported Media Storage Application Profiles (with roles) is provided.

Table 2: Media Services

Media Storage Application Profile	File-set Creator (FSC)	File-set Updater (FSU)	File-set Reader (FSR)
DVD			
General Purpose DVD Interchange with JPEG	Yes	No	Yes
General Purpose DVD Interchange with JPEG 2000	Yes	No	Yes
USB			
General Purpose USB Media	Yes	Yes	Yes

2. Table of Contents

1.	DICOM CONFORMANCE STATEMENT OVERVIEW	3
2.	TABLE OF CONTENTS	4
3.	INTRODUCTION	6
3.1.	REVISION HISTORY	6
3.2.	AUDIENCE	6
3.3.	REMARKS	6
3.4.	DEFINITIONS, TERMS AND ABBREVIATIONS	7
3.5.	REFERENCES	8
4.	NETWORKING	9
4.1.	IMPLEMENTATION MODEL	9
4.1.1.	Application Data Flow	9
4.1.2.	Functional Definition of AE's	10
4.1.2.1.	Functional Definition of BV Vectra Network AE	10
4.1.3.	Sequencing of Real World Activities	11
4.2.	AE SPECIFICATIONS	11
4.2.1.	BV Vectra Network AE	11
4.2.1.1.	SOP Classes	11
4.2.1.2.	Association Policies	12
4.2.1.2.1.	General	12
4.2.1.2.2.	Number of Associations	12
4.2.1.2.3.	Asynchronous Nature	13
4.2.1.2.4.	Implementation Identifying Information	13
4.2.1.2.5.	Communication Failure Handling	13
4.2.1.3.	Association Initiation Policy	13
4.2.1.3.1.	(Real-World) Activity – Verification as SCU	14
4.2.1.3.2.	(Real-World) Activity – FIND as SCU	15
4.2.1.3.3.	(Real-World) Activity – MOVE as SCU	19
4.2.1.3.4.	(Real-World) Activity – Image Export	21
4.2.1.3.5.	(Real-World) Activity – Structure Report Export	24
4.2.1.3.6.	(Real-World) Activity – Storage Commitment Push Model as SCU	25
4.2.1.3.7.	(Real-World) Activity – Print Management as SCU	27
4.2.1.4.	Association Acceptance Policy	38
4.2.1.4.1.	(Real-World) Activity – Verification as SCP	40
4.2.1.4.2.	(Real-World) Activity – Image Import	40
4.3.	NETWORK INTERFACES	42
4.3.1.	Physical Network Interfaces	42
4.3.2.	Additional Protocols	42
4.4.	CONFIGURATION	42
4.4.1.	AE Title/Presentation Address Mapping	42
4.4.1.1.	Local AE Titles	42
4.4.1.2.	Remote AE Title/Presentation Address Mapping	43
4.4.2.	Parameters	43
5.	MEDIA INTERCHANGE	45
5.1.	IMPLEMENTATION MODEL	45
5.1.1.	Application Data Flow Diagram	45
5.1.2.	Functional Definitions of AE's	45
5.1.3.	Sequencing of Real World Activities	45
5.2.	AE SPECIFICATIONS	45
5.2.1.	BV Vectra Media - Specification	45
5.2.1.1.	File Meta Information for the BV Vectra Media	46
5.2.1.2.	Real-World Activities	46
5.2.1.2.1.	RWA - Read File-set	46
5.2.1.2.2.	RWA - Create File-set	46

5.3.	AUGMENTED AND PRIVATE APPLICATION PROFILES	47
5.3.1.	Augmented Application Profiles	47
5.3.1.1.	Augmented Application Profile Descriptions	47
5.3.1.1.1.	SOP Class Augmentations	47
5.3.1.1.2.	Directory Augmentations	47
5.3.1.1.3.	Other Augmentations.....	47
5.3.2.	Private Application Profiles.....	47
5.4.	MEDIA CONFIGURATION	47
6.	SUPPORT OF CHARACTER SETS	48
7.	SECURITY	49
7.1.	SECURITY PROFILES	49
7.1.1.	Security use Profiles	49
7.1.2.	Security Transport Connection Profiles	49
7.1.3.	Digital Signature Profiles	50
7.1.4.	Media Storage Security Profiles	50
7.1.5.	Attribute Confidentiality Profiles	50
7.1.6.	Network Address Management Profiles	50
7.1.7.	Time Synchronization Profiles	50
7.1.8.	Application Configuration Management Profiles.....	50
7.1.9.	Audit Trail Profiles	50
7.2.	ASSOCIATION LEVEL SECURITY	50
7.3.	APPLICATION LEVEL SECURITY	50
7.3.1.	Basic Application Level Confidentiality Profile.....	50
8.	ANNEXES OF APPLICATION "BV VECTRA"	52
8.1.	IOD CONTENTS	52
8.1.1.	Created SOP Instance	52
8.1.1.1.	List of created SOP Classes	53
8.1.1.2.	Secondary Capture Image Storage SOP Class.....	53
8.1.1.3.	Multi-frame Grayscale Word SC Image Storage SOP Class	55
8.1.1.4.	Grayscale Softcopy Presentation State Storage SOP Class	58
8.1.1.5.	X-Ray Angiographic Image Storage SOP Class.....	61
8.1.1.6.	X-Ray Radiation Dose SR SOP Class.....	65
8.1.2.	Usage of Attributes from Received IOD	67
8.1.3.	Attribute Mapping	67
8.1.4.	Coerced/Modified fields.....	67
8.2.	DATA DICTIONARY OF PRIVATE ATTRIBUTES	67
8.3.	CODED TERMINOLOGY AND TEMPLATES	67
8.3.1.	Context Groups	67
8.3.2.	Template Specifications	67
8.3.2.1.1.	TID 10001 Projection X-Ray Radiation Dose.....	68
8.3.2.1.2.	TID 10002 Accumulated X-Ray Dose.....	69
8.3.2.1.3.	TID 10003 Irradiation Event X-Ray Data	70
8.3.2.1.4.	TID 1002 Observer Context.....	71
8.3.2.1.5.	TID 1004 Device Observer Identifying Attributes	71
8.3.3.	Private code definitions	71
8.4.	GRAYSCALE IMAGE CONSISTENCY	71
8.5.	STANDARD EXTENDED/SPECIALIZED/PRIVATE SOPS	71
8.5.1.	Standard Extended/Specialized/Private SOP Instance	72
8.5.1.1.	Multi-frame Grayscale Word SC Image Storage SOP Class	72
8.5.1.2.	Secondary Capture Image Storage SOP Class.....	72
8.5.1.3.	Grayscale Softcopy Presentation State Storage SOP Class	72
8.5.1.4.	X-Ray Angiographic Image Storage SOP Class.....	72
8.6.	PRIVATE TRANSFER SYNTAXES	73

3. Introduction

3.1. Revision History

The revision history provides dates and differences of the different releases.

Table 3: Revision History

Document Version	Date of Issue	Status	Description
00	18-November-2014	Approved	Final version

3.2. Audience

This Conformance Statement is intended for:

- (Potential) customers
- System integrators of medical equipment
- Marketing staff interested in system functionality
- Software designers implementing DICOM interfaces

It is assumed that the reader is familiar with the DICOM standard.

3.3. Remarks

The DICOM Conformance Statement is contained in chapter 4 through 8 and follows the contents and structuring requirements of DICOM PS 3.2.

This DICOM Conformance Statement by itself does not guarantee successful interoperability of Philips equipment with non-Philips equipment. The user (or user's agent) should be aware of the following issues:

- **Interoperability**
Interoperability refers to the ability of application functions, distributed over two or more systems, to work successfully together. The integration of medical devices into an IT environment may require application functions that are not specified within the scope of DICOM. Consequently, using only the information provided by this Conformance Statement does not guarantee interoperability of Philips equipment with non-Philips equipment.
It is the user's responsibility to analyze thoroughly the application requirements and to specify a solution that integrates Philips equipment with non-Philips equipment.
- **Validation**
Philips equipment has been carefully tested to assure that the actual implementation of the DICOM interface corresponds with this Conformance Statement.
Where Philips equipment is linked to non-Philips equipment, the first step is to compare the relevant Conformance Statements. If the Conformance Statements indicate that successful information exchange should be possible, additional validation tests will be necessary to ensure the functionality, performance, accuracy and stability of image and image related data. It is the responsibility of the user (or user's agent) to specify the appropriate test suite and to carry out the additional validation tests.
- **New versions of the DICOM Standard**
The DICOM Standard will evolve in future to meet the user's growing requirements and to incorporate new features and technologies. Philips is actively involved in this evolution and plans to adapt its equipment to future versions of the DICOM Standard. In order to do so, Philips reserves the right to make changes to its products or to discontinue its delivery. The user should ensure that any non-Philips provider linking to Philips equipment also adapts to future versions of the DICOM Standard. If not, the incorporation of DICOM enhancements into Philips equipment may lead to loss of connectivity (in case of networking) and incompatibility (in case of media).

3.4. Definitions, Terms and Abbreviations

Table 4: Definitions, Terms and Abbreviations

Abbreviation/Term	Explanation
AE	Application Entity
ANSI	American National Standard Institute
AP	Application Profile
BOT	Basic Offset Table
CD	Compact Disc
CD-R	CD-Recordable
CD-M	CD-Medical
CR	Computed Radiography
CT	Computed Tomography
DCR	Dynamic Cardio Review
DICOM	Digital Imaging and Communications in Medicine
DIMSE	DICOM Message Service Element
DIMSE-C	DIMSE-Composite
DIMSE-N	DIMSE-Normalized
DX	Digital X-Ray
EBE	DICOM Explicit VR Big Endian
ELE	DICOM Explicit VR Little Endian
FSC	File-set Creator
FSR	File-set Reader
FSU	File-set Updater
GUI	Graphic User Interface
HIS	Hospital Information System
HL7	Health Level Seven
ILE	DICOM Implicit VR Little Endian
IOD	Information Object Definition
ISIS	Information System - Imaging System
MOD	Magneto-Optical Disk
MPPS	Modality Performed Procedure Step
NEMA	National Electrical Manufacturers Association
NM	Nuclear Medicine
PDU	Protocol Data Unit
RF	X-Ray Radiofluoroscopic
RIS	Radiology Information System
RT	Radiotherapy
RWA	Real-World Activity
SC	Secondary Capture
SCM	Study Component Management
SCP	Service Class Provider
SCU	Service Class User
SOP	Service Object Pair
TCP/IP	Transmission Control Protocol/Internet Protocol
UID	Unique Identifier
US	Ultrasound
WLM	Worklist Management
XA	X-Ray Angiographic

3.5. References

[DICOM] Digital Imaging and Communications in Medicine, Parts 1 - 20 (NEMA PS 3.1- PS 3.20),
National Electrical Manufacturers Association (NEMA) Publication Sales 1300 N. 17th Street, Suite 1752 Rosslyn, Virginia,
22209, United States of America.
Internet: <http://medical.nema.org/>

Note that at any point in time the official standard consists of the most recent yearly edition of the base standard (currently 2011) plus all the supplements and correction items that have been approved as Final Text.

4. Networking

This section contains the networking related services (vs. the media related ones).

4.1. Implementation model

The implementation model consists of three sections:

- The application data flow diagram, specifying the relationship between the Application Entities and the "external world" or Real-World Activities,
- A functional description of each Application Entity, and
- The sequencing constraints among them.

4.1.1. Application Data Flow

The BV Vectra implements one network application entity: the BV Vectra Network AE.

The following figure shows the networking application data flow as a functional overview of the application entity. On the left the local Real-World Activities are presented, whereas on the right the remote Real-World Activities are presented.

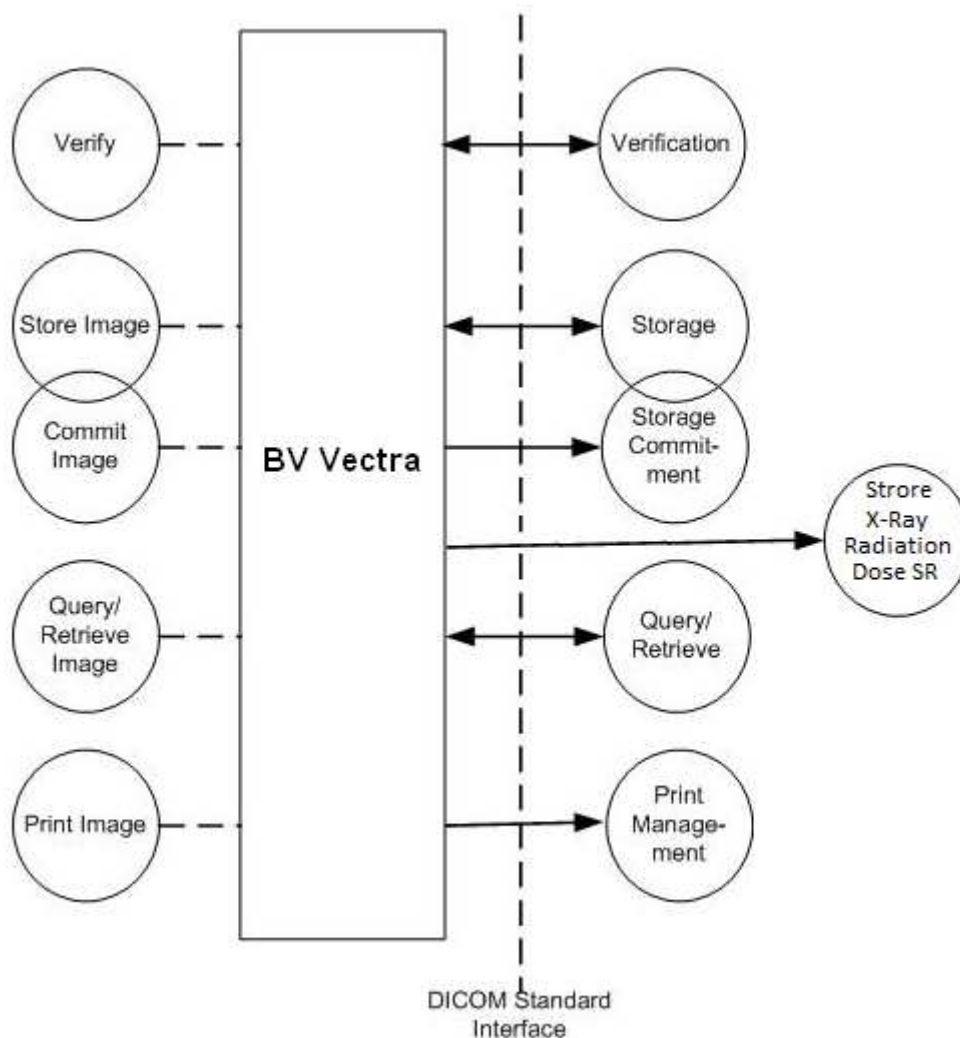

Figure 1: Application Data Flow Diagram.

The BV Vectra incorporates the following functionality:

- Import images generated by a BV Vectra to a local database;
- Export (and commit) images from the local database to a network DICOM node;
- Query and retrieve images generated by a BV Vectra from a remote DICOM node;
- Query and retrieve images from the local database;
- Print grayscale images from the local database on a DICOM printer.

4.1.2. Functional Definition of AE's

This section contains a functional definition for each individual local Application Entity.

4.1.2.1. Functional Definition of BV Vectra Network AE

BV Vectra incorporates the following functionality:

- The BV Vectra Network AE can verify application level communication by using the Verification service both as SCU and SCP (Verify).
- The BV Vectra Network AE can store images by using the Storage service both as SCU and SCP (Store Image).
- The BV Vectra Network AE can commit images by using the Storage Commitment service as SCU (Commit Image).
- The BV Vectra Network AE can print images by using the Print Management service as SCU (Print Image).

4.1.3. Sequencing of Real World Activities

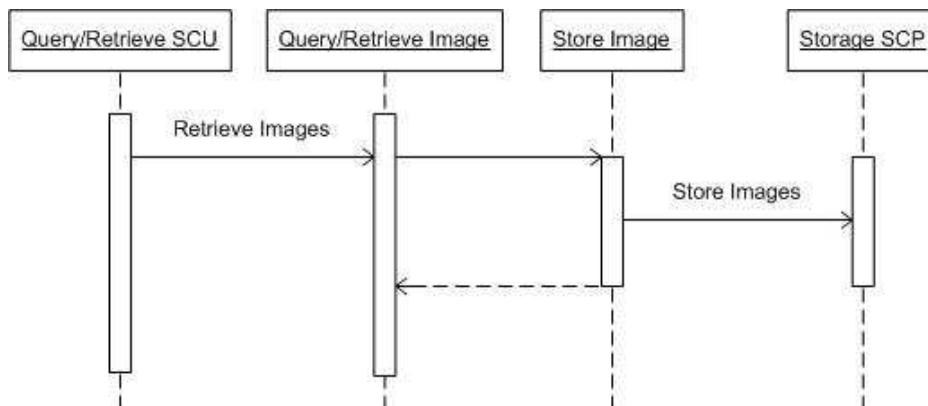

Figure 2: Sequencing of Retrieve.

Note again that only data originating from a BV Vectra can be retrieved with guaranteed quality.

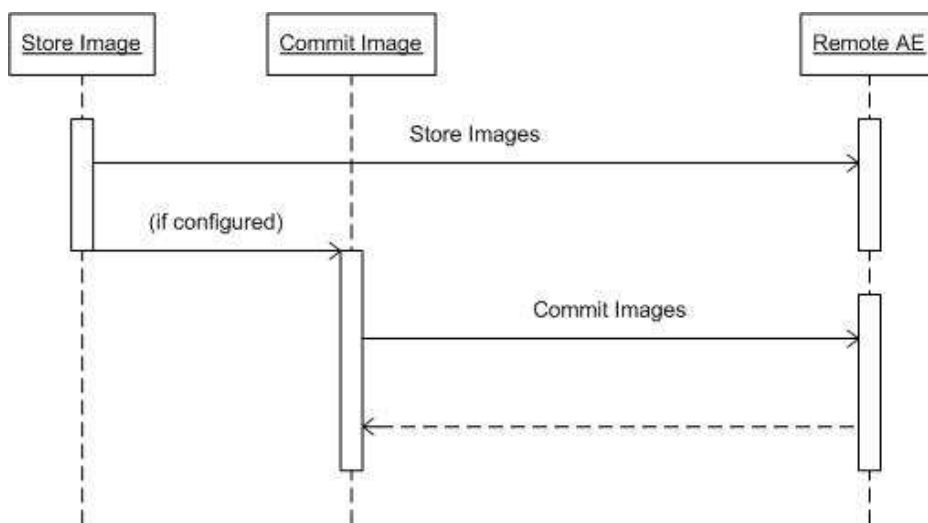

Figure 3: Sequencing of Storage Commitment.

4.2. AE Specifications

This section in the DICOM Conformance Statement is a set of Application Entity specifications. There are as many of these subsections as there are different AE's in the implementation.

4.2.1. BV Vectra Network AE

Detail of this specific Application Entity is specified in this section.

4.2.1.1. SOP Classes

This Application Entity provides Standard Conformance to the following SOP Classes.

Table 5: SOP Classes for BV Vectra Network AE

SOP Class Name	SOP Class UID	SCU	SCP
Verification SOP Class	1.2.840.10008.1.1	Yes	Yes
Storage Commitment Push Model SOP Class	1.2.840.10008.1.20.1	Yes	No
Grayscale Softcopy Presentation State Storage SOP Class	1.2.840.10008.5.1.4.1.1.11.1	Yes	Yes
X-Ray Angiographic Image Storage SOP Class	1.2.840.10008.5.1.4.1.1.12.1	Yes	Yes
Secondary Capture Image Storage SOP Class	1.2.840.10008.5.1.4.1.1.7	Yes	Yes
Multi-frame Grayscale Word SC Image Storage SOP Class	1.2.840.10008.5.1.4.1.1.7.3	Yes	Yes
Patient Root QR Information Model - FIND SOP Class	1.2.840.10008.5.1.4.1.2.1.1	Yes	No
Patient Root QR Information Model - MOVE SOP Class	1.2.840.10008.5.1.4.1.2.1.2	Yes	No
Study Root QR Information Model - FIND SOP Class	1.2.840.10008.5.1.4.1.2.2.1	Yes	No
Study Root QR Information Model - MOVE SOP Class	1.2.840.10008.5.1.4.1.2.2.2	Yes	No
PatientStudy Only QR Info. Model - FIND SOP Class (Retired)	1.2.840.10008.5.1.4.1.2.3.1	Yes	No
PatientStudy Only QR Info. Model - MOVE SOP Class (Retired)	1.2.840.10008.5.1.4.1.2.3.2	Yes	No
X-Ray Radiation Dose SR SOP Class	1.2.840.10008.5.1.4.1.1.88.67	Yes	No
Basic Grayscale Print Management Meta SOP Class	1.2.840.10008.5.1.1.9	Yes	No
>Basic Film Box SOP Class	1.2.840.10008.5.1.1.2	Yes	No
>Basic Film Session SOP Class	1.2.840.10008.5.1.1.1	Yes	No
>Basic Grayscale Image Box SOP Class	1.2.840.10008.5.1.1.4	Yes	No
>Printer SOP Class	1.2.840.10008.5.1.1.16	Yes	No

*Only import of data created by BV Vectra itself is supported. For other SC/XA data, quality of imported data is not guaranteed.

Note: Any SOP specific behavior is documented later in the conformance statement in the applicable SOP specific conformance section.

4.2.1.2. Association Policies

Each AE specification contains a description of the general association establishment and acceptance policies of the AE.

4.2.1.2.1. General

The DICOM standard application context is specified below.

Table 6: DICOM Application Context

Description	Value
Application Context Name	1.2.840.10008.3.1.1.1

4.2.1.2.2. Number of Associations

The number of simultaneous associations that an Application Entity may support as an Initiator or Acceptor is specified here.

Table 7: Number of associations as an Association Initiator for this AE

Description	Value
Maximum number of simultaneous associations	2

Table 8: Number of associations as an Association Acceptor for this AE

Description	Value
Maximum number of simultaneous associations	2

4.2.1.2.3. Asynchronous Nature

The implementation supports negotiation of multiple outstanding transactions, along with the maximum number of outstanding transactions supported.

The BV Vectra Network AE does not support asynchronous operations and will not perform asynchronous window negotiation. The only exceptions are for reports from Storage Commitment and Print Management operations.

Table 9: Asynchronous nature as an Association Initiator for this AE

Description	Value
Maximum number of outstanding asynchronous transactions	Not applicable

4.2.1.2.4. Implementation Identifying Information

The value supplied for Implementation Class UID and version name are documented here.

Table 10: DICOM Implementation Class and Version for BV Vectra Network AE

Implementation Class UID	1.3.46.670589.7.50.2.0.1
Implementation Version Name	1.1.2.3

4.2.1.2.5. Communication Failure Handling

The behavior of the AE during communication failure is summarized in the next table.

Table 11: Communication Failure Behavior

Exception	Behavior
ARTIM Timeout	The association setup fails; the reason is logged and reported to the user.

Table 12: DICOM Command Communication Failure Behavior

Exception	Behavior
Reply Time-out	The association is aborted using A-ABORT and command marked as failed. The reason is logged and reported to the user.

4.2.1.3. Association Initiation Policy

The behavior of this Application Entity is summarized in the next Table.

Table 13: Response Status Handler Behavior

Service Status	Error Code	Further Meaning	Behavior
Success	0000	Matching is complete	The SCP has successfully returned all matching information.

The Application Entity will respond to a received Association rejection as shown in the next table.

Table 14: Association Rejection response

Result	Source	Reason/Diagnosis	Behavior
1 - rejected-permanent	1 - DICOM UL service-user	1 - no-reason-given	-
		2 - application-context-name-not supported	-
		3 - calling-AE-title-not-recognized	-
		7 - called-AE-title-not-recognized	-

Result	Source	Reason/Diagnosis	Behavior
	2 - DICOM UL service-provider (ACSE related function)	1 - no-reason-given	-
		2 - protocol-version-not-supported	-
	3 - DICOM UL service-provider (Presentation related function)	1 - temporary-congestion	-
		2 - local-limit-exceeded	-
2 - rejected-transient	1 - DICOM UL service-user	1 - no-reason-given	-
		2 - application-context-name-not-supported	-
		3 - calling-AE-title-not-recognized	-
		7 - called-AE-title-not-recognized	-
	2 - DICOM UL service-provider (ACSE related function)	1 - no-reason-given	-
		2 - protocol-version-not-supported	-
3 - DICOM UL service-provider (Presentation related function)	1 - temporary-congestion	-	
	2 - local-limit-exceeded	-	

The behavior of the AE on receiving an Association abort is summarized in the next table.

Table 15: Association Abort Handling

Source	Reason/Diagnosis	Behavior
0 - DICOM UL service-user (initiated abort)	0 - reason-not-specified	-
2 - DICOM UL service-provider (initiated abort)	0 - reason-not-specified	-
	1 - unrecognized-PDU	-
	2 - unexpected-PDU	-
	4 - unrecognized-PDU-parameter	-
	5 - unexpected-PDU-parameter	-
	6 - invalid-PDU-parameter-value	-

4.2.1.3.1. (Real-World) Activity – Verification as SCU

4.2.1.3.1.1. Description and Sequencing of Activities

The BV Vectra Network AE implements the Verification service class / Verification SOP class to verify application level communication.

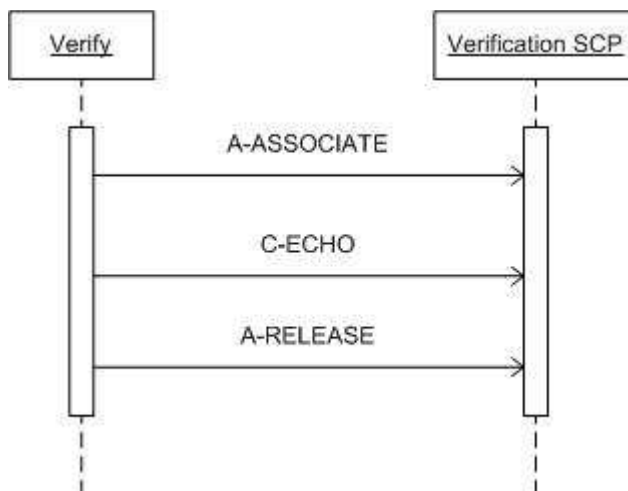

Figure 4: Data Flow Diagram – Verification as SCU.

4.2.1.3.1.2. Proposed Presentation Contexts

The presentation contexts are defined in the next table.

Table 16: Proposed Presentation Contexts for (Real-World) Activity – Verification as SCU

Presentation Context Table					
Abstract Syntax		Transfer Syntax		Role	Extended Negotiation
Name	UID	Name List	UID List		
Verification SOP Class	1.2.840.10008.1.1	Explicit VR Big Endian	1.2.840.10008.1.2.2	SCU	None
		Explicit VR Little Endian	1.2.840.10008.1.2.1		
		Implicit VR Little Endian	1.2.840.10008.1.2		

4.2.1.3.1.3. SOP Specific Conformance for Verification SOP Class

This section and sub-section include the manufacturer SOP and Dataset specific information as well the status codes and their corresponding behavior.

The BV Vectra Network AE provides standard conformance to the DICOM Verification service class.

4.2.1.3.1.3.1. Dataset Specific Conformance for Verification C-ECHO SCU

Detail regarding the Dataset Specific response behavior will be reported in this section.

This part of the section includes the dataset specific behavior, i.e. error codes, error and exception handling, time-outs, etc.

Table 17: Status Response

Service Status	Error Code	Further Meaning	Behavior
Success	0000	Confirmation	The SCP has successfully returned a verification response.

4.2.1.3.2. (Real-World) Activity – FIND as SCU

4.2.1.3.2.1. Description and Sequencing of Activities

BV Vectra Network AE accepts associations from systems that wish to query the local database using the C-FIND command.

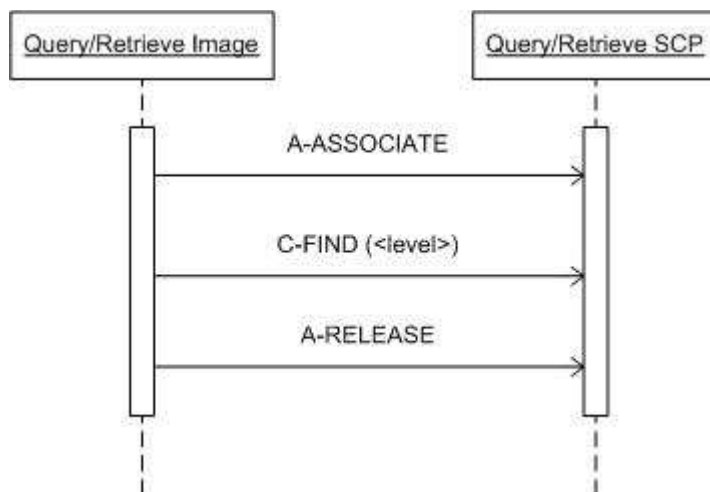

Figure 5: Data Flow Diagram – FIND as SCU

4.2.1.3.2.2. Proposed Presentation Contexts

The presentation contexts are defined in the next table.

Table 18: Proposed Presentation Contexts for (Real-World) Activity – FIND As SCU

Presentation Context Table					
Abstract Syntax		Transfer Syntax		Role	Extended Negotiation
Name	UID	Name List	UID List		
Patient Root QR Information Model - FIND SOP Class	1.2.840.10008.5.1.4.1.2.1.1	Explicit VR Big Endian	1.2.840.10008.1.2.2	SCU	None
		Explicit VR Little Endian	1.2.840.10008.1.2.1		
		Implicit VR Little Endian	1.2.840.10008.1.2		
PatientStudy Only QR Info. Model - FIND SOP Class (Retired)	1.2.840.10008.5.1.4.1.2.3.1	Explicit VR Big Endian	1.2.840.10008.1.2.2	SCU	None
		Explicit VR Little Endian	1.2.840.10008.1.2.1		
		Implicit VR Little Endian	1.2.840.10008.1.2		
Study Root QR Information Model - FIND SOP Class	1.2.840.10008.5.1.4.1.2.2.1	Explicit VR Big Endian	1.2.840.10008.1.2.2	SCU	None
		Explicit VR Little Endian	1.2.840.10008.1.2.1		
		Implicit VR Little Endian	1.2.840.10008.1.2		

4.2.1.3.2.3. SOP Specific Conformance for Patient Root QR Information Model - FIND SOP Class

This section and sub-section include the manufacturer SOP and Dataset specific information as well the status codes and their corresponding behavior.

The BV Vectra Network AE provides standard conformance to the DICOM Query/Retrieve service class. Optional keys are supported, depending on the data repository table that the remote system. Relational queries are not supported. The BV Vectra Network AE generates a C-FIND response for each match with an identifier containing the values of all known attributes identified by the requested key fields. All such responses will have a status of Pending, indicating that the process of matching is not complete. When the process of matching is complete a C-FIND response is sent with a status of success and no identifier. A Refused or Failed response to a C-FIND request indicates that the BV Vectra is unable to process the request.

The SCU may cancel the C-FIND service by issuing a C-FIND-CANCEL request at any time during the processing of the C-FIND service. The BV Vectra will interrupt all matching and return a status of Cancelled.

4.2.1.3.2.3.1. Dataset Specific Conformance for Patient Root QR Information Model - FIND SOP Class C-FIND-SCU

Detail regarding the Dataset Specific response behavior will be reported in this section.

Table 19: Supported Query Keys for Patient Root Information Model

Patient Root Information Model				
Attribute Name	Tag	VR	Type Of Matching	Comment
Query/Retrieve Level	0008,0052	CS	Single Value	
Q/R Patient level				
Patient ID	0010,0020	LO	Single Value, Universal, Wild Card	
Patient's Name	0010,0010	PN	Single Value, Universal, Wild Card	
Patient's Birth Date	0010,0030	DA	Single Value, Universal	
Patient's Sex	0010,0040	CS	Single Value, Universal	
Q/R Study level				
Study Date	00080020	DA	Range, Single Value, Universal	
Study Time	0010,0010	TM	Universal matching	
Accession Number	0008,0050	SH	Single Value, Universal, Wild Card	
Study Instance UID	0020,000D	UI	Universal matching	
Study ID	0020,0010	SH	Single Value, Universal	
Modalities in Study	0008,0061	CS		
Referring Physician's Name	0008,0090	PN		
Patient ID	0010,0020	LO	Single Value, Universal, Wild Card	

Q/R Series level				
Modality	0008,0060	CS	Single Value, Universal, Wild Card	
Patient ID	0010,0020	LO	Single Value, Universal, Wild Card	
Study Instance UID	0020,000D	UI	Single Value, Universal	
Series Instance UID	0020,000E	UI	Single Value	
Series Number	0020,0011	IS	Single Value, Universal	

This part of the section includes the dataset specific behavior, i.e. error codes, error and exception handling, time-outs, etc.

Table 20: Status Response

Service Status	Error Code	Further Meaning	Behavior
Success	0000	Matching is complete – No final identifier is supplied	Successful completion of the query.
Failure	A700	Refused – Out of resources	Not enough resources; exception during evaluation of query.
	C000	Failed – Unable to process	Any other exception generated while evaluating the query.
Cancel	FE00	Matching terminated due to Cancel request	Query has been cancelled.
Pending	FF00	Matches are continuing – Current match is supplied and any optional keys were supported in the same manner as required keys	Optional keys supported.
	FF01	Matches are continuing – Warning that one or more optional keys were not supported for existence and/or matching for this identifier	Optional keys not supported.

4.2.1.3.2.4. SOP Specific Conformance for PatientStudy Only QR Info. Model - FIND SOP Class (Retired)

This section and sub-section include the manufacturer SOP and Dataset specific information as well the status codes and their corresponding behavior.

4.2.1.3.2.4.1. Dataset Specific Conformance for PatientStudy Only QR Info. Model - FIND SOP Class C-FIND-SCU

Detail regarding the Dataset Specific response behavior will be reported in this section.

Table 21: Supported Query Keys for PatientStudy only Root Information Model (Retired)

Patient Root Information Model				
Attribute Name	Tag	VR	Type Of Matching	Comment
Query/Retrieve Level	0008,0052	CS	Single Value	
Q/R Patient level				
Patient's Name	0010,0010	PN	Single Value, Universal, Wild Card	
Patient ID	0010,0020	LO	Single Value, Universal, Wild Card	
Patient's Birth Date	0010,0030	DA	Single Value, Universal	
Patient's Sex	0010,0040	CS	Universal matching	
Q/R Study level				
Study Date	0008,0020	DA	Range, Single Value, Universal	
Study Time	0008,0030	TM	Universal matching	
Accession Number	0008,0050	SH	Single Value, Universal, Wild Card	
Modalities in Study	0008,0061	CS	Single Value, Universal	
Referring Physician's Name	0008,0090	PN	Single Value, Universal, Wild Card	
Patient ID	0010,0020	LO	Single Value, Universal, Wild Card	
Study Instance UID	0020,000D	UI	Single Value	
Study ID	0020,0010	SH	Single Value, Universal, Wild Card	

Table 22: Status Response

Service Status	Error Code	Further Meaning	Behavior
Success	0000	Matching is complete	The SCU has successfully returned all matching information

4.2.1.3.2.5. SOP Specific Conformance for Study Root QR Information Model - FIND SOP Class

This section and sub-section include the manufacturer SOP and Dataset specific information as well the status codes and their corresponding behavior.

4.2.1.3.2.5.1. Dataset Specific Conformance for Study Root QR Information Model - FIND SOP Class C-FIND-SCU

Detail regarding the Dataset Specific response behavior will be reported in this section.

Table 23: Supported Query Keys for Study Root Information Model

Study Root Information Model				
Attribute Name	Tag	VR	Type Of Matching	Comment
Query/Retrieve Level	0008,0052	CS	Single Value	
Q/R Study level				
Accession Number	0008,0050	SH	Single Value, Universal, Wild Card	
Patient ID	0010,0020	LO	Single Value, Universal, Wild Card	
Patient's Name	0010,0010	PN	Single Value, Universal, Wild Card	
Referring Physician's Name	0008,0090	PN	Single Value, Universal, Wild Card	
Study Date	0008,0020	DA	Range, Single Value, Universal	
Study Time	00080030	TM	Universal matching	
Study ID	0020,0010	SH	Single Value, Universal, Wild Card	
Study Instance UID	0020,000D	UI	Single Value	
Accession Number	0008,0050	SH	Single Value, Universal, Wild Card	
Patient's Birth Date	0010,0030	DA	Single Value, Universal	
Patient's Sex	0010,0040	CS	Universal matching	
Q/R Series level				
Modality	0008,0060	CS	Single Value, Universal, Wild Card	
Study Instance UID	0020,000D	UI	Single Value, Universal	
Series Instance UID	0020,000E	UI	Single Value, Universal	
Series Number	0020,0011	IS	Single Value, Universal	

This part of the section includes the dataset specific behavior, i.e. error codes, error and exception handling, time-outs, etc.

Table 24: Status Response

Service Status	Error Code	Further Meaning	Behavior
Success	0000	Matching is complete – No final identifier is supplied	Successful completion of the query.
Failure	A700	Refused – Out of resources	Not enough resources; exception during evaluation of query.
	C000	Failed – Unable to process	Any other exception generated while evaluating the query.
Cancel	FE00	Matching terminated due to Cancel request	Query has been cancelled.
Pending	FF00	Matches are continuing – Current match is supplied and any optional keys were supported in the same manner as required keys	Optional keys supported.
	FF01	Matches are continuing – Warning that one or more optional keys were not supported for existence and/or matching for this identifier	Optional keys not supported.

4.2.1.3.3. (Real-World) Activity – MOVE as SCU

4.2.1.3.3.1. Description and Sequencing of Activities

BV Vectra Network AE accepts associations from systems that wish to retrieve images from the BV Vectra database using the C-MOVE command.

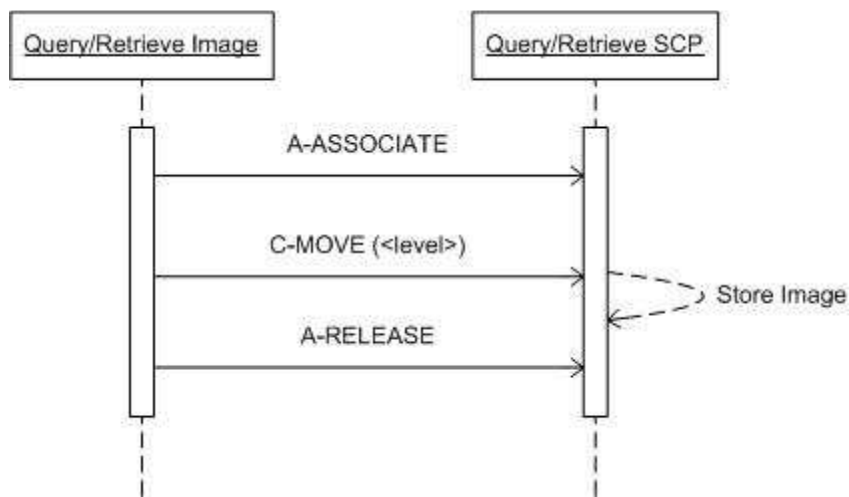

Figure 6: Data Flow Diagram – MOVE as SCU.

4.2.1.3.3.2. Proposed Presentation Contexts

The presentation contexts are defined in the next table.

Table 25: Proposed Presentation Contexts for (Real-World) Activity – MOVE As SCU

Presentation Context Table					
Abstract Syntax		Transfer Syntax		Role	Extended Negotiation
Name	UID	Name List	UID List		
Patient Root QR Information Model - MOVE SOP Class	1.2.840.10008.5.1.4.1.2.1.2	Explicit VR Big Endian	1.2.840.10008.1.2.2	SCU	None
		Explicit VR Little Endian	1.2.840.10008.1.2.1		
		Implicit VR Little Endian	1.2.840.10008.1.2		
PatientStudy Only QR Info. Model - MOVE SOP Class (Retired)	1.2.840.10008.5.1.4.1.2.3.2	Explicit VR Big Endian	1.2.840.10008.1.2.2	SCU	None
		Explicit VR Little Endian	1.2.840.10008.1.2.1		
		Implicit VR Little Endian	1.2.840.10008.1.2		
Study Root QR Information Model - MOVE SOP Class	1.2.840.10008.5.1.4.1.2.2.2	Explicit VR Big Endian	1.2.840.10008.1.2.2	SCU	None
		Explicit VR Little Endian	1.2.840.10008.1.2.1		
		Implicit VR Little Endian	1.2.840.10008.1.2		

4.2.1.3.3.3. SOP Specific Conformance for Patient Root QR Information Model - MOVE SOP Class

This section and sub-section include the manufacturer SOP and Dataset specific information as well the status codes and their corresponding behavior.

During the processing of the C-STORE sub-operations BV Vectra optionally generates responses to the C-MOVE with status equal to pending. These C-MOVE responses indicate a number of remaining C-STORE sub-operations and the number of CSTORE sub-operations returning the status of Success, Warning, and Failed. When the number of remaining C-STORE sub-operations reaches zero, the BV Vectra generates a final response with the status of equal to Success, Warning, Failed, or Refused. This response may indicate the number of C-STORE sub-operations returning the status of Success, Warning, and Failed.

The SCU may cancel the C-MOVE service by issuing a C-MOVE-CANCEL request at any time during the processing of the C-MOVE. The BV Vectra terminates all incomplete CSTORE sub-operations and returns a status of Cancelled.

4.2.1.3.3.3.1. Dataset Specific Conformance for Patient Root QR Information Model - MOVE SOP Class C-MOVE-SCU

Detail regarding the Dataset Specific response behavior will be reported in this section.

Table 26: Identifiers for MOVE Patient Root Information Model as SCU

Patient Root Information Model			
Attribute Name	Tag	VR	Comment
Query/Retrieve Level	0008,0052	CS	
Q/R Patient level			
Patient ID	0010,0020	LO	
Q/R Study level			
Study Instance UID	0020,000D	UI	
Q/R Series level			
Series Instance UID	0020,000E	UI	

This part of the section includes the dataset specific behavior, i.e. error codes, error and exception handling, time-outs, etc.

Table 27: Status Response

Service Status	Error Code	Further Meaning	Behavior
Success	0000	Sub-operations complete – No failures	Successful completion of the retrieve; also storage warnings may have occurred.
Failure	A701	Refused – Out of resources - Unable to calculate number of matches	Storage status Refused: Out of resources.
	AB01	Refused – Move destination unknown	Move destination is unknown.
	C000	Failed – Unable to process	Any other exception generated during the move.
Warning	B000	Sub-operations complete – One or more failures	Warning: One or more SOP instances have been successfully stored and the remaining has failed. Also in case of storage status Refused: SOP class not supported.
Cancel	FE00	Sub-operations terminated due to Cancel indication	Move request has been cancelled.
Pending	FF00	Sub-operations are continuing	Move pending.

4.2.1.3.3.4. SOP Specific Conformance for PatientStudy Only QR Info. Model - MOVE SOP Class (Retired)

This section and sub-section include the manufacturer SOP and Dataset specific information as well the status codes and their corresponding behavior.

4.2.1.3.3.4.1. Dataset Specific Conformance for PatientStudy Only QR Info. Model - MOVE SOP Class C-MOVE-SCU

This part of the section includes the dataset specific behavior, i.e. error codes, error and exception handling, time-outs, etc.

Table 28: Identifiers for MOVE PatientStudy Root Information Model as SCU (Retired)

PatientStudy Root Information Model			
Attribute Name	Tag	VR	Comment
Query/Retrieve Level	0008,0052	CS	
Q/R Patient level			
Patient ID	0010,0020	LO	

Q/R Study level			
Patient ID	0010,0020	LO	
Study Instance UID	0020,000D	UI	

Table 29: Status Response

Service Status	Error Code	Further Meaning	Behavior
Success	0000	Matching is complete	The SCU has successfully returned all matching information

4.2.1.3.3.5. SOP Specific Conformance for Study Root QR Information Model - MOVE SOP Class

This section and sub-section include the manufacturer SOP and Dataset specific information as well the status codes and their corresponding behavior.

4.2.1.3.3.5.1. Dataset Specific Conformance for Study Root QR Information Model - MOVE SOP Class C-MOVE-SCU

Detail regarding the Dataset Specific response behavior will be reported in this section.

Table 30: Identifiers for MOVE Study Root Information Model as SCU

This part of the section includes the dataset specific behavior, i.e. error codes, error and exception handling, time-outs, etc.

Study Root Information Model			
Attribute Name	Tag	VR	Comment
Query/Retrieve Level	0008,0052	CS	
Q/R Study level			
Study Instance UID	0020,000D	UI	
Q/R Series level			
Series Instance UID	0020,000E	UI	
Study Instance UID	0020,000D	UI	

Table 31: Status Response

Service Status	Error Code	Further Meaning	Behavior
Success	0000	Sub-operations complete – No failures	Successful completion of the retrieve; also storage warnings may have occurred.
Failure	A701	Refused – Out of resources - Unable to calculate number of matches	Storage status Refused: Out of resources.
	A801	Refused – Move destination unknown	Move destination is unknown.
	C000	Failed – Unable to process	Any other exception generated during the move.
Warning	B000	Sub-operations complete – One or more failures	Warning: One or more SOP instances have been successfully stored and the remaining has failed. Also in case of storage status Refused: SOP class not supported.
Cancel	FE00	Sub-operations terminated due to Cancel indication	Move request has been cancelled.
Pending	FF00	Sub-operations are continuing	Move pending.

4.2.1.3.4. (Real-World) Activity – Image Export

4.2.1.3.4.1. Description and Sequencing of Activities

The BV Vectra Network AE implements the Storage service class as part of the BV Vectra to store selected images at an archive or other storage SCP. All actual selected images are exported using one and the same association. The BV Vectra waits for synchronous report until, after a configurable time passed, it will release the association.

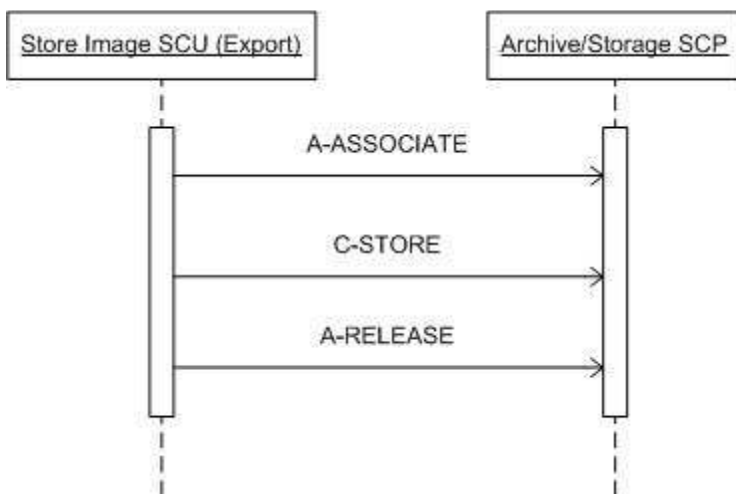

Figure 7: Data Flow Diagram – Store Image – Storage as SCU.

4.2.1.3.4.2. Proposed Presentation Contexts

The presentation contexts are defined in the next table.

Table 32: Proposed Presentation Contexts for (Real-World) Activity – Image Export

Presentation Context Table					
Abstract Syntax		Transfer Syntax		Role	Extended Negotiation
Name	UID	Name List	UID List		
Grayscale Softcopy Presentation State Storage SOP Class	1.2.840.10008.5.1.4.1.1.11.1	Explicit VR Big Endian	1.2.840.10008.1.2.2	SCU	None
		Explicit VR Little Endian	1.2.840.10008.1.2.1		
		Implicit VR Little Endian	1.2.840.10008.1.2		
Multi-frame Grayscale Word SC Image Storage SOP Class	1.2.840.10008.5.1.4.1.1.7.3	JPEG Lossless, Non-Hierarchical, FOP (Process 14)	1.2.840.10008.1.2.4.70	SCU	None
		RLE Lossless	1.2.840.10008.1.2.5		
		Explicit VR Big Endian	1.2.840.10008.1.2.2		
		Explicit VR Little Endian	1.2.840.10008.1.2.1		
		Implicit VR Little Endian	1.2.840.10008.1.2		
		JPEG 2000 Image Compression	1.2.840.10008.1.2.4.91		
		JPEG 2000 Image Compression (Lossless Only)	1.2.840.10008.1.2.4.90		
		JPEG Extended (Process 2 & 4)	1.2.840.10008.1.2.4.51		
Secondary Capture Image Storage SOP Class	1.2.840.10008.5.1.4.1.1.7	JPEG Lossless, Non-Hierarchical, FOP (Process 14)	1.2.840.10008.1.2.4.70	SCU	None
		RLE Lossless	1.2.840.10008.1.2.5		
		Explicit VR Big Endian	1.2.840.10008.1.2.2		
		Explicit VR Little Endian	1.2.840.10008.1.2.1		
		Implicit VR Little Endian	1.2.840.10008.1.2		
		JPEG 2000 Image Compression	1.2.840.10008.1.2.4.91		
		JPEG 2000 Image Compression (Lossless Only)	1.2.840.10008.1.2.4.90		
		JPEG Extended (Process 2 & 4)	1.2.840.10008.1.2.4.51		
X-Ray Angiographic Image Storage SOP Class	1.2.840.10008.5.1.4.1.1.12.1	JPEG Lossless, Non-Hierarchical, FOP (Process 14)	1.2.840.10008.1.2.4.70	SCU	None
		RLE Lossless	1.2.840.10008.1.2.5		
		Explicit VR Big Endian	1.2.840.10008.1.2.2		

Presentation Context Table					
Abstract Syntax		Transfer Syntax		Role	Extended Negotiation
Name	UID	Name List	UID List		
		Explicit VR Little Endian	1.2.840.10008.1.2.1		
		Implicit VR Little Endian	1.2.840.10008.1.2		

4.2.1.3.4.3. SOP Specific Conformance for Storage SOP Classes

This section and sub-section include the manufacturer SOP and Dataset specific information as well the status codes and their corresponding behavior.

The BV Vectra can be configured to stop the transfer of data when the BV Vectra receives an unsuccessful store response. Furthermore the BV Vectra can be configured in such a way that images can be converted to Secondary Captures.

The BV Vectra will transmit all optional or private image attributes. Also the BV Vectra can create attributes that are not in the image: these new attributes are exported along with the image (e.g. when the SCP does not support presentation state objects). The object supplier shall be responsible for the presence of DICOM UIDs. The export job will transparently exchange this UID when the image is exported in „DICOM 20xx Format (i.e. separate Presentation State).

Following remarks hold for the standard DICOM SOP Classes:

- The BV Vectra supports the following Photometric Interpretations for non-compressed images: MONOCHROME1, MONOCHROME2.
- The BV Vectra can convert Transfer Syntaxes from internal to external values. So BV Vectra can convert from internally JPEG compressed/uncompressed pixel data to external JPEG compressed/uncompressed pixel data.
- JPEG Lossless (NH-FOP) compresses all bits denoted by the attribute DICOM_BITS_ALLOCATED. Therefore, any overlays encoded in the pixel data are also encoded and decoded.
- In case of both source (internal) and target compressed pixel data, decompression of the source pixel data and compression to the target pixel data only takes place in case the source and target compression formats are different.

BV Vectra allows export of mixed series: a series containing a maximum of 2 Secondary Capture images in addition to images from another SOP class.

4.2.1.3.4.3.1. Dataset Specific Conformance for C-STORE-RQ

Detail regarding the Dataset Specific response behavior will be reported in this section. This includes the dataset specific behavior, i.e. error codes, error and exception handling, time-outs, etc.

Table 33: Status Response

Service Status	Error Code	Further Meaning	Behavior
Success	0000	Successful stored	Progress of the export job is updated and connection is retained for the next store. If the store of all the SOP instances is completed then the connection is released.
Failure	A7xx	Refused: Out of Resources	Error is logged and the export job fails. Connection is released.
	A9xx	Error: Data Set does not match SOP Class	Error is logged and the export job fails. Connection is released.

Service Status	Error Code	Further Meaning	Behavior
	Cxxx	Error: cannot understand	Error is logged and the export job fails. Connection is released.
Warning	B000	Coercion of Data Elements	Warning is logged and the export job continues. Connection is not released.
	B007	Data Set does not match SOP Class	Warning is logged and the export job continues. Connection is not released.
	B006	Elements Discarded	Warning is logged and the export job continues. Connection is not released.

4.2.1.3.5. (Real-World) Activity – Structure Report Export

4.2.1.3.5.1. Description and Sequencing of Activities

The BV Vectra Network AE implements the Storage service class as part of the BV Vectra to store selected images and associated Structure Reports to an archive or other storage SCP. All actual selected images are exported using one and the same association. The BV Vectra waits for synchronous report until, after a configurable time passed, it will release the association.

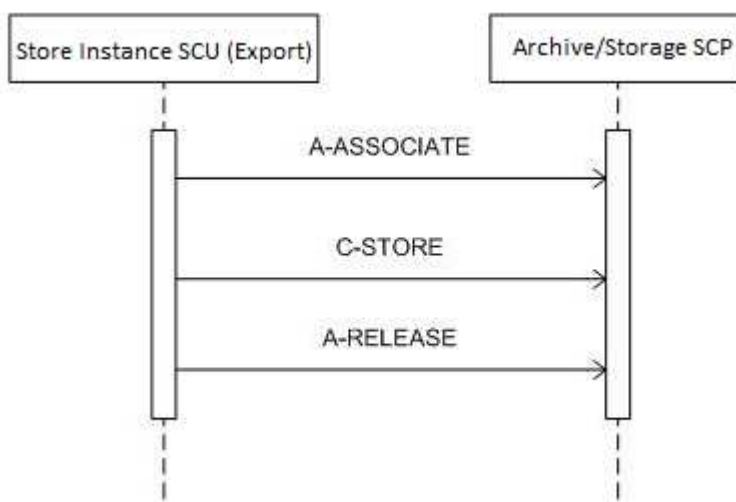

Figure 8: Data Flow Diagram – Store Instance – Storage as SCU.

4.2.1.3.5.2. Proposed Presentation Contexts

The presentation contexts are defined in the next table.

Table 34: Proposed Presentation Contexts for (Real-World) Activity – SR Instance Export

Presentation Context Table					
Abstract Syntax		Transfer Syntax		Role	Extended Negotiation
Name	UID	Name List	UID List		
X-Ray Radiation Dose SR SOP Class	1.2.840.10008.5.1.4.1.1.88.67	Explicit VR Big Endian	1.2.840.10008.1.2.2	SCU	None
		Explicit VR Little Endian	1.2.840.10008.1.2.1		
		Implicit VR Little Endian	1.2.840.10008.1.2		

Note: In the table above, only ILE is specified as transfer syntax. However, the supported transfer syntaxes can be configured to include additional syntaxes. See section 4.4.2. for details.

4.2.1.3.5.3. SOP Specific Conformance for Storage SOP Classes

4.2.1.3.5.3.1. Dataset Specific Conformance for C-STORE-RQ

Detail regarding the Dataset Specific response behavior will be reported in this section. This includes the dataset specific behavior, i.e. error codes, error and exception handling, time-outs, etc.

Table 35: Status Response

Service Status	Error Code	Further Meaning	Behavior
Success	0000	Successful stored	Progress of the export job is updated and connection is retained for the next store. If the store of all the SOP instances is completed then the connection is released.
Failure	A7xx	Refused: Out of Resources	Error is logged and the export job fails. Connection is released.
	A9xx	Error: Data Set does not match SOP Class	Error is logged and the export job fails. Connection is released.
	Cxxx	Error: cannot understand	Error is logged and the export job fails. Connection is released.
Warning	B000	Coercion of Data Elements	Warning is logged and the export job continues. Connection is not released.
	B007	Data Set does not match SOP Class	Warning is logged and the export job continues. Connection is not released.
	B006	Elements Discarded	Warning is logged and the export job continues. Connection is not released.

4.2.1.3.6. (Real-World) Activity – Storage Commitment Push Model as SCU

4.2.1.3.6.1. Description and Sequencing of Activities

BV Vectra Storage Commitment as a SCU service. It accepts a storage commitment notification (N-EVENT-REPORT) from systems that send them.

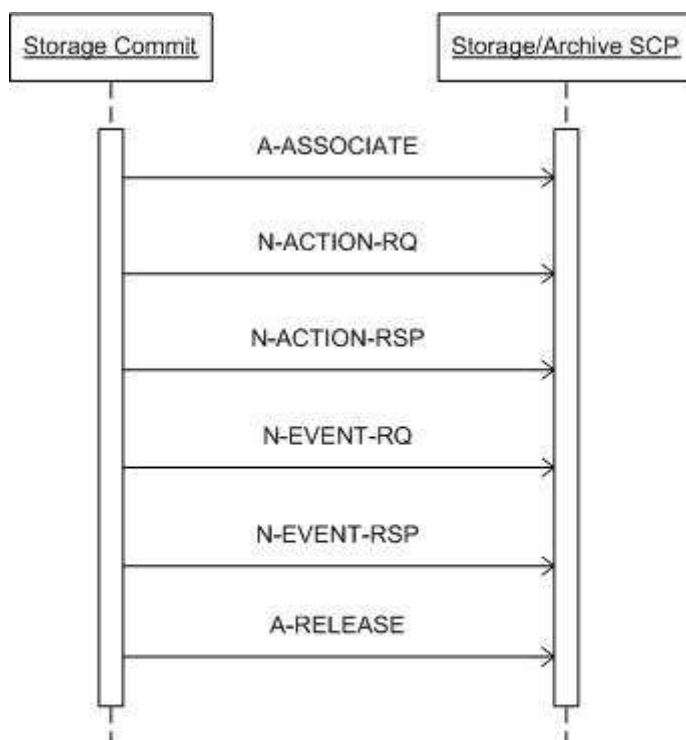

Figure 9: Data Flow Diagram – Commit Image (Synchronous).

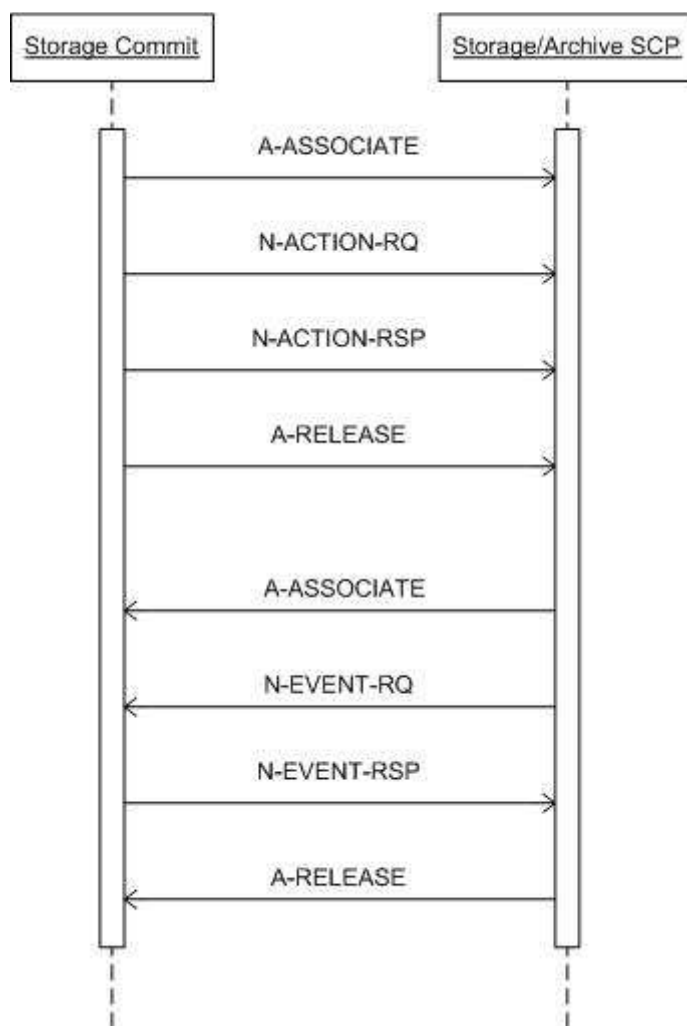

Figure 10: Data Flow Diagram – Commit Image (Asynchronous).

4.2.1.3.6.2. Proposed Presentation Contexts

The presentation contexts are defined in the next table.

Table 36: Proposed Presentation Contexts for (Real-World) Activity – Storage Commitment Push Model AS SCU

Presentation Context Table					
Abstract Syntax		Transfer Syntax		Role	Extended Negotiation
Name	UID	Name List	UID List		
Storage Commitment Push Model SOP Class	1.2.840.10008.1.20.1	Explicit VR Big Endian	1.2.840.10008.1.2.2	SCU	None
		Explicit VR Little Endian	1.2.840.10008.1.2.1		
		Implicit VR Little Endian	1.2.840.10008.1.2		

4.2.1.3.6.3. SOP Specific Conformance for Storage Commitment Push Model SOP Class

This section and sub-section include the manufacturer SOP and Dataset specific information as well the status codes and their corresponding behavior.

BV Vectra provides standard conformance to the DICOM Storage Commitment service class.

4.2.1.3.6.3.1. Dataset Specific Conformance for Storage Commitment Push Model SOP Class N-EVENT-REPORT-SCP

This part of the section includes the dataset specific behavior, i.e. error codes, error and exception handling, time-outs, etc.

Table 37: Status Response

Service Status	Error Code	Further Meaning	Behavior
Success	0000		Successful completion of the request.

4.2.1.3.6.3.2. Dataset Specific Conformance for Storage Commitment Push Model SOP Class N-ACTION-SCU

Detail regarding the Dataset Specific response behavior will be reported in this section.

Table 38: Storage Commitment Attribute for N-ACTION-RQ

Attribute Name	Tag	Comment
Storage Commitment Module		
Transaction UID	0008,1195	
Referenced SOP Sequence	0008,1199	
>Referenced SOP Class UID	0008,1150	
>Referenced SOP Instance UID	0008,1155	

This part of the section includes the dataset specific behavior, i.e. error codes, error and exception handling, time-outs, etc.

Table 39: Status Response

Service Status	Error Code	Further Meaning	Behavior
Success	0000		Successful completion of the request.

4.2.1.3.7. (Real-World) Activity – Print Management as SCU

4.2.1.3.7.1. Description and Sequencing of Activities

The BV Vectra Network AE implements the Print Management service class as part of the Print component to send selected images to a printer (SCP).

As a result, the BV Vectra Network AE will initiate an association to the selected printer and use it to send the Print Service Elements of the Print SOP Classes. If the association could not be established, the BV Vectra Network AE will retry to establish an association every 20 seconds during the next hour.

BV Vectra allows having a print preview first.

In case of a print job association the printer status is requested in that association. The received printer status is displayed in the Printer Status Tool. On a failure printer status the BV Vectra Network AE will retry and request the printer status every 20 seconds during the next hour.

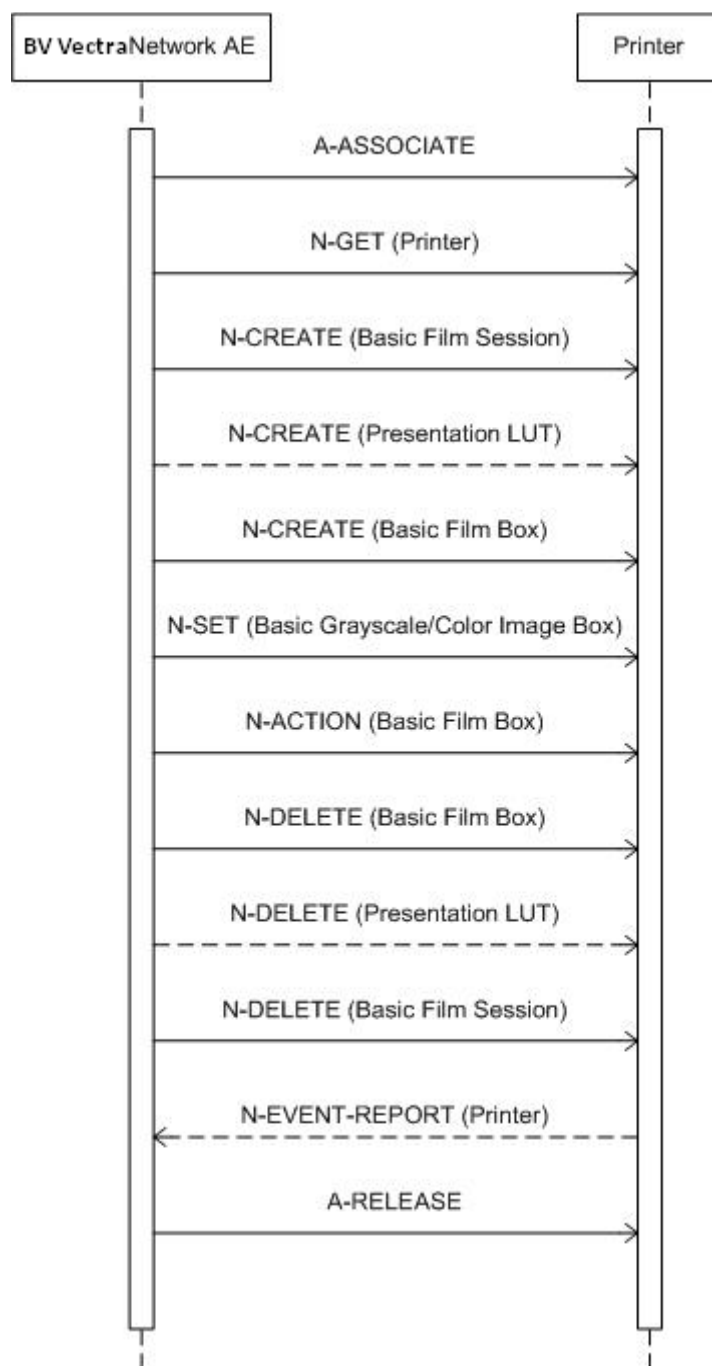

Figure 11: Data Flow Diagram – Print Management as SCU.

Note that associations are proposed for grayscale printing, not for both. The following optional SOP classes from these Meta SOP classes are not supported:

- Print Job SOP class (can be used to get a notification that a job is ready);
- Basic Annotations Box SOP class;
- Reference Image Box SOP class.

The grayscale standard display function adjusts the brightness such that equal changes in P-Values will result in the same level of perceptibility. The applied order of Print Service Elements (DIMSE) is specified in Figure 5. Refer to the following sections for a description of the applied optional attributes in these Service Elements (i.e. non-mandatory attributes as Print SCU). Note that the Service Elements order is not specified by the DICOM standard. Overlay, Annotation (showing the values of some major identifying attributes) and Shutter information is processed in the images sent to the printer (i.e. burnt-in into the image).

The Status Codes of DIMSE Responses (Success, Warning, Failure) as returned by the printer will also be logged (for service purposes) and are mapped onto general print job status messages towards the operator. These User Interface messages indicate:

- "Job Completed" and has the meaning that the print job is accepted by the printer; the actual printing will be done afterwards.
- "Print Error" indicating that a failure occurred during the DICOM Print. Also, most warning cases (like default printer values applied on optional print attributes) are interpreted as a print error because this will mostly result in a different print quality or print layout than expected.

The following implementation remarks are important to achieve successful printing:

- The number of Film Boxes per Film Session is one.
- The number of images per Film Box is one.
- The images to be printed on one film are rendered by BV Vectra Network AE into one logical image. This logical image is very large, depending on the pixel matrix size (pixels per line, lines per image). A rough indication is 20 Mbytes for grayscale. One should take this into account when selecting the DICOM printer and the printer configuration (e.g. the amount of memory).

The BV Vectra Network AE does not send an attribute list to the printer. Therefore the mandatory attributes listed in the following sections are the only attributes that are required to be supported by the printer.

4.2.1.3.7.2. Proposed Presentation Contexts

The presentation contexts are defined in the next table.

Table 40: Proposed Presentation Contexts for (Real-World) Activity – Print Management As SCU

Presentation Context Table					
Abstract Syntax		Transfer Syntax		Role	Extended Negotiation
Name	UID	Name List	UID List		
Basic Grayscale Print Management Meta SOP Class	1.2.840.10008.5.1.1.9			SCU	None
>Basic Film Box SOP Class	1.2.840.10008.5.1.1.2	Explicit VR Big Endian	1.2.840.10008.1.2.2	SCU	None
		Explicit VR Little Endian	1.2.840.10008.1.2.1		
		Implicit VR Little Endian	1.2.840.10008.1.2		
>Basic Film Session SOP Class	1.2.840.10008.5.1.1.1	Explicit VR Big Endian	1.2.840.10008.1.2.2	SCU	None
		Explicit VR Little Endian	1.2.840.10008.1.2.1		
		Implicit VR Little Endian	1.2.840.10008.1.2		
>Basic Grayscale Image Box SOP Class	1.2.840.10008.5.1.1.4	Explicit VR Big Endian	1.2.840.10008.1.2.2	SCU	None
		Explicit VR Little Endian	1.2.840.10008.1.2.1		
		Implicit VR Little Endian	1.2.840.10008.1.2		
>Printer SOP Class	1.2.840.10008.5.1.1.16	Explicit VR Big Endian	1.2.840.10008.1.2.2	SCU	None
		Explicit VR Little Endian	1.2.840.10008.1.2.1		
		Implicit VR Little Endian	1.2.840.10008.1.2		

This section specifies each IOD created (including private IOD's).

Abbreviations used in the Module table for the column "Presence of Value" are:

ALWAYS	The attribute is always present with a value
EMPTY	The attribute is always present without any value (attribute sent zero length)
VNAP	The attribute is always present and its Value is Not Always Present (attribute sent zero length if no value is present)
ANAP	The attribute is present under specified condition – if present then it will always have a value
VNAPCV	The attribute is present under specified condition – if present then its Value is Not Always Present (attribute sent zero length if condition applies and no value is present)
ANAPEV	The attribute is present under specified condition – if present then it will not have any value

The abbreviations used in the Module table for the column "Source" are:

AUTO	The attribute value is generated automatically
CONFIG	The attribute value source is a configurable parameter
COPY	The attribute value source is another SOP instance
FIXED	The attribute value is hard-coded in the application
IMPLICIT	The attribute value source is a user-implicit setting
MPPS	The attribute value is the same as that use for Modality Performed Procedure Step
MWL	The attribute value source is a Modality Worklist
USER	The attribute value source is explicit user input

4.2.1.3.7.2.1. Dataset Specific Conformance for Basic Film Box SOP Class N-CREATE-SCU

Detail regarding the Dataset Specific response behavior will be reported in this section.

Table 41: Basic Film Box Presentation Module

Attribute Name	Tag	VR	Value	Presence of Value	Source	Comment
Image Display Format	2010,0010	ST		ALWAYS	AUTO	
Film Orientation	2010,0040	CS		ALWAYS	CONFIG, IMPLICIT	
Film Size ID	2010,0050	CS		ALWAYS	CONFIG, IMPLICIT	
Magnification Type	2010,0060	CS		ALWAYS	AUTO	
Max Density	2010,0130	US		ALWAYS	AUTO	
Trim	2010,0140	CS		ALWAYS	AUTO	
Configuration Information	2010,0150	ST		ALWAYS	AUTO	

Table 42: Basic Film Box Relationship Module

Attribute Name	Tag	VR	Value	Presence of Value	Source	Comment
Referenced Film Session Sequence	2010,0500	SQ		ALWAYS	AUTO	
>Referenced SOP Class UID	0008,1150	UI		ALWAYS	AUTO	
>Referenced SOP Instance UID	0008,1155	UI		ALWAYS	AUTO	

This part of the section includes the dataset specific behavior, i.e. error codes, error and exception handling, time-outs, etc.

Table 43: Status Response

Service Status	Error Code	Further Meaning	Behavior
Success	0000	Film accepted for printing.	The print job continues and completes.
Failure	xxxx	(any failure)	Print job fails, the error is logged, and the association is released.
Warning	B603	Film Box SOP Instance hierarchy does not contain Image Box SOP Instances (empty page).	The print job continues and the warning is logged.
	B604	Image size is larger than image box size, the image has been demagnified.	The print job continues and the warning is logged.
	B609	Image size is larger than the image box size. The image has been cropped to fit.	The print job continues and the warning is logged.
	B60A	Image size or combined print image size is larger than the image box size. Image or combined print image has been decimated to fit.	The print job continues and the warning is logged.
	0107	(not defined)	The print job continues and the warning is logged.

Service Status	Error Code	Further Meaning	Behavior
	0116	(not defined)	The print job continues and the warning is logged.
	B600	(not defined)	The print job continues and the warning is logged.
	B601	(not defined)	The print job continues and the warning is logged.
	B602	(not defined)	The print job continues and the warning is logged.
	B605	(not defined)	The print job continues and the warning is logged.
	B606	(not defined)	The print job continues and the warning is logged.
	B608	(not defined)	The print job continues and the warning is logged.
	xxxx	(any other warning)	Print job fails, the warning is logged, and the association is released.

4.2.1.3.7.2.2. Dataset Specific Conformance for Basic Film Box SOP Class N-ACTION-SCU

This part of the section includes the dataset specific behavior, i.e. error codes, error and exception handling, time-outs, etc.

Table 44: Status Response

Service Status	Error Code	Further Meaning	Behavior
Success	0000	Film Box successfully created.	The print job continues and completes.
Failure	xxxx	(any failure)	Print job fails, the error is logged, and the association is released.
Warning	B605	Requested Min Density or Max Density outside of printer's operating range. The printer will use its respective minimum or maximum density value instead.	The print job continues and the warning is logged.
	0107	(not defined)	The print job continues and the warning is logged.
	0116	(not defined)	The print job continues and the warning is logged.
	B600	(not defined)	The print job continues and the warning is logged.
	B601	(not defined)	The print job continues and the warning is logged.
	B602	(not defined)	The print job continues and the warning is logged.
	B603	(not defined)	The print job continues and the warning is logged.
	B604	(not defined)	The print job continues and the warning is logged.
	B606	(not defined)	The print job continues and the warning is logged.
	B608	(not defined)	The print job continues and the warning is logged.
	B609	(not defined)	The print job continues and the warning is logged.
	xxxx	(any other warning)	Print job fails, the warning is logged, and the association is released.

4.2.1.3.7.2.3. Dataset Specific Conformance for Basic Film Box SOP Class N-DELETE-SCU

This part of the section includes the dataset specific behavior, i.e. error codes, error and exception handling, time-outs, etc.

Table 45: Status Response

Service Status	Error Code	Further Meaning	Behavior
Success	0000	Successful command	Print job continues.
Failure	xxxx	(any failure)	Print job fails, the error is logged and the association is released.
Warning	xxxx	(any warning)	Print job fails, the warning is logged and the association is released.

4.2.1.3.7.2.4. Dataset Specific Conformance for Basic Film Session SOP Class N-CREATE-SCU

Detail regarding the Dataset Specific response behavior will be reported in this section.

Table 46: Basic Film Session Presentation Module

Attribute Name	Tag	VR	Value	Presence of Value	Source	Comment
Number of Copies	2000,0010	IS		ALWAYS	IMPLICIT	
Print Priority	2000,0020	CS		ALWAYS	AUTO	
Medium Type	2000,0030	CS		ALWAYS	IMPLICIT	
Film Destination	2000,0040	CS		ALWAYS	AUTO	
Film Session Label	2000,0050	LO		ALWAYS	AUTO	

This part of the section includes the dataset specific behavior, i.e. error codes, error and exception handling, time-outs, etc.

Table 47: Status Response

Service Status	Error Code	Further Meaning	Behavior
Success	0000	Film session successfully created.	The print job continues and completes.
Failure	xxxx	(any failure)	Print job fails, the error is logged, and the association is released.
Warning	B600	Memory allocation not supported.	The print job continues and the warning is logged.
	0107	(not defined)	The print job continues and the warning is logged.
	0116	(not defined)	The print job continues and the warning is logged.
	B601	(not defined)	The print job continues and the warning is logged.
	B602	(not defined)	The print job continues and the warning is logged.
	B603	(not defined)	The print job continues and the warning is logged.
	B604	(not defined)	The print job continues and the warning is logged.
	B605	(not defined)	The print job continues and the warning is logged.
	B606	(not defined)	The print job continues and the warning is logged.
	B608	(not defined)	The print job continues and the warning is logged.
	B609	(not defined)	The print job continues and the warning is logged.
	B60A	(not defined)	The print job continues and the warning is logged.
	xxxx	(any other warning)	Print job fails, the warning is logged, and the association is released.

4.2.1.3.7.2.5. Dataset Specific Conformance for Basic Film Session SOP Class N-DELETE-SCU

This part of the section includes the dataset specific behavior, i.e. error codes, error and exception handling, time-outs, etc.

Table 48: Status Response

Service Status	Error Code	Further Meaning	Behavior
Success	0000	Successful command	The print job continues.
Failure	xxxx	(any failure)	The print job fails, the error is logged and the association is released.
Warning	xxxx	(any warning)	The print job fails, the warning is logged and the association is released.

4.2.1.3.7.2.6. Dataset Specific Conformance for Printer SOP Class N-EVENT-REPORT-SCP

This part of the section includes the dataset specific behavior, i.e. error codes, error and exception handling, time-outs, etc.

Table 49: N-EVENT-REPORT Status Handling Behavior.

Event Type Name	Event Type ID	Behavior
Normal	1	The N-EVENT-REPORT-RSP is sent with: Status = 0, Event Type ID = 1 Information is logged: N-EVENT-REPORT received, type: NORMAL
Warning	2	The N-EVENT-REPORT-RSP is sent to the SCP with: Status = 0, Event Type ID = 2 Warning is logged: N-EVENT-REPORT received, type: WARNING Status info: <Status info>
Failure	3	The N-EVENT-REPORT-RSP is sent to the SCP with: Status = 0, Event Type ID = 3 Error is Logged: N-EVENT-REPORT received, type: FAILURE Status info: <Status info> Printer status is set to DICOM_PRINTER_STATUS_FAILURE. The print job retries the print operation.

All possible status responses are provided in the following table.

Table 50: Status Response

Service Status	Error Code	Further Meaning	Behavior
Success	0000	Successful command	The result is logged.

4.2.1.3.7.2.7. Dataset Specific Conformance for Printer SOP Class N-GET-SCU

This part of the section includes the dataset specific behavior, i.e. error codes, error and exception handling, time-outs, etc.

Table 51: Status Response

Service Status	Error Code	Further Meaning	Behavior
Success	0000	Successful command	The print job continues and completes.
Failure	xxxx	(any failure)	Print job fails, the error is logged, and the association is released.
Warning	0001	Requested optional attributes are not supported	The print job continues and the warning is logged.
	xxxx	(any warning)	Print job fails, the warning is logged, and the association is released.

4.2.1.3.7.3. SOP Specific Conformance for Basic Film Box SOP Class of the Basic Grayscale Print Management Meta SOP Class

This section and sub-section include the manufacturer SOP and Dataset specific information as well the status codes and their corresponding behavior.

4.2.1.3.7.3.1. Dataset Specific Conformance for Basic Film Box SOP Class N-CREATE-SCU

Detail regarding the Dataset Specific response behavior will be reported in this section.

Table 52: Basic Film Box Presentation Module

Attribute Name	Tag	VR	Value	Presence of Value	Source	Comment
Image Display Format	2010,0010	ST		ALWAYS	AUTO	
Film Orientation	2010,0040	CS		ALWAYS	CONFIG, IMPLICIT	
Film Size ID	2010,0050	CS		ALWAYS	CONFIG, IMPLICIT	

Magnification Type	2010,0060	CS		ALWAYS	AUTO	
Max Density	2010,0130	US		ALWAYS	AUTO	
Trim	2010,0140	CS		ALWAYS	AUTO	
Configuration Information	2010,0150	ST		ALWAYS	AUTO	

Table 53: Basic Film Box Relationship Module

Attribute Name	Tag	VR	Value	Presence of Value	Source	Comment
Referenced Film Session Sequence	2010,0500	SQ		ALWAYS	AUTO	
>Referenced SOP Class UID	0008,1150	UI		ALWAYS	AUTO	
>Referenced SOP Instance UID	0008,1155	UI		ALWAYS	AUTO	

This part of the section includes the dataset specific behavior, i.e. error codes, error and exception handling, time-outs, etc.

Table 54: Status Response

Service Status	Error Code	Further Meaning	Behavior
Success	0000	Film Box successfully created.	The print job continues and completes.
Failure	xxxx	(any failure)	Print job fails, the error is logged, and the association is released.
Warning	B605	Requested Min Density or Max Density outside of printer's operating range. The printer will use its respective minimum or maximum density value instead.	The print job continues and the warning is logged.
	0107	(not defined)	The print job continues and the warning is logged.
	0116	(not defined)	The print job continues and the warning is logged.
	B600	(not defined)	The print job continues and the warning is logged.
	B601	(not defined)	The print job continues and the warning is logged.
	B602	(not defined)	The print job continues and the warning is logged.
	B603	(not defined)	The print job continues and the warning is logged.
	B604	(not defined)	The print job continues and the warning is logged.
	B606	(not defined)	The print job continues and the warning is logged.
	B608	(not defined)	The print job continues and the warning is logged.
	B609	(not defined)	The print job continues and the warning is logged.
	B60A	(not defined)	The print job continues and the warning is logged.
	xxxx	(any warning)	Print job fails, the warning is logged, and the association is released.

4.2.1.3.7.3.2. Dataset Specific Conformance for Basic Film Box SOP Class N-ACTION-SCU

This part of the section includes the dataset specific behavior, i.e. error codes, error and exception handling, time-outs, etc.

Table 55: Status Response

Service Status	Error Code	Further Meaning	Behavior
Success	0000	Film accepted for printing.	The print job continues and completes.
Failure	xxxx	(any failure)	Print job fails, the error is logged, and the association is released.
Warning	B603	Film Box SOP Instance hierarchy does not contain Image Box SOP Instances (empty page).	The print job continues and the warning is logged.

Service Status	Error Code	Further Meaning	Behavior
	B604	Image size is larger than image box size, the image has been demagnified.	The print job continues and the warning is logged.
	B609	Image size is larger than the image box size. The image has been cropped to fit.	The print job continues and the warning is logged.
	B60A	Image size or combined print image size is larger than the image box size. Image or combined print image has been decimated to fit.	The print job continues and the warning is logged.
	0107	(not defined)	The print job continues and the warning is logged.
	0116	(not defined)	The print job continues and the warning is logged.
	B600	(not defined)	The print job continues and the warning is logged.
	B601	(not defined)	The print job continues and the warning is logged.
	B602	(not defined)	The print job continues and the warning is logged.
	B605	(not defined)	The print job continues and the warning is logged.
	B606	(not defined)	The print job continues and the warning is logged.
	B608	(not defined)	The print job continues and the warning is logged.
	xxxx	(any other warning)	Print job fails, the warning is logged, and the association is released.

4.2.1.3.7.3.3. Dataset Specific Conformance for Basic Film Box SOP Class N-DELETE-SCU

This part of the section includes the dataset specific behavior, i.e. error codes, error and exception handling, time-outs, etc.

Table 56: Status Response

Service Status	Error Code	Further Meaning	Behavior
Success	0000	Successful command	The print job continues and completes.
Failure	xxxx	(any failure)	Print job fails, the error is logged and the association is released.
Warning	xxxx	(any warning)	Print job fails, the warning is logged and the association is released.

4.2.1.3.7.4. SOP Specific Conformance for Basic Film Session SOP Class of the Basic Grayscale Print Management Meta SOP Class

This section and sub-section include the manufacturer SOP and Dataset specific information as well the status codes and their corresponding behavior.

4.2.1.3.7.4.1. Dataset Specific Conformance for Basic Film Session SOP Class N-CREATE-SCU

Detail regarding the Dataset Specific response behavior will be reported in this section.

Table 57: Basic Film Session Presentation Module

Attribute Name	Tag	VR	Value	Presence of Value	Source	Comment
Number of Copies	2000,0010	IS		ALWAYS	IMPLICIT	
Print Priority	2000,0020	CS		ALWAYS	AUTO	
Medium Type	2000,0030	CS		ALWAYS	IMPLICIT	
Film Destination	2000,0040	CS		ALWAYS	AUTO	
Film Session Label	2000,0050	LO		ALWAYS	AUTO	

This part of the section includes the dataset specific behavior, i.e. error codes, error and exception handling, time-outs, etc.

Table 58: Status Response

Service Status	Error Code	Further Meaning	Behavior
Success	0000	Film session successfully created.	The print job continues and completes.
Failure	xxxx	(any failure)	Print job fails, the error is logged, and the association is released.
Warning	B600	Memory allocation not supported.	The print job continues and the warning is logged.
	0107	(not defined)	The print job continues and the warning is logged.
	0116	(not defined)	The print job continues and the warning is logged.
	B601	(not defined)	The print job continues and the warning is logged.
	B602	(not defined)	The print job continues and the warning is logged.
	B603	(not defined)	The print job continues and the warning is logged.
	B604	(not defined)	The print job continues and the warning is logged.
	B605	(not defined)	The print job continues and the warning is logged.
	B606	(not defined)	The print job continues and the warning is logged.
	B608	(not defined)	The print job continues and the warning is logged.
	B609	(not defined)	The print job continues and the warning is logged.
	B60A	(not defined)	The print job continues and the warning is logged.
	xxxx	(any other warning)	Print job fails, the warning is logged, and the association is released.

4.2.1.3.7.4.2. Dataset Specific Conformance for Basic Film Session SOP Class N-DELETE-SCU

This part of the section includes the dataset specific behavior, i.e. error codes, error and exception handling, time-outs, etc.

Table 59: Status Response

Service Status	Error Code	Further Meaning	Behavior
Success	0000	Command successful	Print job continues.
Failure	xxxx	(any failure)	Print job fails, the error is logged, and the association is released.
Warning	xxxx	(any warning)	Print job fails, the warning is logged, and the association is released.

4.2.1.3.7.5. SOP Specific Conformance for Basic Grayscale Image Box SOP Class of the Basic Grayscale Print Management Meta SOP Class

This section and sub-section include the manufacturer SOP and Dataset specific information as well the status codes and their corresponding behavior.

4.2.1.3.7.5.1. Dataset Specific Conformance for Basic Grayscale Image Box SOP Class N-SET-SCU

Detail regarding the Dataset Specific response behavior will be reported in this section.

Table 60: Image Box Pixel Presentation Module

Attribute Name	Tag	VR	Value	Presence of Value	Source	Comment
Image Box Position	2020,0010	US		ALWAYS	AUTO	
Polarity	2020,0020	CS		ALWAYS	AUTO	
Basic Grayscale Image Sequence	2020,0110	SQ		ALWAYS	AUTO	
>Samples per Pixel	0028,0002	US		ALWAYS	AUTO	
>Photometric Interpretation	0028,0004	CS		ALWAYS	IMPLICIT	
>Rows	0028,0010	US		ALWAYS	IMPLICIT	
>Columns	0028,0011	US		ALWAYS	IMPLICIT	
>Bits Allocated	0028,0100	US		ALWAYS	AUTO	
>Bits Stored	0028,0101	US		ALWAYS	IMPLICIT	
>High Bit	0028,0102	US		ALWAYS	AUTO	

>Pixel Representation	0028,0103	US		ALWAYS	AUTO	
>Pixel Data	7FE0,0010	OW/OB		ALWAYS	AUTO	

This part of the section includes the dataset specific behavior, i.e. error codes, error and exception handling, time-outs, etc.

Table 61: Status Response

Service Status	Error Code	Further Meaning	Behavior
Success	0000	Successful command	The print job continues and completes.
Failure	xxxx	(any failure)	Print job fails, the error is logged, and the association is released.
Warning	B604	Image size is larger than image box size, the image has been demagnified.	The print job continues and the warning is logged.
	B609	Image size is larger than the image box size. The image has been cropped to fit.	The print job continues and the warning is logged.
	B60A	Image size or combined print image size is larger than the image box size. Image or combined print image has been decimated to fit.	The print job continues and the warning is logged.
	0107	(not defined)	The print job continues and the warning is logged.
	0116	(not defined)	The print job continues and the warning is logged.
	B600	(not defined)	The print job continues and the warning is logged.
	B601	(not defined)	The print job continues and the warning is logged.
	B602	(not defined)	The print job continues and the warning is logged.
	B603	(not defined)	The print job continues and the warning is logged.
	B605	(not defined)	The print job continues and the warning is logged.
	B606	(not defined)	The print job continues and the warning is logged.
	B608	(not defined)	The print job continues and the warning is logged.
	xxxx	(any other warning)	Print job fails, the warning is logged, and the association is released.

4.2.1.3.7.6. SOP Specific Conformance for Printer SOP Class of the Basic Grayscale Print Management Meta SOP Class

This section and sub-section include the manufacturer SOP and Dataset specific information as well the status codes and their corresponding behavior.

4.2.1.3.7.6.1. Dataset Specific Conformance for Printer SOP Class N-EVENT-REPORT-SCP

This part of the section includes the dataset specific behavior, i.e. error codes, error and exception handling, time-outs, etc.

Table 62: N-EVENT-REPORT Status Handling Behavior.

Event Type Name	Event Type ID	Behavior
Normal	1	The N-EVENT-REPORT-RSP is sent to the SCP with: Status = 0, Event Type ID = 1 Information is logged: N-EVENT-REPORT received, type: NORMAL
Warning	2	The N-EVENT-REPORT-RSP is sent to the SCP with: Status = 0, Event Type ID = 2 Warning is logged: N-EVENT-REPORT received, type: WARNING Status info: <Status info>
Failure	3	The N-EVENT-REPORT-RSP is sent to the SCP with: Status = 0, Event Type ID = 3 Error is Logged: N-EVENT-REPORT received, type: FAILURE Status info: <Status info> Printer status is set to DICOM_PRINTER_STATUS_FAILURE. The print job retries the print operation.

All possible status responses are provided in the following table.

Table 63: Status Response

Service Status	Error Code	Further Meaning	Behavior
Success	0000	Successful command	The result is logged.

4.2.1.3.7.6.2. Dataset Specific Conformance for Printer SOP Class N-GET-SCU

This part of the section includes the dataset specific behavior, i.e. error codes, error and exception handling, time-outs, etc.

Table 64: Status Response

Service Status	Error Code	Further Meaning	Behavior
Success	0000	Successful command	The print job continues and completes.
Failure	xxxx	(any failure)	Print job fails, the error is logged, and the association is released.
Warning	xxxx	(any warning)	Print job fails, the warning is logged, and the association is released.

4.2.1.4. Association Acceptance Policy

The BV Vectra Network AE accepts associations for the following purposes:

- To allow remote applications to verify application level communication.
- To allow remote applications to store images in the BV Vectra database.
- To allow remote applications to commit images in the BV Vectra database.
- To allow remote applications to send storage commit reports to BV Vectra as SCU.

The BV Vectra Network AE rejects association requests from unknown applications, i.e. applications that offer an unknown "calling AE title". An application is known if and only if it is defined per configuration of the BV Vectra system. The BV Vectra Network AE also rejects association requests from applications that do not address the BV Vectra Network AE, i.e. that offer a wrong "called AE title". The BV Vectra AE title is defined during configuration of BV Vectra.

The Application Entity may reject Association attempts as shown in the table below.

Table 65: Association Reject Reasons

Result	Source	Reason/Diagnosis	Behavior
1 - rejected permanent	1 - DICOM UL service-user	1 - no-reason-given	Association is not established due to any problem other than that specified for BV Vectra SCP in the rows below. (Example: Problem while decoding the DICOM stream).
		2 - application-context-name-not-supported	An application context name other than 1.2.840.10008.3.1.1.1 is requested by the SCU during association.
		3 - calling-AE-title-not-recognized	The configuration does not contain a repository having the Calling AE Title as per the association request; There is a problem in configuration (related to composing the configuration from the SCU and the SCP configuration).
		7 - called-AE-title-not-recognized	The called AE Title in the association request does not match the AE Title as per the configuration.
	2 - DICOM UL service provider (ACSE related function)	1 - no-reason-given	Not used.
		2 - protocol-version-not-supported	Not used.
		3 - DICOM UL service provider (Presentation related function)	1 - temporary-congestion 2 - local-limit-exceeded
2 - rejected-transient	1 - DICOM UL service-user	1 - no-reason-given	Not used.
		2 - application-context-name-not-supported	Not used.

Result	Source	Reason/Diagnosis	Behavior
		3 - calling-AE-title-not-recognized	Not used.
		7 - called-AE-title-not-recognized	Not used.
	2 - DICOM UL service provider (ACSE related function)	1 - no-reason-given	Maximum number of associations is exceeded and an association request is received.
		2 - protocol-version-not-supported	Not used.
	3 - DICOM UL service provider (Presentation related function)	1 - temporary-congestion	Not used.
		2 - local-limit-exceeded	Not used.

The behavior of the AE for sending an Association abort is summarized in next table.

Table 66: Association Abort Policies

Source	Reason/Diagnosis	Behavior when received	Sent when
0 - DICOM UL service-user(initiated abort)	0 - reason-not-specified	When received, the BV Vectra Network AE terminates the connection with the following log: Association ABORTED by peer (0: ABORT_SOURCE_dul_user, 0: ABORT_REASON_not_specified).	Association times out due to inactivity; Any other problem than ones specified for BV Vectra SCP in the rows below. (Examples: Problem while decoding the DICOM stream, Invalid request, Echo/Find/Move/N-Action SCP was unable to send the Response to SCU, Error writing to SCU stream).
2 - DICOM UL service-provider initiated abort)	0 - reason-not-specified	When received, the BV Vectra Network AE terminates the connection with the following log: Association ABORTED by peer (2: ABORT_SOURCE_dul_provider, 0: ABORT_REASON_not_specified)	Import fails (Import SCP Performer returns fail status)
	1 - unrecognized-PDU	When received, the BV Vectra Network AE terminates the connection with the following log: Association ABORTED by peer (2: ABORT_SOURCE_dul_provider, 1: ABORT_REASON_unrecognized_pdu).	An unrecognized PDU type is received ⁴ .
	2 - unexpected-PDU	When received, the BV Vectra Network AE terminates the connection with the following log: Association ABORTED by peer (2: ABORT_SOURCE_dul_provider, 2: ABORT_REASON_unexpected_pdu).	The received PDU type is not expected in the current state of connection ⁵ .
	4 - unrecognized-PDU parameter	AE terminates the connection with the following log: Association ABORTED by peer (2: ABORT_SOURCE_dul_provider, 4: ABORT_REASON_unrecognized_pdu_parameter).	An unrecognized Associate PDU item is received ¹ .
	5 - unexpected-PDU parameter	When received, the BV Vectra Network AE terminates the connection with the following log: Association ABORTED by peer (2: ABORT_SOURCE_dul_provider, 5: ABORT_REASON_unexpected_pdu_parameter).	One of the Associate PDU items is received more than once ² ; One of the Associate PDU items is received unexpectedly ² .
	6 - invalid-PDU-parameter value	When received, the BV Vectra Network AE terminates the connection with the following log: Association ABORTED by peer (2: ABORT_SOURCE_dul_provider, 6: ABORT_REASON_invalid_pdu_parameter).	One of the Associate PDU items is received more than once ³ ; One of the Associate PDU items is not received ³ ; Empty Called AE Title String (space-only) is received; Empty Calling AE Title String (space-only) is received; Unknown abstract syntax is received; The length or the format of the received PDU item is invalid.

4.2.1.4.1. (Real-World) Activity – Verification as SCP

4.2.1.4.1.1. Description and Sequencing of Activities

BV Vectra accepts Associations from configured systems that wish to verify application level communication using the C-ECHO command.

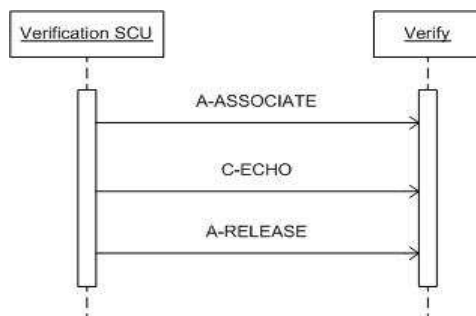

Figure 12: Data Flow Diagram – Verify.

4.2.1.4.1.2. Accepted Presentation Contexts

The presentation contexts are defined in the next table.

Table 67: Acceptable Presentation Contexts for (Real-World) Activity – Verification as SCP

Presentation Context Table					
Abstract Syntax		Transfer Syntax		Role	Extended Negotiation
Name	UID	Name List	UID List		
Verification SOP Class	1.2.840.10008.1.1	Explicit VR Big Endian	1.2.840.10008.1.2.2	SCP	None
		Explicit VR Little Endian	1.2.840.10008.1.2.1		
		Implicit VR Little Endian	1.2.840.10008.1.2		

BV Vectra accepts all contexts in the intersection of the proposed and acceptable Presentation Contexts. This means that multiple proposed presentation contexts with the same SOP class but different transfer syntaxes are accepted by the BV Vectra as far as those transfer syntaxes are part of the acceptable transfer syntaxes. There is no check for duplicate contexts and these are therefore accepted.

4.2.1.4.1.3. SOP Specific Conformance for Verification SOP Class

This section and sub-section include the manufacturer SOP and Dataset specific information as well the status codes and their corresponding behavior.

4.2.1.4.1.3.1. Dataset Specific Conformance for Verification C-ECHO SCP

This part of the section includes the dataset specific behavior, i.e. error codes, error and exception handling, time-outs, etc.

Table 68: Status Response

Service Status	Error Code	Further Meaning	Behavior
Success	0000	Confirmation	Confirm the verification request.

4.2.1.4.2. (Real-World) Activity – Image Import

4.2.1.4.2.1. Description and Sequencing of Activities

The BV Vectra Network AE accepts associations from configured systems that wish to store images in the BV Vectra database using the C-STORE command.

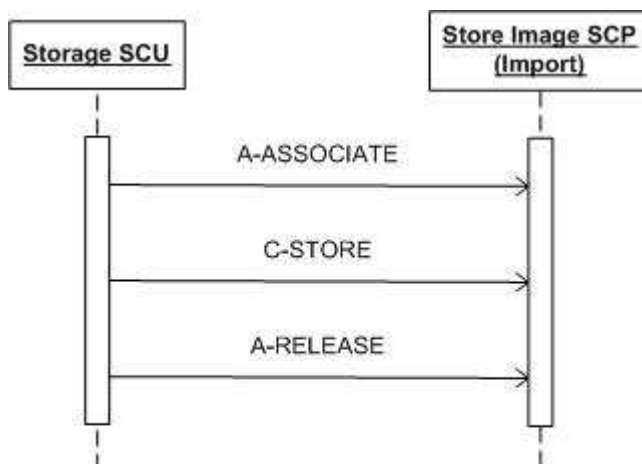

Figure 13: Data Flow Diagram – Store Image (Storage as SCP).

4.2.1.4.2.2. Accepted Presentation Contexts

The presentation contexts are defined in the next table.

Table 69: Acceptable Presentation Contexts for (Real-World) Activity – Image Import

Presentation Context Table					
Abstract Syntax		Transfer Syntax		Role	Extended Negotiation
Name	UID	Name List	UID List		
Grayscale Softcopy Presentation State Storage SOP Class	1.2.840.10008.5.1.4.1.1.11.1	Explicit VR Big Endian	1.2.840.10008.1.2.2	SCP	None
		Explicit VR Little Endian	1.2.840.10008.1.2.1		
		Implicit VR Little Endian	1.2.840.10008.1.2		
Multi-frame Grayscale Word SC Image Storage SOP Class	1.2.840.10008.5.1.4.1.1.7.3	Explicit VR Big Endian	1.2.840.10008.1.2.2	SCP	None
		Explicit VR Little Endian	1.2.840.10008.1.2.1		
		Implicit VR Little Endian	1.2.840.10008.1.2		
Secondary Capture Image Storage SOP Class	1.2.840.10008.5.1.4.1.1.7	Explicit VR Big Endian	1.2.840.10008.1.2.2	SCP	None
		Explicit VR Little Endian	1.2.840.10008.1.2.1		
		Implicit VR Little Endian	1.2.840.10008.1.2		
X-Ray Angiographic Image Storage SOP Class	1.2.840.10008.5.1.4.1.1.12.1	Explicit VR Big Endian	1.2.840.10008.1.2.2	SCP	None
		Explicit VR Little Endian	1.2.840.10008.1.2.1		
		Implicit VR Little Endian	1.2.840.10008.1.2		

Note:

The BV Vectra Network AE has the following Import limitations:

- Images with a non square pixel matrix (e.g. 800x700) are ignored
- Images with a pixel depth (bits stored) not equal to 8 or 10 bits are rejected.
- Images with a photometric interpretation other than monochrome (e.g RGB) are rejected.

4.2.1.4.2.3. SOP Specific Conformance for Storage SOP Classes

This section and sub-section include the manufacturer SOP and Dataset specific information as well the status codes and their corresponding behavior.

4.2.1.4.2.3.1. Dataset Specific Conformance for C-STORE-RSP

This includes the dataset specific behavior, i.e. error codes, error and exception handling, time-outs, etc.

Table 70: Status Response

Service Status	Error Code	Further Meaning	Behavior
Success	0000	Successful operation	The images shall be stored in the local database. Success shall be logged.
Refused	A700-A7FF	Out of Resources	The local database is full – recovery from this condition is left to the SCU. The ACP AE shall send a notification, and abort the association. The failure reason is logged.
Error	A900	Data Set does not match SOP Class	SOP class of the image(s) does not match the negotiated abstract syntax. The ACP AE shall send a notification and abort the association. The failure reason is logged.
	C000	Cannot Understand	The image(s) cannot be parsed. The ACP AE shall send a notification and abort the association. The failure reason is logged.
Warning	B000	Coercion of Data Elements	The association is aborted using A-ABORT and the send job is marked as failed. The failure reason is logged.
	B006	Elements discarded	The association is aborted using A-ABORT and the send job is marked as failed. The failure reason is logged.
	B007	Data set does not match SOP class	The association is aborted using A-ABORT and the send job is marked as failed. The failure reason is logged.

4.3. Network Interfaces

4.3.1. Physical Network Interfaces

The System provides only DICOM V3.0 TCP/IP Network Communication Support as defined in PS 3.8 of the standard. TCP/IP is the only protocol stack supported.

Supported physical medium include:

- IEEE 802.3-1995, 10BASE-T
- IEEE 802.3-1995, 100BASE-TX (Fast Ethernet)
- IEEE 802.3, 1000BASE-X (Fiber Optic Gigabit Ethernet).

The TCP/IP Stack as supported by the underlying Operating System.

The API is the WinSock 2 interface as supported by the underlying Operating System.

4.3.2. Additional Protocols

No additional protocols are used.

4.4. Configuration

Any implementation's DICOM conformance may be dependent upon configuration, which takes place at the time of installation. Issues concerning configuration are addressed in this section.

4.4.1. AE Title/Presentation Address Mapping

An important installation issue is the translation from AE title to presentation address. How this is to be performed is described here.

4.4.1.1. Local AE Titles

The Field Service User Interface only allows one AE to be configured.

The following AE specific information must be available to configure a local AE:

- AE title.
- Hostname or IP address (or both). Use "localhost" (127.0.0.1) for the complete local system. If the AE should only be associated with a specific network adapter, don't specify the host name and use the IP address of this network adapter.
- Port number (note that normally all local BV Vectra AE's will have a different port number).

4.4.1.2. Remote AE Title/Presentation Address Mapping

One or more remote AEs may be configured.

The following AE specific information must be available to configure a remote AE:

- AE title.
- Hostname or IP address (or both).
- Port number.

4.4.2. Parameters

The specification of important operational parameters, their default value and range (if configurable) are specified here.

Table 71: Configuration Parameters Table

Parameter	Configurable	Default Value
General Parameter		
Time-out waiting for acceptance or rejection Response to an Association Open Request (Application Level timeout)	No	60 [s] (set 0 for no time-out)
General DIMSE level time-out values (Verification, Storage, Storage Commitment)	No	-
Time-out for response to TCP/IP connect request. (Low-level timeout)	No	-
Time-out waiting for acceptance of a TCP/IP message over the network (Low-level timeout)	No	-
Time-out for waiting for data between TCP/IP packets. (Low-level timeout)	No	-
Any changes to default TCP/IP settings, such as configurable stack parameters.	No	-
AE Specific Parameters		
Size constraint in maximum object size	No	-
Maximum PDU size the AE can send and receive	No	0
Association time-out SCP	No	0 (no time-out)
Association time-out SCU	No	0 (no time-out; set -1 for immediate time-out, or else value in [s])
AE specific DIMSE level time-out values	Yes	300 [s] (set 0 for no time-out)
Storage Commit Max Reply Waiting Time (after time-out the reply will be handled asynchronously)	Yes	60 [s] (set 0 for no time-out, -1 for immediate time-out)
Number of simultaneous associations by service and/or SOP class	No	1 per service/SOP class
SOP Class support	Yes	All supported SOP classes
Transfer Syntax support*	Yes	ELE - 1.2.840.10008.1.2.1 EBE - 1.2.840.10008.1.2.2 ILE - 1.2.840.10008.1.2 JPEG Lossless (NH-FOP) - 1.2.840.10008.1.2.4.70 JPEG Extended - 1.2.840.10008.1.2.4.51 JPEG 2000 (Lossless Only) - 1.2.840.10008.1.2.4.90 JPEG 2000 - 1.2.840.10008.1.2.4.91 RLE - 1.2.840.10008.1.2.5
IsArchive	Yes	False

***Note:**

Although it is possible to configure encapsulation transfer syntax for every SOP class, encapsulation transfer syntax is practically not applicable for SOP classes that contain no data to be encoded and such transfer syntax should therefore be omitted.

Also note that the order of the specified transfer syntaxes for a SOP class or AE in the configuration determines the preference order of proposed transfer syntaxes. Per default all transfer syntaxes are enabled. Take care that certain presentation context are not

practical. Some transfer syntaxes may only be used on certain datasets, and should not be proposed for other datasets. E.g. never propose lossy JPEG compression for 16 bits images as this is not applicable. Currently JPEG Extended is applicable to 12 bits images only (process 4).

5. Media Interchange

5.1. Implementation model

The implementation model identifies the DICOM Application Entities for Media in specific implementation and relates the Application Entities to Real-World Activities.

5.1.1. Application Data Flow Diagram

The BV Vectra implements one media application entity: the BV Vectra Media.

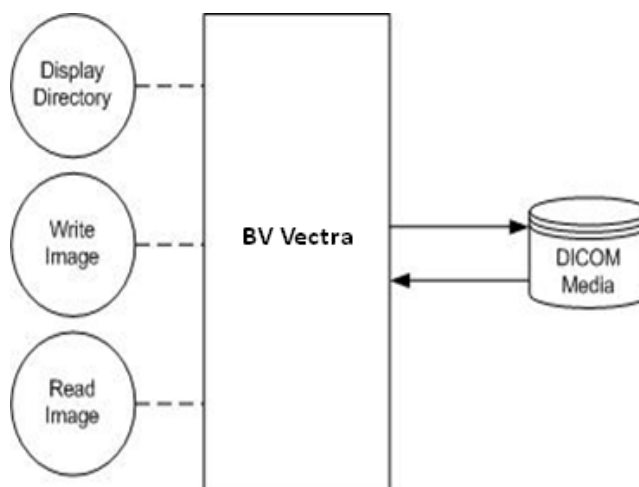

Figure 14: Application Data Flow Diagram.

5.1.2. Functional Definitions of AE's

The BV Vectra implements the following functions for DICOM media:

- Write a DICOM file-set onto the medium.
- Create a DICOMDIR file.
- Read the DICOMDIR file from the medium.
- Read selected images from the medium.

5.1.3. Sequencing of Real World Activities

Not applicable.

5.2. AE Specifications

This section in the DICOM Conformance Statement specifies a set of Media Application Entities.

5.2.1. BV Vectra Media - Specification

This section contains general policies that apply to all of the Application Entities described in subsequent section.

BV Vectra provides standard conformance to the DICOM interchange option of the media storage service class, and follows the specifications as defined in the DICOM standard – Media Storage and File Format for Data Interchange (PS 3.10) and Media Storage Application Profiles (PS 3.11).

BV Vectra supports multi-patient and multi-session for CD-R media (both reading and writing). For one or more Application Profiles, the following table shows the Real-World Activities and the roles of each of these Real-World Activities.

Note:

Read File-set = Display Directory and Read Image

Create File-set = Write Image

Table 72: AE BV Vectra Media related Application Profiles, RWA activities and roles

Supported Application Profile	Identifier	Real-World Activities	Roles
General Purpose CD-R Interchange	STD-GEN-CD	Create File-set	FSC
		Read File-set	FSR
General Purpose DVD Interchange with JPEG	STD-GEN-DVD-JPEG	Create File-set	FSC
		Read File-set	FSR
General Purpose DVD Interchange with JPEG 2000	STD-GEN-DVD-J2K	Create File-set	FSC
		Read File-set	FSR
General Purpose USB Media Interchange with JPEG	STD-GEN-USB-JPEG	Create File-set	FSC
		Read File-set	FSR
General Purpose USB Media Interchange with JPEG-2000	STD-GEN-USB-J2K	Create File-set	FSC
		Read File-set	FSR

5.2.1.1. File Meta Information for the BV Vectra Media

Table 73: File Meta Information for the BV Vectra Media

Implementation Class UID	1.3.46.670589.7.50.2.0.1
Implementation Version Name	1.1.2.5

5.2.1.2. Real-World Activities

The AE specification contains a description of the Real-World Activities, which invoke the particular AE.

5.2.1.2.1. RWA - Read File-set

This Media Application Entity has a File-set Reader functionality which is described here.

Display Directory:

The BV Vectra will act as a FSR when reading the directory of the medium. This allows the user to see the results in an overview of the patients, studies, series presentation states and images.

The BV Vectra will not access DICOM media when either:

- Patient ID is absent; or
- Study Instance UID has no value; or
- Series Instance UID has no value.

Read Image:

The BV Vectra will act as a FSR when reading all/selected images from DICOM media.

5.2.1.2.1.1. Media Storage Application Profile

Refer to the table in section 5.2.1.

5.2.1.2.1.1.1. Options

Not applicable.

5.2.1.2.2. RWA - Create File-set

This Media Application Entity has a File-set Creator functionality which is described here.

Write Images:

BV Vectra acts as an FSC when writing DICOM objects onto DICOM media.

BV Vectra can also store private attributes.

When the BV Vectra has to write objects to DICOM media, it can encounter the following situation.

The objects were new acquired images. BV Vectra supplies a value for the following attributes:

- Patient ID;
- Study ID;
- Series Number;
- Instance number;
- Study Date;
- Study Time.

5.2.1.2.2.1. Media Storage Application Profile

See table in section 5.2.1.

5.2.1.2.2.1.1. Options

Not applicable.

5.3. Augmented and Private Application Profiles

This section is used for the description of Augmented and Private Application Profiles.

5.3.1. Augmented Application Profiles

Any Augmented Application Profiles used by the Application Entity are described in this section. The rules governing the structure of an Augmented Application Profile are also described.

5.3.1.1. Augmented Application Profile Descriptions

Each Augmented Application Profile has a section that describes the specific features of the Application Profile that make it augmented.

5.3.1.1.1. SOP Class Augmentations

The additional SOP Classes beyond those specified in the Standard Application Profile on which this Augmented Application Profile is based are detailed in this section.

5.3.1.1.2. Directory Augmentations

Any additions to the Directory IOD that augment this Application Profile are described in this section.

5.3.1.1.3. Other Augmentations

Any additions to, or extensions of the Application Profile are described in this section.

5.3.2. Private Application Profiles

Not applicable.

5.4. Media Configuration

Not applicable.

6. Support of Character Sets

Any support for character sets in Network and Media services is described here.

Table 74: Supported DICOM Character Sets

Character Set Description	Defined Term	ESC Sequence	ISO Registration Number	Code Element	Character Set
Latin alphabet No. 1	ISO 2022 IR 100	ESC 02/08 04/02	ISO-IR 6	G0	ISO 646
		ESC 02/13 04/01	ISO-IR 100	G1	Supplementary set of ISO 8859

As can be seen in the table above, BV Vectra supports all character sets currently defined by DICOM except for the multi-byte character sets without code extensions.

The preferred character set can be configured. If not configured, the default character set shall be ISO-IR 100.

When an unsupported character set is received it shall be tried and decoded according the preferred character set.

Unsupported characters shall be displayed as "?".

7. Security

7.1. Security Profiles

BV Vectra does not fully support DICOM security profiles. However, it does support security measures that will be used for secure authentication of a node and for the generation of audit records. The BV Vectra component for security measure is:

- TLS Component

7.1.1. Security use Profiles

Not applicable

7.1.2. Security Transport Connection Profiles

The TLS Component is a "mode of operation" of BV Vectra and will be used for nodes that can authenticate each other before they communicate over sockets. TLS can only be used using TCP. Node authentication and encryption are only possible when the node has:

- a "private and public key";
- a self-signed certificate or certificate signed by a Certificate Authority; and
- a list of certificates with which the system wants to communicate.

Furthermore the TLS component may communicate using the following Cipher Suites:

- TLS_RSA_WITH_NULL_SHA; (Node authentication without encryption)
- TLS_RSA_WITH_3DES_SHA. (Node authentication with encryption)

In case no encryption is used the data is signed and hashed: integrity is present and confidentiality is not present.

Certificates

If two systems communicate with each other, one system will be listening on a port (server node) while the other system sets up a connection (client node). The certificate this server node will send to the other client node is the server certificate. The client node initiates the communication and the certificate that the client node is sending to the server is the client certificate. (Server Client Authentication) The following TLS Certification checks will be done (TLS Handshake). The machine (either server or client) that will send its certificate will choose the certificate according to Common Name (CN) value in the Subject-field. This name is case-sensitive. All present certificates should have unique CN names.

The server verifies:

- that the client certificate is a valid X.509 certificate;
- that the client certificate is either signed by a CA or is self-signed;
- that the client certificate is in the list of trusted certificates;
- that the client certificate is valid (present time is between "Valid From" and "Valid To" fields of the X.509 certificate);
- that the client certificate has the correct purpose (at least the Client Authenticate purpose).

The client verifies:

- that the server certificate is a valid X.509 certificate;
- that the server certificate either is signed by a CA or is self-signed;
- that the server certificate is in the list of trusted certificates;
- that the server certificate is valid (present time is between "Valid From" and "Valid To" fields of the X.509 certificate);
- that the server certificate has the correct purpose (at least Server Authenticate purpose).

In the TLS component no verification is done on:

- Revocation of certificates;
- Limiting the connection to a limited set of IP-addresses.

Additional information:

The value in the Subject-field is determined in the certificate request. The CA will sign the request in case it accepts the values that are present in the request. The CN value can be: IP-number, hostname or hostname.domain. The value in the CN-field must be equal to the value that is used in making a connection to the server. In case the name is specified as hostname.domain that same value should be specified during connect. In the ideal situation the name-IP-number translation will be dealt with by the DNS in the hospital. This check is case-insensitive.

7.1.3. Digital Signature Profiles

Not applicable

7.1.4. Media Storage Security Profiles

Not applicable

7.1.5. Attribute Confidentiality Profiles

Not applicable

7.1.6. Network Address Management Profiles

Not applicable

7.1.7. Time Synchronization Profiles

Not applicable

7.1.8. Application Configuration Management Profiles

Not applicable

7.1.9. Audit Trail Profiles

Not applicable

7.2. Association Level Security

BV Vectra accepts associations only from known applications or an application whose "calling AE Title" is defined in its configuration file. BV Vectra will reject association requests from unknown applications, i.e. applications that offer an unknown "calling AE title". An application entity (AE) is known if – and only if – it is defined during configuration of BV Vectra, which is done via the configuration application.

7.3. Application Level Security

BV Vectra allows the use of either conventional (non-secure) communication or secure communication based on the Transport Layer Security (TLS) protocol. If configured, BV Vectra supports security measures for:

- Secure authentication of a node;
- Integrity and confidentiality of transmitted data;
- Access control and user authentication.

7.3.1. Basic Application Level Confidentiality Profile

BV Vectra conforms to the Basic Application Level Confidentiality Profile as a de-identifier. This functionality is targeted towards creating a special purpose, de-identified version of an already existing Data set.

Table presents all attributes that can be de-identified by the BV Vectra. Each Attribute to be protected has its value replaced by a different "replacement value" which does not allow identification of the patient.

Table 75: De-identified Attributes

Attribute Name	Tag	Replacement Value
Instance Creator UID	0008,0014	No values
Accession Number	0008,0050	No values
Institution Name	0008,0080	No values
Institution Address	0008,0081	No values
Referring Physicians Name	0008,0090	No values
Referring Physician Address	0008,0092	No values
Referring Physician Telephone Numbers	0008,0094	No values
Station Name	0008,1010	No values
Study Description	0008,1030	No values
Series Description	0008,103E	No values
Institutional Department Name	0008,1040	No values
Physicians Of Record	0008,1048	No values
Performing Physician Name	0008,1050	No values
Name Of Physicians Reading Study	0008,1060	No values
Operators Name	0008,1070	No values
Admitting Diagnoses Description	0008,1080	No values
Derivation Description	0008,2111	No values
Patient Name	0010,0010	Value configurable by user.
Patient Birth Date	0010,0030	No values
Patient Birth Time	0010,0032	No values
Patient Sex	0010,0040	No values
Other Patient Ids	0010,1000	No values
Other Patient Names	0010,1001	No values
Patients Age	0010,1010	No values
Patients Size	0010,1020	No values
Patients Weight	0010,1030	No values
Medical Record Locator	0010,1090	No values
Ethnic Group	0010,2160	No values
Occupation	0010,2180	No values
Additional Patient History	0010,21B0	No values
Patient Comments	0010,4000	No values
Device Serial Number	0018,1000	No values
Protocol Name	0018,1030	No values
Study ID	0020,0010	No values
Frame Of Reference UID	0020,0052	New Unique Random value
Synchronization Frame Of Reference UID	0020,0200	New Unique Random value
Image Comments	0020,4000	No values
Request Attributes Sequence	0040,0275	No values
Storage Media File Set ID	0088,0130	No values
Patient ID	0010,0020	New Unique Random value
Study Instance UID	0020,000D	New Unique Random value
Series Instance UID	0020,000E	New Unique Random value
Patient Address	0010,1040	No values
Patient Telephone Numbers	0010,2154	No values

8. Annexes of application "BV Vectra"

8.1. IOD Contents

8.1.1. Created SOP Instance

This section specifies each IOD created by this application.

Note on Softcopy Presentation State IOD (Section 8.1.1.2)

The BV Vectra application creates at least one ('AS ACQUIRED') and usually also a second ('AS LAST SEEN') presentation state. Section 8.1.1.2 specifies the attributes that are created to export a presentation state object. This presentation state object shall also export all relevant attributes (ref. [DICOM] on Grayscale Softcopy Presentation State IOD) as stored per original image.

This section specifies each IOD created (including private IODs). It specifies the attribute name, tag, VR, and value. The value should specify the range and source (e.g. user input, Modality Worklist, automatically generated, etc.). For content items in templates, the range and source of the concept name and concept values should be specified. Whether the value is always present or not shall be specified.

This section specifies each IOD created (including private IOD's). It should specify the attribute name, tag, VR, and value. The value should specify the range and source (e.g. user input, Modality Worklist, automatically generated, etc.). For content items in templates, the range and source of the concept name and concept values should be specified. Whether the value is always present or not shall be specified.

Abbreviations used in the IOD tables for the column "Presence of Module" are:

ALWAYS	The module is always present
CONDITIONAL	The module is used under specified condition

Abbreviations used in the Module table for the column "Presence of Value" are:

ALWAYS	The attribute is always present with a value
EMPTY	The attribute is always present without any value (attribute sent zero length)
VNAP	The attribute is always present and its Value is Not Always Present (attribute sent zero length if no value is present)
ANAP	The attribute is present under specified condition – if present then it will always have a value
ANAPCV	The attribute is present under specified condition – if present then its Value is Not Always Present (attribute sent zero length if condition applies and no value is present)
ANAPEV	The attribute is present under specified condition – if present then it will not have any value

The abbreviations used in the Module table for the column "Source" are:

AUTO	The attribute value is generated automatically
CONFIG	The attribute value source is a configurable parameter
COPY	The attribute value source is another SOP instance
FIXED	The attribute value is hard-coded in the application
IMPLICIT	The attribute value source is a user-implicit setting
MPPS	The attribute value is the same as that use for Modality Performed Procedure Step
MWL	The attribute value source is a Modality Worklist
USER	The attribute value source is explicit user input

8.1.1.1. List of created SOP Classes

Table 76: List of created SOP Classes

SOP Class Name	SOP Class UID
Secondary Capture Image Storage SOP Class	1.2.840.10008.5.4.1.1.7
Multi-frame Grayscale Word SC Image Storage SOP Class	1.2.840.10008.5.1.4.1.1.7.3
Grayscale Softcopy Presentation State Storage SOP Class	1.2.840.10008.5.1.4.1.1.11.1
X-Ray Angiographic Image Storage SOP Class	1.2.840.10008.5.1.4.1.1.12.1
X-Ray Radiation Dose SR SOP Class	1.2.840.10008.5.1.4.1.1.88.67

8.1.1.2. Secondary Capture Image Storage SOP Class

Table 77: IOD of Created Secondary Capture Instances

Information Entity	Module	Presence Of Module
Patient	Patient Module	ALWAYS
	General Study Module	ALWAYS
Study	Patient Study Module	CONDITIONAL
	General Series Module	ALWAYS
Series	General Equipment Module	CONDITIONAL
	SC Equipment Module	ALWAYS
Image	General Image Module	ALWAYS
	Image Pixel Module	ALWAYS
	SC Image Module	CONDITIONAL
	VOI LUT Module	CONDITIONAL
	SOP Common Module	ALWAYS
Extended Dicom and Private Module	Extended Dicom and Private attributes	CONDITIONAL

Table 78: Patient Module

Attribute Name	Tag	VR	Value	Presence of Value	Source	Comment
Patient's Name	0010,0010	PN		EMPTY	AUTO, USER	
Patient ID	0010,0020	LO		ALWAYS	AUTO, USER	
Patient's Birth Date	0010,0030	DA	yyyymmdd	VNAP	USER	
Patient's Sex	0010,0040	CS		VNAP	USER	

Table 79: General Study Module

Attribute Name	Tag	VR	Value	Presence of Value	Source	Comment
Study Date	0008,0020	DA	yyyymmdd	ALWAYS	AUTO	
Study Time	0008,0030	TM		ALWAYS	AUTO	
Accession Number	0008,0050	SH	NULL	EMPTY	USER	
Referring Physician's Name	0008,0090	PN		VNAP	USER	
Study Instance UID	0020,000D	UI		ALWAYS	AUTO	
Study ID	0020,0010	SH		VNAP	USER	

Table 80: Patient Study Module

Attribute Name	Tag	VR	Value	Presence of Value	Source	Comment
Patient's Size	0010,1020	DS	In meters	VNAP	USER	

Patient's Age	0010,1010	AS		VNAP	USER	
Patient's Weight	0010,1030	DS	In kilograms	VNAP	USER	

Table 81: General Series Module

Attribute Name	Tag	VR	Value	Presence of Value	Source	Comment
Series Date	0008,0021	DA	yyyymmdd	ANAP	AUTO	
Series Time	0008,0031	TM		ANAP	AUTO	
Series Description	0008,103E	LO		ALWAYS	AUTO	
Series Instance UID	0020,000E	UI		ALWAYS	AUTO	
Series Number	0020,0011	IS		ALWAYS	AUTO	
Laterality	0020,0060	CS	NULL	ANAP	AUTO	
Performing Physician's Name	0008,1050	PN				
Operators' Name	0008,1070	PN				
Protocol Name	0018,1030	LO				
Performed Procedure Step Start Date	0040,0244	DA				
Performed Procedure Step Start Time	0040,0245	TM				
Performed Procedure Step ID	0040,0253	SH				
Performed Station AE Title	0040,0241	AE				

Table 82: General Equipment Module

Attribute Name	Tag	VR	Value	Presence of Value	Source	Comment
Manufacturer	0008,0070	LO	Philips Medical Systems	ANAP	AUTO	
Manufacturer's Model Name	0008,1090	LO	BV Vectra			

Table 83: SC Equipment Module

Attribute Name	Tag	VR	Value	Presence of Value	Source	Comment
Modality	0008,0060	CS	OT	ANAP	AUTO	
Conversion Type	0008,0064	CS	WSD	ALWAYS	AUTO	

Table 84: General Image Module

Attribute Name	Tag	VR	Value	Presence of Value	Source	Comment
Image Type	0008,0008	CS	Value 1: PRIMARY, Value 2: SECONDARY	ANAP	AUTO	
Acquisition Date	0008,0022	DA	NULL	ANAP	AUTO	
Content Date	0008,0023	DA	NULL	ANAP	AUTO	
Acquisition Time	0008,0032	DA		ANAP	AUTO	
Content Time	0008,0033	TM			AUTO	
Instance Number	0020,0013	IS		ALWAYS	AUTO	
Patient Orientation	0020,0020	CS	NULL	ANAP	AUTO	
Burned In Annotation	0028,0301	CS		ANAP		

Table 85: Image Pixel Module

Attribute Name	Tag	VR	Value	Presence of Value	Source	Comment
Samples per Pixel	0028,0002	US	1	ALWAYS	AUTO	

Photometric Interpretation	0028,0004	CS	MONOCHROME2	ALWAYS	AUTO	
Rows	0028,0010	US	512	ALWAYS	AUTO	
Columns	0028,0011	US	512	ALWAYS	AUTO	
Bits Allocated	0028,0100	US	8, 16	ALWAYS	AUTO	
Bits Stored	0028,0101	US	8, 16	ALWAYS	AUTO	
High Bit	0028,0102	US	7, 15	ALWAYS	AUTO	
Pixel Representation	0028,0103	US	0	ALWAYS	AUTO	
Pixel Data	7FE0,0010	OW/OB		ALWAYS	AUTO	

Table 86: SC Image Module

Attribute Name	Tag	VR	Value	Presence of Value	Source	Comment
Date of Secondary Capture	0018,1012	DA	yyyymmdd	ANAP	AUTO	
Time of Secondary Capture	0018,1014	TM	hhmmss.ssssss	ANAP	AUTO	

Table 87: VOI LUT Module

Attribute Name	Tag	VR	Value	Presence of Value	Source	Comment
Window Center	0028,1050	DS		ALWAYS	AUTO	
Window Width	0028,1051	DS		ALWAYS	AUTO	

Table 88: SOP Common Module

Attribute Name	Tag	VR	Value	Presence of Value	Source	Comment
Specific Character Set	0008,0005	CS	ISO_IR 100	ALWAYS	AUTO	
SOP Class UID	0008,0016	UI	1.2.840.10008.5.1.4.1.1.7	ALWAYS	AUTO	Secondary Capture Image
SOP Instance UID	0008,0018	UI		ALWAYS	AUTO	

8.1.1.3. Multi-frame Grayscale Word SC Image Storage SOP Class

Table 89: IOD of Created MF Secondary Capture Instances

Information Entity	Module	Presence Of Module
Patient	Patient Module	ALWAYS
Study	General Study Module	ALWAYS
	Patient Study Module	CONDITIONAL
Series	General Series Module	ALWAYS
Equipment	General Equipment Module	CONDITIONAL
	SC Equipment Module	ALWAYS
Image	General Image Module	ALWAYS
	Image Pixel Module	ALWAYS
	Cine Module	CONDITIONAL
	SC Image Module	CONDITIONAL
	SC Multi-frame Image Module	ALWAYS
	VOI LUT Module	CONDITIONAL
	SOP Common Module	ALWAYS
	Extended Dicom and Private attributes	CONDITIONAL

Table 90: Patient Module

Attribute Name	Tag	VR	Value	Presence of Value	Source	Comment
Patient's Name	0010,0010	PN		EMPTY	AUTO, USER	
Patient ID	0010,0020	LO		ALWAYS	AUTO, USER	
Patient's Birth Date	0010,0030	DA	yyyymmdd	VNAP	USER	
Patient's Sex	0010,0040	CS		VNAP	USER	
Patient Comments	0010,4000	LT		VNAP	USER	

Table 91: General Study Module

Attribute Name	Tag	VR	Value	Presence of Value	Source	Comment
Study Date	0008,0020	DA	yyyymmdd	ALWAYS	AUTO	
Study Time	0008,0030	TM		ALWAYS	AUTO	
Accession Number	0008,0050	SH	NULL	EMPTY	USER	
Referring Physician's Name	0008,0090	PN		VNAP	USER	
Study Description	0008,1030	LO		VNAP	USER	
Study Instance UID	0020,000D	UI		ALWAYS	AUTO	
Study ID	0020,0010	SH		VNAP	USER	

Table 92: Patient Study Module

Attribute Name	Tag	VR	Value	Presence of Value	Source	Comment
Patient's Size	0010,1020	DS	In meters	VNAP	USER	
Patient's Age	0010,1010	AS		VNAP	USER	
Patient's Weight	0010,1030	DS	In kilograms	VNAP	USER	

Table 93: General Series Module

Attribute Name	Tag	VR	Value	Presence of Value	Source	Comment
Series Date	0008,0021	DA	yyyymmdd	ANAP	AUTO	
Series Time	0008,0031	TM		ANAP	AUTO	
Series Description	0008,103E	LO		ALWAYS	AUTO	
Series Instance UID	0020,000E	UI		ALWAYS	AUTO	
Series Number	0020,0011	IS		ALWAYS	AUTO	
Laterality	0020,0060	CS	NULL	ANAP	AUTO	

Table 94: SC Equipment Module

Attribute Name	Tag	VR	Value	Presence of Value	Source	Comment
Modality	0008,0060	CS	OT	ANAP	AUTO	
Conversion Type	0008,0064	CS	WSD	ALWAYS	AUTO	
Secondary Capture Device ID	0018,1010	LO	NULL	ANAP	AUTO	
Secondary Capture Device Manufacturer	0018,1016	LO	NULL	ANAP	AUTO	
Secondary Capture Device Software Version(s)	0018,1019	LO		VNAP	AUTO	

Table 95: General Image Module

Attribute Name	Tag	VR	Value	Presence of Value	Source	Comment
Image Type	0008,0008	CS	Value 1: PRIMARY, Value 2: SECONDARY	ANAP	AUTO	
Acquisition Date	0008,0022	DA	NULL	ANAP	AUTO	
Acquisition Time	0008,0032	TM		ANAP		
Content Date	0008,0023	DA	NULL	ANAP	AUTO	

Instance Number	0020,0013	IS		ALWAYS	AUTO	
Patient Orientation	0020,0020	CS	NULL	ANAP	AUTO	
Burned In Annotation	0028,0301	CS		ANAP		
Presentation LUT Shape	2050,0020	CS		ANAP		

Table 96: Image Pixel Module

Attribute Name	Tag	VR	Value	Presence of Value	Source	Comment
Samples per Pixel	0028,0002	US	1	ALWAYS	AUTO	
Photometric Interpretation	0028,0004	CS	MONOCHROME2	ALWAYS	AUTO	
Rows	0028,0010	US	512	ALWAYS	AUTO	
Columns	0028,0011	US	512	ALWAYS	AUTO	
Bits Allocated	0028,0100	US	8, 16	ALWAYS	AUTO	
Bits Stored	0028,0101	US	8, 16	ALWAYS	AUTO	
High Bit	0028,0102	US	7, 15	ALWAYS	AUTO	
Pixel Representation	0028,0103	US	0	ALWAYS	AUTO	
Smallest Image Pixel Value	0028,0106	US/SS		ANAP	AUTO	
Largest Image Pixel Value	0028,0107	US/SS		ANAP	AUTO	
Pixel Data	7FE0,0010	OW/OB		ALWAYS	AUTO	

Table 97: SC Multi-frame Image Module

Attribute Name	Tag	VR	Value	Presence of Value	Source	Comment
Frame Increment Pointer	0028,0009	AT		ANAP		
Burned In Annotation	0028,0301	CS		ALWAYS		
Rescale Intercept	0028,1052	DS		ANAP		
Rescale Slope	0028,1053	DS		ANAP		
Rescale Type	0028,1054	LO		ANAP		
Presentation LUT Shape	2050,0020	CS		ANAP		

Table 98: Cine Module

Attribute Name	Tag	VR	Value	Presence of Value	Source	Comment
Frame Time	0018,1063	DS		ANAP		

Table 99: SC Image Module

Attribute Name	Tag	VR	Value	Presence of Value	Source	Comment
Date of Secondary Capture	0018,1012	DA	yyyymmdd	ANAP	AUTO	
Time of Secondary Capture	0018,1014	TM	hhmmss.ssssss	ANAP	AUTO	

Table 100: Multi-Frame Module

Attribute Name	Tag	VR	Value	Presence of Value	Source	Comment
Number of Frames	0028,0008	IS		ALWAYS		
Frame Increment Pointer	0028,0009	AT		ALWAYS		

Table 101: VOI LUT Module

Attribute Name	Tag	VR	Value	Presence of Value	Source	Comment
Window Center	0028,1050	DS		ANAP		
Window Width	0028,1051	DS		ANAP		

Table 102: SOP Common Module

Attribute Name	Tag	VR	Value	Presence of Value	Source	Comment
Specific Character Set	0008,0005	CS	ISO_IR 100	ALWAYS	AUTO	
SOP Class UID	0008,0016	UI	1.2.840.10008.5.1.4.1.1.7.3	ALWAYS	AUTO	Multi-frame Grayscale Word Secondary Capture Image
SOP Instance UID	0008,0018	UI		ALWAYS	AUTO	

Table 103: Additional Attributes Module

Attribute Name	Tag	VR	Value	Presence of Value	Source	Comment
Performed Station AE Title	0040,0241	AE		ALWAYS	AUTO	

8.1.1.4. Grayscale Softcopy Presentation State Storage SOP Class

Table 104: IOD of Created Grayscale Softcopy Presentation State Storage SOP Class Instances

Information Entity	Module	Presence Of Module
Patient	Patient Module	ALWAYS
Study	General Study Module	ALWAYS
	Patient Study Module	CONDITIONAL
Series	General Series Module	ALWAYS
	Presentation Series Module	ALWAYS
Equipment	General Equipment Module	ALWAYS
	Presentation State Identification Module	ALWAYS
Presentation State	Display Shutter Module	ALWAYS
	Bitmap Display Shutter Module	ALWAYS
	Presentation State Relationship Module	ALWAYS
	Displayed Area Module	ALWAYS
	Softcopy VOI LUT Module	CONDITIONAL
	Spatial Transformation Module	CONDITIONAL
	Softcopy Presentation LUT Module	ALWAYS
	SOP Common Module	ALWAYS
Extended Dicom and Private attributes	Extended Dicom and Private attributes	CONDITIONAL

Table 105: Patient Module

Attribute Name	Tag	VR	Value	Presence of Value	Source	Comment
Patient's Name	0010,0010	PN		EMPTY	AUTO, USER	
Patient ID	0010,0020	LO		ALWAYS	AUTO, USER	
Patient's Birth Date	0010,0030	DA	yyyymmdd	VNAP	USER	
Patient's Sex	0010,0040	CS		VNAP	USER	
Patient Comments	0010,4000	LT		VNAP	USER	

Table 106: General Study Module

Attribute Name	Tag	VR	Value	Presence of Value	Source	Comment
Study Date	0008,0020	DA	yyyymmdd	ALWAYS	AUTO	
Study Time	0008,0030	TM	hhmmss.ssssss	ALWAYS	AUTO	
Accession Number	0008,0050	SH	NULL	EMPTY	USER	
Referring Physician's Name	0008,0090	PN		VNAP	USER	
Study Description	0008,1030	LO		VNAP	USER	
Study Instance UID	0020,000D	UI		ALWAYS	AUTO	
Study ID	0020,0010	SH		VNAP	USER	

Table 107: Patient Study Module

Attribute Name	Tag	VR	Value	Presence of Value	Source	Comment
Patient's Size	0010,1020	DS	In meters	VNAP	USER	
Patient's Age	0010,1010	AS		VNAP	USER	
Patient's Weight	0010,1030	DS	In kilograms	VNAP	USER	

Table 108: General Series Module

Attribute Name	Tag	VR	Value	Presence of Value	Source	Comment
Modality	0008,0060	CS	"PR"	ALWAYS		Always PR
Series Description	0008,103E	LO		ANAP		
Protocol Name	0018,1030	LO		ANAP		
Series Instance UID	0020,000E	UI		ALWAYS		
Series Number	0020,0011	IS		VNAP		
Performed Procedure Step Start Date	0040,0244	DA		ANAP		
Laterality	0020,0060	CS		ANAPCV		
Performed Procedure Step Start Time	0040,0245	TM		ANAP		
Performed Procedure Step ID	0040,0253	SH		ANAP		

Table 109: General Equipment Module

Attribute Name	Tag	VR	Value	Presence of Value	Source	Comment
Manufacturer	0008,0070	LO		VNAP	FIXED	Philips Medical Systems
Manufacturer's Model Name	0008,1090	LO		ANAP	AUTO	BV Vectra

Table 110: Display Shutter Module

Attribute Name	Tag	VR	Value	Presence of Value	Source	Comment
Shutter Shape	0018,1600	CS		ALWAYS	AUTO	
Center of Circular Shutter	0018,1610	IS		ANAP	AUTO	
Radius of Circular Shutter	0018,1612	IS		ANAP	AUTO	

Table 111: Bitmap Display Shutter Module

Attribute Name	Tag	VR	Value	Presence of Value	Source	Comment
Shutter Shape	0018,1600	CS		ALWAYS	AUTO	

Table 112: Spatial Transformation Module

Attribute Name	Tag	VR	Value	Presence of Value	Source	Comment
Image Horizontal Flip	0070,0041	CS		ALWAYS	AUTO	
Image Rotation	0070,0042	US		ALWAYS	AUTO	

Table 113: Presentation Series Module

Attribute Name	Tag	VR	Value	Presence of Value	Source	Comment
Modality	0008,0060	CS	PR	ALWAYS	AUTO	Always "PR"

Table 114: Presentation State Identification Module

Attribute Name	Tag	VR	Value	Presence of Value	Source	Comment
Presentation Creation Date	0070,0082	DA		ALWAYS	AUTO	Set to the date at which this presentation state is created
Presentation Creation Time	0070,0083	TM		ALWAYS	AUTO	Set to the time at which this presentation state is created
Instance Number	0020,0013	IS		ALWAYS	AUTO	
Content Label	0070,0080	CS		ALWAYS	AUTO	
Content Description	0070,0081	LO		EMPTY	AUTO	
Content Creator's Name	0070,0084	PN		EMPTY	AUTO	

Table 115: Presentation State Relationship Module

Attribute Name	Tag	VR	Value	Presence of Value	Source	Comment
Referenced Series Sequence	0008,1115	SQ		ALWAYS	AUTO	
>Referenced Image Sequence	0008,1140	SQ		ALWAYS	AUTO	These references are constructed from the composite images that are sent in the same association or belong to the same Series.
>>Referenced Frame Number	0008,1160	IS		ALWAYS	AUTO	Frame numbers of all frames in Referenced Image sequence.
>>Referenced SOP Class UID	0008,1150	UI		ALWAYS	AUTO	
>>Referenced SOP Instance UID	0008,1155	UI		ALWAYS	AUTO	
>Series Instance UID	0020,000E	UI		ALWAYS	AUTO	Series Instance UID of the original image.

Table 116: Displayed Area Module

Attribute Name	Tag	VR	Value	Presence of Value	Source	Comment
Displayed Area Selection Sequence	0070,005A	SQ		ALWAYS	IMPLICIT	
>Displayed Area Top Left Hand Corner	0070,0052	SL		ALWAYS	IMPLICIT	
>Displayed Area Bottom Right Hand Corner	0070,0053	SL		ALWAYS	IMPLICIT	
>Presentation Size Mode	0070,0100	CS		ALWAYS	IMPLICIT	
>Presentation Pixel Spacing	0070,0101	DS		ALWAYS	IMPLICIT	

Table 117: Softcopy VOI LUT Module

Attribute Name	Tag	VR	Value	Presence of Value	Source	Comment
Softcopy VOI LUT Sequence	0028,3110	SQ		ALWAYS	AUTO	
>Window Center	0028,1050	DS		ALWAYS	AUTO	
>Window Width	0028,1051	DS		ALWAYS	AUTO	

Table 118: Softcopy Presentation LUT Module

Attribute Name	Tag	VR	Value	Presence of Value	Source	Comment
Presentation LUT Shape	2050,0020	CS		ANAP	AUTO	

Table 119: Spatial Transformation Module

Attribute Name	Tag	VR	Value	Presence of Value	Source	Comment
Image Horizontal Flip	0070,0041	CS		ALWAYS	Image Horizontal Flip	
Image Rotation	0070,0042	US		ALWAYS	Image Rotation	

Table 120: SOP Common Module

Attribute Name	Tag	VR	Value	Presence of Value	Source	Comment
SOP Class UID	0008,0016	UI	1.2.840.10008.5.1.4.1.1.11.1	ALWAYS	AUTO	
SOP Instance UID	0008,0018	UI		ALWAYS	AUTO	
Instance Number	0020,0013	IS		VNAP		

8.1.1.5. X-Ray Angiographic Image Storage SOP Class

Table 121: IOD of Created X-Ray Angiographic Image Storage SOP Class Instances

Information Entity	Module	Presence Of Module
Patient	Patient Module	ALWAYS
Study	General Study Module	ALWAYS
	Patient Study Module	CONDITIONAL
Series	General Series Module	ALWAYS
Equipment	General Equipment Module	ALWAYS
Image	General Image Module	ALWAYS
	Image Pixel Module	ALWAYS
	Cine Module	CONDITIONAL
	Multi-Frame Module	CONDITIONAL
	Display Shutter Module	CONDITIONAL
	X-Ray Image Module	ALWAYS
	X-Ray Acquisition Module	ALWAYS
	XA Positioner Module	ALWAYS
	Modality LUT Module	CONDITIONAL
	VOI LUT Module	CONDITIONAL
	SOP Common Module	ALWAYS
Extended Dicom and Private attributes	CONDITIONAL	

Table 122: Patient Module

Attribute Name	Tag	VR	Value	Presence of Value	Source	Comment
Patient's Name	0010,0010	PN		EMPTY	AUTO, USER	
Patient ID	0010,0020	LO		ALWAYS	AUTO, USER	
Patient's Birth Date	0010,0030	DA	yyyyMMdd	VNAP	USER	
Patient's Sex	0010,0040	CS		VNAP	USER	
Patient Comments	0010,4000	LT		VNAP	USER	

Table 123: General Study Module

Attribute Name	Tag	VR	Value	Presence of Value	Source	Comment
Study Date	0008,0020	DA	yyyymmdd	ALWAYS	AUTO	
Study Time	0008,0030	TM		ALWAYS	AUTO	
Accession Number	0008,0050	SH	NULL	EMPTY	USER	
Referring Physician's Name	0008,0090	PN		VNAP	USER	
Study Description	0008,1030	LO		VNAP	USER	
Study Instance UID	0020,000D	UI		ALWAYS	AUTO	
Study ID	0020,0010	SH		VNAP	USER	

Table 124: Patient Study Module

Attribute Name	Tag	VR	Value	Presence of Value	Source	Comment
Patient's Size	0010,1020	DS	In meters	VNAP	USER	
Patient's Age	0010,1010	AS		VNAP	USER	
Patient's Weight	0010,1030	DS	In kilograms	VNAP	USER	

Table 125: General Series Module

Attribute Name	Tag	VR	Value	Presence of Value	Source	Comment
Modality	0008,0060	CS	XA	ALWAYS	AUTO	
Series Description	0008,103E	LO		ALWAYS	AUTO	Contains Procedure name or Application Name and Fluoro Type
Series Instance UID	0020,000E	UI		ALWAYS	AUTO	
Series Number	0020,0011	IS		ALWAYS	AUTO	
Laterality	0020,0060	CS		EMPTY	AUTO	
Performing Physicians' Name	0008,1050	PN		ANAP		
Operators' Name	0008,1070	PN		ANAP		
Protocol Name	0018,1030	LO		ANAP		
Performed Procedure Step Start Date	0040,0244	DA		ANAP		
Performed Procedure Step Start Time	0040,0245	TM		ANAP		
Performed Procedure Step ID	0040,0253	SH		ANAP		

Table 126: General Equipment Module

Attribute Name	Tag	VR	Value	Presence of Value	Source	Comment
Manufacturer	0008,0070	LO	Philips Medical Systems	ALWAYS	AUTO	
Manufacturer's Model Name	0008,1090	LO	BV Vectra	ALWAYS	AUTO	

Table 127: General Image Module

Attribute Name	Tag	VR	Value	Presence of Value	Source	Comment
Image Type	0008,0008	CS		ANAP		ORIGINAL\ PRIMARY\ SINGLE PLANE
Acquisition Date	0008,0022	DA	yyyymmdd	ALWAYS	AUTO	
Content Date	0008,0023	DA	yyyymmdd	ALWAYS	AUTO	
Acquisition Time	0008,0032	TM	hhmmss.ssssss	ALWAYS	AUTO	
Content Time	0008,0033	TM	hhmmss	ALWAYS	AUTO	

Derivation Description	0008,2111	ST		ANAP	AUTO	If image is subtracted
Instance Number	0020,0013	IS	1	ALWAYS	AUTO	
Patient Orientation	0020,0020	CS		EMPTY	AUTO	

Table 128: Image Pixel Module

Attribute Name	Tag	VR	Value	Presence of Value	Source	Comment
Rows	0028,0010	US	512/1024	ALWAYS	AUTO	
Columns	0028,0011	US	512/1024	ALWAYS	AUTO	
Pixel Data	7FE0,0010	OW/OB		ALWAYS	AUTO	

Table 129: Cine Module

Attribute Name	Tag	VR	Value	Presence of Value	Source	Comment
Cine Rate	0018,0040	IS		ANAP	AUTO	Set to acquisition frame speed
Frame Time	0018,1063	DS	ms	ALWAYS	AUTO	

Table 130: Multi-Frame Module

Attribute Name	Tag	VR	Value	Presence of Value	Source	Comment
Number of Frames	0028,0008	IS		ALWAYS	AUTO	

Table 131: Display Shutter Module

Attribute Name	Tag	VR	Value	Presence of Value	Source	Comment
Shutter Shape	0018,1600	CS	Value 1: CIRCULAR	ALWAYS	AUTO	
Center of Circular Shutter	0018,1610	IS		ALWAYS	AUTO	
Radius of Circular Shutter	0018,1612	IS		ALWAYS	AUTO	

Table 132: X-Ray Image Module

Attribute Name	Tag	VR	Value	Presence of Value	Source	Comment
Image Type	0008,0008	CS	Value 1: DERIVED/ORIGINAL, Value 2: PRIMARY, Value 3: SINGLE PLANE	ALWAYS	AUTO	
Samples per Pixel	0028,0002	US	1	ALWAYS	AUTO	
Photometric Interpretation	0028,0004	CS	MONOCHROME2	ALWAYS	AUTO	
Frame Increment Pointer	0028,0009	AT	0x00181063	ALWAYS	AUTO	Based on frame speed
Bits Allocated	0028,0100	US	16	ALWAYS	AUTO	
Bits Stored	0028,0101	US	12	ALWAYS	AUTO	
High Bit	0028,0102	US	11	ALWAYS	AUTO	
Pixel Representation	0028,0103	US	0	ALWAYS	AUTO	
Pixel Intensity Relationship	0028,1040	CS	DISP, LIN	ALWAYS	AUTO	

Table 133: X-Ray Acquisition Module

Attribute Name	Tag	VR	Value	Presence of Value	Source	Comment
KVP	0018,0060	DS		ALWAYS	AUTO	
X-ray Tube Current	0018,1151	IS		EMPTY	AUTO	
Exposure	0018,1152	IS		EMPTY	AUTO	

Radiation Setting	0018,1155	CS	GR, SC	ALWAYS	AUTO	
Pixel Spacing	0028,0030	DS				

Table 134: XA Positioner Module

Attribute Name	Tag	VR	Value	Presence of Value	Source	Comment
Positioner Primary Angle	0018,1510	DS		EMPTY	AUTO	
Positioner Secondary Angle	0018,1511	DS		EMPTY	AUTO	

Table 135: Modality LUT Module

Attribute Name	Tag	VR	Value	Presence of Value	Source	Comment
Modality LUT Sequence	0028,3000	SQ		ANAP	AUTO	
>LUT Descriptor	0028,3002	US/SS	Value 1: 4096, Value 2: 0, Value 3: 12	ANAP	AUTO	Always 12 bits stored
>Modality LUT Type	0028,3004	LO	US	ANAP	AUTO	
>LUT Data	0028,3006	US/OW		ANAP	AUTO	

Table 136: VOI LUT Module

Attribute Name	Tag	VR	Value	Presence of Value	Source	Comment
Window Center	0028,1050	DS		ALWAYS	AUTO	
Window Width	0028,1051	DS		ALWAYS	AUTO	

Table 137: SOP Common Module

Attribute Name	Tag	VR	Value	Presence of Value	Source	Comment
Specific Character Set	0008,0005	CS	ISO_IR 100	ALWAYS	AUTO	
SOP Class UID	0008,0016	UI	1.2.840.10008.5.1.4.1.1.12.1	ALWAYS	AUTO	
SOP Instance UID	0008,0018	UI		ALWAYS	AUTO	

Table 138: General Equipment Module

Attribute Name	Tag	VR	Value	Presence of Value	Source	Comment
Manufacturer	0008,0070	LO		VNAP	FIXED	Philips Medical Systems
Manufacturer's Model Name	0008,1090	LO		ANAP	AUTO	BV Vectra

Table 139: Display Shutter Module

Attribute Name	Tag	VR	Value	Presence of Value	Source	Comment
Shutter Shape	0018,1600	CS		ALWAYS		
Center of Circular Shutter	0018,1610	IS		ANAP		
Radius of Circular Shutter	0018,1612	IS		ANAP		

Table 140: Spatial Transformation Module

Attribute Name	Tag	VR	Value	Presence of Value	Source	Comment
Image Horizontal Flip	0070,0041	CS		ALWAYS		
Image Rotation	0070,0042	US		ALWAYS		

Table 141: DX Detector Module

Attribute Name	Tag	VR	Value	Presence of Value	Source	Comment
Pixel Spacing	0028,0030	DS		ALWAYS		

Table 142: Extended Dicom and Private attributes Module

Attribute Name	Tag	VR	Value	Presence of Value	Source	Comment
Medical Alerts	0010,2000	LO				
Allergies	0010,2110	LO				
Performed Station AE Title	0040,0241	AE				
:Philips Private	2001,0010	LO				

8.1.1.6. X-Ray Radiation Dose SR SOP Class

Table 143: IOD of Created X-Ray Radiation Dose SR SOP Class Instances

Information Entity	Module	Presence Of Module
Patient	Patient Module	ALWAYS
Study	General Study Module	ALWAYS
	Patient Study Module	ALWAYS
Series	SR Document Series Module	ALWAYS
Equipment	General Equipment Module	ALWAYS
	Enhanced General Equipment	ALWAYS
Document	SR Document General Module	ALWAYS
	SR Document Content	ALWAYS
	SOP Common Module	ALWAYS

Table 144: Patient Module

Attribute Name	Tag	VR	Value	Presence of Value	Source	Comment
Referenced Patient Sequence	0008,1120	SQ		ANAP	AUTO	
Patient's Name	0010,0010	PN		VNAP	USER	
Patient ID	0010,0020	LO		VNAP	USER	
Patient's Sex	0010,0040	CS		VNAP	USER	
Patient's Birth Date	0010,0030	DA		VNAP	USER	

Table 145: General Study Module

Attribute Name	Tag	VR	Value	Presence of Value	Source	Comment
Study Date	0008,0020	DA		VNAP	AUTO	
Study Time	0008,0030	TM		VNAP	AUTO	
Accession Number	0008,0050	SH		EMPTY	USER	
Referring Physician's Name	0008,0090	PN		VNAP	USER	
Referring Physician Identification Sequence	0008,0096	SQ		VNAP	USER	
>Person Identification Code Sequence	0040,1101	SQ		VNAP	USER	
>>Code Value	0008,0100	SH		ALWAYS	USER	
>>Coding Scheme Designator	0008,0102	SH		ALWAYS	USER	
>>Code Meaning	0008,0104	LO		ALWAYS	USER	
Study Description	0008,1030	LO		ANAPCV	USER	
Referenced Study Sequence	0008,1110	SQ		ANAPCV	AUTO	
Study Instance UID	0020,000D	UI		ALWAYS	AUTO	
Study ID	0020,0010	SH		VNAP	AUTO	

Table 146: SR Document Series Module

Attribute Name	Tag	VR	Value	Presence of Value	Source	Comment
Series Date	0008,0021	DA		ANAPCV	AUTO	
Series Time	0008,0031	TM		ANAPCV	AUTO	
Modality	0008,0060	CS		ALWAYS	AUTO	
Series Description	0008,103E	LO		ANAPCV	AUTO	
Referenced Performed Procedure Step Sequence	0008,1111	LO		ANAPCV		
Series Instance UID	0020,000E	UI		ALWAYS	AUTO	
Series Number	0020,0011	IS		ALWAYS	AUTO	

Table 147: General Equipment Module

Attribute Name	Tag	VR	Value	Presence of Value	Source	Comment
Manufacturer	0008,0070	LO		VNAP	AUTO	
Institution Name	0008,0080	LO		ANAPCV		
Station Name	0008,1010	SH		ANAPCV		
Manufacturer's Model Name	0008,1090	LO		ANAPCV	AUTO	
Device Serial Number	0018,1000	LO		ANAPCV	AUTO	
Software Version(s)	0018,1020	LO		ANAPCV	AUTO	

Table 148: SR Document General Module

Attribute Name	Tag	VR	Value	Presence of Value	Source	Comment
Content Date	0008,0023	DA		ALWAYS	AUTO	
Content Time	0008,0033	TM		ALWAYS	AUTO	
Instance Number	0020,0013	IS		ALWAYS	AUTO	
Completion Flag	0040,A491	CS		ALWAYS	AUTO	
Completion Flag Description	0040,A492	LO		ANAPCV	AUTO	
Verification Flag	0040,A493	CS		ALWAYS	AUTO	

Table 149: SR Document Content Module

Attribute Name	Tag	VR	Value	Presence of Value	Source	Comment
Value Type	0040,A040	CS		ANAPCV		
Concept Name Code Sequence	0040,A043	SQ		ANAP	AUTO	
Code Value	0008,0100	SH		ANAP	AUTO	
Coding Scheme Designator	0008,0102	SH		ANAP	AUTO	
Code Meaning	0008,0104	LO		ANAP	AUTO	
Content Sequence	0040,A730	SQ		ANAP	AUTO	

Table 150: Patient Study Module

Attribute Name	Tag	VR	Value	Presence of Value	Source	Comment
Patient's Size	0010,1020	DS	In meters	VNAP	USER	
Patient's Age	0010,1010	AS		VNAP	USER	
Patient's Weight	0010,1030	DS	In kilograms	VNAP	USER	

Table 151: SOP Common Module

Attribute Name	Tag	VR	Value	Presence of Value	Source	Comment
Specific Character Set	0008,0005	CS	ISO_IR 100	ANAP	AUTO	ISO_IR 100
SOP Class UID	0008,0016	UI		ALWAYS		
SOP Instance UID	0008,0018	UI		ALWAYS		
Instance Number	0020,0013	IS		ANAP		

8.1.2. Usage of Attributes from Received IOD

BV Vectra only accepts all valid DICOM IODs specified in this document. Some SOP Classes will not be viewable because they are application dependent.

8.1.3. Attribute Mapping

Not applicable.

8.1.4. Coerced/Modified fields

Not applicable.

8.2. Data Dictionary of Private Attributes

Not applicable.

8.3. Coded Terminology and Templates

BV Vectra does not implement any specific support for coded terminology and templates.

8.3.1. Context Groups

Not applicable.

8.3.2. Template Specifications

X-RAY RADIATION DOSE SR IOD TEMPLATES

The templates that comprise the X-Ray Radiation Dose SR are interconnected as indicated in the figure below:

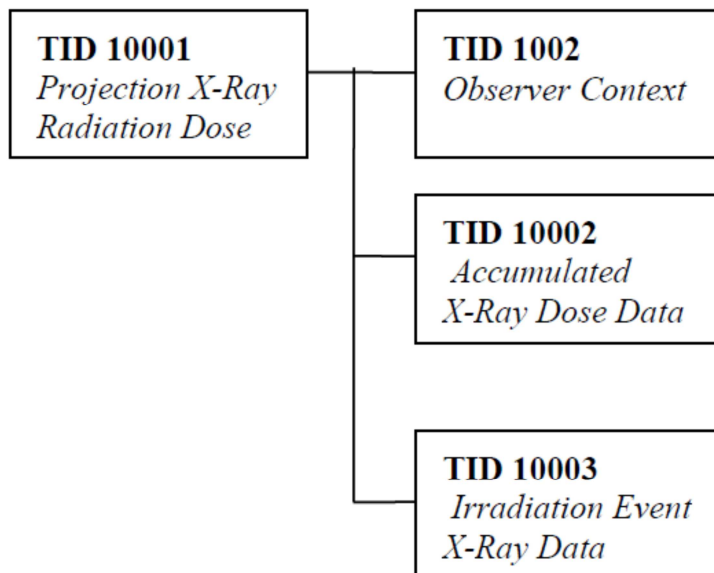

Figure 15: X-Ray Radiation Dose SR IOD Template Structure

This section describes the content of all the templates used in the X-Ray Radiation Dose Reporting SR.

Table 152: Used Templates for X-Ray Radiation Dose Reporting

Template Name	Template ID
Accumulated X-Ray Dose	TID 10002
Irradiation Event X-Ray Data	TID 10003
Accumulated Projection X-Ray Dose	TID 10004
Observer Context	TID 1002
Device Observer Identifying Attributes	TID 1004

8.3.2.1.1. TID 10001 Projection X-Ray Radiation Dose

Table 153: Projection X-Ray Radiation Dose

NL	Relation with Parent	Concept Name	VT	VM	Presence of Value	Value
		X-Ray Radiation Dose Report		1	ALWAYS	
>	HAS CONCEPT MOD	Procedure reported	CODE	1	ALWAYS	Projection X-Ray
>>	HAS CONCEPT MOD	Has Intent	CODE	1	ALWAYS	Combined Diagnostic and Therapeutic Procedure
>	HAS OBS CONTEXT	Device Observer Model Name (DCM, 121015)	TEXT	1	ALWAYS	
>	HAS OBS CONTEXT	Device Observer Serial Number (DCM, 121016)	TEXT	1	ALWAYS	
>	HAS OBS CONTEXT	Scope of Accumulation	CODE	1	ALWAYS	Performed Procedure Step
>	CONTAINS	DTID (10002) Accumulated X-Ray Dose	INCLUDE	1	ALWAYS	

>	CONTAINS	DTID (10003) Irradiation Event X-Ray Data	INCLUDE	1-n	ALWAYS	
>	CONTAINS	Source of Dose Information(DCM, 113854)	CODE	1	ALWAYS	Dosimeter (SRT, A-2C090)
>	CONTAINS	Comment(DCM, 121106)	TEXT	1	ALWAYS	

8.3.2.1.2. TID 10002 Accumulated X-Ray Dose

NL	Relation with Parent	Concept Name	VT	VM	Presence of Value	Value
>	CONTAINS, CONTINUOUS	Accumulated X-Ray Dose Data	CONTAINER	1	ALWAYS	
>>	HAS CONCEPT MOD	Acquisition Plane	CODE	1	ALWAYS	Single Plane
>>	CONTAINS	Reference Point Definition	CODE	1	ALWAYS	DCID (10025) Radiation Dose Reference Points
>>	CONTAINS	Dose Area Product Total	NUM	1	ALWAYS	Gy.m2 (UCUM, Gy.m2)
>>	CONTAINS	Dose (RP) Total	NUM	1	ALWAYS	Gy (UCUM, Gy)
>>	CONTAINS	Acquisition Dose Area Product Total	NUM	1	ALWAYS	Gy.m2 (UCUM, Gy.m2)
>>	CONTAINS	Acquisition Dose (RP) Total	NUM	1	ALWAYS	Gy (UCUM, Gy)
>>	CONTAINS	Fluoro Dose Area Product Total	NUM	1	CONDITIONAL	(Gym2, UCUM, "Gym2")
>>	CONTAINS	Fluoro Dose (RP) Total	NUM	1	CONDITIONAL	(Gy, UCUM, "Gy")
>>	CONTAINS	Total Fluoro Time	NUM	1	CONDITIONAL	(s, UCUM, "s")
>>	CONTAINS	Total Acquisition Time	NUM	1	ALWAYS	s (UCUM, s)
>>	CONTAINS	Total Number of Radiographic Frames	NUM	1	ALWAYS	no units (UCUM, 1)
>>	CONTAINS	Height of System	NUM		ALWAYS	mm (UCUM, mm)
>>	CONATINS	Focal Spot to ISO Center	NUM		ALWAYS	cm (UCUM, cm)

8.3.2.1.3. TID 10003 Irradiation Event X-Ray Data

Table 154: Irradiation Event X-Ray Data

NL	Relation with Parent	Concept Name	VT	VM	Presence of Value	Value
>	CONTAINS, CONTINUOUS	Irradiation Event X-Ray Data	CONTAINER	1	ALWAYS	
>>	HAS CONCEPT MOD	Acquisition Plane	CODE	1	ALWAYS	Single Plane
>>	CONTAINS	DateTime Started	DATETIME	1	ALWAYS	
>>	CONTAINS	Irradiation Event Type	CODE	1	ALWAYS	Fluoroscopy, Stationary Acquisition
>>	CONTAINS	Dose Area Product Total	NUM	1	ALWAYS	Gy.m2 (UCUM, Gy.m2)
>>	CONTAINS	Reference Point Definition	CODE	1	ALWAYS	15cm below Beam Isocenter
>>	CONTAINS	Irradiation Event UID	UIDREF	1	ALWAYS	
>>	CONTAINS	Dose Area Product	NUM	1	ALWAYS	Dose area product (Gy.m2)
>>	CONTAINS	Dose (RP)	NUM	1	ALWAYS	Gy
>>	CONTAINS	KVP	NUM	1-n	ALWAYS	kV
>>	CONTAINS	X-Ray Tube Current	NUM	1-n	ALWAYS	mA
>>	CONTAINS	Exposure	NUM	1-n	ALWAYS	uAs
>>	CONTAINS	Irradiation Duration	NUM	1	ALWAYS	Seconds
>>	CONTAINS	Target Region	CODE	1	ALWAYS	Head, neck, chest, abdomen, heart, extremity, pelvis, lower extremities.
>	CONTAINS	DCID (10008) Dose Related Distance Measurements	INCLUDE	2	ALWAYS	Distance source to detector (99.5)
>	CONTAINS	X-Ray Filters	CONTAINER	1-n	ALWAYS	
>>>	CONTAINS	X-Ray Filter Type	CODE	1	ALWAYS	
>>>	CONTAINS	X-Ray Filter Material	CODE	1	ALWAYS	
>>>	CONTAINS	X-Ray Filter Thickness Minimum	NUM	1	ALWAYS	
>>>	CONTAINS	X-Ray Filter Thickness Maximum	NUM	1	ALWAYS	
>	CONTAINS	Comment	TEXT	1	ALWAYS	X-Ray Radiation Dose Structured Report related to the Performed Procedure Step
>	CONTAINS	Source of Dose Information	CODE	1	ALWAYS	Dosimeter
>>	CONTAINS	Positioner Primary Angle	NUM	1	ALWAYS	° (UCUM, deg)
>>	CONTAINS	Positioner Secondary Angle	NUM	1	ALWAYS	° (UCUM, deg)
>>	CONTAINS	Pulse Width	NUM	1-n	CONDITIONAL	ms (UCUM, ms)
>>	CONTAINS	Patient Table Relationship	CODE	1	ALWAYS	headfirst (SRT, F-10470)

>>	CONTAINS	Patient Orientation	CODE	1	ALWAYS	recumbent (SRT, F-10450)
>>>	HAS CONCEPT MOD	Patient Orientation Modifier	CODE	1	ALWAYS	supine (SRT, F-10340)
>>	CONTAINS	Table Longitudinal Position	NUM	1	ALWAYS	
>>	CONTAINS	Table Lateral Position	NUM	1	ALWAYS	
>>	CONTAINS	Table Height Position	NUM	1	ALWAYS	
>>	CONTAINS	Table Head Tilt Angle	NUM	1	ALWAYS	
>>	CONTAINS	Table Horizontal Rotation Angle	NUM	1	ALWAYS	
>>	CONTAINS	Table Cradle Tilt Angle	NUM	1	ALWAYS	
>>	CONTAINS	Number of Frames	NUM	1	ALWAYS	no units (UCUM, 1)
>>	CONTAINS	Wedges and Shutters	CONTAINER	1	ALWAYS	
>>	CONTAINS	Beam Position	CONTAINER	1	ALWAYS	
>>	CONTAINS	Acquired Image	IMAGE	1-n	CONDITIONAL	
>>	CONTAINS	Pulse Rate	NUM	1	CONDITIONAL	
>>	CONTAINS	Number of pulses	NUM	1	CONDITIONAL	
>>	HAS CONCEPT MOD	Derivation	CODE	1	CONDITIONAL	Estimated

8.3.2.1.4. TID 1002 Observer Context

Table 155: Observer Context

NL	Relation with Parent	Concept Name	VT	VM	Presence of Value	Value
>	HAS OBS CONTEXT	Observer Type	CODE	1	CONDITIONAL	Device

8.3.2.1.5. TID 1004 Device Observer Identifying Attributes

Table 156: Device Observer Identifying Attributes

NL	Relation with Parent	Concept Name	VT	VM	Presence of Value	Value
>	HAS OBS CONTEXT	Device Observer UID	UIDREF	1	ALWAYS	

8.3.3. Private code definitions

Not applicable.

8.4. Grayscale Image consistency

BV Vectra does not implement any specific support for grayscale image consistency.

8.5. Standard Extended/Specialized/Private SOPs

BV Vectra does not support specialized SOP classes.

Table 157: List of created SOP Classes

SOP Class Name	SOP Class UID
Secondary Capture Image Storage SOP Class	1.2.840.10008.5.1.4.1.1.7
Multi-frame Grayscale Word SC Image Storage SOP Class	1.2.840.10008.5.1.4.1.1.7.3
Grayscale Softcopy Presentation State Storage SOP Class	1.2.840.10008.5.1.4.1.1.11.1
X-Ray Angiographic Image Storage SOP Class	1.2.840.10008.5.1.4.1.1.12.1

8.5.1. Standard Extended/Specialized/Private SOP Instance

8.5.1.1. Multi-frame Grayscale Word SC Image Storage SOP Class

Table 158: Extended DICOM and private attributes for Multi-frame Grayscale Word SC Image Storage SOP Class Instances

Attribute Name	Tag	VR	Value	Presence of Value	Source	Comment
Patient's Address	0010,1040	LO		ANAP	USER	
Medical Alerts	0010,2000	LO		ALWAYS	AUTO, USER	
Allergies	0010,2110	LO		ALWAYS	AUTO, USER	
Patient's Telephone Numbers	0010,2154	SH		ANAP	USER	
Pixel Intensity Relationship	0028,1040	CS	LIN	ANAP	AUTO	
Requesting Service	0032,1033	LO		ANAP	USER	
Performed Station AE Title	0040,0241	AE		ANAP	AUTO	

8.5.1.2. Secondary Capture Image Storage SOP Class

Table 159: Extended DICOM and private attributes for Secondary Capture Image Storage SOP Class Instances

Attribute Name	Tag	VR	Value	Presence of Value	Source	Comment
Patient's Address	0010,1040	LO		ANAP	USER	
Medical Alerts	0010,2000	LO		ALWAYS	AUTO, USER	
Allergies	0010,2110	LO		ALWAYS	AUTO, USER	
Patient's Telephone Numbers	0010,2154	SH		ANAP	USER	
Pixel Intensity Relationship	0028,1040	CS	LIN	ANAP	AUTO	QA only
Requesting Service	0032,1033	LO		ANAP	USER	
Performed Station AE Title	0040,0241	AE		ANAP	AUTO	

8.5.1.3. Grayscale Softcopy Presentation State Storage SOP Class

Table 160: Extended DICOM and private attributes for Grayscale Softcopy Presentation State Storage SOP Class Instances

Attribute Name	Tag	VR	Value	Presence of Value	Source	Comment
Patient's Address	0010,1040	LO		ANAP	USER	
Medical Alerts	0010,2000	LO		ALWAYS	AUTO, USER	
Allergies	0010,2110	LO		ALWAYS	AUTO, USER	
Patient's Telephone Numbers	0010,2154	SH		ANAP	USER	
Requesting Service	0032,1033	LO		ANAP	USER	

8.5.1.4. X-Ray Angiographic Image Storage SOP Class

Table 161: Extended DICOM and private attributes for X-Ray Angiographic Image Storage SOP Class Instances

Attribute Name	Tag	VR	Value	Presence of Value	Source	Comment
Patient's Address	0010,1040	LO		ANAP	USER	

Medical Alerts	0010,2000	LO		ALWAYS	AUTO, USER	
Allergies	0010,2110	LO		ALWAYS	AUTO, USER	
Patient's Telephone Numbers	0010,2154	SH		ANAP	USER	
Requesting Service	0032,1033	LO		ANAP	USER	
Performed Station AE Title	0040,0241	AE		ANAP	AUTO	

8.6. Private Transfer Syntaxes

BV Vectra does not support any private transfer syntaxes.