DICOM

Conformance Statement

Brilliance™ Workspace V2



Issued by:

Philips Medical Systems Nederland B.V.
Medical IT, Interoperability

Building QV-282
P.O. Box 10.000
5680 DA Best
The Netherlands

email: <mailto:dicom@philips.com>

Internet: <http://www.medical.philips.com/>

Document Number: 455019001041

Document Revision:2.05

Date: 11 Nov 2009

1 DICOM CONFORMANCE STATEMENT OVERVIEW

This conformance statement refers to the Brilliance™ Workspace, Philips' CT user environment for scanning and visualization. All Brilliance Workspace users enjoy the same easy to use interface and access to advanced CT applications. This DICOM conformance statement applies to Brilliance Workspace running on Brilliance™ CT scanners and Extended Brilliance Workspace (EBW) workstation.

This version of DICOM Conformance Statement (Doc. Revision 2.05) applies to the following products:

- Brilliance CT Scanners (Brilliance-6, Brilliance-10, Brilliance-16, Brilliance-16P, Brilliance-40, Brilliance-64, Big Bore, iCT), versions 2.x and 3.x
- Extended Brilliance Workspace workstation (EBW) versions 2.x
- Mx8000 IDT CT Scanner versions 4.x

The following table contains the Supported Networking DICOM Service (SOP) Classes:

Table 1: Network Services

SOP Class		User of Service (SCU)	Provider of Service (SCP)
Name	UID		
Transfer			
Computed Radiography Image Storage	1.2.840.10008.5.1.4.1.1.1	Yes	Yes
Digital X-Ray Image Storage – for Presentation	1.2.840.10008.5.1.4.1.1.1.1	Yes	Yes
Digital X-Ray Image Storage – for Processing	1.2.840.10008.5.1.4.1.1.1.1.1	Yes	Yes
CT Image Storage	1.2.840.10008.5.1.4.1.1.2	Yes	Yes
MR Image Storage	1.2.840.10008.5.1.4.1.1.4	Yes	Yes
Secondary Capture Image Storage	1.2.840.10008.5.1.4.1.1.7	Yes	Yes
General ECG Waveform Storage	1.2.840.10008.5.1.4.1.1.9.1.2	Yes	Yes
Grayscale Softcopy Presentation State Storage	1.2.840.10008.5.1.4.1.1.11.1	Yes	Yes
X-Ray Angiographic Image Storage	1.2.840.10008.5.1.4.1.1.12.1	Yes	Yes
X-Ray Radiofluoroscopic Image Storage	1.2.840.10008.5.1.4.1.1.12.2	Yes	Yes
Nuclear Medicine Image Storage	1.2.840.10008.5.1.4.1.1.20	Yes	Yes
Positron Emission Tomography Image Storage	1.2.840.10008.5.1.4.1.1.128	Yes	Yes
RT Image Storage	1.2.840.10008.5.1.4.1.1.481.1	Yes	Yes
RT Structure Set Storage	1.2.840.10008.5.1.4.1.1.481.3	Yes	Yes
RT Plan Storage	1.2.840.10008.5.1.4.1.1.481.5	Yes	Yes
Query/Retrieve			
Study Root Query/Retrieve Information Model – FIND	1.2.840.10008.5.1.4.1.2.2.1	Yes	Yes
Study Root Query/Retrieve Information Model – MOVE	1.2.840.10008.5.1.4.1.2.2.2	Yes	Yes
Workflow Management (Scanner Only)			
Modality Performed Procedure Step	1.2.840.10008.3.1.2.3.3	Yes	No
Modality Worklist Information Model – FIND	1.2.840.10008.5.1.4.31	Yes	No

SOP Class		User of Service (SCU)	Provider of Service (SCP)
Name	UID		
Print Management			
Basic Film Session	1.2.840.10008.5.1.1.1	Yes	No
Basic Film Box	1.2.840.10008.5.1.1.2	Yes	No
Basic Grayscale Image Box	1.2.840.10008.5.1.1.4	Yes	No
Basic Color Image Box	1.2.840.10008.5.1.1.4.1	Yes	No
Basic Grayscale Print Management (Meta)	1.2.840.10008.5.1.1.9	Yes	No
Printer	1.2.840.10008.5.1.1.16	No	No
Basic Color Print Management (Meta)	1.2.840.10008.5.1.1.18	Yes	No

Note1: Verification SCP (C-ECHO) is not included in the table above because it is required for any Acceptor of an Association. The Verification SCU details are covered in the details of the conformance statement.

Note2: RT objects are supported only on the Big Bore scanners.

Table 2: Media Services

Media Storage Application Profile	Write Files (FSC)	Read Files (FSR)
Compact Disk – Recordable		
CT/MR Studies on CD-R	Yes	Yes

2 TABLE OF CONTENTS

Table of Contents

1	DICOM CONFORMANCE STATEMENT OVERVIEW.....	3
2	TABLE OF CONTENTS	5
3	INTRODUCTION	8
3.1	REVISION HISTORY	8
3.2	AUDIENCE	8
3.3	REMARKS.....	8
3.4	DEFINITIONS, TERMS AND ABBREVIATIONS.....	9
3.5	REFERENCES	10
4	NETWORKING	11
4.1	IMPLEMENTATION MODEL	11
4.1.1	Application Data Flow	11
4.1.2	Functional Definition of AE's.....	14
4.1.2.1	Functional Definition of Patient Catalog Service	14
4.1.2.2	Functional Definition of Archive-Manager	15
4.1.2.3	Functional Definition of Disk-Server/Queue-Manager.....	15
4.1.2.4	Functional Definition of Memory Manager.....	17
4.1.2.5	Functional Definition of Memory Server	17
4.1.2.6	Functional Definition of Print Manager	17
4.1.2.7	Functional Definition of Storage Commitment Manager	18
4.1.3	Sequencing of Real World Activities.....	19
4.1.3.1	Integrated Workflow	19
4.1.3.2	Import Images per Query/Retrieve	20
4.2	AE SPECIFICATIONS.....	22
4.2.1	Patient-Catalog Server	22
4.2.1.1	SOP Classes	22
4.2.1.2	Association Policies.....	22
4.2.1.2.1	General	22
4.2.1.2.2	Number of Associations	22
4.2.1.2.3	Asynchronous Nature.....	23
4.2.1.2.4	Implementation Identifying Information	23
4.2.1.3	Association Initiation Policy	23
4.2.1.3.1	(Real-World) Activity – Worklist Request (C-FIND)	24
4.2.1.4	Overview of the applied Modality Worklist Information Model - FIND SOP Class	25
4.2.1.4.1	(Real-World) Activity – MPPS (N-CREATE, N-SET)	27
4.2.1.5	Association Acceptance Policy.....	32
4.2.2	Disk-Server/Queue-Manager Specifications	33
4.2.2.1	SOP Classes	33
4.2.2.2	Association Policies.....	33
4.2.2.2.1	General	33
4.2.2.2.2	Number of Associations	33
4.2.2.2.3	Asynchronous Nature.....	34
4.2.2.2.4	Implementation Identifying Information	34
4.2.2.2.5	Communication Failure Handling.....	34
4.2.2.3	Association Initiation Policy	34
4.2.2.3.1	(Real-World) Activity – Disk-Server (C-STORE SCU)	36
4.2.2.3.2	(Real-World) Activity – Queue-Manager (C-MOVE SCU)	39
4.2.2.4	Association Acceptance Policy.....	40
4.2.2.4.1	(Real-World) Activity – Disk-Server/Queue-Manager (C-ECHO)	42
4.2.2.4.2	(Real-World) Activity – Disk-Server (C-STORE SCP)	43
4.2.2.4.3	(Real-World) Activity – Disk-Server (C-MOVE SCP)	45

4.2.2.4.4	(Real-World) Activity – Disk-Server (C-FIND SCP)	47
4.2.3	Archive-Manager Specifications	50
4.2.3.1	SOP Classes	50
4.2.3.2	Association Policies	50
4.2.3.2.1	General	50
4.2.3.2.2	Number of Associations	51
4.2.3.2.3	Asynchronous Nature	51
4.2.3.2.4	Implementation Identifying Information	51
4.2.3.3	Association Initiation Policy	51
4.2.3.3.1	(Real-World) Activity – Archive-Manager C-FIND (SCU)	52
4.2.3.3.2	(Real-World) Activity – Archive-Manager C-ECHO (SCU)	54
4.2.3.4	Association Acceptance Policy	55
4.2.4	Memory-Manager Specifications	56
4.2.4.1	SOP Classes	56
4.2.4.2	Association Policies	56
4.2.4.2.1	General	56
4.2.4.2.2	Number of Associations	56
4.2.4.2.3	Asynchronous Nature	56
4.2.4.2.4	Implementation Identifying Information	56
4.2.4.3	Association Initiation Policy	57
4.2.4.3.1	(Real-World) Activity – Memory-Manager C-MOVE (SCU)	57
4.2.4.4	Association Acceptance Policy	59
4.2.5	Memory-Server Specifications	60
4.2.5.1	SOP Classes	60
4.2.5.2	Association Policies	60
4.2.5.2.1	General	60
4.2.5.2.2	Number of Associations	60
4.2.5.2.3	Asynchronous Nature	61
4.2.5.2.4	Implementation Identifying Information	61
4.2.5.3	Association Initiation Policy	61
4.2.5.4	Association Acceptance Policy	61
4.2.5.4.1	(Real-World) Activity – Memory Server C-STORE (SCP)	61
4.2.5.4.2	(Real-World) Activity – Memory-Server C-ECHO	63
4.2.6	Print-Manager Specifications	65
4.2.6.1	SOP Classes	65
4.2.6.2	Association Policies	65
4.2.6.2.1	General	65
4.2.6.2.2	Number of Associations	65
4.2.6.2.3	Asynchronous Nature	65
4.2.6.2.4	Implementation Identifying Information	66
4.2.6.3	Association Initiation Policy	66
4.2.6.3.1	(Real-World) Activity – Print Manager>	66
4.2.6.4	Association Acceptance Policy	73
4.2.7	StorageComm-Manager Specifications	74
4.2.7.1	SOP Classes	74
4.2.7.2	Association Policies	74
4.2.7.2.1	General	74
4.2.7.2.2	Number of Associations	74
4.2.7.2.3	Asynchronous Nature	74
4.2.7.2.4	Implementation Identifying Information	75
4.2.7.3	Association Initiation Policy	75
4.2.7.3.1	(Real-World) Activity – StorageComm-Manager	77
4.2.7.4	Association Acceptance Policy	79
4.2.7.4.1	(Real-World) Activity – StorageComm-Manager (C-ECHO)	80
4.3	NETWORK BRILLIANCE™ WORKSPACE INTERFACES	81
4.3.1	Physical Network Interface	81
4.3.2	Additional Protocols	81

4.4	CONFIGURATION	81
4.4.1	AE Title/Presentation Address Mapping	81
4.4.1.1	Local AE Titles	82
4.4.1.2	Remote AE Title/Presentation Address Mapping	82
4.4.2	Parameters	82
5	MEDIA INTERCHANGE	83
5.1	IMPLEMENTATION MODEL	83
5.1.1	Application Data Flow Diagram	83
5.1.2	Functional Definitions of AE's	83
5.1.3	Sequencing of Real World Activities	83
5.1.4	File Meta Information for Implementation Class and Version	83
5.2	AE SPECIFICATIONS	84
5.2.1	Media AE - Specification	84
5.2.1.1	File Meta Information for the Media AE	84
5.2.1.2	Real-World Activities	84
5.2.1.2.1	Display Directory	84
5.2.1.2.2	Write Images	84
5.2.1.3	DICOMDIR keys	85
5.2.1.3.1	Read Images	86
5.3	AUGMENTED AND PRIVATE APPLICATION PROFILES	87
5.3.1	Augmented Application Profiles	87
5.3.2	Private Application Profiles	87
5.4	MEDIA CONFIGURATION	87
6	SUPPORT OF CHARACTER SETS	88
7	SECURITY	89
7.1	SECURITY PROFILES	89
7.2	ASSOCIATION LEVEL SECURITY	89
7.3	APPLICATION LEVEL SECURITY	89
8	ANNEXES	90
8.1	IOD CONTENTS	90
8.1.1	Created SOP Instances	90
8.1.2	CT Image IOD Modules	90
8.1.3	General EGC Waveform IOD Modules	97
8.1.4	RT Plan IOD Modules	99
8.1.5	Dose Info Page Image	104
8.1.6	Usage of Attributes from Received IOD's	105
8.1.7	Attribute Mapping	105
8.1.8	Coerced/Modified fields	107
8.1.9	Tumor Localization Curve Module information	107
8.2	DICTIONARY OF PRIVATE ATTRIBUTES	109
8.3	CODED TERMINOLOGY AND TEMPLATES	109
8.4	GRAYSACLE IMAGE CONSISTENCY	109
8.5	STANDARD EXTENDED/SPECIALIZED/PRIVATE SOPS	109
8.5.1	CT Image Storage SOP Class	109
8.6	PRIVATE TRANSFER SYNTAXES	109

3 INTRODUCTION

The introduction specifies product and relevant disclaimers as well as any general information that the vendor feels is appropriate.

3.1 Revision History

The revision history provides dates and differences of the different releases.

Table 3: Revision History

Document Version	Date of Issue	Author	Description
1.0	27 Nov 2003	PMS MIT-IO	First edition of Conformance Statement Brilliance TM Workspace (V1.x).
2.0	22 Sep 2005	PMS MIT-IO	First edition of Conformance Statement Brilliance TM Workspace V 2.x based on DICOM Supplement 64
2.01	17 Oct 2005	PMS CT	Updated with RT objects for Big Bore scanners
2.02	27 Feb 2007	PMS CT	Updated for compliance with DICOM-2006
2.03	08 Apr 2007	PMS CT	Added private dose attributes to MPPS
2.04	16 Apr 2008	PMS CT	Added iCT scanner; compliance with DICOM-2007
2.05	11 Nov 2009	PMS CT	Added V3.x support; compliance with DICOM-2008, Dose Info

3.2 Audience

This Conformance Statement is intended for:

- (Potential) customers
- System integrators of medical equipment
- Marketing staff interested in system functionality
- Software designers implementing DICOM interfaces

It is assumed that the reader is familiar with the DICOM standard.

3.3 Remarks

The DICOM Conformance Statement is contained in chapter 4 through 8 and follows the contents and structuring requirements of DICOM PS 3.2-2008.

This DICOM Conformance Statement by itself does not guarantee successful interoperability of Philips equipment with non-Philips equipment. The user (or user's agent) should be aware of the following issues:

- **Interoperability**
Interoperability refers to the ability of application functions, distributed over two or more systems, to work successfully together. The integration of medical devices into an IT environment may require application functions that are not specified within the scope of DICOM. Consequently, using only the information provided by this Conformance Statement does not guarantee interoperability of Philips equipment with non-Philips equipment.
It is the user's responsibility to analyze thoroughly the application requirements

and to specify a solution that integrates Philips equipment with non-Philips equipment.

- **Validation**

Philips equipment has been carefully tested to assure that the actual implementation of the DICOM interface corresponds with this Conformance Statement.

Where Philips equipment is linked to non-Philips equipment, the first step is to compare the relevant Conformance Statements. If the Conformance Statements indicate that successful information exchange should be possible, additional validation tests will be necessary to ensure the functionality, performance, accuracy and stability of image and image related data. It is the responsibility of the user (or user's agent) to specify the appropriate test suite and to carry out the additional validation tests.

- **New versions of the DICOM Standard**

The DICOM Standard will evolve in future to meet the user's growing requirements and to incorporate new features and technologies. Philips is actively involved in this evolution and plans to adapt its equipment to future versions of the DICOM Standard. In order to do so, Philips reserves the right to make changes to its products or to discontinue its delivery.

The user should ensure that any non-Philips provider linking to Philips equipment also adapts to future versions of the DICOM Standard. If not, the incorporation of DICOM enhancements into Philips equipment may lead to loss of connectivity (in case of networking) and incompatibility (in case of media).

3.4 Definitions, Terms and Abbreviations

DICOM definitions, terms and abbreviations are used throughout this Conformance Statement. For a description of these, see NEMA PS 3.3-2008 and PS 3.4-2008. The word Philips in this document refers to Philips Medical Systems.

The following acronyms and abbreviations are used in this document.

AE	Application Entity
AP	Application Profile
CD	Compact Disc
CD-R	CD-Recordable
CT	Computed Tomography
DICOM	Digital Imaging and Communications in Medicine
DIMSE	DICOM Message Service Element
EBE	DICOM Explicit VR Big Endian
ELE	DICOM Explicit VR Little Endian
EOD	Erasable Optical Disk, same as MOD
FSC	File-set Creator
FSR	File-set Reader
GUI	Graphic User Interface
HIS	Hospital Information System
ILE	DICOM Implicit VR Little Endian
IOD	Information Object Definition
MOD	Magneto-Optical Disk, same as EOD
MPPS	Modality Performed Procedure Step
MR	Magnetic Resonance
MWL	Modality Worklist
NEMA	National Electrical Manufacturers Association
PACS	Picture Archiving and Picture Communication System
PDU	Protocol Data Unit

RIS	Radiology Information System
RT	Radiotherapy
RWA	Real-World Activity
SCP	Service Class Provider
SCU	Service Class User
SOP	Service Object Pair
TCP/IP	Transmission Control Protocol/Internet Protocol
VR	Value Representation
UID	Unique Identifier

3.5 References

- [DICOM] Digital Imaging and Communications in Medicine (DICOM), Part 1 – 18 (NEMA PS 3.1-2008 – PS 3.18-2008), National Electrical Manufacturers Association (NEMA) Publication Sales 1300 N. 17th Street, Suite 1847 Rosslyn, Virginia. 22209, United States of America

4 NETWORKING

This section contains the networking related services vs. the media related ones in Chapter 5.

4.1 Implementation model

The implementation model consists of three sections:

- The application data flow diagram, specifying the relationship between the Application Entities and the “external world” or Real-World Activities,
- A functional description of each Application Entity, and
- The sequencing constraints among them.

4.1.1 Application Data Flow

The System communication is based on the DICOM v3.0 standard. This enables the System to communicate with any DICOM v3.0 compliant products (e.g., scanners, workstations, PACS, HIS/RIS, hardcopy units). The System can function both as a server and as a client. Thus it can send and retrieve images from other stations, and other stations can retrieve and send images to and from the System Images are transferred in the DICOM v3.0 protocol based on TCP/IP as a transport layer.

The system implements and provides DICOM services using the following Application Entities:

- Patient Catalog Service (*Scanner Only*)
- Disk-Server/Queue-Manager
- Archive-Manager
- Memory-Manager
- Memory-Server
- Print-Manager
- StorageComm-Manager
- Media AE (No Network AE, See Chapter 5)

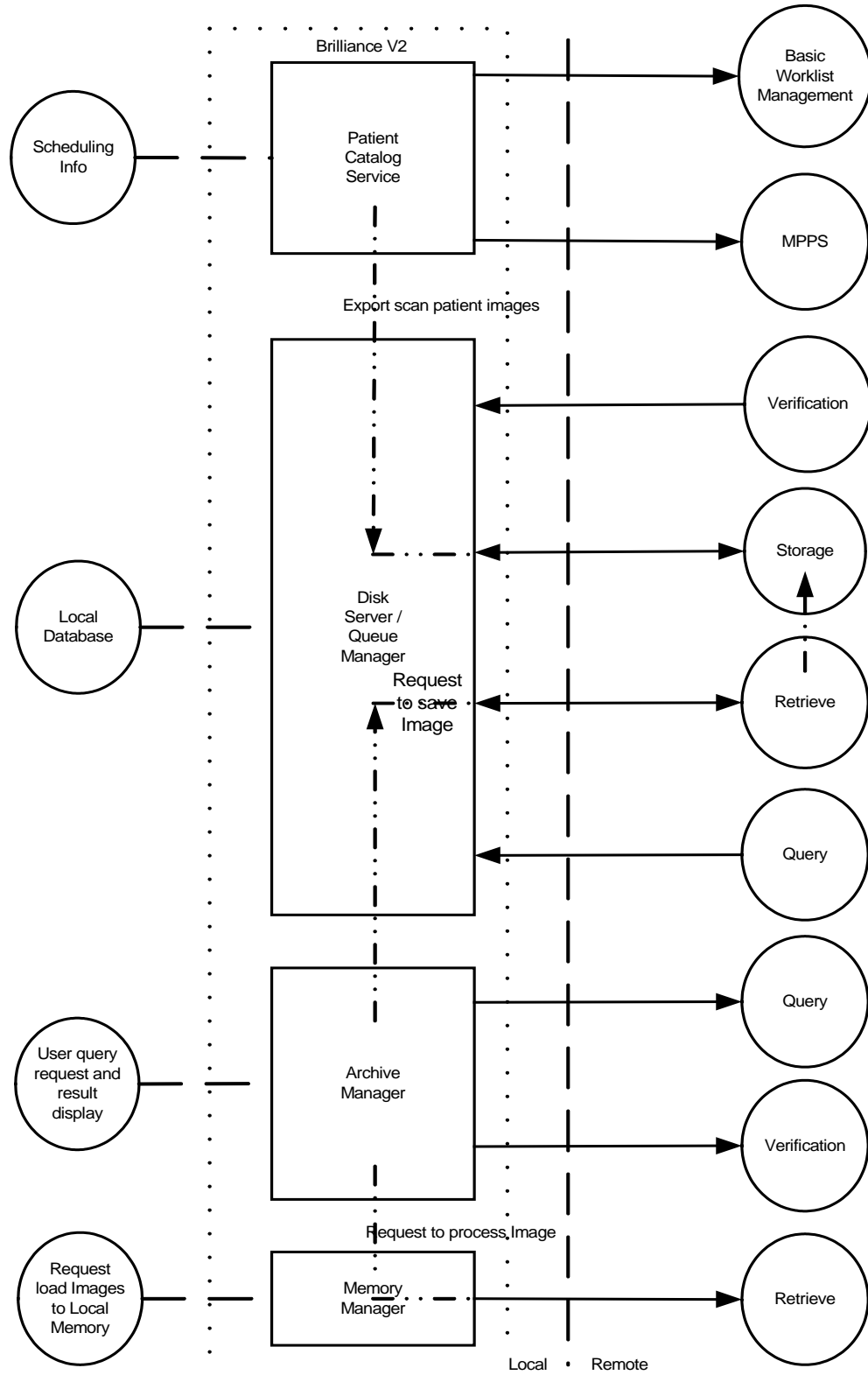

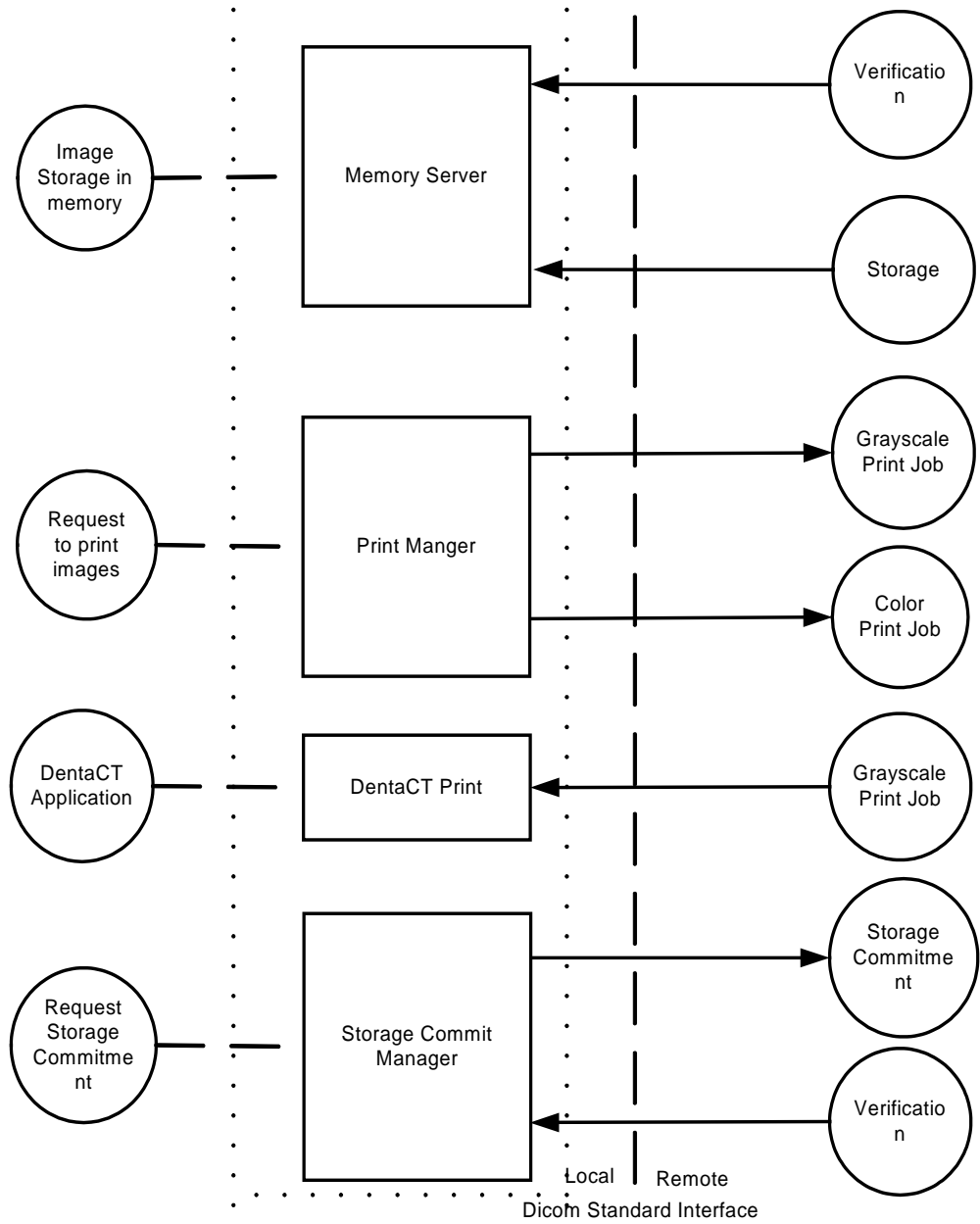

Figure 1: Application Data Flow Diagram

4.1.2 Functional Definition of AE's

This part contains a functional definition for each individual local Application Entity. It describes in general terms the functions to be performed by the AE, and the DICOM services used to accomplish these functions.

4.1.2.1 Functional Definition of Patient Catalog Service

(Scanner Only.)

The Patient-Catalog Server allows scanner software to communicate with a remote HIS/RIS system (as SCU) for the scheduled study information. The Patient-Catalog Server gets requests from the Study program responsible for carrying out the whole scanning procedure, and reports the study start/finish conditions back to HIS/RIS.

The server translates these internal requests into DICOM Modality Worklist Management and MPPS Services Class commands. The Patient-Catalog Server can perform the following activities:

- Establish an association with a remote AE.
- Release an association with a remote AE.
- Issue a C-FIND request to get Modality Worklist Management scheduling information.
- Issue a N-CREATE and N-SET requests to notify HIS/RIS by means of MPPS Service Class

The following figure provides an illustration of Patient-Catalog Server activities:

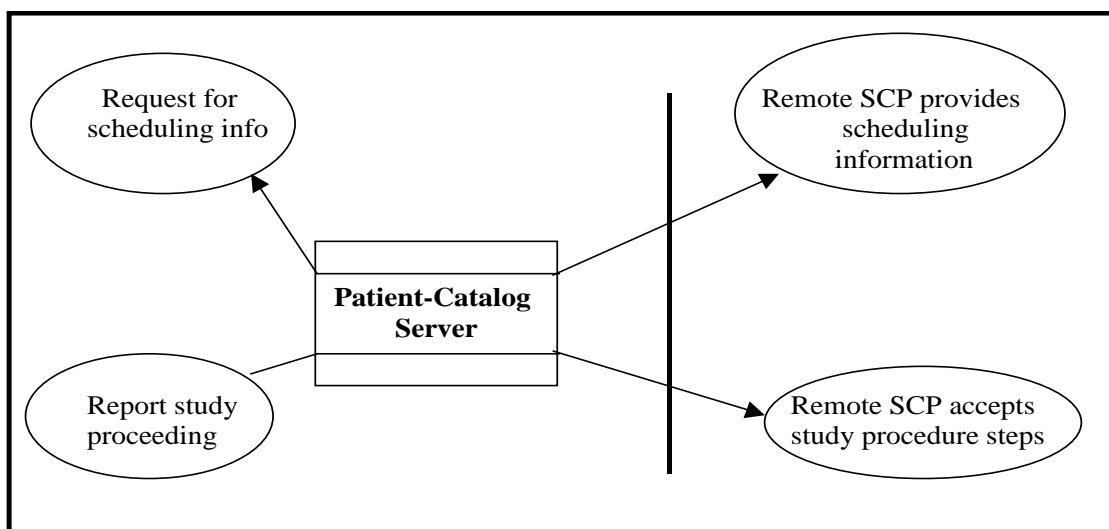

Figure 2: Illustration of Patient Catalog Service

4.1.2.2 Functional Definition of Archive-Manager

The Archive-Manager is a GUI (Graphical User-Interface) based application. It enables the user to perform queries using the DICOM protocol. The Archive-Manager lets the user select from a list of devices. It uses a configuration file to associate each device with a DICOM Application Entity. Using the GUI, the user can initiate the following activities:

- Establish an association with a remote AE.
- Release an association with a remote AE.
- Query for studies (using the Study Root model).
- Query for series (using the Study Root model).
- Verify connection to a remote AE
- Initiate data transfer between two DICOM hosts

The following figure provides an illustration of Archive-Manager activities:

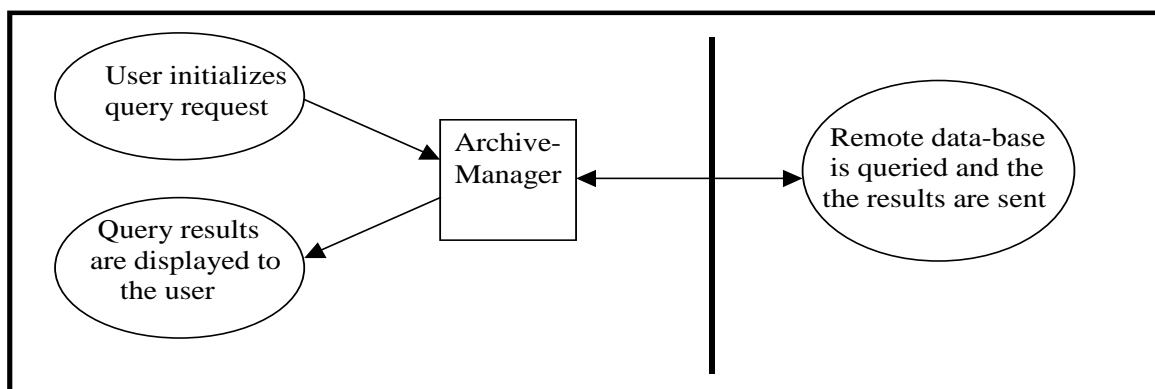

Figure 3: Illustration of Archive Manager

4.1.2.3 Functional Definition of Disk-Server/Queue-Manager

Disk-Server waits for another application to connect at the presentation address configured for its AE title. Disk-Server will accept associations with Presentation Contexts for Service Object Pair (SOP) classes of the Storage, Query-Retrieve (C-MOVE and C-FIND only) and Verification Service Classes.

When performing a Storage Service Class (SCP), Disk-Server will receive images and store them into the system's local database. The same AE may be used (with a configurable different AE title) to access the local MOD or different local hard disk folders.

When performing Query-Retrieve Service Class (C-FIND SCU), Disk-Server will query its local database according to the request's parameters, and will send the results to the issuer.

When performing Query-Retrieve Service Class (C-MOVE SCU), Disk-Server will issue a C-STORE (SCU) to the target AE for every image found according to the request.

The Queue-Manager is responsible for transferring images between devices in batch mode. The Queue-Manager gets transfer requests from the Memory-Manager and the Archive-Manager (using a proprietary non-DICOM protocol). It performs these

requests using the Query-Retrieve Service Class (C-MOVE). The Queue-Manager can perform the following activities:

- Establish an association with a remote AE.
 - Release an association with a remote AE.
 - Issue a C-MOVE request (using the Study Root model) for any desired target AE.
- The following figure provides an illustration of the Disk-Server and Queue-Manager activities:
- Issue a storage commitment request.

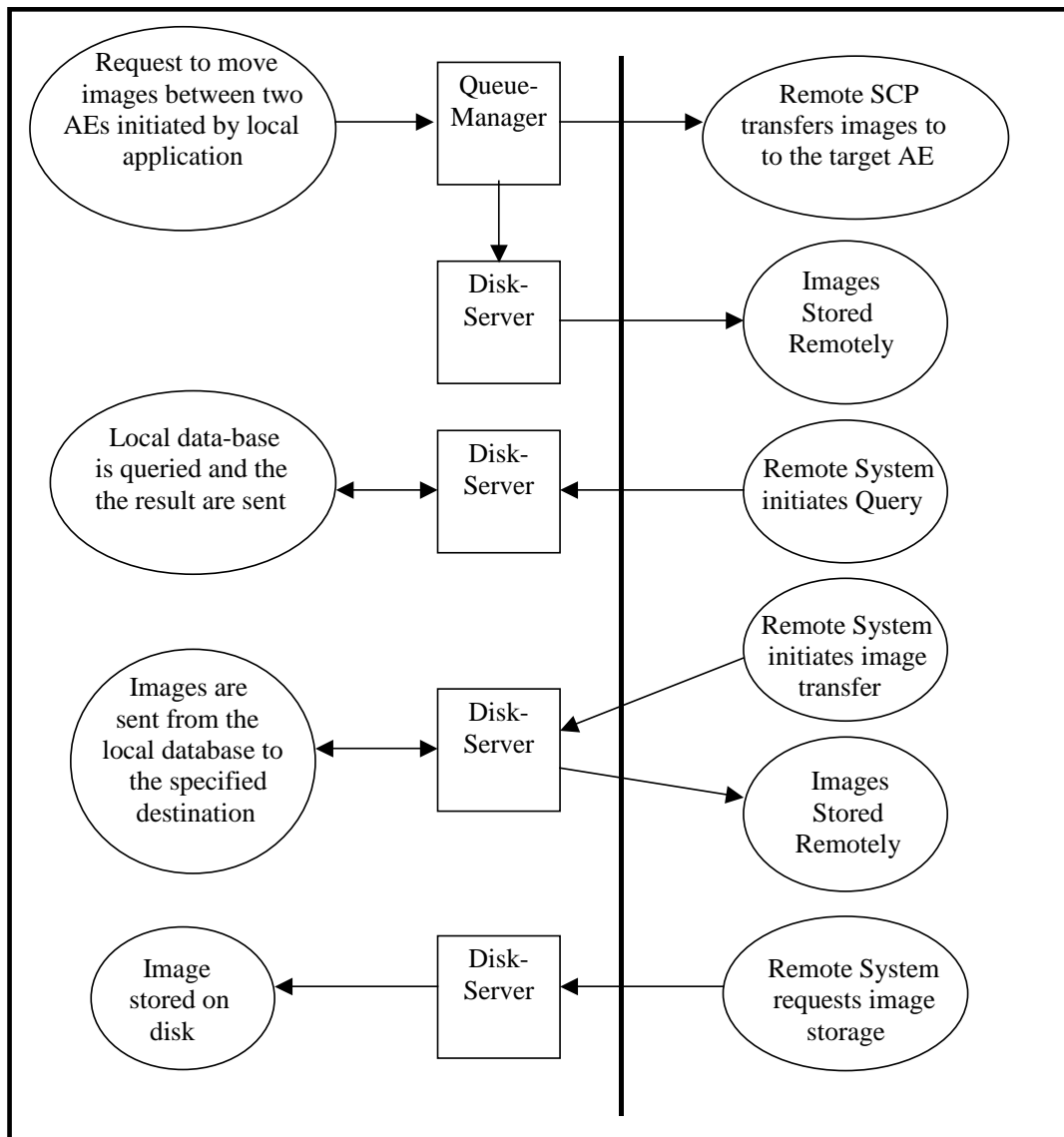

Figure 4: Illustration of Disk-Server/Queue-Manager

4.1.2.4 Functional Definition of Memory Manager

The Memory-Manager is responsible for loading images into memory. The Memory-Manager gets requests from local image processing and display applications to load images to the memory. It performs these requests using the Query-Retrieve Service Class (C-MOVE only). The Memory-Manager can perform the following activities:

- Establish an association with a remote AE.
- Release an association with a remote AE.
- Issue a C-MOVE request (using the Study Root model) where the target AE is Memory-Server.

The following figure provides an illustration of Memory-Manager activities:

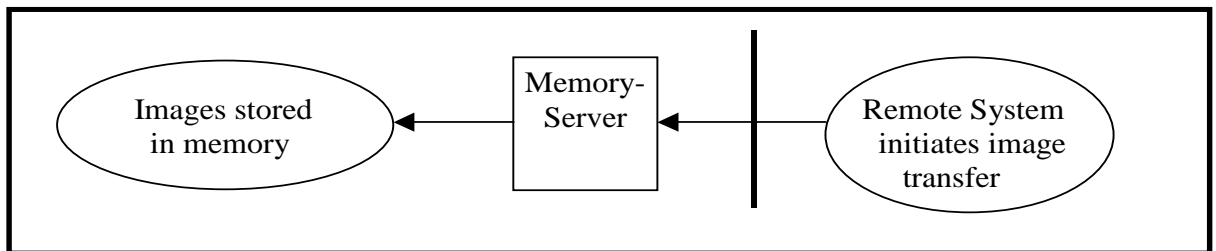

Figure 5: Illustration of Memory Manager

4.1.2.5 Functional Definition of Memory Server

Memory-Server waits for another application to connect at the presentation address configured for its AE title. Memory-Server will accept associations with Presentation Contexts for SOP classes of the Storage and Verification Service Classes. It will receive images on these Presentation Contexts and load them into the system's memory. The following figure provides an illustration of Memory-Server activities:

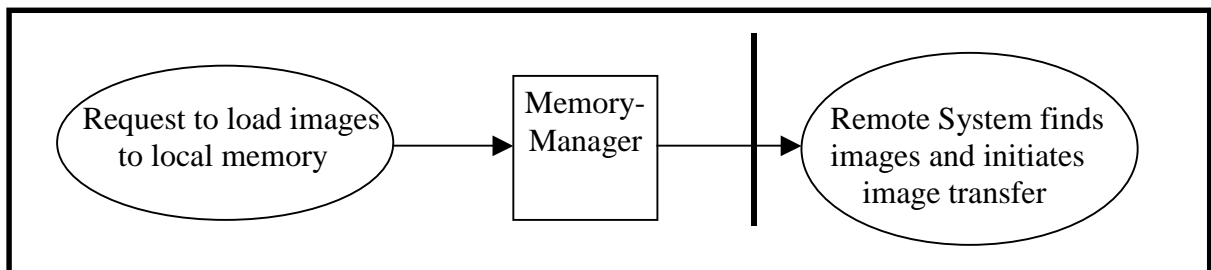

Figure 6: Illustration of Memory Server

4.1.2.6 Functional Definition of Print Manager

The Print-Manager is a Graphical User Interface (GUI) based application. It enables the user to print predefined images using the DICOM protocol. The user can specify as a printing destination one of several predefined printers. The user can also modify some of the printing parameters such as the film size and format. The following figure provides an illustration of Print-Manager activities:

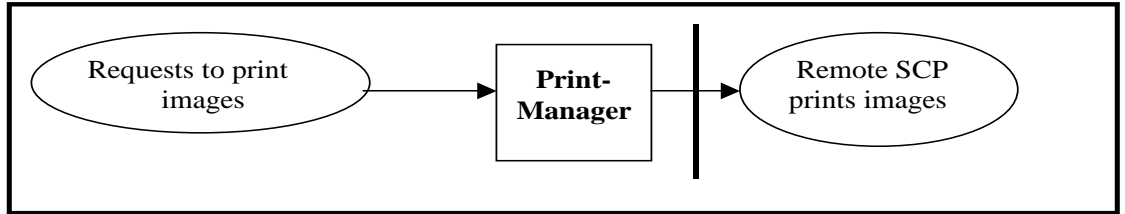

Figure 7: Illustration of Print Manager

4.1.2.7 Functional Definition of Storage Commitment Manager

StorageComm Manager is responsible to issue and support the storage commitment service as SCU. When some storage device server is configured as supports this service, StorageComm Manager establishes association with the specified AE title and sends storage commitment (N-ACTION) request using push model. After that, it may accept storage commitment (N-EVENT-REPORT) request on the same association or by establishing another association. The following figure provides an illustration of StorageComm-Manager:

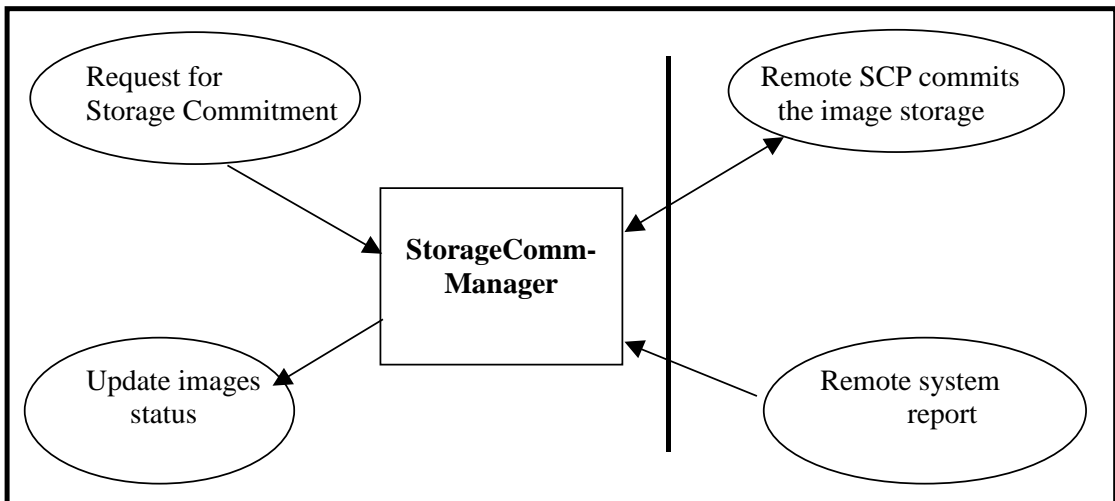

Figure 8: Illustration of Storage Commitment Manager

4.1.3 Sequencing of Real World Activities

4.1.3.1 Integrated Workflow

(Scanner Only) The sequence diagram in Figure 9 shows a typical example of a workflow (using a single acquisition, a single storage with commitment, without pre-fetching).

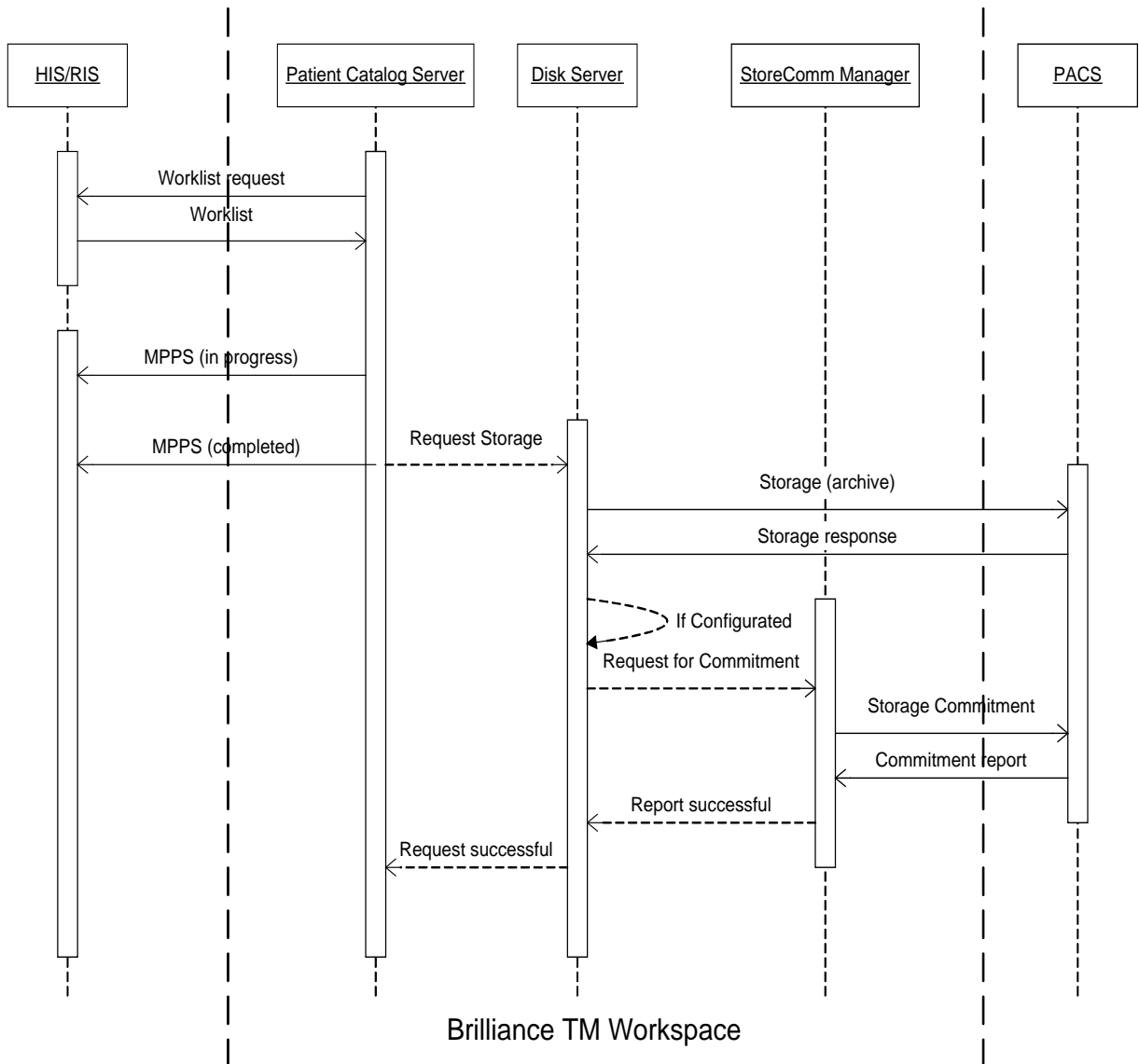

Figure 9: Sequencing of Integrated Workflow

The Brilliance™ Workspace is initiated by clicking the “HIS/RIS” button. After receiving the worklist data from the RIS the Brilliance™ Workspace will display the worklist on the user interface.

Then one may select a relevant patient record and add missing data or modify invalid data (as specified) before the received patient data is stored in the local database. At the start and at the end of the acquisition/processing the configured MPPS system (RIS) is informed of the progress of the selected procedure step.

The created images are converted into a DICOM messages that are stored in the local data base and can be sent to the remote system (PACS). After storage to the remote archive the Brilliance™ Workspace will request a storage commitment (as configured).

Note that, if no RIS is configured or no connection is possible, data can be introduced manually via the user interface.

After preparation of the scanner and the patient, the operator will perform the requested, or on his own initiative modified, procedure steps. Results may be CT Image, and, optionally, ECG Waveform images

4.1.3.2 Import Images per Query/Retrieve

The sequence diagram in Figure 10 and Figure 11 shows a typical example of an import of a series of images per Query/Retrieve (e.g. pre-fetching).

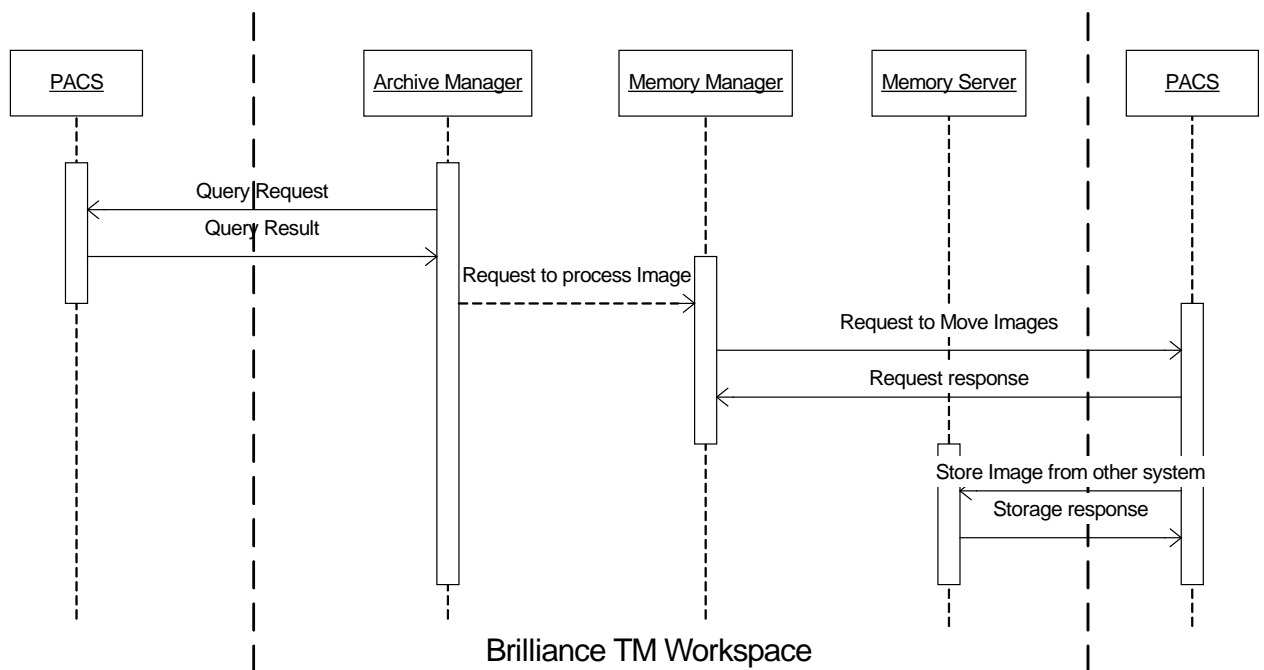

Figure 10: Sequencing of Import Image per Query/Retrieve to Memory Server.

The Brilliance™ Workspace sends initial query requests (on study level) to the remote AE to find all or selected studies. After selecting the studies to be retrieved the copy selection to local database is initiated. New query requests are sent to find the Series related to the selected studies. This is followed by retrieve requests to the remote AE to move all the selected Series of Images. Then for each retrieve request the remote AE will store the related Images on the Brilliance™ Workspace.

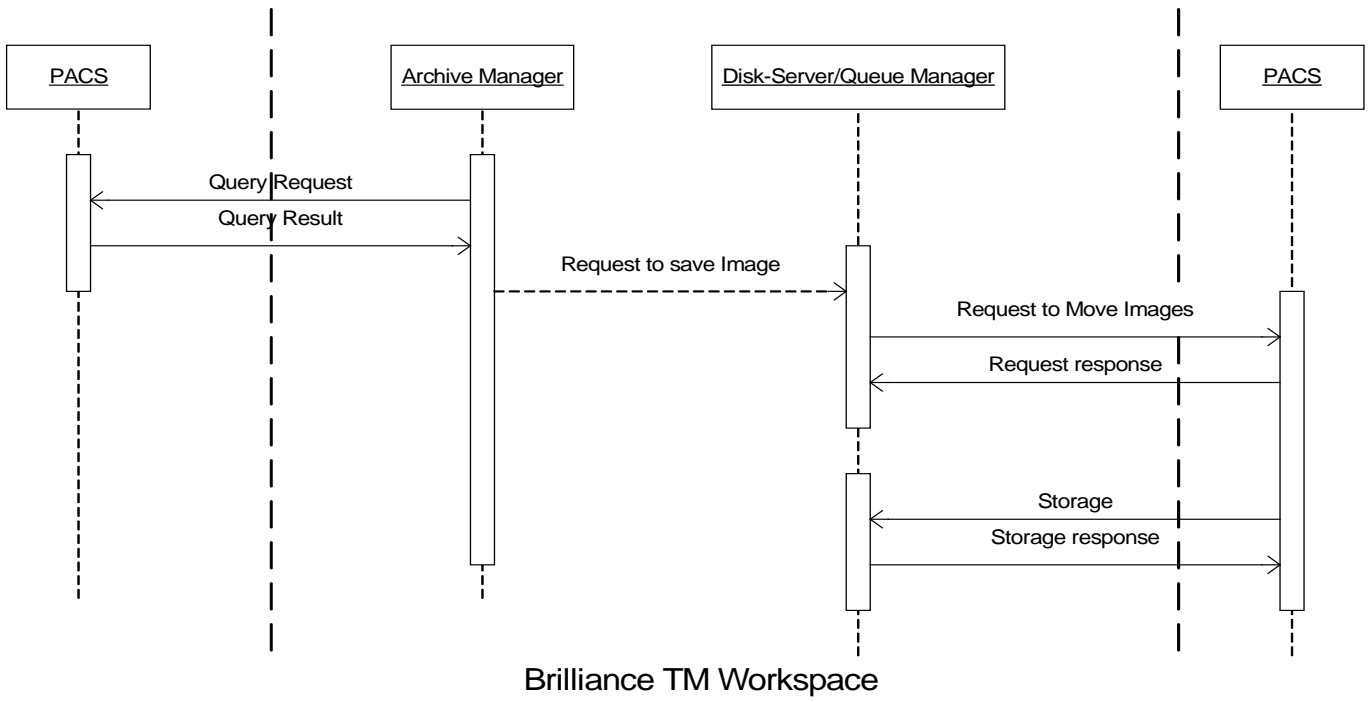

Figure 11: Sequencing of Import Image per Query/Retrieve to Local Disk.

4.2 AE Specifications

4.2.1 Patient-Catalog Server

(Scanner Only)

Patient-Catalog Server provides Standard Conformance to the following DICOM V3.0 SOP Classes.

4.2.1.1 SOP Classes

This Application Entity provides Standard Conformance to the following SOP Classes.

Table 4: SOP Classes for Patient-Catalog Server

SOP Class Name	SOP Class UID	SCU	SCP
Modality Performed Procedure Step Sop Class	1.2.840.10008.3.1.2.3.3	Yes	No
Modality Worklist Information Model FIND	1.2.840.10008.5.1.4.31	Yes	No

4.2.1.2 Association Policies

4.2.1.2.1 General

The maximum Protocol Data Unit (PDU) size that the Patient Catalog Server will use is configurable, with a minimum of 2 Kbytes.

The DICOM standard application context shall be specified.

Table 5: DICOM Application Context

Application Context Name	1.2.840.10008.3.1.1.1
--------------------------	-----------------------

4.2.1.2.2 Number of Associations

The number of simultaneous associations that this Application Entity may support is two. There will be always a separate association for the Modality Worklist and one for the MPPS service. The Patient-Catalog is working for an asynchronous association.

Table 6: Number of Associations as an Association Initiator for Patient-Catalog Server

Maximum number of simultaneous associations	2
---	---

Table 7: Number of Associations as an Association Acceptor for Patient-Catalog Server

Maximum number of simultaneous associations	0
---	---

4.2.1.2.3 Asynchronous Nature

Patient-Catalog will only allow a single outstanding operation on an association.

Table 8: Asynchronous Nature as an Association Initiator for Patient-Catalog Server

Maximum number of outstanding asynchronous transactions	1
---	---

4.2.1.2.4 Implementation Identifying Information

The value supplied for Implementation Class UID and Version Name is documented here.

Table 9: DICOM Implementation Class and Version for Patient-Catalog Server

Implementation Class UID	1.2.840.113704.7.0.2
Implementation Version Name	MxView-3.5

4.2.1.3 Association Initiation Policy

This describes the conditions under which the AE will initiate an association.

The behavior of the AE during association rejection is summarized in Table 10.

Table 10: DICOM Association Rejection Handling

Result	Source	Reason/Diagnosis	Behavior
1 – rejected-permanent	1 – DICOM UL service-user	2 – application-context-name-not-supported	Message on screen
		7 – called-AE-title-not-recognized	Message on screen
	2 – DICOM UL service-provider (ACSE related function)	2 – protocol-version-not-supported	Message on screen

4.2.1.3.1 (Real-World) Activity – Worklist Request (C-FIND)

4.2.1.3.1.1 Description and Sequencing of Activities

Patient-Catalog initiates an association when the user clicks on the HIS/RIS icon in the toolbar.

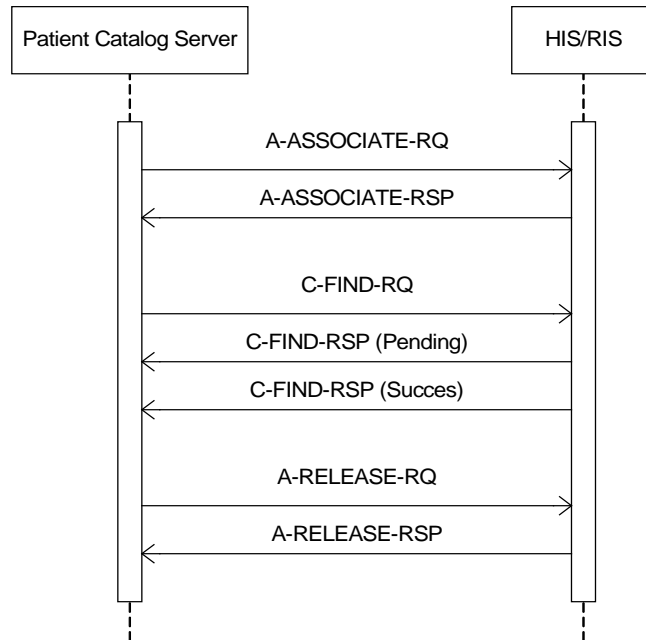

Figure 12: (Real World) Activity - Worklist Request (C-FIND)

4.2.1.3.1.2 Proposed Presentation Contexts

Each time an association is initiated, the association initiator proposes a number of presentation contexts to be used on that association. In this subsection, all the presentation contexts proposed by Patient-Catalog Server for (Real-World) Activity – Worklist Request (C-FIND) are defined in Table 11.

Table 11: Proposed Presentation Contexts for (Real-World) Activity – Worklist Request (C-FIND)

Presentation Context Table					
Abstract Syntax		Transfer Syntax		Role	Extended Negotiation
Name	UID	Name List (note)	UID List		
Modality Worklist Information Model - FIND	1.2.840.10008.5.1.4.31	ILE ELE EBE	1.2.840.10008.1.2 1.2.840.10008.1.2.1 1.2.840.10008.1.2.2	SCU	None

4.2.1.3.1.3 SOP Specific Conformance for SOP Classes

All details regarding the specific conformance, including response behavior to all status codes, both from an application level and communication errors are provided in Table 12.

Table 12: DICOM Worklist C-FIND Command Response Status Handling Behavior

Service Status	Code	Further Meaning	Behavior
Success	0000	Matching is complete	The SCP has successfully returned all matching information.
Failure	A900	Identifier does not match SOP Class	The status meaning is logged and reported to the user on screen.
	C000	Unable to Process	The status meaning is logged and reported to the user on screen.
Pending	FF00	Matches are continuing	No notification
	FF01	Matches are continuing – Warning that one or more Optional Keys were not supported	No notification
Refused	A700	Out of resources	The status meaning is logged and reported to the user on screen.
*	*	Any other status code	The status meaning is logged

4.2.1.4 Overview of the applied Modality Worklist Information Model - FIND SOP Class

This Chapter specifies in detail the applied attributes in the C-FIND Service Elements of this supported SOP Class.

The below tables should be read as follows:

Module name:	The name of the associated module for supported worklist attributes. The module name is written behind the table number.
Attribute name	Attributes supported to build an Panorama Modality Worklist Request Identifier.
Tag:	DICOM tag for this attribute.
VR:	DICOM VR for this attribute.
M:	Matching Keys for (automatic) Worklist Query. An "S" will indicate an attribute value for Single Value Matching, an "R" will indicate an attribute value for Range Matching, an "W" will denote Wildcard Matching (* and ?) and an "U" will indicate an attribute for Universal Matching
R:	Return Keys. An "x" will indicate that this attribute as Return Key with zero length for Universal Matching.
Q:	Interactive Query Key. An "x" will indicate that this attribute as matching key can be used.
D:	Displayed Keys. An "x" indicates that this worklist attribute is displayed to the user during a patient registration dialog.
IOD:	Referring to table 152.

Table 13: Patient Identifier Module

Attribute Name	Tag	VR	M	Q	D
Patient's Name	0010,0010	PN	W	X	X
Patient ID	0010,0020	LO	U	X	X
Other Patient Ids	0010,1000	LO			

Table 14: Patient Demographic Module

Attribute Name	Tag	VR	M	Q	D
Patient's Birth Date	0010,0030	DA			X
Patient's Sex	0010,0040	CS			X
Patient's Age	0010,1010	AS			X
Patient's Weight	0010,1030	DS			X
Ethnic Group	0010,2160	SH			
Patient Comments	0010,4000	LT			X
Patient Data Confidentiality Constraint Description	0040,3001	LO			

Table 15: Patient Medical Module

Attribute Name	Tag	VR	M	Q	D
Medical Alerts	0010,2000	LO			X
Contrast Allergies	0010,2110	LO			X
Additional Patient History	0010,21B0	LT			
Pregnancy Status	0010,21C0	US			
Special Needs	0038,0050	LO			X
Patient State	0038,0500	LO			

Table 16: Visit Relationship Module

Attribute Name	Tag	VR	M	Q	D
Referenced Patient Sequence	0008,1120	SQ			
>Referenced SOP Class UID	0008,1150	UI			
>Referenced SOP Instance UID	0008,1155	UI			

Table 17: Visit Identification Module

Attribute Name	Tag	VR	M	Q	D
Admission ID	0038,0010	LO			

Table 18: Visit Status Module

Attribute Name	Tag	VR	M	Q	D
Current Patient Location	0038,0300	LO			

Table 19: Scheduled Procedure Step Module

Attribute Name	Tag	VR	M	Q	D
Scheduled Procedure Step Sequence	0040,0100	SQ			X
>Modality	0008,0060	CS	S		
>Scheduled Procedure Step Start Date	0040,0002	DA			
>Scheduled Procedure Step Start Time	0040,0003	TM			
>Scheduled Performing Physician's Name	0040,0006	PN			
>Scheduled Procedure Step Description	0040,0007	LO			X
>Scheduled Action Item Code Sequence	0040,0008	SQ			
>>Code Value	0008,0100	SH			X
>>Code Scheme Designator	0008,0102	SH			X
>>Code Meaning	0008,0104	LO			X
>Scheduled Procedure Step ID	0040,0009	SH			
>Scheduled Procedure Step Location	0040,0011	SH			

Table 20: Requested Procedure Module

Attribute Name	Tag	VR	M	Q	D
Referenced Study Sequence	0008,1110	SQ			
>Referenced SOP Class UID	0008,1150	UI			
>Referenced SOP Instance UID	0008,1155	UI			
Requested Procedure Description	0032,1060	LO			X
Requested Procedure Code Sequence	0032,1064	SQ			
>Code Value	0008,0100	SH			X
>Coding Scheme Designator	0008,0102	SH			X
>Code Meaning	0008,0104	LO			X
Names of Intended Recipients of Results	0040,1010	PN			
Requested procedure Comments	0040,1400	LT			X

Table 21: Imaging Service Request Module

Attribute Name	Tag	VR	M	Q	D
Accession Number	0008,0050	SH	S	X	X
Referring Physician's Name	0008,0090	PN			X
Requesting Physician	0032,1032	PN			X
Requesting Service	0032,1033	LO			
Imaging Service Request Comments	0040,2400	LT			

Table 22: SOP Common Module

Attribute Name	Tag	VR	M	Q	D
Specific Character Set	0008,0005	CS	S		

Table 23: Additional Attributes – General Study Module

Attribute Name	Tag	VR	M	Q	D
Study Description	0008,1030	SH			

Table 24: Additional Attributes – General Series Module

Attribute Name	Tag	VR	M	Q	D
Operator's Name	0008,1070	PN			
Protocol Name	0032,1030	PN			

The default Query Configuration is set to "Modality" (CT). Optionally, additional matching for the own AE is configurable for the receive data in the local database.

4.2.1.4.1 (Real-World) Activity – MPPS (N-CREATE, N-SET)

4.2.1.4.1.1 Description and Sequencing of Activities

The user start the scan, the study sends a request to the Patient-Catalog Server, who initiates an association to notify the HIS/RIS system about procedure execution, with the status "IN PROGRESS".

When the user closes the study, the study sends a request to the Patient-Catalog Server, who initiates an association to notify the HIS/RIS about procedure completion.

When sending an N-SET-RQ, a status of "DISCONTINUED" will be sent to the HIS/RIS if not all images have arrived. Otherwise, a status of "COMPLETED" is sent.

The MPPS N-CREATE and MPPS N-SET are always done in two associations.

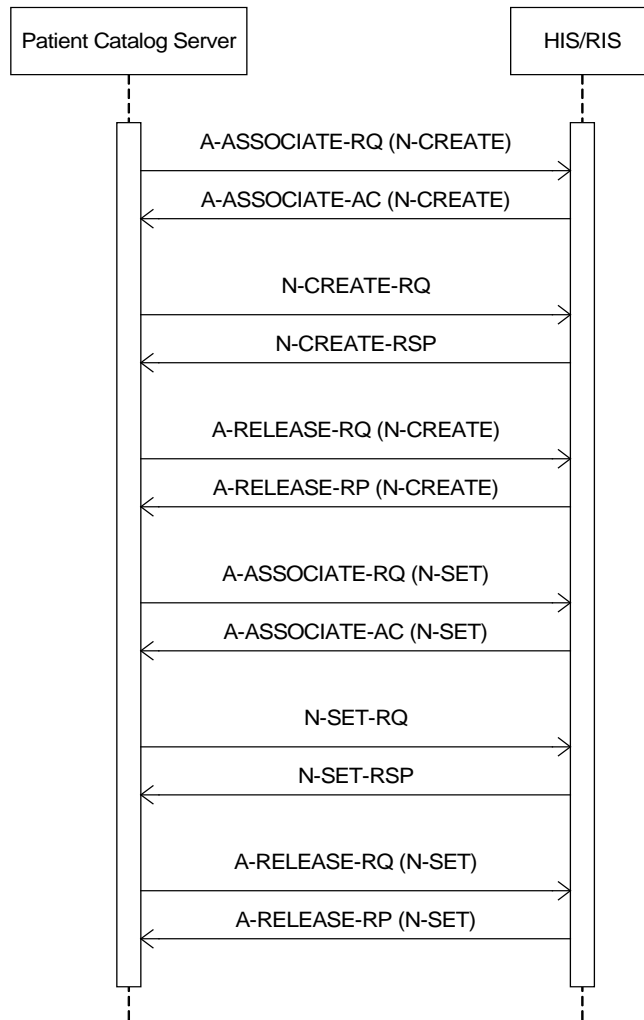

Figure 13: (Real World) Activity – MPPS (N-CREATE, N-SET)

4.2.1.4.1.2 Proposed Presentation Contexts

Each time an association is initiated, the association initiator proposes a number of presentation contexts to be used on that association. In this subsection, all the presentation contexts proposed by Patient-Catalog Server for (Real-World) Activity – MPPS (N-CREATE, N-SET) are defined in Table 11.

Table 25: Proposed Presentation Contexts for (Real-World) Activity – MPPS (N-CREATE, N-SET)

Presentation Context Table					
Abstract Syntax		Transfer Syntax		Role	Extended Negotiation
Name	UID	Name List (note)	UID List		
Modality Performed Procedure Step Sop Class	1.2.840.10008.3.1.2.3.3	ILE ELE EBE	1.2.840.10008.1.2 1.2.840.10008.1.2.1 1.2.840.10008.1.2.2	SCU	None

4.2.1.4.1.3 SOP Specific Conformance for SOP Classes

All details regarding the specific conformance, including response behavior to all status codes, both from an application level and communication errors are provided in Table 26

Table 26: MPPS N-CREATE/N-SET Request Identifier

Attribute Name	Tag	VR	N-CREATE	N-SET
Image Acquisition Results Module				
Modality	0008,0060	CS	Generated by the system: "CT"	N.A.
Study ID	0020,0010	SH	Generated by the system	N.A.
Performed Protocol Code Sequence	0040,0260	SQ	EMPTY	Acquired from the (0040,0100) sequence on the MWL
>Code Value	0008,0100	SH	N.A.	Acquired from the matching attribute on the (0040,0100) sequence on the MWL
>Coding Scheme Designator	0008,0102	SH	N.A.	Acquired from the matching attribute on the (0040,0100) sequence on the MWL
>Code Meaning	0008,0104	LO	N.A.	Acquired from the matching attribute on the (0040,0100) sequence on the MWL
Performed Series Sequence	0040,0340	SQ	EMPTY	Generated by the system
>Retrieve AE Title	0008,0054	AE	N.A.	Local System's AE title
>Series Description	0008,103E	LO	N.A.	User input
>Performing Physician's Name	0008,1050	PN	N.A.	Acquired from the MWL or User input
>Operator's Name	0008,1070	PN	N.A.	Acquired from the MWL or User input
>Referenced Image Sequence	0008,1140	SQ	N.A.	Generated by the system
>>Referenced SOP Class UID	0008,1150	UI	N.A.	Generated by the system
>>Referenced SOP Instance UID	0008,1155	UI	N.A.	Generated by the system
>Protocol Name	0018,1030	LO	N.A.	Generated by the system
>Series Instance UID	0020,000E	UI	N.A.	Generated by the system
>Referenced Non Image composite SOP Instance Sequence	0040,0220	SQ	N.A.	EMPTY
Performed Procedure Step Information Module				
Procedure Code Sequence	0008,1032	SQ	Acquired from the MWL	Acquired from the (0032,1064) sequence on the MWL
>Code Value	0008,0100	SH	Acquired from the MWL	Acquired from the matching attribute on the (0032,1064) sequence on the MWL
>Coding Scheme Designator	0008,0102	SH	Acquired from the MWL	Acquired from the matching attribute on the (0032,1064) sequence on the MWL
>Code Meaning	0008,0104	LO	Acquired from the MWL	Acquired from the matching attribute on the (0032,1064) sequence on the MWL
Performed Station AE Title	0040,0241	AE	Local System's AE title	N.A.
Performed Procedure Step Start Date	0040,0244	DA	Generated by the system: Date in which the scan started	N.A.
Performed Procedure Step Start Time	0040,0245	TM	Generated by the system:	N.A.

Attribute Name	Tag	VR	N-CREATE	N-SET
			Time in which the scan started	
Performed Procedure Step End Date	0040,0250	DA	EMPTY	Generated by the system: Date in which the scan ended
Performed Procedure Step End Time	0040,0251	TM	EMPTY	Generated by the system: Time in which the scan ended
Performed Procedure Step Status	0040,0252	CS	Generated by the system: "IN PROGRESS"	Generated by the system: "COMPLETED" or "DISCONTINUED"
Performed Procedure Step ID	0040,0253	SH	Generated by the system	N.A.
Performed Procedure Step Description	0040,0254	LO	Acquired from the MWL	Acquired from the MWL
Performed Procedure Type Description	0040,0255	LO	EMPTY	EMPTY
Performed Procedure Comment	0040,0280	ST	N.A.	N.A.
Performed Procedure Relationship Module				
Referenced Patient Sequence	0008,1120	SQ	Acquired from the MWL	N.A.
> Referenced SOP Class UID	0008,1150	UI	Acquired from the MWL	N.A.
>Referenced SOP Instance UID	0008,1155	UI	Acquired from the MWL	N.A.
Patient's Name	0010,0010	PN	Acquired from the MWL or User input	N.A.
Patient ID	0010,0020	LO	Acquired from the MWL or User input	N.A.
Patient's Birth Date	0010,0030	DA	Acquired from the MWL or User input	N.A.
Patient's Sex	0010,0040	CS	Acquired from the MWL or User input	N.A.
Scheduled Step Attribute Sequence	0040,0270	SQ	Acquired from the MWL	N.A.
>Accession Number	0008,0050	SH	Acquired from the MWL	N.A.
>Referenced Study Sequence	0008,1110	SQ	Acquired from the MWL	N.A.
>>Referenced SOP Class UID	0008,1150	UI	Acquired from the MWL	N.A.
>>Referenced SOP Instance UID	0008,1155	UI	Acquired from the MWL	N.A.
>Study Instance UID	0020,000D	UI	Acquired from the MWL	N.A.
>Requested Procedure Description	0032,1060	LO	Acquired from the MWL	N.A.
>Scheduled Procedure Step Description	0040,0007	LO	Acquired from the MWL	N.A.
>Scheduled Protocol Code Sequence	0040,0008	SQ	Acquired from the MWL	N.A.
>>Code Value	0008,0100	SH	Acquired from the MWL	N.A.
>>Coding Scheme Designator	0008,0102	SH	Acquired from the MWL	N.A.
>>Coding Scheme Version	0008,0103	SH	Acquired from the MWL	N.A.
>>Code Meaning	0008,0104	LO	Acquired from the MWL	N.A.
>>Protocol Context Sequence	0040,0440	SQ	Acquired from the MWL	N.A.
>>>Content Item Modifier Sequence	0040,0441	SQ	Acquired from the MWL	N.A.
>>>>Measurement Units Code Sequence	0040,08EA	SQ	Acquired from the MWL	N.A.
>>>>Code Value	0008,0100	SH	Acquired from the MWL	N.A.
>>>>Coding Scheme Designator	0008,0102	SH	Acquired from the MWL	N.A.
>>>>Coding Scheme Version	0008,0103	SH	Acquired from the MWL	N.A.
>>>>Code Meaning	0008,0104	LO	Acquired from the MWL	N.A.
>>>>Value Type	0040,A040	CS	Acquired from the MWL	N.A.
>>>>Concept Name Code Sequence	0040,A043	SQ	Acquired from the MWL	N.A.
>>>>Code Value	0008,0100	SH	Acquired from the MWL	N.A.
>>>>Coding Scheme Designator	0008,0102	SH	Acquired from the MWL	N.A.
>>>>Coding Scheme Version	0008,0103	SH	Acquired from the MWL	N.A.
>>>>Code Meaning	0008,0104	LO	Acquired from the MWL	N.A.
>>>>DateTime	0040,A120	DT	Acquired from the MWL	N.A.
>>>>Date	0040,A121	DA	Acquired from the MWL	N.A.
>>>>Time	0040,A122	TM	Acquired from the MWL	N.A.
>>>>Person Name	0040,A123	PN	Acquired from the MWL	N.A.

Attribute Name	Tag	VR	N-CREATE	N-SET
>>>>UID	0040,A123	UI	Acquired from the MWL	N.A.
>>>>Concept Code Sequence	0040,A168	SQ	Acquired from the MWL	N.A.
>>>>>Code Value	0008,0100	SH	Acquired from the MWL	N.A.
>>>>>Coding Scheme Designator	0008,0102	SH	Acquired from the MWL	N.A.
>>>>>Coding Scheme Version	0008,0103	SH	Acquired from the MWL	N.A.
>>>>>Code Meaning	0008,0104	LO	Acquired from the MWL	N.A.
>>>>Numeric Value	0040,A03A	DS	Acquired from the MWL	N.A.
>>>Measurement Units Code Sequence	0040,08EA	SQ	Acquired from the MWL	N.A.
>>>>Code Value	0008,0100	SH	Acquired from the MWL	N.A.
>>>>Coding Scheme Designator	0008,0102	SH	Acquired from the MWL	N.A.
>>>>Coding Scheme Version	0008,0103	SH	Acquired from the MWL	N.A.
>>>>Code Meaning	0008,0104	LO	Acquired from the MWL	N.A.
>>>Value Type	0040,A040	CS	Acquired from the MWL	N.A.
>>> Concept Name Code Sequence	0040,A043	SQ	Acquired from the MWL	N.A.
>>>>Code Value	0008,0100	SH	Acquired from the MWL	N.A.
>>>>Coding Scheme Designator	0008,0102	SH	Acquired from the MWL	N.A.
>>>>Coding Scheme Version	0008,0103	SH	Acquired from the MWL	N.A.
>>>>Code Meaning	0008,0104	LO	Acquired from the MWL	N.A.
>>>DateTime	0040,A120	DT	Acquired from the MWL	N.A.
>>>Date	0040,A121	DA	Acquired from the MWL	N.A.
>>>Time	0040,A122	TM	Acquired from the MWL	N.A.
>>>Person Name	0040,A123	PN	Acquired from the MWL	N.A.
>>>UID	0040,A123	UI	Acquired from the MWL	N.A.
>>>Concept Code Sequence	0040,A168	SQ	Acquired from the MWL	N.A.
>>>>Code Value	0008,0100	SH	Acquired from the MWL	N.A.
>>>>Coding Scheme Designator	0008,0102	SH	Acquired from the MWL	N.A.
>>>>Coding Scheme Version	0008,0103	SH	Acquired from the MWL	N.A.
>>>>Code Meaning	0008,0104	LO	Acquired from the MWL	N.A.
>>>Numeric Value	0040,A30A	DS	Acquired from the MWL	N.A.
>Scheduled Procedure Step ID	0040,0009	SH	Acquired from the MWL	N.A.
>Requested Procedure ID	0040,1001	SH	Acquired from the MWL	N.A.
Radiation Dose Module				
Distance Source To Detector	0018,1110	DS	EMPTY	Generated by the system
Total Number Of Exposures	0040,0301	US	EMPTY	Generated by the system
Exposure Dose Sequence	0040,030E	SQ	EMPTY	Generated by the system
>KVP	0018,0060	DS		Generated by the system
>Exposure Time	0018:1150	IS		Generated by the system
>Radiation Mode	0018,115A	CS		Generated by the system
>Filter Type	0018,1160	SH		Generated by the system
>Filter Material	0018,7050	CS		Generated by the system
>X-ray Tube Current in μ A	0018:8151	DS		Generated by the system
>CTDI Vol	0018:9345	FD		Generated by the system
>DLP	00E1:1021	DS		Generated by the system
Comments On Radiation Dose	0040,0310	ST	EMPTY	Generated by the system (includes CTDI/DLP per acquisition and total DLP)
DLP	00E1:1021	DS	EMPTY	Generated by the system (Total DLP per exam)

* This attribute is Configurable. It is sent on the MPPS N-CREATE/N-SET message only if it was pre-configured for sending on the MWL request to the HIS/RIS machine.

4.2.1.5 Association Acceptance Policy

Patient-Catalog Server never accepts an association.

4.2.2 Disk-Server/Queue-Manager Specifications

Disk-Server and Queue-Manager work closely together and can be configured to act as a single Application Entity (i.e., having the same AE Title) or as different Application Entities. In order to simplify the description they are described in this document as a single Application Entity. Depending on configuration, multiple copies of Disk-Server may be running simultaneously, each representing the same Application Entity.

4.2.2.1 SOP Classes

This Application Entity provides Standard Conformance to the following SOP Classes.

Table 27: SOP Classes for Disk-Server/Queue-Manager Specifications

SOP Class Name	SOP Class UID	SCU	SCP
Computed Radiography Image Storage	1.2.840.10008.5.1.4.1.1.1	Yes	Yes
Digital X-Ray Image Storage – for Presentation	1.2.840.10008.5.1.4.1.1.1.1	Yes	Yes
Digital X-Ray Image Storage – for Processing	1.2.840.10008.5.1.4.1.1.1.1.1	Yes	Yes
CT Image Storage	1.2.840.10008.5.1.4.1.1.2	Yes	Yes
MR Image Storage	1.2.840.10008.5.1.4.1.1.4	Yes	Yes
Secondary Capture Image Storage	1.2.840.10008.5.1.4.1.1.7	Yes	Yes
General ECG Waveform Storage	1.2.840.10008.5.1.4.1.1.9.1.2	Yes	Yes
Grayscale Softcopy Presentation State Storage *	1.2.840.10008.5.1.4.1.1.11.1	Yes	Yes
X-Ray Angiographic Image Storage *	1.2.840.10008.5.1.4.1.1.12.1	Yes	Yes
X-Ray Radiofluoroscopic Image Storage	1.2.840.10008.5.1.4.1.1.12.2	Yes	Yes
Nuclear Medicine Image Storage *	1.2.840.10008.5.1.4.1.1.20	Yes	Yes
Positron Emission Tomography Image Storage *	1.2.840.10008.5.1.4.1.1.128	Yes	Yes
RT Image Storage	1.2.840.10008.5.1.4.1.1.481.1	Yes	Yes
RT Structure Set Storage *	1.2.840.10008.5.1.4.1.1.481.3	Yes	Yes
RT Plan Storage *	1.2.840.10008.5.1.4.1.1.481.5	Yes	Yes
Verification SOP Class	1.2.840.10008.1.1	No	Yes
Study Root Query/Retrieve Information Model – FIND	1.2.840.10008.5.1.4.1.2.2.1	No	Yes
Study Root Query/Retrieve Information Model – MOVE	1.2.840.10008.5.1.4.1.2.2.2	Yes	Yes

*Note: Marked as * SOP Class images are not supported for viewing, only supported for storage.*

4.2.2.2 Association Policies

4.2.2.2.1 General

The Maximum Protocol Data Unit (PDU) size that the Disk-Server will use is configurable, with a minimum of 2K bytes and a maximum of 16 Kbytes.

There is default a timeout of 60 seconds before DICOM association release during Copy operation (when issuing C-STORE and C-MOVE DICOM requests).

Table 28: DICOM Application Context

Application Context Name	1.2.840.10008.3.1.1.1
--------------------------	-----------------------

4.2.2.2.2 Number of Associations

The number of simultaneous associations that will be accepted by Disk-Server is limited only by the kernel parameters of the underlying TCP/IP implementation. Disk-Server will spawn a new process for each connection request it receives. Therefore, Disk-Server can have multiple simultaneous connections, and there are no inherent

limitations on the number of simultaneous associations that the Application Entity represented by Disk-Server can maintain. Disk-Server/Queue-Manager can initiate multiple simultaneous connections. The maximal number of simultaneous associations is limited by the configuration of the system. Disk-Server/Queue-Manager will not initiate more than one association per each remote AE configured as an SCP in the system.

Table 29: Number of Associations as an Association Initiator for Disk-Server/Queue-Manager Specifications

Maximum number of simultaneous associations	Unlimited
---	-----------

Table 30: Number of Associations as an Association Acceptor for Disk-Server/Queue-Manager Specification

Maximum number of simultaneous associations	Limit by Kernel
---	-----------------

4.2.2.2.3 Asynchronous Nature

Disk-Server/Queue-Manager will only allow a single outstanding operation on an association.

Table 31: Asynchronous Nature as an Association Initiator for Disk-Server/Queue-Manager Specifications

Maximum number of outstanding asynchronous transactions	1
---	---

4.2.2.2.4 Implementation Identifying Information

The value supplied for Implementation Class UID and Version Name is documented here.

Table 32: DICOM Implementation Class and Version for Disk-Server/Queue-Manager Specifications

Implementation Class UID	1.2.840.113704.7.0.2
Implementation Version Name	MxView-3.5

4.2.2.2.5 Communication Failure Handling

The behavior of the AE during communication failure is summarized in Table 33

Table 33: Communication Failure Behavior

Exception	Behavior
Communication Timeout	If there is no response from the remote system on store/ retrieve within 5 minutes, the Brilliance™ Workspace will close the association and retry it later

4.2.2.3 Association Initiation Policy

Disk Server will attempt to initiate a new association when requested to send images to the remote system, as part of a C-MOVE Command. Queue-Manager will attempt to initiate a new association when requested to perform image transfer (move) from the remote system.

The behavior of the AE during association rejection is summarized in Table 34

Table 34: DICOM Association Rejection Handling

Result	Source	Reason/Diagnosis	Behavior
1 – rejected-permanent	1 – DICOM UL service-user	2 – application-context-name-not-supported	No message to user. “Out of resources“ message sent to C-MOVE invoker.
		7 – called-AE-title-not-recognized	No message to user. “Out of resources“ message sent to C-MOVE invoker.
	2 – DICOM UL service-provider (ACSE related function)	2 – protocol-version-not-supported	No message to user. “Out of resources“ message sent to C-MOVE invoker.

The behavior of the AE during DICOM communication failure is summarized in Table 35

Table 35: DICOM Command Communication Failure Behavior

Exception	Behavior
Association aborted	Connection closed.

4.2.2.3.1 (Real-World) Activity – Disk-Server (C-STORE SCU)

4.2.2.3.1.1 Description and Sequencing of Activities

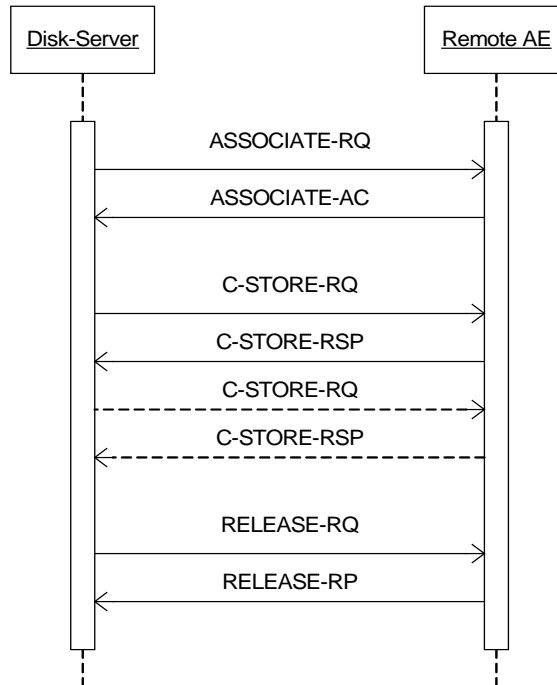

Figure 14: (Real World) Activity – Disk-Server (C-STORE SCU)

The associated Real-World Activity is a request for retrieval of images from the disk and storage of the images to a remote system using a C-STORE command. The Release-RQ has a delay of 30 seconds.

4.2.2.3.1.2 Proposed Presentation Contexts

Each time an association is initiated, the association initiator proposes a number of presentation contexts to be used on that association. In this subsection, the presentation contexts proposed by Disk-Server for (Real-World) Activity – Disk-Server (C-STORE SCU) are defined in Table 36. Explicit VR Transfer Syntaxes for a specific AE target may be restricted using the configuration utility.

Table 36: Proposed Presentation Contexts for (Real-World) Activity – Disk-Server (C-STORE SCU)

Presentation Context Table					
Abstract Syntax		Transfer Syntax		Role	Extended Negotiation
Name	UID	Name List	UID List		
Computed Radiography Image Storage	1.2.840.10008.5.1.4.1.1.1	ILE ELE EBE	1.2.840.10008.1.2 1.2.840.10008.1.2.1 1.2.840.10008.1.2.2	SCU	None
Digital X-Ray Image Storage – for Presentation	1.2.840.10008.5.1.4.1.1.1.1	ILE ELE EBE	1.2.840.10008.1.2 1.2.840.10008.1.2.1 1.2.840.10008.1.2.2	SCU	None
Digital X-Ray Image Storage – for Processing	1.2.840.10008.5.1.4.1.1.1.1.1	ILE ELE EBE	1.2.840.10008.1.2 1.2.840.10008.1.2.1 1.2.840.10008.1.2.2	SCU	None
CT Image Storage	1.2.840.10008.5.1.4.1.1.2	ILE ELE EBE	1.2.840.10008.1.2 1.2.840.10008.1.2.1 1.2.840.10008.1.2.2	SCU	None
MR Image Storage	1.2.840.10008.5.1.4.1.1.4	ILE ELE EBE	1.2.840.10008.1.2 1.2.840.10008.1.2.1 1.2.840.10008.1.2.2	SCU	None
Secondary Capture Image Storage	1.2.840.10008.5.1.4.1.1.7	ILE ELE EBE	1.2.840.10008.1.2 1.2.840.10008.1.2.1 1.2.840.10008.1.2.2	SCU	None
General ECG-Waveform Storage	1.2.840.10008.5.1.4.1.1.9.1.2	ILE ELE EBE	1.2.840.10008.1.2 1.2.840.10008.1.2.1 1.2.840.10008.1.2.2	SCU	None
Grayscale Softcopy Presentation State Storage	1.2.840.10008.5.1.4.1.1.11.1	ILE ELE EBE	1.2.840.10008.1.2 1.2.840.10008.1.2.1 1.2.840.10008.1.2.2	SCU	None
X-Ray Angiographic Image Storage	1.2.840.10008.5.1.4.1.1.12.1	ILE ELE EBE	1.2.840.10008.1.2 1.2.840.10008.1.2.1 1.2.840.10008.1.2.2	SCU	None
X-Ray Radiofluoroscopic Image Storage	1.2.840.10008.5.1.4.1.1.12.2	ILE ELE EBE	1.2.840.10008.1.2 1.2.840.10008.1.2.1 1.2.840.10008.1.2.2	SCU	None
Nuclear Medicine Image Storage	1.2.840.10008.5.1.4.1.1.20	ILE ELE EBE	1.2.840.10008.1.2 1.2.840.10008.1.2.1 1.2.840.10008.1.2.2	SCU	None
Positron Emission Tomography Image Storage	1.2.840.10008.5.1.4.1.1.128	ILE ELE EBE	1.2.840.10008.1.2 1.2.840.10008.1.2.1 1.2.840.10008.1.2.2	SCU	None
RT Image Storage	1.2.840.10008.5.1.4.1.1.481.1	ILE ELE EBE	1.2.840.10008.1.2 1.2.840.10008.1.2.1 1.2.840.10008.1.2.2	SCU	None
RT Structure Set Storage	1.2.840.10008.5.1.4.1.1.481.3	ILE ELE EBE	1.2.840.10008.1.2 1.2.840.10008.1.2.1 1.2.840.10008.1.2.2	SCU	None
RT Plan Storage	1.2.840.10008.5.1.4.1.1.481.5	ILE ELE EBE	1.2.840.10008.1.2 1.2.840.10008.1.2.1 1.2.840.10008.1.2.2	SCU	None

Disk-Server prefers an explicit Transfer Syntax encoding. If offered a choice of Transfer Syntax's in a Presentation Context, it will apply the following priorities to the choice of Transfer Syntax:

- DICOM Explicit VR Little Endian.
- DICOM Explicit VR Big Endian.
- DICOM Implicit VR Little Endian.

4.2.2.3.1.3 SOP Specific Conformance for SOP Classes

Disk-Server provides standard conformance to the DICOM V3.0 Storage Service Class as an SCU SOP Classes mentioned in the previous section.

Multiple C-STORE operations can be performed over a single association. Upon receiving a C-STORE confirmation containing a successful status, this implementation will perform the next C-STORE operation (if this operation is the result of the Series Level Move request). The association will be kept open if possible.

Any unsuccessful status (error or warning), returned in the C-STORE confirmation, results in termination of the sending further C-Store requests (if any in the queue), reporting of error to the system log file, and returning of a status code of A702 ("Refused") in the C-MOVE confirmation.

There are no timeouts implemented in this process.

The system creates CT Images. In section 8.1.1 a detailed description of the created objects is defined.

All details regarding the specific conformance, including response behavior to all status codes, both from an application level and communication errors are provided in Table 37.

Table 37: DICOM C-STORE Command Response Status Handling Behavior

Service Status	Code	Further Meaning	Behavior
Success	0000	Success	Storage successful.
Failure	0122	Refused – SOP Class not supported	Message by transfer result – Unknown reason
	A700	Refused – Out of Resources	Message by transfer result – Out of Resources
	A900	Error - Data Set does not match SOP	Message by transfer result – Unknown reason
	C000	Error – Cannot understand	Message by transfer result – Store failed
Warning	B000	Coercion of Data Elements	Message by transfer result – 0 Success, 1 Warn, 0 Fail
	B006	Elements Discarded	Message by transfer result – 0 Success, 1 Warn, 0 Fail
	B007	Data Set does not match	Message by transfer result – 0 Success, 1 Warn, 0 Fail

4.2.2.3.2 (Real-World) Activity – Queue-Manager (C-MOVE SCU)

4.2.2.3.2.1 Description and Sequencing of Activities

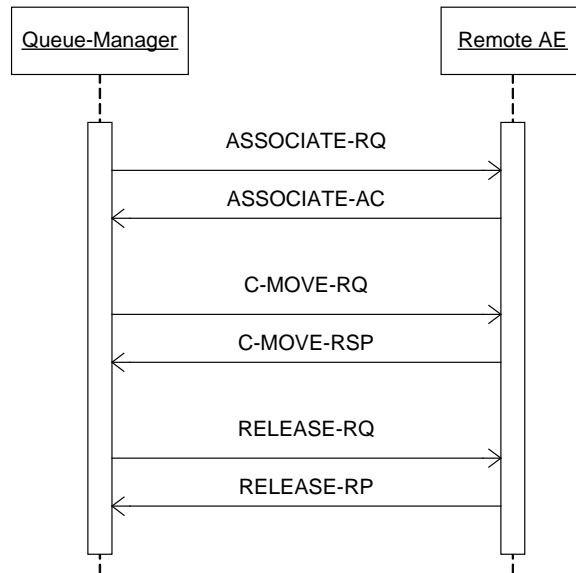

Figure 15: (Real World) Activity – Queue-Manager (C-MOVE SCU)

Queue-Manager initiates an association when some application asks for image transfer from a specified source device to a specified target device. If Queue-Manager fails to move all the required images, it waits for some configurable duration and then retries to initiate the association.

4.2.2.3.2.2 Proposed Presentation Contexts

Each time an association is initiated, the association initiator proposes a number of presentation contexts to be used on that association. In this subsection, the presentation contexts proposed by Disk-Server for (Real-World) Activity – Queue-Manager (C-MOVE SCU) are defined in Table 38

Table 38: Proposed Presentation Contexts for <(Real-World) Activity – Queue-Manager (C-MOVE SCU)

Presentation Context Table					
Abstract Syntax		Transfer Syntax		Role	Extended Negotiation
Name	UID	Name List	UID List		
Study Root Query/Retrieve Information Model - MOVE	1.2.840.10008.5.1.4.1.2.2.2	ILE ELE EBE	1.2.840.10008.1.2 1.2.840.10008.1.2.1 1.2.840.10008.1.2.2	SCU	None

4.2.2.3.3 SOP Specific Conformance for SOP Classes

Queue-Manager provides standard conformance to the DICOM V3.0 Query/Retrieve Service Class as an SCU for the following SOP Class: Study Root Query/Retrieve Information Model - FIND, UID=1.2.840.10008.5.1.4.1.2.2.2.

The system does not support case insensitive matching

All details regarding the specific conformance, including response behavior to all status codes, both from an application level and communication errors are provided in Table 39

Table 39: DICOM C-MOVE Command Response Status Handling Behavior

Service Status	Code	Further Meaning	Behavior
Success	0000	Success	Storage successful.
Failure	A701	Refused – Out of Resources	Message by transfer result – Refused Unknown reason
	A702	Refused – Out of Resources	Message by transfer result – Refused Store Failed
	A801	Refused – Move Destination Unknown	Message by transfer result – Refused Unknown target
	A900	Error – Identifier Does Not Match SOP Class	Message by transfer result – Failed Unknown reason
	C000	Error – Unable to Process	Message by transfer result – Failed Store Failed
Warning	B000	Coercion of Data Elements	Message by transfer result – 0 Success, 1 Warn, 0 Fail
Cancel	FE00	Cancel	Message by transfer result – Refused Connection closed on timeout.

4.2.2.4 Association Acceptance Policy

Disk-Server/Queue-Manager places no limitations on the number of simultaneous connections it will support. However, it is possible to control that may connect to Disk-Server/Queue-Manager during the system configuration process

The AE association rejection policies are summarized in Table 40

Table 40: DICOM Association Rejection Policies

Result	Source	Reason/Diagnosis	Behavior
1 – rejected-permanent	1 – DICOM UL service-user	2 – application-context-name-not-supported	

Result	Source	Reason/Diagnosis	Behavior
		7 – called-AE-title-not-recognized	
	2 – DICOM UL service-provider (ACSE related function)	2 – protocol-version-not-supported	

4.2.2.4.1 (Real-World) Activity – Disk-Server/Queue-Manager (C-ECHO)

4.2.2.4.1.1 Description and Sequencing of Activities

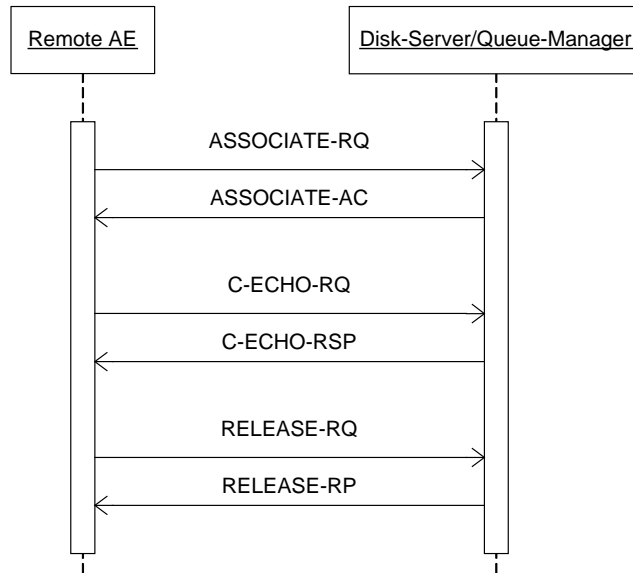

Figure 16: (Real World) Activity – Disk-Server/Queue-Manager (C-ECHO SCP)

Disk-Server/Queue-Manager performs the Verification Service Class by responding with C-ECHO-RSP.

4.2.2.4.1.2 Accepted Presentation Contexts

The presentation Contexts of the Disk-Server/Queue-Manager (C-ECHO) are defined in Table 41.

Table 41: Acceptable Presentation Contexts for (Real-World) Activity – Disk-Server/Queue-Manager (C-ECHO)

Presentation Context Table					
Abstract Syntax		Transfer Syntax		Role	Extended Negotiation
Name	UID	Name List	UID List		
Verification SOP Class	1.2.840.10008.1.1	ILE ELE EBE	1.2.840.10008.1.2 1.2.840.10008.1.2.1 1.2.840.10008.1.2.2	SCP	None

4.2.2.4.1.3 SOP Specific Conformance for SOP Classes

Disk-Server/Queue-Manager (C-ECHO) provides standard conformance to the DICOM V3.0.

Table 42: Disk-Server/Queue-Manager (C-ECHO) Status Response

Service Status	Code	Further Meaning	Description
Success	0000	Success	
Not Success	xxxx	<> 0000	Any of the return status is Not Success

4.2.2.4.2 (Real-World) Activity – Disk-Server (C-STORE SCP)

4.2.2.4.2.1 Description and Sequencing of Activities

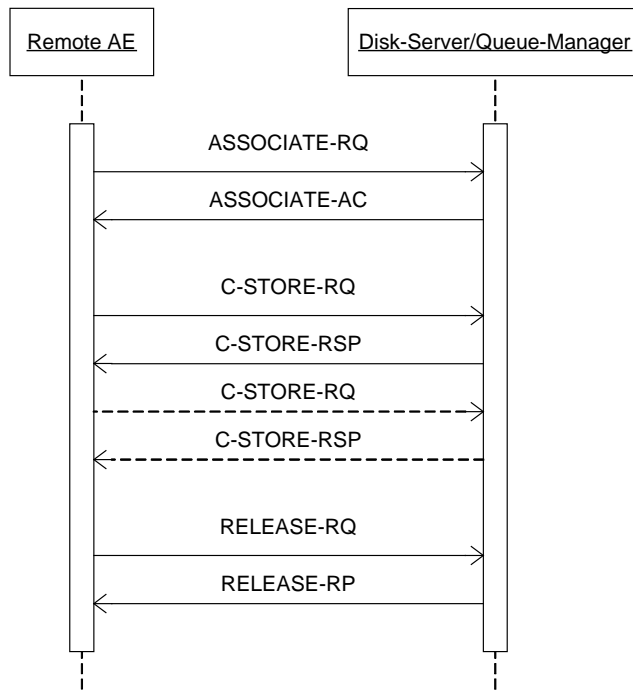

Figure 17: (Real World) Activity – Disk-Server/Queue-Manager (C-STORE SCP)

A remote system requests image storage from Disk-Server using the C-STORE command.

4.2.2.4.2.2 Accepted Presentation Contexts

The presentation Contexts of the Disk-Server/Queue-Manager (C-STORE) are defined in Table 43

Table 43: Acceptable Presentation Contexts for (Real-World) Activity – Disk-Server (C-STORE SCP)

Presentation Context Table					
Abstract Syntax		Transfer Syntax		Role	Extended Negotiation
Name	UID	Name List	UID List		
Computed Radiography Image Storage	1.2.840.10008.5.1.4.1.1.1	ILE	1.2.840.10008.1.2	SCP	None
		ELE	1.2.840.10008.1.2.1		
		EBE	1.2.840.10008.1.2.2		
Digital X-Ray Image Storage – for Presentation	1.2.840.10008.5.1.4.1.1.1.1	ILE	1.2.840.10008.1.2	SCP	None
		ELE	1.2.840.10008.1.2.1		
		EBE	1.2.840.10008.1.2.2		
Digital X-Ray Image Storage – for Processing	1.2.840.10008.5.1.4.1.1.1.1.1	ILE	1.2.840.10008.1.2	SCP	None
		ELE	1.2.840.10008.1.2.1		
		EBE	1.2.840.10008.1.2.2		
CT Image Storage	1.2.840.10008.5.1.4.1.1.2	ILE	1.2.840.10008.1.2	SCP	None
		ELE	1.2.840.10008.1.2.1		
		EBE	1.2.840.10008.1.2.2		
MR Image Storage	1.2.840.10008.5.1.4.1.1.4	ILE	1.2.840.10008.1.2	SCP	None
		ELE	1.2.840.10008.1.2.1		
		EBE	1.2.840.10008.1.2.2		
Secondary Capture Image Storage	1.2.840.10008.5.1.4.1.1.7	ILE	1.2.840.10008.1.2	SCP	None
		ELE	1.2.840.10008.1.2.1		
		EBE	1.2.840.10008.1.2.2		
General ECG-Waveform Storage	1.2.840.10008.5.1.4.1.1.9.1.2	ILE	1.2.840.10008.1.2	SCP	None
		ELE	1.2.840.10008.1.2.1		
		EBE	1.2.840.10008.1.2.2		
Grayscale Softcopy Presentation State Storage	1.2.840.10008.5.1.4.1.1.11.1	ILE	1.2.840.10008.1.2	SCP	None
		ELE	1.2.840.10008.1.2.1		
		EBE	1.2.840.10008.1.2.2		
X-Ray Angiographic Image Storage	1.2.840.10008.5.1.4.1.1.12.1	ILE	1.2.840.10008.1.2	SCP	None
		ELE	1.2.840.10008.1.2.1		
		EBE	1.2.840.10008.1.2.2		
X-Ray Radiofluoroscopic Image Storage	1.2.840.10008.5.1.4.1.1.12.2	ILE	1.2.840.10008.1.2	SCP	None
		ELE	1.2.840.10008.1.2.1		
		EBE	1.2.840.10008.1.2.2		
Nuclear Medicine Image Storage	1.2.840.10008.5.1.4.1.1.20	ILE	1.2.840.10008.1.2	SCP	None
		ELE	1.2.840.10008.1.2.1		
		EBE	1.2.840.10008.1.2.2		
Positron Emission Tomography Image Storage	1.2.840.10008.5.1.4.1.1.128	ILE	1.2.840.10008.1.2	SCP	None
		ELE	1.2.840.10008.1.2.1		
		EBE	1.2.840.10008.1.2.2		
RT Image Storage	1.2.840.10008.5.1.4.1.1.481.1	ILE	1.2.840.10008.1.2	SCP	None
		ELE	1.2.840.10008.1.2.1		
		EBE	1.2.840.10008.1.2.2		
RT Structure Set Storage	1.2.840.10008.5.1.4.1.1.481.3	ILE	1.2.840.10008.1.2	SCP	None
		ELE	1.2.840.10008.1.2.1		
		EBE	1.2.840.10008.1.2.2		
RT Plan Storage	1.2.840.10008.5.1.4.1.1.481.5	ILE	1.2.840.10008.1.2	SCP	None
		ELE	1.2.840.10008.1.2.1		
		EBE	1.2.840.10008.1.2.2		

4.2.2.4.2.3 SOP Specific Conformance for SOP Classes

Disk-Server conforms to the SOPs of the Storage Service Class at Level 2 (Full). In case of a successful C-STORE, the stored image may be accessed by the Disk-Server.

The user of the system, who can delete any image using the Archive Manager application, determines the duration of the storage. An auto-delete mechanism can be utilized to remove the least recently accessed images in order to make room for new ones. This mechanism is optional and is controlled by user configurable parameters.

Disk-Server will not coerce any attribute except for the following:
Pixel data (0x7FE0, 0x0010) of type OW is converted to OB when bits allocated (0x0028, 0x0100) equal 8.

All viewing applications can support only canonical form of images as follows:

Rescale Slope: 1
Rescale Intercept: -1000 or -1024
Bits Allocated: 16
Bits Stored: 12
High Bit: 11

All other images that are not in the canonical form will be translated to it.

If Disk-Server returns one of the following status codes, it means that the C-STORE has been unsuccessful. Recovery from this condition is the responsibility of the Disk-Server:

Table 44: Disk-Server C-STORE SCP Status Response

Service Status	Code	Further Meaning	Description
Success	0000	Success	Successful stored.
Failure	A700	General refusal status	
	A701	Out of disk space	
	C000	General failure status	
Warning	B000	General warning status	

4.2.2.4.3 (Real-World) Activity – Disk-Server (C-MOVE SCP)

4.2.2.4.3.1 Description and Sequencing of Activities

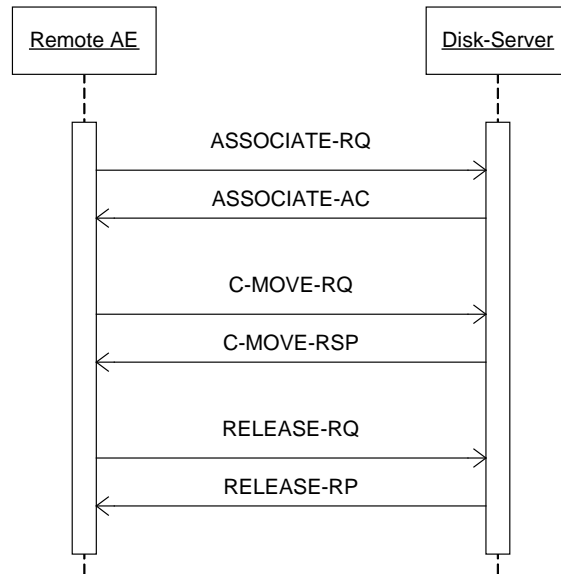

Figure 18: (Real World) Activity – Disk-Server (C-MOVE SCP)

The Real World activity associated with the C-MOVE command is retrieval of images from the disk and storage of the images to a remote system using a C-STORE command.

Disk-Server will issue a failure status if it is unable to process the transfer request

4.2.2.4.3.2 Proposed Presentation Contexts

Any of the Presentation Contexts show in Table 45 is acceptable to the Disk-Server (C-MOVE SCP).

Table 45: Proposed Presentation Contexts for <(Real-World) Activity – Disk-Server (C-MOVE SCP)

Presentation Context Table					
Abstract Syntax		Transfer Syntax		Role	Extended Negotiation
Name	UID	Name List	UID List		
Study Root Query/Retrieve Information Model - MOVE	1.2.840.10008.5.1.4.1.2.2.2	ILE ELE EBE	1.2.840.10008.1.2 1.2.840.10008.1.2.1 1.2.840.10008.1.2.2	SCP	None

4.2.2.4.3.3 SOP Specific Conformance for SOP Classes

Disk-Server provides standard conformance to the DICOM V3.0 Query/Retrieve Service Class as an SCP for the following SOP Class: Study Root Query/Retrieve Information Model - MOVE, UID=1.2.840.10008.5.1.4.1.2.2.2.

Prioritization of C-MOVE requests is not supported.

Disk-Server does not support relational C-MOVE requests.
All images requested in the C-MOVE will be sent over a single association (the association will not be established and torn down for each image).

All details regarding the specific conformance, including response behavior to all status codes, both from an application level and communication errors are provided in Table 46

Table 46: DICOM C-MOVE Command Response Status Handling Behavior

Service Status	Code	Further Meaning	Behavior
Success	0000	Matching complete	All other situations
Failure	A700	General refusal error	Storage Client failed or Storage client terminated (broken connection)
	A802	Refused – Move Destination Unknown	
	C000	General failure status	Number of sub operations completed =0 or sub operation failed > 0
Warning	B000	General warning status	Number of sub operations completed > 0 and sub operation failed > 0 or sub operation warning > 0 OR Number of sub operations completed = 0 and sub operations warning > 0 and sub operations failed > 0
Pending	FF00	Pending	For every store response we get

4.2.2.4.4 (Real-World) Activity – Disk-Server (C-FIND SCP)

4.2.2.4.4.1 Description and Sequencing of Activities

Figure 19: (Real World) Activity – Disk-Server (C-FIND SCP)

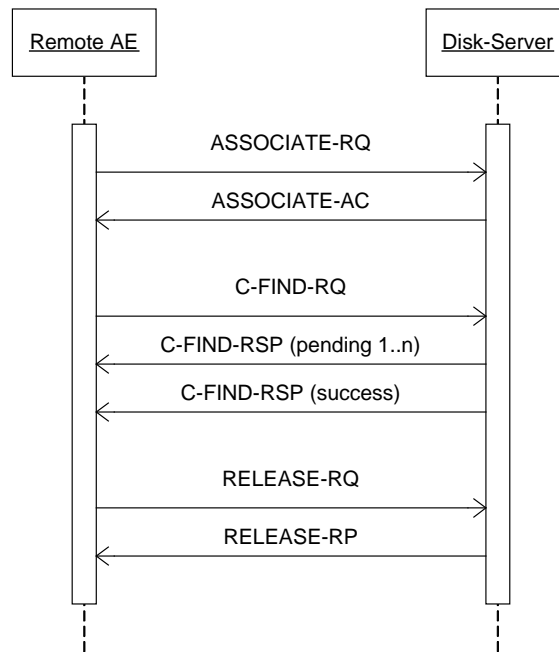

The Real World activity associated with the C-FIND command is an examination of the disk content. **Disk-Server** will issue a failure status if it is unable to process the query request.

4.2.2.4.2 Proposed Presentation Contexts

Any of the Presentation Contexts show in Table 47 is acceptable to the Disk-Server (C-FIND SCP).

Table 47: Proposed Presentation Contexts for <(Real-World) Activity – Disk-Server (C-FIND SCP)

Presentation Context Table					
Abstract Syntax		Transfer Syntax		Role	Extended Negotiation
Name	UID	Name List	UID List		
Study Root Query/Retrieve Information Model - MOVE	1.2.840.10008.5.1.4.1.2.2.2	ILE ELE EBE	1.2.840.10008.1.2 1.2.840.10008.1.2.1 1.2.840.10008.1.2.2	SCP	None

4.2.2.4.3 SOP Specific Conformance for SOP Classes

Disk-Server provides standard conformance to the DICOM V3.0 Query/Retrieve Service Class as an SCP for the following SOP Class: Study Root Query/Retrieve Information Model - FIND, UID=1.2.840.10008.5.1.4.1.2.2.1.

Disk-Server does not support Relational Search.

All Required (R) and Unique (U) Study, Series and Image level keys for the Study Root Query/Retrieve Information Model are supported. Disk-Server supports the following optional keys:

Table 48: Supported Query Keys

Query Level	Query Key			Type of Matching
	Name	Tag	VR	
Study	Patient's Name	0010,0010	PN	S, U, *
	Patient ID	0010,0020	LO	S, U
	Patient's Birth Date	0010,0030	DA	NONE
	Study Date	0008,0020	DA	R
	Study Time	0008,0030	TM	R
	Accession Number	0008,0050	IS	S, U
	Query/Retrieve Level	0008,0052	CS	S
	Retrieve AE Title	0008,0054	AE	-
	Modalities in Study	0008,0061	CS	NONE
	Referring Physician's Name	0008,0090	PN	NONE
	Study Description	0008,1030	LO	NONE
	Study Instance UID	0020,000D	UI	S, U, R
	Study ID	0020,0010	SH	NONE
	Number of Study Related Series	0020,1206	IS	NONE
	Number of Study Related Images	0021,1208	IS	NONE
Series	Modality	0008,0060	CS	S, U
	Series Instance UID	0020,000E	UI	S, U
	Series Number	0020,0011	IS	S, U
	Gantry/Detector Tilt	0018,1120	DS	NONE
	Rows	0028,0010	US	NONE
	Columns	0028,0011	US	NONE
Image	Image Type	0008,0008	CS	NONE
	Instance Creation Date	0008,0012	DA	NONE
	Instance Creation Time	0008,0013	TM	NONE
	SOP Class UID	0008,0016	UI	S, U
	SOP Instance UID	0008,0018	UI	S, U
	Content Date	0008,0023	DA	NONE
	Content Time	0008,0033	TM	NONE
	Acquisition Number	0020,0012	IS	NONE
	Instance Number	0020,0013	IS	S, U
	Image Position	0020,0032	DS	NONE
	Image Orientation	0020,0037	DS	NONE
	Frame Of Reference UID	0020,0052	UI	NONE
	Slice Location	0020,1041	DS	NONE
	Pixel Spacing	0028,0030	DS	NONE
	Bits Allocated	0028,0100	US	NONE

The column Type of Matching of the table should be read as follows:

The types of Matching supported by the C-Find SCP. A "S" indicates the identifier attribute can specify Single Value Matching, a "R" will indicate Range Matching, a "*" will denote wildcard matching (**Note:** the system does NOT support matching using the "?")

question mark character), an “U” will indicate universal matching, and “L” will indicate that UID lists are supported for matching. “NONE” indicates that no matching is supported, but that values for this element in the database can be returned.

Unsupported fields will not be returned in the C-FIND response.

C-FIND-CANCEL is supported. However, some C-FIND responses may be forwarded before the C-FIND-CANCEL takes effect.

All details regarding the specific conformance, including response behavior to all status codes, both from an application level and communication errors are provided in Table 49

Table 49: DICOM C-MOVE Command Response Status Handling Behavior

Service Status	Code	Further Meaning	Behavior
Success	0000	Matching complete	Transaction is removed from the Queue manager
Failure	A700	General refusal error	Queue Manager states: “Refused: Out of resources”
	C000	General failure status	Queue Manager states: “Failed: Store failed”
Warning	B000	General warning status	Queue Manager states: “Failed: X success, X warn, X fail” (“X” Depending of the Number of Completed, Failed and Warning Sub operations received from the remote storage system)
Cancel	FE00	Cancel	*

4.2.3 Archive-Manager Specifications

4.2.3.1 SOP Classes

This Application Entity provides Standard Conformance to the following SOP Classes.

Table 50: SOP Classes for Archive-Manager

SOP Class Name	SOP Class UID	SCU	SCP
Verification SOP Class	1.2.840.10008.1.1	Yes	No
Study Root Query/Retrieve Information Model - FIND	1.2.840.10008.5.1.4.2.2.1	Yes	No

4.2.3.2 Association Policies

4.2.3.2.1 General

The maximum PDU size that the Archive-Manager will use is configurable, with a minimum of 2 Kbytes.

Table 51: DICOM Application Context

Application Context Name	1.2.840.10008.3.1.1.1
--------------------------	-----------------------

4.2.3.2.2 Number of Associations

Archive-Manager can have multiple simultaneous connections. The maximal number of simultaneous associations that will be initiated by Archive-Manager is limited by the configuration of the system. Archive-Manager will not initiate more than one association per each AE configured as an SCP in the system.

Table 52: Number of Associations as an Association Initiator for Archive Manager

Maximum number of simultaneous associations	1
---	---

Table 53: Number of Associations as an Association Acceptor for Archive Manager

Maximum number of simultaneous associations	0
---	---

4.2.3.2.3 Asynchronous Nature

Archive-Manager will only allow a single outstanding operation on an association.

Table 54: Asynchronous Nature as an Association Initiator for Archive Manager

Maximum number of outstanding asynchronous transactions	1
---	---

4.2.3.2.4 Implementation Identifying Information

The value supplied for Implementation Class UID shall be documented here. If a version name is supplied, this fact shall be documented here. Policies defining the values supplied for version name may be stated here.

Table 55: DICOM Implementation Class and Version for Archive Manager

Implementation Class UID	1.2.840.113704.7.0.2
Implementation Version Name	MxView-3.5

4.2.3.3 Association Initiation Policy

This describes the conditions under which the AE will initiate an association. The behavior of the AE during association rejection is summarized in Table 56

Table 56: DICOM Association Rejection Handling

Result	Source	Reason/Diagnosis	Behavior
1 – rejected-permanent	1 – DICOM UL service-user	1 – no-reason-given	Message on screen in popup
		2 – application-context-name-not-supported	Message on screen in popup
		3 – calling-AE-title-not-recognized	Message on screen in popup
		7 – called-AE-title-not-recognized	Message on screen in popup
	2 – DICOM UL service-provider (ACSE related function)	1 – no-reason-given	Message on screen in popup
2 – protocol-version-not-supported		Message on screen in popup	

Result	Source	Reason/Diagnosis	Behavior
	3 – DICOM UL service-provider (presentation related function)	1 – temporary-congestion	Message on screen in popup
		2 – local-limit-exceeded	Message on screen in popup

4.2.3.3.1 (Real-World) Activity – Archive-Manager C-FIND (SCU)

4.2.3.3.1.1 Description and Sequencing of Activities

Archive-Manager initiates an association when the user clicks on one of the icons in the devices tool-bar.
 The Archive-Manager searches (C-FIND) by study level following by Series level. The association remains open until the user explicitly closes it by clicking again on the device icon - the Query will be closed with a C-Release

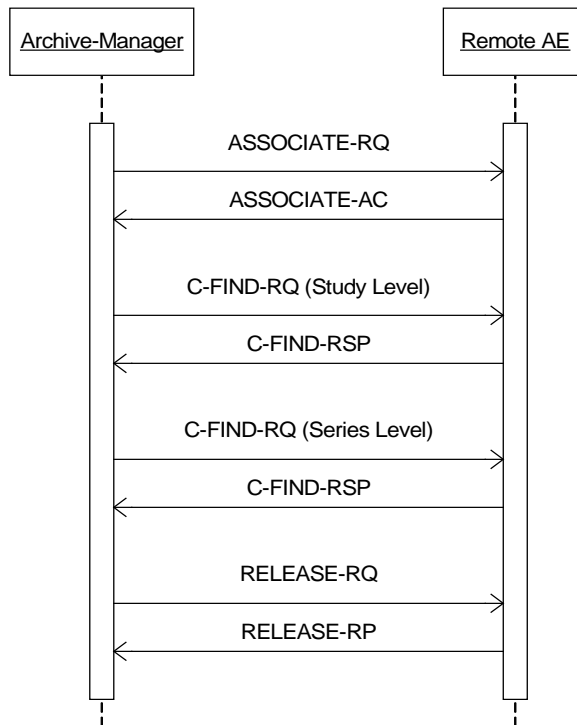

Figure 20: (Real World) Activity – Archive-Manager C-FIND (SCU)

4.2.3.3.1.2 Proposed Presentation Contexts

Each time an association is initiated, the association initiator proposes a number of presentation contexts to be used on that association. In this subsection, the presentation contexts proposed by Archive-Manager for (Real-World) Activity – Archive-Manager C-FIND (SCU) are defined in Table 57

Table 57: Proposed Presentation Contexts for (Real-World) Activity – Archive-Manager C-FIND (SCU)

Presentation Context Table					
Abstract Syntax		Transfer Syntax		Role	Extended Negotiation
Name	UID	Name List	UID List		
Study Root Query /Retrieve Information Model - FIND	1.2.840.10008.5.1.4.1.2.2.1	ILE ELE EBE	1.2.840.10008.1.2 1.2.840.10008.1.2.1 1.2.840.10008.1.2.2	SCU	None

4.2.3.3.1.3 SOP Specific Conformance for SOP Classes

The Archive-Manager provides standard conformance to the DICOM V3.0. The Archive-Manager supports the following Study and Series level attributes. Sub-selection on the received list of patients after query will be done on the local memory.

Table 58: Supported Study and Series Query Level Attributes

Query Level	Query Key			Value	Type of matching
	Name	Tag	VR		
Study	Specific Character Set	0008,0005	CS	None	None
	Study Date	0008,0020	DA	User Input	S, U, R
	Study Time	0008,0030	TM		None
	Query/Retrieve Level	0008,0052	CS	STUDY	S
	Modalities in Study	0008,0061	CS	User Input	S
	Referring Physician's Name *	0008,0090	PN	User Input	S, U, *
	Study Description	0008,1030	LO	User Input	S, U, *
	Patient's Name *	0010,0010	PN	User Input	S, U, *
	Patient ID	0010,0020	LO	User Input	S, U, *
	Patient's Birth Date	0010,0030	DA		None
	Patient's Sex	0010,0040	CS		None
	Study Instance UID	0020,000D	UI		None
	Study ID	0020,0010	SH		None
	Number of Study Related Series	0020,1206	IS		None
	Number of Study Related Images	0020,1208	IS		None
Series	Query/Retrieve Level	0008,0052	CS	SERIES	S
	Modality	0008,0060	CS		None
	Series Description	0008,103E	LO		None
	Protocol Name	0018,1030	LO		None
	Study Instance UID	0020,000D	UI	Parent Study	None
	Series Instance UID	0020,000E	UI		None
	Series Number	0020,0011	IS		None

Query Level	Query Key			Value	Type of matching
	Name	Tag	VR		
	Number of Series Related Instances	0020,1209	IS		None
	Performed Procedure Step Start Date	0040,0244	DA		None
	Performed Procedure Step Start Time	0040,0245	TM		None
	Request Attributes Sequence	0040,0275	SQ	Empty sequence	None

* Note: In name filters, the space character “ ” is converted to a caret “^” as name delimiter.

The column Type of Matching of the table should be read as follows:

The types of Matching supported by the C-FIND SCP. A “S” indicates the identifier attribute can specify Single Value Matching, a “R” will indicate Range Matching, a “*” will denote wildcard matching, an “U” will indicate universal matching, and “L” will indicate that UID lists are supported for matching. “NONE” indicates that no matching is supported, but that values for this element in the database can be returned.

All details regarding the specific conformance, including response behavior to all status codes, both from an application level and communication errors are provided in Table 59

Table 59: DICOM C-FIND Command Response Status Handling Behavior

Service Status	Code	Further Meaning	Behavior
Success	0000	Success	Matching successful.
Failure	A700	Refused	Out of Resources
	A900	Failed	Unknown reason
	C000	Failed	Unknown reason

4.2.3.3.2 (Real-World) Activity – Archive-Manager C-ECHO (SCU)

4.2.3.3.2.1 Description and Sequencing of Activities

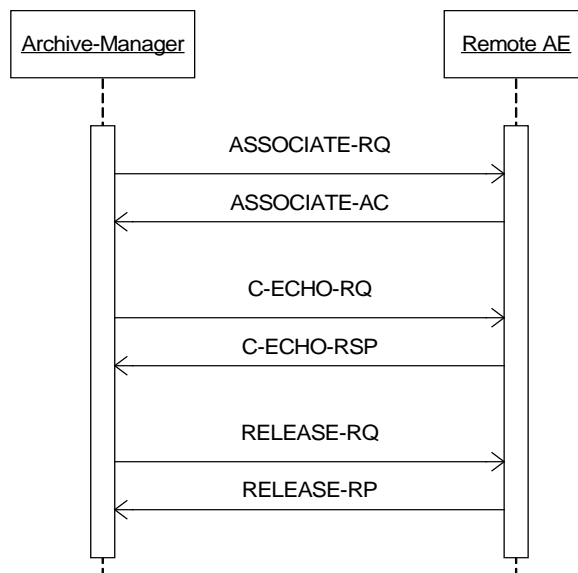

Figure 21: (Real World) Activity – Archive-Manager C-ECHO (SCU)

Archive-Manager initiates an association when the user points to one of the icons in the devices tool-bar, clicks the right mouse button and selects “Verify Connection” operation.

4.2.3.3.2 Proposed Presentation Contexts

Each time an association is initiated, the association initiator proposes a number of presentation contexts to be used on that association. In this subsection, the presentation contexts proposed by Archive-Manager for (Real-World) Activity – Archive-Manager C-ECHO (SCU) are defined in Table 60

Table 60: Proposed Presentation Contexts for (Real-World) Activity – Archive-Manager C-ECHO (SCU)

Presentation Context Table					
Abstract Syntax		Transfer Syntax		Role	Extended Negotiation
Name	UID	Name List	UID List		
Verification SOP Class	1.2.840.10008.1.1	ILE ELE EBE	1.2.840.10008.1.2 1.2.840.10008.1.2.1 1.2.840.10008.1.2.2	SCU	None

4.2.3.3.2.3 SOP Specific Conformance for SOP Classes

Archive-Manager provides standard conformance to the DICOM V3.0. All details regarding the specific conformance, including response behavior to all status codes, both from an application level and communication errors are provided in Table 61

Table 61: DICOM C-ECHO (SCU) Command Response Status Handling Behavior

Service Status	Code	Further Meaning	Behavior
Success	0000	Success	The SCU has successful send C-ECHO.
*	*	<> 0000	

4.2.3.4 Association Acceptance Policy

Archive-Manager never accepts an association.

4.2.4 Memory-Manager Specifications

4.2.4.1 SOP Classes

This Application Entity provides Standard Conformance to the following SOP Classes.

Table 62: SOP Classes for Memory-Manager

SOP Class Name	SOP Class UID	SCU	SCP
Study Root Query/Retrieve Information Model - Move	1.2.840.10008.5.1.4.1.2.2.2	Yes	No

4.2.4.2 Association Policies

4.2.4.2.1 General

The maximum PDU size that the Memory-Manager will use is configurable, with a minimum of 2 Kbytes.

Table 63: DICOM Application Context

Application Context Name	1.2.840.10008.3.1.1.1
--------------------------	-----------------------

4.2.4.2.2 Number of Associations

Memory-Manager can have multiple simultaneous connections. The maximal number of simultaneous associations that will be initiated by Memory-Manager is limited by the configuration of the system. Memory-Manager will not initiate more than one association per each AE configured as an SCP in the system.

Table 64: Number of Associations as an Association Initiator for Memory-Manager

Maximum number of simultaneous associations	Unlimited
---	-----------

Table 65: Number of Associations as an Association Acceptor for Memory-Manager

Maximum number of simultaneous associations	0
---	---

4.2.4.2.3 Asynchronous Nature

Memory-Manager will only allow a single outstanding operation on an association.

Table 66: Asynchronous Nature as an Association Initiator for Memory-Manager

Maximum number of outstanding asynchronous transactions	1
---	---

4.2.4.2.4 Implementation Identifying Information

The value supplied for Implementation Class UID shall be documented here. If a version name is supplied, this fact shall be documented here. Policies defining the values supplied for version name may be stated here.

Table 67: DICOM Implementation Class and Version for Memory-Manager

Implementation Class UID	1.2.840.113704.7.0.2
Implementation Version Name	MxView-3.5

4.2.4.3 Association Initiation Policy

This describes the conditions under which the AE will initiate an association.

The behavior of the AE during association rejection is summarized in Table 10.

Table 68: DICOM Association Rejection Handling

Result	Source	Reason/Diagnosis	Behavior
1 – rejected-permanent	1 – DICOM UL service-user	1 – no-reason-given	Popup message: “Connection establishment to (X*) was permanently rejected. Rejection reason is: No reason given”.
		2 – application-context-name-not-supported	Popup message: “Connection establishment to (X*) was permanently rejected. Rejection reason is: Application context name not supported”.
		3 – Calling AE-title-not-recognized	Popup message: “Connection establishment to (X*) was permanently rejected. Rejection reason is: Calling AE title not recognized”.
		7 – called-AE-title-not-recognized	Popup message: “Connection establishment to (X*) was permanently rejected. Rejection reason is: Called AE title not recognized”.
	2 – DICOM UL service-provider (ACSE related function)	1 – no-reason-given	Popup message: “Connection establishment to (X*) was permanently rejected. Rejection reason is: No reason given”.
		2 – protocol-version-not-supported	Popup message: “Connection establishment to (X*) was permanently rejected. Rejection reason is: Protocol version not supported”.
	3- DICOM UL service-provider (Presentation related function)	1-temporary-congestion	Popup message: “Connection establishment to (X*) was permanently rejected. Rejection reason is: temporary congestion”.
		2 local-limit-exceeded	Popup message: “Connection establishment to (X*) was permanently rejected. Rejection reason is: local-limit-exceeded”.

* “X” stands for the name of the remote device

4.2.4.3.1 (Real-World) Activity – Memory-Manager C-MOVE (SCU)**4.2.4.3.1.1 Description and Sequencing of Activities**

Memory-Manager initiates an association when an image processing application asks for image loading from a specified source device using a proprietary IPC protocol.

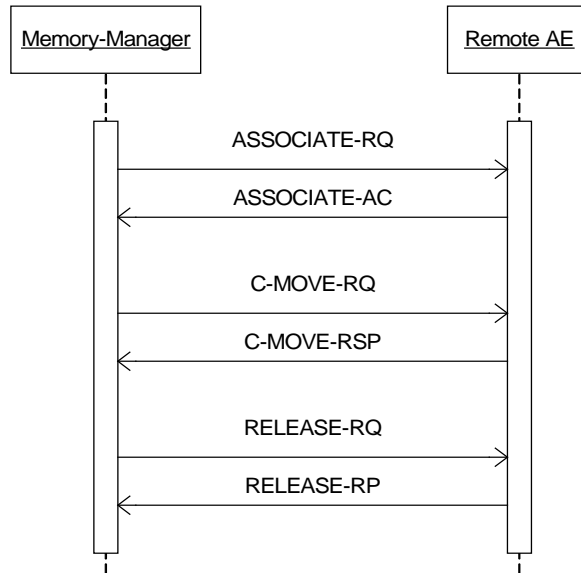

Figure 22: (Real World) Activity – Memory-Manager C-MOVE (SCU)

4.2.4.3.1.2 Proposed Presentation Contexts

Each time an association is initiated, the association initiator proposes a number of presentation contexts to be used on that association. In this subsection, the presentation contexts proposed by Memory-Manager for (Real-World) Activity – Memory-Manager C-MOVE (SCU) are defined in Table 69.

Table 69: Proposed Presentation Contexts for (Real-World) Activity – Memory-Manager C-MOVE (SCU)

Presentation Context Table					
Abstract Syntax		Transfer Syntax		Role	Extended Negotiation
Name	UID	Name List	UID List		
Study Root Query/Retrieve Information Model - MOVE	1.2.840.10008.5.1.4.1.2.2.2	ILE ELE EBE	1.2.840.10008.1.2 1.2.840.10008.1.2.1 1.2.840.10008.1.2.2	SCU	None

4.2.4.3.1.3 SOP Specific Conformance for SOP Classes

Memory-Manager provides standard conformance to the DICOM V3.0 Query/Retrieve Service Class as an SCU for the SOP Class Study Root Query/Retrieve Information Model – Move.

All details regarding the specific conformance, including response behavior to all status codes, both from an application level and communication errors are provided in Table 70.

Table 70: DICOM C-MOVE Command Response Status Handling Behavior

Service Status	Code	Further Meaning	Behavior
Success	0000	Success	Storage successful.
Failure	A701	Refused – Out of Resources	Message by transfer result – Refused Unknown reason
	A702	Refused – Out of Resources	Message by transfer result – Refused Store Failed
	A801	Refused – Move Destination Unknown	Message by transfer result – Refused Unknown target
	A900	Error – Identifier Does Not Match SOP Class	Message by transfer result – Failed Unknown reason
	C000	Error – Unable to Process	Message by transfer result – Failed Store Failed
Warning	B000	Coercion of Data Elements	Message by transfer result – 0 Success, 1 Warn, 0 Fail
Cancel	FE00	Cancel	Message by transfer result – Refused Connection closed on timeout.

4.2.4.4 Association Acceptance Policy

Memory-Manager never accepts an association.

4.2.5 Memory-Server Specifications

4.2.5.1 SOP Classes

This Application Entity provides Standard Conformance to the following SOP Classes.

Table 71: SOP Classes for Memory-Server

SOP Class Name	SOP Class UID	SCU	SCP
Computed Radiography Image Storage	1.2.840.10008.5.1.4.1.1.1	No	Yes
Digital X-Ray Image Storage – for Presentation	1.2.840.10008.5.1.4.1.1.1.1	No	Yes
Digital X-Ray Image Storage – for Processing	1.2.840.10008.5.1.4.1.1.1.1.1	No	Yes
CT Image Storage	1.2.840.10008.5.1.4.1.1.2	No	Yes
MR Image Storage	1.2.840.10008.5.1.4.1.1.4	No	Yes
Secondary Capture Image Storage	1.2.840.10008.5.1.4.1.1.7	No	Yes
General ECG Waveform Storage	1.2.840.10008.5.1.4.1.1.9.1.2	No	Yes
Grayscale Softcopy Presentation State Storage *	1.2.840.10008.5.1.4.1.1.11.1	No	Yes
X-Ray Angiographic Image Storage *	1.2.840.10008.5.1.4.1.1.12.1	No	Yes
X-Ray Radiofluoroscopic Image Storage	1.2.840.10008.5.1.4.1.1.12.2	No	Yes
Nuclear Medicine Image Storage *	1.2.840.10008.5.1.4.1.1.20	No	Yes
Positron Emission Tomography Image Storage *	1.2.840.10008.5.1.4.1.1.128	No	Yes
RT Image Storage *	1.2.840.10008.5.1.4.1.1.481.1	No	Yes
RT Structure Set Storage *	1.2.840.10008.5.1.4.1.1.481.3	No	Yes
RT Plan Storage *	1.2.840.10008.5.1.4.1.1.481.5	No	Yes
Verification SOP Class	1.2.840.10008.1.1	No	Yes

*Note: Mark as * SOP Class images are not supported for viewing, only supported for storage.*

4.2.5.2 Association Policies

4.2.5.2.1 General

The maximum PDU size that the Memory-Server will use is configurable, with a minimum of 2 Kbytes.

Table 72: DICOM Application Context

Application Context Name	1.2.840.10008.3.1.1.1
--------------------------	-----------------------

4.2.5.2.2 Number of Associations

The number of simultaneous associations that will be accepted by Memory-Server is limited only by the kernel parameters of the underlying TCP/IP implementation. Memory-Server will spawn a new process for each connection request it receives. Therefore, Memory-Server can have multiple simultaneous connections, and there are no inherent limitations on the number of simultaneous associations that the Application Entity represented by Memory-Server can maintain.

Table 73: Number of Associations as an Association Initiator for Memory-Server

Maximum number of simultaneous associations	0
---	---

Table 74: Number of Associations as an Association Acceptor for Memory-Server

Maximum number of simultaneous associations	Kernel Limit
---	--------------

4.2.5.2.3 Asynchronous Nature

Memory-Server will only allow a single outstanding operation on an association

Table 75: Asynchronous Nature as an Association Initiator for Memory-Server

Maximum number of outstanding asynchronous transactions	1
---	---

4.2.5.2.4 Implementation Identifying Information

The value supplied for Implementation Class UID shall be documented here. If a version name is supplied, this fact shall be documented here. Policies defining the values supplied for version name may be stated here.

Table 76: DICOM Implementation Class and Version for Memory-Server

Implementation Class UID	1.2.840.113704.7.0.2
Implementation Version Name	MxView-3.5

4.2.5.3 Association Initiation Policy

Memory-Server never initiates an association.

4.2.5.4 Association Acceptance Policy

Memory-Server places no limits on the number of simultaneous connections it will support. However, it is possible to control that may connect to Memory-Server during the system's configuration process.

The AE association rejection policies are summarized in Table 77

Table 77: DICOM Association Rejection Policies

Result	Source	Reason/Diagnosis	Behavior
1 – rejected-permanent	1 – DICOM UL service-user	2 – application-context-name-not-supported	Message on screen
		7 – called-AE-title-not-recognized	Message on screen
	2 – DICOM UL service-provider (ACSE related function)	2 – protocol-version-not-supported	Message on screen

4.2.5.4.1 (Real-World) Activity – Memory Server C-STORE (SCP)**4.2.5.4.1.1 Description and Sequencing of Activities**

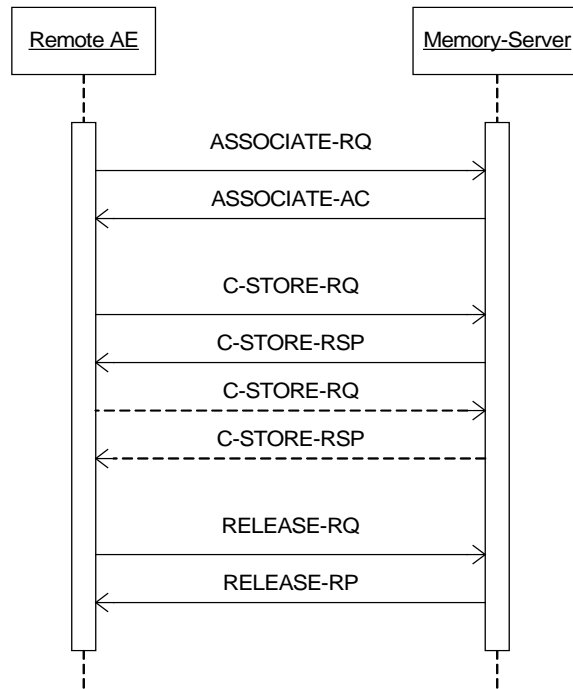

Figure 23: (Real World) Activity – Memory-Server C-STORE (SCP)

The real world activity associated with the C-STORE operation is the storage of the image in the memory of the system upon which Memory-Server is running in order to make it available for immediate processing by applications. Memory-Server will issue a failure status if it is unable to store the image in the memory.

4.2.5.4.1.2 Accepted Presentation Contexts

Any of the Presentation Contexts shown in Table 78 is acceptable to the Memory-Server C-STORE as SCP.

Table 78: Acceptable Presentation Contexts for (Real-World) Activity – Memory-Server C-STORE (SCP)

Presentation Context Table					
Abstract Syntax		Transfer Syntax		Role	Extended Negotiation
Name	UID	Name List	UID List		
Computed Radiography Image Storage	1.2.840.10008.5.1.4.1.1.1	ILE ELE EBE	1.2.840.10008.1.2 1.2.840.10008.1.2.1 1.2.840.10008.1.2.2	SCP	None
Digital X-Ray Image Storage – for Presentation	1.2.840.10008.5.1.4.1.1.1.1	ILE ELE EBE	1.2.840.10008.1.2 1.2.840.10008.1.2.1 1.2.840.10008.1.2.2	SCP	None
Digital X-Ray Image Storage – for Processing	1.2.840.10008.5.1.4.1.1.1.1.1	ILE ELE EBE	1.2.840.10008.1.2 1.2.840.10008.1.2.1 1.2.840.10008.1.2.2	SCP	None
CT Image Storage	1.2.840.10008.5.1.4.1.1.2	ILE ELE EBE	1.2.840.10008.1.2 1.2.840.10008.1.2.1 1.2.840.10008.1.2.2	SCP	None

Presentation Context Table					
Abstract Syntax		Transfer Syntax		Role	Extended Negotiation
Name	UID	Name List	UID List		
MR Image Storage	1.2.840.10008.5.1.4.1.1.4	ILE ELE EBE	1.2.840.10008.1.2 1.2.840.10008.1.2.1 1.2.840.10008.1.2.2	SCP	None
Secondary Capture Image Storage	1.2.840.10008.5.1.4.1.1.7	ILE ELE EBE	1.2.840.10008.1.2 1.2.840.10008.1.2.1 1.2.840.10008.1.2.2	SCP	None
X-Ray Radiofluoroscopic Image Storage	1.2.840.10008.5.1.4.1.1.12.2	ILE ELE EBE	1.2.840.10008.1.2 1.2.840.10008.1.2.1 1.2.840.10008.1.2.2	SCP	None
Nuclear Medicine Image Storage	1.2.840.10008.5.1.4.1.1.20	ILE ELE EBE	1.2.840.10008.1.2 1.2.840.10008.1.2.1 1.2.840.10008.1.2.2	SCP	None

4.2.5.4.1.3 SOP Specific Conformance for SOP Classes

Memory-Server provides standard conformance to the DICOM V3.0 Storage Service Class as a SCP.

Memory-Server conforms to the SOPs of the Storage Service Class at Level 2 (Full). In case of a successful C-STORE, the stored image may be accessed by the processing applications

The user determines the duration of the storage.

If the Memory-Server returns one of the following status codes, it means that the C-Store has been unsuccessful.

Table 79: Memory-Server C-STORE (SCP) Status Response

Service Status	Code	Further Meaning	Description
Success	0000	Successful	Successful. storage
Failure	A700	Refused	General refusal status
	C000	Failed	General failure status

4.2.5.4.2 (Real-World) Activity – Memory-Server C-ECHO

4.2.5.4.2.1 Description and Sequencing of Activities

Description and Sequencing of Activities

A remote system requests verification from Memory-Server using the C-ECHO command.

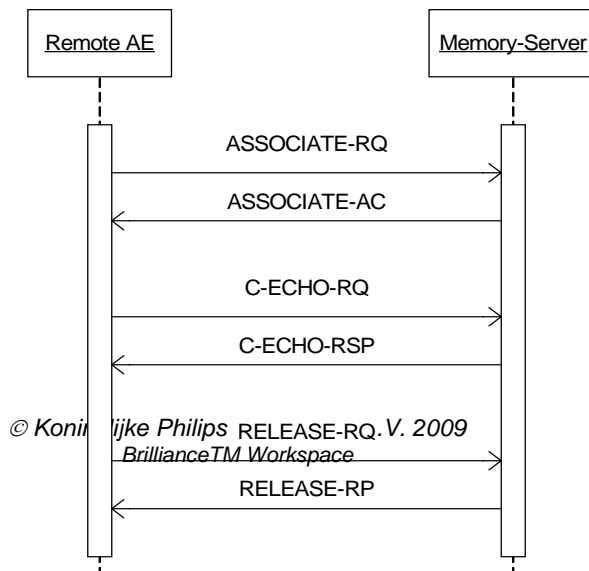

Figure 24: (Real World) Activity – Memory-Server C-ECHO**4.2.5.4.2.2 Accepted Presentation Contexts**

Any of the presentation contexts shown in Table 80 is acceptable to Memory-Server C-ECHO.

Table 80: Acceptable Presentation Contexts for <(Real-World) Activity – Memory-Server C-ECHO

Presentation Context Table					
Abstract Syntax		Transfer Syntax		Role	Extended Negotiation
Name	UID	Name List	UID List		
Verification SOP Class	1.2.840.10008.1.1	ILE ELE EBE	1.2.840.10008.1.2 1.2.840.10008.1.2.1 1.2.840.10008.1.2.2	SCU	None

4.2.5.4.2.3 SOP Specific Conformance for SOP Classes

Memory-Server C-ECHO provides standard conformance to the DICOM V3.0 verification SOP Class.

The behavior of an Application Entity SOP class is summarized as shown in Table 81. The standard as well as the manufacturer specific status codes and their corresponding behavior shall be specified.

Table 81: Memory Server C-ECHO Status Response

Service Status	Code	Further Meaning	Description
Success	0000	Success	C-ECHO command was successful received
*	*	<> 0000	Error by receiving C-ECHO

4.2.6 Print-Manager Specifications

4.2.6.1 SOP Classes

This Application Entity provides Standard Conformance to the following SOP Classes.

Table 82: SOP Classes for Print-Manager

SOP Class Name	SOP Class UID	SCU	SCP
Basic Grayscale Print Management (Meta)	1.2.840.10008.5.1.1.9	Yes	No
>Basic Film Box SOP Class	1.2.840.10008.5.1.1.2	Yes	No
>Basic Film Session SOP Class	1.2.840.10008.5.1.1.1	Yes	No
>Basic Grayscale Image Box SOP Class	1.2.840.10008.5.1.1.4	Yes	No
>Printer SOP Class	1.2.840.10008.5.1.1.16	No	No
Basic Color Print Management (Meta)	1.2.840.10008.5.1.1.18	Yes	No
>Basic Film Box SOP Class	1.2.840.10008.5.1.1.2	Yes	No
>Basic Film Session SOP Class	1.2.840.10008.5.1.1.1	Yes	No
>Basic Color Image Box SOP Class	1.2.840.10008.5.1.1.4.1	Yes	No
>Printer SOP Class	1.2.840.10008.5.1.1.16	No	No
Print Job SOP Class	1.2.840.10008.5.1.1.14	Yes	No

4.2.6.2 Association Policies

4.2.6.2.1 General

The maximum PDU Size that the Print-Manager will use is configurable, with a minimum of 2 Kbytes.

Table 83: DICOM Application Context

Application Context Name	1.2.840.10008.3.1.1.1
--------------------------	-----------------------

4.2.6.2.2 Number of Associations

Print-Manager can have only one open connection at a given time.

Table 84: Number of Associations as an Association Initiator for Print-Manager

Maximum number of simultaneous associations	1
---	---

Table 85: Number of Associations as an Association Acceptor for Print-Manager

Maximum number of simultaneous associations	0
---	---

4.2.6.2.3 Asynchronous Nature

Print-Manager will only allow a single outstanding operation on an association.

Table 86: Asynchronous Nature as an Association Initiator for Print-Manager

Maximum number of outstanding asynchronous transactions	1
---	---

4.2.6.2.4 Implementation Identifying Information

The value supplied for Implementation Class UID and Version Name is documented here.

Table 87: DICOM Implementation Class and Version for Print-Manager

Implementation Class UID	1.2.840.113704.7.0.2
Implementation Version Name	MxView-3.5

4.2.6.3 Association Initiation Policy

4.2.6.3.1 (Real-World) Activity – Print Manager>

4.2.6.3.1.1 Description and Sequencing of Activities

Print-Manager initiates an association when the user selects a new printer or when the system is started, the film pre-viewer is initialised and an association to the default printer is initiated. In case of printer selection, the previous association is closed.

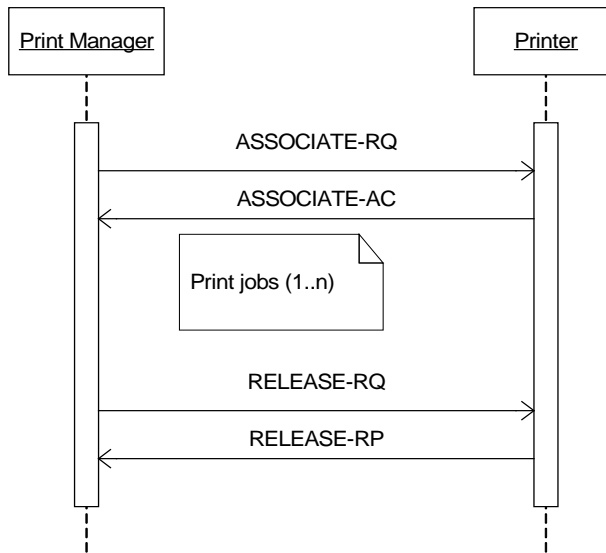

Figure 25: (Real World) Activity – Print-Manager Initiates

By printing of one or more images in a print job the association will not be closed at the end of the print job. A next print job used the same association. Switch of printer closed the association also a TCP/IP connection timeout closed the connection. Then a new association will be set up. Normally the Print-Manager does not closed the connection with a A-RELEASE-RQ after a print job.

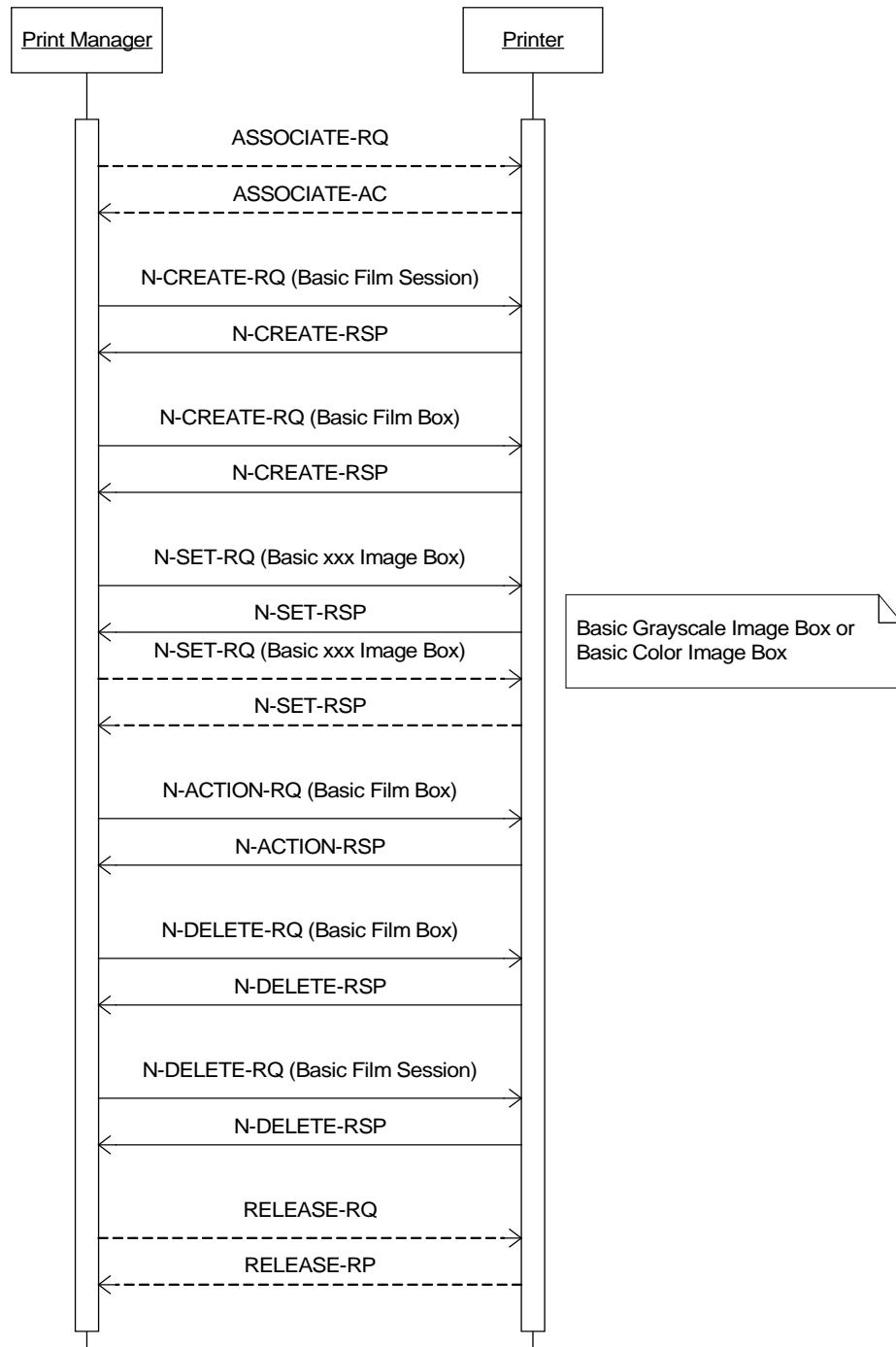

Figure 26: (Real World) Activity – Print-Manager

4.2.6.3.1.2 Proposed Presentation Contexts

Each time an association is initiated, the association initiator proposes a number of presentation contexts to be used on that association. In this subsection, the

presentation contexts proposed by Print-Manager for (Real-World) Activity – Print Image are defined in Table 88

Table 88: Proposed Presentation Contexts for (Real-World) Activity – Print Image

Presentation Context Table					
Abstract Syntax		Transfer Syntax		Role	Extended Negotiation
Name	UID	Name List	UID List		
Basic Grayscale Print Management (Meta)	1.2.840.10008.5.1.1.9	ILE ELE EBE	1.2.840.10008.1.2 1.2.840.10008.1.2.1 1.2.840.10008.1.2.2	SCU	None
Basic Color Print Management (Meta)	1.2.840.10008.5.1.1.18	ILE ELE EBE	1.2.840.10008.1.2 1.2.840.10008.1.2.1 1.2.840.10008.1.2.2	SCU	None
Print Job SOP Class	1.2.840.10008.5.1.1.14	ILE ELE EBE	1.2.840.10008.1.2 1.2.840.10008.1.2.1 1.2.840.10008.1.2.2	SCU	None

Recommended abbreviations to be used for the following printer tables are:

ALWAYS	the module or attribute shall always be present with value
ANAP	Attribute Not Always Present
VNAP	Value Not Always Present (attribute sent zero length if no value is present)
EMPTY	Attribute is sent without a value
MAYBE	the module may be present under specified condition
OPTIONAL	the module may be available, depending on source object
AUTO	the attribute value is generated automatically
CONF	the attribute value source is a configurable parameter

4.2.6.3.1.3 SOP Specific Conformance Basic Film Session SOP Class

The Printer process conforms to the Basic Film Session Sop Class.
The following DIMSE service element is supported:

N-CREATE
N-DELETE

The following table lists the supported attributes for the N-CREATE DIMSE.

Table 89: Basic Film Session Presentation Module

Attribute Name	Tag	VR	Value	Presence of Value	Source
Number of Copies	2000,0010	IS	1..20	ALWAYS	CONF
Print Priority	2000,0020	CS	Printer configuration	ALWAYS	CONF
Medium Type	2000,0030	CS	Printer configuration	ALWAYS	CONF
Film Destination	2000,0040	CS	Printer configuration	ALWAYS	CONF

The behavior on successful and unsuccessful transfer is given in the table below.

Table 90: DICOM Command Response Status Handling Behavior for Basic Film Session N-CREATE

Service Status	Error Code	Further Meaning	Behavior
Success	0000	Film Session successfully created	The print job continues
*	B600	Memory Allocation not supported	The print job continues and the warning is logged

Table 91: DICOM Command Response Status Handling Behavior for Basic Film Session N-DELETE

Service Status	Error Code	Further Meaning	Behavior
Success	0000	Film Session successfully created	The SCP has completed the operation successfully
*		<> 0000	.

4.2.6.3.1.4 SOP Specific Conformance Basic Film Box SOP Class

The Printer process conforms to the Basic Film Box Sop Class.
The following DIMSE service elements are supported:

N-CREATE
N-ACTION
N-DELETE

The following table lists the supported attributes for the N-CREATE DIMSE

Table 92: Basic Film Box Presentation Module

Attribute Name	Tag	VR	Value	Presence of Value	Source
Image Display Format	2010,0010	ST	Printer configuration	ALWAYS	CONF
Film Orientation	2010,0040	CS	PORTRAIT; LANDSCAPE	ALWAYS	CONF
Film Size ID	2010,0050	CS	Printer configuration	ALWAYS	CONF

Table 93: Basic Film Box Relationship Module

Attribute Name	Tag	VR	Value	Presence of Value	Source
Referenced Film Session Sequence	2010,0500	SQ		ALWAYS	AUTO
>Referenced SOP Class UID	0008,1150	UI	UID of Parent Film Session	ALWAYS	AUTO
>Referenced SOP Instance UID	0008,1155	UI		ALWAYS	AUTO

The behavior on successful and unsuccessful transfer is given in the table below.

Table 94: DICOM Command Response Status Handling Behavior for Basic Film Box N-CREATE

Service Status	Error Code	Further Meaning	Behavior
Success	0000	Film Box successfully created	The SCP has completed the operation successfully.
Warning	B605	Requested Min Density or Max Density outside of Printer's operating Range	The print job continues and the warning is logged.
Failure	C616	There is an existing Film Box that has not been printed	The print job is marked as failed and the reason is logged.

N-ACTION DIMSE does not create any Data Set Attributes.
The behavior on successful and unsuccessful transfer is given in the table below.

Table 95: DICOM Command Response Status Handling Behavior for Basic Film Box N-ACTION

Service Status	Error Code	Further Meaning	Behavior
Success	0000	Film accepted for printing	The print job continues.
Warning	B603	Film Box SOP Instance Hierarchy does not contain Image Box SOP Instances	The print job continues and the warning is logged and reported to the user.
	B604	Image Size is larger than Image Box Size – The Image has been de-magnified	The print job continues and the warning is logged and reported to the user.
	B609	Image Size is larger than Image Box Size – The Image has been cropped to fit	The print job continues and the warning is logged and reported to the user.
	B60A	Image Size or combined Print Image Size is larger than Image Box Size – The Image or combined Print Image has been decimated to fit	The print job continues and the warning is logged and reported to the user.
Failure	C602	Unable to create Print Job SOP Instance – Print Queue is full	The print job is marked as failed and the reason is logged and reported to the user.
	C603	Image Size is larger than Image Box Size	The print job is marked as failed and the reason is logged and reported to the user.
	C613	Combined Print Image Size is larger than Image Box Size	The print job is marked as failed and the reason is logged and reported to the user.

N-DELETE DIMSE does not create any Data Set Attributes.
The behavior on successful and unsuccessful transfer is given in the table below.

Table 96: DICOM Command Response Status Handling Behavior for Basic Film Box N-DELETE

Service Status	Error Code	Further Meaning	Behavior
Success	0000	Film Session successfully created	The SCP has completed the operation successfully
*		<> 0000	.

4.2.6.3.1.5 SOP Specific Conformance Basic Grayscale Image Box SOP Class

The Printer process conforms to the Basic Grayscale Image Box Sop Class.
The following DIMSE service element is supported:

N-SET

The following table lists the supported attributes for the N-SET DIMSE

Table 97: Basic Grayscale Image Box SOP Class - N-SET-RQ - Pixel Presentation Module

Attribute Name	Tag	VR	Value	Presence of Value	Source
Image Position	2020,0010	US	1	ALWAYS	AUTO
Polarity	2020,0020	CS	Printer configuration	ALWAYS	AUTO
Basic Grayscale Image Sequence	2020,0110	SQ		ALWAYS	AUTO
>Samples per Pixel	0028,0002	US	1	ALWAYS	AUTO
>Photometric Interpretation	0028,0004	CS	MONOCHROME2	ALWAYS	AUTO
>Rows	0028,0010	US		ALWAYS	CONF
>Columns	0028,0011	US		ALWAYS	CONF
>Pixel Aspect Ratio	0028,0034	IS		ALWAYS	CONF
>Bits Allocated	0028,0100	US	8, 16	ALWAYS	AUTO
>Bits Stored	0028,0101	US	8,12	ALWAYS	CONF
>High Bit	0028,0102	US	7,11	ALWAYS	AUTO
>Pixel Representation	0028,0103	US	0	ALWAYS	AUTO
>Pixel Data	7FE0,0010	OB/OW		ALWAYS	AUTO

The behavior on successful and unsuccessful transfer is given in the table below.

Table 98: DICOM Command Response Status Handling Behavior for Basic Grayscale Image Box N-SET

Service Status	Error Code	Further Meaning	Behavior
Success	0000	Image successfully stored in Image Box	The print job continues.
Warning	B604	Image Size is larger than Image Box Size – The Image has been de-magnified	The print job continues and the warning is logged and reported to the user.
	B605	Requested Min Density or Max Density outside of Printer's operating Range	The print job continues and the warning is logged and reported to the user.
	B609	Image Size is larger than Image Box Size – The Image has been cropped to fit	The print job continues and the warning is logged and reported to the user.
	B60A	Image Size or combined Print Image Size is larger than Image Box Size – The Image or combined Print Image has been decimated to fit	The print job continues and the warning is logged and reported to the user.
Error	C603	Image Size is larger than Image Box Size	The print job is marked as failed and the reason is logged and reported to the user
	C605	Insufficient Memory in Printer to store the Image	The print job is marked as failed and the reason is logged and reported to the user

Service Status	Error Code	Further Meaning	Behavior
	C613	Combined Print Image Size is larger than Image Box Size	The print job is marked as failed and the reason is logged and reported to the user

4.2.6.3.1.6 SOP Specific Conformance Basic Color Image Box SOP Class

The Printer process conforms to the Basic Grayscale Image Box Sop Class.
The following DIMSE service element is supported:

N-SET

The following table lists the supported attributes for the N-SET DIMSE

Table 99: Basic Color Image Box SOP Class - N-SET-RQ - Pixel Presentation Module

Attribute Name	Tag	VR	Value	Presence of Value	Source
Image Position	2020,0010	US	1	ALWAYS	AUTO
Polarity	2020,0020	CS	Printer configuration	ALWAYS	AUTO
Basic Color Image Sequence	2020,0111	SQ		ALWAYS	AUTO
>Samples per Pixel	0028,0002	US	3	ALWAYS	AUTO
>Photometric Interpretation	0028,0004	CS	RGB	ALWAYS	AUTO
>Planar Configuration	0028,0006	US	0,1	ALWAYS	CONF
>Rows	0028,0010	US		ALWAYS	CONF
>Columns	0028,0011	US		ALWAYS	CONF
>Pixel Aspect Ratio	0028,0034	IS		ALWAYS	CONF
>Bits Allocated	0028,0100	US	8	ALWAYS	AUTO
>Bits Stored	0028,0101	US	8	ALWAYS	CONF
>High Bit	0028,0102	US	7	ALWAYS	AUTO
>Pixel Representation	0028,0103	US	0	ALWAYS	AUTO
>Pixel Data	7FE0,0010	OW		ALWAYS	AUTO

The behavior on successful and unsuccessful transfer is given in the Table 100

Table 100: DICOM Command Response Status Handling Behavior for Basic Color Image Box N-SET

Service Status	Further Meaning	Error Code	Behavior
Success	0000	Image successfully stored in Image Box	The print job continues.
Warning	B604	Image Size is larger than Image Box Size – The Image has been de-magnified	The print job continues and the warning is logged and reported to the user.
	B605	Requested Min Density or Max Density outside of Printer's operating Range	The print job continues and the warning is logged and reported to the user.
	B609	Image Size is larger than Image Box Size – The Image has been cropped to fit	The print job continues and the warning is logged and reported to the user.
	B60A	Image Size or combined Print Image Size is larger than Image Box Size – The Image or combined Print Image has been decimated to fit	The print job continues and the warning is logged and reported to the user.
Error	C603	Image Size is larger than Image Box Size	The print job is marked as failed and the reason is logged and reported to the user.
	C605	Insufficient Memory in Printer to store the Image	The print job is marked as failed and the reason is logged and reported to the user.
	C613	Combined Print Image Size is larger than Image Box Size	The print job is marked as failed and the reason is logged and reported to the user.

4.2.6.4 Association Acceptance Policy

Print-Manager never accepts an association.

4.2.7 StorageComm-Manager Specifications

4.2.7.1 SOP Classes

This Application Entity provides Standard Conformance to the following SOP Classes.

Table 101: SOP Classes for StorageComm-Manager

SOP Class Name	SOP Class UID	SCU	SCP
Storage Commitment Push Model SOP Class	1.2.840.10008.1.20.1	Yes	No
Verification SOP Class	1.2.840.10008.1.1	No	Yes

4.2.7.2 Association Policies

4.2.7.2.1 General

The maximum PDU size, which the StorageComm-Manager will use, is configurable, with a minimum of 2 Kbytes.

Table 102: DICOM Application Context

Application Context Name	1.2.840.10008.3.1.1.1
--------------------------	-----------------------

4.2.7.2.2 Number of Associations

The number of simultaneous associations that will be accepted by StorageComm-Manager is limited only by the kernel parameters of the underlying TCP/IP implementation. StorageComm-Manager will spawn a new process for each connection request it receives. Therefore, StorageComm-Manager can have multiple simultaneous connections, and there are no inherent limitations on the number of simultaneous associations that the Application Entity represented by StorageComm-Manager can maintain.

Table 103: Number of Associations as an Association Initiator for StorageComm-Manager

Maximum number of simultaneous associations	Kernel Limited
---	----------------

Table 104: Number of Associations as an Association Acceptor for StorageComm-Manager

Maximum number of simultaneous associations	No limit
---	----------

4.2.7.2.3 Asynchronous Nature

StorageComm-Manager will only allow a single outstanding operation on an association.

Table 105: Asynchronous Nature as an Association Initiator for StorageComm-Manager

Maximum number of outstanding asynchronous transactions	1
---	---

4.2.7.2.4 Implementation Identifying Information

The value supplied for Implementation Class UID and Version Name is documented here.

Table 106: DICOM Implementation Class and Version for StorageComm-Manager

Implementation Class UID	1.2.840.113704.7.0.2
Implementation Version Name	MxView-3.5

4.2.7.3 Association Initiation Policy

This describes the conditions under which the AE will initiate an association.

The behavior of the AE during association rejection is summarized in Table 107

Table 107: DICOM Association Rejection Handling

Result	Source	Reason/Diagnosis	Behavior
1 – rejected-permanent	1 – DICOM UL service-user	1 – no-reason-given	Message to user: "Connection establishment to '\$\$\$' was permanently rejected. Rejection reason is: No reason given."
		2 – application-context-name-not-supported	Message to user: "Connection establishment to '\$\$\$' was permanently rejected. Rejection reason is: Application context name not supported."
		3 – calling-AE-title-not-recognized	Message to user: "Connection establishment to '\$\$\$' was permanently rejected. Rejection reason is: Calling AE Title not recognized."
		7 – called-AE-title-not-recognized	Message to user: "Connection establishment to '\$\$\$' was permanently rejected. Rejection reason is: Called AE Title not recognized."
	2 – DICOM UL service-provider (ACSE related function)	1 – no-reason-given	Message to user: "Connection establishment to '\$\$\$' was permanently rejected. Rejection reason is: No reason given."
		2 – protocol-version-not-supported	Message to user: "Connection establishment to '\$\$\$' was permanently rejected. Rejection reason is: Protocol version not supported."
	3 – DICOM UL service-provider (presentation related function)	1 – temporary-congestion	Message to user: "Connection establishment to '\$\$\$' was permanently rejected. Rejection reason is: Temporary congestion."
2 – local-limit-exceeded		Message to user: "Connection establishment to '\$\$\$' was permanently rejected. Rejection reason is: Local limit exceeded."	
2 – rejected-transient	1 – DICOM UL service-user	1 – no-reason-given	Message to user: "Connection establishment to '\$\$\$' was temporarily rejected. Rejection reason is: No reason given."

Result	Source	Reason/Diagnosis	Behavior
		2 – application-context-name-not-supported	Message to user: "Connection establishment to '\$\$\$' was permanently rejected. Rejection reason is: No reason given."
		3 – calling-AE-title-not-recognized	Message to user: "Connection establishment to '\$\$\$' was permanently rejected. Rejection reason is: Application context name not supported."
		7 – called-AE-title-not-recognized	Message to user: "Connection establishment to '\$\$\$' was permanently rejected. Rejection reason is: Calling AE Title not recognized."
	2 – DICOM UL service-provider (ACSE related function)	1 – no-reason-given	Message to user: "Connection establishment to '\$\$\$' was permanently rejected. Rejection reason is: Called AE Title not recognized."
		2 – protocol-version-not-supported	Message to user: "Connection establishment to '\$\$\$' was permanently rejected. Rejection reason is: No reason given."
	3 – DICOM UL service-provider (presentation related function)	1 – temporary-congestion	Message to user: "Connection establishment to '\$\$\$' was permanently rejected. Rejection reason is: Protocol version not supported."
		2 – local-limit-exceeded	Message to user: "Connection establishment to '\$\$\$' was permanently rejected. Rejection reason is: Temporary congestion."

4.2.7.3.1 (Real-World) Activity – StorageComm-Manager

4.2.7.3.1.1 Description and Sequencing of Activities

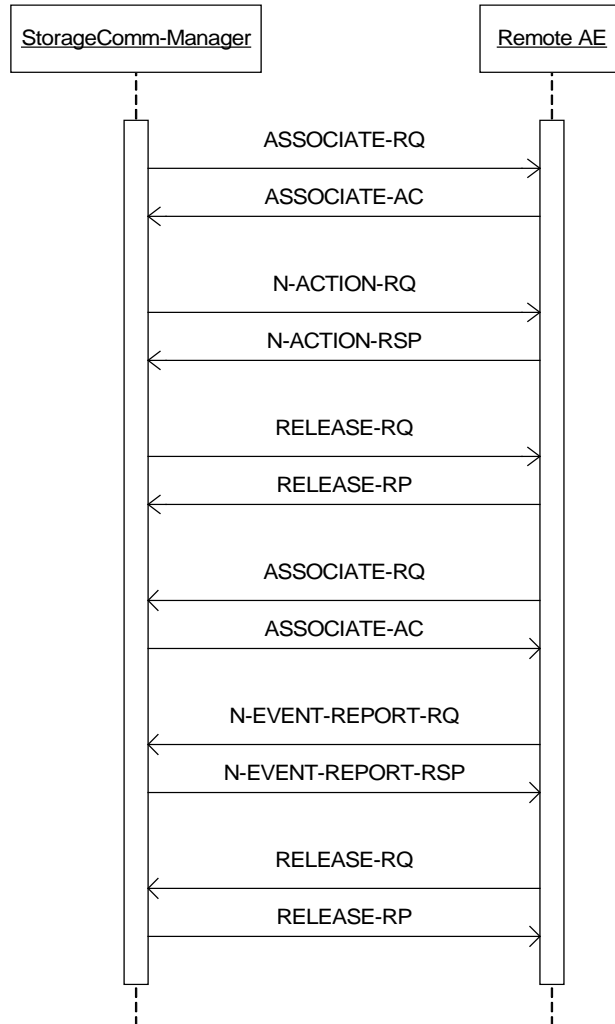

Figure 27: (Real World) Activity – StorageComm-Manager (SCU)

StorageComm-Manager will attempt to initiate a new association when requested to commit the images that were stored on the remote device, which support the storage Commitment Service.

The associated real world activity N-ACTION is a response about successful completion of storage request from the remote storage device.

The associated real world activity N-EVENT-REPORT operation is the completion of the storage commitment by the remote device. StorageComm-Manager will issue a failure status if it is unable to handle in proper way the storage commitment report event.

4.2.7.3.1.2 Proposed Presentation Contexts

Each time an association is initiated, the association initiator proposes a number of presentation contexts to be used on that association. In this subsection, the presentation contexts proposed by StorageComm-Manager for (Real-World) Activity – StorageComm-Manager are defined in Table 108.

Table 108: Proposed Presentation Contexts for (Real-World) Activity – StorageComm-Manager

Presentation Context Table					
Abstract Syntax		Transfer Syntax		Role	Extended Negotiation
Name	UID	Name List	UID List		
Storage Commitment Push Model Sop Class	1.2.840.1.20.1	ILE ELE EBE	1.2.840.10008.1.2 1.2.840.10008.1.2.1 1.2.840.10008.1.2.2	SCU	None

4.2.7.3.1.3 SOP Specific Conformance for SOP Classes

StorageComm-Manager provides standard conformance to the DICOM V3.0 Storage Commitment Service Class using Push Model as an SCU.

Multiple N-ACTION requests can be performed over a single association. Multiple N-EVENT-REPORT requests can be accepted over a single association.

After all N-ACTION requests that are waiting in the stack are issued, association will be closed with the timeout of 60 seconds.

A remote system reports about storage commitment completion using N-EVENT-REPORT command.

All details regarding the specific conformance, including response behavior to all status codes, both from an application level and communication errors are provided in Table 109 for N-ACTION and in Table 111 for N-EVENT-REPORT

Table 109: DICOM N-ACTION Command Response Status Handling Behavior

Service Status	Code	Further Meaning	Behavior
Success	0000	Success	The request for storage comment is considered successfully stored
*	*	<> 0000	The association is aborted and the request for storage comments is marked as failed.

Table 110: Storage Commitment N-EVENT-REPORT Behavior

Event Type Name	Event Type ID	Behavior
Storage Commitment Request Successful	1	Successfully committed SOP Instances are marked as “transferred” and are candidates for automatic (configurable) deletion from the local database if local resources become scarce.
Storage Commitment Request Complete – Failures Exist	2	The Failure Reasons are logged

Table 111: DICOM N-EVENT-REPORT Command Response Status Handling Behavior

Service Status	Code	Further Meaning	Behavior
Success	0000	Success	The storage commitment result has been successfully received.
Failure	0211	Unrecognized Operation	The transaction UID in the N-EVENT-REPORT request is not recognized..
	0213	Resource Limitation	The Transaction UID in the N-EVENT-REPORT request has expired.
	0113	No Such Event Type	An invalid Event Type ID was supplied in the N-EVENT-REPORT.
	0110	Processing Failure	An internal error occurred during processing
	0115	Invalid Argument Value	One of more SOP Instance UIDs with the Referenced SOP Sequence (0008.1199) or Failed SOP Sequence (0008,1198) was not included in the Storage Commitment Request associated with this Transaction UID.

4.2.7.4 Association Acceptance Policy

Each AE specification contains a description of the association acceptance policies of the AE. This describes the conditions under which the AE will accept an association.

The AE association rejection policies are summarized in Table 112.

Table 112: DICOM Association Rejection Policies

Result	Source	Reason/Diagnosis	Behavior
1 – rejected-permanent	1 – DICOM UL service-user	2 – application-context-name-not-supported	Sends A-ASSOCIATE-RJ Message Result: 1 (Rejected-permanent) Source: 1 (DICOM UL service-user) Reason: 2 (application-context-name-not-supported)
		7 – called-AE-title-not-recognized	Sends A-ASSOCIATE-RJ Message Result: 1 (Rejected-permanent) Source: 1 (DICOM UL service-user) Reason: 7 (called-AE-title-not-recognized)
	2 – DICOM UL service-provider (ACSE related function)	2 – protocol-version-not-supported	Sends A-ASSOCIATE-RJ Message Result: 1 (Rejected-permanent) Source: 2 (DICOM UL service-provider (ACSE related function)) Reason: 2 (protocol-version-not-supported)

4.2.7.4.1 (Real-World) Activity – StorageComm-Manager (C-ECHO)

4.2.7.4.1.1 Description and Sequencing of Activities

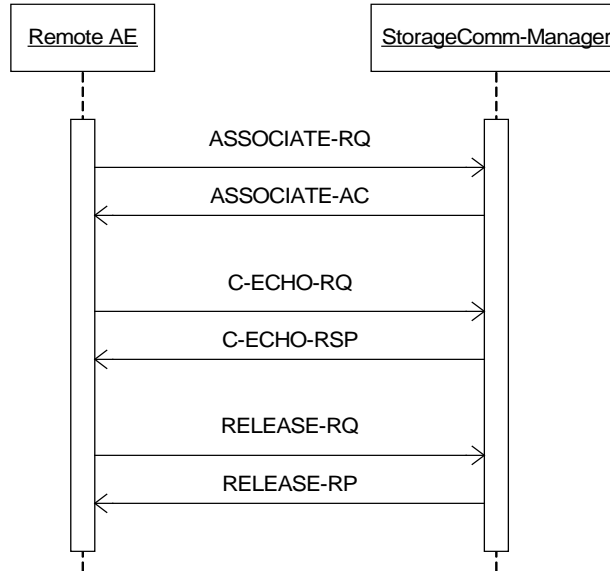

Figure 28: (Real World) Activity – StorageComm-Manager (C-ECHO SCP)

StorageComm-Manager performs the Verification Service Class by responding with C-ECHO-RSP.

4.2.7.4.1.2 Accepted Presentation Contexts

The presentation Contexts of the StorageComm-Manager (C-ECHO) are defined in Table 41.

Table 113: Acceptable Presentation Contexts for (Real-World) Activity – StorageComm-Manager (C-ECHO)

Presentation Context Table					
Abstract Syntax		Transfer Syntax		Role	Extended Negotiation
Name	UID	Name List	UID List		
Verification SOP Class	1.2.840.10008.1.1	ILE ELE EBE	1.2.840.10008.1.2 1.2.840.10008.1.2.1 1.2.840.10008.1.2.2	SCP	None

4.2.7.4.1.3 SOP Specific Conformance for SOP Classes

StorageComm-Manager (C-ECHO) provides standard conformance to the DICOM V3.0.

Table 114: StorageComm-Manager (C-ECHO) Status Response

Service Status	Code	Further Meaning	Description
Success	0000	Success	
Not Success	xxxx	<> 0000	Any of the return status is Not Success

4.3 Network Brilliance™ Workspace Interfaces

4.3.1 Physical Network Interface

The Workspace application provides DICOM V3.0 TCP/IP Network Communication Support as defined in Part 8 of [DICOM].

Brilliance™ Workspace inherits its TCP/IP stack from Windows XP (i.e. the operating system platform).

Brilliance™ Workspace supports a single network interface: Ethernet ISO.8802-3. With standard supported physical medium include:

- IEEE 802.3 10BASE-TX
- IEEE 802.3 100BASE-TX (Fast Ethernet)
- IEEE 802.3 1000BASE-X (Fiber Optic Gigabit Ethernet).

4.3.2 Additional Protocols

Additional protocols such as used for network management are listed here.

4.4 Configuration

The Brilliance™ Workspace system is configured by means of a configuration program. This program is accessible at start-up of the Brilliance™ Workspace system. It is password protected and intended to be used by Philips Customer Support Engineers or administrator only.

4.4.1 AE Title/Presentation Address Mapping

This mapping (including IP and port numbers) is defined during the system Networking Procedure.

Configurable are the parameters:

- Calling AE Titles
- Called AE Titles
- Maximum PDU size
- Disable arbitrary transfer syntaxes to be proposed at the association negotiation
- Disable generation of Icon Image sequence
- Disable generation of DICOM overlays (“burn-in” instead)

4.4.1.1 Local AE Titles

The local AE title mapping and configuration shall be specified. The default AE titles are based on the system host name defined by the service engineer as part of the system configuration. The following table shall be used:

Table 115: AE Title Configuration Table

Application Entity	Default AE Title	Default TCP/IP Port
Disk-Server/Queue-Manager	<hostname> <hostname>TMP <hostname><localfolder>	104
Archive-Manager	<hostname>	
Memory-Manager	<hostname>	
Memory-Server	<hostname>RMI	104
Print-Manager	<hostname>	
Dent act-Print	<hostname>	
StorageComm-Manager	<hostname>COMM	104
Patient-Catalog Server	<hostname>	

4.4.1.2 Remote AE Title/Presentation Address Mapping

Remote AE Title, IP-Address and Port-number are free configurable for the Philips Customer Support Engineers or administrator.

4.4.2 Parameters

The specification of important operational parameters, their default value and range (if configurable) is specified here.

Table 116: Configuration Parameters table

Parameter	Configurable	Default Value
General Parameters		
Release Timeout	No	30 seconds
AE Specific Parameters		
Port-Number	Yes	104
Maximum PDU size the AE can receive	Yes	16378
Maximum PDU size the AE can send	Yes	16378
Transfer Syntax support, ILE, ELE, EBE	No	ILE, ELE, EBE
Storage / Retrieve Timeout	No	5 Minutes

Printers are configurable by a selection of the default printer types. Every printer types has a fixed configuration, but can be extended with new ones. The configuration of the printer is depended of the filling of the default printer types files.

5 MEDIA INTERCHANGE

5.1 Implementation Model

AE Provides Standard Conformance to the DICOM Media Storage Service and File Format (PS 3.10) and the Media Storage Application Profiles (PS 3.11)

5.1.1 Application Data Flow Diagram

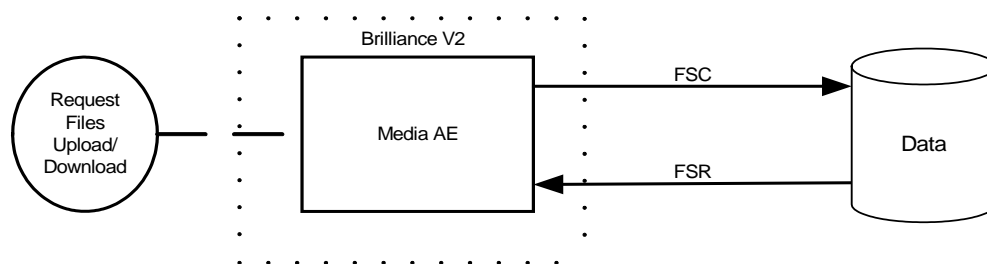

Figure 29: Media Interchange Application Data Flow Diagram

The Media AE will act as a FSR when reading the directory of the medium. The Media AE will act as a FSC when writing the selected images in a patient folder onto the CD-R medium.

5.1.2 Functional Definitions of AE's

The Media AE is the one and only application entity within Brilliance™ Workspace. It includes the following service class.

Media Storage Service Class

The Media AE can perform the Media Storage service as SCU, with capabilities for RWA Display Directory (as FSR), RWA Write Images(as FSC), and RWA Read Images (as FSR). The Brilliance™ Workspace can create and read CD-R and read CD.

5.1.3 Sequencing of Real World Activities

The Media AE can only create a new CD-R. After filling the CD-R the image can be read back by the Brilliance™ Workspace.

5.1.4 File Meta Information for Implementation Class and Version

Default the Version Name is MXVCDR but is configurable.

Table 117: DICOM Implementation Class and Version for Media AE

Implementation Class UID	1.2.840.113704.7.0.2
Implementation Version Name	MXVCDR (CD), MXVCD (CD-R)

5.2 AE Specifications

5.2.1 Media AE - Specification

The supported Application Profiles, their Roles and the Service Class options, all defined in DICOM terminology, are listed in the following table.

Table 118: AE Related Application Profiles, Real-World Activities, and Roles

Supported Application Profile	Real-World Activity	Roles	SC Option
CT/MR studies on CD-R	Write Images	FSC	Interchange
	Read Images	FSR	Interchange

5.2.1.1 File Meta Information for the Media AE

The Application Entity title is registered into the DICOM File Meta Information header and is supported by the CD-writer (CD write option) acting as a FSC.

5.2.1.2 Real-World Activities

The SOP instances provided by the RWA are written to the CD-R media and a corresponding DICOMDIR is created.

5.2.1.2.1 Display Directory

When a database open action is initiated on the CD-R then the Media AE acts as an FSR using the interchange option to read the DICOMDIR of the CD or CD-R media.

This will result in an overview of the patients, studies, series and images on the Brilliance™ Workspace screen.

5.2.1.2.1.1 Media Storage Application Profile

As depicted in Table 118, the Media AE supports the RWA Display Directory for the Application Profile.

The mandatory DICOMDIR keys are required for the correct display of directory information. The display is structured according the DICOM Composite Information Model: Patient, Study, Series, and Image.

5.2.1.2.2 Write Images

When an image transfer to CD-R is initiated then the Media AE acts as an FSC using the interchange option to export SOP Instances from the local database to a CD-R medium.

5.2.1.2.2.1 Media Storage Application Profile

As depicted in Table 118, the Media AE supports the RWA Write Images for the Application Profile.

The DICOMDIR file will be extended when new images are written. In case some attributes are not present in an image but are specified as mandatory in the DICOMDIR definition in DICOM Media, a generated value will be filled in.

Implementation remarks and restrictions

When writing the DICOMDIR records, key values are generated when no value of the corresponding attribute is supplied, according to the following tables.

Table 119: Generated Keys

Key	Tag	Generated Value
Study Keys		
Study Date	(0008,0020)	Current date
Study Time	(0008,0030)	Current time
Series Keys		
Series Number	(0020,0011)	1
Image Keys		
Instance Number	(0020,0013)	1

Brilliance™ Workspace can write a maximum volume of the media to that media. No request for new media is done. By more volume then the media a device error is given.

5.2.1.3 DICOMDIR keys**Table 120: Supported attributes in the DICOMDIR**

Dicom Tag	Description
0002:0001	File Meta Information Version
0002:0002	UI Media Storage Sop Class UID
0002:0003	UI Media Storage Sop Instance UID
0002:0010	UI Transfer Syntax UID
0002:0012	UI Implementation Class UID
0004:1130	File Set ID
0004:1200	First Directory Record Offset
0004:1202	Last Directory Record Offset
0004:1212	File Set Consistency Flag
0004:1220	Directory Record Sequence
0004:1400	Offset Of The Next Dir Record
0004:1410	Record In Use Flag
0004:1420	Offset Of Ref Lower Level Dir Ent
0004:1430	Directory Record Type
0010:0010	Patient's Name
0010:0020	Patient ID
0004:1400	Offset Of The Next Dir Record
0004:1410	Record In Use Flag
0004:1420	Offset Of Ref Lower Level Dir Ent
0004:1430	Directory Record Type
0004:1500	Referenced File ID
0008:0020	Study Date
0008:0030	Study Time
0008:0050	Accession Number
0008:1030	Study Description
0010:0010	Patient's Name
0010:0020	Patient ID
0020:000D	Study Instance UID
0020:0010	Study ID
0020:1206	Number Of Study Related Series
0020:1208	Number Of Study Related Images

Dicom Tag	Description
07A1:0010	Implementor ID
07A1: 1001	Number Of Series In Study
07A1: 1003	Last Update Time
07A1: 1004	Last Update Date
07A1: 1014	Protection Flag
0004:1400	Offset Of The Next Dir Record
0004:1410	Record In Use Flag
0004:1420	Offset Of Ref Lower Level Dir Ent
0004:1430	Directory Record Type
0004:1500	Referenced File ID
0008:0060	Modality
0018:1030	Protocol Name
0020:000E	Series Instance UID
0020:0011	Series Number
0020:1209	Number of Series Related Instances
07A1:0010	Implementor ID
07A1: 1002	Number Of Images In Series
07A1: 1003	Last Update Time
07A1: 1004	Last Update Date
0004:1400	Offset Of The Next Dir Record
0004:1410	Record In Use Flag
0004:1420	Offset Of Ref Lower Level Dir Ent
0004:1430	Directory Record Type
0004:1500	Referenced File ID
0004:1510	Referenced Sop Class UID In File
0004:1511	Ref Sop Instance UID In File
0004:1512	Referenced Transfer Syntax UID in FILE
0008:0008	Image Type
0008:0012	Instance Creation Date
0008:0013	Instance Creation Time
0008:0016	SOP Class UID
0008:0018	SOP Instance UID
0008:0023	Image Date
0008:0033	Image Time
0018:0010	Contrast/Bolus Agent
0018:1120	Gantry/Detector Tilt
0020:0013	Image Number
0020:0052	Frame of Reference UID
0020:1041	Slice Location
0028:0002	Samples per Pixels
0028:0010	Rows
0028:0011	Columns
0028:0100	Bits Allocated
07A1:0010	Implementor ID
00E1: 1040	Image Label

5.2.1.3.1 Read Images

When an image transfer from CD or CD-R is initiated then the Media AE acts as an FSR using the interchange option to import SOP Instances from the CD or CD-R medium.

5.2.1.3.1.1 Media Storage Application Profile

As depicted in Table 118, the Media AE supports the RWA Read Images for the Application Profile.

The mandatory attributes of the DICOM images are required for the correct storage of the images in the Brilliance™ Workspace internal image database. Optional attributes and Retired/Private attributes are stored too – if present; this is equivalent with the level 2 (Full) conformance for the Storage service class in the Network support;

5.3 Augmented and Private Application Profiles

This section is used for the description of augmented and private Application Profiles.

5.3.1 Augmented Application Profiles

None.

5.3.2 Private Application Profiles

None.

5.4 Media Configuration

Any configuration issues may be found in the Networking Section 4.4 Configuration.

6 SUPPORT OF CHARACTER SETS

The following extended character sets are supported:

Latin ISO_IR 100 also code as ISO 8859-1 Latin alphabet No. 1 Supplementary Set.

7 SECURITY

7.1 Security Profiles

None supported.

7.2 Association Level Security

None supported

7.3 Application Level Security

None supported

8 ANNEXES

8.1 IOD Contents

8.1.1 Created SOP Instances

This section specifies each IOD created by the Brilliance™ Workspace

Used abbreviations are:

ALWAYS	the module or attribute shall always be present with value
ANAP	Attribute Not Always Present
VNAP	Value Not Always Present (attribute sent zero length if no value is present)
EMPTY	Attribute is sent without a value
MAYBE	the module may be present under specified condition
OPTIONAL	the module may be available, depending on source object
AUTO	the attribute value is generated automatically
CONF	the attribute value source is a configurable parameter
IMPL	the attribute value source is a user-implicit configuration setting
SPEC	the attribute value source is a specific DICOM object
USER	the attribute value source is explicit user input
MWL	the attribute is derived from the HIS/RIS' Modality worklist

8.1.2 CT Image IOD Modules

Table 121: CT Image IOD Modules Table

Information Entity	Module Name	Reference	Presence of Module
Patient	Patient Module	Table 122	ALWAYS
Study	General Study Module	Table 123	ALWAYS
	Patient Study Module	Table 124	OPTIONAL
Series	General Series Module	Table 126	ALWAYS
Frame of Reference	Frame of Reference Module	Table 131	ALWAYS
Equipment	General Equipment Module	Table 125	ALWAYS
Image	General Image Module	Table 127	ALWAYS
	Image Plane Module	Table 132	ALWAYS
	Image Pixel Module	Table 129	ALWAYS
	Contrast/Bolus Module	Table 134	MAYBE
	CT Image Module	Table 135	ALWAYS
	VOI LUT Module	Table 130	OPTIONAL
	SOP Common Module	Table 128	ALWAYS

Table 122: Patient Module

Attribute Name	Tag	VR	Value	Presence of Value	Source
Patient's Name	0010,0010	PN		ALWAYS	MWL or USER
Patient ID	0010,0020	LO		ALWAYS	MWL or USER
Patient's Birth Date	0010,0030	DA		VNAP	MWL or USER
Patient's Sex	0010,0040	CS		ALWAYS	MWL or USER
Referenced Patient Sequence	0008,1120	SQ		ANAP	MWL
>Referenced SOP Class UID	0008,1150	UI		ALWAYS	MWL
>Referenced SOP Instance UID	0008,1155	UI		ALWAYS	MWL
Patient's Birth Time	0010,0032	TM		ANAP	MWL or USER
Other Patient IDs	0010,1000	LO		ANAP	CONF
Other Patient Names	0010,1001	PN		ANAP	MWL
Ethnic Group	0010,2160	SH		ANAP	MWL
Patient Comments	0010,4000	LT		ANAP	MWL

Table 123: General Study Module

Attribute Name	Tag	VR	Value	Presence of Value	Source
Study Instance UID	0020,000D	UI		ALWAYS	AUTO
Study Date	0008,0020	DA	Date of study creation	VNAP	AUTO
Study Time	0008,0030	TM	Time of study creation	VNAP	AUTO
Accession Number	0008,0050	SH		VNAP	MWL or USER
Referring Physician's Name	0008,0090	PN		VNAP	MWL or USER
Study ID	0020,0010	SH		VNAP	AUTO
Study Description	0008,1030	LO	The Procedure Description	ANAP	MWL or USER
Procedure Code Sequence	0008,1032	SQ	the (0032,1064) sequence on the MWL	ANAP	MWL
>Code Value	0008,0100	SH	Acquired from the matching attribute on the (0032,1064) sequence on the MWL	ALWAYS	MWL
>Coding Scheme Designator	0008,0102	SH	Acquired from the matching attribute on the (0032,1064) sequence on the MWL	ALWAYS	MWL
>Code Meaning	0008,0104	LO	Acquired from the matching attribute on the (0032,1064) sequence on the MWL	ALWAYS	MWL
Referenced Study Sequence	0008,1110	SQ		ANAP	MWL
>Referenced SOP Class UID	0008,1150	UI		ALWAYS	MWL
>Referenced SOP Instance UID	0008,1155	UI		ALWAYS	MWL

Table 124: Patient Study Module

Attribute Name	Tag	VR	Value	Presence of Value	Source
Patient's Age	0010,1010	AS	Generated according to the patient's Date of birth	ANAP	AUTO
Patient's Size	0010,1020	DS		ANAP	MWL or USER
Patient's Weight	0010,1030	DS		ANAP	MWL or USER
Occupation	0010,2180	SH	Acquired from the MWL	ANAP	MWL
Additional Patient's History	0010,21B0	LT	Acquired from the MWL	ANAP	MWL

Table 125: General Equipment Module

Attribute Name	Tag	VR	Value	Presence of Value	Source
Manufacturer	0008,0070	LO		VNAP	USER
Institution Name	0008,0080	LO		ANAP	USER
Institution Address	0008,0081	ST		ANAP	USER
Institutional Department Name	0008,1040	LO		ANAP	USER
Manufacturer's Module Name	0008,1090	LO		ANAP	AUTO
Software Versions	0018,1020	LO		ANAP	AUTO

Table 126: General Series Module

Attribute Name	Tag	VR	Value	Presence of Value	Source
Modality	0008,0060	CS	CT/ ECG	ALWAYS	AUTO
Series Instance UID	0020,000E	UI		ALWAYS	AUTO
Series Number	0020,0011	IS		ALWAYS	AUTO
Patient Position	0018,5100	CS		ANAP	AUTO
Laterality	0020,0060	CS		ANAP	MWL
Series Description	0008,103E	LO		ANAP	USER
Operators' Name	0008,1070	PN		ANAP	USER
Referenced Performed Procedure Step_Sequence	0008,1111	SQ		ANAP	AUTO
>Referenced SOP Class UID	0008,1150	UI		ALWAYS	AUTO
>Referenced SOP Instance UID	0008,1155	UI		ALWAYS	AUTO
Protocol Name	0018,1030	LO		ANAP	AUTO
Performed Procedure Step ID	0040,0253	SH		ANAP	MWL
Performed Procedure Step Description	0040,0254	LO			MWL
Performed Protocol Code Sequence	0040,0260	SQ		ANAP	MWL
>Requested Procedure ID	0040,1001	SH		ANAP	MWL
>Scheduled Procedure Step ID	0040,0009	SH		ANAP	MWL
>Scheduled Procedure Step Description	0040,0007	LO		ANAP	MWL
>Scheduled Protocol Code Sequence	0040,0008	SQ		ANAP	MWL
>>Code Value	0008,0100	SH		ALWAYS	MWL
>>Coding Scheme Designator	0008,0102	SH		ALWAYS	MWL
>>Code Scheme Version	0008,0103	SH		ALWAYS	MWL

>>Code Meaning	0008,0104	LO		ALWAYS	MWL
>>Protocol Context Sequence	0040,0440	SQ		ANAP	MWL
>>>Content Item Modifier Sequence	0040,0441	SQ		ANAP	MWL
>>>> Measurement Units Code Sequence	0040,08EA	SQ		ANAP	MWL
>>>>>Code Value	0008,0100	SH		ANAP	MWL
>>>>>Coding Scheme Designator	0008,0102	SH		ANAP	MWL
>>>>>Coding Scheme Version	0008,0103	SH		ANAP	MWL
>>>>>Code Meaning	0008,0104	LO		ANAP	MWL
>>>>>Value Type	0040,A040	CS		ANAP	MWL
>>>>>Concept Name Code Sequence	0040,A043	SQ		ANAP	MWL
>>>>>>Code Value	0008,0100	SH		ANAP	MWL
>>>>>>Coding Scheme Designator	0008,0102	SH		ANAP	MWL
>>>>>>Coding Scheme Version	0008,0103	SH		ANAP	MWL
>>>>>>Code Meaning	0008,0104	LO		ANAP	MWL
>>>>>>DateTime	0040,A120	DT		ANAP	MWL
>>>>>>Date	0040,A121	DA		ANAP	MWL
>>>>>>Time	0040,A122	TM		ANAP	MWL
>>>>>>Person Name	0040,A123	PN		ANAP	MWL
>>>>>>UID	0040,A124	UI		ANAP	MWL
>>>>>>Text Value	0040,A160	UT		ANAP	MWL
>>>>>>Concept Code Sequence	0040,A168	SQ		ANAP	MWL
>>>>>>>Code Value	0008,0100	SH		ANAP	MWL
>>>>>>>Coding Scheme Designator	0008,0102	SH		ANAP	MWL
>>>>>>>Coding Scheme Version	0008,0103	SH		ANAP	MWL
>>>>>>>Code Meaning	0008,0104	LO		ANAP	MWL
>>>>>>>Numeric Value	0040,A30A	DS		ANAP	MWL
>>>Measurement Units Code Sequence	0040,08EA	SQ		ANAP	MWL
>>>>>Code Value	0008,0100	SH		ANAP	MWL
>>>>>Coding Scheme Designator	0008,0102	SH		ANAP	MWL
>>>>>Coding Scheme Version	0008,0103	SH		ANAP	MWL
>>>>>Code Meaning	0008,0104	LO		ANAP	MWL
>>>>>Value Type	0040,A040	CS		ANAP	MWL
>>>>>Concept Name Code Sequence	0040,A043	SQ		ANAP	MWL
>>>>>>Code Value	0008,0100	SH		ANAP	MWL
>>>>>>Coding Scheme Designator	0008,0102	SH		ANAP	MWL
>>>>>>Coding Scheme Version	0008,0103	SH		ANAP	MWL
>>>>>>Code Meaning	0008,0104	LO		ANAP	MWL
>>>DateTime	0040,A120	DT		ANAP	MWL
>>>Date	0040,A121	DA		ANAP	MWL
>>>Time	0040,A122	TM		ANAP	MWL
>>>Person Name	0040,A123	PN		ANAP	MWL
>>>UID	0040,A124	UI		ANAP	MWL
>>>Text Value	0040,A160	UT		ANAP	MWL
>>>Concept Code Sequence	0040,A168	SQ		ANAP	MWL
>>>>>Code Value	0008,0100	SH		ANAP	MWL
>>>>>Coding Scheme Designator	0008,0102	SH		ANAP	MWL
>>>>>Coding Scheme Version	0008,0103	SH		ANAP	MWL
>>>>>Code Meaning	0008,0104	LO		ANAP	MWL
>>>Numeric Value	0008,A30A	DS		ANAP	MWL
Performed Procedure Step ID	0040,0253	SH		ANAP	MWL
Performed Procedure Step Description	0040,0254	LO		ANAP	MWL

Table 127: General Image Module

Attribute Name	Tag	VR	Value	Presence of Value	Source
Instance Number	0020,0013	IS	Image number in parent series	VNAP	AUTO
Content Date	0008,0023	DA	Image creation date	ANAP	AUTO
Content Time	0008,0033	TM	Image creation time	ANAP	AUTO
Image Type	0008,0008	CS	Value 1 = "ORIGINAL" or "DERIVED" Value 2 = "PRIMARY" or "SECONDARY" Value 3 = "AXIAL", "LOCALIZER", "LOCALIZER ES", "LOCALIZER PS", "MULTI_FORMAT_RASTER", "MPR", "DISPLAY", "VOLR", "TISSUE", "IMAGE ADDITION", "SCR", "3D", "MIP", "ANGIO", "PATH", "PERFUSION", "DENTA", "ROIS", "NODULS", "REGISTRATION", "TRANSFORM" Value 4 = "AXIAL", "CRV", "HELIX", "SCR", "MIP", "3D", "HEARTBEATCS", "LNA", "ENHANCED" Value 5 = "HELIX", "ROI"	ANAP	AUTO
Acquisition Date	0008,0022	DA		ANAP	AUTO
Acquisition Time	0008,0032	TM		ANAP	AUTO
Image Comments	0020,4000	LT		ANAP	USER

Table 128: SOP Common Module

Attribute Name	Tag	VR	Value	Presence of Value	Source
Specific Character Set	0008,0005	CS	(ISO_IR 100) *	ALWAYS	MWL or AUTO
SOP Class UID	0008,0016	UI	1.2.840.10008.5.1.4.1.1.2 / 1.2.840.10008.5.1.4.1.1.9.1.2 / 1.2.840.10008.5.1.4.1.1.7	ALWAYS	AUTO
SOP Instance UID	0008,0018	UI		ALWAYS	AUTO
Instance Creation Date	0008,0012	UI	Image creation date	ANAP	AUTO
Instance Creation Time	0008,0013	TM	Image creation time	ANAP	AUTO

* Depends if configured as acquired from the MWL.

Table 129: Image Pixel Module

Attribute Name	Tag	VR	Value	Presence of Value	Source
Row	0028,0010	US		ALWAYS	AUTO
Columns	0028,0011	US		ALWAYS	AUTO
Pixel Representation	0028,0103	US	0	ALWAYS	AUTO
Pixel Data	7FE0,0010	OW		ALWAYS	AUTO

Table 130: VOI LUT Module

Attribute Name	Tag	VR	Value	Presence of Value	Source
Window Center	0028,1050	DS		ANAP	AUTO
Window Width	0028,1051	DS		ANAP	AUTO

Table 131: Frame of Reference Module

Attribute Name	Tag	VR	Value	Presence of Value	Source
Frame of Reference UID	0020,0052	UI		ALWAYS	AUTO
Position Reference Indicator	0020,1040	LO		VNAP	AUTO

Table 132: Image Plane Module

Attribute Name	Tag	VR	Value	Presence of Value	Source
Image Position (Patient)	0020,0032	DS		ALWAYS	AUTO
Image Orientation (Patient)	0020,0037	DS		ALWAYS	AUTO
Pixel Spacing	0028,0030	DS		ALWAYS	AUTO
Slice Thickness	0018,0050	DS		ALWAYS	AUTO
Slice Location	0020,1041	DS		ALWAYS	AUTO

Table 133: Modality LUT Module

Attribute Name	Tag	VR	Value	Presence of Value	Source
Rescale Intercept	0028,1052	DS		ANAP	AUTO
Rescale Slope	0028,1053	DS		ANAP	AUTO
Rescale Type	0028,1054	LO		ANAP	AUTO

Table 134: Contrast/Bolus Module

Attribute Name	Tag	VR	Value	Presence of Value	Source
Contrast/Bolus Agent	0018,0010	LO		VNAP	AUTO
Contrast/Bolus Route	0018,1040	LO		VNAP	AUTO
Contrast/Bolus Administration Route Sequence	0018,0014	SQ		VNAP	AUTO
Contrast/Bolus Volume	0018,002A	SQ		VNAP	AUTO
Contrast Flow Rate	0018,1046	DS		VNAP	AUTO
Contrast/Bolus Ingredient Concentration	0018,1049	DS		VNAP	AUTO

Table 135: CT Image Module

Attribute Name	Tag	VR	Value	Presence of Value	Source
Image Type	0008,0008	CS		ALWAYS	CONF
Samples per Pixel	0028,0002	US	1	ALWAYS	AUTO
Photometric Interpretation	0028,0004	CS	MONOCHROME2	ALWAYS	AUTO

Bits Allocated	0028,0100	US	16	ALWAYS	AUTO
Bits Stored	0028,0101	US	12	ALWAYS	AUTO
High Bit	0028,0102	US	11	ALWAYS	AUTO
Rescale Intercept	0028,1052	DS		ALWAYS	AUTO
Rescale Slope	0028,1053	DS		ALWAYS	AUTO
KVP	0018,0060	DS		VNAP	AUTO
Acquisition Number	0020,0012	IS		VNAP	AUTO
Scan Options	0018,0022	CS		ANAP	AUTO
Data Collection Diameter	0018,0090	DS		ANAP	AUTO
Reconstruction Diameter	0018,1100	DS		ANAP	AUTO
Gantry/Detector Tilt	0018,1120	DS		ANAP	AUTO
Table Height	0018,1130	DS		ANAP	AUTO
Rotation Direction	0018,1140	CS		ANAP	AUTO
Exposure Time	0018,1150	IS		ANAP	AUTO
X-Ray Tube Current	0018,1151	IS		ANAP	AUTO
Exposure	0018,1152	IS		ANAP	AUTO
Filter Type	0018,1160	SH		ANAP	AUTO
Convolution Kernel	0018,1210	SH		ANAP	AUTO

8.1.3 General EGC Waveform IOD Modules

Table 136: General EGC Waveform IOD Modules table

Information Entity	Module Name	Reference	Presence of Module
Patient	Patient Module	Table 122	ALWAYS
Study	General Study Module		ALWAYS
		Table 123	
Series	General Series Module	Table 126	ALWAYS
Frame of Reference	Synchronization Module		OPTIONAL
Equipment	General Equipment Module	Table 125	ALWAYS
Waveform	Waveform Identification Module	Table 137	ALWAYS
	Waveform Module	Table 138	ALWAYS
	Acquisition Context	Table 139	ALWAYS
	SOP Common Module	Table 128	ALWAYS

Table 137: Waveform Identification Module

Attribute Name	Tag	VR	Value	Presence of Value	Source
Instance Number	0020,0013	CS		ALWAYS	AUTO
Content Date	0008,0023	DA	Image creation date	ALWAYS	AUTO
Content Time	0008,0033	TM	Image creation time	ALWAYS	AUTO
Acquisition DateTime	0008,002A	DT		ALWAYS	AUTO
Referenced Instance Sequence	0008,114A	SQ		ANAP	AUTO
>Referenced SOP Class UID	0008,1150	UI		ALWAYS	AUTO
>Referenced SOP Instance UID	0008,1155	UI		ALWAYS	AUTO

Table 138: Waveform Module

Attribute Name	Tag	VR	Value	Presence of Value	Source
Waveform Sequence	5400,0100	SQ		ALWAYS	AUTO
>Multiplex Group Time Offset	0018,1068	DS		VNAP	AUTO
>Waveform Originality	003A,0004	CS	ORIGINAL	ALWAYS	AUTO
>Number of Waveform Channels	003A,0005	US		ALWAYS	AUTO
>Number of Waveform Samples	003A,0010	UL		ALWAYS	AUTO
>Sampling Frequency	003A,001A	DS		ALWAYS	AUTO
>Channel Definition Sequence	003A,0200	SQ		ALWAYS	AUTO
>>Waveform Channel Number	003A,0202	IS		ANAP	AUTO
>>Channel Label	003A,0203	SH		ANAP	AUTO
>>Channel Status	003A,0205	CS		ANAP	AUTO
>>Channel Source Sequence	003A,0206	SQ		ALWAYS	AUTO
>>>Code Value	0008,0100	SH		ALWAYS	AUTO
>>>Coding Scheme Designator	0008,0102	SH		ALWAYS	AUTO
>>>Code Meaning	0008,0104	LO		ALWAYS	AUTO
>>Channel Sensitivity Units Sequence	003A,0211	SQ		ALWAYS	AUTO
>>>Code Value	0008,0100	SH		ALWAYS	AUTO

>>>Coding Scheme Designator	0008,0102	SH		ALWAYS	AUTO
>>>Coding Scheme Version	0008,0103	SH		ALWAYS	AUTO
>>>Code Meaning	0008,0104	LO		ALWAYS	AUTO
>>Channel Sensitivity Correction Factor	003A,0212	DS		ALWAYS	AUTO
>>Channel Baseline	003A,0213	DS		ALWAYS	AUTO
>>Channel Time Skew	003A,0214	DS		ANAP	AUTO
>>Channel Sample Skew	003A,0215	DS		ANAP	AUTO
>>Waveform Bits Stored	003A,021A	US		ALWAYS	AUTO
>Waveform Bits Allocated	5400,1004	US		ALWAYS	AUTO
>Waveform Sample Interpretation	5400,1006	CS		ALWAYS	AUTO
Waveform Data	5400,1010	OB/ OW		ALWAYS	AUTO

Table 139: Acquisition Context Module

Attribute Name	Tag	VR	Value	Presence of Value	Source
Acquisition Context Sequence	0040,0555	SQ		VNAP	AUTO
>Value Type	0040,A040	CS		ANAP	AUTO
>Concept Name Code Sequence	0040,A043	SQ		ALWAYS	AUTO
>>Code Value	0008,0100	SH		ALWAYS	AUTO
>>Coding Scheme Designator	0008,0102	SH		ALWAYS	AUTO
>>Coding Scheme Version	0008,0103	SH		ALWAYS	AUTO
>>Code Meaning	0008,0104	LO		ALWAYS	AUTO
>Referenced Frame Numbers	0040,A136	US		MAYBE	AUTO
>Numeric Value	0040,A30A	DS		MAYBE	AUTO
>Measurement Units Code Sequence	0040,08EA	SQ		MAYBE	AUTO
>>Code Value	0008,0100	SH		ALWAYS	AUTO
>>Coding Scheme Designator	0008,0102	SH		ALWAYS	AUTO
>>Coding Scheme Version	0008,0103	SH		ALWAYS	AUTO
>>Code Meaning	0008,0104	LO		ALWAYS	AUTO
>Date	0040,A121	DA		MAYBE	AUTO
>Time	0040,A122	TM		MAYBE	AUTO
>Person Name	0040,A123	PN		MAYBE	AUTO
>Text Value	0040,A160	UT		MAYBE	AUTO
>Concept Code Sequence	0040,A168	SQ		MAYBE	AUTO
>>Code Value	0008,0100	SH		ALWAYS	AUTO
>>Coding Scheme Designator	0008,0102	SH		ALWAYS	AUTO
>>Coding Scheme Version	0008,0103	SH		ALWAYS	AUTO
>>Code Meaning	0008,0104	LO		ALWAYS	AUTO
Acquisition Context Description	0040,0556	ST		ANAP	AUTO

8.1.4 RT Plan IOD Modules

Table 140: RT Plan IOD Modules Table

Information Entity	Module Name	Reference	Presence of Module
Patient	Patient Module	Table 122	ALWAYS
Study	General Study Module	Table 123	ALWAYS
	Patient Study Module		NOT USED
Series	RT Series Module	Table 143	ALWAYS
Frame of Reference	Frame of Reference Module	Table 131	OPTIONAL
Equipment	General Equipment Module	Table 150	ALWAYS
	RT General Plan Module	Table 144	ALWAYS
	RT Prescription Module		NOT USED
	RT Tolerance Tables Module		NOT USED
	RT Patient Setup Module		NOT USED
	RT Fraction Scheme Module		NOT USED
	RT Beams Module	Table 145	ALWAYS
	RT Brachy Application Setup Module		NOT USED
	Approval Module		NOT USED
	Audio Module		NOT USED
	SOP Common Module	Table 128	ALWAYS

Table 141: RT Structure Set IOD Modules Table

Information Entity	Module Name	Reference	Presence of Module
Patient	Patient Module	Table 122	ALWAYS
Study	General Study Module	Table 123	ALWAYS
	Patient Study Module		NOT USED
Series	RT Series Module	Table 143	ALWAYS
Frame of Reference	Frame of Reference Module	Table 131	OPTIONAL
Equipment	General Equipment Module	Table 150	ALWAYS
	Structure Set Module	Table 146	ALWAYS
	ROI Contour Module	Table 147	ALWAYS
	RT ROI Observations Module	Table 148	
	Approval Module		NOT USED
	Audio Module		NOT USED
	SOP Common Module	Table 128	ALWAYS

Table 142: RT Image IOD Modules Table

Information Entity	Module Name	Reference	Presence of Module
Patient	Patient Module	Table 122	ALWAYS

Information Entity	Module Name	Reference	Presence of Module
Study	General Study Module	Table 123	ALWAYS
	Patient Study Module		NOT USED
Series	RT Series Module	Table 143	ALWAYS
Frame of Reference	Frame of Reference Module	Table 131	OPTIONAL
Equipment	General Equipment Module	Table 150	ALWAYS
Image	General Image Module	Table 127	ALWAYS
	Image Pixel Module	Table 129	ALWAYS
	Contrast/Bolus Module		NOT USED
	Cine Module		NOT USED
	Multi-Frame Module		NOT USED
	RT Image Module	Table 149	ALWAYS
	Modality LUT Module		NOT USED
	VOI LUT Module		NOT USED
	Approval Module		NOT USED
	Curve Module		NOT USED
	Audio Module		NOT USED
	SOP Common Module	Table 128	ALWAYS

Table 143: RT Series Module

Attribute Name	Tag	VR	Value	Presence of Value	Source
Modality	0008,0060	CS	"RTPLAN" or "RTSTRUCT" or "RTIMAGE"	ALWAYS	AUTO
Series Instance UID	0020,000E	UI		ALWAYS	AUTO
Series Number	0020,0011	IS		ALWAYS	AUTO
Series Description	0008,103E	LO		ANAP	AUTO
Referenced Study Component Sequence	0008,1111	SQ		ANAP	AUTO
>Referenced SOP Class UID	0008,1150	UI		ANAP	AUTO
>Referenced SOP Instance UID	0008,1155	UI		ANAP	AUTO

Table 144: RT General Plan Module

Attribute Name	Tag	VR	Value	Presence of Value	Source
RT Plan Label	300A,0002	SH		VNAP	AUTO
RT Plan Name	300A,0003	LO		ANAP	AUTO
RT Plan Description	300A,0004	ST	Related CT Series UID	ALWAYS	AUTO
Operators' Name	0008,1070	PN		VNAP	AUTO
RT Plan Date	300A,0006	DA	Last Modified Date	ALWAYS	AUTO
RT Plan Time	300A,0007	TM	Last Modified Time	ALWAYS	AUTO
RT Plan Geometry	300A,000C	CS	"PATIENT" or "TREATMENT DEVICE"	ALWAYS	AUTO
Referenced Structure Set Sequence	300C,0060	SQ		ANAP	AUTO
>Referenced SOP Class UID	0008,1150	UI		ANAP	AUTO
>Referenced SOP Instance UID	0008,1155	UI		ANAP	AUTO

Table 145: RT Beams Module

Attribute Name	Tag	VR	Value	Presence of Value	Source
Beam Sequence	300A,00B0	SQ		ALWAYS	AUTO
> Beam Number	300A,00C0	IS	Unique starting at "0"	ALWAYS	AUTO
> Beam Name	300A,00C2	LO	Isocenter Name + "Beam_1" or "Beam_2"	ALWAYS	USER
>Beam Description	300A,00C3	ST		ALWAYS	AUTO
>Beam Type	300A,00C4	CS	"STATIC"	ALWAYS	AUTO
>Radiation Type	300A,00C6	CS	"PHOTON"	ALWAYS	AUTO
>Treatment Machine Name	300A,00B2	SH	Configurable value default: "linac"	ALWAYS	CONF
>Manufacturer	0008,0070	LO	"Other"	ALWAYS	AUTO
>Primary Dosimeter Unit	300A,00B3	CS	"Mu"	ALWAYS	AUTO
>Source-Axis Distance	300A,00B4	DS	Configurable value default: "1000"	ALWAYS	CONF
>Beam Limiting Device Sequence	300A,00B6	SQ		ALWAYS	AUTO
>>RT Beam Limiting Device Type	300A,00B8	CS	"X" or "Y" or "ASMYX" or "ASYMY"	ALWAYS	AUTO
>>Source to Beam Limiting Device Distance	300A,00BA	DS		ALWAYS	AUTO
>>Number of Leaf/Jaw Pairs	300A,00BC	IS		ALWAYS	AUTO
>Referenced Patient Setup Number	300C,006A	IS		ANAP	AUTO
>Treatment Delivery Type	300A,00CE	CS		ANAP	AUTO
>Number of Wedges	300A,00D0	IS	"0"	ALWAYS	AUTO
>Number of Compensators	300A,00E0	IS	"0"	ALWAYS	AUTO
>Number of Boli	300A,00ED	IS	"0"	ALWAYS	AUTO
>Number of Blocks	300A,00F0	IS	"0"	ALWAYS	AUTO
>Final Cumulative Meterset Weight	300A,010E	DS		ALWAYS	AUTO
>Number of Control Points	300A,0110	IS		ALWAYS	AUTO
>Control Point Sequence	300A,0111	SQ		ALWAYS	AUTO
>>Control Point Index	300A,0112	IS		ALWAYS	AUTO
>>Cumulative Meterset Weight	300A,0134	DS		ALWAYS	AUTO
>>Beam Limiting Device Position Sequence	300A,011A	SQ		ALWAYS	AUTO
>>>RT Beam Limiting Device Type	300A,00B8	CS		ALWAYS	AUTO
>>>Leaf/Jaw Positions	300A,011C	DS		ALWAYS	AUTO
>>>Gantry Angle	300A,011E	DS		ALWAYS	AUTO
>>>Gantry Rotation Direction	300A,011F	CS		ALWAYS	AUTO
>>>Beam Limiting Device Angle	300A,0120	DS		ALWAYS	AUTO
>>>Beam Limiting Device Rotation Direction	300A,0121	CS		ALWAYS	AUTO
>>>Patient Support Angle	300A,0122	DS		ALWAYS	AUTO
>>>Patient Support Rotation Direction	300A,0123	CS		ALWAYS	AUTO
>>>Table Top Eccentric Angle	300A,0125	DS		ALWAYS	AUTO
>>>Table Top Eccentric Rotation Direction	300A,0126	CS		ALWAYS	AUTO
>>>Table Top Vertical Position	300A,0128	DS		ALWAYS	AUTO
>>>Table Top Longitudinal Position	300A,0129	DS		ALWAYS	AUTO
>>>Table Top Lateral Position	300A,012A	DS		ALWAYS	AUTO
>>>Isocenter Position	300A,012C	DS		ALWAYS	AUTO

Table 146: Structure Set Module

Attribute Name	Tag	VR	Value	Presence of Value	Source
Structure Set Label	3006,0002	SH		VNAP	AUTO
Structure Set Name	3006,0004	LO		VNAP	AUTO
Structure Set Date	3006,0008	DA	Last Modified Date	ALWAYS	AUTO
Structure Set Time	3006,0009	TM	Last Modified Time	ALWAYS	AUTO
Referenced Frame of Reference Sequence	3006,0010	SQ		ALWAYS	AUTO
>Frame of Reference UID	0020,0052	UI	Related CT Image Frame of Reference UID	ALWAYS	AUTO
>RT Referenced Study Sequence	3006,0012	SQ		ALWAYS	AUTO
>>Referenced SOP Class UID	0008,1150	UI	"1.2.840.10008.3.1.2.3.2"	ALWAYS	AUTO
>>Referenced SOP Instance UID	0008,1155	UI		ALWAYS	AUTO
>>RT Referenced Series Sequence	3006,0014	SQ		ALWAYS	AUTO
>>>Series Instance UID	0020,000E	UI		ALWAYS	AUTO
>>>Contour Image Sequence	3006,0016	SQ		ALWAYS	AUTO
>>>>Referenced SOP Class UID	0008,1150	UI	"1.2.840.10008.5.1.4.1.1.2"	ALWAYS	AUTO
>>>>Referenced SOP Instance UID	0008,1155	UI		ALWAYS	AUTO
Structure Set ROI Sequence	3006,0020	SQ		ALWAYS	AUTO
>ROI Number	3006,0022	IS		ALWAYS	AUTO
>Referenced Frame of Reference UID	3006,0024	UI	Related CT Image Frame of Reference UID	ALWAYS	AUTO
>ROI Name	3006,0026	LO	User definable organ name	ALWAYS	USER
>ROI Volume	3006,002C	DS		ALWAYS	AUTO
>ROI Generation Algorithm	3006,0036	CS		VNAP	AUTO

Table 147: ROI Contour Module

Attribute Name	Tag	VR	Value	Presence of Value	Source
ROI Contour Sequence	3006,0039	SQ		ALWAYS	AUTO
>Referenced ROI Number	3006,0084	IS		ALWAYS	AUTO
>ROI Display Color	3006,002A	IS		ALWAYS	AUTO
>Contour Sequence	3006,0040	SQ		ALWAYS	AUTO
>>Contour Image Sequence	3006,0016	SQ		ALWAYS	AUTO
>>>Referenced SOP Class UID	0008,1150	UI	"1.2.840.10008.5.1.4.1.1.2"	ALWAYS	AUTO
>>>Referenced SOP Instance UID	0008,1155	UI		ALWAYS	AUTO
>>Contour Geometric Type	3006,0042	CS	"CLOSED_PLANAR"	ALWAYS	AUTO
>>Number of Contour Points	3006,0046	IS		ALWAYS	AUTO
>>Contour Data	3006,0050	DS		ALWAYS	AUTO

Table 148: RT ROI Observation Module

Attribute Name	Tag	VR	Value	Presence of Value	Source
RT ROI Observations Sequence	3006,0080	SQ		ALWAYS	AUTO
>Observation Number	3006,0082	IS		ALWAYS	AUTO
>Referenced ROI Number	3006,0084	IS		ALWAYS	AUTO
>RT ROI Interpreted Type	3006,00A4	CS		VNAP	AUTO
>ROI Interpreter	3006,00A6	PN		VNAP	AUTO

Table 149: RT Image Module

Attribute Name	Tag	VR	Value	Presence of Value	Source
Samples per Pixel	0028,0002	US		ALWAYS	AUTO
Photometric Interpretation	0028,0004	CS	"MONOCHROME2"	ALWAYS	AUTO
Rows	0028,0010	US		ALWAYS	AUTO
Columns	0028,0011	US		ALWAYS	AUTO
Bits Allocated	0028,0100	US		ALWAYS	AUTO
Bits Stored	0028,0101	US		ALWAYS	AUTO
High Bit	0028,0102	US		ALWAYS	AUTO
Pixel Representation	0028,0103	US		ALWAYS	AUTO
RT Image Label	3002,0002	SH		VNAP	AUTO
RT Image Name	3002,0003	LO		ANAP	AUTO
RT Image Description	3002,0004	ST	Related CT Series UID	ALWAYS	AUTO
Operators' Name	0008,1070	PN		EMPTY	AUTO
Image Type	0008,0008	CS	"DERIVED / SECONDARY / DRR"	ALWAYS	AUTO
Conversion Type	0008,0064	CS		ALWAYS	AUTO
RT Image Plane	3002,000C	CS		ALWAYS	AUTO
X-Ray Image Receptor Angle	3002,000E	DS		ALWAYS	AUTO
Image Plane Pixel Spacing	3002,0011	DS		VNAP	AUTO
RT Image Position	3002,0012	DS		VNAP	AUTO
Radiation Machine Name	3002,0020	SH		VNAP	AUTO
Primary Dosimeter Unit	300A,00B3	CS		VNAP	AUTO
Radiation Machine SAD	3002,0022	DS		VNAP	AUTO
RT Image SID	3002,0026	DS		VNAP	AUTO
Referenced RT Plan Sequence	300C,0002	SQ		ANAP	AUTO
>Referenced SOP Class UID	0008,1150	UI		ANAP	AUTO
>Referenced SOP Instance UID	0008,1155	UI		ANAP	AUTO
Referenced Beam Number	300C,0006	IS		ANAP	AUTO
Exposure Sequence	3002,0030	SQ		ANAP	AUTO
>Beam Limiting Device Sequence	300A,00B6	SQ		ANAP	AUTO
>>RT Beam Limiting Device Type	300A,00B8	CS		ANAP	AUTO
>>Number of Leaf/Jaw Pairs	300A,00BC	IS		ANAP	AUTO
>>Leaf/Jaw Positions	300A,011C	DS		ANAP	AUTO
>Number of Blocks	300A,00F0	IS		ANAP	AUTO
Gantry Angle	300A,011E	DS		ANAP	AUTO
Beam Limiting Device Angle	300A,0120	DS		ANAP	AUTO

Table 150: General Equipment Module (RT Objects)

Attribute Name	Tag	VR	Value	Presence of Value	Source
Manufacturer	0008,0070	LO	"Philips"	ALWAYS	AUTO
Station Name	0008,1010	SH	"Unknown"	ALWAYS	AUTO
Manufacturer's Module Name	0008,1090	LO	"Loc1.0"	ALWAYS	AUTO
Software Versions	0018,1020	LO		EMPTY	AUTO

8.1.5 Dose Info Page Image

Brilliance™ scanner can optionally create, upon completion of the study, a special Secondary Capture image that contains radiation dose Information. The specific attributes for this image are described in the next table:

Table 151: Dose Info Page Image Attributes

Attribute Name	Tag	VR	Value	Presence of Value	Source
Image Type	0008,0008	CS	DERIVED\SECONDARY\DOSE_INFO	ALWAYS	AUTO
Series Description	0008,103E	LO	"Dose Info"	ALWAYS	AUTO
Image Comments	0020,4000	LT	"Dose Info"	ALWAYS	AUTO
Total Number of Exposures	0040,0301			ALWAYS	AUTO
Exposure Dose Sequence	0040,030E			ALWAYS	AUTO
>X-ray Tube Current in μ A	0018,8151			ALWAYS	AUTO
>Exposure Time	0018,1150			ALWAYS	AUTO
>Radiation Mode	0018,115A			ALWAYS	AUTO
>KVp	0018,0060			ALWAYS	AUTO
>Filter Type	0018,1160			ALWAYS	AUTO
>Filter Material	0018,7050			ALWAYS	AUTO
>CTDIvol	0018,9345			ALWAYS	AUTO
>Estimated Dose Saving	0018,9324			ANAP	AUTO
>DLP	00E1:1021	DS		ALWAYS	AUTO
>Acquisition Type	0018,9302			ALWAYS	AUTO
>Scan Length	0018,1302			ALWAYS	AUTO
>Acquisition Datetime	0008,002A			ALWAYS	AUTO
>Single Collimation Width	0018,9306			ALWAYS	AUTO
>Total Collimation Width	0018,9307			ALWAYS	AUTO
>Spiral Pitch Factor	0018,9311			ANAP	AUTO
>Series Number	0020,0011			ALWAYS	AUTO
>Series Description	0008:103E			ALWAYS	AUTO
DLP	00E1:1021	DS	Total DLP	ALWAYS	AUTO

8.1.6 Usage of Attributes from Received IOD's

Not Applicable

8.1.7 Attribute Mapping

The relationships between attributes received via Modality Worklist, stored in acquired images and MPPS are summarized in Table

Table 152: Attribute mapping between modality worklist, image and MPPS

MWL Value	Image	MPPS
(0010,0010) Patient's Name	(0010,0010) Patient's Name	(0010,0010) Patient's Name
(0010,0020) Patient ID	(0010,0020) Patient ID	(0010,0020) Patient ID
(0010,1000) Other Patient IDs	(0010,1000) Other Patient IDs	(0010,1000) Other Patient IDs
(0010,0030) Patient's Birth Date	(0010,0030) Patient's Birth Date	(0010,0030) Patient's Birth Date
(0010,0040) Patient's Sex	(0010,0040) Patient's Sex	(0010,0040) Patient's Sex
(0010,1030) Patient's Weight	(0010,1030) Patient's Weight	N/A
(0010,2160) Ethnic Group	(0010,2160) Ethnic Group	N/A
(0010,4000) Patient Comments	(0010,4000) Patient Comments	N/A
(0020,000D) Study Instance UID	(0020,000D) Study Instance UID **	(0040,0270) Scheduled Step Attributes Sequence > (0020,000D) Study Instance UID
(0040,3001) Confidentiality Constraint on Patient Data Description	(0040,3001) Confidentiality Constraint on Patient Data Description	N/A
(0010,2000) Medical Alerts	(0010,2000) Medical Alerts	N/A
(0010,2110) Contrast Allergies	(0010,2110) Contrast Allergies	N/A
(0010,21B0) Additional Patient History	N/A	N/A
(0010,21C0) Pregnancy Status	(0010,21C0) Pregnancy Status	N/A
(0038,0050) Special Needs	(0038,0050) Special Needs	N/A
(0038,0500) Patient State	(0038,0500) Patient State	N/A
(0038,0010) Admission ID	(0038,0010) Admission ID	N/A
(0038,0300) Current Patient Location	N/A	N/A
(0040,0100) Scheduled Procedure Step Sequence	(0040,0275) Request attributes sequence	(0040,0270) Scheduled Step Attributes Sequence
>(0008,0060) Modality***	(0008,0060) Modality***	(0008,0060) Modality***
>(0032,1070) Requested Contrast Agent	(0032,1070)	N/A
>(0040,0001) Scheduled Station AE Title	N/A	(0040,0241) Performed Station AE Title
>(0040,0002) Scheduled Procedure Step Start Date	N/A	N/A
>(0040,0003) Scheduled Procedure Step Start Time	N/A	N/A
>(0040,0006) Scheduled Performing Physician's Name	N/A	N/A
>(0040,0007) Scheduled Procedure Step Description	(0040,0275) Request attributes sequence >(0040,0007) Scheduled Procedure Step Description	(0040,0270) Scheduled Step Attributes Sequence >(0040,0254) Performed Procedure Step Description
>(0040,0008) Scheduled Protocol Code Sequence	(0040,0275) Request attributes sequence >(0040,0008) Scheduled Protocol Code Sequence	(0040,0270) Scheduled Step Attributes Sequence >(0040,0008) Scheduled Protocol Code Sequence
>>(0008,0100) Code Value	(0040,0275) Request attributes sequence >(0040,0008) Scheduled Protocol Code Sequence >>(0008,0100) Code Value	(0040,0270) Scheduled Step Attributes Sequence >(0040,0008) Scheduled Protocol Code Sequence >>(0008,0100) Code Value

>>(0008,0102) Coding Scheme Designator	(0040,0275) Request attributes sequence >(0040,0008) Scheduled Protocol Code Sequence >>(0008,0102) Coding Scheme Designator	(0040,0270) Scheduled Step Attributes Sequence >(0040,0008) Scheduled Protocol Code Sequence >>(0008,0102) Coding Scheme Designator
>>(0008,0103) Coding Scheme Version	N/A	N/A
>>(0008,0104) Code Meaning	(0040,0275) Request attributes sequence >(0040,0008) Scheduled Protocol Code Sequence >>(0008,0104) Code Meaning	(0040,0270) Scheduled Step Attributes Sequence >(0040,0008) Scheduled Protocol Code Sequence >>(0008,0104) Code Meaning
>(0040,0009) Scheduled Procedure Step ID	(0040,0275) Request attributes sequence >(0040,0009) Scheduled Procedure Step ID	(0040,0270) Scheduled Step Attributes Sequence >(0040,0253) Performed Procedure step ID
>(0040,0010) Scheduled Station Name	(0040,0275) Request attributes sequence >(0040,0010) Scheduled Station Name	(0040,0242) Performed Station Name
>(0040,0011) Scheduled Procedure Step Location	N/A	(0040,0243) Performed Step Location
(0008,1110) Referenced Study Sequence	(0008,1110) Referenced Study Sequence	(0040,0270) Scheduled Step Attributes Sequence > (0008,1110) Referenced Study Sequence
>(0008,1150) Referenced SOP Class UID	>(0008,1150) Referenced SOP Class UID	(0040,0270) Scheduled Step Attributes Sequence > (0008,1110) Referenced Study Sequence >>(0008,1150) Referenced SOP Class UID
>(0008,1155) Referenced SOP Instance UID	>(0008,1155) Referenced SOP Instance UID	(0040,0270) Scheduled Step Attributes Sequence > (0008,1110) Referenced Study Sequence >>(0008,1150) Referenced SOP Instance UID
(0008,1120) Referenced Patient Sequence	(0008,1120) Referenced Patient Sequence	(0008,1120) Referenced Patient Sequence
>(0008,1150) Referenced SOP Class UID	>(0008,1150) Referenced SOP Class UID	>(0008,1150) Referenced SOP Class UID
>(0008,1155) Referenced SOP Instance UID	>(0008,1155) Referenced SOP Instance UID	>(0008,1155) Referenced SOP Instance UID
(0032,1060) Requested Procedure Description	(0032,1060) Requested Procedure Description	(0032,1060) Requested Procedure Description
(0032,1064) Requested Procedure Code Sequence	(0008,1032) Procedure Code Sequence	(0008,1032) Procedure Code Sequence
>(0008,0100) Code Value	>(0008,0100) Code Value	>(0008,0100) Code Value
>(0008,0102) Coding Scheme Designator	>(0008,0102) Coding Scheme Designator	>(0008,0102) Coding Scheme Designator
>(0008,0104) Code Meaning	>(0008,0104) Code Meaning	>(0008,0104) Code Meaning
(0040,1001) Requested Procedure ID	(0040,0275) Request attributes sequence > (0040,1001) Requested Procedure ID	(0040,0270) Scheduled Step Attributes Sequence > (0040,1001) Requested Procedure ID
(0040,1010) Names of Intended Recipients of Results	(0040,1010) Names of Intended Recipients of Results	(0040,1010) Names of Intended Recipients of Results
(0040,1400) Requested Procedure Comments	(0040,1400) Requested Procedure Comments	(0040,1400) Requested Procedure Comments
(0008,0050) Accession Number	(0008,0050) Accession Number	(0040,0270) Scheduled Step Attributes Sequence > (0008,0050) Accession Number

(0008,0090) Refer (0008,0090) Referring Physician's Name		N/A
(0032,1032) Requesting Physician	(0032,1032) Requesting Physician	N/A
(0032,1033) Requesting Service	(0032,1033) Requesting Service	N/A
(0040,2400) Imaging Service Request Comments	(0040,2400) Imaging Service Request Comments	N/A
(0008,0005) Specific Character Set	ISO_IR 100 *	N/A

* The value for the specific character set attribute is stored on images only if configured by the user to be sent to the HIS/RIS.

** The value of Study instance UID will be originated from the MWL only if configured to be sent to the HIS/RIS and the patient details are NOT changed by the user after acquiring the MWL data, on all other cases a new UID will be generated by the System on the Images and MPPS.

*** The modality attribute is used for a MWL matching purposes only. It is generated by the system.

8.1.8 Coerced/Modified fields

Brilliance™ Workspace allows the operator to modify attributes of the stored images; see table below. Modified images retain their original Study, Series and Image UID.

Table 153: Modifiable Attributes

Attribute Name	Attribute Tag
Accession Number	0008,0050
Study Description	0008,1030
Operators Name	0008,1070
Patient's Name	0010,0010
Patient ID	0010,0020
Patient's Birth Date	0010,0030
Patient's Sex	0010,0040
Other Patient Ids	0010,1000
Patient's Age	0010,1010
Patient's Size	0010,1020
Patient's Weight	0010,1030
Requesting Physician	0032,1032
Requesting Service	0032,1033

8.1.9 Tumor Localization Curve Module information

NOTICE: The implementation of this module is intended for Philips Medical Systems use only. Further development with this module or maintenance of existing implementation may be discontinued at any time without notice at the discretion of Philips Medical Systems. Any vendor making use of this interface for the purpose of importing data to their system may do so with the explicit understanding of the statements in this paragraph.

The Curve module is required to be part of all CT Images that contain Structure Set contour and/or Plan isocenter information only if the CT Images are being sent to the Voxel Q workstation.

The Voxel Q workstation does not have the ability to import RT data through typical DICOM RT methods. As a result the curve module transfer is a necessary proprietary-like transfer of information.

The following values for the curve module is only sent to nodes configured as Voxel Q. The Curve Module differs slightly for contour information or isocenter information. These two types are described below.

The group number “50xx” specifies a DICOM Repeating Group. This Group is repeated for each curve sent and repeats with even numbers only. For example if three curves are sent, their corresponding DICOM group numbers are 5000, 5002, and 5004. There is a limit of 16 total organs sent per slice due to use of only even numbered group 5000 tags.

The way the curve module is constructed violates the DICOM standard because the Value Multiplicity for Curve Description (50xx,0022) is 1, however for historical reasons and compatibility with the Voxel Q workstation we must send 2 values when sending contour data.

Table 154: Curve Module for Contours

Attribute Name	Tag	VR	Value	Presence of Value	Source
Curve Dimensions	50xx,0005	US	“2”	CONF	AUTO
Number of Points	50xx,0010	US		CONF	AUTO
Type of Data	50xx,0020	CS	“EXTERNAL” or “ROI”	CONF	AUTO
Curve Description	50xx,0022	LO	<Organ Name> \ <Color Index>	CONF	AUTO
Data Value Representation	50xx,0103	US	“0002H”	CONF	AUTO
Curve Data	50xx,3000	OW		CONF	AUTO

Table 155: Contour Color Indices

This table describes the color index value used in Curve Description (50xx,0022)

Color Index	Application Color Name Value	RGB Value
1	magenta	(210,0,255)
2	violet	(130,0,255)
3	dark blue	(130,0,255)
4	blue	(0,108,255)
5	light blue	(0,148,255)
6	aqua	(0,228,255)
7	blue-green	(0,255,202)
8	green	(0,255,122)
9	light green	(96,255,0)
10	yellow-green	(176,255,0)
11	yellow	(236,255,0)
12	gold	(255,214,0)
13	rust	(255,154,0)
14	orange	(255,94,0)
15	red	(255,34,0)

Table 156: Curve Module for Isocenters

The specification for Isocenter Data is two Isocenter points of three dimensions each. The two isocenter points are sent: “Marked” and “Final” in that order. Thus 6 floating point double values will be sent in the order shown below.

Example:

marked_x, marked_y, marked_z location of slice closest to marked Isocenter,
final_x, final_y, final_z location of slice closest to final Isocenter.

Attribute Name	Tag	VR	Value	Presence of Value	Source
Curve Dimensions	50xx,0005	US	"3"	CONF	AUTO
Number of Points	50xx,0010	US	"2"	CONF	AUTO
Type of Data	50xx,0020	CS	"ISOCENTER"	CONF	AUTO
Curve Description	50xx,0022	LO		CONF	AUTO
Data Value Representation	50xx,0103	US	"0003H"	CONF	AUTO
Curve Data	50xx,3000	OW		CONF	AUTO

8.2 Dictionary of Private Attributes

Attribute Name	Tag	VR	VM	Description
DLP	00E1:1021	DS	1	Dose Length Product (in mGy-cm)

8.3 Coded Terminology and Templates

Not applicable.

8.4 Grayscale Image consistency

Not applicable.

8.5 Standard Extended/Specialized/Private SOPs

No Specialized or Private SOP Classes are supported.

8.5.1 CT Image Storage SOP Class

The CT Image Storage SOP Class is extended to create a Standard Extended SOP class by addition of the standard and private attributes to the created SOP Instances as documented in section 8.1 and section 8.2

8.6 Private Transfer Syntaxes

1. No Private Transfer Syntaxes are supported