DICOM

Conformance Statement

ViewForum R5.1 with
Philips Orthopaedic Applications R1.2



Issued by:

Philips Medical Systems Nederland B.V.
Medical IT, Interoperability

Building QV-282
P.O. Box 10.000
5680 DA Best
The Netherlands

email: dicom@philips.com
Internet: <http://www.medical.philips.com/>

Document Number: XPR 080-050416.03
Created on: 31 January 2006

1. DICOM CONFORMANCE STATEMENT OVERVIEW

The ViewForum Release 5.1 system is a comprehensive range of hardware and software modules that allow for tailored clinical solutions. The software applications are categorized in packages, for instance the Volume package for CT/MR images. It is also possible to calculate the volume of a segmented 3D object. The hardware consists of a PC Windows workstation.

ViewForum R5.1 provides the following DICOM data exchange features:

- It receives images sent to it by remote systems (e.g. workstations or imaging modalities) and stores them in a database.
- It allows the operator to copy images from the database to remote databases and vice versa. For this purpose the operator is able to query remote databases.
- It allows a remote system to query the ViewForum R5.1 database and to retrieve images from it.
- It allows the operator to print images stored in the database on a DICOM printer.
- It is able to read and write DICOM CD-RW disks.
- It is able to read and write DICOM DVD-RW disks.

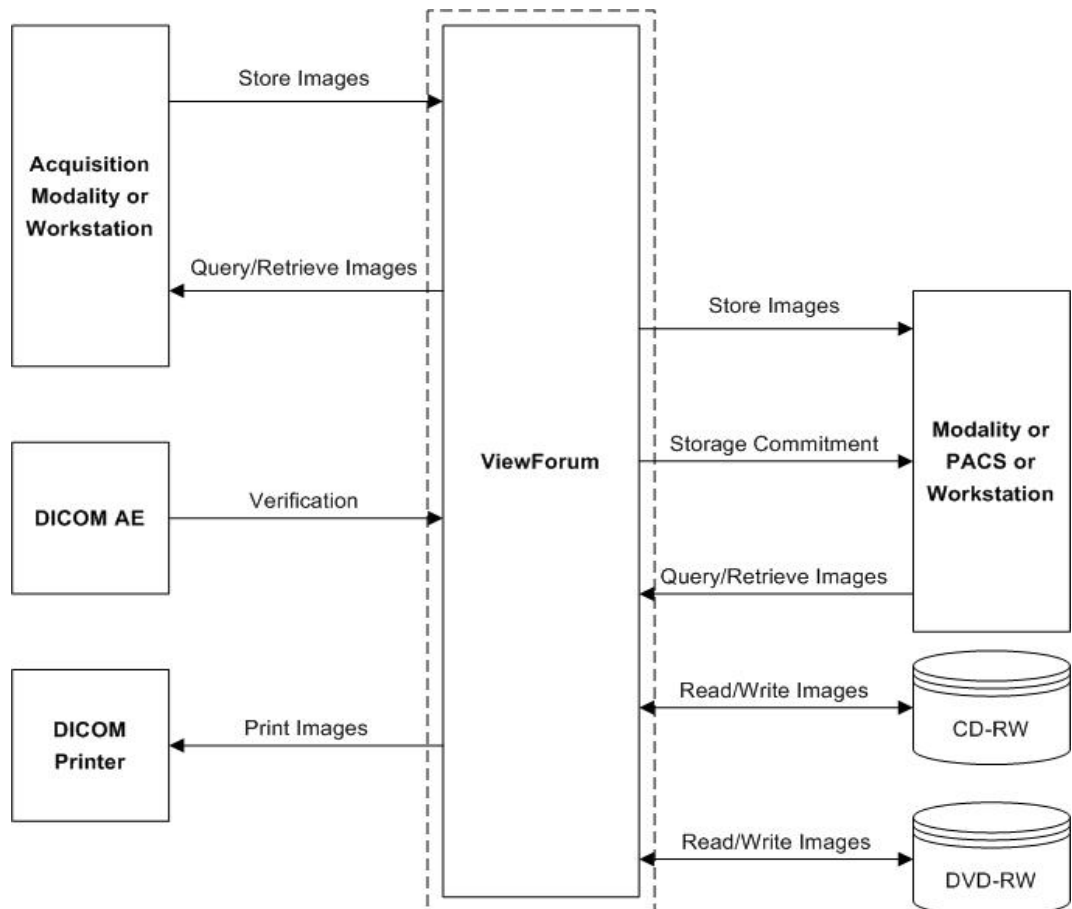

Figure 1: ViewForum R5.1 in a DICOM Network

ViewForum R5.1 allows the operator also to view, analyze and process the images stored in the database. Some advanced analysis and processing applications are primarily designed for images generated by Philips equipment when sent to the ViewForum R5.1.

This DICOM Conformance Statement describes the DICOM conformance of the ViewForum R5.1 platform. Application package specific DICOM conformance is described in separate Conformance Statements.

Table 1 presents an overview of all network services and the applicable SOP classes as provided by ViewForum R5.1.

Table 1: Network Services

SOP Class		User of Service (SCU)	Provider of Service (SCP)
Name	UID		
Storage			
Computed Radiography Image Storage	1.2.840.10008.5.1.4.1.1.1	Yes	Yes
Digital X-Ray Image Storage – for Presentation	1.2.840.10008.5.1.4.1.1.1.1	Yes	Yes
CT Image Storage	1.2.840.10008.5.1.4.1.1.2	Yes	Yes
Ultrasound Multi-frame Image Storage	1.2.840.10008.5.1.4.1.1.3.1	Yes	Yes
MR Image Storage	1.2.840.10008.5.1.4.1.1.4	Yes	Yes
Ultrasound Image Storage	1.2.840.10008.5.1.4.1.1.6.1	Yes	Yes
Secondary Capture Image Storage	1.2.840.10008.5.1.4.1.1.7	Yes	Yes
Grayscale Softcopy Presentation State Storage	1.2.840.10008.5.1.4.1.1.11.1	Yes	Yes
X-Ray Angiographic Image Storage	1.2.840.10008.5.1.4.1.1.12.1	Yes	Yes
X-Ray Radiofluoroscopic Image Storage	1.2.840.10008.5.1.4.1.1.12.2	Yes	Yes
Private Storage			
Specialized X-Ray	1.3.46.670589.2.3.1.1	Yes	Yes
CX Image	1.3.46.670589.2.4.1.1	Yes	Yes
3D Volume Storage	1.3.46.670589.5.0.1.1	Yes	Yes
3D Volume Object Storage	1.3.46.670589.5.0.2.1	Yes	Yes
Surface Storage	1.3.46.670589.5.0.3.1	Yes	Yes
MR Cardio Storage	1.3.46.670589.5.0.8.1	Yes	Yes
CT Synthetic Image	1.3.46.670589.5.0.9	Yes	Yes
MR Synthetic Image	1.3.46.670589.5.0.10	Yes	Yes
MR Cardio Analysis Storage	1.3.46.670589.5.0.11.1	Yes	Yes
CX Synthetic Image	1.3.46.670589.5.0.12	Yes	Yes
Perfusion	1.3.46.670589.5.0.13	Yes	Yes
Perfusion Analysis	1.3.46.670589.5.0.14	Yes	Yes
Query/Retrieve			
Patient Root Query/Retrieve Information Model – FIND	1.2.840.10008.5.1.4.1.2.1.1	Yes	Yes
Patient Root Query/Retrieve Information Model – MOVE	1.2.840.10008.5.1.4.1.2.1.2	Yes	Yes
Study Root Query/Retrieve Information Model – FIND	1.2.840.10008.5.1.4.1.2.2.1	Yes	Yes
Study Root Query/Retrieve Information Model – MOVE	1.2.840.10008.5.1.4.1.2.2.2	Yes	Yes
Patient/Study Only Query/Retrieve Information Model – FIND	1.2.840.10008.5.1.4.1.2.3.1	Yes	Yes
Patient/Study Only Query/Retrieve Information Model – MOVE	1.2.840.10008.5.1.4.1.2.3.2	Yes	Yes

SOP Class		User of Service (SCU)	Provider of Service (SCP)
Name	UID		
Workflow Management			
Storage Commitment Push Model	1.2.840.10008.1.20.1	Yes	No
Verification	1.2.840.10008.1.1	No	Yes
Print Management			
Basic Grayscale Print Management (Meta)	1.2.840.10008.5.1.1.9	Yes	No
> Basic Film Session	1.2.840.10008.5.1.1.1	Yes	No
> Basic Film Box	1.2.840.10008.5.1.1.2	Yes	No
> Basic Grayscale Image Box	1.2.840.10008.5.1.1.4	Yes	No
> Printer	1.2.840.10008.5.1.1.16	Yes	No
Basic Color Print Management (Meta)	1.2.840.10008.5.1.1.18	Yes	No
> Basic Film Session	1.2.840.10008.5.1.1.1	Yes	No
> Basic Film Box	1.2.840.10008.5.1.1.2	Yes	No
> Basic Color Image Box	1.2.840.10008.5.1.1.4.1	Yes	No
> Printer	1.2.840.10008.5.1.1.16	Yes	No
Presentation LUT	1.2.840.10008.5.1.1.23	Yes	No

The following table lists the Supported Media Storage Application Profiles (with roles).

Table 2: Media Services

Media Storage Application Profile	Write Files (FSC / FSU)	Read Files (FSR)	Supported Media
CD – R Disk			
General Purpose CD-R	YES / YES	YES	CD
DVD Disk			
General Purpose DVD-JPEG	YES / NO	YES	DVD+R / DVD+RW

Note: Not supported are the Media DVD -R / -RW.

2. TABLE OF CONTENTS

1.	DICOM CONFORMANCE STATEMENT OVERVIEW.....	1
2.	TABLE OF CONTENTS	4
3.	INTRODUCTION.....	7
3.1.	REVISION HISTORY	7
3.2.	AUDIENCE.....	7
3.3.	REMARKS	7
3.4.	DEFINITIONS, TERMS AND ABBREVIATIONS	8
3.5.	REFERENCES	9
4.	NETWORKING	10
4.1.	IMPLEMENTATION MODEL	10
4.1.1.	Application Data Flow	10
4.1.2.	Functional Definition of AE's	11
4.1.2.1.	Functional Definition of ViewForum AE	11
4.1.3.	Sequencing of Real World Activities	13
4.2.	AE SPECIFICATIONS	14
4.2.1.	ViewForum AE	14
4.2.1.1.	SOP Classes	14
4.2.1.2.	Association Policies	15
4.2.1.2.1.	General	15
4.2.1.2.2.	Number of Associations.....	16
4.2.1.2.3.	Asynchronous Nature	16
4.2.1.2.4.	Implementation Identifying Information.....	16
4.2.1.3.	Association Initiation Policy.....	17
4.2.1.3.1.	Export Images.....	17
4.2.1.3.1.1.	Description and Sequencing of Activities	17
4.2.1.3.1.2.	Proposed Presentation Contexts.....	18
4.2.1.3.1.3.	SOP Specific Conformance for SOP Classes	20
4.2.1.3.2.	Find Remote Images	23
4.2.1.3.2.1.	Description and Sequencing of Activities	23
4.2.1.3.2.2.	Proposed Presentation Contexts.....	23
4.2.1.3.2.3.	SOP Specific Conformance for SOP Classes	24
4.2.1.3.3.	Move Remote Images.....	26
4.2.1.3.3.1.	Description and Sequencing of Activities	26
4.2.1.3.3.2.	Proposed Presentation Contexts.....	26
4.2.1.3.3.3.	SOP Specific Conformance for SOP Classes	27
4.2.1.3.4.	Request Storage Commitment	28
4.2.1.3.4.1.	Description and Sequencing of Activities	28
4.2.1.3.4.2.	Proposed Presentation Contexts.....	29
4.2.1.3.4.3.	SOP Specific Conformance for SOP Class.....	30
4.2.1.3.5.	Print Images`	31
4.2.1.3.5.1.	Description and Sequencing of Activities	31
4.2.1.3.5.2.	Proposed Presentation Contexts.....	32
4.2.1.3.5.3.	SOP Specific Conformance Printer SOP Class	32
4.2.1.3.5.4.	SOP Specific Conformance Basic Film Session SOP Class.....	33
4.2.1.3.5.5.	SOP Specific Conformance Basic Film Box SOP Class	33
4.2.1.3.5.6.	SOP Specific Conformance Basic Grayscale Image Box SOP Class.....	35
4.2.1.3.5.7.	SOP Specific Conformance Basic Color Image Box SOP Class.....	36
4.2.1.3.5.8.	SOP Specific Conformance Presentation LUT SOP Class.....	37

4.2.1.3.6.	Request Printer Status.....	38
4.2.1.3.6.1.	Description and Sequencing of Activities	38
4.2.1.3.6.2.	Proposed Presentation Contexts.....	39
4.2.1.3.6.3.	SOP Specific Conformance for SOP Class.....	39
4.2.1.4.	Association Acceptance Policy	40
4.2.1.4.1.	Request Verification.....	40
4.2.1.4.1.1.	Description and Sequencing of Activities	40
4.2.1.4.1.2.	Accepted Presentation Contexts	41
4.2.1.4.1.3.	SOP Specific Conformance for SOP Class.....	42
4.2.1.4.2.	Import Images.....	42
4.2.1.4.2.1.	Description and Sequencing of Activities	42
4.2.1.4.2.2.	Accepted Presentation Contexts	43
4.2.1.4.2.3.	SOP Specific Conformance for SOP Classes	44
4.2.1.4.3.	Query Local Images.....	46
4.2.1.4.3.1.	Description and Sequencing of Activities	46
4.2.1.4.3.2.	Accepted Presentation Contexts	47
4.2.1.4.3.3.	SOP Specific Conformance for SOP Classes	47
4.2.1.4.4.	Retrieve Local Images.....	49
4.2.1.4.4.1.	Description and Sequencing of Activities	49
4.2.1.4.4.2.	Accepted Presentation Contexts	50
4.2.1.4.4.3.	SOP Specific Conformance for SOP Classes	51
4.3.	NETWORK INTERFACES.....	52
4.3.1.	Physical Network Interface	52
4.4.	CONFIGURATION	52
4.4.1.	AE Title/Presentation Address Mapping	52
4.4.1.1.	Local AE Titles	52
4.4.1.2.	Remote AE Title/Presentation Address Mapping	53
4.4.1.2.1.	Remote Association Initiators	53
4.4.1.2.2.	Remote Association Acceptors.....	53
4.4.2.	Parameters.....	53
5.	MEDIA INTERCHANGE	55
5.1.	IMPLEMENTATION MODEL	55
5.1.1.	Application Data Flow	55
5.1.2.	Functional Definitions of AE's	57
5.1.2.1.	Functional Definition of ViewForum AE	57
5.1.3.	Sequencing of Real World Activities.....	58
5.1.4.	File Meta Information for Implementation Class and Version.....	58
5.2.	AE SPECIFICATIONS	59
5.2.1.	ViewForum AE	59
5.2.1.1.	File Meta Information for the ViewForum AE.....	59
5.2.1.2.	Real-World Activities.....	59
5.2.1.2.1.	Display Directory.....	59
5.2.1.2.1.1.	Media Storage Application Profile	60
5.2.1.2.1.1.1.	Options.....	60
5.2.1.2.2.	Write Images.....	60
5.2.1.2.2.1.	Media Storage Application Profile	60
5.2.1.2.2.1.1.	Options.....	60
5.2.1.2.3.	Read Images.....	61
5.2.1.2.3.1.	Media Storage Application Profile	61
5.2.1.2.3.1.1.	Options.....	61

5.3.	AUGMENTED AND PRIVATE APPLICATION PROFILES	61
5.3.1.	Augmented Application Profiles	61
5.3.2.	Private Application Profiles	61
5.4.	MEDIA CONFIGURATION	61
6.	SUPPORT OF CHARACTER SETS	62
7.	SECURITY	63
7.1.	SECURITY PROFILES	63
7.2.	ASSOCIATION LEVEL SECURITY.....	63
7.3.	APPLICATION LEVEL SECURITY	63
8.	ANNEXES.....	64
8.1.	IOD CONTENTS	64
8.1.1.	Created SOP Instances	64
8.1.1.1.	Secondary Capture Image Storage SOP Class.....	64
8.1.1.2.	Grayscale Softcopy Presentation State Storage SOP Class.....	71
8.1.2.	Attribute Mapping.....	75
8.1.3.	Coerced/Modified fields.....	75
8.2.	DATA DICTIONARY OF PRIVATE ATTRIBUTES	79
8.3.	CODED TERMINOLOGY AND TEMPLATES.....	79
8.4.	GRAYSCALE IMAGE CONSISTENCY	79
8.5.	STANDARD EXTENDED/SPECIALIZED/PRIVATE SOPS.....	79
8.6.	PRIVATE TRANSFER SYNTAXES.....	79
9.	ANNEXES PHILIPS ORTHOPAEDIC APPLICATIONS	80
9.1.1.	Created SOP Instances	80
9.1.1.1.	Secondary Capture Image IOD.....	80
9.1.2.	Usage of Attributes from Received IOD's	85
9.1.2.1.	Folder Contents.....	85
9.1.2.2.	Supported SOP Classes	86
9.1.2.2.1.	Leg Osteotomy planning.....	86
9.1.2.2.2.	Lower extremity measurements	86
9.1.2.2.3.	Hip Implant planning	87
9.1.2.2.4.	Viewing	87
9.1.2.3.	Information per SOP Class	87
9.1.2.3.1.	Computed Radiography Image.....	87
9.1.2.3.2.	Digital X-Ray Image	88
9.1.2.3.3.	X-Ray Radiofluoroscopic image	88
9.1.2.3.4.	X-Ray Angiographic Image.....	89
9.1.3.	Attribute Mapping	89
9.1.4.	Coerced/Modified fields.....	89
9.2.	DATA DICTIONARY OF PRIVATE ATTRIBUTES	90
9.3.	CODED TERMINOLOGY AND TEMPLATES.....	90
9.4.	GRAYSCALE IMAGE CONSISTENCY	90
9.5.	STANDARD EXTENDED/SPECIALIZED/PRIVATE SOPS.....	90
9.6.	PRIVATE TRANSFER SYNTAXES.....	90

3. INTRODUCTION

3.1. Revision History

Table 3: Revision History

Document Version	Date of Issue	Author	Description
00	12 December 2005	PMS MIT-IO	Preliminary version of the DICOM Conformance Statement for ViewForum Release 5.1 with plugin Philips Orthopaedic Application R1.2
01	15 December-2005	PMS MIT-IO	Version after review
02	16 December 2005	PMS MIT-IO	Final version Preliminary
03	31 January 2006	PMS MIT-IO	Final version

3.2. Audience

This DICOM Conformance Statement is intended for:

- (Potential) customers
- System integrators of medical equipment
- Marketing staff interested in system functionality
- Software designers implementing DICOM interfaces

It is assumed that the reader is familiar with the DICOM standard.

3.3. Remarks

The DICOM Conformance Statement is contained in chapter 1 through 8 and follows the contents and structuring requirements of the DICOM Standard PS 3.2- XXXXX.

This DICOM Conformance Statement by itself does not guarantee successful interoperability of Philips equipment with non-Philips equipment. The user (or user's agent) should be aware of the following issues:

- **Interoperability**
Interoperability refers to the ability of application functions, distributed over two or more systems, to work successfully together. The integration of medical devices into an IT environment may require application functions that are not specified within the scope of DICOM. Consequently, using only the information provided by this Conformance Statement does not guarantee interoperability of Philips equipment with non-Philips equipment. It is the user's responsibility to analyze thoroughly the application requirements and to specify a solution that integrates Philips equipment with non-Philips equipment.
- **Validation**
Philips equipment has been carefully tested to assure that the actual implementation of the DICOM interface corresponds with this DICOM Conformance Statement. Where Philips equipment is linked to non-Philips equipment, the first step is to compare the relevant DICOM Conformance Statements. If the DICOM Conformance Statements indicate that successful information exchange

should be possible, additional validation tests will be necessary to ensure the functionality, performance, accuracy and stability of image and image related data. It is the responsibility of the user (or user's agent) to specify the appropriate test suite and to carry out the additional validation tests.

- **New versions of the DICOM Standard**

The DICOM Standard will evolve in future to meet the user's growing requirements and to incorporate new features and technologies. Philips is actively involved in this evolution and plans to adapt its equipment to future versions of the DICOM Standard. In order to do so, Philips reserves the right to make changes to its products or to discontinue its delivery.

The user should ensure that any non-Philips provider linking to Philips equipment also adapts to future versions of the DICOM Standard. If not, the incorporation of DICOM enhancements into Philips equipment may lead to loss of connectivity (in case of networking) and incompatibility (in case of media).

3.4. Definitions, Terms and Abbreviations

DICOM definitions, terms and abbreviations are used throughout this Conformance Statement. For a description of these, see NEMA PS 3.3-XXXX and PS 3.4-XXXX. The word Philips in this document refers to Philips Medical Systems. The following acronyms and abbreviations may be used in this document.

AE	Application Entity
CD	Compact Disc
CD-R	CD-Recordable
CT	Computed Tomography
DICOM	Digital Imaging and Communications in Medicine
DIMSE	DICOM Message Service Element
DVD-JPEG	Digital Video Disc – JPEG
EBE	DICOM Explicit VR Big Endian
ELE	DICOM Explicit VR Little Endian
FSC	File-set Creator
FSR	File-set Reader
FSU	File-set Updater
GUI	Graphical User Interface
HIPAA	Health Insurance Portability and Accountability Act
ILE	DICOM Implicit VR Little Endian
IHE	Integrating the Healthcare Enterprise
IOD	Information Object Definition
JPEG	Joint Photographic Experts Group
MR	Magnetic Resonance
N/A	Not applicable
NEMA	National Electrical Manufacturers Association
PDU	Protocol Data Unit
PMS(N)	Philips Medical Systems (Nederland B.V.)
Q/R	Query/Retrieve (Service Class)
RWA	Real-World Activity
SC	Secondary Capture
SCP	Service Class Provider
SCU	Service Class User
SOP	Service Object Pair
TCP/IP	Transmission Control Protocol/Internet Protocol

UID Unique Identifier

3.5. References

- [DICOM] Digital Imaging and Communications in Medicine (DICOM), Part 1 – 16 (NEMA PS 3.1 – PS 3.16),
National Electrical Manufacturers Association (NEMA)
Publication Sales 1300 N. 17th Street, Suite 1847
Rosslyn, Virginia. 22209, United States of America.
Note that at any point in time the official standard consists of the most recent yearly edition of the base standard (currently 2004) PLUS all the supplements and correction items that have been approved as Final Text

4. NETWORKING

This section contains the networking related services (vs. the media related ones).

4.1. Implementation model

The implementation model consists of three sections:

- The Application Data Flow Diagram, specifying the relationship between the ViewForum R5.1 Application Entity and the “external world” or Real-World activities,
- A functional description of the ViewForum R5.1 Application Entity, and
- the sequencing constraints among them.

4.1.1. Application Data Flow

The ViewForum R5.1 system consists of one single Application Entity only: the ViewForum Application Entity (ViewForum AE).

Figure 2 shows the Networking application data flow as a functional overview of the ViewForum AE. As depicted in Figure 2, the ViewForum AE incorporates the following functionality.

- After RWA Request Verification, the ViewForum AE as SCP provides standard Verification Service Class functionality to the requesting SCU.
- After RWA Import Images, the ViewForum AE as SCP provides standard Storage Service Class functionality to the requesting SCU.
- After RWA Query Local Images/Retrieve Local Images, the ViewForum AE as SCP provides standard Query/Retrieve Service Class functionality to the requesting SCU.
- After RWA Export Images (triggered by either the operator or RWA Retrieve Local Images), the ViewForum AE as SCU uses the Remote SCP Storage Service Class functionality to store Local Images on a Remote Database.
- After operator RWA Find Remote Images, the ViewForum AE as SCU uses the remote SCP Query/Retrieve Service Class functionality to query remote images.
- After operator RWA Move Remote Images, the ViewForum AE as SCU uses the remote SCP Query/Retrieve Service Class functionality to retrieve remote images.
- After operator RWA Request Storage Commitment, the ViewForum AE as SCU uses the remote SCP Storage Commitment Service Class functionality to commit remote images.
- After operator RWA Print Images, the ViewForum AE as SCU uses the remote Print Management Service Class to print local images.
- After operator RWA Request Printer Status, the ViewForum AE as SCU uses the remote Print Management Service Class to request the printer status.

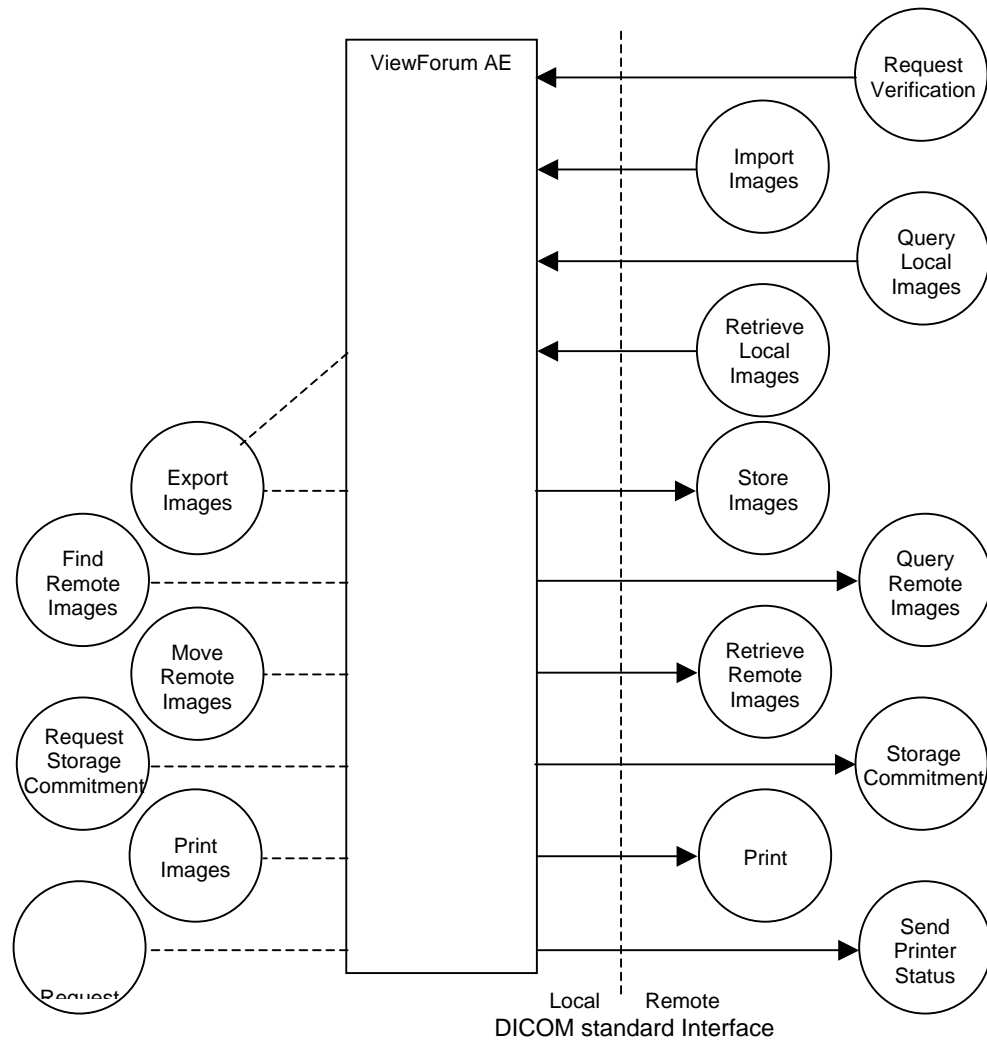

Figure 2: Networking Application Data Flow Diagram

4.1.2. Functional Definition of AE's

This section shall describe in general terms the functions to be performed by the AE, and the DICOM services used to accomplish these functions.

4.1.2.1. Functional Definition of ViewForum AE

The ViewForum AE is the one and only Application Entity within ViewForum R5.1. It includes the following service classes.

Verification Service Class

The ViewForum AE can perform the Verification service as SCP (RWA Request Verification).

A remote SCU shall request an association with the ViewForum AE for Verification SOP class. After accepting the association, the ViewForum AE shall receive and respond to the Verification request, and release the association when requested.

Storage Service Class

The ViewForum AE can perform the Storage service as SCP (RWA Import Images).

A remote SCU shall request an association with the ViewForum AE for Storage SOP classes. After accepting the association, the ViewForum AE shall receive the Storage requests, store the data in the local database, send the applicable Storage responses, and release the association when requested.

The ViewForum AE can perform the Storage service as SCU (RWA Export Images, triggered by operator or retrieve request).

The ViewForum AE shall request an association with the selected remote SCP for all applicable Storage SOP classes. When the association is accepted, the ViewForum AE shall send the Storage requests (including data from local database), receive the Storage responses and act accordingly, and release the association. Finally, if configured, the ViewForum AE shall request storage commitment per Storage Commitment service (ref. Storage Commitment service class).

Query/Retrieve Service Class

The ViewForum AE can perform the Query/Retrieve service as SCP (RWA Query Local Images and RWA Retrieve Local Images).

A remote SCU shall request an association with the ViewForum AE for Query/Retrieve SOP classes. After accepting the association, the ViewForum AE shall receive the Query/Retrieve requests. In case of a Retrieve request, the ViewForum AE shall request storage per Storage service as SCU (ref. Storage Service Class). Next, the ViewForum AE shall send the applicable Query/Retrieve responses, and release the association when requested.

The ViewForum AE can perform the Query/Retrieve service as SCU (RWA Find Remote Images and RWA Move Remote Images).

The ViewForum AE shall request an association with the selected remote SCP for the applicable (configured) Query/Retrieve SOP class. When the association is accepted, the ViewForum AE shall send the Query/Retrieve requests, receive the Query/Retrieve responses and act accordingly, and finally release the association.

The ViewForum AE fully supports the Cancel functionality, both as SCU and as SCP.

Storage Commitment Service Class

The ViewForum AE can perform the Storage Commitment service as SCU (RWA Request Storage Commitment).

The ViewForum AE shall request an association with the selected remote SCP for the Storage Commitment Push Model SOP class. When the association is accepted, the ViewForum AE shall send the Storage Commitment requests, receive the Storage Commitment responses and act accordingly, and release the association.

When the remote commitment actions have been finished, the remote SCP should request an association with the ViewForum AE (still SCU). After accepting the association, the ViewForum AE shall receive the Storage Commitment reports, and release the association when requested.

The Storage Commitment Service can be done Synchronous and Asynchronous. A detailed specification of the Storage Commitment is described in section 4.2.1.3.4 (RWA Request Storage Commitment).

Print Management Service Class

The ViewForum AE can perform the Print service as SCU (RWA Print Images).

The ViewForum AE shall request an association with the selected remote SCP (printer) for all applicable SOP classes of the applicable Print Management Meta SOP class. When the association is accepted, the ViewForum AE shall send the Print requests (including data from local database), receive the Print responses and act accordingly, and finally release the association.

The ViewForum AE can perform the Printer service as SCU (RWA Request Printer Status).

The ViewForum AE shall request an association with the selected remote SCP (printer) for the Printer SOP class. When the association is accepted, the ViewForum AE shall send the Get/Event Report request, receive the Printer responses and act accordingly, and finally release the association.

4.1.3. Sequencing of Real World Activities

This section shall contain a description of specific sequencing as well as potential constraints of Real-World Activities, including any applicable user interactions, as performed by the ViewForum AE.

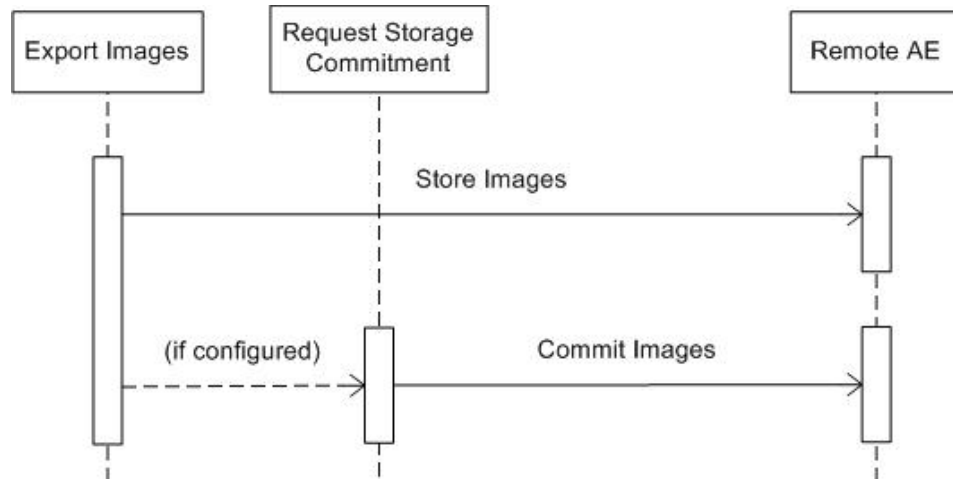

Figure 3: RWA Sequencing for Export Images

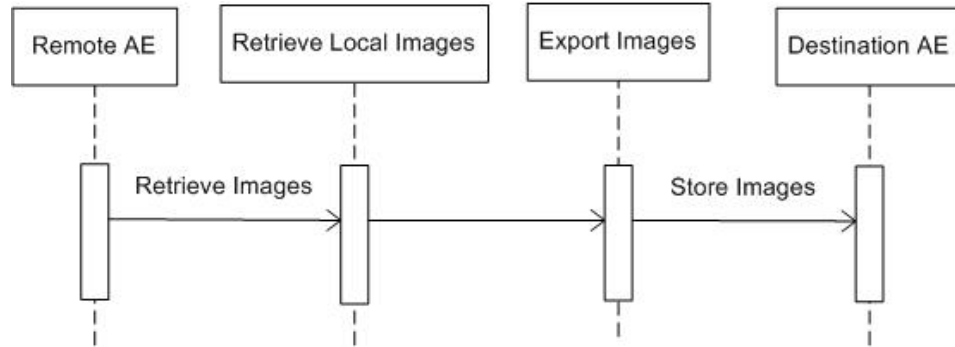

Figure 4: RWA Sequencing for Retrieve Local Images

4.2. AE Specifications

The next section in the DICOM Conformance Statement contains the specification of the one and only ViewForum R5.1 Application Entity: ViewForum AE.

4.2.1. ViewForum AE

Every detail of this specific Application Entity shall be completely specified under this section.

4.2.1.1. SOP Classes

This Application Entity provides extended Standard Conformance to the following SOP classes.

Table 4: SOP Classes for ViewForum AE

SOP Class Name	SOP Class UID	SCU	SCP
Storage Commitment Push Model	1.2.840.10008.1.20.1	Yes	No
Basic Grayscale Print Management (Meta)	1.2.840.10008.5.1.1.9	Yes	No
> Basic Film Session	1.2.840.10008.5.1.1.1	Yes	No
> Basic Film Box	1.2.840.10008.5.1.1.2	Yes	No
> Basic Grayscale Image Box	1.2.840.10008.5.1.1.4	Yes	No
> Printer	1.2.840.10008.5.1.1.16	Yes	No
Basic Color Print Management (Meta)	1.2.840.10008.5.1.1.18	Yes	No
> Basic Film Session	1.2.840.10008.5.1.1.1	Yes	No
> Basic Film Box	1.2.840.10008.5.1.1.2	Yes	No
> Basic Color Image Box	1.2.840.10008.5.1.1.4.1	Yes	No
> Printer	1.2.840.10008.5.1.1.16	Yes	No
Presentation LUT	1.2.840.10008.5.1.1.23	Yes	No
Computed Radiography Image Storage	1.2.840.10008.5.1.4.1.1.1	Yes	Yes
Digital X-Ray Image Storage – for Presentation	1.2.840.10008.5.1.4.1.1.1.1	Yes	Yes
CT Image Storage	1.2.840.10008.5.1.4.1.1.2	Yes	Yes
Ultrasound Multi-frame Image Storage	1.2.840.10008.5.1.4.1.1.3.1	Yes	Yes
MR Image Storage	1.2.840.10008.5.1.4.1.1.4	Yes	Yes
Ultrasound Image Storage	1.2.840.10008.5.1.4.1.1.6.1	Yes	Yes
Secondary Capture Image Storage	1.2.840.10008.5.1.4.1.1.7	Yes	Yes

SOP Class Name	SOP Class UID	SCU	SCP
Grayscale Softcopy Presentation State Storage	1.2.840.10008.5.1.4.1.1.11.1	Yes	Yes
X-Ray Angiographic Image Storage	1.2.840.10008.5.1.4.1.1.12.1	Yes	Yes
X-Ray Radiofluoroscopic Image Storage	1.2.840.10008.5.1.4.1.1.12.2	Yes	Yes
Patient Root Query/Retrieve Information Model – FIND	1.2.840.10008.5.1.4.1.2.1.1	Yes	Yes
Patient Root Query/Retrieve Information Model – MOVE	1.2.840.10008.5.1.4.1.2.1.2	Yes	Yes
Study Root Query/Retrieve Information Model – FIND	1.2.840.10008.5.1.4.1.2.2.1	Yes	Yes
Study Root Query/Retrieve Information Model – MOVE	1.2.840.10008.5.1.4.1.2.2.2	Yes	Yes
Patient/Study Only Query/Retrieve Information Model – FIND	1.2.840.10008.5.1.4.1.2.3.1	Yes	Yes
Patient/Study Only Query/Retrieve Information Model – MOVE	1.2.840.10008.5.1.4.1.2.3.2	Yes	Yes
Specialized X-Ray	1.3.46.670589.2.3.1.1	Yes	Yes
CX Image	1.3.46.670589.2.4.1.1	Yes	Yes
3D Volume Storage	1.3.46.670589.5.0.1.1	Yes	Yes
3D Volume Object Storage	1.3.46.670589.5.0.2.1	Yes	Yes
Surface Storage	1.3.46.670589.5.0.3.1	Yes	Yes
MR Cardio Storage	1.3.46.670589.5.0.8.1	Yes	Yes
CT Synthetic Image	1.3.46.670589.5.0.9	Yes	Yes
MR Synthetic Image	1.3.46.670589.5.0.10	Yes	Yes
MR Cardio Analysis Storage	1.3.46.670589.5.0.11.1	Yes	Yes
CX Synthetic Image	1.3.46.670589.5.0.12	Yes	Yes
Perfusion	1.3.46.670589.5.0.13	Yes	Yes
Perfusion Analysis	1.3.46.670589.5.0.14	Yes	Yes

Note: Any SOP specific behavior is documented later in the Conformance Statement in the applicable SOP specific conformance section.

Remarks:

- During installation the list of available SOP classes can be configured per ViewForum R5.1 system. The SOP classes to be supported can be configured per remote station.
- The Private SOP classes may be stored in image archives, but are to be used by ViewForum R5.1 systems only!
- In case the remote SCP system does not support the import of a specific image storage SOP class, the ViewForum AE will convert and send such images as Secondary Capture images (if configured to do so).
- After storing images as SCU the ViewForum AE shall request Storage Commitment (only as configured).

4.2.1.2. Association Policies

This section shall contain a description of the General Association Establishment and Acceptance policies of the AE.

4.2.1.2.1. General

The DICOM standard application context shall be specified.

Table 5: DICOM Application Context

Application Context Name	1.2.840.10008.3.1.1.1
--------------------------	-----------------------

4.2.1.2.2. Number of Associations

The number of simultaneous associations, which an Application Entity may support as a SCU or SCP, shall be specified. Any rules governing simultaneity of associations shall be defined here.

Table 6: Number of Associations as an Association Initiator for ViewForum AE

Maximum number of simultaneous associations	3 *
---	-----

* As a result of local activities, ViewForum R5.1 will initiate at most 3 simultaneous associations. One association may be used to issue **query** requests, the other association may be used to issue **store or retrieve** requests, and another association may be used for **print** requests.

Furthermore, ViewForum R5.1 may initiate an association for each remote retrieve request, executed by ViewForum R5.1 as a C-MOVE operation. These associations are used to issue the C-STORE sub-operations implied by the retrieve requests. The number of simultaneous store associations for this retrieve purpose is principally not limited.

The number of simultaneous associations for Storage Commitment is configurable.

Table 7: Number of Associations as an Association Acceptor for ViewForum AE

Maximum number of simultaneous associations	Configurable
---	--------------

Nevertheless the number of simultaneous associations shall be limited by the available resources (CPU, memory, disk space).

4.2.1.2.3. Asynchronous Nature

ViewForum R5.1 does not support asynchronous operations, and will not perform asynchronous window negotiation.

Table 8: Asynchronous Nature as an Association Initiator for ViewForum AE

Maximum number of outstanding asynchronous transactions	N/A
---	-----

4.2.1.2.4. Implementation Identifying Information

Following Implementation Class UID and Version Name are defined.

Table 9: DICOM Implementation Class and Version for ViewForum AE

Implementation Class UID	1.3.46.670589.5.2.23
Implementation Version Name	ViewForum R4.3

4.2.1.3. Association Initiation Policy

ViewForum R5.1 shall initiate associations as a result of the following events.

- The operator or a remote (Query/Retrieve) application copies selected images from the ViewForum R5.1 database to another database; ref. section 4.2.1.3.1 Export Images.
- The operator queries a remote database; ref. section 4.2.1.3.2 Find Remote Images.
- The operator copies selected images from a remote database to another database; ref. section 4.2.1.3.3 Move Remote Images.
- The operator requests storage commitment of images on a remote database; ref. section 4.2.1.3.4 Request Storage Commitment.
- The operator requests to print selected images of the ViewForum R5.1 database; ref. section 4.2.1.3.5 Print Images.
- The operator requests the status of the selected printer, ref section 4.2.1.3.6 Request Printer Status.

4.2.1.3.1. Export Images

The ViewForum is able to write to any location known to the Operating System of the Workspot where it is installed and is aware of a number of locations where data can be stored e.g. local hard disk, network drives, CD drives. All of these should be accessible from writing, provided that writing is possible and the user has sufficient permission to write images.

4.2.1.3.1.1. Description and Sequencing of Activities

The RWA Export Images involves the storage of images from the local ViewForum R5.1 database to a remote system.

There are two ways for the ViewForum AE to initiate Export Images.

1. The operator is able to copy the images selected in a patient folder from the local ViewForum R5.1 database to another database by means of the copy tool in the ViewForum R5.1 data-handling tool. For each selected patient ViewForum R5.1 initiates an association to the selected peer entity, and uses it to send C-STORE requests and receive the associated C-STORE responses. The association is released when all selected images in the selected folder have been transmitted.
ViewForum R5.1 handles operator copy requests one after another.
2. A remote application copies images from the local ViewForum R5.1 database to another database by sending a C-MOVE request to ViewForum R5.1. For each received retrieve request ViewForum R5.1 initiates an association to the requested retrieve/move destination, and uses it to send C-STORE requests and receive associated C-STORE responses. The association is released when all instances, i.e. images and presentation states as selected by the retrieve request identifier, have been stored.
ViewForum R5.1 is able to simultaneously handle C-MOVE requests.

Along with the image data the ViewForum AE shall also export presentation state data. If the SCP supports the Grayscale Softcopy Presentation State storage SOP class then the applicable presentation state data will be transferred as such, otherwise the presentation state data will be merged with the image data before export.

Please refer to section 8.1.3, Coerced/Modified fields, for more information on presentation state storage.

If configured, the ViewForum AE shall also try and initiate a storage commitment of the stored image (after releasing the storage association). See section 4.2.1.3.4 (RWA Request Storage Commitment) for a detailed specification of the storage commitment.

Figure 5 shows the sequence of events after the operator or remote application initiates the RWA Export Images.

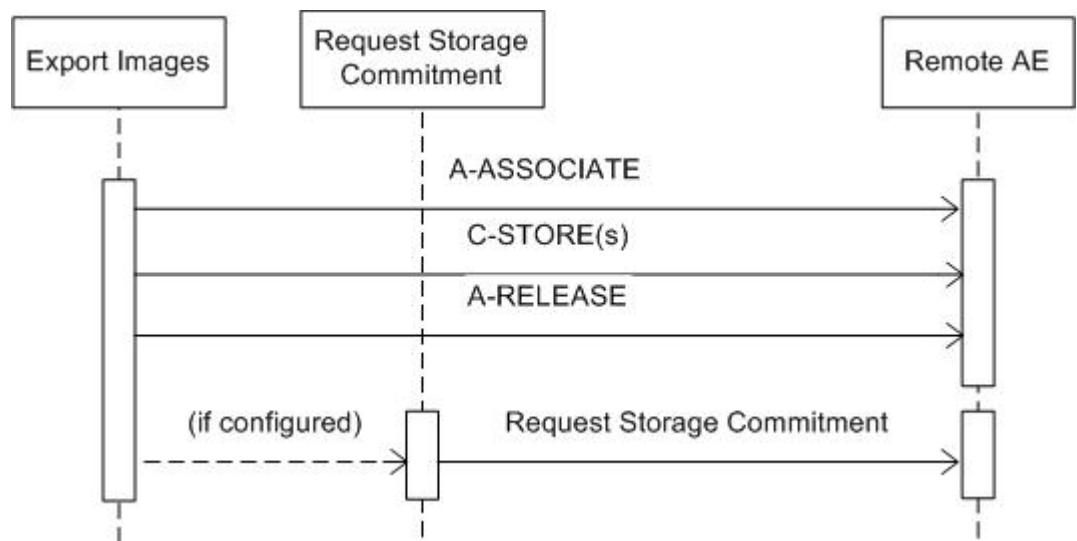

Figure 5: Sequencing of RWA Export Images

4.2.1.3.1.2. Proposed Presentation Contexts

Each time an association is initiated, the association initiator proposes a number of Presentation Contexts to be used on that association. The Presentation Contexts proposed by the ViewForum AE for Export Images are defined in Table 10.

Table 10: Proposed Presentation Contexts for Export Images

Presentation Context Table					
Abstract Syntax		Transfer Syntax		Role	Extended Negotiation
Name	UID	Name List (note)	UID List		
Computed Radiography Image Storage	1.2.840.10008.5.1.4.1.1.1	ILE ELE EBE	1.2.840.10008.1.2 1.2.840.10008.1.2.1 1.2.840.10008.1.2.2	SCU	None
Digital X-Ray Image Storage – for Presentation	1.2.840.10008.5.1.4.1.1.1.1	ILE ELE EBE	1.2.840.10008.1.2 1.2.840.10008.1.2.1 1.2.840.10008.1.2.2	SCU	None
CT Image Storage	1.2.840.10008.5.1.4.1.1.2	ILE ELE EBE	1.2.840.10008.1.2 1.2.840.10008.1.2.1 1.2.840.10008.1.2.2	SCU	None
MR Image Storage	1.2.840.10008.5.1.4.1.1.4	ILE ELE EBE	1.2.840.10008.1.2 1.2.840.10008.1.2.1 1.2.840.10008.1.2.2	SCU	None
Secondary Capture Image Storage	1.2.840.10008.5.1.4.1.1.7	ILE ELE EBE	1.2.840.10008.1.2 1.2.840.10008.1.2.1 1.2.840.10008.1.2.2	SCU	None
Grayscale Softcopy Presentation State Storage	1.2.840.10008.5.1.4.1.1.11.1	ILE ELE EBE	1.2.840.10008.1.2 1.2.840.10008.1.2.1 1.2.840.10008.1.2.2	SCU	None
X-Ray Angiographic Image Storage	1.2.840.10008.5.1.4.1.1.12.1	ILE ELE EBE	1.2.840.10008.1.2 1.2.840.10008.1.2.1 1.2.840.10008.1.2.2	SCU	None
X-Ray Radiofluoroscopic Image Storage	1.2.840.10008.5.1.4.1.1.12.2	ILE ELE EBE	1.2.840.10008.1.2 1.2.840.10008.1.2.1 1.2.840.10008.1.2.2	SCU	None
Specialized X-Ray	1.3.46.670589.2.3.1.1	ILE ELE EBE	1.2.840.10008.1.2 1.2.840.10008.1.2.1 1.2.840.10008.1.2.2	SCU	None
CX Image	1.3.46.670589.2.4.1.1	ILE ELE EBE	1.2.840.10008.1.2 1.2.840.10008.1.2.1 1.2.840.10008.1.2.2	SCU	None
3D Volume Storage	1.3.46.670589.5.0.1.1	ILE ELE EBE	1.2.840.10008.1.2 1.2.840.10008.1.2.1 1.2.840.10008.1.2.2	SCU	None
3D Volume Object Storage	1.3.46.670589.5.0.2.1	ILE ELE EBE	1.2.840.10008.1.2 1.2.840.10008.1.2.1 1.2.840.10008.1.2.2	SCU	None
Surface Storage	1.3.46.670589.5.0.3.1	ILE ELE EBE	1.2.840.10008.1.2 1.2.840.10008.1.2.1 1.2.840.10008.1.2.2	SCU	None
MR cardio Storage	1.3.46.670589.5.0.8.1	ILE ELE EBE	1.2.840.10008.1.2 1.2.840.10008.1.2.1 1.2.840.10008.1.2.2	SCU	None
CT Synthetic Image	1.3.46.670589.5.0.9	ILE ELE EBE	1.2.840.10008.1.2 1.2.840.10008.1.2.1 1.2.840.10008.1.2.2	SCU	None
MR Synthetic Image	1.3.46.670589.5.0.10	ILE ELE EBE	1.2.840.10008.1.2 1.2.840.10008.1.2.1 1.2.840.10008.1.2.2	SCU	None
MR Cardio Analysis Storage	1.3.46.670589.5.0.11.1	ILE ELE EBE	1.2.840.10008.1.2 1.2.840.10008.1.2.1 1.2.840.10008.1.2.2	SCU	None
CX Synthetic Image	1.3.46.670589.5.0.12	ILE ELE EBE	1.2.840.10008.1.2 1.2.840.10008.1.2.1 1.2.840.10008.1.2.2	SCU	None

Presentation Context Table					
Abstract Syntax		Transfer Syntax		Role	Extended Negotiation
Name	UID	Name List (note)	UID List		
Perfusion	1.3.46.670589.5.0.13	ILE ELE EBE	1.2.840.10008.1.2 1.2.840.10008.1.2.1 1.2.840.10008.1.2.2	SCU	None
Perfusion Analysis	1.3.46.670589.5.0.14	ILE ELE EBE	1.2.840.10008.1.2 1.2.840.10008.1.2.1 1.2.840.10008.1.2.2	SCU	None
Ultra sound Multi-frame Image Storage	1.2.840.10008.5.1.4.1.1.3.1	ILE ELE EBE JPEG Baseline (Note 1)	1.2.840.10008.1.2 1.2.840.10008.1.2.1 1.2.840.10008.1.2.2 1.2.840.10008.1.2.4.50	SCU	None
Ultra sound Image Storage	1.2.840.10008.5.1.4.1.1.6.1	ILE ELE EBE JPEG Baseline (Note 1)	1.2.840.10008.1.2 1.2.840.10008.1.2.1 1.2.840.10008.1.2.2 1.2.840.10008.1.2.4.50	SCU	None

Note : For performance reasons the ELE transfer syntax is preferred

Note1: Only for Photometric Interpretation of RGB and YBR_FULL_422. Therefore JPEG Baseline transfer syntax may NOT be configured for SCU systems that are capable of handling storage of monochrome images too.

4.2.1.3.1.3. SOP Specific Conformance for SOP Classes

Important remarks about the exported images:

- In case the remote system does not support modality specific image storage SOP class, the ViewForum AE will convert the images (if configured to do so) and send them via the Secondary Capture image storage SOP class. These Secondary Capture images and additional information (like graphics, text and important attribute information) are burnt-in (if configured). The original bit depth of the Secondary Capture image is kept. Note: only standard DICOM images can be converted, private SOP classes cannot be converted.
- In case of color images, all color-coding schemes are sent as they were received.
- Attributes e.g. Study Date and Study Time will be added to images to be exported (if not yet present). This is done because there are imaging systems relying on the existence of these attributes.
- On the export of an imported image the ViewForum adds private attributes to the image.
- The exported ViewForum R5.1 images do not contain Instance Number if the original images received from modalities do not contain this attribute or provide information in other attributes for ViewForum R5.1 to generate it.
- Exported CT/MR images relate Scanogram and Slice images in the following way: Attribute 'Referenced Image Sequence' is present in the slice images and points to the related Scanogram image. Note that Attribute 'Frame of Reference UID' in the Scanogram (Localiser image) and related image slices are not guaranteed to be equal; this depends on the source of the images.
- For Secondary Capture images only one Window Width and Window Centre value is exported.
- Please refer to section 8.1.3, Coerced/Modified fields, for more information on stored images.

Use of optional, private and retired attributes

The transmitted Storage SOP instances may include all optional elements specified in the DICOM standard, depending on the source of the images.

The transmitted Storage SOP instances may contain Retired and Private data elements, depending on the source of the images and of the ViewForum R5.1 configuration.

When exporting images the ViewForum AE can convert the transfer syntax according to the following table.

Table 11: Transfer Syntax Conversion

Syntax	Source	ILE	ELE	EBE	JPEG Baseline
Destination	/				
ILE		+	+	+	-
ELE		+	+	+	-
EBE		+	+	+	-
JPEG Baseline	*	+	+	+	-

- *JPEG Baseline is only supported for images with Photometric Interpretation of YBR_FULL_422.*
- *As ViewForum R5.1 internally stores the images in uncompressed format, the image data shall be compressed to JPEG (RGB to YBR_FULL_422) before export.*
- *Note that JPEG Baseline transfer syntax may NOT be configured for SCU systems that are capable of handling storage of monochrome images too.*

The store response status is saved in the log file; a user error will be displayed in the GUI.

The ViewForum AE will stop the transfer of the images and release the association as soon as it receives an unsuccessful store response status. In case that a remote application requested the transfer (by means of a C-MOVE request), a move response with status unsuccessful is sent to the retrieve requestor.

Following are the details regarding the specific conformance, including response behavior to all status codes, both from an application level and communication errors.

Table 12: DICOM Command Response Status Handling Behavior

Service Status	Further Meaning	Error Code	Behavior
Success	Storage is complete	0000	Continues with next store until completed thereafter the store job is marked as completed and the association is released.
Refused	Out of Resources	A7xx	The store job fails and the association is released. The reason is logged and reported to the user.
Error	Data set does not match SOP Class	A9xx	The store job fails and the association is released. The reason is logged and reported to the user.
	Cannot understand	Cxxx	The store job fails and the association is released. The reason is logged and reported to the user.
Warning	Coercion of Data Elements	B000	Continues with next store until completed thereafter the store job is marked as completed and the association is released.
	Elements discarded	B006	Continues with next store until completed thereafter the store job is marked as completed and the association is released.
	Data set does not match SOP class	B007	Continues with next store until completed thereafter the store job is marked as completed and the association is released.

Table 13: DICOM Command Communication Failure Behavior

Exception	Behavior
ARTIM Time-out	The store job fails in case of association setup. The reason is logged and reported to the user.
Reply Time-out	The store job fails and the association is aborted. The reason is logged and reported to the user.
Association Time-out SCU	The association is released.
Association aborted	The store job fails. The reason is logged and reported to the user.

4.2.1.3.2. Find Remote Images

4.2.1.3.2.1. Description and Sequencing of Activities

The RWA Find Remote Images involves the query of a remote system to find matching images in the remote database.

The operator queries a remote database by means of the query tool in the ViewForum R5.1 data handling facility. The ViewForum AE initiates an association to the selected peer entity and uses it to send Query (C-FIND) requests (and receive the associated responses). The association is released when the execution of the query completes (the Q/R dialog on the GUI is closed).

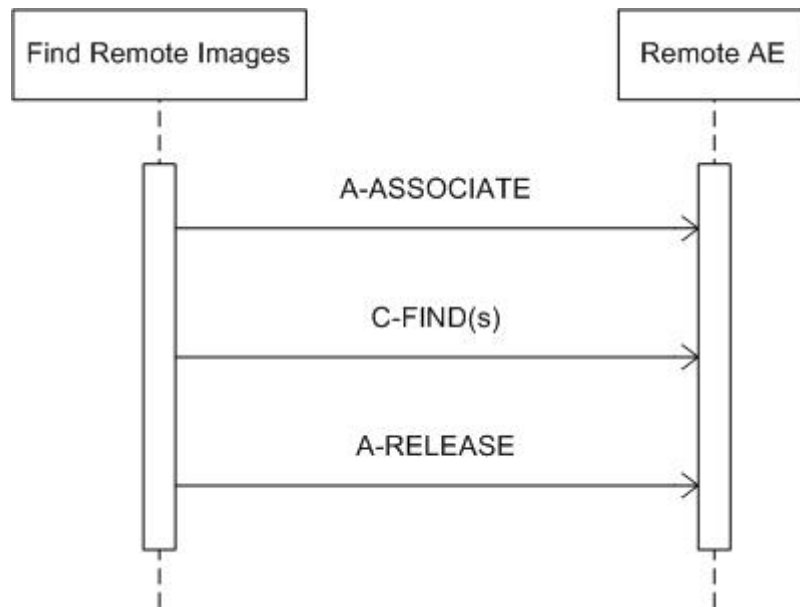

Figure 6: Sequencing of RWA Find Remote Images

4.2.1.3.2.2. Proposed Presentation Contexts

Each time an association is initiated, the association initiator proposes a number of Presentation Contexts to be used on that association. In this subsection, the Presentation Contexts proposed by the ViewForum AE for Find Remote Images are defined in Table 14.

Table 14: Proposed Presentation Contexts for Find Remote Images

Presentation Context Table					
Abstract Syntax		Transfer Syntax		Role	Extended Negotiation
Name	UID	Name List (note)	UID List		
Patient Root Query /Retrieve Information Model - FIND	1.2.840.10008.5.1.4.1.2.1.1	ILE ELE EBE	1.2.840.10008.1.2 1.2.840.10008.1.2.1 1.2.840.10008.1.2.2	SCU	None
Study Root Query /Retrieve Information Model - FIND	1.2.840.10008.5.1.4.1.2.2.1	ILE ELE EBE	1.2.840.10008.1.2 1.2.840.10008.1.2.1 1.2.840.10008.1.2.2	SCU	None
Patient/Study Only Query/Retrieve Information Model - FIND	1.2.840.10008.5.1.4.1.2.3.1	ILE ELE EBE	1.2.840.10008.1.2 1.2.840.10008.1.2.1 1.2.840.10008.1.2.2	SCU	None

Note: For performance reasons the ELE transfer syntax is preferred.

4.2.1.3.2.3. SOP Specific Conformance for SOP Classes

The ViewForum AE will not generate queries containing optional keys. The ViewForum AE will not generate relational queries.

In the following table the supported query keys for each query level are described. Universal matching shall be supported as default.

Table 15: Supported Query Keys

Query Level	Query Key		Type of Matching
	Name	Tag	
Patient	Patient's Name	0010,0010	Wild Card/ Universal
	Patient ID	0010,0020	Wild Card/ Universal
	Patient's Birth Date	0010,0030	-
	Patient's Sex	0010,0040	-
Study	Study Date	0008,0020	-
	Study Time	0008,0030	-
	Accession Number	0008,0050	-
	Modalities in Study	0008,0061	-
	Referring Physician's Name	0008,0090	-
	Study Description	0008,1030	-
	Study Instance UID	0020,000D	-
	Study ID	0020,0010	-
Series	Modality	0008,0060	-
	Station Name	0008,1010	-
	Performing Physician's Name	0008,1050	-
	Body Part Examined	0018,0015	-
	Protocol Name	0018,1030	-

Query Level	Query Key		Type of Matching
	Name	Tag	
Image	Series Instance UID	0020,000E	-
	Series Number	0020,0011	-
	Performed Procedure Step Start Date	0040,0244	-
	Performed Procedure Step ID	0040,0253	-
	SOP Class UID	0008,0016	-
	SOP Instance UID	0008,0018	-
	Content Date	0008,0023	-
	Content Time	0008,0033	-
	Instance Number	0020,0013	-

Do note that the query results screen will display all patients that have an empty Patient ID as one patient entry.

Following are the details regarding the specific conformance, including response behavior to all status codes, both from an application level and communication errors.

Table 16: DICOM Command Response Status Handling Behavior

Service Status	Further Meaning	Error Code	Behavior
Success	Matching is complete	0000	The find results are displayed.
Refused	Out of Resources	A700	No find results are displayed. The reason is logged.
Failed	Identifier does not match SOP class	A900	No find results are displayed. The reason is logged.
	Unable to process	Cxxx	No find results are displayed. The reason is logged.
Cancel	Matching terminated due to Cancel Request	FE00	No find results are displayed. The reason is logged.
Pending	Matches are continuing – Current match is supplied and any optional keys were supported in the same manner as required keys	FF00	The find command continues.
	Matches are continuing – Warning that one or more optional keys were not supported for existence and/or matching for this identifier	FF01	The find command continues.

Table 17: DICOM Command Communication Failure Behavior

Exception	Behavior
ARTIM Time-out	N/A
Reply Time-out	The query fails and the association is aborted. The reason is logged and reported to the user.
Association Time-out SCU	The association is released.
Association aborted	The query fails. The reason is logged and reported to the user.

4.2.1.3.3. Move Remote Images

4.2.1.3.3.1. Description and Sequencing of Activities

The RWA Move Remote Images involves the retrieve of images on a remote system by moving matching images from the remote database to another database.

The operator is able to copy the selected images in a patient folder from a remote database to another, local or remote, database by means of the copy tool in the ViewForum R5.1 data handling facility. The ViewForum AE initiates for each copy request an association to the selected peer entity (Remote AE) and uses it to send the Retrieve (C-MOVE) request (and receive the associated responses). An examination may contain both images and presentation states. The association is released after the final Retrieve (C-MOVE) response for the related request has been received (no more pending).

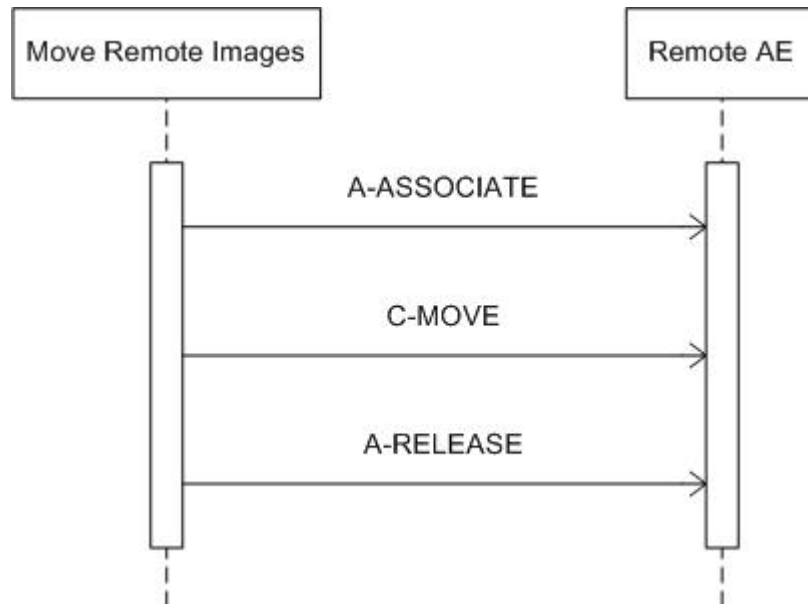

Figure 7: Sequencing of RWA Move Remote Images

4.2.1.3.3.2. Proposed Presentation Contexts

Each time an association is initiated, the association initiator proposes a number of Presentation Contexts to be used on that association. In this subsection, the Presentation Contexts proposed by the ViewForum AE for Move Remote Images are defined in Table 18.

Table 18: Proposed Presentation Contexts for Move Remote Images

Presentation Context Table					
Abstract Syntax		Transfer Syntax		Role	Extended Negotiation
Name	UID	Name List (note)	UID List		
Patient Root Query /Retrieve Information Model - MOVE	1.2.840.10008.5.1.4.1.2.1.2	ILE ELE EBE	1.2.840.10008.1.2 1.2.840.10008.1.2.1 1.2.840.10008.1.2.2	SCU	None
Study Root Query /Retrieve Information Model - MOVE	1.2.840.10008.5.1.4.1.2.2.2	ILE ELE EBE	1.2.840.10008.1.2 1.2.840.10008.1.2.1 1.2.840.10008.1.2.2	SCU	None
Patient/Study Only Query/Retrieve Information Model - MOVE	1.2.840.10008.5.1.4.1.2.3.2	ILE ELE EBE	1.2.840.10008.1.2 1.2.840.10008.1.2.1 1.2.840.10008.1.2.2	SCU	None

Note: For performance reasons the ELE transfer syntax is preferred.

4.2.1.3.3.3. SOP Specific Conformance for SOP Classes

The ViewForum AE provides standard conformance.

Following are the details regarding the specific conformance, including response behavior to all status codes, both from an application level and communication errors.

Table 19: DICOM Command Response Status Handling Behavior

Service Status	Further Meaning	Error Code	Behavior
Success	Sub-operations complete – No Failures	0000	The move job is marked as completed. The association is released.
Refused	Out of Resources – Unable to calculate number of matches	A701	The move job is marked as failed. The association is released. The reason is logged and reported to the user.
	Out of Resources – Unable to perform Sub-operations	A702	The move job is marked as failed. The association is released. The reason is logged and reported to the user.
	Move Destination unknown	A801	The move job is marked as failed. The association is released. The reason is logged and reported to the user.
Failed	Identifier does not match SOP class	A900	The move job is marked as failed. The association is released. The reason is logged and reported to the user.
	Unable to process	Cxxx	The move job is marked as failed. The association is released. The reason is logged and reported to the user.
Cancel	Sub-operations terminated due to Cancel Indication	FE00	The move job is marked as failed. The association is released. The reason is logged and reported to the user.
Warning	Sub-operations complete – One or more Failures	B000	The move job is marked as completed. The association is released.
Pending	Sub-operations are continuing	FF00	The move job continues.

Table 20: DICOM Command Communication Failure Behavior

Exception	Behavior
ARTIM Time-out	The move job fails in case of association setup. The reason is logged and reported to the user.
Reply Time-out	The move job fails and the association is aborted. The reason is logged and reported to the user.
Association Time-out SCU	N/A
Association aborted	The move job fails. The reason is logged and reported to the user.

4.2.1.3.4. Request Storage Commitment

4.2.1.3.4.1. Description and Sequencing of Activities

The RWA Request Storage Commitment involves the storage commitment of images on a remote system.

If configured, Storage Commitment will be initiated in a new association after closing the association of the related image storage (C-STORE). This new association will be open until the remote archive sends a storage commitment report (synchronous) or when the configured maximum time is passed. When this maximum configured period is passed, it is the responsibility of the remote archive to setup a new association with ViewForum R5.1 and send the storage commitment report (asynchronous).

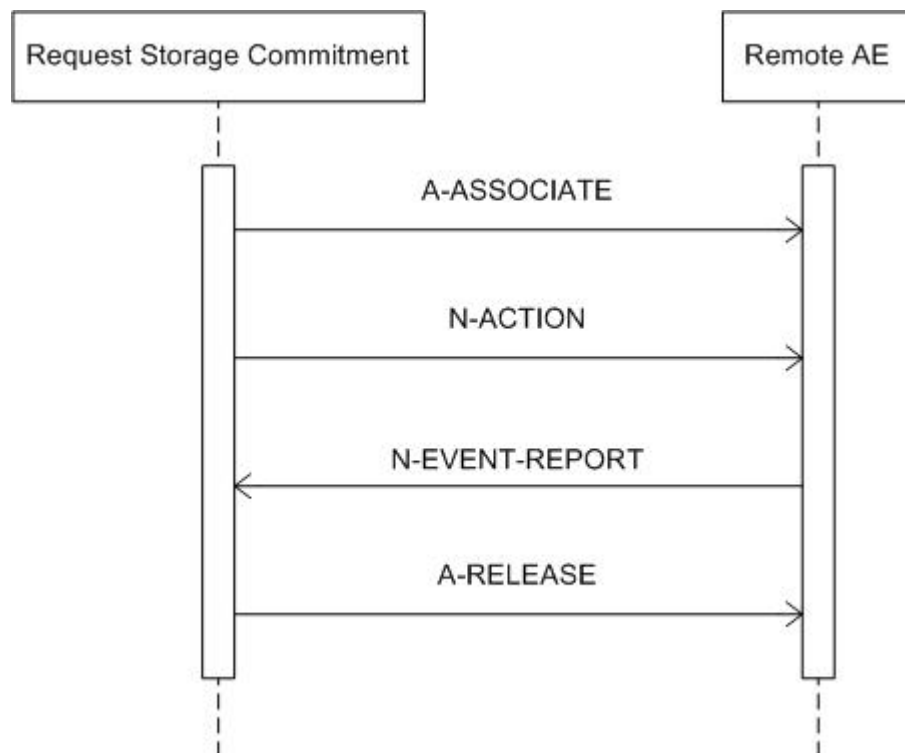

Figure 8: Sequencing of Synchronous RWA Request Storage Commitment

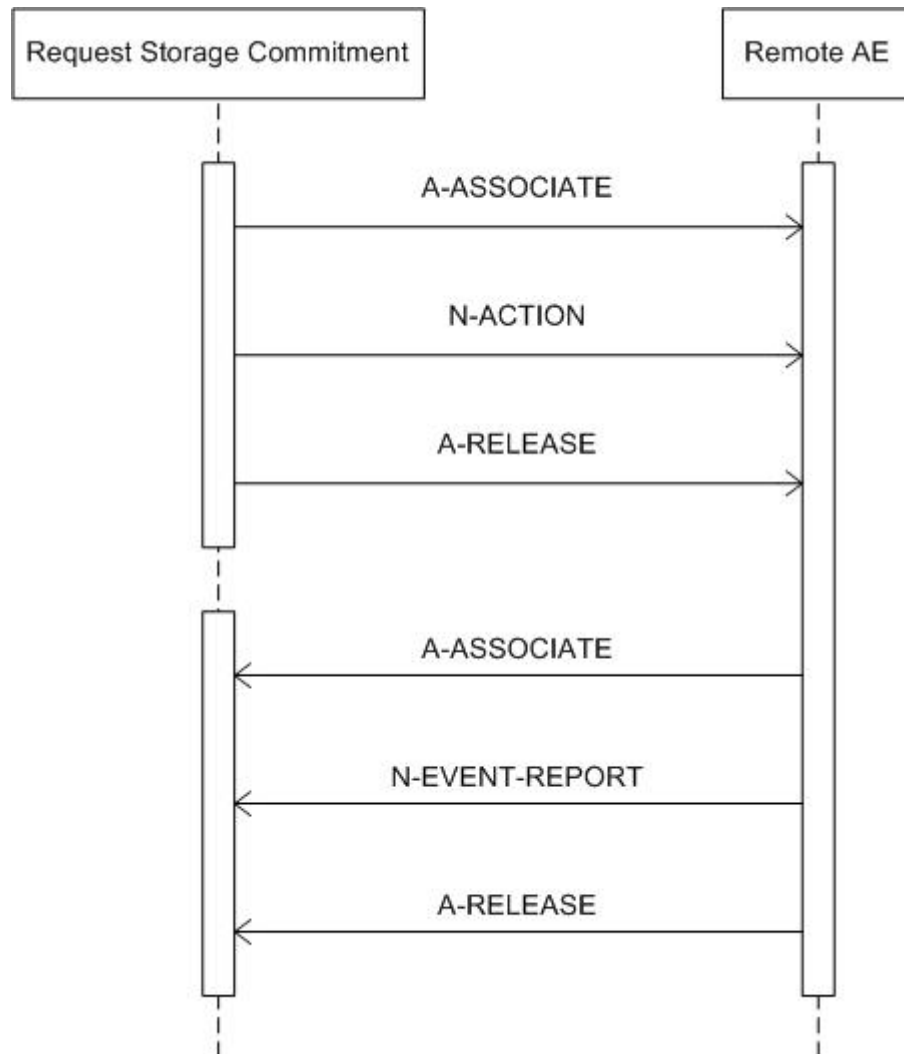

Figure 9: Sequencing of Asynchronous RWA Request Storage Commitment

4.2.1.3.4.2. Proposed Presentation Contexts

Each time an association is initiated, the association initiator proposes a number of Presentation Contexts to be used on that association. In this subsection, the Presentation Contexts proposed by the ViewForum AE for Request Storage Commitment are defined in Table 21.

Table 21: Proposed Presentation Contexts for Request Storage Commitment

Presentation Context Table					
Abstract Syntax		Transfer Syntax		Role	Extended Negotiation
Name	UID	Name List (note)	UID List		
Storage Commitment Push Model	1.2.840.10008.1.20.1	ILE ELE EBE	1.2.840.10008.1.2 1.2.840.10008.1.2.1 1.2.840.10008.1.2.2	SCU	None

Note: For performance reasons the ELE transfer syntax is preferred.

4.2.1.3.4.3. SOP Specific Conformance for SOP Class

The ViewForum AE provides standard conformance. In ViewForum R5.1 many remote nodes can be configured for storage Images. Per remote node one node can be configured to deliver the Storage Commitment service.

Following are the details regarding the specific conformance, including response behavior to all status codes, both from an application level and communication errors.

Table 22: DICOM Command Response Status Handling Behavior

Service Status	Further Meaning	Error Code	Behavior
Success	Operation complete	0000	Continues with waiting for storage commitment.
Failure	(any failure)	xxxx	The reason is logged.

The ViewForum AE does not take any more actions on receiving the N-EVENT-REPORT, even when failures exist (Event Type ID 2).

Table 23: DICOM Command Communication Failure Behavior

Exception	Behavior
ARTIM Time-out	The reason is logged.
Reply Time-out	The association is released. Continues with waiting for storage commitment.
Association Time-out SCU	The association is released. Continues with waiting for storage commitment.
Association aborted	Continues with waiting for storage commitment.

4.2.1.3.5. Print Images`

4.2.1.3.5.1. Description and Sequencing of Activities

The RWA Print Images involves the printing of images by sending the selected images to a Print Management SCP (i.e. printer). After selecting the print destination (out of choice list of configured printers) and some print parameters (depending on the configuration and the selected printer; these values can be configured too), the ViewForum AE shall initiate an association to the selected printer and use it to send the print job. ViewForum R5.1 also has an option for print preview.

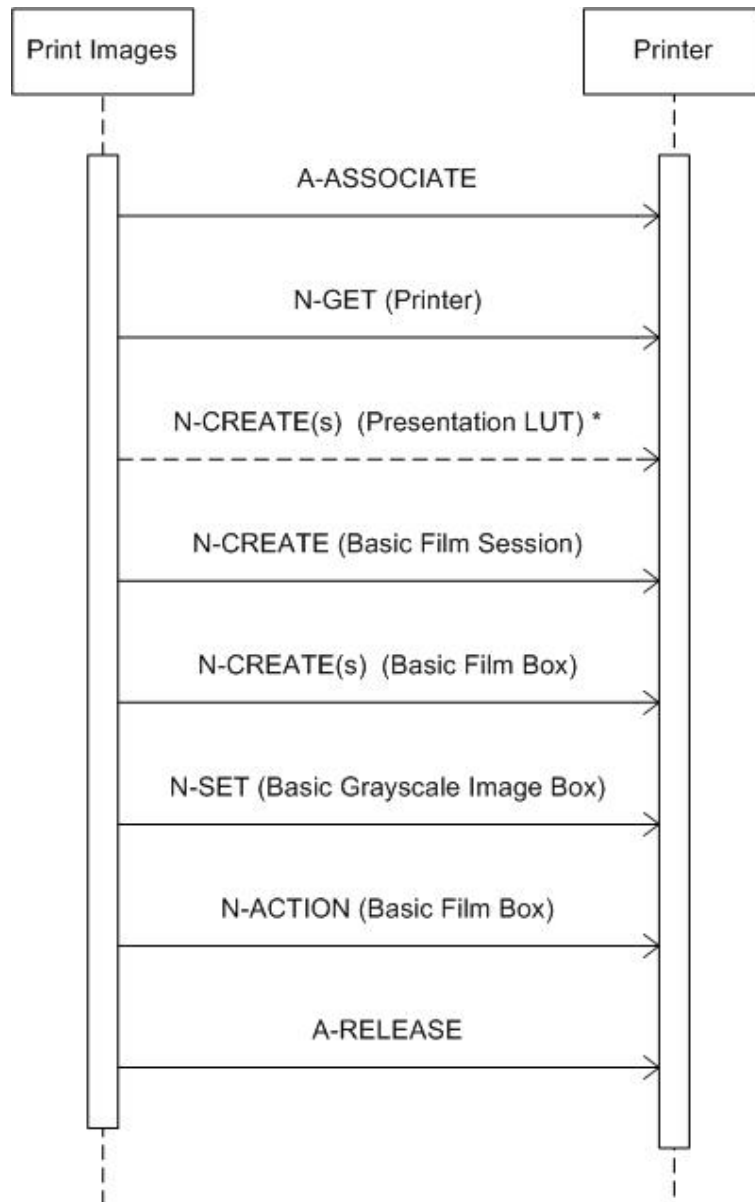

Figure 10: Sequencing of RWA Print Images

- Note that the Presentation LUT SOP class is only supported for Grayscale image printing.

4.2.1.3.5.2. Proposed Presentation Contexts

Each time an association is initiated, the association initiator proposes a number of Presentation Contexts to be used on that association. In this subsection, the Presentation Contexts proposed by the ViewForum AE for Print Images are defined in Table 24.

Table 24: Proposed Presentation Contexts for Print Images

Presentation Context Table					
Abstract Syntax		Transfer Syntax		Role	Extended Negotiation
Name	UID	Name List (note)	UID List		
Basic Grayscale Print Management (Meta)	1.2.840.10008.5.1.1.9	ILE	1.2.840.10008.1.2	SCU	None
		ELE	1.2.840.10008.1.2.1		
		EBE	1.2.840.10008.1.2.2		
Basic Color Print Management (Meta)	1.2.840.10008.5.1.1.14	ILE	1.2.840.10008.1.2	SCU	None
		ELE	1.2.840.10008.1.2.1		
		EBE	1.2.840.10008.1.2.2		
Presentation LUT	1.2.840.10008.5.1.1.23	ILE	1.2.840.10008.1.2	SCU	None
		ELE	1.2.840.10008.1.2.1		
		EBE	1.2.840.10008.1.2.2		

Note: For performance reasons the ELE transfer syntax is preferred.

Used abbreviations are:

ALWAYS	the module or attribute shall always be present with value
ANAP	Attribute Not Always Present
VNAP	Value Not Always Present (attribute sent zero length if no value is present)
EMPTY	Attribute is sent without a value
MAYBE	the module may be present under specified condition
OPTIONAL	the module may be available, depending on source object
AUTO	the attribute value is generated automatically
CONF	the attribute value source is a configurable parameter
IMPL	the attribute value source is a user-implicit configuration setting
SPEC	the attribute value source is a specific DICOM object
USER	the attribute value source is explicit user input

4.2.1.3.5.3. SOP Specific Conformance Printer SOP Class

The Printer process conforms to the Printer Sop Class.

The following DIMSE service element is supported:

N-GET

N-GET DIMSE does not create any Data Set Attributes.

The behavior on successful and unsuccessful transfer is given in the table below.

Table 25: DICOM Command Response Status Handling Behavior for Printer N-GET

Service Status	Further Meaning	Error Code	Behavior
Success	Successful operation	0000	The print job continues.
Warning	(any warning)	xxxx	The print job continues and the warning is logged.
Failure	(any failure)	xxxx	The print job is marked as failed, the reason is logged and reported to the user.

4.2.1.3.5.4. SOP Specific Conformance Basic Film Session SOP Class

The Printer process conforms to the Basic Film Session Sop Class.
The following DIMSE service element is supported:

N-CREATE

The following table lists the supported attributes for the N-CREATE DIMSE.

Table 26: Basic Film Session Presentation Module

Attribute Name	Tag	VR	Value	Presence of Value	Source
Number of Copies	2000,0010	IS	1 to 99	ALWAYS	USER/IMPL
Print Priority	2000,0020	CS	HIGH	ALWAYS	USER/IMPL
Medium Type	2000,0030	CS	BLUE FILM, CLEAR FILM, PAPER	ALWAYS	IMPL
Film Destination	2000,0040	CS	MAGAZINE, PROCESSOR	ALWAYS	IMPL
Film Session Label	2000,0050	LO	Philips Medical Systems	ALWAYS	AUTO

The behavior on successful and unsuccessful transfer is given in the table below.

Table 27: DICOM Command Response Status Handling Behavior for Basic Film Session N-CREATE

Service Status	Further Meaning	Error Code	Behavior
Success	Film Session successfully created	0000	The print job continues.
Warning	Memory Allocation not supported	B600	The print job continues and the warning is logged.

4.2.1.3.5.5. SOP Specific Conformance Basic Film Box SOP Class

The Printer process conforms to the Basic Film Box Sop Class.
The following DIMSE service elements are supported:

**N-CREATE
N-ACTION**

The following table lists the supported attributes for the N-CREATE DIMSE

Table 28: Basic Film Box Presentation Module

Attribute Name	Tag	VR	Value	Presence of Value	Source
Image Display Format	2010,0010	ST	STANDARD\1,1 CUSTOM\1	ALWAYS	CONF
Film Orientation	2010,0040	CS	PORTRAIT; LANDSCAPE	ALWAYS	CONF
Film Size ID	2010,0050	CS	A, A3, A4, 8INX10IN, 8_5INX11IN, 10INX12IN, 10INX14IN, 11INX14IN, 11INX17IN, 14INX14IN, 14INX17IN, 24CMX24CM, 24CMX30CM	ALWAYS	CONF
Max Density	2010,0130	US		VNAP	CONF
Trim	2010,0140	CS	NO, YES	VNAP	CONF
Configuration Information	2010,0150	ST	L=1, L=V	ALWAYS	CONF

Table 29: Basic Film Box Relationship Module

Attribute Name	Tag	VR	Value	Presence of Value	Source
Referenced Film Session Sequence	2010,0500	SQ		ALWAYS	AUTO
>Referenced SOP Class UID	0008,1150	UI	UID of Parent Film Session	ALWAYS	AUTO
>Referenced SOP Instance UID	0008,1155	UI		ALWAYS	AUTO
Referenced Presentation LUT Sequence	2050,0500	SQ		ANAP	AUTO
>Referenced SOP Class UID	0008,1150	UI	UID of Parent LUT Presentation	ALWAYS	AUTO
>Referenced SOP Instance UID	0008,1155	UI		ALWAYS	AUTO

The behavior on successful and unsuccessful transfer is given in the table below.

Table 30: DICOM Command Response Status Handling Behavior for Basic Film Box N-CREATE

Service Status	Further Meaning	Error Code	Behavior
Success	Film Box successfully created	0000	The print job continues.
Warning	Requested Min Density or Max Density outside of Printer's operating Range	B605	The print job continues and the warning is logged.
Failure	There is an existing Film Box that has not been printed	C616	The print job is marked as failed and the reason is logged.

N-ACTION DIMSE does not create any Data Set Attributes.

The behavior on successful and unsuccessful transfer is given in the table below.

Table 31: DICOM Command Response Status Handling Behavior for Basic Film Box N-ACTION

Service Status	Further Meaning	Error Code	Behavior
Success	Film accepted for printing	0000	The print job continues.
Warning	Film Box SOP Instance Hierarchy does not contain Image Box SOP Instances	B603	The print job continues and the warning is logged and reported to the user.
	Image Size is larger than Image Box Size – The Image has been de-magnified	B604	The print job continues and the warning is logged and reported to the user.
	Image Size is larger than Image Box Size – The Image has been cropped to fit	B609	The print job continues and the warning is logged and reported to the user.
	Image Size or combined Print Image Size is larger than Image Box Size – The Image or combined Print Image has been decimated to fit	B60A	The print job continues and the warning is logged and reported to the user.
Failure	Unable to create Print Job SOP Instance – Print Queue is full	C602	The print job is marked as failed and the reason is logged and reported to the user.
	Image Size is larger than Image Box Size	C603	The print job is marked as failed and the reason is logged and reported to the user.
	Combined Print Image Size is larger than Image Box Size	C613	The print job is marked as failed and the reason is logged and reported to the user.

4.2.1.3.5.6. SOP Specific Conformance Basic Grayscale Image Box SOP Class

The Printer process conforms to the Basic Grayscale Image Box Sop Class.
The following DIMSE service element is supported:

N-SET

The following table lists the supported attributes for the N-SET DIMSE

Table 32: Basic Grayscale Image Box SOP Class - N-SET-RQ - Pixel Presentation Module

Attribute Name	Tag	VR	Value	Presence of Value	Source
Image Position	2020,0010	US	1	ALWAYS	AUTO
Polarity	2020,0020	CS	NORMAL	ALWAYS	AUTO
Basic Grayscale Image Sequence	2020,0110	SQ		ALWAYS	AUTO
>Samples per Pixel	0028,0002	US	1	ALWAYS	AUTO
>Photometric Interpretation	0028,0004	CS	MONOCHROME2	ALWAYS	AUTO
>Rows	0028,0010	US		ALWAYS	IMPL
>Columns	0028,0011	US		ALWAYS	IMPL
>Bits Allocated	0028,0100	US	8, 16	ALWAYS	AUTO
>Bits Stored	0028,0101	US	8,12	ALWAYS	IMPL
>High Bit	0028,0102	US	7,11	ALWAYS	AUTO
>Pixel Representation	0028,0103	US	0	ALWAYS	AUTO
>Pixel Data	7FE0,0010	OB/OW		ALWAYS	AUTO

The behavior on successful and unsuccessful transfer is given in the table below.

Table 33: DICOM Command Response Status Handling Behavior for Basic Grayscale Image Box N-SET

Service Status	Further Meaning	Error Code	Behavior
Success	Image successfully stored in Image Box	0000	The print job continues.
Warning	Image Size is larger than Image Box Size – The Image has been de-magnified	B604	The print job continues and the warning is logged and reported to the user.
	Requested Min Density or Max Density outside of Printer's operating Range	B605	The print job continues and the warning is logged and reported to the user.
	Image Size is larger than Image Box Size – The Image has been cropped to fit	B609	The print job continues and the warning is logged and reported to the user.
	Image Size or combined Print Image Size is larger than Image Box Size – The Image or combined Print Image has been decimated to fit	B60A	The print job continues and the warning is logged and reported to the user.
Error	Image Size is larger than Image Box Size	C603	The print job is marked as failed and the reason is logged and reported to the user
	Insufficient Memory in Printer to store the Image	C605	The print job is marked as failed and the reason is logged and reported to the user
	Combined Print Image Size is larger than Image Box Size	C613	The print job is marked as failed and the reason is logged and reported to the user

4.2.1.3.5.7. SOP Specific Conformance Basic Color Image Box SOP Class

The Printer process conforms to the Basic Color Image Box Sop Class.
The following DIMSE service element is supported:

N-SET

The following table lists the supported attributes for the N-SET DIMSE

Table 34: Basic Color Image Box SOP Class - N-SET-RQ - Pixel Presentation Module

Attribute Name	Tag	VR	Value	Presence of Value	Source
Image Position	2020,0010	US	1	ALWAYS	AUTO
Polarity	2020,0020	CS	NORMAL	ALWAYS	AUTO
Basic Color Image Sequence	2020,0111	SQ		ALWAYS	AUTO
>Samples per Pixel	0028,0002	US	3	ALWAYS	AUTO
>Photometric Interpretation	0028,0004	CS	RGB	ALWAYS	AUTO
>Planar Configuration	0028,0006	US	0,1	ALWAYS	IMPL
>Rows	0028,0010	US		ALWAYS	IMPL
>Columns	0028,0011	US		ALWAYS	IMPL
>Bits Allocated	0028,0100	US	8	ALWAYS	AUTO
>Bits Stored	0028,0101	US	8	ALWAYS	IMPL
>High Bit	0028,0102	US	7	ALWAYS	AUTO
>Pixel Representation	0028,0103	US	0	ALWAYS	AUTO
>Pixel Data	7FE0,0010	OW		ALWAYS	AUTO

The behavior on successful and unsuccessful transfer is given in the table below.

Table 35: DICOM Command Response Status Handling Behavior for Basic Color Image Box N-SET

Service Status	Further Meaning	Error Code	Behavior
Success	Image successfully stored in Image Box	0000	The print job continues.
Warning	Image Size is larger than Image Box Size – The Image has been de-magnified	B604	The print job continues and the warning is logged and reported to the user.
	Requested Min Density or Max Density outside of Printer's operating Range	B605	The print job continues and the warning is logged and reported to the user.
	Image Size is larger than Image Box Size – The Image has been cropped to fit	B609	The print job continues and the warning is logged and reported to the user.
	Image Size or combined Print Image Size is larger than Image Box Size – The Image or combined Print Image has been decimated to fit	B60A	The print job continues and the warning is logged and reported to the user.
Error	Image Size is larger than Image Box Size	C603	The print job is marked as failed and the reason is logged and reported to the user.
	Insufficient Memory in Printer to store the Image	C605	The print job is marked as failed and the reason is logged and reported to the user.
	Combined Print Image Size is larger than Image Box Size	C613	The print job is marked as failed and the reason is logged and reported to the user.

4.2.1.3.5.8. SOP Specific Conformance Presentation LUT SOP Class

The Printer process conforms to the Presentation LUT Sop Class.

The following DIMSE service element is supported:

N-CREATE

The following table lists the supported attributes for the N-CREATE DIMSE

Table 36: Presentation LUT Module

Attribute Name	Tag	VR	Value	Presence of Value	Source
Presentation LUT Shape	2050,0020	CS	IDENTITY	ALWAYS	AUTO

The behavior on successful and unsuccessful transfer is given in the table below.

Table 37: DICOM Command Response Status Handling Behavior for Presentation LUT N-CREATE

Service Status	Further Meaning	Error Code	Behavior
Success	Presentation LUT successfully created	0000	The print job continues.
Warning	Requested Min Density or Max Density outside of printer's operating range. The printer will use its respective minimum or maximum density value instead.	B605	The print job continues and the warning is logged.

Table 38: DICOM Command Response Status Handling Behavior for Printer N-EVENT-REPORT

Service Status	Further Meaning	Error Code	Behavior
Normal	Successful operation	0000	The print job is marked as completed.
Warning	(any warning)	xxxx	The print job is marked as completed and the warning is logged and reported to the user.
Failure	(any failure)	xxxx	The print job is marked as failed and the reason is logged and reported to the user

The behavior of the AE during communication failure is summarized in Table 39.

Table 39: DICOM Command Communication Failure Behavior

Exception	Behavior
ARTIM Time-out	Print job fails.
Reply Time-out	The association is released.
Association Time-out SCU	The association is released.
Association aborted	The Print job is marked as failed. The reason is logged and reported to the user.

4.2.1.3.6. Request Printer Status

4.2.1.3.6.1. Description and Sequencing of Activities

The RWA Request Printer Status involves the request for the printer status of the configured Print Management SCP's (i.e. printers).

The ViewForum AE will periodically request the printer status. If an association already exists for a print job (RWA Print Images) then the ViewForum AE shall use this association, otherwise a new association shall be initiated.

The status codes as returned by the printer shall be logged for service purposes and shall not be shown on the GUI.

The Printer Status Tool may be used to reveal the received printer status.

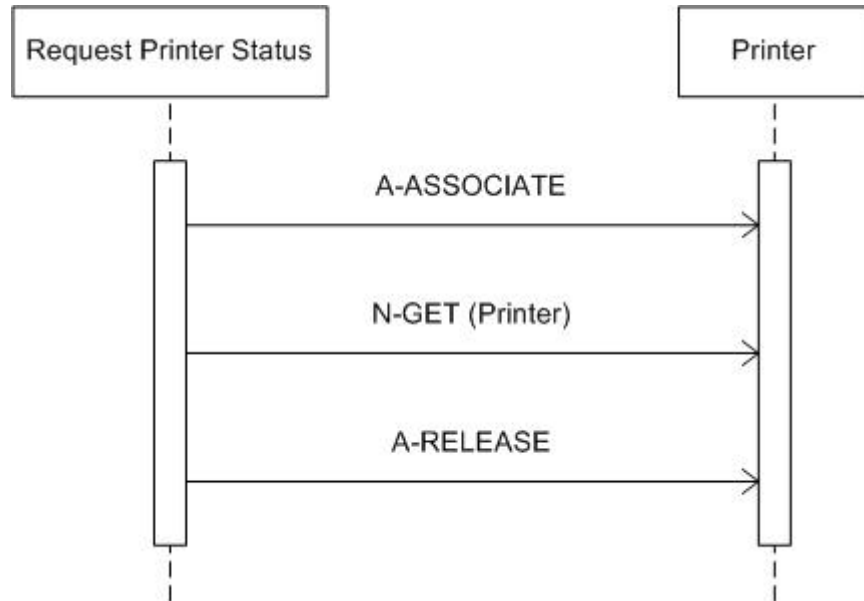

Figure 11: Sequencing of RWA Request Printer Status

4.2.1.3.6.2. Proposed Presentation Contexts

Each time an association is initiated, the association initiator proposes a number of Presentation Contexts to be used on that association. In this subsection, the Presentation Contexts proposed by the ViewForum AE for Request Printer Status are defined in Table 40

Table 40: Proposed Presentation Contexts for Request Printer Status

Presentation Context Table					
Abstract Syntax		Transfer Syntax		Role	Extended Negotiation
Name	UID	Name List (note)	UID List		
Printer	1.2.840.10008.5.1.1.16	ILE ELE EBE	1.2.840.10008.1.2 1.2.840.10008.1.2.1 1.2.840.10008.1.2.2	SCU	None

Note: For performance reasons the ELE transfer syntax is preferred and shall be chosen in case multiple Transfer Syntaxes are accepted in the Association Acceptance

4.2.1.3.6.3. SOP Specific Conformance for SOP Class

The ViewForum AE provides standard conformance to the Printer SOP class.

All details regarding the specific conformance, including response behavior to all status codes, both from an application level and communication errors are provided in Table 41.

Table 41: DICOM Command Response Status Handling Behavior

Service Status	Further Meaning	Error Code	Behavior
Success	Matching is complete	0000	The print job continues.
Warning	(any warning)	xxxx	The print job continues and the warning is logged and reported to the user.
Error	(any failure)	xxxx	The print job is marked as failed. The reason is logged and reported to the user.

The behavior of the AE during communication failure is summarized in Table 42.

Table 42: DICOM Command Communication Failure Behavior

Exception	Behavior
ARTIM Timeout	Print job fails.
Reply Time-out	The association is released.
Association Time-out SCU	The association is released.
Association aborted	The print job is marked as failed. The reason is logged and reported to the user.

4.2.1.4. Association Acceptance Policy

ViewForum R5.1 shall accept Associations for the following purposes:

- To allow remote applications to verify application level communication with ViewForum R5.1; ref. section 4.2.1.4.1 Request Verification.
- To allow remote applications to store images in the ViewForum R5.1 database (i.e. image import); ref. section 4.2.1.4.2 Import Images.
- To allow remote applications to query the ViewForum R5.1 database; ref. section 4.2.1.4.3 Query Local Images.
- To allow remote applications to retrieve images from the ViewForum R5.1 database; ref. section 4.2.1.4.4 Retrieve Local Images.

The ViewForum AE shall reject association requests from unknown applications, i.e. applications that offer an unknown "calling AE title". An application is known if – and only if – it is defined during configuration of the ViewForum system.

The ViewForum AE shall reject association requests from applications that do not address the ViewForum AE, i.e. applications that offer a wrong "called AE title".

The ViewForum AE title is defined during configuration of the ViewForum system.

4.2.1.4.1. Request Verification

4.2.1.4.1.1. Description and Sequencing of Activities

The ViewForum AE shall accept associations from systems that wish to verify application level communication using the C-ECHO command.

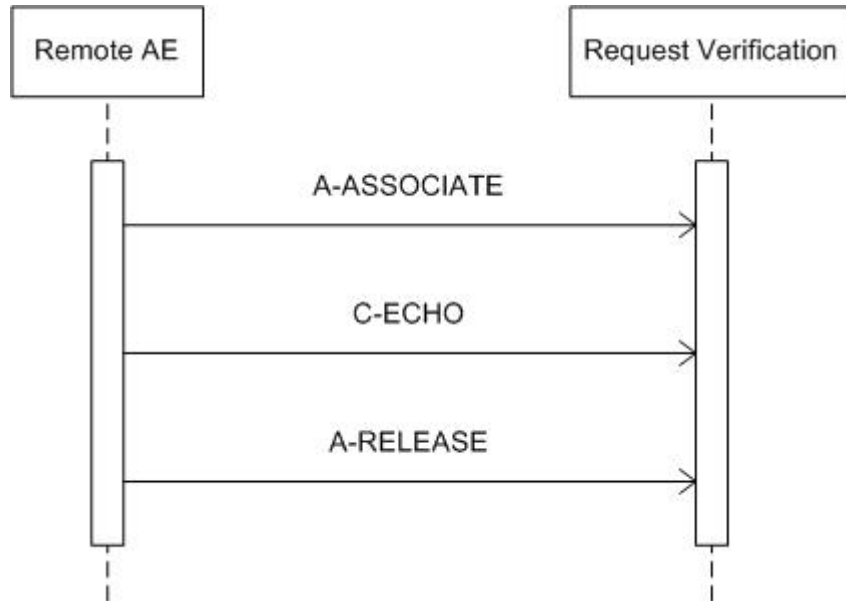

Figure 12: Sequencing of RWA Request Verification

4.2.1.4.1.2. Accepted Presentation Contexts

The ViewForum AE shall be able to accept the presentation contexts as specified in the next table.

Table 43: Acceptable Presentation Contexts for Request Verification

Presentation Context Table					
Abstract Syntax		Transfer Syntax		Role	Extended Negotiation
Name	UID	Name List	UID List		
Verification	1.2.840.10008.1.1	ILE ELE EBE	1.2.840.10008.1.2 1.2.840.10008.1.2.1 1.2.840.10008.1.2.2	SCP	None

For performance reasons the ELE transfer syntax is preferred and shall be chosen in case multiple Transfer Syntaxes are proposed in the Association Negotiation.

The ViewForum AE shall accept all contexts in the intersection of the proposed and acceptable Presentation Contexts. This means that the ViewForum AE accepts multiple proposed Presentation Contexts with the same SOP class but different Transfer Syntaxes.

There is no check for duplicate contexts, and these will therefore be accepted.

4.2.1.4.1.3. SOP Specific Conformance for SOP Class

The ViewForum AE provides standard conformance to the Verification service class.

The behavior of an Application Entity shall be summarized as shown in Table 44. The standard as well as the manufacturer specific status codes and their corresponding behavior shall be specified.

Table 44: Verification C-ECHO Response Status Handling Behavior

Service Status	Further Meaning	Error Code	Behavior
N/A			

4.2.1.4.2. Import Images

The ViewForum is able to read from any location known to the Operating System of the Workspot where it is installed and is aware of a number of locations where data can be read from e.g. local hard disk, network drives, CD drives. All of these should be accessible from reading.

4.2.1.4.2.1. Description and Sequencing of Activities

The ViewForum AE shall accept associations from systems that wish to store images in the ViewForum R5.1 database using the C-STORE command.

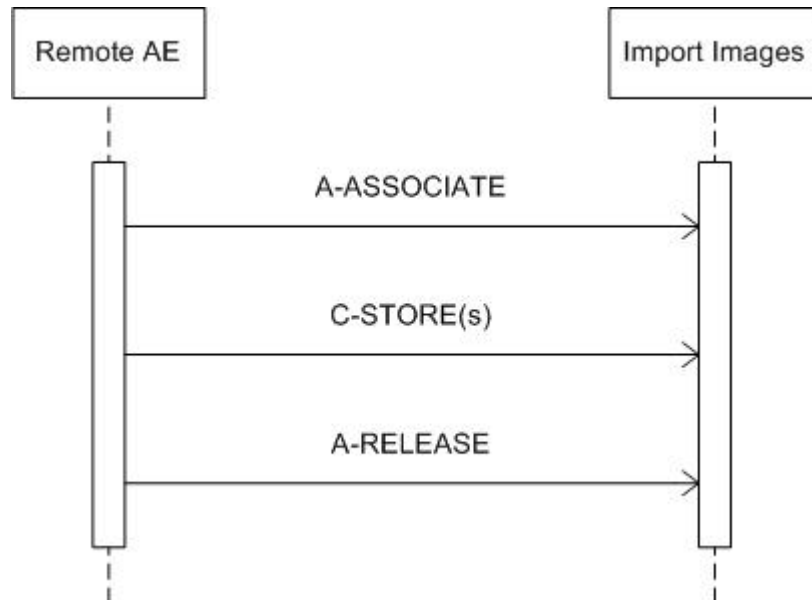

Figure 13: Sequencing of RWA Import Images

4.2.1.4.2.2. Accepted Presentation Contexts

The ViewForum AE shall be able to accept the presentation contexts as specified in the next table.

Table 45: Acceptable Presentation Contexts for Import Images

Presentation Context Table					
Abstract Syntax		Transfer Syntax		Role	Extended Negotiation
Name	UID	Name List (note)	UID List		
Computed Radiography Image Storage	1.2.840.10008.5.1.4.1.1.1	ILE ELE EBE	1.2.840.10008.1.2 1.2.840.10008.1.2.1 1.2.840.10008.1.2.2	SCP	None
Digital X-Ray Image Storage – for Presentation	1.2.840.10008.5.1.4.1.1.1.1	ILE ELE EBE	1.2.840.10008.1.2 1.2.840.10008.1.2.1 1.2.840.10008.1.2.2	SCP	None
CT Image Storage	1.2.840.10008.5.1.4.1.1.2	ILE ELE EBE	1.2.840.10008.1.2 1.2.840.10008.1.2.1 1.2.840.10008.1.2.2	SCP	None
MR Image Storage	1.2.840.10008.5.1.4.1.1.4	ILE ELE EBE	1.2.840.10008.1.2 1.2.840.10008.1.2.1 1.2.840.10008.1.2.2	SCP	None
Secondary Capture Image Storage	1.2.840.10008.5.1.4.1.1.7	ILE ELE EBE	1.2.840.10008.1.2 1.2.840.10008.1.2.1 1.2.840.10008.1.2.2	SCP	None
Grayscale Softcopy Presentation State Storage	1.2.840.10008.5.1.4.1.1.11.1	ILE ELE EBE	1.2.840.10008.1.2 1.2.840.10008.1.2.1 1.2.840.10008.1.2.2	SCP	None
X-Ray Angiographic Image Storage	1.2.840.10008.5.1.4.1.1.12.1	ILE ELE EBE	1.2.840.10008.1.2 1.2.840.10008.1.2.1 1.2.840.10008.1.2.2	SCP	None
X-Ray Radiofluoroscopic Image Storage	1.2.840.10008.5.1.4.1.1.12.2	ILE ELE EBE	1.2.840.10008.1.2 1.2.840.10008.1.2.1 1.2.840.10008.1.2.2	SCP	None
Specialized X-Ray	1.3.46.670589.2.3.1.1	ILE ELE EBE	1.2.840.10008.1.2 1.2.840.10008.1.2.1 1.2.840.10008.1.2.2	SCP	None
CX Image	1.3.46.670589.2.4.1.1	ILE ELE EBE	1.2.840.10008.1.2 1.2.840.10008.1.2.1 1.2.840.10008.1.2.2	SCP	None
3D Volume Storage	1.3.46.670589.5.0.1.1	ILE ELE EBE	1.2.840.10008.1.2 1.2.840.10008.1.2.1 1.2.840.10008.1.2.2	SCP	None
3D Volume Object Storage	1.3.46.670589.5.0.2.1	ILE ELE EBE	1.2.840.10008.1.2 1.2.840.10008.1.2.1 1.2.840.10008.1.2.2	SCP	None
Surface Storage	1.3.46.670589.5.0.3.1	ILE ELE EBE	1.2.840.10008.1.2 1.2.840.10008.1.2.1 1.2.840.10008.1.2.2	SCP	None
MR cardio Storage	1.3.46.670589.5.0.8.1	ILE ELE EBE	1.2.840.10008.1.2 1.2.840.10008.1.2.1 1.2.840.10008.1.2.2	SCP	None
CT Synthetic Image	1.3.46.670589.5.0.9	ILE ELE EBE	1.2.840.10008.1.2 1.2.840.10008.1.2.1 1.2.840.10008.1.2.2	SCP	None
MR Synthetic Image	1.3.46.670589.5.0.10	ILE ELE EBE	1.2.840.10008.1.2 1.2.840.10008.1.2.1 1.2.840.10008.1.2.2	SCP	None

Presentation Context Table					
Abstract Syntax		Transfer Syntax		Role	Extended Negotiation
Name	UID	Name List (note)	UID List		
MR Cardio Analysis Storage	1.3.46.670589.5.0.11.1	ILE ELE EBE	1.2.840.10008.1.2 1.2.840.10008.1.2.1 1.2.840.10008.1.2.2	SCP	None
CX Synthetic Image	1.3.46.670589.5.0.12	ILE ELE EBE	1.2.840.10008.1.2 1.2.840.10008.1.2.1 1.2.840.10008.1.2.2	SCP	None
Perfusion	1.3.46.670589.5.0.13	ILE ELE EBE	1.2.840.10008.1.2 1.2.840.10008.1.2.1 1.2.840.10008.1.2.2	SCP	None
Perfusion Analysis	1.3.46.670589.5.0.14	ILE ELE EBE	1.2.840.10008.1.2 1.2.840.10008.1.2.1 1.2.840.10008.1.2.2	SCP	None
Ultra sound Multi-frame Image Storage	1.2.840.10008.5.1.4.1.1.3.1	ILE ELE EBE JPEG Baseline (Note 1)	1.2.840.10008.1.2 1.2.840.10008.1.2.1 1.2.840.10008.1.2.2 1.2.840.10008.1.2.4 .50	SCP	None
Ultra sound Image Storage	1.2.840.10008.5.1.4.1.1.6.1	ILE ELE EBE JPEG Baseline (Note 1)	1.2.840.10008.1.2 1.2.840.10008.1.2.1 1.2.840.10008.1.2.2 1.2.840.10008.1.2.4 .50	SCP	None

Note : For performance reasons the ELE transfer syntax is preferred and shall be chosen in case multiple Transfer Syntaxes are proposed in the Association Negotiation

Note 1 : Only for Photometric Interpretation of RGB and YBR_FULL_422. Therefore JPEG Baseline transfer syntax may NOT be configured for SCU systems that are capable of handling storage of monochrome images too.

The ViewForum AE shall accept all contexts in the intersection of the proposed and acceptable Presentation Contexts. This means that the ViewForum AE accepts multiple proposed Presentation Contexts with the same SOP class but different Transfer Syntaxes.

There is no check for duplicate contexts, and these will therefore be accepted.

4.2.1.4.2.3. SOP Specific Conformance for SOP Classes

The ViewForum AE provides standard level 1 (Base) conformance to the Storage service class.

If the ViewForum AE imports an image and during the association negotiation the Presentation State SOP class was not negotiated, then the ViewForum AE creates a Presentation State instance for the imported image.

The following table gives an overview of the image formats that can be viewed or stored.

Table 46: Support for Photometric Interpretation

Photometric Interpretation	Storage	Viewing
MONOCHROME1	✓	✓
MONOCHROME2	✓	✓
RGB	✓	✓
YBR_FULL	✓	-
YBR_FULL_422	✓ *	✓ *
YBR_PARTIAL_422	✓	-
PALETTE COLOR	✓	-
Other	✓	-

- *Compressed YBR_FULL_422 images received per JPEG Baseline transfer shall be stored (and consequently viewed) as RGB images.*

If the ViewForum AE receives improper DICOM, ViewForum R5.1 tries as much as possible to make it proper DICOM (if configured to do so). But ViewForum R5.1 also tries to remain as transparent as possible on images; on export the images must be changed only to such extent as really necessary. Therefore it is not guaranteed that all DICOM violations of incoming images are repaired (e.g. enumerated values are not changed).

Thus improper DICOM import may result in improper DICOM export from the ViewForum AE (no checks are available for incorrect UIDs, Date/Time formats, etc.).

ViewForum R5.1 stores all additional standard, private and retired attributes in received images. Retrieval of these attributes VR's is only possible (by means of a C-STORE) if the following conditions are satisfied:

- The image was encoded (when ViewForum R5.1 was C-STORE SCP) using one of the explicit value representations; or
- The image was encoded (when ViewForum R5.1 was C-STORE SCP) using implicit value representation and the destination (i.e. a remote C-STORE SCP) has accepted implicit value representation as the only transfer syntax applicable to the storage SOP class of the image (with ViewForum R5.1 as C-STORE SCU).

Otherwise the VR shall be set to unknown (UN).

Important implementation remarks and restrictions:

- The DICOM standard does not guarantee that the advanced ViewForum R5.1 applications can process the received images. This depends on the presence and consistency of a set of attributes in these images. The conditions for running the ViewForum R5.1 applications shall be specified in separate Annexes.
- See section 8.1.3, Coerced/Modified fields, for details on coerced and modified attributes.
- When the location of a graphic or text annotation is specified relatively with regards to the displayed area. (i.e. DICOM attribute: Bounding Box Annotation Units, Ancjor Point Annotation Units or Graphic Annotation Units equals "DISPLAY"), the annotation is not displayed.
- Areas occluded by shutter are always black in ViewForum R5.1, whereas it is possible to want it to be white in DICOM.

The response status behavior of the ViewForum AE is as described in Table 47. The standard as well as the manufacturer specific status codes and their corresponding behavior shall be specified.

Table 47: Storage C-STORE Response Status Handling Behavior

Service Status	Further Meaning	Error Code	Behavior
Success	Storage is complete	0000	The image(s) shall be stored in the ViewForum R5.1 database.
Refused	Out of Resources	A700	The ViewForum R5.1 database is full – recovery from this condition is left to the SCU. ViewForum R5.1 shall send a notification, log the condition, and abort the association.
Error	Data set does not match SOP class	A900	The SOP class of the image(s) does not match the negotiated abstract syntax. ViewForum R5.1 shall send a notification, log the condition, and abort the association.
	Cannot understand	C000	The image(s) cannot be parsed. ViewForum R5.1 shall send a notification, log the condition, and abort the association.
Warning	Coercion of Data Elements	B000	N/A
	Elements discarded	B006	N/A
	Data set does not match SOP class	B007	N/A

4.2.1.4.3. Query Local Images

4.2.1.4.3.1. Description and Sequencing of Activities

The ViewForum AE shall accept associations from systems that wish to query the ViewForum R5.1 database using the C-FIND command.

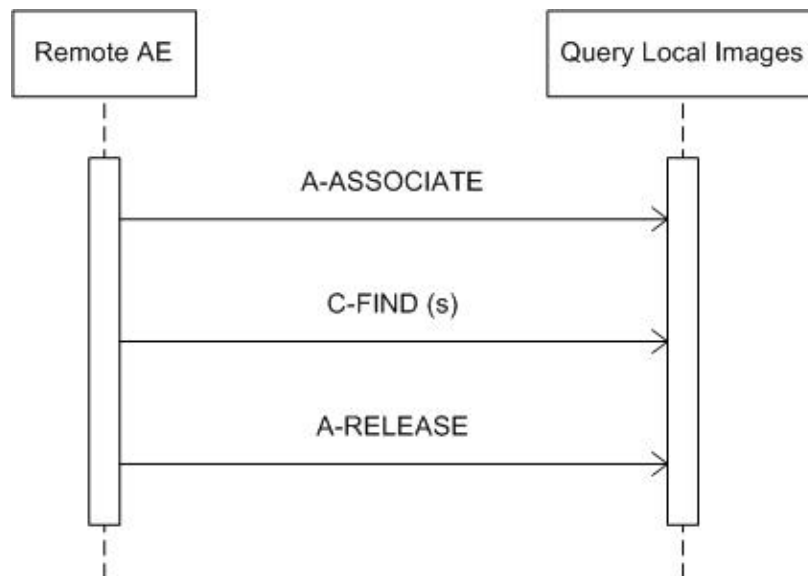

Figure 14: Sequencing of RWA Query Local Images

4.2.1.4.3.2. Accepted Presentation Contexts

The ViewForum AE shall be able to accept the presentation contexts as specified in the next table.

Table 48: Acceptable Presentation Contexts for Query Local Images

Presentation Context Table					
Abstract Syntax		Transfer Syntax		Role	Extended Negotiation
Name	UID	Name List (note)	UID List		
Patient Root Query /Retrieve Information Model - FIND	1.2.840.10008.5.1.4.1.2.1.1	ILE ELE EBE	1.2.840.10008.1.2 1.2.840.10008.1.2.1 1.2.840.10008.1.2.2	SCP	None
Study Root Query /Retrieve Information Model - FIND	1.2.840.10008.5.1.4.1.2.2.1	ILE ELE EBE	1.2.840.10008.1.2 1.2.840.10008.1.2.1 1.2.840.10008.1.2.2	SCP	None
Patient/Study Only Query/Retrieve Information Model - FIND	1.2.840.10008.5.1.4.1.2.3.1	ILE ELE EBE	1.2.840.10008.1.2 1.2.840.10008.1.2.1 1.2.840.10008.1.2.2	SCP	None

Note : For performance reasons the ELE transfer syntax is preferred and shall be chosen in case multiple Transfer Syntaxes are proposed in the Association Negotiation

The ViewForum AE shall accept all contexts in the intersection of the proposed and acceptable Presentation Contexts. This means that the ViewForum AE accepts multiple proposed Presentation Contexts with the same SOP class but different Transfer Syntaxes.

There is no check for duplicate contexts, and these will therefore be accepted.

4.2.1.4.3.3. SOP Specific Conformance for SOP Classes

The ViewForum AE provides standard conformance to the Query/Retrieve service class. Relational queries are not supported. The ViewForum AE shall handle simultaneous C-FIND requests simultaneously.

The ViewForum R5.1 database distinguishes two patients with the same Patient ID but different Patient's Name or Patient's Birth Date. However, the DICOM Query/Retrieve service class has Patient ID as a unique key at Patient level, and thus two patients with the same Patient ID cannot be distinguished via a standard DICOM Query.

The following query keys shall be supported.

Table 49: Supported Query Keys

Query Level	Query Key		Standard Matching
	Name	Tag	
Patient	Patient's Name	(0010,0010)	✓
	Patient ID	(0010,0020)	✓
Study	Study Date	(0008,0020)	✓
	Study Time	(0008,0030)	✓
	Accession Number	(0008,0050)	✓
	Study Instance UID	(0020,000D)	✓
	Study ID	(0020,0010)	✓
Series	Modality	(0008,0060)	✓
	Series Instance UID	(0020,000E)	✓
	Series Number	(0020,0011)	✓
Image	SOP Instance UID	(0008,0018)	✓
	Instance Number	(0020,0013)	✓

When querying optional keys the ViewForum R5.1 will respond successfully for available keys if queried per **universal matching**; otherwise it will respond with warning.

Note that when querying optional keys with **non-universal matching** the ViewForum R5.1 will return information using universal matching for those keys.

Note that when a query is performed per Patient/Study Only Query/Retrieve Information Model SOP class on Patient Level, the ViewForum R5.1 always sends back the attribute "Patient's Name" (0010,0010), also when it was not requested.

The response status behavior of the ViewForum AE is as described in Table 50. The standard as well as the manufacturer specific status codes and their corresponding behavior shall be specified.

Table 50: Query/Retrieve C-FIND Response Status Handling Behavior

Service Status	Further Meaning	Error Code	Behavior
Success	Matching is complete	0000	The C-FIND request handling is completed, no more C-FIND responses are sent.
Refused	Out of Resources	A700	N/A
Failed	Identifier does not match SOP class	A900	N/A
	Unable to process	C000	The C-FIND request cannot be parsed. ViewForum R5.1 logs the reason.
Cancel	Matching terminated due to Cancel Request	FE00	The C-FIND request is canceled, no more C-FIND responses are sent.

Service Status	Further Meaning	Error Code	Behavior
Pending	Matches are continuing – Current match is supplied and any optional keys were supported in the same manner as required keys	FF00	The C-FIND responses are continuing.
	Matches are continuing – Warning that one or more optional keys were not supported for existence and/or matching for this identifier	FF01	The C-FIND responses are continuing.

4.2.1.4.4. Retrieve Local Images

4.2.1.4.4.1. Description and Sequencing of Activities

The ViewForum AE shall accept associations from systems that wish to retrieve images from the ViewForum R5.1 database using the C-MOVE command.

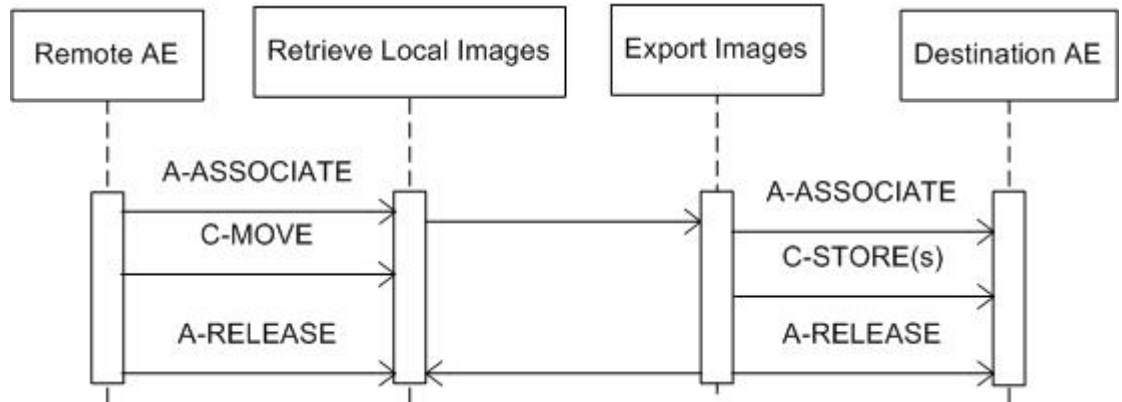

Figure 15: Sequencing of RWA Retrieve Local Images

After RWA Retrieve Local Images the RWA Export Images is started; the RWA Export Images is described in section 4.2.1.3.1.

4.2.1.4.4.2. Accepted Presentation Contexts

The ViewForum AE shall be able to accept the presentation contexts as specified in the next table.

Table 51: Acceptable Presentation Contexts for Retrieve Local Images

Presentation Context Table					
Abstract Syntax		Transfer Syntax		Role	Extended Negotiation
Name	UID	Name List (note)	UID List		
Patient Root Query /Retrieve Information Model - MOVE	1.2.840.10008.5.1.4.1.2.1.2	ILE ELE EBE	1.2.840.10008.1.2 1.2.840.10008.1.2.1 1.2.840.10008.1.2.2	SCU	None
Study Root Query /Retrieve Information Model - MOVE	1.2.840.10008.5.1.4.1.2.2.2	ILE ELE EBE	1.2.840.10008.1.2 1.2.840.10008.1.2.1 1.2.840.10008.1.2.2	SCU	None
Patient/Study Only Query/Retrieve Information Model - MOVE	1.2.840.10008.5.1.4.1.2.3.2	ILE ELE EBE	1.2.840.10008.1.2 1.2.840.10008.1.2.1 1.2.840.10008.1.2.2	SCU	None

Note : For performance reasons the ELE transfer syntax is preferred and shall be chosen in case multiple Transfer Syntaxes are proposed in the Association Negotiation

The ViewForum AE shall accept all contexts in the intersection of the proposed and acceptable Presentation Contexts. This means that the ViewForum AE accepts multiple proposed Presentation Contexts with the same SOP class but different Transfer Syntaxes.

There is no check for duplicate contexts, and these will therefore be accepted.

4.2.1.4.4.3. SOP Specific Conformance for SOP Classes

The response status behavior of the ViewForum AE is as described in Table 52. The standard as well as the manufacturer specific status codes and their corresponding behavior shall be specified.

Table 52: Query/Retrieve C-MOVE Response Status Handling Behavior

Service Status	Further Meaning	Error Code	Behavior
Success	Sub-operations complete – No Failures	0000	The C-MOVE command has been completed.
Refused	Out of Resources – Unable to calculate number of matches	A701	N/A
	Out of Resources – Unable to perform Sub-operations	A702	N/A
	Move Destination unknown	A801	No C-STORE command will be sent. ViewForum R5.1 logs the reason.
Failed	Identifier does not match SOP class	A900	N/A
	Unable to process	C000	The C-MOVE request cannot be parsed. No Store Command will be sent. ViewForum R5.1 logs the reason.
Cancel	Sub-operations terminated due to Cancel Indication	FE00	The C-MOVE request is canceled, no more C-MOVE responses are sent.
Warning	Sub-operations complete – One or more Failures	B000	N/A
Pending	Sub-operations are continuing	FF00	Approximately every 30 seconds to indicate progress.

4.3. Network Interfaces

4.3.1. Physical Network Interface

The ViewForum R5.1 application provides DICOM V3.0 TCP/IP Network Communication Support as defined in Part 8 of [DICOM].

ViewForum R5.1 inherits its TCP/IP stack from Windows XP (i.e. the operating system platform).

ViewForum R5.1 supports a single network interface: Ethernet ISO.8802-3. With standard supported physical medium include:

- IEEE 802.3 10BASE-TX
- IEEE 802.3 100BASE-TX (Fast Ethernet)
- IEEE 802.3 1000BASE-X (Fiber Optic Gigabit Ethernet).

4.4. Configuration

The ViewForum R5.1 system is configured by means of a configuration program. This program is accessible at start-up of the ViewForum R5.1 system. It is password protected and intended to be used by Philips Customer Support Engineers only.

The configuration program shall prompt the Customer Support Engineer to enter configuration information as required by the ViewForum R5.1 application.

4.4.1. AE Title/Presentation Address Mapping

An important installation issue is the translation from AE title to Presentation Address. How this is to be performed shall be described in this section.

4.4.1.1. Local AE Titles

Per default the ViewForum AE title is equal to the IP host name. At installation the Customer Support Engineer can change this host name. The ViewForum AE can be changed independently.

ViewForum R5.1 listens on **port 3010**. This port number is not configurable.

Table 53: AE Title Configuration Table

Application Entity	Default AE Title	Default TCP/IP Port
ViewForum AE	<IP host name>	3010 *

Note: * Not configurable.

4.4.1.2. Remote AE Title/Presentation Address Mapping

4.4.1.2.1. Remote Association Initiators

All relevant remote applications able to setup a DICOM association towards ViewForum R5.1 must be configured at ViewForum R5.1 configuration time. The Customer Support Engineer must provide the following information for each remote application:

- The Application Entity Title.
- The SOP classes and transfer syntaxes for which ViewForum R5.1 accepts associations.

4.4.1.2.2. Remote Association Acceptors

The following information must be provided for all relevant remote applications that are able to accept DICOM associations from ViewForum R5.1:

- The Application Entity Title.
- The host name/IP address on which the remote application resides.
- The port number at which the remote application accepts association requests.

4.4.2. Parameters

The specification of important operational parameters, and if configurable, their default value and range, shall be specified here.

The configuration parameters are given in Table 54, categorized in the following sections:

- General Parameters of ViewForum R5.1.
- Local Configurable Parameters of the ViewForum AE.
- Remote Configurable Parameters of the ViewForum AE.
- General Print Parameters.
- Printer Specific Print Parameters.

Table 54: Configuration Parameters table

Parameter	Configurable	Default Value
General Parameters of ViewForum R5.1		
Time-out waiting for acceptance or rejection Response to an Association Open Request. (Application Level timeout)	No	-
General DIMSE level time-out values	No	-
Time-out waiting for response to TCP/IP connect request. (Low-level timeout)	No	-
Time-out waiting for acceptance of a TCP/IP message over the network. (Low-level timeout)	No	-
Time-out for waiting for data between TCP/IP packets. (Low-level timeout)	No	-
Any changes to default TCP/IP settings, such as configurable stack parameters.	No	-

Parameter	Configurable	Default Value
Local Configurable Parameters of the ViewForum AE		
Size constraint in maximum object size (see note)	No	-
Maximum PDU size the AE can receive	Yes	0 (unlimited)
Maximum PDU size the AE can send	No	-
AE specific DIMSE level time-out values	No	-
Number of simultaneous associations by Service and/or SOP class	No	-
SOP class support	Yes	none
Transfer Syntax support ¹	Yes	ELE
Remote Configurable Parameters of the ViewForum AE		
Size constraint in maximum object size (see note)	No	-
Maximum PDU size the AE can receive	Yes	0 (unlimited)
Maximum PDU size the AE can send	No	-
AE specific DIMSE level time-out values	No	-
Number of simultaneous associations by Service and/or SOP class	No	-
SOP class support	Yes	none
Transfer Syntax support	Yes	ELE
Storage Commitment request must be sent after Storage request	Yes	not
Storage Commitment time-out (synchronous to asynchronous)	Yes	none
Automatic conversion of images of SOP classes not supported by remote systems into Secondary Capture Image Storage SOP instances	Yes	convert to SC
Export of pure DICOM images (i.e. only the standard DICOM attributes as defined in the related IOD) or extended DICOM images (with additional Standard DICOM, Private and Retired attributes)	Yes	allow all attributes
Support of overlays for DICOM node not supporting Presentation State objects ²	Yes	enabled
Support of overlays for DICOM node supporting Presentation State objects ²	Yes	disabled
Support of overlays for CD ²	Yes	disabled
General Print Parameters		
The DICOM printers that may be selected by the operator	Yes	none
Printer Specific Print Parameters ³		
Medium type	Yes	all available
Film size ID (i.e. Media size)	Yes	all available
Resolution (300 / 600 dpi)	Yes	300
Color model (8 / 16 bits color)	Yes	8
Min Density	Yes	0
Max Density	Yes	0

Note 1: The JPEG Baseline transfer syntax is only supported for RGB and YBR_FULL_422 images; therefore JPEG Baseline may NOT be configured for systems that are capable of handling storage of monochrome images too.

Note 2: The ViewForum R5.1 Copy-tool can override the configured setting of overlay support.

Note 3: These print parameters can be selected from choice lists. These choice lists are defined via so-called prototypes for each type of printer and print medium. These prototypes are also configurable.

5. MEDIA INTERCHANGE

5.1. Implementation Model

The Implementation Model identifies the DICOM Application Entities in a specific implementation, and relates the Application Entities to Real-World Activities.

5.1.1. Application Data Flow

The ViewForum R5.1 system consists of one single application entity only: the ViewForum R5.1 Application Entity (ViewForum AE).

Figure 16 shows the Media Interchange Application Data Flow as a functional overview of the ViewForum AE for CD-R and DVD.

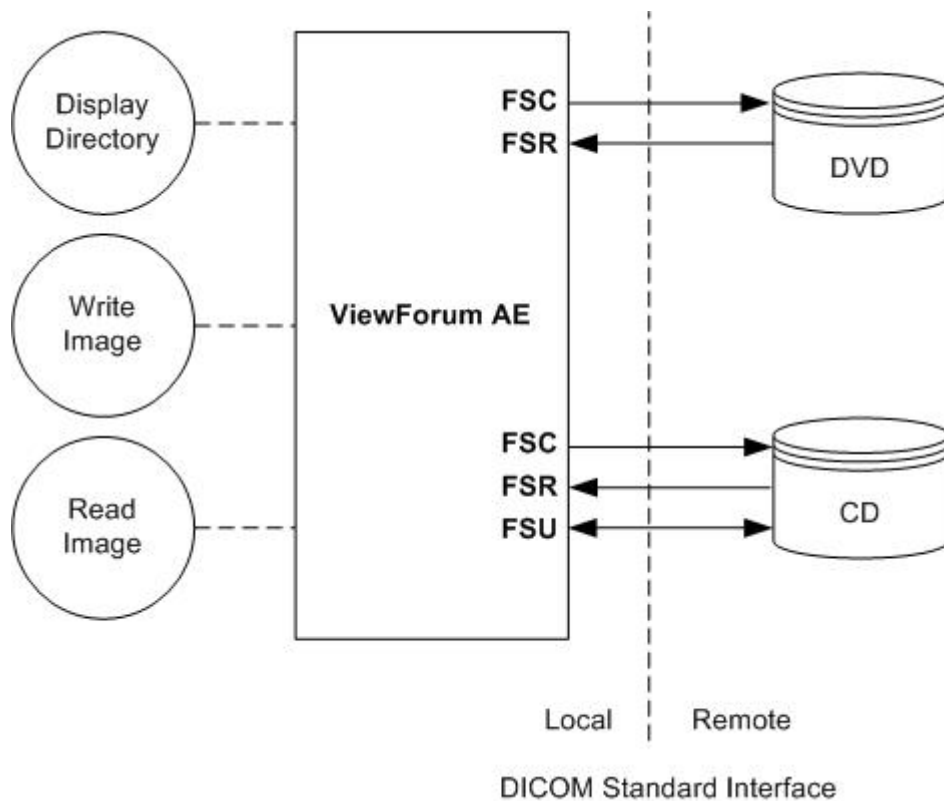

Figure 16: Media Interchange Application Data Flow Diagram

Table 61 shows the Media Interchange overview of the ViewForum AE and the supporting roles for CD-R and DVD.

Table 55: Media Services table

Media Storage Application	Write Files (FSC / FSU)	Read Files (FSR)
General Purpose CD-R	YES / YES	YES
General Purpose DVD-JPEG	YES / NO	YES

The ViewForum AE will act as a FSR, for CD-R and DVD, when reading the directory of the medium. The ViewForum AE will act as a FSC / FSU for a CD-R and as FSC for DVD, when writing the selected images in a patient folder onto the medium. ViewForum supports the media profiles as shows in the Table below:

Table 56: Media Profiles supported by ViewForum

Application Profile	CD	DVD+RW / DVD+R
General Purpose	STD-GEN-CD	STD-GEN-DVD

Note; DVD-R and DVD-RW can be read but are not supported for writing.

Supported Photometric Interpretations

The ViewForum system supports images with the following DICOM Photometric Interpretations as shows in the Table below:

Table 57: Photometric interpretations supported by ViewForum

Photometric Interpretation	Import	Export	Viewing
MONOCHROME1	YES	YES	YES
MONOCHROME2	YES	YES	YES
PALETTE COLOR	YES	YES	NO
RGB	YES	YES	YES
YBR_FULL	YES	YES	NO
YBR_FULL_422 (see note)	YES	YES	NO
YBR_PARTIAL_422	YES	YES	NO
YBR_RCT	YES	YES	NO
YBR_ICT	YES	YES	NO

Note: if the photometric interpretation YBR_FULL_422 is used in combination with transfer syntax JPEG-lossy then the pixel data is converted to RGB on import.

The system proposes the transfer syntaxes mentioned in Table below.

Table 58: Transfer Syntaxes of DVD / CD supported by ViewForum

Abstract Syntax		Transfer Syntax		Role	Extended Negotiation
Name	UID	Name List (note)	UID List		
See Note	See Note	ILE ELE EBE	1.2.840.10008.1.2 1.2.840.10008.1.2.1 1.2.840.10008.1.2.2	SCU	None

Note: any of the standard image storage and private SOP classes mentioned before. The preferred transfer syntax is ELE.

ViewForum supports images with Lossy image compression via JPEG as described as shows in the Table below.

Table 59: JPEG coding supported by ViewForum

DICOM Transfer Syntax UID	JPEG coding process	JPEG description
1.2.840.10008.1.2.4.50	1	Lossy, Baseline (JPEG 8 Bit Image Compression)

Note: Lossy Compression is only supported for images with photometric interpretation RGB and YBR_FULL_422 and therefore ViewForum supports this only for Ultrasound Images.

5.1.2. Functional Definitions of AE's

This section shall describe in general terms the functions to be performed by the AE, and the DICOM services used to accomplish these functions.

5.1.2.1. Functional Definition of ViewForum AE

The ViewForum AE is the one and only application entity within ViewForum R5.1. It includes the following service class.

Media Storage Service Class for CD and DVD

The ViewForum AE can perform the CD-R Media Storage service as SCU, with capabilities for:

RWA Display Directory (as FSR),
RWA Write Images (as FSC / FSU), and
RWA Read Images (as FSR).

For DVD the ViewForum AE can perform the Media Storage service as SCU, with capabilities for:

RWA Display Directory (as FSR),
RWA Write Images (as FSC), and
RWA Read Images (as FSR).

5.1.3. Sequencing of Real World Activities

Whenever a CD or DVD has to be written the ViewForum AE first tries to read the DICOMDIR. The ViewForum AE will compile the updated DICOMDIR and any required DICOM images into a CD or DVD session image; this CD or DVD session image will be written to CD or DVD.

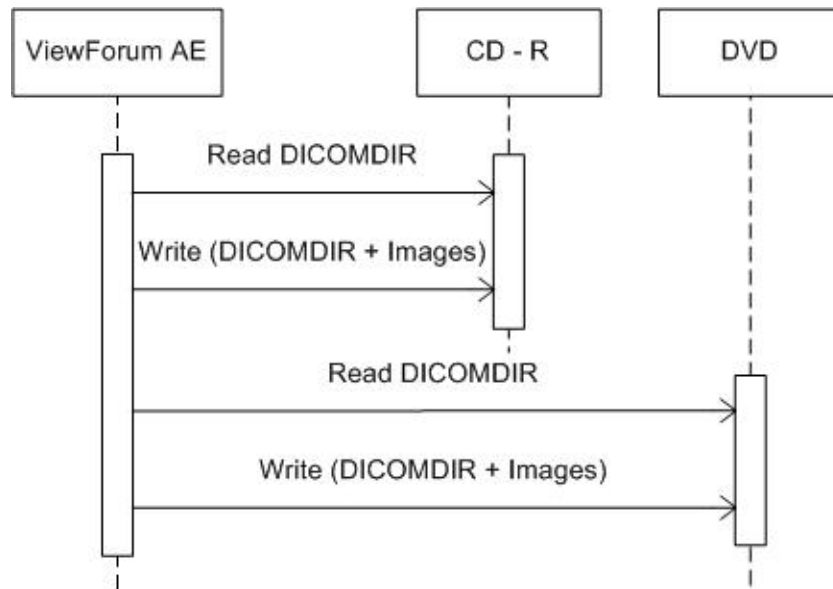

Figure 17: Sequencing of RWA Write Images

5.1.4. File Meta Information for Implementation Class and Version

This section shall be used to list the values assigned to the File Meta Information attributes (ref. [DICOM] PS 3.10) that pertain to the Implementation Class and Version.

The Implementation Class UID and the Implementation Version Name in the File Meta Header are as specified for Networking (ref. Table 9 in section 4.2.1.2.4).

Table 60: DICOM Implementation Class and Version for ViewForum AE

File Meta Information Version	00, 01
Implementation Class UID	1.3.46.670589.5.2.23
Implementation Version Name	ViewForum R4.3

5.2. AE Specifications

The next section in the DICOM Conformance Statement contains the specification of the one and only ViewForum R5.1 Application Entity: ViewForum AE.

5.2.1. ViewForum AE

The ViewForum AE provides Standard Conformance to the DICOM Media Storage Service and File Format ([DICOM] PS 3.10), the Media Storage Application Profiles STD-GEN-CD ([DICOM] PS 3.11) and the Media Storage Application Profiles STD-GEN-DVD-JPEG ([DICOM] PS 3.12) for Reading and Writing.

ViewForum supports multi-patient and multi-session CD-R / DVD disks, both for Reading and Writing.

Supported media by ViewForum are:

for CD: CD R / CD RW with the profile: STD-GEN-CD and

for DVD: DVD+R and DVD+RW with the profile: STD-GEN-DVD-JPEG and the Transfer Syntax ELE uncompressed.

DVD-R and DVD-RW can be read but are not supported for writing.

The supported Application Profiles, their Roles and the Service Class (SC) options, all defined in DICOM terminology, are listed in Table 61.

Table 61: AE Related Application Profiles, Real-World Activities, and Roles for CD-R and DVD

Supported Application Profile	Real-World Activity	Roles	SC Option
STD-GEN-CD	Display Directory	FSR	Interchange
	Write Images	FSC, FSU	Interchange
	Read Images	FSR	Interchange
STD-GEN-DVD-JPEG	Display Directory	FSR	Interchange
	Write Images	FSC	Interchange
	Read Images	FSR	Interchange

Only adding on instances is supported for the FSU, deleting is not supported.

5.2.1.1. File Meta Information for the ViewForum AE

The Source Application Entity Title is configurable (see ref. section 5.4 Media Configuration).

5.2.1.2. Real-World Activities

5.2.1.2.1. Display Directory

When a database open action is initiated on the CD-R or DVD then the ViewForum AE acts as an FSR using the interchange option to read the DICOMDIR of the CD-R or DVD medium.

This will result in an overview of the patients, studies, series and images on the ViewForum R5.1 screen.

5.2.1.2.1.1. Media Storage Application Profile

As depicted in Table 61, the ViewForum AE supports the RWA Display Directory for the STD-GEN-CD and the STD-GEN-DVD-JPEG Application Profile.

5.2.1.2.1.1.1. Options

The mandatory DICOMDIR keys are required for the correct display of directory information. The display is structured according the DICOM Composite Information Model: Patient, Study, Serie and Image.

5.2.1.2.2. Write Images

When an image transfer to CD-R or DVD is initiated then the ViewForum AE acts as an FSC or FSU (CD-R only) using the interchange option to export SOP Instances from the local database to a CD-R or DVD medium. If an image transfer to CD-R or DVD is initiated it is possible to indicate what the size of the selected storage medium is, how much space is use and free, and how big the selection is that is write to the storage medium.

5.2.1.2.2.1. Media Storage Application Profile

As depicted in Table 61, the ViewForum AE supports the RWA Write Images for the STD-GEN-CD and the STD-GEN-DVD-JPEG Application Profile.

5.2.1.2.2.1.1. Options

The same remarks as in section 4.2.1.3.1.3 about the existence of Optional, Retired and Private Attributes are applicable.

The DICOMDIR file will be extended when new images are written. In case some attributes are not present in an image but are specified as mandatory in the DICOMDIR definition in DICOM Media, a generated value will be filled in.

Implementation remarks and restrictions

When writing the DICOMDIR records, key values are generated when no value of the corresponding attribute is supplied, according to the following table.

Table 62: Generated Keys

Key	Tag	Generated Value
Patient Keys		
Patient ID	(0010,0020)	At import ViewForum R5.1 each time creates a new value based on the Study Instance UID for each new study written to the CD-R/ DVD (even if this study belongs to a patient recorded earlier). Otherwise the default-generated value shall be a succession of "UNKNOWN", the Patient's Name, the Patient's Birth Date, and the Patient's Sex, concatenated by using underscore characters.
Study Keys		
Study Date	(0008,0020)	Current date
Study Time	(0008,0030)	Current time
Study ID	(0020,0010)	"UNKNOWN"
Series Keys		
Series Number	(0020,0011)	1
Image Keys		
Instance Number	(0020,0013)	1

The default value for the Pixel Intensity Relationship (0028,1040) is set to DISP.

ViewForum R5.1 can write volumes of the media to that media.
ViewForum asks for a new media if media is spanning over more CD-R / DVD disks.

5.2.1.2.3. Read Images

When an image transfer from CD-R or DVD is initiated then the ViewForum AE acts as an FSR using the interchange option to import SOP Instances from the CD-R / DVD medium.

5.2.1.2.3.1. Media Storage Application Profile

As depicted in Table 61, the ViewForum AE supports the RWA Read Images for the STD-GEN-CD and STD-GEN-DVD-JPEG Application Profile.

5.2.1.2.3.1.1. Options

The mandatory attributes of the DICOM images are required for the correct storage of the images in the ViewForum R5.1 internal image database.

Optional attributes and Retired/Private attributes are stored too – if present; this is equivalent with the level 2 (Full) conformance for the Storage service class in the Network support; ref. section 4.2.1.4.2.

The same remarks as in section 4.2.1.4.2.3 about the storage of images and about requirements to process read images via the dedicated ViewForum R5.1 application functions are applicable.

5.3. Augmented and Private Application Profiles

This section shall be used for the description of Augmented and Private Application Profiles.

5.3.1. Augmented Application Profiles

None.

5.3.2. Private Application Profiles

None.

5.4. Media Configuration

Any configuration issues may be found in the Networking section 4.4 Configuration.

6. SUPPORT OF CHARACTER SETS

ViewForum R5.1 supports the extended character set ISO 2022 IR 100, which is the Latin alphabet No 1, supplementary set.

When the ViewForum AE receives images with undefined character set then the import will be terminated with error status code.

ViewForum will accept images within Asian characters in the Patient's Name, however ViewForum will *not* display the patient's name properly.

ViewForum R5.1 also supports the Japanese ISO 2022 IR87 character set and will accept images within Japanese characters in the Patient's Name, Referring Physician's Name and other DICOM Person Names.

7. SECURITY

7.1. Security Profiles

None supported.

7.2. Association level security

Any calling AE title and/or IP address may open an association.

7.3. Application level security

The ViewForum R5.1 supports the HIPAA Audit trail profile.

The ViewForum can create audit messages according to the IHE Basic Security Integration Profile [IHE] to audit activities, to detect non-compliant behavior in the enterprise, and to facilitate detection of improper creation, access, modification and deletion of Protected Health Information (PHI).

These messages may contain information that identifies the patient

8. ANNEXES

8.1. IOD Contents

8.1.1. Created SOP Instances

This section specifies each IOD created by the ViewForum AE.

Used abbreviations are:

ALWAYS	the module or attribute shall always be present with value
ANAP	Attribute Not Always Present
VNAP	Value Not Always Present (attribute sent zero length if no value is present)
EMPTY	Attribute is sent without a value
MAYBE	the module may be present under specified condition
OPTIONAL	the module may be available, depending on source object
AUTO	the attribute value is generated automatically
CONF	the attribute value source is a configurable parameter
IMPL	the attribute value source is a user-implicit configuration setting
SPEC	the attribute value source is a specific DICOM object
USER	the attribute value source is explicit user input

8.1.1.1. Secondary Capture Image Storage SOP Class

Information Entity	Module Name	Reference	Presence of Module
Patient	Patient Module	Table 63	ALWAYS
Study	General Study Module	Table 64	ALWAYS
	Patient Study Module	Table 65	OPTIONAL
Series	General Series Module	Table 69	ALWAYS
Equipment	General Equipment Module	Table 66	OPTIONAL
	SC Equipment Module	Table 67	ALWAYS
Image	General Image Module	Table 71	ALWAYS
	Image Pixel Module	Table 72	ALWAYS
	SC Image Module	Table 70	ALWAYS
	Overlay Plane Module	Table 75	OPTIONAL
	Modality LUT Module	Table 68	OPTIONAL
	VOI LUT Module	Table 68	OPTIONAL
	SOP Common Module		ALWAYS
Private	Private Module	Table 74	ANAP
		Table 77	

Table 63: Patient Module

Attribute Name	Tag	VR	Value	Presence of Value	Source
Patient's Name	0010,0010	PN		VNAP	AUTO
Patient ID	0010,0020	LO		VNAP	AUTO
Patient's Birth Date	0010,0030	DA		VNAP	AUTO
Patient's Sex	0010,0040	CS		VNAP	AUTO
Referenced Patient Sequence	0008,1120	SQ		ANAP	AUTO
>Referenced SOP Class UID	0008,1150	UI		MAYBE	AUTO
>Referenced SOP Instance UID	0008,1155	UI		MAYBE	AUTO
Patient's Birth Time	0010,0032	TM		ANAP	AUTO
Other Patient IDs	0010,1000	LO		ANAP	AUTO
Other Patient Names	0010,1001	PN		ANAP	AUTO
Ethnic Group	0010,2160	SH		ANAP	AUTO
Patient Comments	0010,4000	LT		ANAP	AUTO

Table 64: General Study Module

Attribute Name	Tag	VR	Value	Presence of Value	Source
Study Instance UID	0020,000D	UI		ALWAYS	AUTO
Study Date	0008,0020	DA		VNAP	AUTO
Study Time	0008,0030	TM		VNAP	AUTO
Referring Physician's Name	0008,0090	PN		VNAP	AUTO
Study ID	0020,0010	SH		VNAP	AUTO
Accession Number	0008,0050	SH		VNAP	AUTO
Study Description	0008,1030	LO		ANAP	AUTO
Physician(s) of Record	0008,1048	PN		ANAP	AUTO
Name of Physician(s) Reading Study	0008,1060	PN		ANAP	AUTO
Referenced Study Sequence	0008,1110	SQ		ANAP	AUTO
>Referenced SOP Class UID	0008,1150	UI		MAYBE	AUTO
>Referenced SOP Instance UID	0008,1155	UI		MAYBE	AUTO
Procedure Code Sequence	0008,1032	SQ		ANAP	AUTO
>Code Sequence Macro			Reference Table 76		

Table 65: Patient Study Module

Attribute Name	Tag	VR	Value	Presence of Value	Source
Admitting Diagnoses Description	0008,1080	UI		ANAP	AUTO
Admitting Diagnoses Code Sequence	0008,1084	SQ		ANAP	AUTO
>Code Sequence Macro			Reference Table 76		
Patient's Age	0010,1010	AS		ANAP	AUTO
Patient's Size	0010,1020	DS		ANAP	AUTO
Patient's Weight	0010,1030	DS		ANAP	AUTO
Occupation	0010,2180	SH		ANAP	AUTO
Additional Patient's History	0010,21B0	LT		ANAP	AUTO

Table 66: General Equipment Module

Attribute Name	Tag	VR	Value	Presence of Value	Source
Manufacturer	0008,0070	LO		VNAP	AUTO
Institution Name	0008,0080	LO		ANAP	AUTO
Institution Address	0008,0081	ST		ANAP	AUTO
Station Name	0008,1010	SH		ANAP	AUTO
Institutional Department Name	0008,1040	LO		ANAP	AUTO
Manufacturer's Module Name	0008,1090	LO		ANAP	AUTO
Device Serial Number	0018,1000	LO		ANAP	AUTO
Software Versions	0018,1020	LO		ANAP	AUTO
Spatial Resolution	0018,1050	DS		ANAP	AUTO
Date of Last Calibration	0018,1200	DA		ANAP	AUTO
Time of Last Calibration	0018,1201	TM		ANAP	AUTO
Pixel Padding Value	0028,0120	US/ SS		ANAP	AUTO

Table 67: SC Equipment Module

Attribute Name	Tag	VR	Value	Presence of Value	Source
Modality	0008,0060	CS		ALWAYS	AUTO
Conversion Type	0008,0064	CS	WSD	ALWAYS	AUTO

Table 68: Modality LUT Module

Attribute Name	Tag	VR	Value	Presence of Value	Source
Modality LUT Sequence	0028,3000	SQ		MAYBE	AUTO
>LUT Descriptor	0028,3002	US/ SS		MAYBE	AUTO
>LUT Explanation	0028,3003	LO		ANAP	AUTO
>Modality LUT Type	0028,3004	LO		MAYBE	AUTO
>LUT Data	0028,3006	US/ SS/ OW		MAYBE	AUTO
Rescale Intercept	0028,1052	DS		MAYBE	AUTO
Rescale Slope	0028,1053	DS		MAYBE	AUTO

Table 69: General Series Module

Attribute Name	Tag	VR	Value	Presence of Value	Source
Series Instance UID	0020,000E	UI		ALWAYS	CONF
Series Number	0020,0011	IS		VNAP	AUTO
Laterality	0020,0060	CS		MAYBE	AUTO
Series Date	0008,0021	DA		ANAP	AUTO
Series Time	0008,0031	TM		ANAP	AUTO
Performing Physicians' Name	0008,1050	PN		ANAP	AUTO
Protocol Name	0018,1030	LO		ANAP	AUTO
Series Description	0008,103E	LO		ANAP	AUTO
Operators' Name	0008,1070	PN		ANAP	AUTO
Referenced Performed Procedure Step_Sequence	0008,1111	SQ		ANAP	AUTO
>Referenced SOP Class UID	0008,1150	UI		MAYBE	AUTO
>Referenced SOP Instance UID	0008,1155	UI		MAYBE	AUTO
Body Part Examined	0018,0015	CS		ANAP	AUTO
Patient Position	0018,5100	CS		MAYBE	AUTO
Smallest Pixel Value in Series	0028,0108	US/SS		ANAP	AUTO
Largest Pixel Value in Series	0028,0109	US/SS		ANAP	AUTO
Request Attributes Sequence	0040,0275	SQ		ANAP	AUTO
>Requested Procedure ID	0040,1001	SH		MAYBE	AUTO
>Scheduled Procedure Step ID	0040,0009	SH		MAYBE	AUTO
>Scheduled Procedure Step Description	0040,0007	LO		ANAP	AUTO
>Scheduled Protocol Code Sequence	0040,0008	SQ		ANAP	AUTO
>>Code Sequence Code Sequence			Reference Table 76		
Performed Procedure Step ID	0040,0253	SH		ANAP	AUTO
Performed Procedure Step Start Date	0040,0244	DA		ANAP	AUTO
Performed Procedure Step Start Time	0040,0245	TM		ANAP	AUTO
Performed Procedure Step Description	0040,0254	LO		ANAP	AUTO
Performed Protocol Code Sequence	0040,0260	SQ		ANAP	AUTO
>Code Sequence Macro			Reference Table 76		
Comments on the Performed Procedure Step	0040,0280	ST		ANAP	AUTO

Table 70: SC Image Module Module

Attribute Name	Tag	VR	Value	Presence of Value	Source
Date of Secondary Capture	0018,1012	DA		ALWAYS	AUTO
Time of Secondary Capture	0018,1014	TM		ALWAYS	AUTO

Table 71: General Image Module

Attribute Name	Tag	VR	Value	Presence of Value	Source
Instance Number	0020,0013	IS		VNAP	AUTO
Patient Orientation	0020,0020	CS		ALWAYS	AUTO
Content Date	0008,0023	DA		MAYBE	AUTO
Content Time	0008,0033	TM		MAYBE	AUTO
Image Type	0008,0008	CS		ANAP	AUTO
Acquisition Number	0020,0012	IS		ANAP	AUTO
Acquisition Date	0008,0022	DA		ANAP	AUTO
Acquisition Time	0008,0032	TM		ANAP	AUTO
Acquisition Datetime	0008,002A	DT		ANAP	AUTO
Referenced Image Sequence	0008,1140	SQ		ANAP	AUTO
>Referenced SOP Class UID	0008,1150	UI		MAYBE	AUTO
>Referenced SOP Instance UID	0008,1155	UI		MAYBE	AUTO
>Referenced Frame Number	0008,1160	IS		ANAP	AUTO
>Purpose of Reference Code Sequence	0040,A170	SQ		ANAP	AUTO
>>Code Sequence Macro			Reference Table 76		
Derivation Description	0008,2111	ST		ANAP	AUTO
Derivation Code Sequence	0008,9215	SQ		ANAP	AUTO
>>Code Sequence Macro			Reference Table 76		
Source Image Sequence	0008,2112	SQ		ANAP	AUTO
>Referenced SOP Class UID	0008,1150	UI		MAYBE	AUTO
>Referenced SOP Instance UID	0008,1155	UI		MAYBE	AUTO
>Referenced Frame Number	0008,1160	IS		ANAP	AUTO
>Purpose of Reference Code Sequence	0040,A170	SQ		ANAP	AUTO
>>Code Sequence Macro			Reference Table 76		
>Purpose of Reference Code Sequence	0040,A170	SQ		ALWAYS	AUTO
>>Code Sequence Marco			Reference Table 76		
Images in Acquisition	0020,1002	IS		ANAP	AUTO
Image Comments	0020,4000	LT		ANAP	AUTO
Quality Control Image	0028,0300	CS		ANAP	AUTO
Burned in Annotation	0028,0301	CS		ANAP	AUTO
Lossy Image Compression	0028,2110	CS		ANAP	AUTO
Lossy Image Compression Ratio	0028,2112	DS		ANAP	AUTO
Icon Image Sequence	0088,0200	SQ		ANAP	AUTO
>Pixel Spacing	0028,0030	DS		ALWAYS	AUTO
>Slice Thickness	0018,0050	DS		ALWAYS	AUTO
>Slice Location	0020,1041	DS		ALWAYS	AUTO
Presentation LUT Shape	2050,0020	CS		ANAP	AUTO

Table 72: Image Pixel Module

Attribute Name	Tag	VR	Value	Presence of Value	Source
Samples per Pixel	0028,0002	US		ALWAYS	AUTO
Photometric Interpretation	0028,0004	CS		ALWAYS	AUTO
Row	0028,0010	US		ALWAYS	AUTO
Columns	0028,0011	US		ALWAYS	AUTO
Bits Allocated	0028,0100	US		ALWAYS	AUTO
Bits Stored	0028,0101	US		ALWAYS	AUTO
High Bit	0028,0102	US		ALWAYS	AUTO
Pixel Representation	0028,0103	US		ALWAYS	AUTO
Pixel Data	7FE0,0010	OW		ALWAYS	AUTO
Planar Configuration	0028,0006	US		MAYBE	AUTO
Pixel Aspect Ratio	0028,0034	IS		MAYBE	AUTO
Smallest Image Pixel Value	0028,0106	US/ SS		ANAP	AUTO
Largest Image Pixel Value	0028,0107	US/ SS		ANAP	AUTO
Red Palette Color Lookup Table Descriptor	0028,1101	US/ SS		MAYBE	AUTO
Green Palette Color Lookup Table Descriptor	0028,1102	US/ SS		MAYBE	AUTO
Blue Palette Color Lookup Table Descriptor	0028,1103	US/ SS		MAYBE	AUTO
Red Palette Color Lookup Table Data	0028,1201	OW		MAYBE	AUTO
Green Palette Color Lookup Table Data	0028,1202	OW		MAYBE	AUTO
Blue Palette Color Lookup Table Data	0028,1203	OW		MAYBE	AUTO

Table 73: VOI LUT Module

Attribute Name	Tag	VR	Value	Presence of Value	Source
VOI LUT Sequence	0028,3010	SQ		ANAP	AUTO
>LUT Descriptor	0028,3002	US/ SS		MAYBE	AUTO
>LUT Explanation	0028,3003	LO		ANAP	AUTO
>LUT Data	0028,3006	US/ SS/ OW		MAYBE	AUTO
Window Center	0028,1050	DS		ANAP	AUTO
Window Width	0028,1051	DS		MAYBE	AUTO
Window Center & Width Explanation	0028,1055	LO		ANAP	AUTO

Table 74: SOP Common Module

Attribute Name	Tag	VR	Value	Presence of Value	Source
SOP Class UID	0008,0016	UI	1.2.840.10008.5.1.1.7	ALWAYS	AUTO
SOP Instance UID	0008,0018	UI		ALWAYS	AUTO

Table 75: Overlay Plane Module

Attribute Name	Tag	VR	Value	Presence of Value	Source
Overlay Rows	60xx,0010	US		ALWAYS	AUTO
Overlay Columns	60xx,0011	US		ALWAYS	AUTO
Overlay Type	60xx,0040	CS		ALWAYS	AUTO
Overlay Origin	60xx,0050	SS		ALWAYS	AUTO
Overlay Bits Allocated	60xx,0100	US		ALWAYS	AUTO
Overlay Bits Position	60xx,0102	US		ALWAYS	AUTO
Overlay Data	60xx,3000	OW/ OB		MAYBE	AUTO
Overlay Description	60xx,0022	LO		ANAP	AUTO
Overlay Subtype	60xx,0045	LO		ANAP	AUTO
Overlay Label	60xx,1500	LO		ANAP	AUTO
ROI Area	60xx,1301	IS		ANAP	AUTO
ROI Mean	60xx,1302	DS		ANAP	AUTO
ROI Standard Deviation	60xx,1303	DS		ANAP	AUTO

Table 76: Code Sequence Macro

Attribute Name	Tag	VR	Value	Presence of Value	Source
Basic Coded Entry Attributes					
Code Value	0008,0100	SH		MAYBE	AUTO
Coding Scheme Designator	0008,0102	SH		MAYBE	AUTO
Coding Scheme Version	0008,0103	SH		MAYBE	AUTO
Code Meaning	0008,0104	LO		MAYBE	AUTO
Enhanced Encoding Mode					
Context Identifier	0008,010F	CS		ANAP	AUTO
Mapping Resource	0008,0105	CS		MAYBE	AUTO
Context Group Version	0008,0106	DT		MAYBE	AUTO
Context Group Extension Flag	0008,010B	CS		ANAP	AUTO
Context Group Local Version	0008,0107	DT		MAYBE	AUTO
Context Group Extension Creator UID	0008,010D	UI		MAYBE	AUTO

Table 77: Private Module

Attribute Name	Tag	VR	Value	Presence of Value	Source
	2001,00FF	LO		ANAP	AUTO
	2001,FF6E	SH		ANAP	AUTO
	2007,00FE	LO		ANAP	AUTO
	2007,FE12	LO		ANAP	AUTO

8.1.1.2. Grayscale Softcopy Presentation State Storage SOP Class

When the ViewForum AE imports a storage object without presentation state object then it will create a presentation object for this storage object, which it then can use for export (if negotiated).

If private presentation state information exists, then this will be used to create the presentation state object. Depending on the setup, the ViewForum AE may or may not add this private presentation state information on export.

Table 78: Modules of the Grayscale Softcopy Presentation State Storage SOP Class

Information Entity	Module Name	Reference	Presence of Module
Patient	Patient Module	Table 79	ALWAYS
Study	General Study Module	Table 80	ALWAYS
Series	General Series Module	Table 81	ALWAYS
	Presentation Series Module	Table 82	ALWAYS
Equipment	General Equipment Module	Table 84	ALWAYS
Modality LUT	Modality LUT Module	Table 83	MAYBE
Image	Mask module	Table 85	MAYBE
	Display shutter module	Table 86	MAYBE
	Overlay Plane Module	Table 87	MAYBE
	Displayed Area Module	Table 88	ALWAYS
	Graphic Layer Module	Table 89	MAYBE
	Softcopy Presentation LUT Module	Table 90	ALWAYS
	Overlay/Curve Activation Module	Table 91	MAYBE
	Softcopy VOI LUT Module	Table 92	MAYBE
	Presentation State Module	Table 93	ALWAYS
	SOP Common Module	Table 94	ALWAYS

Table 79: Patient Module

Attribute Name	Tag	VR	Value	Presence of Value	Source
Patient's Name	0010,0010	PN		VNAP	SPEC
Patient ID	0010,0020	LO		VNAP	SPEC
Patient's Birth Date	0010,0030	DA		VNAP	SPEC
Patient's Sex	0010,0040	CS	F, M, O	VNAP	SPEC

Table 80: General Study Module

Attribute Name	Tag	VR	Value	Presence of Value	Source
Study Instance UID	0020,000D	UI		ALWAYS	SPEC
Study Date	0008,0020	DA		VNAP	SPEC
Study Time	0008,0030	TM		VNAP	SPEC
Referring Physician's Name	0008,0090	PN		VNAP	SPEC
Study ID	0020,0010	SH		VNAP	SPEC
Accession Number	0008,0050	SH		VNAP	SPEC
Study Description	0008,1030	LO		ANAP	SPEC

Table 81: General Series Module

Attribute Name	Tag	VR	Value	Presence of Value	Source
Series Instance UID	0020,000E	UI		ALWAYS	AUTO
Series Number	0020,0011	IS		VNAP	SPEC
Series Date	0008,0021	DA		ANAP	SPEC
Series Time	0008,0031	TM		ANAP	SPEC
Laterally	0020,0060	CS	L, R	MAYBE	SPEC

Table 82: Presentation Series Module

Attribute Name	Tag	VR	Value	Presence of Value	Source
Modality	0008,0060	CS	PR	ALWAYS	AUTO

Table 83: Modality LUT Module

Attribute Name	Tag	VR	Value	Presence of Value	Source
Modality LUT Sequence	0028,3000	SQ		MAYBE	SPEC
>LUT Descriptor	0028,3002	US/ SS		MAYBE	SPEC
>LUT Explanation	0028,3003	LO		ANAP	SPEC
>Modality LUT Type	0028,3004	LO		MAYBE	SPEC
>LUT Data	0028,3006	US/ SS/ OW		MAYBE	SPEC
Rescale Intercept	0028,1052	DS		MAYBE	SPEC
Rescale Slope	0028,1053	DS		MAYBE	SPEC
Rescale Type	0028,1054	LO		MAYBE	SPEC

Table 84: General Equipment Module

Attribute Name	Tag	VR	Value	Presence of Value	Source
Manufacturer	0008,0070	LO		ALWAYS	AUTO
Manufacturer's Model Name	0008,1090	LO		ALWAYS	AUTO
Software Versions	0018,1020	LO		ALWAYS	AUTO

Table 85: Mask Module

Attribute Name	Tag	VR	Value	Presence of Value	Source
Recommended Viewing Mode	0028,1090	CS	NAT, SUB	VNAP	SPEC
Mask Subtraction Sequence	0028,6100	SQ		ALWAYS	SPEC
>Mask Operation	0028,6101	CS	AVG_SUB, NONE, TID	ALWAYS	SPEC
>Applicable Frame Range	0028,6102	US		ANAP	SPEC
>Mask Frame Numbers	0028,6110	US		MAYBE	SPEC
>Contrast Frame Averaging	0028,6112	US		ANAP	SPEC
>Mask Sub-pixel Shift	0028,6114	FL		ANAP	SPEC
>TID Offset	0028,6120	SS		MAYBE	SPEC
>Mask Operation Explanation	0028,6190	ST		ANAP	SPEC

Table 86: DISPLAY Shutter Module

Attribute Name	Tag	VR	Value	Presence of Value	Source
Shutter Shape	0018,1600	CS	CIRCULAR, POLYGONAL, RECTANGULAR	ALWAYS	SPEC
Shutter Left Vertical Edge	0018,1602	IS		MAYBE	SPEC
Shutter Right Vertical Edge	0018,1604	IS		MAYBE	SPEC
Shutter Upper Horizontal Edge	0018,1606	IS		MAYBE	SPEC
Shutter Lower Horizontal Edge	0018,1608	IS		MAYBE	SPEC
Center of Circular Shutter	0018,1610	IS		MAYBE	SPEC
Radius of Circular Shutter	0018,1612	IS		MAYBE	SPEC
Vertices of the Polygonal Shutter	0018,1620	IS		MAYBE	SPEC

Table 87: Overlay Plane Module

Attribute Name	Tag	VR	Value	Presence of Value	Source
Overlay Rows	60xx,0010	US		ALWAYS	SPEC
Overlay Columns	60xx,0011	US		ALWAYS	SPEC
Overlay Description	60xx,0022	LO		ALWAYS	SPEC
Overlay Type	60xx,0040	CS	G, R	ALWAYS	SPEC
Overlay Subtype	60xx,0045	LO		ANAP	SPEC
Overlay Origin	60xx,0050	SS	1/1	ALWAYS	SPEC
Overlay Bits Allocated	60xx,0100	US	1	ALWAYS	SPEC
Overlay Bit Position	60xx,0102	US	0	ALWAYS	SPEC
ROI Area	60xx,1301	IS		ANAP	SPEC
ROI Mean	60xx,1302	DS		ANAP	SPEC
ROI Standard Deviation	60xx,1303	DS		ANAP	SPEC
Overlay Label	60xx,1500	LO		ANAP	SPEC
Overlay Data	60xx,3000	OB/OW		MAYBE	SPEC

Table 88: Displayed Area Module

Attribute Name	Tag	VR	Value	Presence of Value	Source
Displayed Area Selection Sequence	0070,005A	SQ		ALWAYS	AUTO
>Displayed Area Top Left Hand Corner	0070,0052	SL	1/1	ALWAYS	AUTO
>Displayed Area Bottom Right Hand Corner	0070,0053	SL		ALWAYS	AUTO
>Presentation Size Mode	0070,0100	CS	SCALE TO FIT	ALWAYS	AUTO
Private Creator	2001,0010	LO		ALWAYS	AUTO
Interpolation Method	2001,103F	CS		ALWAYS	AUTO

Table 89: Graphic Layer Module

Attribute Name	Tag	VR	Value	Presence of Value	Source
Graphic Layer Sequence	0070,0060	SQ		ALWAYS	AUTO
>Graphic Layer	0070,0002	CS	Layer created on import	ALWAYS	AUTO
>Graphic Layer	0070,0062	IS	1	ALWAYS	AUTO

Table 90: Softcopy Presentation LUT Module

Attribute Name	Tag	VR	Value	Presence of Value	Source
Presentation LUT Sequence	2050,0010	SQ		ALWAYS	AUTO
>LUT Descriptor	0028,3002	SS		ALWAYS	AUTO
>LUT Data	0028,3006	OW		ALWAYS	AUTO

Table 91: Overlays/Curve Activation Module

Attribute Name	Tag	VR	Value	Presence of Value	Source
Curve Activation Layer	50xx,1001	CS	Layer created on import	MAYBE	AUTO
Overlay Activation Layer	60xx,1001	CS	Layer created on import	MAYBE	AUTO

Table 92: Softcopy VOI LUT Module

Attribute Name	Tag	VR	Value	Presence of Value	Source
Softcopy VOI LUT Sequence	0028,3110	SQ		ALWAYS	SPEC
>Referenced Image Sequence	0008,1140	SQ		MAYBE	SPEC
>>Referenced SOP Class UID	0008,1150	UI		MAYBE	SPEC
>>Referenced SOP Instance UID	0008,1155	UI		MAYBE	SPEC
>>Referenced Frame Number	0008,1160	IS		MAYBE	SPEC
>Window Center	0028,1050	DS		MAYBE	SPEC
>Window Width	0018,1051	DS		MAYBE	SPEC
>Window Center & Width Explanation	0028,1055	LO		ANAP	SPEC
>VOI LUT Sequence	0028,3010	SQ		MAYBE	SPEC
>>LUT Descriptor	0028,3002	SS/ US		MAYBE	SPEC
>>LUT Explanation	0028,3003	LO		ANAP	SPEC
>>LUT Data	0028,3006	OW/ SS/ US		MAYBE	SPEC

Table 93: Presentation State Module

Attribute Name	Tag	VR	Value	Presence of Value	Source
Referenced Series Sequence	0008,1115	SQ		ALWAYS	AUTO
>Referenced Image Sequence	0008,1140	SQ		MAYBE	AUTO
>>Referenced SOP Class UID	0008,1150	UI		MAYBE	AUTO
>>Referenced SOP Instance UID	0008,1155	UI		MAYBE	AUTO
>Series Instance UID	0020,000E	UI		MAYBE	AUTO
Shutter Presentation Value	0018,1622	US	0	MAYBE	AUTO
Instance Number	0020,0013	IS	1	ALWAYS	AUTO
Presentation Label	0070,0080	CS	NEW AT IMPORT	ALWAYS	AUTO
Presentation Description	0070,0081	LO		VNAP	AUTO
Presentation Creation Date	0070,0082	DA	Current date	ALWAYS	AUTO
Presentation Creation Time	0070,0083	TM	Current time	ALWAYS	AUTO
Presentation Creator's Name	0070,0084	PN		VNAP	AUTO

Table 94: SOP Common Module

Attribute Name	Tag	VR	Value	Presence of Value	Source
SOP Class UID	0008,0016	UI	1.2.840.10008.5.1.1.23	ALWAYS	AUTO
SOP Instance UID	0008,0018	UI		ALWAYS	AUTO

8.1.2. Attribute Mapping

Not applicable.

8.1.3. Coerced/Modified fields

In general, ViewForum R5.1 will try and optimize the imported image data. This may involve the removal of redundant data, either or not due to the creation of a Presentation State object for the image data. This may also involve the creation of extra attributes. As it is not the intention of ViewForum R5.1 to export this data as such, the SOP Instance UID shall not be changed.

If not available at import then ViewForum R5.1 will create the additional attributes as listed in 95.

Table 95: Additional Attributes for Import Images

Attribute Name	Tag	VR	Generated Value
Performed Procedure Step Start Date	0040,0244	DA	Copied from (0008,0020) Study Date.
Performed Procedure Step Start Time	0040,0245	TM	Copied from (0008,0030) Study Time.
Performed Procedure Step ID	0040,0253	SH	Copied from (0020,0010) Study ID.
Performed Procedure Step Description	0040,0254	LO	Copied from (0008,1030) Study Description.

If the SCU does not propose a presentation context for the Grayscale Softcopy Presentation State storage SOP class, then ViewForum R5.1 will derive Presentation State data from the imported image data and store this data in a new series within the examination of the imported image.

However, if during import the image is accompanied by Presentation State data, the ViewForum R5.1 database shall avoid data overlap by only storing the relevant data from the first object received; either the first image or its Presentation State! Thus it will omit data received by succeeding objects concerning the optional attributes (VT=3) listed in Table 96, and clear all mandatory attributes (VT=2) listed in Table 97.

Table 96: Omitted Attributes for Import Images

Attribute Name	Tag	VR	Value	Presence of Value	Source
Patient Module					
Referenced Patient Sequence	0008,1120	SQ		ANAP	AUTO
Patient's Birth Time	0010,0032	TM		ANAP	AUTO
Other Patient Ids	0010,1000	LO		ANAP	AUTO
Other Patient Names	0010,1001	PN		ANAP	AUTO
Ethnic Group	0010,2160	SH		ANAP	AUTO
Patient Comments	0010,4000	LT		ANAP	AUTO
General Study Module					
Referring Physician Identification	0008,0096	SQ		ANAP	AUTO

Sequence					
Study Description	0008,1030	LO		ANAP	AUTO
Procedure Code Sequence	0008,1032	SQ		ANAP	AUTO
Physician(s) of Record	0008,1048	PN		ANAP	AUTO
Physician(s) of Record Identification Sequence	0008,1049	SQ		ANAP	AUTO
Name of Physician(s) Reading Study	0008,1060	PN		ANAP	AUTO
Physician(s) Reading Study Identification Sequence	0008,1062	SQ		ANAP	AUTO
Referenced Study Sequence	0008,1110	SQ		ANAP	AUTO
Patient Study Module					
Admitting Diagnoses Description	0008,1080	UI		ANAP	AUTO
Admitting Diagnoses Code Sequence	0008,1084	SQ		ANAP	AUTO
Patient's Age	0010,1010	AS		ANAP	AUTO
Patient's Size	0010,1020	DS		ANAP	AUTO
Patient's Weight	0010,1030	DS		ANAP	AUTO
Occupation	0010,2180	SH		ANAP	AUTO
Additional Patient History	0010,21B0	LT		ANAP	AUTO
Clinical Trial Study Module					
Clinical Trial Time Point Description	0012,0051			ANAP	AUTO
General Series Module					
Series Date	0008,0021	DA		ANAP	AUTO
Series Time	0008,0031	TM		ANAP	AUTO
Series Description	0008,103E	LO		ANAP	AUTO
Performing Physicians' Name	0008,1050	PN		ANAP	AUTO
Performing Physician Identification Sequence	0008,1052	SQ		ANAP	AUTO
Operators' Name	0008,1070	PN		ANAP	AUTO
Operators Identification Sequence	0008,1072	SQ		ANAP	AUTO
Referenced Performed Procedure Step Sequence	0008,1111	SQ		ANAP	AUTO
Body Part Examined	0018,0015	CS		ANAP	AUTO
Protocol Name	0018,1030	LO		ANAP	AUTO
Smallest Pixel Value in Series	0028.0108	US / SS		ANAP	AUTO
Largest Pixel Value in Series	0028.0109	US / SS		ANAP	AUTO
Performed Procedure Step Start Date	0040,0244	DA		ANAP	AUTO
Performed Procedure Step Start Time	0040,0245	TM		ANAP	AUTO
Performed Procedure Step ID	0040,0253	SH		ANAP	AUTO
Performed Procedure Step Description	0040,0254	LO		ANAP	AUTO
Performed Protocol Code Sequence	0040,0260	SQ		ANAP	AUTO
Request Attributes Sequence	0040,0275	SQ		ANAP	AUTO
Comments on the Performed Procedure Step	0040,0280	ST		ANAP	AUTO
General Equipment Module					
Institution Name	0008,0080	LO		ANAP	AUTO
Institution Address	0008,0081	ST		ANAP	AUTO
Station Name	0008,1010	SH		ANAP	AUTO
Institutional Department Name	0008,1040	LO		ANAP	AUTO
Manufacturer's Model Name	0008,1090	LO		ANAP	AUTO
Device Serial Number	0018,1000	LO		ANAP	AUTO
Software Versions	0018,1020	LO		ANAP	AUTO
Spatial Resolution	0018,1050	DS		ANAP	AUTO
Date of Last Calibration	0018,1200	DA		ANAP	AUTO
Time of Last Calibration	0018,1201	TM		ANAP	AUTO

Pixel Padding Value	0028,0120	US / SS		ANAP	AUTO
Display Shutter Module					
Shutter Presentation Value	0018,1622	US		ANAP	AUTO
Overlay Plane Module					
Overlay Description	60xx,0022	LO		ANAP	AUTO
Overlay Subtype	60xx,0045	LO		ANAP	AUTO
ROI Area	60xx,1301	IS		ANAP	AUTO
ROI Mean	60xx,1302	DS		ANAP	AUTO
ROI Standard Deviation	60xx,1303	DS		ANAP	AUTO
Overlay Label	60xx,1500	LO		ANAP	AUTO
SOP Common Module					
Instance Creation Date	0008,0012	DA		ANAP	AUTO
Instance Creation Time	0008,0013	TM		ANAP	AUTO
Instance Creator UID	0008,0014	UI		ANAP	AUTO
Coding Scheme Identification Sequence	0008,0110	SQ		ANAP	AUTO
Timezone Offset From UTC	0008,0201	SH		ANAP	AUTO
Contributing Equipment Sequence	0018,A001	SQ		ANAP	AUTO
Instance Number	0020,0013	IS		ANAP	AUTO
SOP Authorization Date and Time	0100,0420	DT		ANAP	AUTO
SOP Authorization Comment	0100,0424	LT		ANAP	AUTO
Authorization Equipment Certification Number	0100,0426	LO		ANAP	AUTO
MAC Parameters Sequence	4FFE,0001	SQ		ANAP	AUTO
Digital Signatures Sequence	FFFA,FFFA	SQ		ANAP	AUTO

Table 97: Cleared Attributes for Import Images

Attribute Name	Tag	VR	Value	Presence of Value	Source
Patient Module					
Patient's Name	0010,0010	PN		VNAP	AUTO
Patient ID	0010,0020	LO		VNAP	AUTO
Patient's Birth Date	0010,0030	DA		VNAP	AUTO
Patient's Sex	0010,0040	CS		VNAP	AUTO
Clinical Trial Subject Module					
Clinical Trial Protocol Name	0012,0021	LO		VNAP	AUTO
Clinical Trial Site ID	0012,0030	LO		VNAP	AUTO
Clinical Trial Site Name	0012,0031	LO		VNAP	AUTO
General Study Module					
Study Date	0008,0020	DA		VNAP	AUTO
Study Time	0008,0030	TM		VNAP	AUTO
Accession Number	0008,0050	SH		VNAP	AUTO
Referring Physician's Name	0008,0090	PN		VNAP	AUTO
Study ID	0020,0010	SH		VNAP	AUTO
Clinical Trial Study Module					
Clinical Trial Time Point ID	0012,0050	LO		VNAP	AUTO
General Series Module					
Patient Position	0018,5100	CS		MAYBE	AUTO
Series Number	0020,0011	IS		VNAP	AUTO
Laterality	0020,0060	CS		MAYBE	AUTO
Clinical Trial Series Module					
Clinical Trial Coordinating Center	0012,0060	LO		VNAP	AUTO

Name					
General Equipment Module					
Manufacturer	0008,0070	LO		VNAP	AUTO
Mask Module					
Recommended Viewing Mode	0028,1090	CS		VNAP	AUTO
Overlay/Curve Activation Module					
Curve Activation Layer	50xx,1001	CS		ANAP	AUTO
Overlay Activation Layer	60xx,1001	CS		ANAP	AUTO

ViewForum R5.1 allows the operator to modify attributes of the stored images; see Table 98. ViewForum R5.1 does not modify the pixel values of the stored images. Modified images retain their original Study, Series and Image UID.

Table 98: Modifiable Attributes

Attribute Name	Tag	VR	Value	Presence of Value	Source
Patient					
Patient's Name	0010,0010	PN		VNAP	USER
Patient ID	0010,0020	LO		VNAP	USER
Patient's Birth Date	0010,0030	DA		VNAP	USER
Patient's Sex	0010,0040	CS		VNAP	USER
Medical Alerts	0010,2000	LO	1-N	VNAP	USER
Contrast Allergies	0010,2110	LO	1-N	VNAP	USER
Patient Comments	0010,4000	LT		ANAP	USER
Study					
Accession Number	0008,0050	SH		VNAP	USER
Referring Physician's Name	0008,0090	PN		VNAP	USER
Study Description	0008,1030	LO		ANAP	USER
Physician(s) of Record	0008,1048	PN	1-N	ANAP	USER
Name of Physician(s) Reading Study	0008,1060	PN	1-N	ANAP	USER
Admitting Diagnoses Description	0008,1080	LO	1-N	ANAP	USER
Patient's Age	0010,1010	AS		ANAP	USER
Occupation	0010,2180	SH		ANAP	USER
Additional Patient History	0010,21B0	LT		ANAP	USER
Examination					
Performed Station Name	0040,0242	SH	An institution defined name for the modality on which the Performed Procedure Step was performed.	ANAP, VNAP	CONF / MPPS
Performed Location	0040,0243	SH	Description of the location at which the Performed Procedure Step was performed.	ANAP, VNAP	USER / MPPS
Performed Procedure Step Description	0040,0254	LO	From Modality Worklist or user input. The user can modify the description provided via Modality Worklist.	ANAP, VNAP	USER / MPPS
Performed Procedure Type Description	0040,0255	LO	A description of the type of procedure performed.	ANAP, VNAP	USER / MPPS
Comments on the Performed Procedure Step	0040,0280	ST	User-defined comments on the Performed Procedure Step.	ANAP, VNAP	USER / MPPS
Series					
-					

ViewForum R5.1 adds additional to exported new created images of the plug in some attributes. Some of the attributes are added for the connection to the created Presentation State. These attributes are listed in Table 99

Table 99: Additional Attributes for Export Images

Attribute Name	Tag	VR	Value	Presence of Value	Source
General Image Module					
Presentation LUT Shape	2050,0020	SQ		ANAP	AUTO
VOI LUT Module					
Window Width	0028,1051	DS		ANAPEV	AUTO
Window Center	0028,1050	DS		ANAP	AUTO

8.2. Data Dictionary of Private Attributes

Not applicable.

8.3. Coded Terminology and Templates

Not applicable.

8.4. Grayscale Image consistency

The high-resolution display monitor attached to the product can be calibrated by using the service tool together with a light probe. See the [VFRB] for details on the calibration procedure.

8.5. Standard Extended/Specialized/Private SOPs

Not applicable.

8.6. Private Transfer Syntaxes

None.

9. ANNEXES PHILIPS ORTHOPAEDIC APPLICATIONS

9.1.1. Created SOP Instances

This section specifies each IOD created by Philips Orthopaedic Applications including the attribute name, tag, VR, and value (range, condition and source).

The Leg Osteotomy Application, Hip implants planning and Lower extremity measurements do not create any SOP Instances. However, they are able to prepare images to be saved as Secondary Capture by the main application. Refer to section 9.1.4 Coerced/Modified fields for further details.

Recommended abbreviations to be used for the IOD tables are:

ALWAYS the module is always present
CONDITIONAL the module is used under specified condition

Recommended abbreviations to be used for the module tables are:

ALWAYS the attribute is always present with a value
EMPTY the attribute is always present without any value (attribute sent zero length)
VNAP the attribute is always present and its Value is Not Always Present (attribute sent zero length if no value is present)
ANAP the Attribute is Not Always Present
VNAPCV Value is Not Always Present (attribute sent zero length if Condition applies and no Value is present)
ANAPEV the Attribute is Not Present if Empty Value

Recommended abbreviations to be used for the source of the data values in the tables are:

AUTO the attribute value is generated automatically
CONFIG the attribute value source is a configurable parameter
COPY the attribute value source is another SOP instance
FIXED the attribute value is hard-coded in the application
IMPLICIT the attribute value source is a user-implicit setting
MPPS the attribute value source is a Modality Performed Procedure Step
MWL the attribute value source is a Modality Worklist
USER the attribute value source is explicit user input

9.1.1.1. Secondary Capture Image IOD

A Secondary Capture Image will adhere to a snapshot image with the next IOD Attributes:

Table 100: Modules of the Secondary Capture Image IOD

Information Entity	Module Name	Reference	Presence of Module
Patient	Patient Module	Table 63	ALWAYS
Study	General Study Module	Table 102	ALWAYS

Information Entity	Module Name	Reference	Presence of Module
Series	Patient Study Module	Table 103	CONDITIONAL
	General Series Module	Table 69	ALWAYS
Equipment	General Equipment Module	Table 105	CONDITIONAL
	SC Equipment Module	Table 106	ALWAYS
Image	General Image Module	Table 107	ALWAYS
	Image Pixel Module	Table 108	ALWAYS
	SC Image Module	Table 109	ALWAYS
	SOP Common Module	Table 74	ALWAYS

Table 101: Patient Module

Attribute Name	Tag	VR	Value	Presence of Value	Source
Patient's Name	0010,0010	PN		VNAP	COPY
Patient ID	0010,0020	LO		VNAP	COPY
Issuer of Patient ID	0010,0021	LO		ANAP	COPY
Patient's Birth Date	0010,0030	DA		VNAP	COPY
Patient's Birth Time	0010,0032	TM		ANAP	COPY
Patient's Sex	0010,0040	CS		VNAP	COPY
Other Patient IDs	0010,1000	LO		ANAP	COPY
Other Patient Names	0010,1001	PN		ANAP	COPY
Ethnic Group	0010,2160	SH		ANAP	COPY
Patient Comments	0010,4000	LT		ANAP	COPY
Referenced Patient Sequence	0008,1120	SQ		ANAP	COPY
>Referenced SOP Class UID	0008,1150	UI		ANAPEV	COPY
>Referenced SOP Instance UID	0008,1155	UI		ANAPEV	COPY

Table 102: General Study Module

Attribute Name	Tag	VR	Value	Presence of Value	Source
Study Instance UID	0020,000D	UI		ALWAYS	COPY
Study Date	0008,0020	DA		VNAP	COPY
Study Time	0008,0030	TM		VNAP	COPY
Accession Number	0008,0050	SH		VNAP	COPY
Referring Physician's Name	0008,0090	PN		VNAP	COPY
Study Description	0008,1030	LO		ANAP	COPY
Procedure Code Sequence	0008,1032	SQ	Include macro: Code Sequence Macro	ANAP	COPY
Physician(s) of Record	0008,1048	PN		ANAP	COPY
Name of Physician(s) Reading Study	0008,1060	PN		ANAP	COPY
Referenced Study Sequence	0008,1110	SQ		ANAP	COPY
>Referenced SOP Class UID	0008,1150	UI		ANAPEV	COPY
>Referenced SOP Instance UID	0008,1155	UI		ANAPEV	COPY
Study ID	0020,0010	SH		VNAP	COPY

Table 103: Patient Study Module

Attribute Name	Tag	VR	Value	Presence of Value	Source
Admitting Diagnoses Description	0008,1080	LO		ANAP	COPY
Patient's Age	0010,0010	AS		ANAP	COPY
Patient's Size	0010,1020	DS		ANAP	COPY
Patient's Weight	0010,1030	DS		ANAP	COPY
Occupation	0010,2180	SH		ANAP	COPY
Additional Patient's History	0010,21B0	LT		ANAP	COPY

Table 104: General Series Module

Attribute Name	Tag	VR	Value	Presence of Value	Source
Series Date	0008,0021	DA		ANAP	COPY
Series Time	0008,0031	TM		ANAP	COPY
Series Description	0008,103E	LO		ANAP	COPY
Performing Physicians' Name	0008,1050	PN		ANAP	COPY
Operators' Name	0008,1070	PN		ANAP	COPY
Referenced Performed Procedure Step Sequence	0008,1111	SQ		ANAP	COPY
>Referenced SOP Class UID	0008,1150	UI		ANAPEV	COPY
>Referenced SOP Instance UID	0008,1155	UI		ANAPEV	COPY
Body Part Examined	0018,0015	CS		ANAP	COPY
Protocol Name	0018,1030	LO		ANAP	COPY
Series Instance UID	0020,000E	UI		ALWAYS	AUTO
Series Number	0020,0011	IS		VNAP	AUTO
Laterality	0020,0060	CS		VNAPCV	COPY
Performed Procedure Step Start Date	0040,0244	DA		ANAP	COPY
Performed Procedure Step Start Time	0040,0245	TM		ANAP	COPY
Performed Procedure Step ID	0040,0253	SH		ANAP	COPY
Performed Procedure Step Description	0040,0254	LO		ANAP	COPY
Performed Protocol Code Sequence	0040,0260	SQ	Include macro: Code Sequence Macro	ANAP	COPY
Request Attributes Sequence	0040,0275	SQ		ANAP	COPY
>Scheduled Procedure Step	0040,0007	LO		ANAP	COPY
>Scheduled Protocol Code Sequence	0040,0008	SQ	Include macro: Code Sequence Macro	ANAP	COPY
>Scheduled Procedure Step ID	0040,0009	SH		ANAPEV	COPY
>Requested Procedure ID	0040,1001	SH		ANAPEV	COPY
Comments on the Performed	0040,0280	ST		ANAP	COPY

Table 105: General Equipment Module

Attribute Name	Tag	VR	Value	Presence of Value	Source
Manufacturer	0008,0070	LO	Philips Medical Systems	VNAP	AUTO
Station Name	0008,1010	SH		ANAP	COPY
Manufacturer's Module Name	0008,1090	LO	Philips Orthopaedic Application	ANAP	AUTO
Software Versions	0018,1020	LO	Original value extended with: Philips Orthopaedic Application R 1.2V1L1 PMS1.1 MIMIT	ANAP	AUTO

EVIIMDictionary

Table 106: SC Equipment Module

Attribute Name	Tag	VR	Value	Presence of Value	Source
Modality	0008,0060	CS		ANAP	COPY
Conversion Type	0008,0064	CS	WSD	ALWAYS	AUTO

Table 107: General Image Module

Attribute Name	Tag	VR	Value	Presence of Value	Source
Image Type	0008,0008	CS	Derived, Secondary	ALWAYS	AUTO
Acquisition Date	0008,0022	DA		ANAP	COPY
Content Date	0008,0023	DA		VNAPCV	COPY
Acquisition Time	0008,0032	TM		ANAP	COPY
Content Time	0008,0033	TM		VNAPCV	COPY
Derivation Description	0008,2111	ST		ANAP	AUTO
Instance Number	0020,0013	IS	1	VNAP	AUTO
Patient Orientation	0020,0020	CS		VNAPCV	AUTO
Image Comments	0020,4000	LT		ANAP	COPY
Burned in Annotation	0028,0301	CS	Original value extended with: CAPTURE, and for Leg Osteotomy Application and Hip implant planning: CUTNPASTE_SIMULATION; CAPTURE	ANAP	AUTO

Table 108: Image Pixel Module

Attribute Name	Tag	VR	Value	Presence of Value	Source
Samples per Pixel	0028,0002	US	3	ALWAYS	AUTO
Photometric Interpretation	0028,0004	CS	RGB	ALWAYS	AUTO
Planar Configuration	0028,0006	US	0	ANAPEV	AUTO
Row	0028,0010	US		ALWAYS	AUTO
Columns	0028,0011	US		ALWAYS	AUTO
Pixel Aspect Ratio	0028,0034	IS		ANAPEV	COPY
Bits Allocated	0028,0100	US	8	ALWAYS	AUTO
Bits Stored	0028,0101	US	8	ALWAYS	AUTO
High Bit	0028,0102	US	7	ALWAYS	AUTO
Pixel Representation	0028,0103	US	0	ALWAYS	AUTO
Pixel Data	7FE0,0010	OW		ALWAYS	AUTO

Table 109: SC Image Module Module

Attribute Name	Tag	VR	Value	Presence of Value	Source
Date of Secondary Capture	0018,1012	DA		ANAP	AUTO
Time of Secondary Capture	0018,1014	TM		ANAP	AUTO

Table 110: SOP Common Module

Attribute Name	Tag	VR	Value	Presence of Value	Source
Specific Character SET	0008,0005	CS		ANAPEV	AUTO
SOP Class UID	0008,0016	UI	1.2.840.10008.5.1.4.1.1.7	ALWAYS	AUTO
SOP Instance UID	0008,0018	UI		ALWAYS	AUTO

Table 111: Code Sequence Macro

Attribute Name	Tag	VR	Value	Presence of Value	Source
Code Value	0008,0100	SH		ALWAYS	COPY
Coding Scheme Designator	0008,0102	SH		ALWAYS	COPY
Coding Scheme Version	0008,0103	SH		ANAPEV	COPY
Code Meaning	0008,0104	LO		ALWAYS	COPY
Mapping Resource	0008,0105	CS		ANAPEV	COPY
Context Group Version	0008,0106	DT		ANAPEV	COPY
Context Group Local Version	0008,0107	DT		ANAPEV	COPY
Context Group Extension Flag	0008,010B	CS		ANAP	COPY
Context Group Extension Creator UID	0008,010D	UI		ANAPEV	COPY
Context Identifier	0008,010F	CS		ANAP	COPY

(*) Have the same aspect ratio as on screen, preserving image resolution.
E.g. an image of (512 x 1024) in a viewer of (200 x 100) will result in an SC image of (2048 x 1024).

PIXEL SIZE CALIBRATION:

- X-ray (XA, RF) images however generally have no pixel size defined; as they are projection images, the pixel size for different anatomical details may be different (geometrical enlargement).
The user may decide to define the pixel size of X-ray images (though it has a very limited meaning). This makes it possible to obtain meaningful measurements.
- CR and DX usually do have defined pixel size. But as this is the plate pixel size, Philips Orthopaedic Applications offer the scaling functionality
- ViewForum R5.1 Images will be exported as SC images DICOM file, without Greyscale Softcopy Presentation State.
- The stored SC image will be stored as a RGB image and contain pixel data, as viewed on the screen (everything burnt in).
- Virtually be placed in a new series in the same examination as the original image.
- ViewForum R5.1 Attributes will be as described in Annexes.

9.1.2. Usage of Attributes from Received IOD's

The Philips Orthopaedic Application system supports the DICOM image SOP Classes as mentioned in the following table:

Table 112: Supported SOP Classes

SOP Class		Comments
Name	UID	
Media Storage Directory Storage	1.2.840.10008.1.3.10	For image selection
Computed Radiography Image Storage	1.2.840.10008.5.1.4.1.1.1	CR
Digital X-Ray Image Storage – for Presentation	1.2.840.10008.5.1.4.1.1.1.1	DX
Secondary Capture Image Storage	1.2.840.10008.5.1.4.1.1.7	SC
X-Ray Angiographic Image Storage	1.2.840.10008.5.1.4.1.1.12.1	XA
X-Ray Radiofluoroscopic Image Storage	1.2.840.10008.5.1.4.1.1.12.2	RF

The following table lists the Supported Media Storage Application Profiles (with roles).

Table 113: Media Services

Media Storage Application Profile	Write Files (FSC / FSU)	Read Files (FSR)	Supported Media
CD – R Disk			
General Purpose CD-R	NO / NO	YES	CD/DVD

9.1.2.1. Folder Contents

The work list is put together using the following attributes.

Table 114: Folder Contents

UI Field	DICOM Attribute		Comments
	Name	Tag	
Patient			
Patient Name	Patient's Name	(0010,0010)	For viewing.
Patient ID	Patient ID	(0010,0020)	For viewing.
Date of birth	Patient's Birth Date	(0010,0030)	For viewing.
Study			
Accession number	Accession Number	(0008,0050)	Per Series data object.
Series			
Series date	Series Date	(0008,0021)	-
Series time	Series Time	(0008,0031)	-
Modality	Modality	(0008,0060)	Defined values: CR, DX, OT, RF, XA
Series number	Series Number	(0020,0011)	-
Image			
Image date	Content Date	(0008,0023)	For viewing.
Image time	Content Time	(0008,0033)	For viewing.
Image number	Instance Number	(0020,0013)	-
Number of frames	Number of Frames	(0028,0008)	Per multi-frame image data object.
Presentation State Label	Content Label	(0070,0080)	Only for Presentation

UI Field	DICOM Attribute		Comments
	Name	Tag	
Patient			
Created by	Content Creator's Name	(0070,0084)	Only for Presentation
Creation date	Presentation Creation Date	(0070,0082)	Only for Presentation
Creation time	Presentation Creation Time	(0070,0083)	Only for Presentation
Frame			
Frame number	Frame number	(2001,107C)	-

9.1.2.2. Supported SOP Classes

9.1.2.2.1. Leg Osteotomy planning

The Leg Osteotomy application supports the following SOP classes.

Table 115: Supported SOP Classes

SOP Class		Comments
Name	UID	
Computed Radiography Image Storage	1.2.840.10008.5.1.4.1.1.1	CR
Digital X-Ray Image Storage – for Presentation	1.2.840.10008.5.1.4.1.1.1.1	DX
X-Ray Radiofluoroscopic Image Storage	1.2.840.10008.5.1.4.1.1.12.2	RF

Note that only single frame images are supported. Multi-frame images will be omitted.

The following sections list the attributes that are used explicitly (i.e. apart from DICOM mandatory attributes).

9.1.2.2.2. Lower extremity measurements

The Lower extremity measurements application supports the following SOP classes.

Table 116: Supported SOP Classes

SOP Class		Comments
Name	UID	
Computed Radiography Image Storage	1.2.840.10008.5.1.4.1.1.1	CR
Digital X-Ray Image Storage – for Presentation	1.2.840.10008.5.1.4.1.1.1.1	DX
X-Ray Radiofluoroscopic Image Storage	1.2.840.10008.5.1.4.1.1.12.2	RF
X-Ray Angiographic Image Storage	1.2.840.10008.5.1.4.1.1.12.1	XA

Note that only single frame images are supported. Multi-frame images will be omitted. The following sections list the attributes that are used explicitly (i.e. apart from the DICOM mandatory attributes).

9.1.2.2.3. Hip Implant planning

The Hip implant planning application supports the following SOP classes.

Table 117: Supported SOP Classes

SOP Class		Comments
Name	UID	
Computed Radiography Image Storage	1.2.840.10008.5.1.4.1.1.1	CR
Digital X-Ray Image Storage – for Presentation	1.2.840.10008.5.1.4.1.1.1.1	DX
X-Ray Radiofluoroscopic Image Storage	1.2.840.10008.5.1.4.1.1.12.2	RF
X-Ray Angiographic Image Storage	1.2.840.10008.5.1.4.1.1.12.1	XA

Note that only single frame images are supported. Multi-frame images will be omitted. The following sections list the attributes that are used explicitly (i.e. apart from the DICOM mandatory attributes).

9.1.2.2.4. Viewing

The viewing application has supported by the ViewForum R5.1.

9.1.2.3. Information per SOP Class**9.1.2.3.1. Computed Radiography Image**

The following table lists the input requirements for a Computed Radiography image.

Table 118: Computed Radiography Image

DICOM Attribute		Comments
Name	Tag	
Patient module		
Patient's Name	(0010,0010)	Info for viewing and report
Patient ID	(0010,0020)	Info for viewing and report
Patient's Birth Date	(0010,0030)	Info for viewing and report
Patient's Sex	(0010,0040)	Info for report
General Study module		
Referring Physician's Name	(0008,0090)	Info for report
Study Date	(0008,1020)	Info for report
Study Description	(0008,1030)	Info for report
Image Pixel module		
Pixel Spacing	(0028,0030)	Additional calibration data - info for viewing
Pixel Data	(7FE0,0010)	Info for viewing
SOP Common module		
SOP Class UID	(0008,0016)	Required. Enumerated value: 1.2.840.10008.5.1.4.1.1.1

9.1.2.3.2. Digital X-Ray Image

The following table lists the input requirements for a Digital X-Ray image.

Table 119: Digital X-Ray Image

DICOM Attribute		Comments
Name	Tag	
Patient module		
Patient's Name	(0010,0010)	Info for viewing and report
Patient ID	(0010,0020)	Info for viewing and report
Patient's Birth Date	(0010,0030)	Info for viewing and report
Patient's Sex	(0010,0040)	Info for report
General Study module		
Referring Physician's Name	(0008,0090)	Info for report
Study Date	(0008,1020)	Info for report
Study Description	(0008,1030)	Info for report
Image Pixel module		
Pixel Spacing	(0028,0030)	Additional calibration data - info for viewing
Pixel Data	(7FE0,0010)	Info for viewing
SOP Common module		
SOP Class UID	(0008,0016)	Required. Enumerated value: 1.2.840.10008.5.1.4.1.1.1.1

9.1.2.3.3. X-Ray Radiofluoroscopic image

The following table lists the input requirements for an X-Ray Radiofluoroscopic image. Multi frame (with more than 1 frame) images are only accepted for viewing. Single frame and 1-frame Multi frame images can be viewed and reported.

Table 120: X-Ray Radiofluoroscopic Image

DICOM Attribute		Comments
Name	Tag	
Patient module		
Patient's Name	(0010,0010)	Info for viewing and report
Patient ID	(0010,0020)	Info for viewing and report
Patient's Birth Date	(0010,0030)	Info for viewing and report
Patient's Sex	(0010,0040)	Info for report
General Study module		
Referring Physician's Name	(0008,0090)	Info for report
Study Date	(0008,1020)	Info for report
Study Description	(0008,1030)	Info for report
Image Pixel module		
Pixel Spacing	(0028,0030)	Additional calibration data - info for viewing
Pixel Data	(7FE0,0010)	Info for viewing
SOP Common module		
SOP Class UID	(0008,0016)	Required. Enumerated values: 1.2.840.10008.5.1.4.1.1.12.2
Multi- Frame Module		
Number of Frames	(0028,0008)	Optional: 1

9.1.2.3.4. X-Ray Angiographic Image

The following table lists the input requirements for an X-Ray Angiographic image. Multi frame (with more than 1 frame) images are only accepted for viewing. Multi frame with 1 frame, Single frame can be viewed and reported.

Table 121: X-Ray Angiographic Image

DICOM Attribute		Comments
Name	Tag	
Patient module		
Patient's Name	(0010,0010)	Info for viewing and report
Patient ID	(0010,0020)	Info for viewing and report
Patient's Birth Date	(0010,0030)	Info for viewing and report
Patient's Sex	(0010,0040)	Info for report
General Study module		
Referring Physician's Name	(0008,0090)	Info for report
Study Date	(0008,1020)	Info for report
Study Description	(0008,1030)	Info for report
Image Pixel module		
Pixel Spacing	(0028,0030)	Additional calibration data - info for viewing
Pixel Data	(7FE0,0010)	Info for viewing
SOP Common module		
SOP Class UID	(0008,0016)	Required. Enumerated values: 1.2.840.10008.5.1.4.1.1.12.1

9.1.3. Attribute Mapping

Not applicable.

9.1.4. Coerced/Modified fields

When creating a Secondary Capture, the attribute Software Version(s) (0018,1020) is coerced by the original value added with "Philips Orthopaedic Applications R1.2V1L1", "PMS1.1 MIMIT EVIIMDictionary", and the attribute Derivation Description (0008,2111) is coerced by changing the original value and extend it with "CAPTURE".

In case of creating a simulation image in the Leg Osteotomy Application and Hip implant planning, the attribute Derivation Description (0008,2111) is coerced by extending the original value with "CUTNPASTE_SIMULATION".

9.2. Data Dictionary of Private Attributes

Not applicable.

9.3. Coded Terminology and Templates

Not applicable.

9.4. Grayscale Image consistency

Not applicable.

9.5. Standard Extended/Specialized/Private SOPs

Not applicable.

9.6. Private Transfer Syntaxes

Not applicable.