

DICOM Conformance Statement

Incisive CT – Console v5.0



Issued by:

Philips Medical Systems Nederland BV, a Philips Healthcare company,

P.O. Box 10.000
5680 DA Best
The Netherlands

Internet: <https://www.philips.com/healthcare/about/customer-support>

Doc Id: HSDP-678997

Date: 18-Feb-2021

1. DICOM Conformance Statement Overview

This conformance statement refers to the Incisive CT, Philips' CT user environment for scanning a visualization. All Incisive CT workspace users enjoy the same easy to use interface and access to advanced CT applications. Incisive is a family of CT scanners. The System is used as a diagnostic human patient imaging device that produces, and provides tools to view images of internal patient anatomy that correspond to tissue density of both normal and abnormal anatomic structures.

The system is verified as DIN 6862-2 compliant.

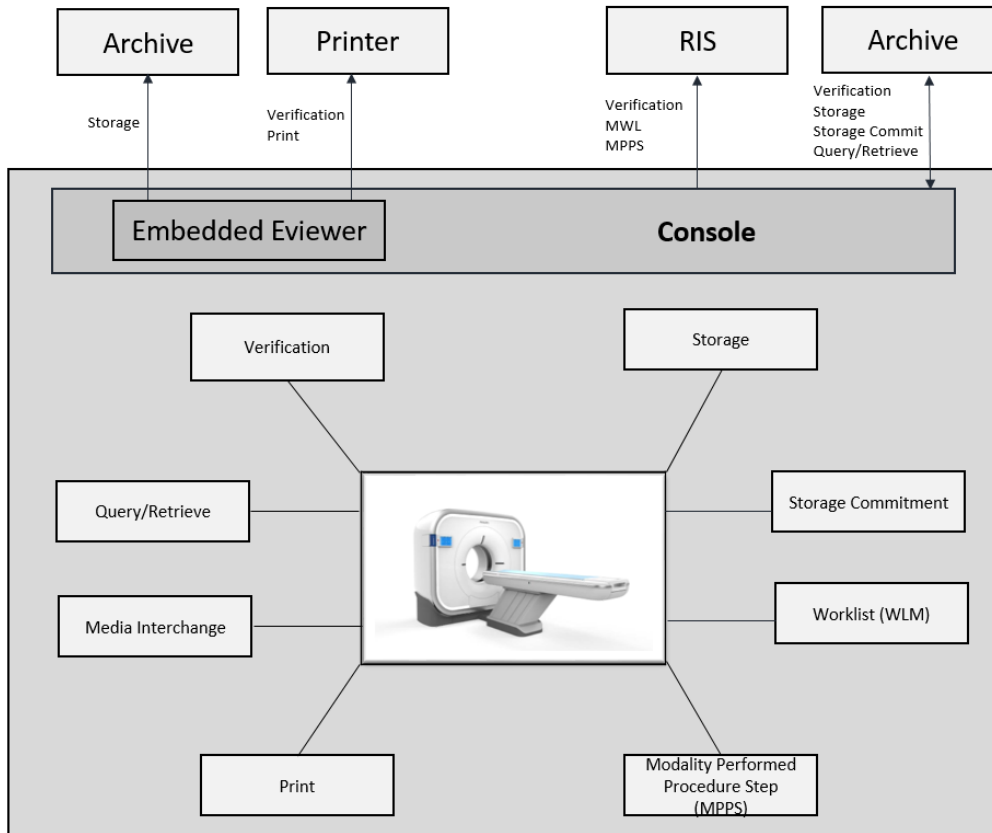

Figure 1: Console in a DICOM network

A table of supported Network DICOM Service (SOP) Classes is provided with roles (User/Provider)

Table 1: Network Services

SOP Class		User of Service (SCU)	Provider of Service (SCP)
Name	UID		
Other			
Verification SOP Class	1.2.840.10008.1.1	Yes	Yes
Print Management			
Basic Color Print Management Meta SOP Class	1.2.840.10008.5.1.1.18	Yes	No
>Basic Color Image Box SOP Class	1.2.840.10008.5.1.1.4.1	Yes	No
>Basic Film Box SOP Class	1.2.840.10008.5.1.1.2	Yes	No

SOP Class		User of Service (SCU)	Provider of Service (SCP)
Name	UID		
>Basic Film Session SOP Class	1.2.840.10008.5.1.1.1	Yes	No
>Printer SOP Class	1.2.840.10008.5.1.1.16	Yes	No
Basic Grayscale Print Management Meta SOP Class	1.2.840.10008.5.1.1.9	Yes	No
>Basic Film Box SOP Class	1.2.840.10008.5.1.1.2	Yes	No
>Basic Film Session SOP Class	1.2.840.10008.5.1.1.1	Yes	No
>Basic Grayscale Image Box SOP Class	1.2.840.10008.5.1.1.4	Yes	No
>Printer SOP Class	1.2.840.10008.5.1.1.16	Yes	No
Query/Retrieve			
Study Root QR Information Model – FIND SOP Class	1.2.840.10008.5.1.4.1.2.2.1	Yes	Yes
Study Root QR Information Model – MOVE SOP Class	1.2.840.10008.5.1.4.1.2.2.2	Yes	Yes
Transfer			
CT Image Storage SOP Class	1.2.840.10008.5.1.4.1.1.2	Yes	Yes
Secondary Capture Image Storage SOP Class	1.2.840.10008.5.1.4.1.1.7	Yes	Yes
X-Ray Radiation Dose SR	1.2.840.10008.5.1.4.1.1.88.67	Yes	Yes
General ECG Waveform Storage SOP Class	1.2.840.10008.5.1.4.1.1.9.1.2	Yes	Yes
Workflow Management			
Modality Performed Procedure Step SOP Class	1.2.840.10008.3.1.2.3.3	Yes	No
Modality Worklist Information Model – FIND SOP Class	1.2.840.10008.5.1.4.31	Yes	No
Storage Commitment Push Model SOP Class	1.2.840.10008.1.20.1	Yes	No

For media the Console Incisive CT system supports:

- FSC service for CD-R, CD-RW, DVD + R, DVD – R, DVD + RW, DVD – RW media
- FSR service for CD-R, CD-RW, DVD + R, DVD – R, DVD + RW, DVD – RW media

All the Media Services supported by Console Incisive CT are shown in the next table.

Table 2: Media Services

Media Storage Application Profile	File-set Creator (FSC)	File-set Updater (FSU)	File-set Reader (FSR)	Display Directory (DD)
Compact Disk-Recordable				
General Purpose CD-R Interchange	Yes	No	Yes	No

2. Table of Contents

1.	DICOM CONFORMANCE STATEMENT OVERVIEW	3
2.	TABLE OF CONTENTS	5
3.	INTRODUCTION	7
3.1.	REVISION HISTORY	7
3.2.	AUDIENCE	7
3.3.	REMARKS	7
3.4.	DEFINITIONS, TERMS AND ABBREVIATIONS.....	8
3.5.	REFERENCES.....	8
4.	NETWORKING	9
4.1.	IMPLEMENTATION MODEL	9
4.1.1.	Application Data Flow.....	9
4.1.2.	Functional Definition of AE's	10
4.1.3.	Sequencing of Real World Activities	11
4.2.	AE SPECIFICATIONS	12
4.2.1.	Console AE	12
4.2.1.1.	SOP Classes	12
4.2.1.2.	Association Policies.....	13
4.2.1.2.1.	General.....	13
4.2.1.2.2.	Number of Associations.....	13
4.2.1.2.3.	Asynchronous Nature	13
4.2.1.2.4.	Implementation Identifying Information.....	14
4.2.1.2.5.	Communication Failure Handling.....	14
4.2.1.3.	Association Initiation Policy	14
4.2.1.3.1.	(Real-World) Activity – Verification as SCU.....	16
4.2.1.3.2.	(Real-World) Activity – Modality worklist As SCU	17
4.2.1.3.3.	(Real-World) Activity – Modality Performed Procedure Step As SCU.....	20
4.2.1.3.4.	(Real-World) Activity – FIND as SCU	23
4.2.1.3.5.	(Real-World) Activity – MOVE as SCU	25
4.2.1.3.6.	(Real-World) Activity – Image Export.....	27
4.2.1.3.7.	(Real-World) Activity – Storage Commitment Push Model AS SCU	29
4.2.1.3.8.	(Real-World) Activity - Print Management as SCU	31
4.2.1.4.	Association Acceptance Policy	40
4.2.1.4.1.	(Real-World) Activity – Verification as SCP	40
4.2.1.4.2.	(Real-World) Activity – Image Import.....	42
4.2.1.4.3.	(Real-World) Activity – FIND as SCP.....	43
4.2.1.4.4.	(Real-World) Activity – MOVE as SCP	45
4.3.	NETWORK INTERFACES.....	46
4.3.1.	Physical Network Interfaces	46
4.3.2.	Additional Protocols	46
4.4.	CONFIGURATION.....	46
4.4.1.	AE Title/Presentation Address Mapping.....	46
4.4.1.1.	Local AE Titles.....	46
4.4.1.2.	Remote AE Title/Presentation Address Mapping.....	46
4.4.2.	Parameters.....	47
5.	MEDIA INTERCHANGE	49
5.1.	IMPLEMENTATION MODEL	49
5.1.1.	Application Data Flow Diagram	49
5.1.2.	Functional Definitions of AE's.....	49
5.1.3.	Sequencing of Real World Activities	49
5.2.	AE SPECIFICATIONS	50
5.2.1.	Media Console Media - Specification	50
5.2.1.1.	File Meta Information for the media Console	50

5.2.1.2.	Real-World Activities.....	50
5.2.1.2.1.	RWA - Read File-set.....	50
5.2.1.2.2.	RWA - Create File-set.....	50
5.2.1.2.3.	RWA - Update File-set.....	51
5.3.	AUGMENTED AND PRIVATE APPLICATION PROFILES.....	51
5.4.	MEDIA CONFIGURATION	51
6.	SUPPORT OF CHARACTER SETS.....	52
7.	SECURITY.....	53
7.1.	SECURITY PROFILES	53
7.1.1.	Security use Profiles	53
7.1.2.	Security Transport Connection Profiles	53
7.1.3.	Digital Signature Profiles	53
7.1.4.	Media Storage Security Profiles	53
7.1.5.	Attribute Confidentiality Profiles	53
7.1.6.	Network Address Management Profiles	55
7.1.7.	Time Synchronization Profiles	55
7.1.8.	Application Configuration Management Profiles.....	55
7.1.9.	Audit Trail Profiles	55
7.2.	ASSOCIATION LEVEL SECURITY.....	55
7.3.	APPLICATION LEVEL SECURITY	55
8.	CONSOLE	56
8.1.	IOD CONTENTS	56
8.1.1.	Created SOP Instance	56
8.1.1.1.	List of created SOP Classes	56
8.1.1.2.	CT Image Storage SOP Class.....	56
8.1.1.3.	Secondary Capture Image Storage SOP Class.....	61
8.1.1.4.	X-Ray Radiation Dose Report Storage SOP Class.....	64
8.1.1.5.	General ECG Waveform Storage SOP Class	67
8.1.2.	Usage of Attributes from Received IOD	69
8.1.2.1.	Usage of the Functionality Viewer	69
8.1.3.	Attribute Mapping	70
8.1.4.	Coerced/Modified fields.....	70
8.2.	DATA DICTIONARY OF PRIVATE ATTRIBUTES.....	71
8.3.	CODED TERMINOLOGY AND TEMPLATES	71
8.3.1.	Context Groups	71
8.3.2.	Template Specifications	71
8.3.2.1.	TID 10011 CT Radiation Dose.....	71
8.3.2.2.	TID 10012 CT Accumulated Dose Data.....	72
8.3.2.3.	TID 10013 CT Irradiation Event Data.....	72
8.3.2.4.	TID 10014 Scanning Length	73
8.3.2.5.	TID 10015 CT Dose Check Details.....	73
8.3.2.6.	TID 1002 Observer Context.....	74
8.3.2.7.	TID 1004 Device Observer Identifying Attributes	74
8.3.3.	Private code definitions	74
8.4.	GRAYSCALE IMAGE CONSISTENCY	74
8.5.	STANDARD EXTENDED/SPECIALIZED/PRIVATE SOPS.....	74
8.6.	PRIVATE TRANSFER SYNTAXES	74

3. Introduction

3.1. Revision History

The revision history provides dates and differences of the different releases.

Table 3: Revision History

Document Version	Date of Issue	Description of change
01	18-Feb-2021	Initial version for Incisive CT – Console v5.0

3.2. Audience

This Conformance Statement is intended for:

- (Potential) customers
- System integrators of medical equipment
- Marketing staff interested in system functionality
- Software designers implementing DICOM interfaces

It is assumed that the reader is familiar with the DICOM standard.

3.3. Remarks

The DICOM Conformance Statement is contained in chapter 4 through 8 and follows the contents and structuring requirements of DICOM PS 3.2.

This DICOM Conformance Statement by itself does not guarantee successful interoperability of Philips equipment with non-Philips equipment. The user (or user's agent) should be aware of the following issues:

- **Interoperability**
Interoperability refers to the ability of application functions, distributed over two or more systems, to work successfully together. The integration of medical devices into an IT environment may require application functions that are not specified within the scope of DICOM. Consequently, using only the information provided by this Conformance Statement does not guarantee interoperability of Philips equipment with non-Philips equipment.
It is the user's responsibility to analyze thoroughly the application requirements and to specify a solution that integrates Philips equipment with non-Philips equipment.
- **Validation**
Philips equipment has been carefully tested to ensure that the actual implementation of the DICOM interface corresponds with this Conformance Statement.
Where Philips equipment is linked to non-Philips equipment, the first step is to compare the relevant Conformance Statements. If the Conformance Statements indicate that successful information exchange should be possible, additional validation tests will be necessary to ensure the functionality, performance, accuracy and stability of image and image related data. It is the responsibility of the user (or user's agent) to specify the appropriate test suite and to carry out the additional validation tests.
- **New versions of the DICOM Standard**
The DICOM Standard will evolve in future to meet the user's growing requirements and to incorporate new features and technologies. Philips is actively involved in this evolution and plans to adapt its equipment to future versions of the DICOM Standard. In order to do so, Philips reserves the right to make changes to its products or to discontinue its delivery. The user should ensure that any non-Philips provider linking to Philips equipment also adapts to future versions of the DICOM Standard. If not, the incorporation of DICOM enhancements into Philips equipment may lead to loss of connectivity (in case of networking) and incompatibility (in case of media).

3.4. Definitions, Terms and Abbreviations

Table 4: Definitions, Terms and Abbreviations

Abbreviation/Term	Explanation
AE	Application Entity
CD	Compact Disc
CD-R	CD-Recordable
CT	Computed Tomography
DCS	DICOM Conformance Statement
DICOM	Digital Imaging and Communications in Medicine
DIMSE	DICOM Message Service Element
DVD	A trademark of the DVD Forum that is not an abbreviation
DVD-RW	DVD Rewritable
EBE	DICOM Explicit VR Big Endian
ELE	DICOM Explicit VR Little Endian
FSC	File-set Creator
FSR	File-set Reader
FSU	File-set Updater
HIS	Hospital Information System
ILE	DICOM Implicit VR Little Endian
IMS	Image Station
IOD	Information Object Definition
MPPS	Modality Performed Procedure Step
MWL	Modality Worklist
NEMA	National Electrical Manufacturers Association
PDU	Protocol Data Unit
RIS	Radiology Information System
RWA	Real-World Activity
SC	Secondary Capture
SCP	Service Class Provider
SCU	Service Class User
SOP	Service Object Pair
TCP/IP	Transmission Control Protocol/Internet Protocol
UID	Unique Identifier
USB	Universal Serial Bus
WLM	Worklist Management
WS	Workstation

3.5. References

[DICOM] Digital Imaging and Communications in Medicine, Parts 1 - 22 (NEMA PS 3.1- PS 3.22),
 National Electrical Manufacturers Association
 1300 North 17th Street Suite 900
 Arlington, Virginia 22209
 Internet: <https://www.dicomstandard.org/current>

4. Networking

This section contains the networking related services.

4.1. Implementation model

The implementation model consists of three sections:

- The application data flow diagram, specifying the relationship between the Application Entities and the "external world" or Real-World Activities,
- A functional description of each Application Entity, and
- The sequencing constraints among them.

4.1.1. Application Data Flow

The Console with embedded Eviewer Incisive CT scanner system consists of a single Application Entity (Console Network AE).

Figure 2 shows the Networking application data flow as a functional overview of the Console Network AE.

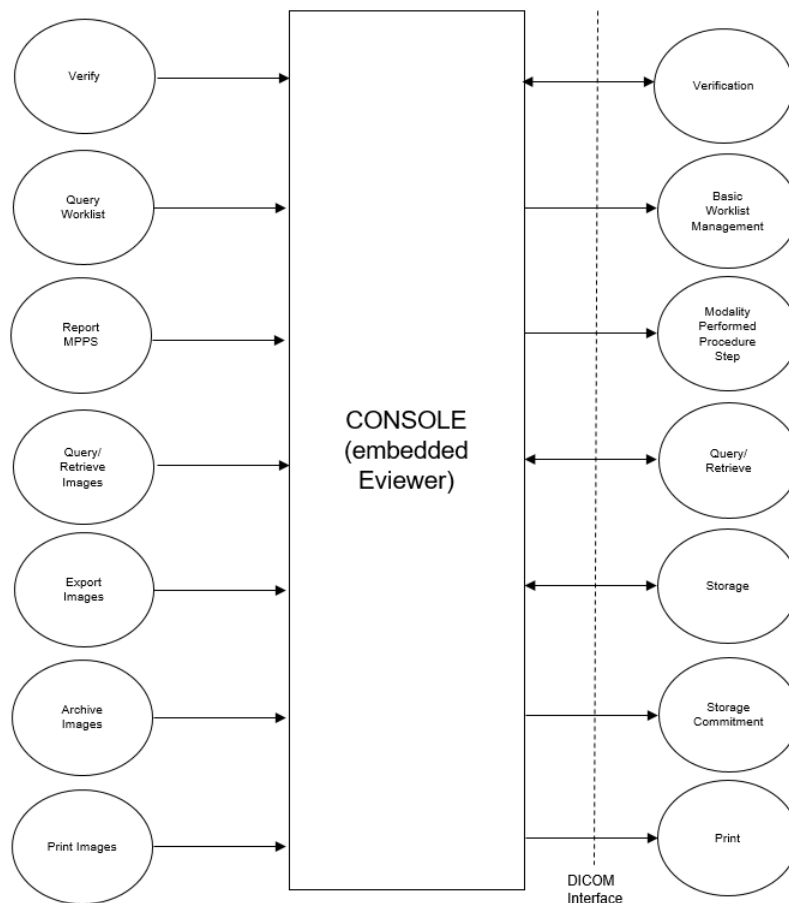

Figure 2: Data flow diagram Incisive CT - Console.

Console (with embedded Eviewer) incorporates the following functionality:

- DICOM Verification service (for both SCU and SCP).
- Storage of DICOM objects on a remote DICOM system.
- Commitment of stored DICOM objects on a remote DICOM system (Push Model).
- Querying for data on a remote DICOM system.
- Retrieval of DICOM objects from a remote DICOM system.
- Basic Worklist Management (BWLM).
- Implementation of Modality Performed Procedure Step (MPPS).

- Storage and Retrieval of DICOM objects per removable media.
- Printing of hardcopies on a remote DICOM printer.
- Query for data by a remote DICOM system.

4.1.2. Functional Definition of AE's

The Console Network AE is the one and only application entity within the Console with embedded Eviewer Incisive CT scanner. It includes the following service classes.

Verification Service Class

The Console Network AE provides the Verification service as SCU and SCP

A remote SCU shall request an association with the Console Network AE for Verification SOP class. After accepting the association the Console Network AE shall receive and respond to the Verification request and release the association when requested.

The Console Network AE can request an association to a remote node for Verification SOP class. After receiving the response for the Verification request from the remote SCP system, it releases the association.

Basic Worklist Management Service Class

The Console Network AE uses the Basic Worklist Management service as SCU.

After initiating a worklist query the Console Network AE requests an association with the configured remote Basic Worklist Management SCP. After accepting the association the Console Network AE shall send the find request, wait for response, and then release the association.

The system shall be updated with the query results.

Modality Performed Procedure Step Service Class

The Console Network AE as SCU uses the Modality Performed Procedure Step service class to report the status of a procedure step to the configured MPPS manager.

As soon as a study is selected on the scanner and the first acquisition is made, a MPPS N-CREATE message is sent with the status IN PROGRESS to the MPPS manager.

After a worklist is finished on the Console network AE scanner (indicated by finishing the study), a new association is opened with the MPPS manager and an N-SET message is sent with the status COMPLETED.

Storage Service Class

Export Images

The Console Network AE use the Storage SCU service to send the created images to a remote system.

The Console system can be configured to send a Storage Commitment messages for archive commitment.

Acquired images will always be exported with "CT image SOP Class".

Annotations and other presentation changes made by the viewer will always be send as "Secondary Capture" images.

The presentation information will be burned into the image.

Dose information is stored in a "Secondary Capture SOP class" object and in an X-RAY Dose report after the END STUDY button is pressed. Dose information is included in the study when exported to a remote system.

It is possible to enable on the Console network AE scanner auto store. With this setting, acquired images are automatically exported during acquisition. These images are exported with "CT Image SOP Class".

Import Images

The Console Network AE as Storage SCP supports the storage of images and related objects from a remote archive using the relevant storage SOP classes.

The import of images is also triggered when Console Network AE sends a request to a remote system to retrieve a remote study to its local database.

Query/Retrieve Service Class

The Console (SCU) initiates an association to find Examinations on a remote system (e.g. PACS).

Via the retrieve operation a request will be sent to a remote system to retrieve an examination into the Console local database.

The Console (SCP) accepts an association from a remote system to receive a Query/Retrieve request .Via the retrieve operation a request will be sent to Console to retrieve an examination into remote system.

Print Service Class

The Console Network AE gives the user the option to print Color and Grayscale Images.

4.1.3. Sequencing of Real World Activities

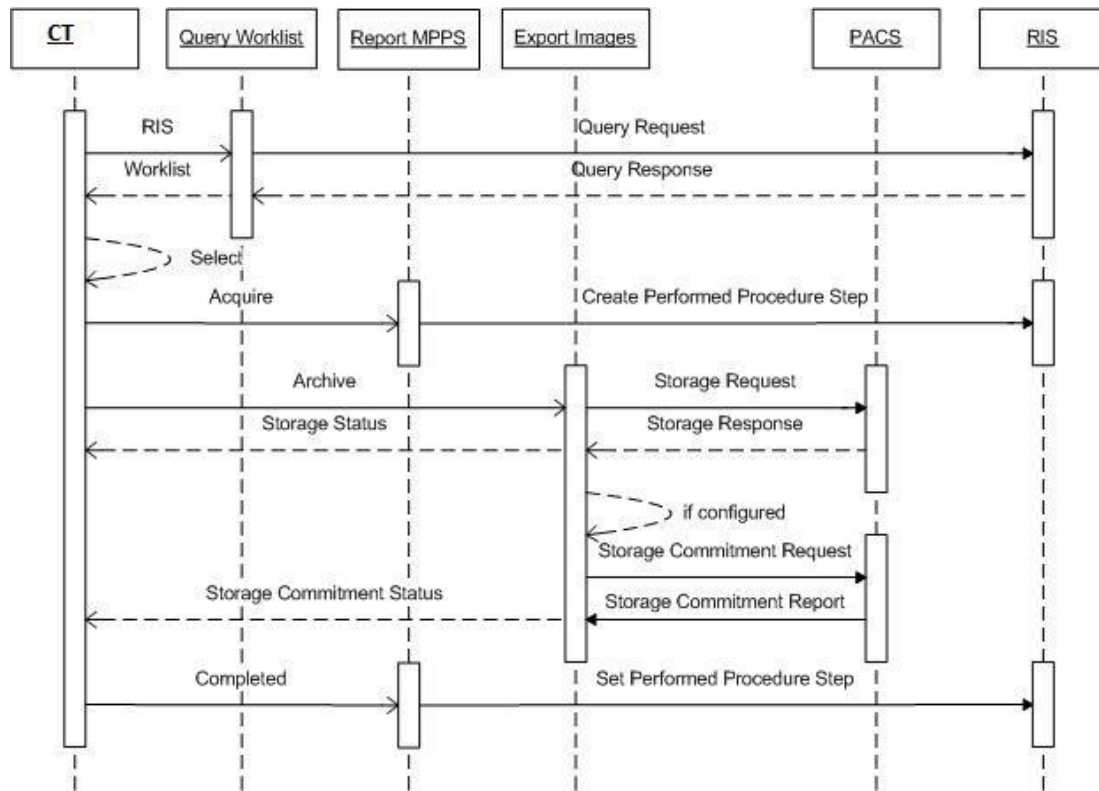

Figure 3: Sequence of real world activity Workflow

The Console with embedded Eviewer system workflow is initiated by clicking the worklist button in the schedule screen.

After receiving the worklist data from the RIS, the CT system will display the worklist on the user interface

Then one may select a relevant study from the list to start a scan.

At the start and at the end of the acquisition the configured MPPS system (RIS) is informed about the progress of the selected procedure step.

At the end of the exam, a completed or discontinue is sent with MPPS.

The created images are converted into a DICOM object that can be sent to a remote system, or can be written on a DVD or local disk.

After storage in a remote archive the Console with embedded Eviewer system will request a storage commitment (if configured).

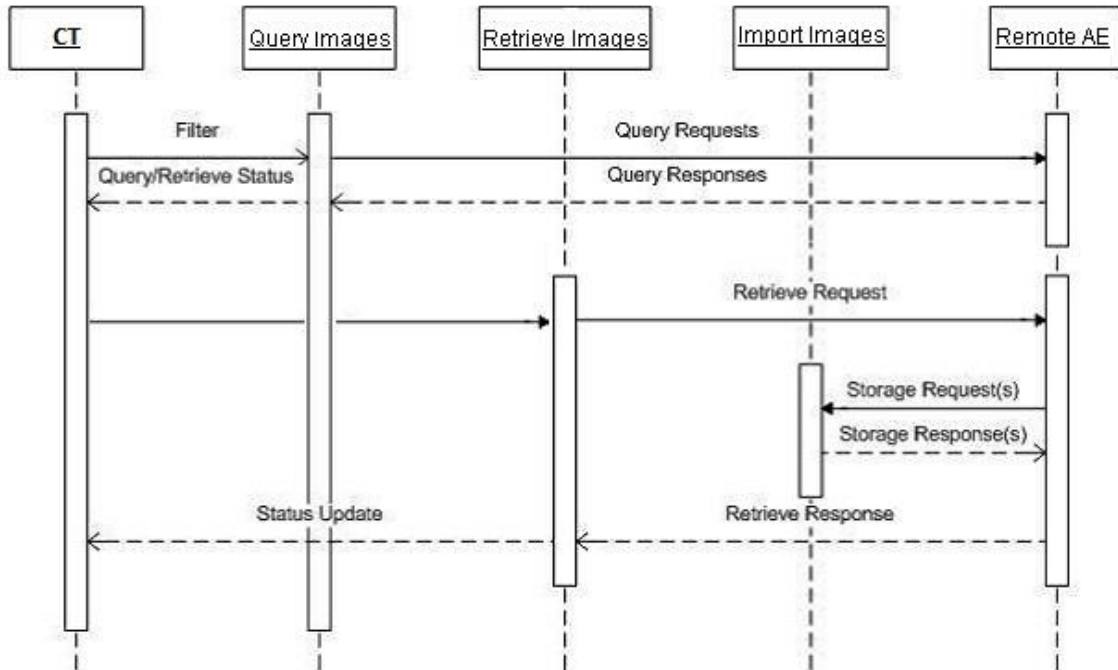

Figure 4: Sequence of real world activity Query/Retrieve

The Console (embedded Eviewer) CT sends initial query requests to the remote AE to find all Examinations matching the specified filter. After selecting the Examinations to be retrieved, the move selection to local database is initiated. This is followed by retrieve requests to the remote AE to move all required Series of Images. Then for each retrieve request the remote AE will store the related Images on the Console (embedded Eviewer) CT System. Query/Retrieve as SCP is supported by the Console with embedded Eviewer system.

4.2. AE Specifications

This section in the DICOM Conformance Statement is a set of Application Entity specifications. There are as many of these subsections as there are different AE's in the implementation.

4.2.1. Console AE

Details of this specific Application Entity is specified in this section.

4.2.1.1. SOP Classes

The Console network AE provides Standard Conformance to the following SOP Classes.

Table 5: SOP Classes for Hardcopy AE

SOP Class Name	SOP Class UID	SCU	SCP
Verification SOP Class	1.2.840.10008.1.1	Yes	Yes
Storage Commitment Push Model SOP Class	1.2.840.10008.1.20.1	Yes	No
Modality Performed Procedure Step SOP Class	1.2.840.10008.3.1.2.3.3	Yes	No
Basic Color Print Management Meta SOP Class	1.2.840.10008.5.1.1.18	Yes	No
>Basic Color Image Box SOP Class	1.2.840.10008.5.1.1.4.1	Yes	No
>Basic Film Box SOP Class	1.2.840.10008.5.1.1.2	Yes	No

SOP Class Name	SOP Class UID	SCU	SCP
>Basic Film Session SOP Class	1.2.840.10008.5.1.1.1	Yes	No
>Printer SOP Class	1.2.840.10008.5.1.1.16	Yes	No
Basic Grayscale Print Management Meta SOP Class	1.2.840.10008.5.1.1.9	Yes	No
>Basic Film Session SOP Class	1.2.840.10008.5.1.1.1	Yes	No
>Basic Film Box SOP Class	1.2.840.10008.5.1.1.2	Yes	No
>Basic Grayscale Image Box SOP Class	1.2.840.10008.5.1.1.4	Yes	No
>Printer SOP Class	1.2.840.10008.5.1.1.16	Yes	No
CT Image Storage SOP Class	1.2.840.10008.5.1.4.1.1.2	Yes	Yes
Secondary Capture Image Storage SOP Class	1.2.840.10008.5.1.4.1.1.7	Yes	Yes
X-Ray Radiation Dose SR	1.2.840.10008.5.1.4.1.1.88.67	Yes	Yes
General Electrocardiogram	1.2.840.10008.5.1.4.1.1.9.1.2	Yes	Yes
Study Root QR Information Model - FIND SOP Class	1.2.840.10008.5.1.4.1.2.2.1	Yes	Yes
Study Root QR Information Model - MOVE SOP Class	1.2.840.10008.5.1.4.1.2.2.2	Yes	Yes
Modality Worklist Information Model - FIND SOP Class	1.2.840.10008.5.1.4.31	Yes	No

Note: Any SOP specific behavior is documented later in the conformance statement in the applicable SOP specific conformance section.

4.2.1.2. Association Policies

Each AE specification contains a description of the general association establishment and acceptance policies of the AE.

4.2.1.2.1. General

The DICOM standard application context is specified below.

Table 6: DICOM Application Context

Description	Value
Application Context Name	1.2.840.10008.3.1.1.1

4.2.1.2.2. Number of Associations

The number of simultaneous associations that an Application Entity may support as an Initiator or Acceptor is specified here.

Table 7: Number of associations as an Association Initiator for this AE

Description	Value
Maximum number of simultaneous associations	Not configurable (limited on resource availability)

Table 8: Number of associations as an Association Acceptor for this AE

Description	Value
Maximum number of simultaneous associations	Not configurable (limited on resource availability)

4.2.1.2.3. Asynchronous Nature

The Console Network AE as supports asynchronous operations only for Storage Commitment, and does not negotiate other asynchronous operation windows. When a synchronous Storage Commitment times out, it automatically becomes an asynchronous Storage Commitment.

Table 9: Asynchronous nature as an Association Initiator for this AE

Description	Value
Maximum number of outstanding asynchronous transactions	None

4.2.1.2.4. Implementation Identifying Information

The value supplied for Implementation Class UID and version name are documented here.

Table 10: DICOM Implementation Class and Version for Hardcopy AE

Implementation Class UID	1.3.46.670589.61.1
Implementation Version Name	CHESS5_0

4.2.1.2.5. Communication Failure Handling

The behavior of the AE during communication failure is summarized in the next table.

Table 11: Communication Failure Behavior

Exception	Behavior
Timeout	The Association is aborted using A-ABORT and the command is marked as failed.
Association Aborted	The Association is aborted using A-ABORT and the command is marked as failed.
DIMSE Time out	The Association is aborted using A-ABORT and the command is marked as failed.

4.2.1.3. Association Initiation Policy

The Console Network AE initiates associations as a result of the following events:

- The operator selects local images and uses the “copy to” function to send the selected images to a remote destination.
- Storage commitment is requested to the archive for exported images to the archive
 - Application is configured for “auto store” so that acquired images are automatically transferred to a remote destination during acquisition.
- A retrieve request is received from a remote system to export images to a remote destination.
- The operator queries a database on a remote system
- Operator initiates a request for a worklist query to the RIS
- Application reports examination status via MPPS to the RIS at the start and end of an examination.
- Operator requests to print selected images.

The Application Entity responds to an Association reject as shown in the table below.

Table 12: Association Reject Response

Result	Source	Reason/Diagnosis	Behavior
1 - rejected permanent	1 - DICOM UL service-user	1 - no-reason-given	Connection closed. "Failed to connect to remote Device: Association request has been rejected" popup message is displayed in UI.
		2 - application-context-name-not supported	
		3 - calling-AE-title-not-recognized	
7 - called-AE-title-not-recognized			
		1 - no-reason-given	

Result	Source	Reason/Diagnosis	Behavior
	2 - DICOM UL service provider (ACSE related function)	2 - protocol-version-not-supported	Connection closed. "Failed to connect to remote Device: Association request has been rejected" popup message is displayed in UI.
	3 - DICOM UL service provider (Presentation related function)	1 - temporary-congestion 2 - local-limit-exceeded	Connection closed. "Failed to connect to remote Device: Association request has been rejected" popup message is displayed in UI.
2 - rejected-transient	1 - DICOM UL service-user	1 - no-reason-given	Connection closed. "Failed to connect to remote Device: Association request has been rejected" popup message is displayed in UI.
		2 - application-context-name-not-supported	
		3 - calling-AE-title-not-recognized	
	7 - called-AE-title-not-recognized		
2 - DICOM UL service provider (ACSE related function)	2 - DICOM UL service provider (Presentation related function)	1 - no-reason-given	Connection closed. "Failed to connect to remote Device: Association request has been rejected" popup message is displayed in UI.
		2 - protocol-version-not-supported	
	3 - DICOM UL service provider (Presentation related function)	1 - temporary-congestion	

The behavior of the AE for sending an Association abort is summarized in next table.

Table 13: Association Abort Policies

Source	Reason/Diagnosis	Behavior
0 - DICOM UL service-user (initiated abort)	0 - reason-not-specified	When received, the Console Network AE terminates the connection and logs the event.
2 - DICOM UL service-provider (initiated abort)	0 - reason-not-specified	When received, the Console Network AE terminates the connection and logs the event.
	1 - unrecognized-PDU	When received, the Console Network AE terminates the connection and logs the event.
	2 - unexpected-PDU	When received, the Console Network AE terminates the connection and logs the event.
	4 - unrecognized-PDU parameter	When received, the Console Network AE terminates the connection and logs the event.
	5 - unexpected-PDU parameter	When received, the Console Network AE terminates the connection and logs the event.
	6 - invalid-PDU-parameter value	When received, the Console Network AE terminates the connection and logs the event.

4.2.1.3.1. (Real-World) Activity – Verification as SCU

4.2.1.3.1.1. Description and Sequencing of Activities

The CT user can send a verification request to a remote system via the “Test” button in the system setting (configuration) tool.

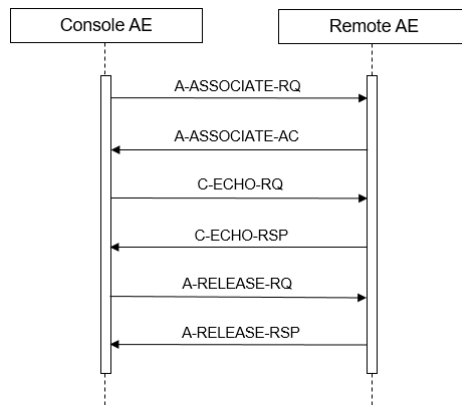

Figure 5: (Real World) Activity - Verification as SCU

The system sends a DICOM Association request message. After the Association accept is received a C-ECHO message is send.

4.2.1.3.1.2. Proposed Presentation Contexts

The presentation contexts are defined in the next table.

Table 14: Proposed Presentation Contexts for (Real-World) Activity – Verification As SCU

Presentation Context Table					
Abstract Syntax		Transfer Syntax		Role	Extended Negotiation
Name	UID	Name List	UID List		
Verification SOP Class	1.2.840.10008.1.1	Explicit VR Little Endian	1.2.840.10008.1.2.1	SCU	None
		Implicit VR Little Endian	1.2.840.10008.1.2		
		Explicit VR Big Endian	1.2.840.10008.1.2.2		

4.2.1.3.1.3. SOP Specific Conformance for Verification SOP Class

This section and sub-section include the manufacturer SOP and Dataset specific information as well the status codes and their corresponding behavior.

4.2.1.3.1.3.1. Dataset Specific Conformance for Verification C-ECHO

In the table below the possible response messages from the CT application are given as a result of the status in the received C-ECHO-RSP message.

Table 15: Status Response

Service Status	Error Code	Further Meaning	Behavior
Success	0000	Communication with remote system is successful	Popup message "Connection Succeeded" appears.
Failure	<xxxx>	Failed communication	Popup message "Connection Failed" appears.

4.2.1.3.2. (Real-World) Activity – Modality worklist As SCU

4.2.1.3.2.1. Description and Sequencing of Activities

The CT system sends a request to the worklist provider to have an up-to-date Modality Worklist.

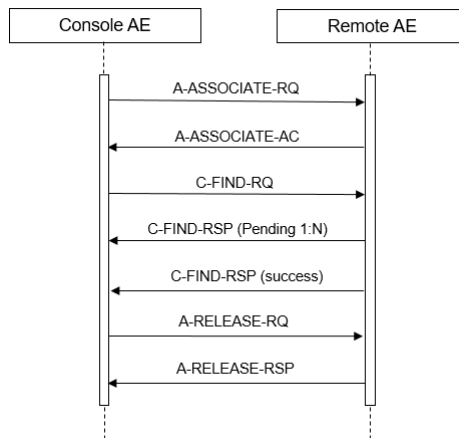

Figure 6: (Real World) Activity - Worklist request

A broad worklist query is triggered when changing from processing to scanning mode or when in scanning mode the “schedule” tab is selected.

The matching keys for the broad worklist query can be configured in advanced system settings for the HIS/RIS node. Available keys for the broad query are:

- Modality
- Station AE
- Station Name
- Scheduled Procedure Start Date

The Patient Specific worklist query is triggered when the search function is selected in scanning mode.

An association will be initiated to the configured worklist provider system (typically a RIS) to send a worklist query C-FIND-RQ message. The RIS processes the query and returns the list with scheduled studies for the CT scanner.

After receiving the worklist the association will be released by the scanner and the received studies will be displayed in the study list. The maximum number of worklist responses that are accepted by the Console system is configurable via the “max patient count” value. In case more responses are received than the configured value for “max patient count” the Console sends a C-CANCEL message to interrupt the query.

4.2.1.3.2.2. Proposed Presentation Contexts

The presentation contexts are defined in the table below:

Table 16: Proposed Presentation Contexts for (Real-World) Activity – Modality worklist As SCU

Presentation Context Table					
Abstract Syntax		Transfer Syntax		Role	Extended Negotiation
Name	UID	Name List	UID List		
Modality Worklist Information Model - FIND SOP Class	1.2.840.10008.5.1.4.31	Explicit VR Little Endian	1.2.840.10008.1.2.1	SCU	None
		Implicit VR Little Endian	1.2.840.10008.1.2.		
		Explicit VR Big Endian	1.2.840.10008.1.2.2		

The list of proposed transfer syntaxes is not configurable, neither the order.

4.2.1.3.2.3. SOP Specific Conformance for Modality Worklist Information Model - FIND SOP Class

This section and sub-section include the manufacturer SOP and Dataset specific information as well the status codes and their corresponding behavior.

4.2.1.3.2.3.1. Dataset Specific Conformance for Modality Worklist Information Model - FIND SOP Class C-FIND-SCU

Details regarding the Dataset Specific response behavior will be reported in this section.

Attribute Name: Attributes supported to build a Modality Worklist Request Identifier.

- Tag: DICOM tag for this attribute.
- VR: DICOM VR for this attribute.
- M: Matching Keys for (automatic) Worklist Update.
- R: Return Keys. An “X” will indicate that this attribute as Return Key with zero length for Universal Matching.
- Q: Interactive Query Key. An “X” will indicate that this attribute as matching key can be used.
- D: Displayed Keys. An “X” indicates that this Worklist attribute is displayed to the user during a patient registration dialog.
- IOD: An “X” indicates that this Worklist attribute is included into all object Instances created during performance of the related Procedure Step.

Type of matching: The following types of matching exists:

- Single Value Matching
- List of UID Matching
- Wild Card Matching
- Range Matching
- Sequence Matching
- Universal Matching

Table 17: Worklist Request Identifier

Attribute Name	Tag	VR	M	R	Q	D	IOD	Type of Matching	Comment
Patient Identification Module									
Patient's Name	0010,0010	PN		X	X	X	X	S,*,U	
Patient ID	0010,0020	LO		X	X	X	X	S,*,U	
Patient Demographic Module									
Patient's Birth Date	0010,0030	DA		X		X	X	U	
Patient's Sex	0010,0040	CS		X		X	X	U	
Patient's Age	0010,1010	AS		X		X	X	U	
Patient's Size	0010,1020	DS		X		X	X	U	
Patient's Weight	0010,1030	DS		X		X	X	U	
Patient Comments	0010,4000	LT		X			X	U	
Ethnic Group	0010,2160	SH		X				U	
Confidentiality Constraint On Patient Data Description	0040,3001	LO		X				U	
Scheduled Procedure Step Module									
Scheduled Procedure Step Sequence	0040,0100	SQ		X					
>Modality	0008,0060	CS	X	X	X		X	S,U	Always value CT used
>Scheduled Station AE Title	0040,0001	AE	X	X	X			S,U	
>Scheduled Procedure Step Start Date	0040,0002	DA	X	X	X	X		S,R,U	Supported values: Any Time,Next 7 days, Tomorrow, Today, Last 2 days, Last 3 days, Last week, Last 2 weeks
>Scheduled Procedure Step Start Time	0040,0003	TM		X		X		U	
>Scheduled Performing Physician's Name	0040,0006	PN		X					

Attribute Name	Tag	VR	M	R	Q	D	IOD	Type of Matching	Comment
>Scheduled Procedure Step Description	0040,0007	LO		X		X	X	U	Displayed as Study Description.
>Scheduled Procedure Step ID	0040,0009	SH		X				U	
>Scheduled Station Name	0040,0010	SH	X	X				S,U	Station name configured in Hospital information.
>Scheduled Protocol Code Sequence	0040,0008	SQ		X					
>> Code Value	0008,0100	SH		X				U	
>>Coding Scheme Designator	0008,0102	SH		X				U	
>>Code Meaning	0008,0104	LO		X				U	
Requested Procedure Module									
Requested Procedure Description	0032,1060	LO		X		X		U	
Requested Procedure ID	0040,1001	SH		X	X	X	X	S,*,U	Mapped to Study ID
Study Instance UID	0020,000D	UI		X			X	U	
Referenced Study Sequence	0008,1110	SQ		X				U	
Requested Procedure Code Sequence	0032,1064	SQ		X				U	
>Code Value	0008,0100	SH		X				U	
>Coding Scheme Designator	0008,0102	SH		X				U	
>Code Meaning	0008,0104	LO		X				U	
Reason For The Requested Procedure	0040,1002	LO		X				U	
Reason For Requested Procedure Code Sequence	0040,100A	SQ		X				U	
Imaging Service Request Module									
Accession Number	0008,0050	SH		X	X	X	X	S	
Referring Physician's Name	0008,0090	PN		X	X	X	X	S,*,U	
Requesting Physician	0032,1032	PN		X		X		U	
PlacerOrderNumberImagingServiceRequest	0040,2016	SH		X				U	
FillerOrderNumberImagingServiceRequest	0040,2017	SH		X				U	
SOP Common Module									
Specific Character Set	0008,0005	CS					X		
Visit Identification Module									
Admission ID	0038,0010	LO		X				U	
Visit Status Module									
Current Patient Location	0038,0300	LO		X				U	
Visit Relationship Module									
Referenced Patient Sequence	0008,1120	SQ		X				U	
Patient Medical Module									
PatientState	0038,0500	LO		X				U	
PregnancyStatus	0010,21C0	US		X				U	
MedicalAlerts	0010,2000	LO		X				U	
ContrastAllergies	0010,2110	LO		X				U	
SpecialNeeds	0038,0050	LO		X				U	
Visit Admission Module									
AdmittingDiagnosesDescription	0008,1080	LO		X				U	
AdmittingDiagnosesCodeSequence	0008,1084	SQ		X				U	

Types of Matching:

The types of Matching supported by the C-FIND SCU. An "S" indicates the identifier attribute uses Single Value Matching, an "R" indicates Range Matching, an "*" indicates wild card matching, a 'U' indicates Universal Matching.

This part of the section includes the dataset specific behavior, i.e. error codes, error and exception handling, time-outs, etc.

Table 18: Status Response

Service Status	Error Code	Further Meaning	Behavior
Success	0000	Matching is complete	The SCU has successfully returned all matching information. Association Release RQ message sent to RIS
Cancel	FE00	Matching terminated due to cancel request	Error code is logged. The association is released. (Cancel initiated by Console in case too many RIS responses received).
Failure	<xxxx>	All other error codes	Error code is logged. The association is aborted using A-Abort and the worklist query is marked as failed

4.2.1.3.3. (Real-World) Activity – Modality Performed Procedure Step As SCU

4.2.1.3.3.1. Description and Sequencing of Activities

When the first scan of an examination is initiated on the scanner, the Console Network AE opens an association to the MPPS server (typically a RIS) and sends an N-CREATE message with all appropriate information about the examination on the CT scanner. The status of the performed procedure will be set to IN-PROGRESS.

After clicking the “End Study” button on the scanner, the Console Network AE opens an association to the MPPS server and sends an N-SET message with the end date and end time and a status of respectively “COMPLETED” or “DISCONTINUED”. The MPPS function is independent of the use of storage commitment. All acquired/created DICOM instance in the study are reported in the N-SET message.

The sequence diagram below shows the interaction for the CT System RWA Report MPPS.

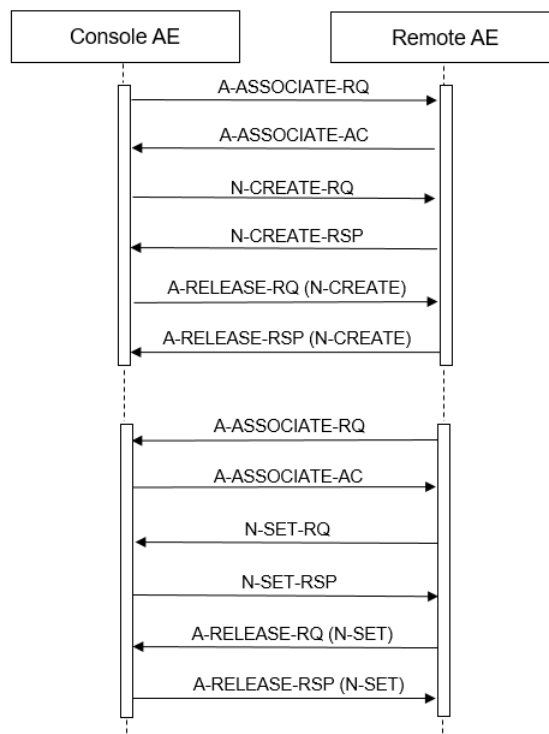

Figure 7: (Real World) Activity - MPPS as SCU

4.2.1.3.3.2. Proposed Presentation Contexts

The presentation context proposed by the Console Network AE are defined in the table below:

Table 19: Proposed Presentation Contexts for (Real-World) Activity – Modality Performed Procedure Step As SCU

Presentation Context Table					
Abstract Syntax		Transfer Syntax		Role	Extended Negotiation
Name	UID	Name List	UID List		
Modality Performed Procedure Step SOP Class	1.2.840.10008.3.1.2.3.3	Explicit VR Big Endian	1.2.840.10008.1.2.2	SCU	None
		Explicit VR Little Endian	1.2.840.10008.1.2.1		
		Implicit VR Little Endian	1.2.840.10008.1.2		

4.2.1.3.3.3. SOP Specific Conformance for Modality Performed Procedure Step SOP Class

The mapping of attributes in the MPPS messages is specified in chapter 8.1.3

4.2.1.3.3.3.1. Dataset Specific Conformance for Modality Performed Procedure Step SOP Class N-CREATE-SCU

The content of the MPPS N-CREATE-RQ message is specified in the table below

Table 20: MPPS Request Identifiers for N-CREATE-RQ

Attribute Name	Tag	VR	Value	Comment
Performed Procedure Step Relationship Module				
Referenced Patient Sequence	0008,1120	SQ		
Patient ID	0010,0020	LO		
Patient's Birth Date	0010,0030	DA		
Patient's Name	0010,0010	PN		
Patient's Sex	0010,0040	CS		
Scheduled Step Attributes Sequence	0040,0270	SQ		
>Accession Number	0008,0050	SH		
>Referenced Study Sequence	0008,1110	SQ		
>>ReferencedSOPClassUID	0008,1150	UI		
>>ReferencedSOPInstanceUID	0008,1155	UI		
>Study Instance UID	0020,000D	UI		
>Requested Procedure Description	0032,1060	LO		
>Scheduled Procedure Step Description	0040,0007	LO		
>Scheduled Protocol Code Sequence	0040,0008	SQ		
>> Code Meaning	0008,0104	LO		
>> Code Value	0008,0100	SH		
>> Coding Scheme Designator	0008,0102	SH		
>Scheduled Procedure Step ID	0040,0009	SH		
>Requested Procedure ID	0040,1001	SH		
Performed Procedure Step Information Module				
Procedure Code Sequence	0008,1032	SQ		
>> Code Meaning	0008,0104	LO		
>> Code Value	0008,0100	SH		
>> Coding Scheme Designator	0008,0102	SH		
Performed Station AE Title	0040,0241	AE		
Performed Station Name	0040,0242	SH		

Attribute Name	Tag	VR	Value	Comment
Performed Location	0040,0243	SH		
Performed Procedure Step Start Date	0040,0244	DA		
Performed Procedure Step Start Time	0040,0245	TM		
Performed Procedure Step End Date	0040,0250	DA		
Performed Procedure Step End Time	0040,0251	TM		
Performed Procedure Step Status	0040,0252	CS	IN PROGRESS	
Performed Procedure Step ID	0040,0253	SH		
Performed Procedure Step Description	0040,0254	LO		
Performed Procedure Type Description	0040,0255	LO		
Image Acquisition Results Module				
Modality	0008,0060	CS	CT	
Study ID	0020,0010	SH		
Performed Protocol Code Sequence	0040,0260	SQ		
Performed Series Sequence	0040,0340	SQ		
SOP Common Module				
Specific Character Set	0008,0005	CS		

The possible status responses for N-CREATE-RQ actions are shown in table below:

Table 21: Status Response

Service Status	Error Code	Further Meaning	Behavior
Success	0000	Success	The SCP has received the MPPS message. Association will be released.
Warning	xxxx	All warning codes	The MPPS operation is considered successful but the status meaning is logged.
Failed	xxxx	All other error codes	Error code is logged. The SCP cannot process the received MPPS message. Association is released and received status code error is logged. No N-Set message will be send.

4.2.1.3.3.3.2. Dataset Specific Conformance for Modality Performed Procedure Step SOP Class N-SET-SCU

The content of the MPPS N-SET-RQ message is specified in the table below.

Table 22: MPPS Request Identifiers for N-SET-RQ

Attribute Name	Tag	VR	Value	Comment
Performed Procedure Step Information Module				
Performed Procedure Step End Date	0040,0250	DA		
Performed Procedure Step End Time	0040,0251	TM		
Performed Procedure Step Status	0040,0252	CS	COMPLETED or DISCONTINUED	
PerformedProcedureStepDescription	0040,0254	LO		
Procedure Code Sequence	0008,1032	SQ		
>> Code Meaning	0008,0104	LO		
>> Code Value	0008,0100	SH		
>> Coding Scheme Designator	0008,0102	SH		
Image Acquisition Results Module				
Performed Series Sequence	0040,0340	SQ		

Attribute Name	Tag	VR	Value	Comment
>Retrieve AE Title	0008,0054	AE		
>Series Description	0008,103E	LO		
>Performing Physician's Name	0008,1050	PN		
>Operators' Name	0008,1070	PN		
>Referenced Image Sequence	0008,1140	SQ		
>Protocol Name	0018,1030	LO		
>Series Instance UID	0020,000E	UI		
>Referenced Non-Image Composite SOP Instance Sequence	0040,0220	SQ		
SOP Common Module				
Specific Character Set	0008,0005	CS		

This part of the section includes the dataset specific behavior, i.e. error codes, error and exception handling, time-outs, etc.

Table 23: Status Response

Service Status	Error Code	Further Meaning	Behavior
Success	0000	Success	The SCP has completed. Association is released.
Failure	<xxxx>	All other error codes	Error code is logged. Association is released

4.2.1.3.4. (Real-World) Activity – FIND as SCU

4.2.1.3.4.1. Description and Sequencing of Activities

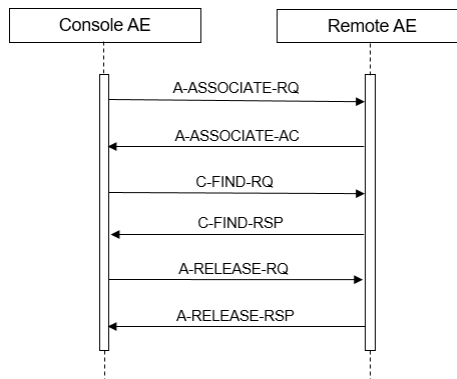

Figure 8: (Real World) Activity - Find as SCU

After a node is selected by the operator from the remote device list, the search window pops-up. After the required matching values are entered and the search button is pressed, a study level query request is send to the remote system. Only for the first received study, automatically a new association is opened for a series level query. All results (study, series) are displayed in the study manager on the Console system.

Each time a study is selected from the remote study list, a series level query is automatically started.

4.2.1.3.4.2. Proposed Presentation Contexts

Each time an association is initiated, the association initiator propose a number of presentation contexts to be used on that association. In this subsection, the presentation context proposed by Console Network AE for (Real World) Activity - C-FIND (SCU) are defined.

Table 24: Proposed Presentation Contexts for (Real-World) Activity – FIND As SCU

Presentation Context Table					
Abstract Syntax		Transfer Syntax		Role	Extended Negotiation
Name	UID	Name List	UID List		
Study Root QR Information Model - FIND SOP Class	1.2.840.10008.5.1.4.1.2.2.1	Explicit VR Little Endian	1.2.840.10008.1.2.1	SCU	None
		Implicit VR Little Endian	1.2.840.10008.1.2		
		Explicit VR Little Endian	1.2.840.10008.1.2.2		

4.2.1.3.4.3. SOP Specific Conformance for Study Root QR Information Model - FIND SOP Class

This section and sub-section include the manufacturer SOP and Dataset specific information as well the status codes and their corresponding behavior.

4.2.1.3.4.3.1. Dataset Specific Conformance for Study Root QR Information Model - FIND SOP Class C-FIND-SCU

In the table below the query keys are specified for each supported query level.

Table 25: Supported Query Keys for Study Root Information Model

Study Root Information Model				
Attribute Name	Tag	VR	Type Of Matching	Comment
Query/Retrieve Level	0008,0052	CS		STUDY, SERIES
Specific Character Set	0008,0005	CS		Only present in case non default characters are used in one of the matching values.
Study level attributes				
Study Date	0008,0020	DA	R,U	Possible values: Select time, Today, Last Two Days, Last Three Days, Last Week, Last Two Weeks, Any Time,
Study Time	0008,0030	TM	R,U	
Accession Number	0008,0050	SH	*,U	
Modalities in Study	0008,0061	CS	S,L,U	CT,ECG, CT or ECG
Referring Physician's Name	0008,0090	PN	*,U	
Study Description	0008,1030	LO	*,U	
Patient's Name	0010,0010	PN	*,U	
Patient ID	0010,0020	LO	*,U	
Patient's Birth Time	0010,0032	TM	U	
Patient's Sex	0010,0040	CS	S,U	M,F,O
Study Instance UID	0020,000D	UI	U	
Study ID	0020,0010	SH	*,U	
Number of Study Related Series	0020,1206	IS	U	
Number of Study Related Instances	0020,1208	IS	U	
Series level attributes				
Series Date	0008,0021	DA	U	
Series Time	0008,0031	TM	U	
Modality	0008,0060	CS	S,U	CT,ECG
Series Description	0008,103E	LO	U	

Performing Physician Name	0008,1050	PN	U	
Operators' Name	0008,1070	PN	U	
Referenced Study Sequence	0008,1110	SQ	U	
Body Part Examined	0018,0015	CS	U	
Protocol Name	0018,1030	LO	U	
Study Instance UID	0020,000D	UI	S	
Series Instance UID	0020,000E	UI	U	
Series Number	0020,0011	IS	S,U	
Number of Series Related Instances	0020,1209	IS	U	
Performed Procedure Step Start Date	0040,0244	DA	R,U	Possible values: Select time, Today, Last Two Days, Last Three Days, Last Week, Last Two Weeks, Any Time
Performed Procedure Step Start Time	0040,0245	TM	U	
Request Attributes Sequence	0040,0275	SQ	U	
Scheduled Procedure Step ID	0040,0009	SH	U	
Requested Procedure ID	0040,1001	SH	U	

Types of Matching:

The types of Matching supported by the C-FIND SCU. An "S" indicates the identifier attribute uses Single Value Matching, an "R" indicates Range Matching, an "*" indicates wild card matching, a 'U' indicates Universal Matching, and an 'L' indicates that UID lists are sent.

This part of the section includes the dataset specific behavior, i.e. error codes, error and exception handling, time-outs, etc.

Table 26: Status Response

Service Status	Error Code	Further Meaning	Behavior
Success	0000	Matching is complete	Query result is logged in Dicomlog file Association is released
Failure	<xxxx>	Failed Communication	Error code is logged in Dicomlog file. The Association is aborted using A-ABORT

4.2.1.3.5. (Real-World) Activity – MOVE as SCU

4.2.1.3.5.1. Description and Sequencing of Activities

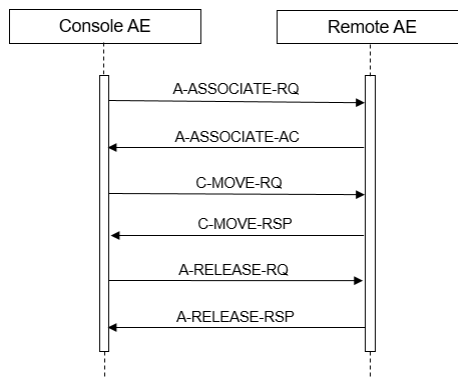

Figure 9: (Real World) Activity - MOVE as SCU

In the Console 1 or more studies, series or images can be selected and via the “copy to local” button a retrieve request (C-MOVE-RQ) can be send to the remote device. In case multiple studies, series are selected for retrieve, for each item a separate C-MOVE-RQ message is send in a separate association to the remote system. (Only a single UID value is included in a C-MOVE –RQ on all levels). The association is released after the final Retrieve (C-MOVE) response for the related request has been received (no more pending)

4.2.1.3.5.2. Proposed Presentation Contexts

The presentation contexts for MOVE as SCU are defined in the table below.

Table 27: Proposed Presentation Contexts for (Real-World) Activity – MOVE As SCU

Presentation Context Table					
Abstract Syntax		Transfer Syntax		Role	Extended Negotiation
Name	UID	Name List	UID List		
Study Root QR Information Model - MOVE SOP Class	1.2.840.10008.5.1.4.1.2.2.2	Explicit VR Little Endian	1.2.840.10008.1.2.1	SCU	None
		Implicit VR Little Endian	1.2.840.10008.1.2		
		Explicit VR Big Endian	1.2.840.10008.1.2.2		

4.2.1.3.5.3. SOP Specific Conformance for Study Root QR Information Model - MOVE SOP Class

The CT System provides standard conformance for the Study Root QR Information Model - MOVE SOP Class.

4.2.1.3.5.3.1. Dataset Specific Conformance for Study Root QR Information Model - MOVE SOP Class C-MOVE-SCU

Details regarding the Dataset Specific response behavior will be reported in this section.

Table 28: Identifiers for MOVE Study Root Information Model as SCU

Study Root Information Model				
Attribute Name	Tag	VR	Type Of Matching	Comment
Query/Retrieve Level	0008,0052	CS		Study, Series
Study level attributes				
Study Instance UID	0020,000D	UI	L,U	
Series level attributes				
Series Instance UID	0020,000E	UI	L,U	
Study Instance UID	0020,000D	UI	U	

Types of Matching:

The types of Matching supported by the C-MOVE SCU. A 'U' indicates UNIQUE Matching (single UID), and an 'L' indicates that UID lists are sent.

The DICOM C-MOVE Study Root Information Model Command Status Response Handling is shown in the Table below.

Table 29: Status Response

Service Status	Status Code	Further Meaning	Behavior
Success	0000	Sub-operations completed	Association is released and operation is logged.

Service Status	Status Code	Further Meaning	Behavior
Refused	A701	Out of resources. Unable to calculate number of matches	Error code is logged. Association is released
	A702	Out of resources. Unable to perform sub-operations	Error code is logged. Association is released
	A703	Move destination Unknown	Error code is logged. Association is released
Failed	A900	Identifier does not match SOP class	Error code is logged. Association is released
	Cxxx	Unable to process	Error code is logged. Association is released
Warning	B000	Sub-operations completed. One or more failures	Warning code is logged. Association is released
Pending	FF00	Sub operations are continuing	Status is logged. The move job continues

4.2.1.3.6. (Real-World) Activity – Image Export

4.2.1.3.6.1. Description and Sequencing of Activities

As defined by the Console RWA export Images, from the local patient database studies/series/images can be selected for export to a remote destination. The export is triggered by using the button “Copy to “

For each selected Examination the Console AE will successively do the following actions.

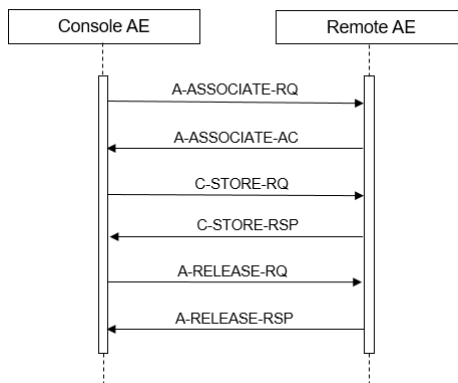

Figure 10: (Real World) Activity – Image export

The Console AE initiates an association with the configured export node. Over this association all images, related data are exported. When the storage job has finished, be it successfully or not, the Console AE releases the association.

4.2.1.3.6.2. Proposed Presentation Contexts

The presentation contexts proposed by the Console AE for Image Export are defined in Table below.

Table 30: Proposed Presentation Contexts for (Real-World) Activity – Image Export

Presentation Context Table					
Abstract Syntax		Transfer Syntax		Role	Extended Negotiation
Name	UID	Name List	UID List		
CT Image Storage SOP class	1.2.840.10008.5.1.4.1.1.2	Explicit VR Little Endian	1.2.840.10008.1.2.1	SCU	None
		Implicit VR Little Endian	1.2.840.10008.1.2		
		Explicit VR Big Endian	1.2.840.10008.1.2.2		

Presentation Context Table					
Abstract Syntax		Transfer Syntax		Role	Extended Negotiation
Name	UID	Name List	UID List		
Secondary Capture Image Storage SOP class	1.2.840.10008.5.1.4.1.1.7	Explicit VR Little Endian	1.2.840.10008.1.2.1	SCU	None
		Implicit VR Little Endian	1.2.840.10008.1.2		
		Explicit VR Big Endian	1.2.840.10008.1.2.2		
X-Ray Radiation Dose SR SOP Class	1.2.840.10008.5.1.4.1.1.88.67	Explicit VR Little Endian	1.2.840.10008.1.2.1	SCU	None
		Implicit VR Little Endian	1.2.840.10008.1.2		
		Explicit VR Big Endian	1.2.840.10008.1.2.2		
General ECG Waveform Storage SOP Class	1.2.840.10008.5.1.4.1.1.9.1.2	Explicit VR Little Endian	1.2.840.10008.1.2.1	SCU	None
		Implicit VR Little Endian	1.2.840.10008.1.2		
		Explicit VR Big Endian	1.2.840.10008.1.2.2		

4.2.1.3.6.3. Dataset Specific Conformance for C-STORE-RQ

The possible Status Responses for the export Images storage are shown in table below.

Table 31: C-STORE-RQ Status Response

Service Status	Code	Further Meaning	Behavior
Success	0000	Storage is complete	On the Status bar a message is shown that all images were sent completely and then hide automatically
Failure	A7xx	Refused: Out of resources	The reason is logged. "Sending image file: message = Refused: out of Resources" message is displayed in the status bar.
	A9xx	Error: Data set does not match SOP class	The reason is logged. "Sending image file: message = Error: Data set doesnot match sop class" message is displayed in the status bar.
	Cxxx	Error: Cannot understand	The reason is logged. "Sending image file: message = Error: Cannot understand" message is displayed in the status bar.
Warning	B000	Coercion of data elements	The reason is logged. Message pops up in status bar to give user the error message.
	B006	Elements discarded	The reason is logged. Message pops up in status bar to give user the error message.
	B007	Data set does not match SOP class	The reason is logged. Message pops up in status bar to give user the error message.

The status can be inspected via the user interface (queue manager).

The possible communication failures during a C-STORE-RQ are listed in table below.

Table 32: DICOM Command Communication Failure Behavior

Exception	Behavior
Timeout	The Association is aborted using A-ABORT and job is marked as failed. The reason is logged.
Association aborted	The job is marked as failed. The reason is logged.

4.2.1.3.7. (Real-World) Activity – Storage Commitment Push Model AS SCU

4.2.1.3.7.1. Description and Sequencing of Activities

The support for storage commitment has to be configured for a remote PACS node in the configuration tool in Console. The Console AE supports both synchronous and asynchronous storage commitment.

Via the parameter “Commit Max Reply Waiting Time” in the PACS node configuration, the time is configured that Console keeps the storage commitment association open to wait for a response (N-EVENT-REPORT) from the PACS.

In case the response is received within the waiting time interval, the whole storage commitment transaction (N-ACTION and N-EVENT-REPORT) is handled in the same association (Synchronous mode).

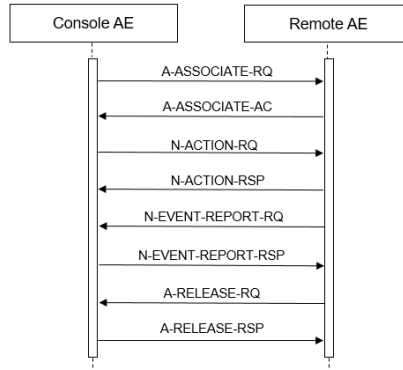

Figure 11: (Real World) Activity - Synchronous Storage Commitment Push model as SCU

If the N-EVENT-REPORT is not received within the configured waiting time period, the Console AE releases the association and the storage commitment continues asynchronously. (PACS has to open a new association with Console for sending the N-EVENT-REPORT).

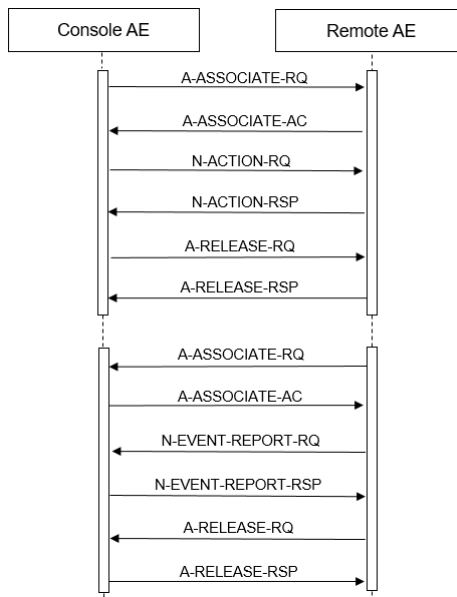

Figure 12: (Real World) Activity - Asynchronous Storage Commitment Push model as SCU

4.2.1.3.7.2. Proposed Presentation Contexts

The proposed presentation contexts for Storage Commitment Push Model as SCU are defined in Table below.

Table 33: Proposed Presentation Contexts for (Real-World) Activity – Storage Commitment Push Model AS SCU

Presentation Context Table					
Abstract Syntax		Transfer Syntax		Role	Extended Negotiation
Name	UID	Name List	UID List		
Storage Commitment Push Model SOP Class	1.2.840.10008.1.20.1	Explicit VR Little Endian	1.2.840.10008.1.2.1	SCU	None
		Implicit VR Little Endian	1.2.840.10008.1.2		
		Explicit VR Little Endian	1.2.840.10008.1.2.2		

4.2.1.3.7.3. SOP Specific Conformance for Storage Commitment Push Model SOP Class

The Console system conforms to the standard Storage Commitment model. Storage commitment is requested for all exported instances.

4.2.1.3.7.3.1. Dataset Specific Conformance for Storage Commitment Push Model SOP Class N-ACTION-SCU

This chapter describes the Dataset Specific response behavior for Storage Commitment Attribute N-ACTION-RQ.

Table 34: Storage Commitment Attribute for N-ACTION-RQ

Attribute Name	Tag	Comment
Storage Commitment Module		
Transaction UID	0008,1195	
Referenced SOP Sequence	0008,1199	
>Referenced SOP Class UID	0008,1150	
>Referenced SOP Instance UID	0008,1155	

The behavior of Console for handling the status responses received in the N-ACTION-RSP message are shown in the table below

Table 35: Status Response

Service Status	Error Code	Further Meaning	Behavior
Success	0000	Success	Console will log the transaction with status success. Association is left open for the time configured in the parameter “commit Max Reply Waiting Time” to wait for response from archive.
Failure	<xxxx>	All other error codes	Error code is logged. No new request for commitment is send to the archive.

The possible communication failures are shown in the below 48.

Table 36: DICOM Command Communication Failure Behavior N-ACTION.

Exception	Behavior
ARTIM Time-out	The association is released. Storage commitment response is expected on a new association
Reply Time-out	The association is released. Storage commitment response is expected on a new association.
Association Time-out SCU	The association is released. Storage commitment response is expected on a new association.
Association Aborted	The association is released. Storage commitment response is expected on a new association

4.2.1.3.7.3.2. Dataset Specific Conformance for Storage Commitment Push Model SOP Class N-EVENT-REPORT-SCU

For receiving the Storage Commitment N-EVENT-REPORT, the Console system acts as SCU role even if a new association is opened by the archive to the Console system for sending the N-EVENT-REPORT message (=reverse role).

On receiving a storage commitment result with Event Type ID 1 (Storage Commitment Request Successful) the Application Entity will mark these images as committed.

On receiving a storage commitment result with Event Type ID 2 (Storage Commitment Request Complete - Failures Exist) the Application Entity will mark the not committed images as failed. (in log file) and in UI data cannot be deleted message is displayed.

Table 37: Status Response N-EVENT-REPORT.

Service Status	Error Code	Further Meaning	Behavior
Success	0000	Success	N-EVENT-REPORT has been received and processed.

4.2.1.3.8. (Real-World) Activity - Print Management as SCU

4.2.1.3.8.1. Description and Sequencing of Activities

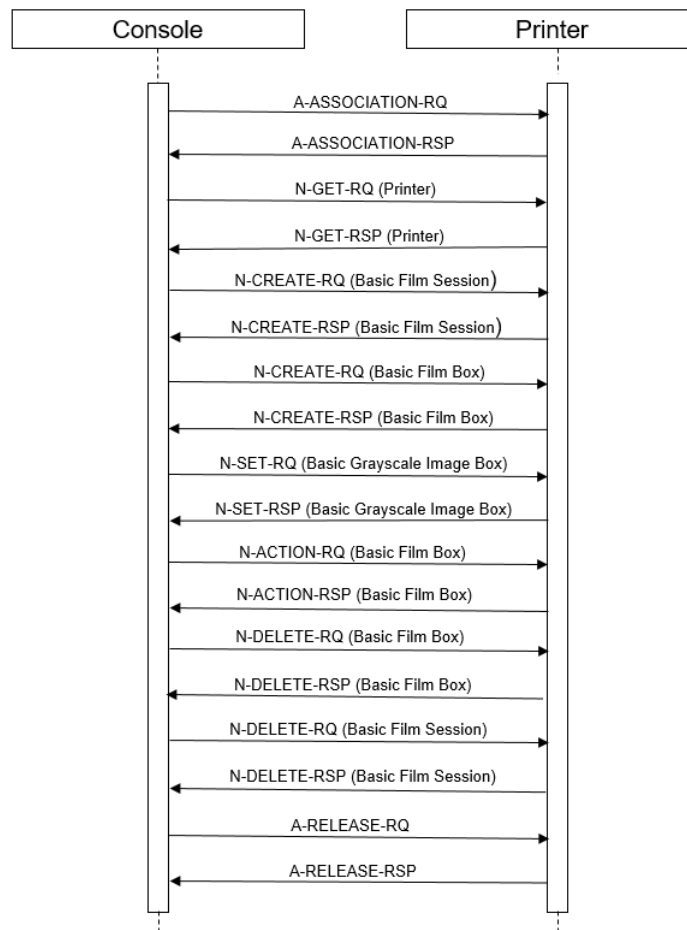

Figure 13: (Real World) Activity - Print Management as SCU

A typical sequence of DIMSE messages sent in an association between Hardcopy AE and a Printer is illustrated in above figure.

- Print AE opens an association with the printer.

- N-GET on the Printer SOP Class is used to obtain current printer status information. If the printer reports a status of failure, the print-job is switched to a failed state and the user is informed.
- N-CREATE on the Film Session SOP Class creates a Film Session.
- N-CREATE on the Film Box SOP Class creates a film box linked to the film session. A single image box will be created as the result of the operation. (Print AE only use the format STANDARD\1,1)
- N-SET on the Image Box (Grayscale or Color) SOP Class transfers the contents of the film sheet to the printer.
- N-ACTION on the Film Box SOP Class instructs the printer to print the film box.
- The printer prints the requested number of film sheets.
- N-DELETE on the FILM BOX SOP Class deletes the Film Box SOP Instance.
- N-DELETE on the Film Session SOP Class deletes the complete Film Session SOP Instance hierarchy.
- Print AE close the association with the printer.

4.2.1.3.8.2. Proposed Presentation Contexts

The presentation contexts are defined in the next table.

Table 38: Proposed Presentation Contexts for (Real-World) Activity – Print Management As SCU

Presentation Context Table					
Abstract Syntax		Transfer Syntax		Role	Extended Negotiation
Name	UID	Name List	UID List		
Basic Color Print Management Meta SOP Class	1.2.840.10008.5.1.1.18			SCU	None
>Basic Color Image Box SOP Class	1.2.840.10008.5.1.1.4.1	Explicit VR Big Endian	1.2.840.10008.1.2.2	SCU	None
		Explicit VR Little Endian	1.2.840.10008.1.2.1		
		Implicit VR Little Endian	1.2.840.10008.1.2		
>Basic Film Box SOP Class	1.2.840.10008.5.1.1.2	Explicit VR Big Endian	1.2.840.10008.1.2.2	SCU	None
		Explicit VR Little Endian	1.2.840.10008.1.2.1		
		Implicit VR Little Endian	1.2.840.10008.1.2		
>Basic Film Session SOP Class	1.2.840.10008.5.1.1.1	Explicit VR Big Endian	1.2.840.10008.1.2.2	SCU	None
		Explicit VR Little Endian	1.2.840.10008.1.2.1		
		Implicit VR Little Endian	1.2.840.10008.1.2		
>Printer SOP Class	1.2.840.10008.5.1.1.16	Explicit VR Big Endian	1.2.840.10008.1.2.2	SCU	None
		Explicit VR Little Endian	1.2.840.10008.1.2.1		
		Implicit VR Little Endian	1.2.840.10008.1.2		
Basic Grayscale Print Management Meta SOP Class	1.2.840.10008.5.1.1.9			SCU	None
>Basic Film Box SOP Class	1.2.840.10008.5.1.1.2	Explicit VR Big Endian	1.2.840.10008.1.2.2	SCU	None
		Explicit VR Little Endian	1.2.840.10008.1.2.1		
		Implicit VR Little Endian	1.2.840.10008.1.2		
>Basic Film Session SOP Class	1.2.840.10008.5.1.1.1	Explicit VR Big Endian	1.2.840.10008.1.2.2	SCU	None
		Explicit VR Little Endian	1.2.840.10008.1.2.1		
		Implicit VR Little Endian	1.2.840.10008.1.2		
>Basic Grayscale Image Box SOP Class	1.2.840.10008.5.1.1.4	Explicit VR Big Endian	1.2.840.10008.1.2.2	SCU	None
		Explicit VR Little Endian	1.2.840.10008.1.2.1		
		Implicit VR Little Endian	1.2.840.10008.1.2		
>Printer SOP Class	1.2.840.10008.5.1.1.16	Explicit VR Big Endian	1.2.840.10008.1.2.2	SCU	None
		Explicit VR Little Endian	1.2.840.10008.1.2.1		
		Implicit VR Little Endian	1.2.840.10008.1.2		

This section specifies each IOD created (including private IOD's).

Abbreviations used in the Module table for the column "Presence of Value" are:

ALWAYS	The attribute is always present with a value
EMPTY	The attribute is always present without any value (attribute sent zero length)
VNAP	The attribute is always present and its Value is Not Always Present (attribute sent zero length if no value is present)
ANAP	The attribute is present under specified condition – if present then it will always have a value
ANAPCV	The attribute is present under specified condition – if present then its Value is Not Always Present (attribute sent zero length if condition applies and no value is present)
ANAPEV	The attribute is present under specified condition – if present then it will not have any value

The abbreviations used in the Module table for the column "Source" are:

AUTO	The attribute value is generated automatically
CONFIG	The attribute value source is a configurable parameter
COPY	The attribute value source is another SOP instance
FIXED	The attribute value is hard-coded in the application
IMPLICIT	The attribute value source is a user-implicit setting
USER	The attribute value source is explicit user input

4.2.1.3.8.3. SOP Specific Conformance for Basic Color Image Box SOP Class of the Basic Color Print Management Meta SOP Class

This section and sub-section include the manufacturer SOP and Dataset specific information as well the status codes and their corresponding behavior.

4.2.1.3.8.3.1. Dataset Specific Conformance for Basic Color Image Box SOP Class N-SET Request.

Details regarding the Dataset Specific request behavior will be reported in this section.

Table 39: Image Box Pixel Presentation Module

Attribute Name	Tag	VR	Value	Presence of Value	Source	Comment
Image Box Position	2020,0010	US		ALWAYS	AUTO	
Polarity	2020,0020	CS	NORMAL	ALWAYS	FIXED	
Basic Color Image Sequence	2020,0111	SQ		ALWAYS	AUTO	
>Samples per Pixel	0028,0002	US	3	ALWAYS	FIXED	
>Photometric Interpretation	0028,0004	CS	RGB	ALWAYS	FIXED	
>Planar Configuration	0028,0006	US	0	ALWAYS	FIXED	
>Rows	0028,0010	US		ALWAYS	AUTO	
>Columns	0028,0011	US		ALWAYS	AUTO	
>Pixel Aspect Ratio	0028,0034	IS	1\1	ALWAYS	FIXED	
>Bits Allocated	0028,0100	US	8	ALWAYS	FIXED	
>Bits Stored	0028,0101	US	8	ALWAYS	FIXED	
>High Bit	0028,0102	US	7	ALWAYS	FIXED	
>Pixel Representation	0028,0103	US	0	ALWAYS	FIXED	
>Pixel Data	7FE0,0010	OW/ OB		ALWAYS	AUTO	

This part of the section includes the dataset specific behavior, i.e. error codes, error and exception handling, time-outs, etc.

Table 40: Status Response

Service Status	Error Code	Further Meaning	Behavior
Success	0000	Image successfully stored in image box.	The print job continues and completes.
Failure	xxxx	(any failure)	Print job is not terminated, job is continued and the association is released. .
Warning	B604	Image size is larger than image box size, the image has been unmagnified.	The print job continues and the warning is logged.
	B605	Requested Min Density or Max Density outside of printer's operating range. The printer will use its respective minimum or maximum density value instead.	The print job continues and the warning is logged.
	B609	Image size is larger than the image box size. The image has been cropped to fit.	The print job continues and the warning is logged.
	B60A	Image size or combined print image size is larger than the image box size. Image or combined print image has been decimated to fit.	The print job continues and the warning is logged.

4.2.1.3.8.4. SOP Specific Conformance for Basic Film Box SOP Class of the Basic Color Print Management Meta SOP Class

This section and sub-section include the manufacturer SOP and Dataset specific information as well the status codes and their corresponding behavior.

4.2.1.3.8.4.1. Dataset Specific Conformance for Basic Film Box SOP Class N-CREATE Request

Details regarding the Dataset Specific request behavior will be reported in this section.

Table 41: Basic Film Box Presentation Module

Attribute Name	Tag	VR	Value	Presence of Value	Source	Comment
Image Display Format	2010,0010	ST	STANDARD\1,1	ALWAYS	FIXED	
Film Orientation	2010,0040	CS	PORTRAIT, LANDSCAPE	ALWAYS	USER	
Film Size ID	2010,0050	CS		ALWAYS	CONFIG	
Magnification Type	2010,0060	CS		ALWAYS	CONFIG	
Min Density	2010,0120	US		ALWAYS	CONFIG	
Max Density	2010,0130	US		ALWAYS	CONFIG	
Trim	2010,0140	CS	YES, NO	ALWAYS	CONFIG	

Table 42: Basic Film Box Relationship Module

Attribute Name	Tag	VR	Value	Presence of Value	Source	Comment
Referenced Film Session Sequence	2010,0500	SQ		ALWAYS	AUTO	
>Referenced SOP Class UID	0008,1150	UI		ALWAYS	AUTO	
>Referenced SOP Instance UID	0008,1155	UI		ALWAYS	AUTO	

This part of the section includes the dataset specific behavior, i.e. error codes, error and exception handling, time-outs, etc.

Table 43: Status Response

Service Status	Error Code	Further Meaning	Behavior
Success	0000	Film accepted for printing.	The print job continues and completes.

Service Status	Error Code	Further Meaning	Behavior
Failure	xxxx	(any failure)	Print job is not terminated, job is continued and the association is released.
Warning	B603	Film Box SOP Instance hierarchy does not contain Image Box SOP Instances (empty page).	The print job continues and the warning is logged.
	B604	Image size is larger than image box size, the image has been unmagnified.	The print job continues and the warning is logged.
	B609	Image size is larger than the image box size. The image has been cropped to fit.	The print job continues and the warning is logged.
	B60A	Image size or combined print image size is larger than the image box size. Image or combined print image has been decimated to fit.	The print job continues and the warning is logged.

4.2.1.3.8.4.2. Dataset Specific Conformance for Basic Film Box SOP Class N-ACTION Response

This part of the section includes the dataset specific behavior, i.e. error codes, error and exception handling, time-outs, etc.

Table 44: Status Response

Service Status	Error Code	Further Meaning	Behavior
Success	0000	Film accepted for printing.	The print job continues and completes.
Failure	xxxx	(any failure)	Print job fails, the error is logged, and the association is released.
Warning	B603	Film Box SOP Instance hierarchy does not contain Image Box SOP Instances (empty page).	The print job continues and the warning is logged.
	B604	Image size is larger than image box size, the image has been unmagnified.	The print job continues and the warning is logged.
	B609	Image size is larger than the image box size. The image has been cropped to fit.	The print job continues and the warning is logged.
	B60A	Image size or combined print image size is larger than the image box size. Image or combined print image has been decimated to fit.	The print job continues and the warning is logged.

4.2.1.3.8.4.3. Dataset Specific Conformance for Basic Film Box SOP Class N-DELETE-SCU

Details regarding the Dataset Specific response behavior will be reported in this section.

This part of the section includes the dataset specific behavior, i.e. error codes, error and exception handling, time-outs, etc.

Table 45: Status Response

Service Status	Error Code	Further Meaning	Behavior
Success	0000	Job successfully completed	The SCU has successfully completed
Other than Success	<xxxx>	Any other status than success	The job remains in the queue manager, with status failed

4.2.1.3.8.5. SOP Specific Conformance for Basic Film Session SOP Class of the Basic Color Print Management Meta SOP Class

This section and sub-sections include the manufacturer SOP and Dataset specific information as well the status codes and their corresponding behavior.

4.2.1.3.8.5.1. Dataset Specific Conformance for Basic Film Session SOP Class N-CREATE Request

Table 46: Basic Film Session Presentation Module

Attribute Name	Tag	VR	Value	Presence of Value	Source	Comment
Number of Copies	2000,0010	IS		ALWAYS	USER	
Print Priority	2000,0020	CS	MED	ALWAYS	FIXED	
Medium Type	2000,0030	CS		ALWAYS	CONFIG	
Film Destination	2000,0040	CS		ALWAYS	CONFIG	
Film Session Label	2000,0050	LO	Philips	ALWAYS	FIXED	

This part of the section includes the dataset specific behavior, i.e. error codes, error and exception handling, time-outs, etc.

Table 47: Status Response

Service Status	Error Code	Further Meaning	Behavior
Success	0000	Success	The SCP has completed the operation successfully
Warning	<xxxx>	All warning numbers	Warning is ignored, print job continued.
Failure	<xxxx>	All error numbers	Error is logged and print job is marked as failure.

4.2.1.3.8.5.2. Dataset Specific Conformance for Basic Film Session SOP Class N-DELETE Request.

This part of the section includes the dataset specific behavior, i.e. error codes, error and exception handling, time-outs, etc.

Table 48: Status Response

Service Status	Error Code	Further Meaning	Behavior
Success	0000	Success	The SCP has completed the operation successfully
Failure	<xxxx>	Error code	The print job fails, the error is logged and the association is released.

4.2.1.3.8.6. SOP Specific Conformance for Printer SOP Class of the Basic Color Print Management Meta SOP Class

This section and sub-section include the manufacturer SOP and Dataset specific information as well the status codes and their corresponding behavior.

4.2.1.3.8.6.1. Dataset Specific Conformance for Printer SOP Class N-EVENT-REPORT Request.

The DIMSE N-EVENT-REPORT of the Printer SOP Class is not supported by the Console.

4.2.1.3.8.6.2. Dataset Specific Conformance for Printer SOP Class N-GET Request.

Details regarding the Dataset Specific request behavior will be reported in this section.

This part of the section includes the dataset specific behavior, i.e. error codes, error and exception handling, time-outs, etc.

Table 49: Status Response

Service Status	Error Code	Further Meaning	Behavior
Success	0000	Success	The SCP has completed the operation successfully
Failure	<xxxx>	Error during printing	Error is logged and print job is marked as failure
Warning	<xxxx>	Warning during printing	The Console does not react on this status and finish print job

4.2.1.3.8.7. SOP Specific Conformance for Basic Film Box SOP Class of the Basic Grayscale Print Management Meta SOP Class

This section and sub-section include the manufacturer SOP and Dataset specific information as well the status codes and their corresponding behavior.

4.2.1.3.8.7.1. Dataset Specific Conformance for Basic Film Box SOP Class N-CREATE-RQ

Details regarding the Dataset Specific response behavior will be reported in this section.

Table 50: Basic Film Box Presentation Module

Attribute Name	Tag	VR	Value	Presence of Value	Source	Comment
Image Display Format	2010,0010	ST	STANDARD\1,1	ALWAYS	FIXED	
Film Orientation	2010,0040	CS	PORTRAIT, LANDSCAPE	ALWAYS	USER	
Film Size ID	2010,0050	CS		ALWAYS	CONFIG	
Magnification Type	2010,0060	CS		ALWAYS	CONFIG	
Min Density	2010,0120	US		ALWAYS	CONFIG	
Max Density	2010,0130	US		ALWAYS	CONFIG	
Trim	2010,0140	CS	YES,NO	ALWAYS	CONFIG	

Table 51: Basic Film Box Relationship Module

Attribute Name	Tag	VR	Value	Presence of Value	Source	Comment
Referenced Film Session Sequence	2010,0500	SQ		ALWAYS	AUTO	
>Referenced SOP Class UID	0008,1150	UI		ALWAYS	AUTO	
>Referenced SOP Instance UID	0008,1155	UI		ALWAYS	AUTO	

Table 52: Status Response

Service Status	Error Code	Further Meaning	Behavior
Success	0000	Success	The SCP has completed the operation successfully
Failure	<xxxx>	All error numbers	Error is logged and print job is marked as failure
Warning	<xxxx>	All warning numbers	Warning is logged, print job continued.

4.2.1.3.8.7.2. Dataset Specific Conformance for Basic Film Box SOP Class N-ACTION Request.

Details regarding the Dataset Specific response behavior will be reported in this section.

Table 53: Status Response

Service Status	Error Code	Further Meaning	Behavior
Success	0000	Success	The SCP has completed the operation successfully
Failure	<xxxx>	Error code	Print job continued.

4.2.1.3.8.7.3. Dataset Specific Conformance for Basic Film Box SOP Class N-DELETE Request.

Details regarding the Dataset Specific response behavior will be reported in this section.

Table 54: Status Response

Service Status	Error Code	Further Meaning	Behavior
Success	0000	Success	The SCP has completed the operation successfully
Failure	<xxxx>	Error code	Print job continued

4.2.1.3.8.8. SOP Specific Conformance for Basic Film Session SOP Class of the Basic Grayscale Print Management Meta SOP Class

This section and sub-section include the manufacturer SOP and Dataset specific information as well the status codes and their corresponding behavior.

4.2.1.3.8.8.1. Dataset Specific Conformance for Basic Film Session SOP Class N-CREATE Request

Details regarding the Dataset Specific response behavior will be reported in this section.

Table 55: Basic Film Session Presentation Module

Attribute Name	Tag	VR	Value	Presence of Value	Source	Comment
Number of Copies	2000,0010	IS		ALWAYS	USER	
Print Priority	2000,0020	CS		ALWAYS	FIXED	
Medium Type	2000,0030	CS		ALWAYS	CONFIG	
Film Destination	2000,0040	CS		ALWAYS	CONFIG	
Film Session Label	2000,0050	LO	Philips	ALWAYS	FIXED	

This part of the section includes the dataset specific behavior, i.e. error codes, error and exception handling, time-outs, etc.

Table 56: Status Response

Service Status	Error Code	Further Meaning	Behavior
Success	0000	Success	The SCP has completed the operation successfully
Failure	0106	Invalid attribute value	The association is released after error is received. Does not send film to printer.
	<xxxx>	Other error numbers	Error is ignored, print job continued.
Warning	<xxxx>	All warning numbers	Warning is ignored, print job continued.

4.2.1.3.8.8.2. Dataset Specific Conformance for Basic Film Session SOP Class N-DELETE Request.

Details regarding the Dataset Specific response behavior will be reported in this section.

Table 57: Status Response

Service Status	Error Code	Further Meaning	Behavior
Success	0000	Success	The SCP has completed the operation successfully
Failure	<xxxx>	Error code	Print job continued

4.2.1.3.8.9. SOP Specific Conformance for Basic Grayscale Image Box SOP Class of the Basic Grayscale Print Management Meta SOP Class

This section and sub-section include the manufacturer SOP and Dataset specific information as well the status codes and their corresponding behavior.

4.2.1.3.8.9.1. Dataset Specific Conformance for Basic Grayscale Image Box SOP Class N-SET Request.

Details regarding the Dataset Specific response behavior will be reported in this section.

Table 58: Image Box Pixel Presentation Module

Attribute Name	Tag	VR	Value	Presence of Value	Source	Comment
Image Box Position	2020,0010	US		ALWAYS	AUTO	
Polarity	2020,0020	CS	NORMAL	ALWAYS	FIXED	
Basic Grayscale Image Sequence	2020,0110	SQ		ALWAYS	AUTO	
>Samples per Pixel	0028,0002	US	1	ALWAYS	FIXED	
>Photometric Interpretation	0028,0004	CS	MONOCHROME2	ALWAYS	FIXED	
>Rows	0028,0010	US		ALWAYS	AUTO	
>Columns	0028,0011	US		ALWAYS	AUTO	
>Pixel Aspect Ratio	0028,0034	IS	1\1	ALWAYS	FIXED	
>Bits Allocated	0028,0100	US	8	ALWAYS	FIXED	
>Bits Stored	0028,0101	US	8	ALWAYS	FIXED	
>High Bit	0028,0102	US	7	ALWAYS	FIXED	
>Pixel Representation	0028,0103	US	0	ALWAYS	FIXED	
>Pixel Data	7FE0,0010	OW/OB		ALWAYS	AUTO	

This part of the section includes the dataset specific behavior, i.e. error codes, error and exception handling, time-outs, etc.

Table 59: Status Response

Service Status	Error Code	Further Meaning	Behavior
Success	0000	Success	The SCP has completed the operation successfully
Failure	<xxxx>	All error numbers	The error is logged and print job is marked as failure.
Warning	<xxxx>	All warning numbers	The warning is logged. Print job continue.

4.2.1.3.8.10. SOP Specific Conformance for Printer SOP Class of the Basic Grayscale Print Management Meta SOP Class

This section and sub-section include the manufacturer SOP and Dataset specific information as well the status codes and their corresponding behavior.

4.2.1.3.8.10.1. Dataset Specific Conformance for Printer SOP Class N-EVENT-REPORT Request.

The DIMSE N-EVENT-REPORT of the Printer SOP Class is not supported by Console.

4.2.1.3.8.10.2. Dataset Specific Conformance for Printer SOP Class N-GET Request.

Detail regarding the Dataset Specific response behavior will be reported in this section.

This part of the section includes the dataset specific behavior, i.e. error codes, error and exception handling, time-outs, etc.

Table 60: Status Response

Service Status	Error Code	Further Meaning	Behavior
Success	0000	Success	The SCP has completed the operation successfully
Failure	<xxxx>	Error during printing	Error is logged and print job is marked as failure.
Warning	<xxxx>	Warning during printing	Console does not react on this status and finish printing

4.2.1.4. Association Acceptance Policy

The Application Entity may reject Association attempts as shown in the table below.

Table 61: Association Rejection Policies.

Result	Source	Reason/Diagnosis	Behavior
1 - rejected permanent	1 - DICOM UL service-user	2 - application-context-name-not-supported	When receiving association request and the application context name is not supported.
		7 - called-AE-title-not-recognized	When receiving association request and the called AE title is not supported.
	2 - DICOM UL service provider (ACSE related function)	1 - no-reason-given	When receiving association request and all of the items in the presentation context item list are not supported by the system.
		2 - protocol-version-not-supported	When receiving an association request and the protocol version received is not supported.

* Remark: the Console system accepts associations from any host and from any calling AE title. It is not required to add the remote DICOM SCU node to the configuration in the Console system.

The behavior of the AE on DICOM receiving Association Abort Handling is summarized in table below:

Table 62: DICOM receiving Association Abort Handling.

Source	Reason/Diagnosis	Behavior
0 - DICOM UL service-user (initiated abort)	0 - reason-not-specified	The connection is closed.
2 - DICOM UL service-provider (initiated abort)	0 - reason-not-specified	The connection is closed.
	1 - unrecognized-PDU	The connection is closed.
	2 - unexpected-PDU	The connection is closed.
	4 - unrecognized-PDU parameter	The connection is closed.
	5 - unexpected-PDU parameter	The connection is closed.
	6 - invalid-PDU-parameter value	The connection is closed.

The behavior of the AE for sending an association abort is summarized in next table.

Table 63: Association Abort Policies.

Source	Reason/Diagnosis	Behavior
0 - DICOM UL service-user (initiated abort)	0 - reason-not-specified	When an association timeout (configurable per remote device) expired (timeout which determines how long to keep an idle association).When receiving a PDU whose size is bigger than the agreed max PDU size.
2 - DICOM UL service-provider (initiated abort)	1 - unrecognized-PDU	Whenever the system receives unexpected or unrecognized PDU (according to the DICOM UPPER LAYER PROTOCOL STATE TRANSITION TABLE in chapter 8 of the DICOM standard).

4.2.1.4.1. (Real-World) Activity – Verification as SCP

4.2.1.4.1.1. Description and Sequencing of Activities

A remote system requests verification from Console AE using the C-ECHO command.

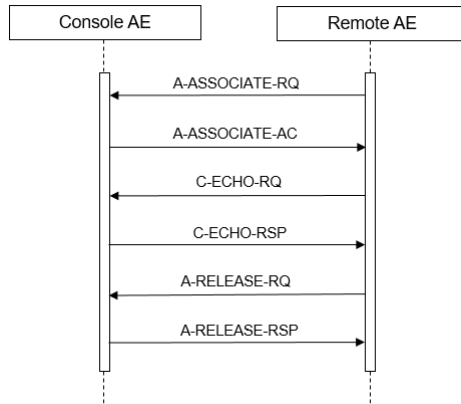

Figure 14: (Real World) Activity - Verification as SCP

4.2.1.4.1.2. Accepted Presentation Contexts

The presentation contexts are defined in the next table.

Table 64: Acceptable Presentation Contexts for (Real-World) Activity – Verification as SCP

Presentation Context Table					
Abstract Syntax		Transfer Syntax		Role	Extended Negotiation
Name	UID	Name List	UID List		
Verification SOP Class	1.2.840.10008.1.1	Implicit VR Little Endian	1.2.840.10008.1.2	SCP	None
		Explicit VR Little Endian	1.2.840.10008.1.2.1		
		Explicit VR Big Endian	1.2.840.10008.1.2.2		

4.2.1.4.1.3. SOP Specific Conformance for Verification SOP Class

The system provides standard conformance to the Verification SOP Class as an SCP.

4.2.1.4.1.3.1. Dataset Specific Conformance for Verification C-ECHO SCP

This part of the section includes the dataset specific behavior, i.e. error codes, error and exception handling, time-outs, etc.

Table 65: Status Response

Service Status	Error Code	Further Meaning	Behavior
Success	0000	Success	The C-ECHO message is successfully received.
Failure	C000	Error- Cannot Understand	In all other situation than success.

4.2.1.4.2. (Real-World) Activity – Image Import

4.2.1.4.2.1. Description and Sequencing of Activities

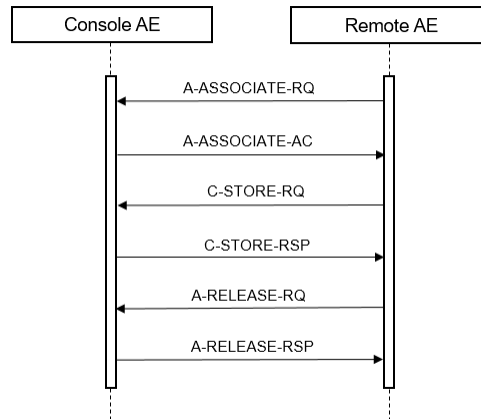

Figure 15: (Real World) Activity - Image Import

The Storage SCP function will accept images as a result of a retrieve request initiated by Eviewer and in case a remote Storage SCU node opens an association to store supported Storage SOP class objects to Eviewer.

4.2.1.4.2.2. Accepted Presentation Contexts

The presentation contexts are defined in the next table.

Table 66: Acceptable Presentation Contexts for (Real-World) Activity – Image Import

Presentation Context Table					
Abstract Syntax		Transfer Syntax		Role	Extended Negotiation
Name	UID	Name List	UID List		
CT Image Storage SOP Class	1.2.840.10008.5.1.4.1.1.2	Explicit VR Big Endian	1.2.840.10008.1.2.2	SCP	None
		Explicit VR Little Endian	1.2.840.10008.1.2.1		
		Implicit VR Little Endian	1.2.840.10008.1.2		
Secondary Capture Image Storage SOP Class	1.2.840.10008.5.1.4.1.1.7	Explicit VR Big Endian	1.2.840.10008.1.2.2	SCP	None
		Explicit VR Little Endian	1.2.840.10008.1.2.1		
		Implicit VR Little Endian	1.2.840.10008.1.2		
X-Ray Radiation Dose SR	1.2.840.10008.5.1.4.1.1.88.67	Explicit VR Big Endian	1.2.840.10008.1.2.2	SCP	None
		Explicit VR Little Endian	1.2.840.10008.1.2.1		
		Implicit VR Little Endian	1.2.840.10008.1.2		
General ECG Waveform Storage	1.2.840.10008.5.1.4.1.1.9.1.2	Explicit VR Big Endian	1.2.840.10008.1.2.2	SCP	None
		Explicit VR Little Endian	1.2.840.10008.1.2.1		
		Implicit VR Little Endian	1.2.840.10008.1.2		

The use of Explicit Little Endian transfer syntax is preferred.

4.2.1.4.2.3. SOP Specific Conformance for Storage SOP Classes

This section and sub-section include the manufacturer SOP and Dataset specific information as well the status codes and their corresponding behavior.

4.2.1.4.2.3.1. Dataset Specific Conformance for C-STORE-RSP

Detail regarding the Dataset Specific response behavior will be reported in this section.

© 2021 Koninklijke Philips N.V.

This includes the dataset specific behavior, i.e. error codes, error and exception handling, time-outs, etc.

Table 67: Status Response

Service Status	Error Code	Further Meaning	Behavior
Success	0000	Successful stored	Information is automatically updated in the patient list and series list
Failure	A700	Refused: Out of Resources	The reason is logged. Message pops up to give user the error message
	Cxxx	Error: Cannot understand	The reason is logged. Message pops up to give user the error message
	A900	Error: Data Set does not match SOP Class	The reason is logged. Message pops up to give user the error message

4.2.1.4.3. (Real-World) Activity – FIND as SCP

4.2.1.4.3.1. Description and Sequencing of Activities

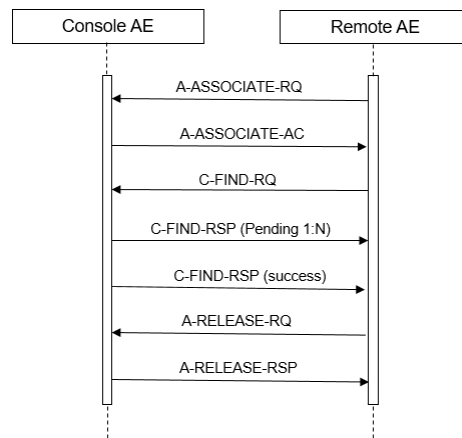

Figure 16: (Real World) Activity – FIND as SCP

The FIND SCP function will respond to query requests from a remote system. Queries are supported on STUDY, SERIES level.

4.2.1.4.3.2. Accepted Presentation Contexts

The presentation contexts are defined in the next table.

Table 68: Acceptable Presentation Contexts for (Real-World) Activity – Find as SCP

Presentation Context Table					
Abstract Syntax		Transfer Syntax		Role	Extended Negotiation
Name	UID	Name List	UID List		
Study Root QR information Model – FIND SOP Class	1.2.840.10008.5.1.4.1.2.2.1	Explicit VR Little Endian	1.2.840.10008.1.2.1	SCP	None
		Implicit VR Little Endian	1.2.840.10008.1.2		
		Explicit VR Big Endian	1.2.840.10008.1.2.2		

The use of Explicit Little Endian transfer syntax is preferred.

4.2.1.4.3.3. SOP Specific Conformance for Study Root QR Information Model – FIND SOP Class

The Console AE provides standard conformance to the Query/Retrieve service class. Relational queries are not supported. The maximum number of association requests for incoming queries that can be handled by Console AE at the same time is unlimited.

4.2.1.4.3.3.1. Dataset Specific Conformance for Study Root QR Information Model – FIND SOP Class

Console only supports hierarchical queries, starting at the top level in the Query/Retrieve Information Model, continuing until the Query/Retrieve level specified in the C-FIND request is reached.

All Required (R) and Unique (U) Study, Series level keys for the Study Root Query/Retrieve Information Model are supported.

Unsupported fields will not be returned in the C-FIND response

Supported Query Keys for Study Root Information Model

Study Root Information Model				
Attribute Name	Tag	VR	Type Of Matching	Comment
Query/Retrieve Level	0008,0052	CS	S	STUDY, SERIES, IMAGE
Specific Character Set	0008,0005	CS	NONE	Required in case non default characters are used in one of the matching values.
Study level attributes				
Study Date	0008,0020	DA	S,R,U	
Study Time	0008,0030	TM	U	
Accession Number	0008,0050	SH	S,*,U	Matching is not case sensitive
Retrieve AE Title	0008,0054	AE	NONE	
Referring Physician's Name	0008,0090	PN	*,U	
Patient's Name	0010,0010	PN	S,*,U	Matching is not case sensitive
Patient ID	0010,0020	LO	S,*,U	Matching is not case sensitive
Patient's Sex	0010,0040	CS	S,U	M, F, O (Matching is not case sensitive).
Study Instance UID	0020,000D	UI	Unique	
Study ID	0020,0010	SH	S,*,U	
Number of Study Related Series	0020,1206	IS	U	
Number of Study Related Instances	0020,1208	IS	U	
Series level attributes				
Retrieve AE Title	0008,0054	AE	NONE	
Modality	0008,0060	CS	S,*,U	
Study Instance UID	0020,000D	UI	S,L,U	
Series Instance UID	0020,000E	UI	Unique	
Series Number	0020,0011	IS	S,U	
Number of Series Related Instances	0020,1209	IS	U	

Types of Matching:

The types of Matching supported by the C-FIND SCP. An "S" indicates the identifier attribute uses Single Value Matching, an "R" indicates Range Matching, an "*" indicates wild card matching, a "U" indicates Universal Matching and "L" indicates List of UID Matching.

Table 69: Status Response

Service Status	Error Code	Further Meaning	Behavior
Success	0000	Successful stored	Matching successful

Service Status	Error Code	Further Meaning	Behavior
Failure	C000	General failure status	Whenever the find operation failed.
Failure	A900	Identifier does not match SOP class	
Cancel	FE00	Cancel	Whenever receiving a cancel request
Pending	FF00	Pending	For every C-FIND response. More responses to follow.

4.2.1.4.4. (Real-World) Activity – MOVE as SCP

4.2.1.4.4.1. Description and Sequencing of Activities

The Real World activity associated with the C-MOVE command is retrieval of images from the disk and storage of the images to a remote system using a C-STORE command. Console will issue a failure status if it is unable to process the transfer request.

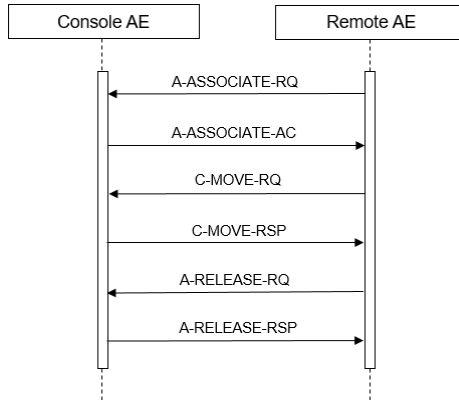

Figure 17: (Real World) Activity – MOVE as SCP

The MOVE SCP service will respond to move requests from a remote system. Retrieve operations are supported on STUDY, SERIES level.

4.2.1.4.4.2. Accepted Presentation Contexts

The presentation contexts are defined in the next table.

Table 70: Acceptable Presentation Contexts for (Real-World) Activity – MOVE as SCP

Presentation Context Table					
Abstract Syntax		Transfer Syntax		Role	Extended Negotiation
Name	UID	Name List	UID List		
Study Root QR information Model – MOVE SOP Class	1.2.840.10008.5.1.4.1.2.2.2	Explicit VR Little Endian	1.2.840.10008.1.2.1	SCP	None
		Implicit VR Little Endian	1.2.840.10008.1.2		
		Explicit VR Big Endian	1.2.840.10008.1.2.2		

The use of Explicit Little Endian transfer syntax is preferred.

4.2.1.4.4.3. SOP Specific Conformance for Study Root QR Information Model – MOVE SOP Class

The Console AE provides standard conformance to MOVE.

4.3. Network Interfaces

4.3.1. Physical Network Interfaces

The System provides only DICOM V3.0 TCP/IP Network Communication Support as defined in PS 3.8 of the standard. TCP/IP is the only protocol stack supported.

The Console inherits its TCP/IP stack from Windows 7 (i.e. the operation system platform).

The Console supports a single network interface: Ethernet ISO. 802.3 with supported physical medium include:

- IEEE 802.3-1995, 10BASE-T
- IEEE 802.3-1995, 100BASE-TX (Fast Ethernet)
- IEEE 802.3, 1000BASE-X (Fiber Optic Gigabit Ethernet).

4.3.2. Additional Protocols

Not applicable

4.4. Configuration

Any implementation's DICOM conformance may be dependent upon configuration, which takes place at the time of installation. Issues concerning configuration are addressed in this section.

4.4.1. AE Title/Presentation Address Mapping

An important installation issue is the translation from AE title to presentation address. How this is to be performed is described here.

4.4.1.1. Local AE Titles

The local AE title mapping and configuration are specified as:

Table 71: AE Title configuration table

Application Entity	Default AE Title	Default TCP/IP Port
RIS SCU (worklist + MPPS)	None	None
STORE SCU	CT	None
STORAGE COMMITMENT SCU	None	204
PRINT	None	None
QR SCU	None	None
STORE SCP	CT	104
QR SCP	None	105

4.4.1.2. Remote AE Title/Presentation Address Mapping

The configuration of the remote application is specified here.

Table 72: Defined remote parameters worklist for RIS AE

Description	Default
Worklist AE	None
Worklist Port	None
Worklist IP	None
Default showing	Show Patients Scheduled Today in HIS/RIS
Max Patient Count	200

Description	Default
Scheduled Station AE Title	Disabled
Scheduled Station Name	Disabled
Modality	Disabled

Table 73: Defined remote parameters MPPS for RIS AE

Description	Default
MPPS AE	None
MPPS Port	None
MPPS IP	None

Table 74: Defined remote parameters StorageSCP AE

Description	Default
RemoteAE	None
IP	None
Port	None
Type (QRSCP + Storage SCP, QRSCP, Storage SCP)	None
AR Timeout (s)	15
Storage commitment	
Commit Max Reply Waiting Time	0
Remote Commit AE	None
Remote Commit IP	None
Remote Commit port	0

Table 75: Defined remote parameters QRSCP AE

Description	Default
Remote AE	None
IP	None
Port	None
AR Timeout (s)	15

Table 76: Defined remote parameters DICOM SCP

Description	Default
Calling Title	None

4.4.2. Parameters

The specification of important operational parameters, their default value and range (if configurable) are specified here.

Table 77: Configuration Parameters Table

Parameter	Configurable*	Default Value
General Parameters		
Max PDU receive size	No	16384
Max PDU send size	No	131072
RIS AE Specific Parameters		
ARTim Time Out (worklist)	No	10 seconds
DIMSE Time Out (worklist)	No	20 seconds
ARTim Time Out (MPPS)	No	5 seconds
DIMSE Time Out (MPPS)	No	60 seconds
StorageSCU AE Specific Parameters		
DIMSE Time Out (storage)	No	30 seconds
ARTim Time Out (Storage Commitment)	No	10 seconds
DIMSE Time Out (storage Commitment)	No	10 seconds
QRSCU AE Specific Parameters		
DIMSE Time Out (FIND)	No	30 seconds
ARTim Time Out (MOVE)	No	10 seconds
DIMSE Time Out (MOVE)	No	7200 seconds
Storage SCP AE Specific Parameters		
ARTim Time Out	No	10 seconds
DIMSE Time Out	No	10 seconds
QRSCP AE Specific Parameters		
ARTim Time Out	No	10 seconds
DIMSE Time Out	No	10 seconds

5. Media Interchange

5.1. Implementation model

The implementation model identifies the DICOM Application Entities for Media in specific implementation and relates the Application Entities to Real-World Activities.

5.1.1. Application Data Flow Diagram

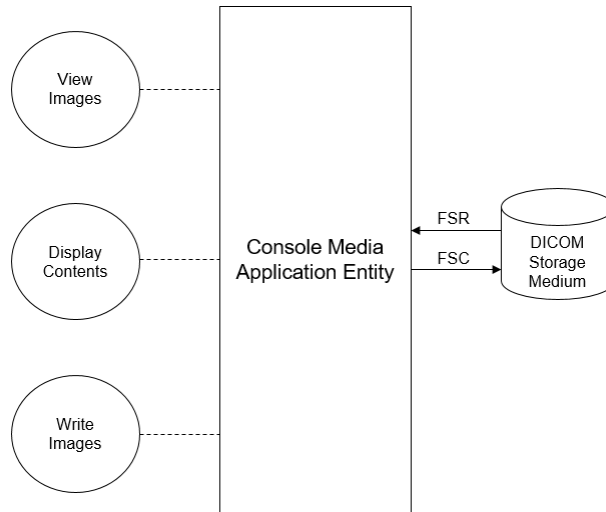

Figure 18: Media Application Data Flow Diagram

5.1.2. Functional Definitions of AE's

The Console can write and read to different media's. The DICOM Standard protocol is used for writing to CD's and DVD's. For other media their own protocol is used.

The images on the CD or DVD can be viewed on CD or DVD available viewer.
 The Console cannot update a CD or DVD. An error message will be popup.

5.1.3. Sequencing of Real World Activities

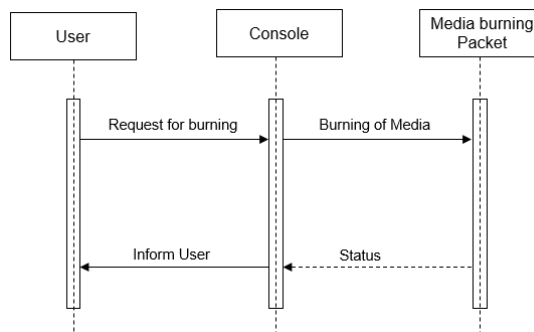

Figure 19: Sequence of Real World Activities - Media

After selection of the studies for the media the system check if the media is already used.
 An error message will be generated as popup on the screen if the media is used.

The Console check for the size on the media. All selected images must be inside the maximum size of the one media.

5.2. AE Specifications

This section in the DICOM Conformance Statement specifies a set of Media Application Entities.

5.2.1. Media Console Media - Specification

Table 78: AE media related Application Profiles, RWA activities and roles

Supported Application Profile	Identifier	Real-World Activities	Roles
General Purpose CD-R Interchange	STD-GEN-CD	Create File-set	FSC
		Read File-set	FSR

5.2.1.1. File Meta Information for the media Console

Table 79: File Meta Information for the media

Implementation Class UID	1.3.46.670589.61.1
Implementation Version Name	CHESS5_0

5.2.1.2. Real-World Activities

The AE specification contains a description of the Real-World Activities, which invoke the particular AE.

5.2.1.2.1. RWA - Read File-set

This Media Application Entity has a File-set Reader functionality which is described here.

5.2.1.2.1.1. Media Storage Application Profile

The Console uses the default "General Purpose CD-R" application profile for reading the CD or DVD.

The Console will read the CD or DVD for the "CT Image" and "Secondary Capture" SOP classes, X-Ray Radiation Dose Report and General Electrocardiogram.

Read images can be displayed with the Console viewer (except for the X-Ray Radiation Dose Report).

5.2.1.2.1.1.1. Options

The options used in the Application Profile are specified in detail in this section.

If there are no options used in the Application Profile, this section may be omitted by writing "Not applicable".

5.2.1.2.2. RWA - Create File-set

This Media Application Entity has a File-set Creator functionality which is described here.

5.2.1.2.2.1. Media Storage Application Profile

The Console write CD and DVD by using the "General Purpose CD-R Interchange" application profile.

The Console can write multiple studies and multiply patients on a single CD or DVD in one process.

Update of CD or DVD with a new study is not possible.

5.2.1.2.2.1.1. Options

Not applicable.

© 2021 Koninklijke Philips N.V.

5.2.1.2.3. RWA - Update File-set

Not supported

5.2.1.2.3.1. Media Storage Application Profile

Not supported

5.2.1.2.3.1.1. Options

Not supported

5.3. Augmented and Private Application Profiles

Not applicable

5.4. Media Configuration

Not applicable

6. Support of Character Sets

Any support for character sets beyond the default character repertoire in Network and Media services is described here.

Table 80: Supported DICOM Character Sets

Character Set Description	Defined Term	ESC Sequence	ISO Registration Number	Code Element	Character Set
GB18030	GB18030	-	-	-	-
Latin alphabet No. 1	ISO_IR 100	-	ISO-IR 6	G0	ISO 646
		-	ISO-IR 100	G1	Supplementary set of ISO 8859
Latin alphabet No. 2	ISO_IR 101	-	ISO-IR 6	G0	ISO 646
		-	ISO-IR 101	G1	Supplementary set of ISO 8859
Cyrillic	ISO_IR 144		ISO-IR 6	G0	ISO 646
			ISO-IR 144	G1	Supplementary set of ISO 8859
Unicode in UTF-8	ISO_IR 192	-	-	-	-

7. Security

7.1. Security Profiles

This version of the Console does not satisfy the security as describe in the DICOM Standard.

7.1.1. Security use Profiles

Not applicable

7.1.2. Security Transport Connection Profiles

Not applicable

7.1.3. Digital Signature Profiles

Not applicable

7.1.4. Media Storage Security Profiles

Not applicable

7.1.5. Attribute Confidentiality Profiles

The Console System conforms to the Basic Application Level Confidentiality Profile as a de-identifier without encryption. This functionality is targeted toward creating a special purpose, de-identified version of an already-existing Data Set. The de-identified SOP Instances are useful, for example, in creating teaching or research files, where the identity of the patient should be protected. The Console System does not use the Encrypted Attributes Data Set, therefore, retrieval of the original attribute values will not be possible.

Table below presents all attributes that can be de-identified by the Console System. Each Attribute to be protected has its value replaced by a different “replacement value” which does not allow identification of the patient. Integrity of dummy values for references (such as SOP Instance UID, etc.) if multiple SOP instances are protected is ensured within the scope of one job.

Note:

- The Console System does not ensure that identifying information that is burned in to the image pixel data is “blackened” (removed).
- Export of imported data might result in not completely de-identified objects.
- System retains private attributes for proper display on Philips systems.
- EMPTY as Replacement Value means the attribute is always present without any value (attribute sent zero length)

Table 81: Basic Application Level Confidentiality Profile Attributes

Attribute Name	Tag	VR	Replacement Value
Accession Number	0008,0050	SH	EMPTY
Acquisition Date	0008,0022	DA	19000101
Acquisition DateTime	0008,002A	DT	19000101000000
Acquisition Time	0008,0032	TM	000000
Admitting Diagnoses Code Sequence	0008,1084	SQ	remove attribute
Content Date	0008,0023	DA	19000101
Content Time	0008,0033	TM	000000
Contrast/Bolus Agent	0018,0010	LO	dummyString
De-identification Method Code Sequence	0012,0064	SQ	Basic Application Confidentiality Profile Clean Descriptors Option Retain Safe Private Option
Device Serial Number	0018,1000	LO	dummyString

© 2021 Koninklijke Philips N.V.

Attribute Name	Tag	VR	Replacement Value
Frame of Reference UID	0020,0052	UI	new UID
Image Comment	0020,4000	LT	EMPTY
Instance Creation Date	0008,0012	DA	19000101
Instance Creation Time	0008,0013	TM	000000
Institution Address	0008,0081	ST	remove attribute
Institution Name	0008,0080	LO	EMPTY
Institutional Department Name	0008,1040	LO	EMPTY
Irradiation Event UID	0008,3010	UI	New UID
Operators' Name	0008,1070	PN	EMPTY
Patient Comments	0010,4000	LT	EMPTY
Patient ID	0010,0020	LO	yyyymmddhhmmssSSS
Patient Identity Removed	0012,0062	CS	YES
Patient's Age	0010,1010	AS	remove attribute
Patient's Birth Date	0010,0030	DA	EMPTY
Patient's Name	0010,0010	PN	Anonymous
Patient's Sex	0010,0040	CS	EMPTY
Patient's Size	0010,1020	DS	remove attribute
Patient's Weight	0010,1030	DS	remove attribute
Performed Procedure Code Sequence	0040,A372	SQ	EMPTY
Performed Procedure Step Description	0040,0254	LO	remove attribute
Performed Procedure Step ID	0040,0253	SH	remove attribute
Performed Procedure Step Start Date	0040,0244	DA	remove attribute
Performed Procedure Step Start Time	0040,0245	TM	remove attribute
Procedure Code Sequence	0008,1032	SQ	remove attribute
Protocol Name	0018,1030	LO	EMPTY
Reason for the Requested Procedure	0040,1002	LO	remove attribute
Referenced Image Sequence	0008,1140	SQ	N/A
>Referenced SOP Class UID	0008,1150	UI	Unchanged UID
>Referenced SOP Instance UID	0008,1155	UI	new UID
Referenced Performed Procedure Step Sequence	0008,1111	SQ	remove attribute
Referenced Request Sequence	0040,A370	SQ	N/A
>Requested Procedure Code Sequence	0032,1064	SQ	EMPTY
>Reason for Requested Procedure Code Sequence	0040,100A	SQ	remove attribute
Referenced Study Sequence	0008,1110	SQ	remove attribute
Referring Physician's Name	0008,0090	PN	EMPTY
Request Attributes Sequence	0040,0275	SQ	remove attribute
Requested Procedure Description	0032,1060	LO	EMPTY
Requested Procedure ID	0040,1001	SH	remove attribute
Scheduled Procedure Step Description	0040,0007	LO	remove attribute
Series Date	0008,0021	DA	19000101
Series Description	0008,103E	LO	remove attribute
Series Time	0008,0031	TM	000000
SOP Instance UID	0008,0018	UI	new UID
Station Name	0008,1010	SH	EMPTY
Study Date	0008,0020	DA	19000101
Study Description	0008,1030	LO	remove attribute
Study ID	0020,0010	SH	dummyString
Study Time	0008,0030	TM	000000

7.1.6. Network Address Management Profiles

Not applicable

7.1.7. Time Synchronization Profiles

Not applicable

7.1.8. Application Configuration Management Profiles

Not applicable

7.1.9. Audit Trail Profiles

Not applicable

7.2. Association Level Security

Not applicable

7.3. Application Level Security

Not applicable

8. Console

8.1. IOD Contents

8.1.1. Created SOP Instance

This section specifies each IOD created by this application.

This section specifies each IOD created (including private IOD's). It should specify the attribute name, tag, VR, and value. The value should specify the range and source (e.g. user input, Modality Worklist, automatically generated, etc.). For content items in templates, the range and source of the concept name and concept values should be specified. Whether the value is always present or not shall be specified.

Abbreviations used in the IOD tables for the column "Presence of Module" are:

ALWAYS The module is always present
 CONDITIONAL The module is used under specified condition

Abbreviations used in the Module table for the column "Presence of Value" are:

ALWAYS The attribute is always present with a value
 EMPTY The attribute is always present without any value (attribute sent zero length)
 VNAP The attribute is always present and its Value is Not Always Present
 (attribute sent zero length if no value is present)
 ANAP The attribute is present under specified condition – if present then it will always have a value

The abbreviations used in the Module table for the column "Source" are:

AUTO The attribute value is generated automatically
 CONFIG The attribute value source is a configurable parameter
 COPY The attribute value source is another SOP instance
 FIXED The attribute value is hard-coded in the application
 IMPLICIT The attribute value source is a user-implicit setting
 MPPS The attribute value is the same as that use for Modality Performed Procedure Step
 MWL The attribute value source is a Modality Worklist
 USER The attribute value source is explicit user input

8.1.1.1. List of created SOP Classes

Table 82: List of created SOP Classes

SOP Class Name	SOP Class UID
CT Image Storage	1.2.840.10008.5.1.4.1.1.2
Secondary Capture Image Storage	1.2.840.10008.5.1.4.1.1.7
X-Ray Radiation Dose Report Storage	1.2.840.10008.5.1.4.1.1.88.67
General Electrocardiogram	1.2.840.10008.5.1.4.1.1.9.1.2

8.1.1.2. CT Image Storage SOP Class

Table 83: IOD of Created CT Image Storage SOP Class Instances

Information Entity	Module	Presence Of Module
Patient	Patient Module	ALWAYS
Study	General Study Module	ALWAYS
	Patient Study Module	ALWAYS
Series	General Series Module	ALWAYS

Frame of Reference	Frame of Reference Module	ALWAYS
Equipment	General Equipment Module	ALWAYS
Image	General Image Module	ALWAYS
	General Reference Module	ALWAYS
	Image Plane Module	ALWAYS
	Image Pixel Module	ALWAYS
	CT Image Module	ALWAYS
	VOI LUT Module	ALWAYS
	SOP Common Module	ALWAYS
	Contrast/Bolus Module	CONDITIONAL
	Additional Module	ALWAYS

Table 84: Patient Module

Attribute Name	Tag	VR	Value	Presence of Value	Source	Comment
Patient's Name	0010,0010	PN		ALWAYS	MWL, USER	
Patient ID	0010,0020	LO		ALWAYS	MWL, USER	
Patient's Birth Date	0010,0030	DA		VNAP	MWL, USER	
Patient's Sex	0010,0040	CS	F, M, O	ALWAYS	MWL, USER	
Patient Comments	0010,4000	LT		VNAP	MWL	

Table 85: General Study Module

Attribute Name	Tag	VR	Value	Presence of Value	Source	Comment
Study Date	0008,0020	DA		ALWAYS	AUTO	
Study Time	0008,0030	TM		ALWAYS	AUTO	
Accession Number	0008,0050	SH		VNAP	MWL, USER	
Referring Physician's Name	0008,0090	PN		VNAP	MWL, USER	
Study Description	0008,1030	LO		VNAP	MWL, USER	
Procedure Code Sequence	0008,1032	SQ		VNAP	MWL	
Study Instance UID	0020,000D	UI		ALWAYS	AUTO, MWL	
Study ID	0020,0010	SH		ALWAYS	AUTO, MWL	
Referenced Study Sequence	0008,1110	SQ		VNAP	MWL	

Table 86: Patient Study Module

Patient's Age	0010,1010	AS		VNAP	MWL, USER	
Patient's Size	0010,1020	DS		VNAP	MWL, USER	
Patient's Weight	0010,1030	DS		VNAP	MWL, USER	

Table 87: General Series Module

Attribute Name	Tag	VR	Value	Presence of Value	Source	Comment
Series Date	0008,0021	DA		ALWAYS	AUTO	
Series Time	0008,0031	TM		ALWAYS	AUTO	
Modality	0008,0060	CS	CT	ALWAYS	FIXED	
Series Description	0008,103E	LO		VNAP	USER	
Operators' Name	0008,1070	PN		VNAP	USER	
Referenced Performed Procedure Step Sequence	0008,1111	SQ		VNAP	MPPS	
Body Part Examined	0008,0015	CS		ALWAYS	AUTO	
Protocol Name	0018,1030	LO		ALWAYS	AUTO	
Patient Position	0018,5100	CS		ALWAYS	USER	
Series Instance UID	0020,000E	UI		ALWAYS	AUTO	
Series Number	0020,0011	IS		ALWAYS	AUTO	
Performed Procedure Step Start Date	0040,0244	DA		VNAP	MPPS	
Performed Procedure Step Start Time	0040,0245	TM		VNAP	MPPS	
Performed Procedure Step ID	0040,0253	SH		VNAP	MPPS	
Performed Procedure Step Description	0040,0254	LO		VNAP	MPPS	
Request Attributes Sequence	0040,0275	SQ		ALWAYS	AUTO	
>Scheduled Procedure Step ID	0040,0009	SH		ANAP	AUTO	
>Requested Procedure ID	0040,1001	SH		ANAP	AUTO	
>Reason for the Requested Procedure	0040,1002	LO		ALWAYS	AUTO	

Table 88: Frame of Reference Module

Attribute Name	Tag	VR	Value	Presence of Value	Source	Comment
Frame of Reference UID	0020,0052	UI		ALWAYS	AUTO	
Position Reference Indicator	0020,1040	LO		EMPTY		

Table 89: General Equipment Module

Attribute Name	Tag	VR	Value	Presence of Value	Source	Comment
Manufacturer	0008,0070	LO	Philips	ALWAYS	CONFIG	
Institution Name	0008,0080	LO		VNAP	CONFIG	
Institution Address	0008,0081	ST		ALWAYS	CONFIG	
Station Name	0008,1010	SH		ALWAYS	CONFIG	
Institutional Department Name	0008,1040	LO		ALWAYS	AUTO	
Manufacturer's Model Name	0008,1090	LO	Incisive CT	ALWAYS	CONFIG	
Software Version(s)	0018,1020	LO	CHESS5_0	ALWAYS	CONFIG	
Spatial Resolution	0018,1050	DS		ALWAYS	AUTO	
Device Serial Number	0018,1000	LO		VNAP	AUTO	

Table 90: General Image Module

Attribute Name	Tag	VR	Value	Presence of Value	Source	Comment
Acquisition Date	0008,0022	DA		ALWAYS	AUTO	
Content Date	0008,0023	DA		ALWAYS	AUTO	
Acquisition Time	0008,0032	TM		ALWAYS	AUTO	

Content Time	0008,0033	TM		ALWAYS	AUTO	
Irradiation Event UID	0008,3010	UI		ALWAYS	AUTO	
Instance Number	0020,0013	IS		ALWAYS	AUTO	
Acquisition number	0020,0012	IS		ALWAYS	AUTO	
Image Laterality	0020,0062	CS		ALWAYS	AUTO	
Lossy Image Compression	0028,2110	CS		ALWAYS	AUTO	

Table 91: General Reference Module

Attribute Name	Tag	VR	Value	Presence of Value	Source	Comment
Referenced Image Sequence	0008,1140	SQ		ANAP	AUTO	
>Referenced SOP Class UID	0008,1150	UI		ALWAYS	AUTO	
>Referenced SOP Instance UID	0008,1155	UI		ALWAYS	AUTO	
Source Image Sequence	0008,2112	SQ		ALWAYS	AUTO	Present ONLY for DERIVED images
>Referenced SOP Class UID	0008,1150	UI		ALWAYS	AUTO	
>Referenced SOP Instance UID	0008,1155	UI		ALWAYS	AUTO	

Table 92: Image Plane Module

Attribute Name	Tag	VR	Value	Presence of Value	Source	Comment
Slice Thickness	0018,0050	DS		ALWAYS	AUTO	
Image Position (Patient)	0020,0032	DS		ALWAYS	AUTO	
Image Orientation (Patient)	0020,0037	DS		ALWAYS	AUTO	
Slice Location	0020,1041	DS		ALWAYS	AUTO	
Pixel Spacing	0028,0030	DS		ALWAYS	AUTO	

Table 93: Image Pixel Module

Attribute Name	Tag	VR	Value	Presence of Value	Source	Comment
Rows	0028,0010	US		ALWAYS	AUTO	
Columns	0028,0011	US		ALWAYS	AUTO	
Pixel Representation	0028,0103	US	0	ALWAYS	FIXED	
Pixel Data	7FE0,0010	OW		ALWAYS	AUTO	
Bits Allocated	0028,0100	US	16	ALWAYS	FIXED	
Bits Stored	0028,0101	US	12	ALWAYS	FIXED	
High Bit	0028,0102	US	11	ALWAYS	FIXED	
Pixel Representation	0028,0103	US	0	ALWAYS	AUTO	
Pixel Data	7FE0,0010	OW		ALWAYS	AUTO	

Table 94: CT Image Module

Attribute Name	Tag	VR	Value	Presence of Value	Source	Comment
Image Type	0008,0008	CS	Value 1: ORIGINAL, Value 2: PRIMARY, Value 3: AXIAL, LOCALIZER Value 4:HELICAL	ALWAYS	AUTO	
Scan Options	0018,0022	CS		ALWAYS	AUTO	AXIAL, SURVIEW, HELICAL

KVP	0018,0060	DS		ALWAYS	USER	
Data Collection Diameter	0018,0090	DS		ALWAYS	CONFIG	
Reconstruction Diameter	0018,1100	DS		ALWAYS	AUTO	
Distance Source to Detector	0018,1110	DS		ALWAYS	CONFIG	
Distance Source to Patient	0018,1111	DS		ALWAYS	CONFIG	
Gantry/Detector Tilt	0018,1120	DS		ALWAYS	USER	
Table Height	0018,1130	DS		ALWAYS	AUTO	
Rotation Direction	0018,1140	CS	CW	ANAP	FIXED	
Exposure Time	0018,1150	IS		ALWAYS	AUTO	
X-ray Tube Current	0018,1151	IS		ALWAYS	AUTO	
Exposure	0018,1152	IS		ALWAYS	AUTO	
Filter Type	0018,1160	SH	WEDGE	ANAP	USER	
Convolution Kernel	0018,1210	SH		ALWAYS	USER	
Revolution Time	0018,9305	FD		ANAP	USER	
Table Speed	0018,9309	FD		ANAP	AUTO	
Table Feed per Rotation	0018,9310	FD		ANAP	AUTO	
Spiral Pitch Factor	0018,9311	FD		ANAP	AUTO	
Reconstruction Target Center (Patient)	0018,9318	FD		ALWAYS	AUTO	
Exposure Modulation Type	0018,9323	CS		ALWAYS	AUTO	
CTDIvol	0018,9345	FD		ALWAYS	AUTO	
CTDI Phantom Type Code Sequence	0018,9346	SQ		ALWAYS	COPY	
>Code Value	0008,0100	SH		ALWAYS	COPY	
>Coding Scheme Designator	0008,0102	SH		ALWAYS	COPY	
>Code Meaning	0008,0104	LO		ALWAYS	COPY	
Acquisition Number	0020,0012	IS		ALWAYS	AUTO	
Samples per Pixel	0028,0002	US	1	ALWAYS	FIXED	
Photometric Interpretation	0028,0004	CS	MONOCHROME2	ALWAYS	FIXED	
Bits Allocated	0028,0100	US	16	ALWAYS	FIXED	
Bits Stored	0028,0101	US	12	ALWAYS	FIXED	
High Bit	0028,0102	US	11	ALWAYS	FIXED	
Rescale Intercept	0028,1052	DS	-1024	ALWAYS	FIXED	
Rescale Slope	0028,1053	DS	1	ALWAYS	FIXED	
Rescale Type	0028,1054	LO	US	ANAP	FIXED	
Single Collimation Width	0018,9306	FD		ALWAYS	AUTO	
Total Collimation Width	0018,9307	FD		ALWAYS	AUTO	

Table 95: VOI LUT Module

Attribute Name	Tag	VR	Value	Presence of Value	Source	Comment
Window Center	0028,1050	DS		ALWAYS	AUTO	
Window Width	0028,1051	DS		ALWAYS	AUTO	

Table 96: SOP Common Module

Attribute Name	Tag	VR	Value	Presence of Value	Source	Comment
Specific Character Set	0008,0005	CS		ANAP	CONFIG, MWL	
Instance Creation Date	0008,0012	DA		ALWAYS	AUTO	
Instance Creation Time	0008,0013	TM		ALWAYS	AUTO	

SOP Class UID	0008,0016	UI	1.2.840.10008.5.1.4.1.1.2	ALWAYS	FIXED	
SOP Instance UID	0008,0018	UI		ALWAYS	AUTO	

Table 97: Contrast/Bolus Module

Attribute Name	Tag	VR	Value	Presence of Value	Source	Comment
Contrast/Bolus Agent	0018,0010	LO		ALWAYS	COPY	

Table 98: Additional Module

Attribute Name	Tag	VR	Value	Presence of Value	Source	Comment
Spacing Between Slices	0018,0088	DS		ANAP	AUTO	
XFocusCenter	0018,1183	DS		ALWAYS	USER	
YFocusCenter	0018,1184	DS		ALWAYS	USER	
Table Position	0018,9327	FD		ALWAYS	USER	

8.1.1.3. Secondary Capture Image Storage SOP Class

Table 99: IOD of Created Secondary Capture Image Storage SOP Class Instances (Dose info page)

Information Entity	Module	Presence Of Module
Patient	Patient Module	ALWAYS
Study	General Study Module	ALWAYS
	Patient Study Module	ALWAYS
Series	General Series Module	ALWAYS
Equipment	SC Equipment Module	ALWAYS
	General Equipment	ALWAYS
Image	General Image Module	ALWAYS
	Image Pixel Module	ALWAYS
	SC Image Module	ALWAYS
	SOP Common Module	ALWAYS
	VOI LUT Module	ALWAYS
	Additional Module	ALWAYS

Table 100: Patient Module

Attribute Name	Tag	VR	Value	Presence of Value	Source	Comment
Patient's Name	0010,0010	PN		ALWAYS	COPY	
Patient ID	0010,0020	LO		ALWAYS	COPY	
Patient's Birth Date	0010,0030	DA		ALWAYS	COPY	
Patient's Sex	0010,0040	CS		ALWAYS	COPY	
Ethnic Group	0010,2160	SH		EMPTY		
Patient Comments	0010,4000	LT		VNAP	COPY	

Table 101: General Study Module

Attribute Name	Tag	VR	Value	Presence of Value	Source	Comment
Study Date	0008,0020	DA		ALWAYS	COPY	
Study Time	0008,0030	TM		ALWAYS	COPY	
Accession Number	0008,0050	SH		VNAP	COPY	

Referring Physician's Name	0008,0090	PN		VNAP	COPY	
Study Instance UID	0020,000D	UI		ALWAYS	COPY	
Study ID	0020,0010	SH		ALWAYS	COPY	
Study Description	0008,1030	LO		VNAP	COPY	
Procedure Code Sequence	0008,1032	SQ		VNAP	MWL	
ReferencedStudySequence	0008,1110	SQ		VNAP	MWL	

Table 102: Patient Study Module

Attribute Name	Tag	VR	Value	Presence of Value	Source	Comment
Patient's Age	0010,1010	AS		VNAP	COPY	
Patient's Size	0010,1020	DS		VNAP	COPY	
Patient's Weight	0010,1030	DS		VNAP	COPY	

Table 103: General Series Module

Attribute Name	Tag	VR	Value	Presence of Value	Source	Comment
Series Date	0008,0021	DA		ALWAYS	AUTO	
Series Time	0008,0031	TM		ALWAYS	AUTO	
Modality	0008,0060	CS	CT	ALWAYS	FIXED	
Series Description	0008,103E	LO	Dose Info	ALWAYS	FIXED	
Series Instance UID	0020,000E	UI		ALWAYS	AUTO	
Series Number	0020,0011	IS	10001	ALWAYS	FIXED	
RequestAttributesSequence	0040,0275	SQ		ALWAYS		
> RequestedProcedureID	0040,1001	SH		ANAP	MWL	
> RequestedProcedureDescription	0032,1060	LO		VNAP	MWL	
>ScheduledProcedureStepID	0040,0009	SH		ANAP	MWL	
>ScheduledProcedureStepDescription	0040,0007	LO		VNAP	MWL	
> ScheduledProtocolCodeSequence	0040,0008	SQ		VNAP	MWL	
>> Code Value	0008,0100	SH		ANAP	MWL	
>>Coding Scheme Designator	0008,0102	SH		ANAP	MWL	
>>Code Meaning	0008,0104	LO		ANAP	MWL	
>Reason for the Requested Procedure	0040,1002	LO		VNAP	MWL	
Performed ProcedureStepID	0040,0253	SH		VNAP	MPPS	
Performed Procedure Step Description	0040,0254	LO		VNAP	MPPS	
Performed Procedure Step Start Date	0040,0244	DA		VNAP	MPPS	
Performed Procedure Step Start Time	0040,0245	TM		VNAP	MPPS	
Referenced PerformedProcedure Step Sequence	0008,1111	SQ		VNAP		
> Referenced SOP Class UID	0008,1150	UI		ANAP	MPPS	
> Referenced SOP Instance UID	0008,1155	UI		ANAP	MPPS	

Table 104: SC Equipment Module

Attribute Name	Tag	VR	Value	Presence of Value	Source	Comment
Modality	0008,0060	CS	CT	ALWAYS	COPY	
Conversion Type	0008,0064	CS	WSD	ALWAYS	FIXED	
Secondary Capture Device Manufacturer	0018,1016	LO	Philips	ALWAYS	COPY	
Secondary Capture Device Manufacturer Model Name	0018,1018	LO	Incisive CT	ALWAYS	COPY	
SecondaryCaptureDeviceSoftwareVersions	0018,1019	LO		ALWAYS	COPY	

Table 105: General Equipment Module

Attribute Name	Tag	VR	Value	Presence of Value	Source	Comment
Manufacturer	0008,0070	LO	Philips	ALWAYS	CONFIG	
Institution Name	0008,0080	LO		VNAP	CONFIG	
Institution Address	0008,0081	ST		ALWAYS	CONFIG	
Station Name	0008,1010	SH		ALWAYS	CONFIG	
Manufacturer's Model Name	0008,1090	LO	Incisive CT	ALWAYS	CONFIG	
Institutional Department Name	0008,1040	LO		ALWAYS	AUTO	
Software Version(s)	0018,1020	LO	CHESS5_0	ALWAYS	CONFIG	
Device Serial Number	0018,1000	LO		VNAP	CONFIG	

Table 106: General Image Module

Attribute Name	Tag	VR	Value	Presence of Value	Source	Comment
Image Type	0008,0008	CS	Value 1: DERIVED, Value 2: SECONDARY Value 3:DOSE_INFO	ALWAYS	FIXED	
Acquisition DateTime	0008,002A	DT		ALWAYS	AUTO	
Content Date	0008,0023	DA		ALWAYS	AUTO	
Content Time	0008,0033	TM		ALWAYS	AUTO	
Instance Number	0020,0013	IS	1	ALWAYS	FIXED	
Patient Orientation	0020,0020	CS		EMPTY		
Burned In Annotation	0028,0301	CS	NO	ALWAYS	FIXED	
Image Comments	0020,4000	LT	Dose Info	ALWAYS	FIXED	
Lossy Image Compression	0028,2110	CS		ALWAYS	AUTO	

Table 107: Image Pixel Module

Attribute Name	Tag	VR	Value	Presence of Value	Source	Comment
Samples per Pixel	0028,0002	US	1	ALWAYS	FIXED	
Photometric Interpretation	0028,0004	CS	MONOCHROME2	ALWAYS	FIXED	
Rows	0028,0010	US	512	ALWAYS	FIXED	
Columns	0028,0011	US	512	ALWAYS	FIXED	
Bits Allocated	0028,0100	US	16	ALWAYS	FIXED	
Bits Stored	0028,0101	US	12	ALWAYS	FIXED	
High Bit	0028,0102	US	11	ALWAYS	FIXED	
Pixel Representation	0028,0103	US	0	ALWAYS	FIXED	
Pixel Data	7FE0,0010	OW		ALWAYS	AUTO	

Table 108: SC Image Module

Attribute Name	Tag	VR	Value	Presence of Value	Source	Comment
Date of Secondary Capture	0018,1012	DA		ALWAYS	AUTO	
Time of Secondary Capture	0018,1014	TM		ALWAYS	AUTO	

Table 109: VOI LUT Module

Attribute Name	Tag	VR	Value	Presence of Value	Source	Comment
Window Center	0028,1050	DS	100	ALWAYS	FIXED	
Window Width	0028,1051	DS	50	ALWAYS	FIXED	

Table 110: Additional Module

Attribute Name	Tag	VR	Value	Presence of Value	Source	Comment
Distance Source to Detector	0018,1110	DS		ALWAYS	CONFIG	
Total Number of Exposures	0040,0301	US		ALWAYS	AUTO	
Comments on Radiation Dose	0040,0310	ST	Dose Info	ALWAYS	FIXED	
Exposure Dose Sequence	0040,030E	SQ		ALWAYS	AUTO	
>Series Description	0008,103E	LO		ALWAYS	AUTO	
>KVP	0018,0060	DS		ALWAYS	AUTO	
>Exposure Time	0018,1150	IS		ALWAYS	AUTO	
>Exposure	0018,1152	IS		ALWAYS	AUTO	
>Radiation Mode	0018,115A	CS		ALWAYS	AUTO	
>Filter Type	0018,1160	SH	WEDGE	ALWAYS	FIXED	
>Scan Length	0018,1302	IS		ALWAYS	AUTO	
>Filter Material	0018,7050	CS	ALUMINUM	ALWAYS	FIXED	
>X-Ray Tube Current in uA	0018,8151	DS		ALWAYS	AUTO	
>Acquisition Type	0018,9302	CS		ALWAYS	AUTO	
>Single Collimation Width	0018,9306	FD		ALWAYS	AUTO	
>Total Collimation Width	0018,9307	FD		ALWAYS	AUTO	
>Spiral Pitch Factor	0018,9311	FD		ALWAYS	AUTO	
>Estimated Dose Saving	0018,9324	FD		ALWAYS	AUTO	
>CTDIvol	0018,9345	FD		ALWAYS	AUTO	
>Series Number	0020,0011	IS		ALWAYS	AUTO	

Table 111: SOP Common Module

Attribute Name	Tag	VR	Value	Presence of Value	Source	Comment
Specific Character Set	0008,0005	CS		ANAP	AUTO	
SOP Class UID	0008,0016	UI	1.2.840.10008.5.1.4.1.1.7	ALWAYS	FIXED	
SOP Instance UID	0008,0018	UI		ALWAYS	AUTO	
Instance Number	0020,0013	IS	1	ALWAYS	FIXED	

8.1.1.4. X-Ray Radiation Dose Report Storage SOP Class

Table 112: IOD of Created X-Ray Radiation Dose Report Storage SOP instance (Dose info page)

Information Entity	Module	Presence Of Module
Patient	Patient Module	ALWAYS
Study	General Study Module	ALWAYS
Study	Patient Study Module	ALWAYS
Series	SR Document Series Module	ALWAYS

Equipment	General Equipment Module	ALWAYS
Equipment	Enhanced General Equipment	ALWAYS
Document	SR Document General Module	ALWAYS
Document	SR Document Content	ALWAYS
Document	SOP Common Module	ALWAYS

Table 113: Patient Module

Attribute Name	Tag	VR	Value	Presence of Value	Source	Comment
Patient's Name	0010,0010	PN		ALWAYS	COPY	
Patient ID	0010,0020	LO		ALWAYS	COPY	
Patient's Birth Date	0010,0030	DA		VNAP	COPY	
Patient's Sex	0010,0040	CS		ALWAYS	COPY	
Patient Comments	0010,4000	LT		VNAP	COPY	

Table 114: General Study Module

Attribute Name	Tag	VR	Value	Presence of Value	Source	Comment
Study Date	0008,0020	DA		ALWAYS	COPY	
Study Time	0008,0030	TM		ALWAYS	COPY	
Accession Number	0008,0050	SH		VNAP	COPY	
Referring Physician's Name	0008,0090	PN		VNAP	COPY	
Study Description	0008,1030	LO		VNAP	COPY	
Study Instance UID	0020,000D	UI		ALWAYS	COPY	
Study ID	0020,0010	SH		ALWAYS	COPY	

Table 115: Patient Study Module

Attribute Name	Tag	VR	Value	Presence of Value	Source	Comment
Admitting Diagnoses Description	0008,1080	LQ		ALWAYS	COPY	
Admitting Diagnoses Code Sequence	0008,1084	SQ		ALWAYS	COPY	
Patient's Age	0010,1010	AS		ALWAYS	COPY	
Patient's Size	0010,1020	DS		ALWAYS	COPY	
Patient's Weight	0010,1030	DS		ALWAYS	COPY	

Table 116: SR Document Series Module

Attribute Name	Tag	VR	Value	Presence of Value	Source	Comment
Modality	0008,0060	CS	SR	ALWAYS	FIXED	
Series Description	0008,103E	LO	Dose SR	ALWAYS	FIXED	
Referenced Performed Procedure Step Sequence	0008,1111	SQ		VNAP	COPY	
Series Instance UID	0020,000E	UI		ALWAYS	AUTO	
Series Number	0020,0011	IS	10002	ALWAYS	FIXED	

Table 117: General Equipment Module

Attribute Name	Tag	VR	Value	Presence of Value	Source	Comment
Manufacturer	0008,0070	LO	Philips	ALWAYS	FIXED	
Institution Name	0008,0080	LO		VNAP	COPY	
Institution Address	0008,0081	ST		VNAP	COPY	
Station Name	0008,1010	SH		VNAP	COPY	

Manufacturer's Model Name	0008,1090	LO	Incisive CT	ALWAYS	COPY	
Device Serial Number	0018,1000	LO		VNAP	CONFIG	
Software Version(s)	0018,1020	LO	CHESS5_0	ALWAYS	COPY	

Table 118: Enhanced General Equipment Module

Attribute Name	Tag	VR	Value	Presence of Value	Source	Comment
Manufacturer	0008,0070	LO	Philips	ALWAYS	COPY	
Manufacturer's Model Name	0008,1090	LO	Incisive CT	ALWAYS	COPY	
Device Serial Number	0018,1000	LO		VNAP	CONFIG	
Software Version(s)	0018,1020	LO	CHESS5_0	ALWAYS	COPY	

Table 119: SR Document General Module

Attribute Name	Tag	VR	Value	Presence of Value	Source	Comment
Content Date	0008,0023	DA		ALWAYS	AUTO	
Content Time	0008,0033	TM		ALWAYS	AUTO	
Instance Number	0020,0013	IS	1	ALWAYS	FIXED	
Referenced Request Sequence	0040,A370	SQ				
>Accession Number	0008,0050	SH		VNAP	COPY	
>Referenced Study Sequence	0008,1110	SQ		VNAP	COPY	
>Study Instance UID	0020,000D	UI		ALWAYS	COPY	
>Requested Procedure Description	0032,1060	LO		VNAP	COPY	
>Requested Procedure Code Sequence	0032,1064	SQ		VNAP	COPY	
>Requested Procedure ID	0040,1001	SH		ALWAYS	COPY	
>Placer Order Number/Imaging Service Request	0040,2016	LO		VNAP	COPY	
>Filler Order Number/Imaging Service Request	0040,2017	LO		VNAP	COPY	
Performed Procedure Code Sequence	0040,A372	SQ		VNAP	COPY	
Completion Flag	0040,A491	CS	COMPLETE	ALWAYS	FIXED	
Verification Flag	0040,A493	CS	UNVERIFIED	ALWAYS	FIXED	

Table 120: SR Document Content Module

Attribute Name	Tag	VR	Value	Presence of Value	Source	Comment
Value Type	0040,A040	CD	CONTAINER	ALWAYS	FIXED	
Concept Name Code Sequence	0040,A043	SQ		ALWAYS	AUTO	
>Code Value	0008,0100	SH	113701	EMPTY	AUTO	
>Coding Scheme Designator	0008,0102	SH	DCM	EMPTY	AUTO	
>Code Meaning	0008,0104	LO	X-Ray Radiation Dose Report	EMPTY	AUTO	
Continuity Of Content	0040,A050	CS	SEPARATE	ALWAYS	AUTO	
Content Template Sequence	0040,A504	SQ		ALWAYS	FIXED	
>Mapping Resource	0008,0105	CS	DCMR	ALWAYS	FIXED	
>Template Identifier	0040,DB00	CS	TID 10011	ALWAYS	FIXED	
Content Sequence	0040,A730	SQ		ALWAYS	AUTO	

Table 121: SOP Common Module

Attribute Name	Tag	VR	Value	Presence of Value	Source	Comment
Specific Character Set	0008,0005	CS		ANAP	COPY	

Instance Creation Date	0008,0012	DA		ALWAYS	AUTO	
Instance Creation Time	0008,0013	TM		ALWAYS	AUTO	
SOP Class UID	0008,0016	UI	1.2.840.10008.5.1.4. 1.1.88.67	ALWAYS	FIXED	
SOP Instance UID	0008,0018	UI		ALWAYS	AUTO	
Instance Number	0020,0013	IS	1	ALWAYS	FIXED	

8.1.1.5. General ECG Waveform Storage SOP Class

Table 122: IOD of Created General ECG Waveform Storage SOP Class Instances

Information Entity	Module	Presence Of Module
Patient	Patient Module	ALWAYS
Study	General Study Module	ALWAYS
Study	Patient Study Module	ALWAYS
Series	General Series Module	ALWAYS
Equipment	General Equipment Module	ALWAYS
Waveform	Acquisition Context Module	ALWAYS
Waveform	Waveform Identification Module	ALWAYS
Waveform	Waveform Module	ALWAYS
Waveform	SOP Common Module	ALWAYS

Table 123: Patient Module

Attribute Name	Tag	VR	Value	Presence of Value	Source	Comment
Patient's Name	0010,0010	PN		VNAP	COPY	
Patient ID	0010,0020	LO		VNAP	COPY	
Patient's Birth Date	0010,0030	DA		VNAP	COPY	
Patient's Sex	0010,0040	CS		VNAP	COPY	

Table 124: General Study Module

Attribute Name	Tag	VR	Value	Presence of Value	Source	Comment
Study Date	0008,0020	DA		VNAP	COPY	
Study Time	0008,0030	TM		VNAP	COPY	
Accession Number	0008,0050	SH		VNAP	COPY	
Referring Physician's Name	0008,0090	PN		VNAP	COPY	
Study Description	0008,1030	LO		ANAP	COPY	
Procedure Code Sequence	0008,1032	SQ		VNAP	COPY	
>Referenced Study Sequence	0008,1110	SQ		VNAP	COPY	
Study Instance UID	0020,000D	UI		ALWAYS	COPY	
Study ID	0020,0010	SH		VNAP	COPY	

Table 125: Patient Study Module

Attribute Name	Tag	VR	Value	Presence of Value	Source	Comment
Patient's Age	0010,1010	AS		VNAP	COPY	
Patient's Size	0010,1020	DS		VNAP	COPY	
Patient's Weight	0010,1030	DS		VNAP	COPY	

Table 126: General Series Module

Attribute Name	Tag	VR	Value	Presence of Value	Source	Comment
Series Date	0008,0021	DA		ALWAYS	AUTO	
Series Time	0008,0031	TM		ALWAYS	AUTO	
Modality	0008,0060	CS	"ECG"	ALWAYS	FIXED	
Series Description	0008,103E	LO		ALWAYS	AUTO	
Referenced Performed Procedure Step Sequence	0008,1111	SQ		VNAP	COPY	
Body Part Examined	0018,0015	CS	HEART	ALWAYS ALWAYS	FIXED	
Protocol Name	0018,1030	LO		ALWAYS	COPY	
Patient Position	0018,5100	CS		ALWAYS	COPY	
Series Instance UID	0020,000E	UI		ALWAYS	AUTO	
Series Number	0020,0011	IS		ALWAYS	AUTO	
RequestAttributesSequence	0040,0275	SQ		ALWAYS	MWL	
> RequestedProcedureID	0040,1001	SH		ANAP	MWL	
> RequestedProcedureDescription	0032,1060	LO		VNAP	MWL	
>ScheduledProcedureStepID	0040,0009	SH		ANAP	MWL	
>ScheduledProcedureStepDescription	0040,0007	LO		VNAP	MWL	
> ScheduledProtocolCodeSequence	0040,0008	SQ		VNAP	MWL	
>> Code Value	0008,0100	SH		ANAP	MWL	
>>Coding Scheme Designator	0008,0102	SH		ANAP	MWL	
>>Code Meaning	0008,0104	LO		ANAP	MWL	
Performed ProcedureStepID	0040,0253	SH		VNAP	MPPS	
Performed Procedure Step Description	0040,0254	LO		VNAP	MPPS	
Performed Procedure Step Start Date	0040,0244	DA		VNAP	MPPS	
Performed Procedure Step Start Time	0040,0245	TM		VNAP	MPPS	

Table 127: General Equipment Module

Attribute Name	Tag	VR	Value	Presence of Value	Source	Comment
Manufacturer	0008,0070	LO	Philips	ALWAYS	FIXED	
Institution Name	0008,0080	LO		VNAP	USER	
Institution Address	0008,0081	ST		VNAP	USER	
Station Name	0008,1010	SH		VNAP	USER	
Manufacturer's Model Name	0008,1090	LO	Incisive CT	ALWAYS	FIXED	
Software Version(s)	0018,1020	LO	CHESS5_0	ALWAYS	AUTO	.

Table 128: Acquisition Context Module

Attribute Name	Tag	VR	Value	Presence of Value	Source	Comment
Acquisition Context Sequence	0040,0555	SQ		EMPTY		

Table 129: Waveform Identification Module

Attribute Name	Tag	VR	Value	Presence of Value	Source	Comment
Content Date	0008,0023	DA		ALWAYS	AUTO	
Acquisition Datetime	0008,002A	DT		ALWAYS	AUTO	
Content Time	0008,0033	TM		ALWAYS	AUTO	
Instance Number	0020,0013	IS		ALWAYS	AUTO	

Table 130: Waveform Module

Attribute Name	Tag	VR	Value	Presence of Value	Source	Comment
Waveform Sequence	5400,0100	SQ		ALWAYS		
>Waveform Originality	003A,0004	CS	ORIGINAL	ALWAYS	FIXED	
>Number of Waveform Channels	003A,0005	US	1	ALWAYS	FIXED	
>Number of Waveform Samples	003A,0010	UL		ALWAYS	AUTO	
>Sampling Frequency	003A,001A	DS		ALWAYS	AUTO	
>Channel Definition Sequence	003A,0200	SQ		ALWAYS		
>>Channel Source Sequence	003A,0208	SQ		ALWAYS		
>>>Code Value	0008,0100	SH	2:2	ALWAYS	FIXED	
>>>Coding Scheme Designator	0008,0102	SH	MDC	ALWAYS	FIXED	
>>>Code Meaning	0008,0104	LO	Lead II	ALWAYS	FIXED	
>>Channel Sample Skew	003A,0215	DS	0	ALWAYS	FIXED	
>>Waveform Bits Stored	003A,021A	US	13	ALWAYS	FIXED	
>Waveform Bits Allocated	5400,1004	US	16	ALWAYS	FIXED	
>Waveform Sample Interpretation	5400,1006	CS	SS	ALWAYS	FIXED	
>Waveform Data	5400,1010	OW	IN FILE	ALWAYS		

Table 131: SOP Common Module

Attribute Name	Tag	VR	Value	Presence of Value	Source	Comment
Specific Character Set	0008,0005	CS		ANAP	COPY	
SOP Class UID	0008,0016	UI	1.2.840.10008.5.1.4.1.1.9.1.2	ALWAYS	FIXED	
SOP Instance UID	0008,0018	UI		ALWAYS	AUTO	
Instance Number	0020,0013	IS		ALWAYS	AUTO	

8.1.2. Usage of Attributes from Received IOD

Table 132: Functionalities

Functionality	Type1	Optional	Private
Viewer	X		

8.1.2.1. Usage of the Functionality Viewer

The following table lists the supported SOP Classes which can be used by this application.

Table 133: Supported SOP Classes for functionality Viewer

SOP Class name	SOP Class UID
CT Image Storage SOP Class	1.2.840.10008.5.1.4.1.1.2
Secondary Capture Image Storage SOP Class	1.2.840.10008.5.1.4.1.1.7
X-Ray Radiation Dose SR	1.2.840.10008.5.1.4.1.1.88.67
General ECG Waveform Storage SOP Class	1.2.840.10008.5.1.4.1.1.9.1.2

8.1.3. Attribute Mapping

In this section the mapping between the Modality Worklist, Storage and Modality Performed Procedure Step is specified.

Table 134: Attribute mapping during Modality Workflow

Name	WLM tag	MPPS Create tag	MPPS Set tag	Image IOD tag
Specific Character Set	0008,0005	0008,0005		0008,0005
Accession Number	0008,0050	0008,0050		0008,0050
Referring Physician's Name	0008,0090			0008,0090
Modality		0008,0060		0008,0060
Series Description			0008,103E	0008,103E
Protocol Name			0018,1030	0008,1030
Operator's Name			0008,1070	0008,1070
Patient's Name	0010,0010	0010,0010		0010,0010
Patient ID	0010,0020	0010,0020		0010,0020
Patient's Birth Date	0010,0030	0010,0030		0010,0030
Patient Sex	0010,0040	0010,0040		0010,0040
Patient's Size	0010,1020			0010,1020
Patient Comments	0010,4000			0010,4000
Study Instance UID	0020,000D	0020,000D		0020,000D
Series Instance UID			0020,000E	0020,000E
Scheduled Procedure Step Description	0040,0007	0040,0007 0040,0254	0040,0254	0008,1030 0040,0007 0040,0254
Scheduled Procedure Step ID	0040,0009	0040,0009 0040,0253		0040,0009 0040,0253
Requested Procedure ID	0040,1001	0020,0010 0040,1001		0020,0010 0040,1001
Requested Procedure Description	0032,1060	0032,1060		0032,1060
Referenced Study Sequence	0008,1110	0008,1110		0008,1110
Scheduled Protocol Code Sequence	0040,0008	0040,0008		0040,0008
Requested Procedure Code Sequence	0032,1064	0008,1032	0008,1032	0008,1032
Performed Procedure Step Start Date		0040,0244		0040,0244
Performed Procedure Step Start Time		0040,0245		0040,0245
Referenced SOP Class UID			0008,1150	0008,0016
Referenced SOP Instance UID			0008,1155	0008,0018

8.1.4. Coerced/Modified fields

Not applicable

8.2. Data Dictionary of Private Attributes

Not applicable

8.3. Coded Terminology and Templates

This application supports the following Coded Terminology and templates as described in the sub-sections.

8.3.1. Context Groups

Not supported.

8.3.2. Template Specifications

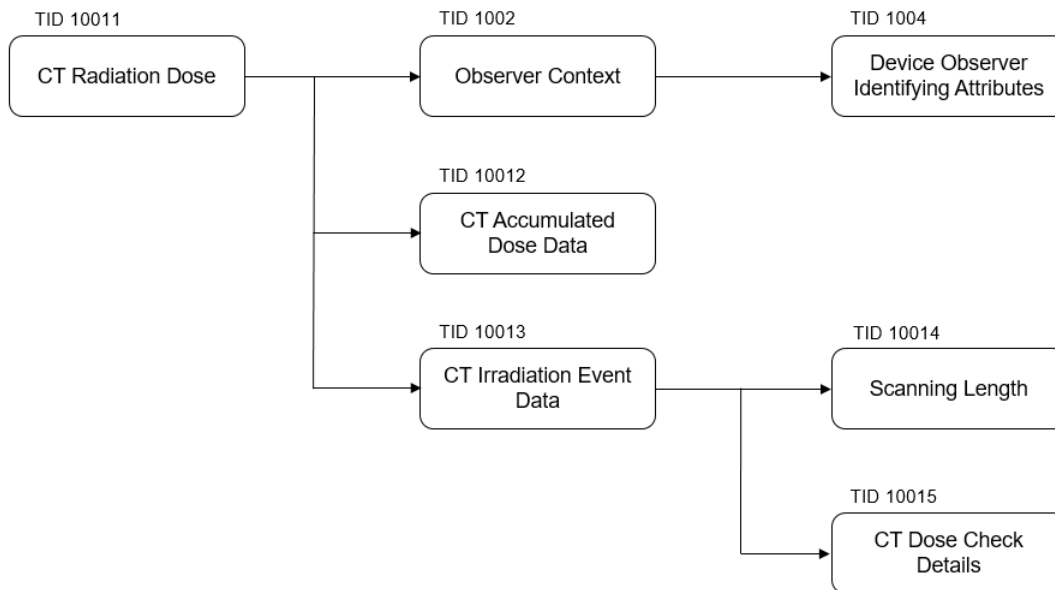

Figure 20: X-Ray Radiation Dose SR IOD Template Structure

This section describes the content of all the templates used in the X-Ray Radiation Dose Reporting SR.

Table 135: Used Templates for X-Ray Radiation Dose Reporting

Template Name	Template ID
CT Radiation Dose	TID 10011
CT Accumulated Dose Data	TID 10012
CT Irradiation Event Data	TID 10013
Scanning Length	TID 10014
CT Dose Check Details	TID 10015
Observer Context	TID 1002
Device Observer Identifying Attributes	TID 1004

8.3.2.1. TID 10011 CT Radiation Dose

Table 136: CT Radiation Dose

NL	Relation with Parent	Concept Name	VT	VM	Presence of Value	Value
		X-Ray Radiation Dose Report		1	ALWAYS	
>	HAS CONCEPT MOD	Procedure reported	CODE	1	ALWAYS	Computed Tomography X-Ray
>>	HAS CONCEPT MOD	Has Intent	CODE	1	ALWAYS	Diagnostic Intent
>		DTID (1002) Observer Context	INCLUDE	1	ALWAYS	
>	HAS OBS CONTEXT	Start of X-Ray Irradiation	DATETIME	1	ALWAYS	
>	HAS OBS CONTEXT	End of X-Ray Irradiation	DATETIME	1	ALWAYS	
>	HAS OBS CONTEXT	Scope of Accumulation	CODE	1	ALWAYS	Study
>>	HAS PROPERTIES	Study Instance UID	UIDREF	1	ALWAYS	
>	CONTAINS	DTID (10012) CT Accumulated Dose Data	INCLUDE	1	ALWAYS	
>	CONTAINS	DTID (10013) CT Irradiation Event Data	INCLUDE	1	ALWAYS	
>	CONTAINS	X-Ray Source Data Available	CODE	1	ALWAYS	Yes
>	CONTAINS	DTID (10003) Irradiation Event X-Ray Data	INCLUDE	1-n	ALWAYS	
>	CONTAINS	Source of Dose Information	CODE	1	ALWAYS	Automated Data Collection

8.3.2.2. TID 10012 CT Accumulated Dose Data

Table 137: CT Accumulated Dose Data

NL	Relation with Parent	Concept Name	VT	VM	Presence of Value	Value
		CT Accumulated Dose Data	CONTAINER	1	ALWAYS	
>	CONTAINS	Total Number of Irradiation Events	NUM	1	ALWAYS	
>	CONTAINS	CT Dose Length Product Total	NUM	1	ALWAYS	

8.3.2.3. TID 10013 CT Irradiation Event Data

Table 138: CT Irradiation Event Data

NL	Relation with Parent	Concept Name	VT	VM	Presence of Value	Value
		CT Acquisition	CONTAINER	1	ALWAYS	
>	CONTAINS	Acquisition Protocol	TEXT	1	ALWAYS	
>	CONTAINS	Target Region	CODE	1	ALWAYS	
>	CONTAINS	CT Acquisition Type	CODE	1	ALWAYS	

>	CONTAINS	Procedure Context	CODE	1	CONDITIONAL	
>	CONTAINS	Irradiation Event UID	UIDREF	1	ALWAYS	
>	CONTAINS	CT Acquisition Parameters	CONTAINER	1	ALWAYS	
>>	CONTAINS	Exposure Time	NUM	1	ALWAYS	
>>	CONTAINS	DTID (10014) Scanning Length	INCLUDE	1	ALWAYS	
>>	CONTAINS	Nominal Single Collimation Width	NUM	1	ALWAYS	
>>	CONTAINS	Nominal Total Collimation Width	NUM	1	ALWAYS	
>>	CONTAINS	Number of X-Ray Sources	NUM	1	ALWAYS	
>>	CONTAINS	CT X-Ray Source Parameters	CONTAINER	1-n	ALWAYS	
>>>	CONTAINS	Identification of the X-Ray Source	TEXT	1	ALWAYS	
>>>	CONTAINS	KVP	NUM	1	ALWAYS	
>>>	CONTAINS	Maximum X-Ray Tube Current	NUM	1	ALWAYS	
>>>	CONTAINS	X-Ray Tube Current	NUM	1	ALWAYS	
>>	CONTAINS	Mean CTDIvol	NUM	1	ALWAYS	
>>	CONTAINS	CTDIw Phantom Type	CODE	1	ALWAYS	
>>	CONTAINS	DLP	NUM	1	ALWAYS	

8.3.2.4. TID 10014 Scanning Length

Table 139: Scanning Length

NL	Relation with Parent	Concept Name	VT	VM	Presence of Value	Value
	CONTAINS	Scanning Length	NUM	1	ALWAYS	

8.3.2.5. TID 10015 CT Dose Check Details

Table 140: CT Dose Check Details

NL	Relation with Parent	Concept Name	VT	VM	Presence of Value	Value
	CONTAINER	Dose Check Alert Details	NUM	1	CONDITIONAL	
>	CONTAINS	DLP Alert Value Configured	CODE	1	ALWAYS	
>	CONTAINS	CTDIvol Alert Value Configured	CODE	1	ALWAYS	
>	CONTAINS	DLP Alert Value	NUM	1	CONDITIONAL	
>	CONTAINS	CTDIvol Alert Value	NUM	1	CONDITIONAL	
>	CONTAINS	DLP Notification Value Configured	CODE	1	ALWAYS	
>	CONTAINS	CTDIvol Notification Value Configured	CODE	1	ALWAYS	
>	CONTAINS	DLP Notification Value	NUM	1	ALWAYS	
>	CONTAINS	CTDIvol Notification Value	NUM	1	ALWAYS	
>	CONTAINS	DLP Forward Estimate	NUM	1	ALWAYS	

>	CONTAINS	Reason for Proceeding	TEXT	USER CONDITIONAL	
---	----------	-----------------------	------	---------------------	--

8.3.2.6. TID 1002 Observer Context

Table 141: Observer Context

NL	Relation with Parent	Concept Name	VT	VM	Presence of Value	Value
>	HAS OBS CONTEXT	Observer Type	CODE	1	CONDITIONAL	Device
	HAS OBS CONTEXT	DTID (1004) Device observer identifying attributes	INCLUDE	1	CONDITIONAL	

8.3.2.7. TID 1004 Device Observer Identifying Attributes

Table 142: Device Observer Identifying Attributes

NL	Relation with Parent	Concept Name	VT	VM	Presence of Value	Value
>	HAS OBS CONTEXT	Device Observer UID	UIDREF	1	ALWAYS	
>	HAS OBS CONTEXT	Device Observer Name	TEXT	1	ALWAYS	Station Name (0008,1010)
>	HAS OBS CONTEXT	Device Observer Manufacturer	TEXT	1	ALWAYS	Manufacturer (0008,0070): Philips
>	HAS OBS CONTEXT	Device Observer Model Name	TEXT	1	ALWAYS	Manufacturer's Model Name (0008,1090): Incisive CT
>	HAS OBS CONTEXT	Device Observer Serial Number	TEXT	1	ALWAYS	Device Serial Number (0018,1000)
>	HAS OBS CONTEXT	Device Observer Physical Location	TEXT	1	ALWAYS	

8.3.3. Private code definitions

Not applicable

8.4. Grayscale Image consistency

Not applicable

8.5. Standard Extended/Specialized/Private SOPs

Not applicable

8.6. Private Transfer Syntaxes

Not applicable