DICOM

Conformance Statement

MX 16-slice



Issued by:
Philips Healthcare

P.O. Box 10.000
5680 DA Best
The Netherlands

Email: dicom@philips.com
Internet: [http:// www.philips.com/connectivity](http://www.philips.com/connectivity)

Document Number: ICAP-PF.0024612
Date: 12-July-2016

1. DICOM CONFORMANCE STATEMENT OVERVIEW

This conformance statement refers to the MX 16-slice Workspace, Philips' CT user environment for scanning a visualization.
 All MX 16-slice workspace users enjoy the same easy to use interface and access to advanced CT applications.

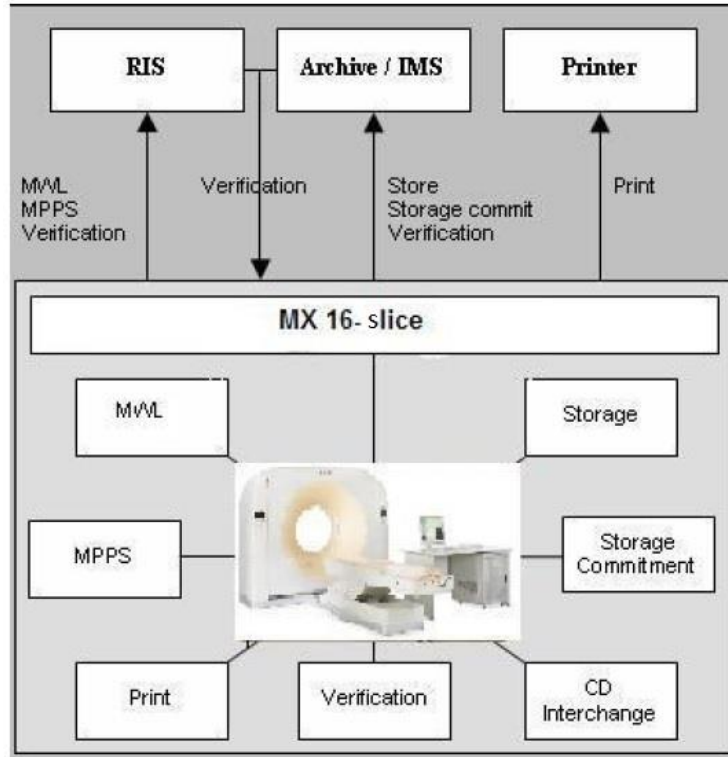

Figure 1: MX 16-slice in a DICOM Network

A table of supported Network DICOM Service (SOP) Classes is provided with roles (User/Provider)

Table 1: Network Services

SOP Class		User of Service (SCU)	Provider of Service (SCP)
Name	UID		
Other			
Verification SOP Class	1.2.840.10008.1.1	Yes	Yes
Print Management			
Basic Color Print Management Meta SOP Class	1.2.840.10008.5.1.1.18	Yes	No
>Basic Color Image Box SOP Class	1.2.840.10008.5.1.1.4.1	Yes	No
>Basic Film Box SOP Class	1.2.840.10008.5.1.1.2	Yes	No
>Basic Film Session SOP Class	1.2.840.10008.5.1.1.1	Yes	No
>Printer SOP Class	1.2.840.10008.5.1.1.16	Yes	No
Basic Grayscale Print Management Meta SOP Class	1.2.840.10008.5.1.1.9	Yes	No
>Basic Film Box SOP Class	1.2.840.10008.5.1.1.2	Yes	No

SOP Class		User of Service (SCU)	Provider of Service (SCP)
Name	UID		
>Basic Film Session SOP Class	1.2.840.10008.5.1.1.1	Yes	No
>Basic Grayscale Image Box SOP Class	1.2.840.10008.5.1.1.4	Yes	No
>Printer SOP Class	1.2.840.10008.5.1.1.16	Yes	No
Query/Retrieve			
Study Root QR Information Model - FIND SOP Class	1.2.840.10008.5.1.4.1.2.2.1	Yes	No
Study Root QR Information Model - MOVE SOP Class	1.2.840.10008.5.1.4.1.2.2.2	Yes	No
Transfer			
CT Image Storage SOP Class	1.2.840.10008.5.1.4.1.1.2	Yes	Yes
Secondary Capture Image Storage SOP Class	1.2.840.10008.5.1.4.1.1.7	Yes	Yes
Workflow Management			
Modality Performed Procedure Step SOP Class	1.2.840.10008.3.1.2.3.3	Yes	No
Modality Worklist Information Model - FIND SOP Class	1.2.840.10008.5.1.4.31	Yes	No
Storage Commitment Push Model SOP Class	1.2.840.10008.1.20.1	Yes	No

The MX 16-slice can write to different media as:

- CD-R
- DVD (-+)
- DVD-RW (-+)
- USB
- RAM-DISK
- Network

Only CD-R, DVD, DVD-RW are using a DICOM Conform layout. In session 5 there is a full description given of the used media.

A table of Supported Media Storage Application Profiles (with roles) is provided.

Table 2: Media Services

Media Storage Application Profile	File-set Creator (FSC)	File-set Updater (FSU)	File-set Reader (FSR)	Display Directory (DD)
Compact Disk-Recordable				
General Purpose CD-R Interchange	Yes	No	Yes	No

2. TABLE OF CONTENTS

1.	DICOM CONFORMANCE STATEMENT OVERVIEW	3
2.	TABLE OF CONTENTS	5
3.	INTRODUCTION	8
3.1.	REVISION HISTORY	8
3.2.	AUDIENCE	8
3.3.	REMARKS.....	8
3.4.	DEFINITIONS, TERMS AND ABBREVIATIONS	9
3.5.	REFERENCES	10
4.	NETWORKING	11
4.1.	IMPLEMENTATION MODEL	11
4.1.1.	Application Data Flow	11
4.1.2.	Functional Definition of AE's	12
4.1.2.1.	Functional Definition of DICOM SCP	12
4.1.2.2.	Functional Definition of Print	12
4.1.2.3.	Functional Definition of QRSCU.....	13
4.1.2.4.	Functional Definition of RIS.....	13
4.1.2.5.	Functional Definition of StorageSCU	13
4.1.3.	Sequencing of Real World Activities	13
4.2.	AE SPECIFICATIONS	16
4.2.1.	DICOM SCP	16
4.2.1.1.	SOP Classes	16
4.2.1.2.	Association Policies	16
4.2.1.2.1.	General	16
4.2.1.2.2.	Number of Associations	16
4.2.1.2.3.	Asynchronous Nature	17
4.2.1.2.4.	Implementation Identifying Information.....	17
4.2.1.2.5.	Communication Failure Handling.....	17
4.2.1.3.	Association Initiation Policy.....	17
4.2.1.4.	Association Acceptance Policy	18
4.2.1.4.1.	(Real-World) Activity – Verification as SCP.....	18
4.2.1.4.2.	(Real-World) Activity – Image Import.....	20
4.2.2.	Print	22
4.2.2.1.	SOP Classes	22
4.2.2.2.	Association Policies	22
4.2.2.2.1.	General	22
4.2.2.2.2.	Number of Associations	22
4.2.2.2.3.	Asynchronous Nature	23
4.2.2.2.4.	Implementation Identifying Information.....	23
4.2.2.2.5.	Communication Failure Handling.....	23
4.2.2.3.	Association Initiation Policy.....	23
4.2.2.3.1.	(Real-World) Activity – Print Management As SCU.....	23
4.2.2.4.	Association Acceptance Policy	34
4.2.3.	QRSCU	35
4.2.3.1.	SOP Classes	35
4.2.3.2.	Association Policies	35
4.2.3.2.1.	General	35
4.2.3.2.2.	Number of Associations	35
4.2.3.2.3.	Asynchronous Nature	36
4.2.3.2.4.	Implementation Identifying Information.....	36
4.2.3.2.5.	Communication Failure Handling.....	36
4.2.3.3.	Association Initiation Policy.....	36
4.2.3.3.1.	(Real-World) Activity – Verification as SCU.....	36
4.2.3.3.2.	(Real-World) Activity – FIND As SCU.....	38
4.2.3.3.3.	(Real-World) Activity – MOVE As SCU.....	41
4.2.3.4.	Association Acceptance Policy	43
4.2.4.	RIS	44
4.2.4.1.	SOP Classes	44

4.2.4.2.	Association Policies	44
4.2.4.2.1.	General	44
4.2.4.2.2.	Number of Associations	44
4.2.4.2.3.	Asynchronous Nature	45
4.2.4.2.4.	Implementation Identifying Information	45
4.2.4.2.5.	Communication Failure Handling	45
4.2.4.3.	Association Initiation Policy	45
4.2.4.3.1.	(Real-World) Activity – Verification as SCU	45
4.2.4.3.2.	(Real-World) Activity – Modality worklist As SCU	47
4.2.4.3.3.	(Real-World) Activity – Modality Performed Procedure Step As SCU	50
4.2.4.4.	Association Acceptance Policy	54
4.2.5.	StorageSCU	55
4.2.5.1.	SOP Classes	55
4.2.5.2.	Association Policies	55
4.2.5.2.1.	General	55
4.2.5.2.2.	Number of Associations	55
4.2.5.2.3.	Asynchronous Nature	56
4.2.5.2.4.	Implementation Identifying Information	56
4.2.5.2.5.	Communication Failure Handling	56
4.2.5.3.	Association Initiation Policy	56
4.2.5.3.1.	(Real-World) Activity – Verification as SCU	56
4.2.5.3.2.	(Real-World) Activity – Image Export	58
4.2.5.3.3.	(Real-World) Activity – Storage Commitment Push Model AS SCU	60
4.2.5.4.	Association Acceptance Policy	64
4.3.	NETWORK INTERFACES	65
4.3.1.	Physical Network Interfaces	65
4.3.2.	Additional Protocols	65
4.4.	CONFIGURATION	65
4.4.1.	AE Title/Presentation Address Mapping	65
4.4.1.1.	Local AE Titles	65
4.4.1.2.	Remote AE Title/Presentation Address Mapping	65
4.4.2.	Parameters	66
5.	MEDIA INTERCHANGE	68
5.1.	IMPLEMENTATION MODEL	68
5.1.1.	Application Data Flow Diagram	68
5.1.2.	Functional Definitions of AE's	68
5.1.3.	Sequencing of Real World Activities	68
5.2.	AE SPECIFICATIONS	69
5.2.1.	Media MX 16-slice Media - Specification	69
5.2.1.1.	File Meta Information for the Media MX 16-slice	69
5.2.1.2.	Real-World Activities	69
5.2.1.2.1.	RWA - Read File-set	70
5.2.1.2.2.	RWA - Create File-set	70
5.3.	AUGMENTED AND PRIVATE APPLICATION PROFILES	70
5.4.	MEDIA CONFIGURATION	70
6.	SUPPORT OF CHARACTER SETS	71
7.	SECURITY	72
7.1.	SECURITY PROFILES	72
7.1.1.	Security use Profiles	72
7.1.2.	Security Transport Connection Profiles	72
7.1.3.	Digital Signature Profiles	72
7.1.4.	Media Storage Security Profiles	72
7.1.5.	Attribute Confidentiality Profiles	72
7.1.6.	Network Address Management Profiles	72
7.1.7.	Time Synchronization Profiles	72
7.1.8.	Application Configuration Management Profiles	72
7.1.9.	Audit Trail Profiles	72
7.2.	ASSOCIATION LEVEL SECURITY	72
7.3.	APPLICATION LEVEL SECURITY	72
8.	ANNEXES OF APPLICATION "APPLICATION MX 16-SLICE"	73

8.1.	IOD CONTENTS	73
8.1.1.	Created SOP Instance	73
8.1.1.1.	List of created SOP Classes	73
8.1.1.2.	CT Image Storage SOP Class	74
8.1.1.3.	Secondary Capture Image Storage SOP Class	77
8.1.2.	Usage of Attributes from Received IOD	80
8.1.2.1.	Usage of the Functionality Viewer	80
8.1.3.	Attribute Mapping	80
8.1.4.	Coerced/Modified fields	81
8.2.	DATA DICTIONARY OF PRIVATE ATTRIBUTES	81
8.3.	CODED TERMINOLOGY AND TEMPLATES	81
8.3.1.	Context Groups	81
8.3.2.	Template Specifications	81
8.3.3.	Private code definitions	81
8.4.	GRAYSCALE IMAGE CONSISTENCY	81
8.5.	STANDARD EXTENDED/SPECIALIZED/PRIVATE SOPS	81
8.6.	PRIVATE TRANSFER SYNTAXES	81

3. INTRODUCTION

The introduction specifies product and relevant disclaimers as well as any general information that the vendor feels is appropriate.

3.1. Revision History

The revision history provides dates and differences of the different releases.

Table 3: Revision History

Document Version	Date of Issue	Author	Description
00	12-July-2016		Final version

3.2. Audience

This Conformance Statement is intended for:

- (Potential) customers
- System integrators of medical equipment
- Marketing staff interested in system functionality
- Software designers implementing DICOM interfaces

It is assumed that the reader is familiar with the DICOM standard.

3.3. Remarks

The DICOM Conformance Statement is contained in chapter 4 through 8 and follows the contents and structuring requirements of DICOM PS 3.2.

This DICOM Conformance Statement by itself does not guarantee successful interoperability of Philips equipment with non-Philips equipment. The user (or user's agent) should be aware of the following issues:

- **Interoperability**
Interoperability refers to the ability of application functions, distributed over two or more systems, to work successfully together. The integration of medical devices into an IT environment may require application functions that are not specified within the scope of DICOM. Consequently, using only the information provided by this Conformance Statement does not guarantee interoperability of Philips equipment with non-Philips equipment.

It is the user's responsibility to analyze thoroughly the application requirements and to specify a solution that integrates Philips equipment with non-Philips equipment.

- **Validation**

Philips equipment has been carefully tested to assure that the actual implementation of the DICOM interface corresponds with this Conformance Statement.

Where Philips equipment is linked to non-Philips equipment, the first step is

to compare the relevant Conformance Statements. If the Conformance Statements indicate that successful information exchange should be possible, additional validation tests will be necessary to ensure the functionality, performance, accuracy and stability of image and image related data. It is the responsibility of the user (or user's agent) to specify the appropriate test suite and to carry out the additional validation tests.

- **New versions of the DICOM Standard**

The DICOM Standard will evolve in future to meet the user's growing requirements and to incorporate new features and technologies. Philips is actively involved in this evolution and plans to adapt its equipment to future versions of the DICOM Standard. In order to do so, Philips reserves the right to make changes to its products or to discontinue its delivery.

The user should ensure that any non-Philips provider linking to Philips equipment also adapts to future versions of the DICOM Standard. If not, the incorporation of DICOM enhancements into Philips equipment may lead to loss of connectivity (in case of networking) and incompatibility (in case of media).

3.4. Definitions, Terms and Abbreviations

Table 4: Definitions, Terms and Abbreviations

Abbreviation/Term	Explanation
AE	Application Entity
CD	Compact Disc
CD-R	CD-Recordable
CT	Computed Tomography
DCS	DICOM Conformance Statement
DICOM	Digital Imaging and Communications in Medicine
DIMSE	DICOM Message Service Element
DVD	A trademark of the DVD Forum that is not an abbreviation
DVD-RW	DVD Rewritable
EBE	DICOM Explicit VR Big Endian
ELE	DICOM Explicit VR Little Endian
FSC	File-set Creator
FSR	File-set Reader
FSU	File-set Updater
HIS	Hospital Information System
ILE	DICOM Implicit VR Little Endian
IOD	Information Object Definition
MPPS	Modality Performed Procedure Step
NEMA	National Electrical Manufacturers Association
PDU	Protocol Data Unit
RIS	Radiology Information System
RWA	Real-World Activity
SC	Secondary Capture
SCP	Service Class Provider
SCU	Service Class User
SOP	Service Object Pair
TCP/IP	Transmission Control Protocol/Internet Protocol
UID	Unique Identifier

Abbreviation/Term	Explanation
USB	Universal Serial Bus
WLM	Worklist Management

3.5. References

[DICOM] Digital Imaging and Communications in Medicine, Parts 1 - 20 (NEMA PS 3.1- PS 3.20), National Electrical Manufacturers Association (NEMA)

Publication Sales 1300 N. 17th Street, Suite 1752 Rosslyn, Virginia. 22209, United States of America

Internet: <http://medical.nema.org/>

Note that at any point in time the official standard consists of the most recent yearly edition of the base standard (currently 2015) plus all the supplements and correction items that have been approved as Final Text.

4. NETWORKING

This section contains the networking related services (vs. the media related ones).

4.1. Implementation model

The implementation model consists of three sections:

- The application data flow diagram, specifying the relationship between the Application Entities and the "external world" or Real-World Activities,
- A functional description of each Application Entity, and
- The sequencing constraints among them.

4.1.1. Application Data Flow

The MX 16-slice system is a comprehensive range of hardware and software modules. The system implements:

- A worklist management function to communicate with a RIS/HIS.
- An export function to transfer image data from local system to a remote system.
- A print function to print image data from the local system.
- Query/Retrieve to remote systems for history images.
- A viewing function for images from the local system.
- Images read from media.
- Viewed images can be written to media.

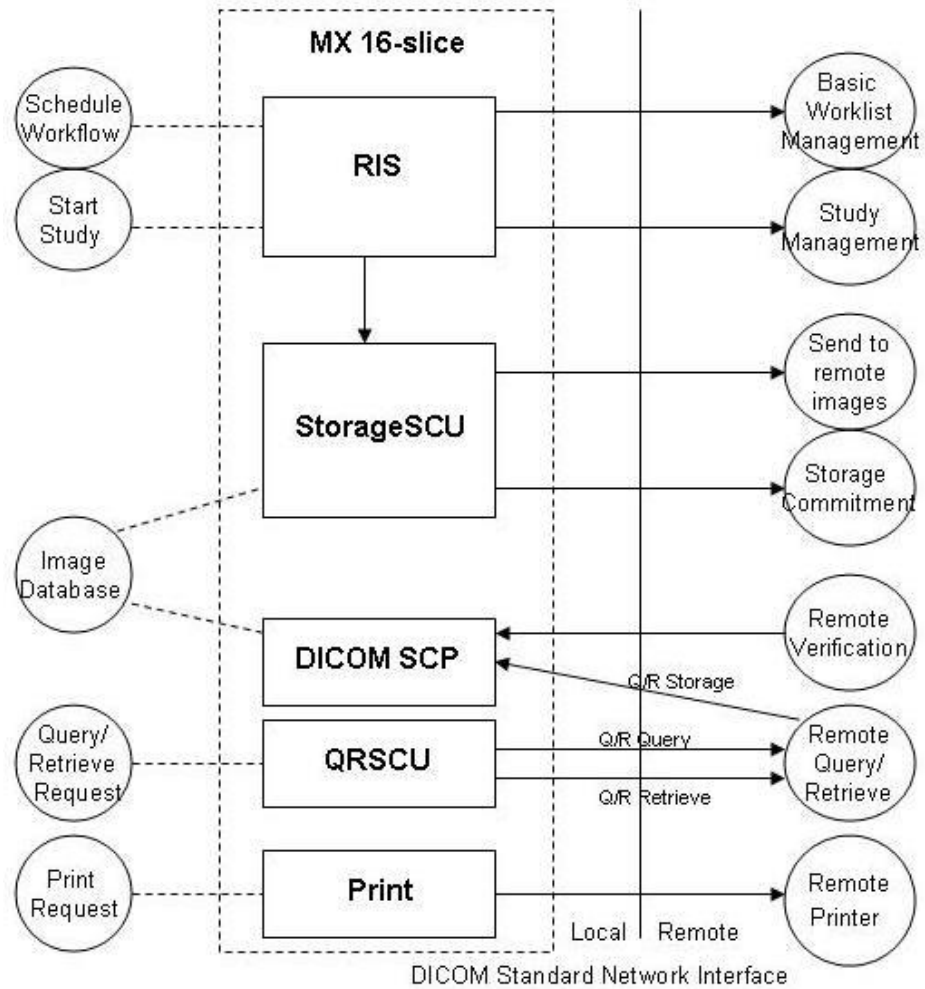

Figure 2: Data flow diagram MX 16-slice

4.1.2. Functional Definition of AE's

This section contains a functional definition for each individual local Application Entity.

4.1.2.1. Functional Definition of DICOM SCP

The DICOM SCP AE on the modality has the functionality to handle the received images.

On the modality is this accept only during a Query/Retrieve. Image send from remote to the modality will not be accepted.

Accept storage handle this AE also the verification from remote.

If the function is not started the AE will not accept any association request from remote.

4.1.2.2. Functional Definition of Print

The Print AE give the user the option to print Color and Grayscale Images.

The option for print in Color is dependent on color images. If no color images available this option cannot be selected.

4.1.2.3. Functional Definition of QRSCU

The MX 16-slice can request images from the past for a remote system (PACS, Workstation).

These images can be retrieve from remote to MX 16-slice.

The MX 16-slice will only retrieve images in the SOP Classes "CT Image SOP Class" and "Secondary Capture SOP Class".

After retrieve the images can be viewed with the available viewer.

4.1.2.4. Functional Definition of RIS

The RIS AE is the DICOM communicator to the RIS/HIS systems.

The MX 16-slice does a worklist request to the RIS and will create MPPS N-Create/N-Set message during the acquisition if configured.

4.1.2.5. Functional Definition of StorageSCU

The StorageSCU AE is for sending of the created images to a workstation of PACS. The MX 16-slice can send a Storage Commitment messages for archive proposal.

New created images will be from the SOP Class "CT image SOP Class".

Annotations and other made by the viewer will always send as "Secondary Capture" image.

The information will be burn into the image.

Also the Dose image created by pressing button "end study" is send with the "Secondary Capture SOP Class".

It it possible to configure auto store for the created images during the acquisition. These images are from the "CT Image SOP Class".

4.1.3. Sequencing of Real World Activities

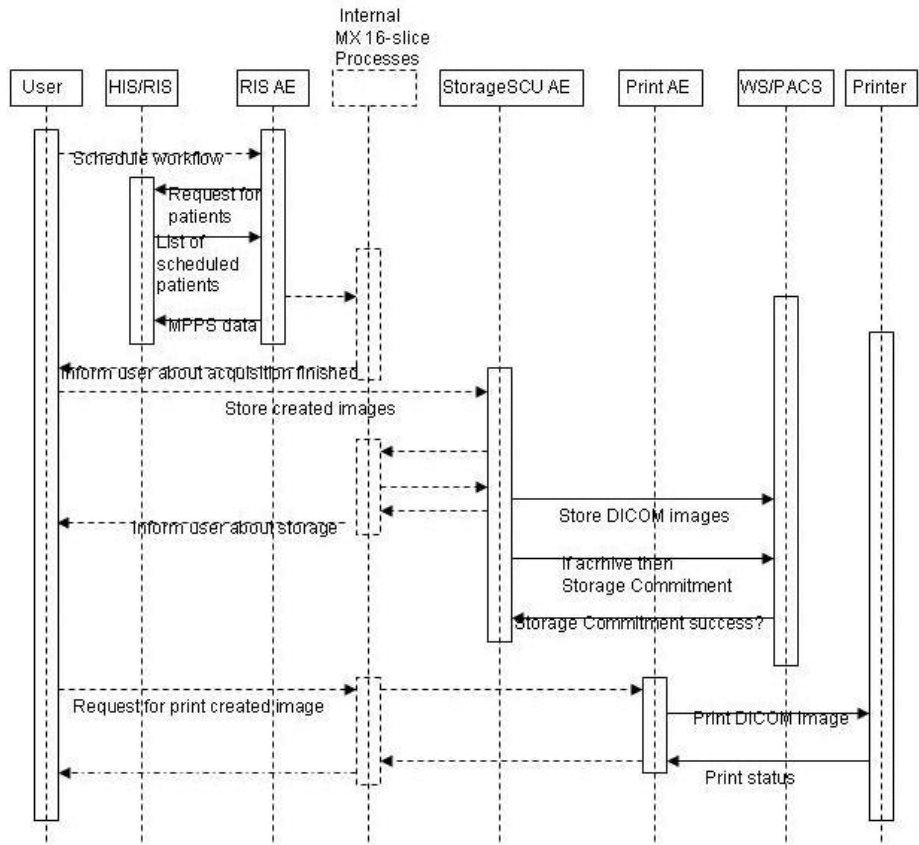

Figure 3: Sequence of real world activity Workflow

An user can do a request for the scheduled jobs of today.
 The MX 16-slice collects the responses from the RIS/HIS.
 For one of the studies from the list a scan can be started at the same moment.
 The images of the scan are collected on the MX 16-slice for viewing and sending to Workstation or PACS.
 With the MX 16-slice it is possible to print the images.
 The user is informed.

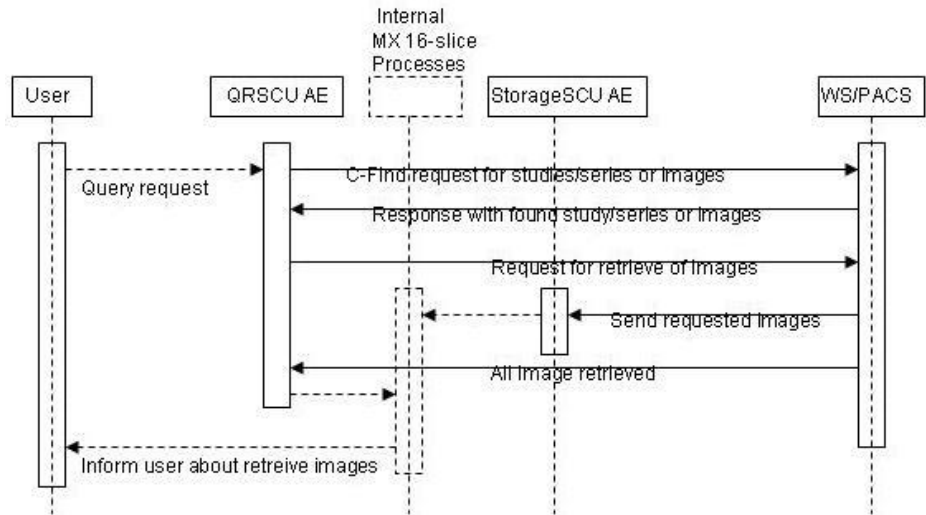

Figure 4: Sequence of real world activity Query/Retrieve

An user can request for images of a previous study on a patient form a remote system. The QRSCU AE is sending the C-FIND request to the remote system. After selecting of a study/series/image the AE will request a retrieve for images. The images are send from remote to the StorageSCU AE. The images are collected on the MX 16-slice for viewing. The user is informed that the images are retrieved.

4.2. AE Specifications

This section in the DICOM Conformance Statement is a set of application entity specifications. There are as many of these subsections as there are different AE's in the implementation.

4.2.1. DICOM SCP

Detail of this specific Application Entity is specified in this section.

4.2.1.1. SOP Classes

This Application Entity provides Standard Conformance to the following SOP Classes.

Table 5: SOP Classes for DICOM SCP

SOP Class Name	SOP Class UID	SCU	SCP
CT Image Storage SOP Class	1.2.840.10008.5.1.4.1.1.2	No	Yes
Secondary Capture Image Storage SOP Class	1.2.840.10008.5.1.4.1.1.7	No	Yes
Verification SOP Class	1.2.840.10008.1.1	No	Yes

Note: Any SOP specific behavior is documented later in the conformance statement in the applicable SOP specific conformance section.

4.2.1.2. Association Policies

Each AE specification contains a description of the general association establishment and acceptance policies of the AE.

4.2.1.2.1. General

The DICOM standard application context is specified below.

Table 6: DICOM Application Context

Description	Value
Application Context Name	1.2.840.10008.3.1.1.1

4.2.1.2.2. Number of Associations

The number of simultaneous associations that an Application Entity may support as a Initiator or Acceptor is specified here.

Table 7: Number of associations as an Association Initiator for this AE

Description	Value
Maximum number of simultaneous associations	0

Table 8: Number of associations as an Association Acceptor for this AE

Description	Value
Maximum number of simultaneous associations	no limit

4.2.1.2.3. Asynchronous Nature

The implementation supports negotiation of multiple outstanding transactions, along with the maximum number of outstanding transactions supported.

Table 9: Asynchronous nature as an Association Initiator for this AE

Description	Value
Maximum number of outstanding asynchronous transactions	none

4.2.1.2.4. Implementation Identifying Information

The value supplied for Implementation Class UID and version name are documented here.

Table 10: DICOM Implementation Class and Version for DICOM SCP

Implementation Class UID	1.2.840.113704.9.1000.1.1
Implementation Version Name	MX 16-slice 1.0

4.2.1.2.5. Communication Failure Handling

The behavior of the AE during communication failure is summarized in the next table.

Table 11: Communication Failure Behavior

Exception	Behavior
Timeout	The Association is aborted using A-ABORT and the command is marked as failed.
Association Aborted	The Association is aborted using A-ABORT and the command is marked as failed.
DIMSE Timeout	The Association is aborted using A-ABORT and the command is marked as failed.

4.2.1.3. Association Initiation Policy

The DICOM SCP does not handle the association initiation policy.

4.2.1.4. Association Acceptance Policy

The Application Entity may reject Association attempts as shown in the table below.

Table 12: Association Reject Reasons

Result	Source	Reason/Diagnosis	Behavior
1 - rejected permanent	1 - DICOM UL service-user	1 - no-reason-given	
		2 - application-context-name-not-supported	Connection closed
		3 - calling-AE-title-not-recognized	
	2 - DICOM UL service provider (ACSE related function)	7 - called-AE-title-not-recognized	
		1 - no-reason-given	A-ASSOCIATE-RJ
		2 - protocol-version-not-supported	A-ASSOCIATE-RJ
3 - DICOM UL service provider (Presentation related function)	1 - temporary-congestion		
2 - rejected-transient	1 - DICOM UL service-user	2 - local-limit-exceeded	
		1 - no-reason-given	Connection closed
		2 - application-context-name-not-supported	Connection closed
		3 - calling-AE-title-not-recognized	Connection closed
	2 - DICOM UL service provider (ACSE related function)	7 - called-AE-title-not-recognized	Connection closed
		1 - no-reason-given	
		2 - protocol-version-not-supported	
		3 - DICOM UL service provider (Presentation related function)	1 - temporary-congestion
	2 - local-limit-exceeded		

The behavior of the AE for sending an Association abort is summarized in next table.

Table 13: Association Abort Policies

Source	Reason/Diagnosis	Behavior
0 - DICOM UL service-user (initiated abort)	0 - reason-not-specified	
2 - DICOM UL service-provider (initiated abort)	0 - reason-not-specified	
	1 - unrecognized-PDU	
	2 - unexpected-PDU	
	4 - unrecognized-PDU parameter	
	5 - unexpected-PDU parameter	
	6 - invalid-PDU-parameter value	

4.2.1.4.1. (Real-World) Activity – Verification as SCP

4.2.1.4.1.1. Description and Sequencing of Activities

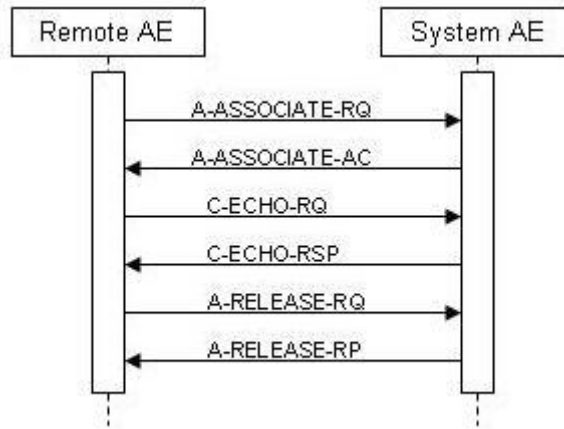

Figure 5: (Real World) Activity - Verification as SCP

The system provides standard conformance to the Verification SOP Class as an SCP. Verification can only be done if the Calling Title is defined on the MX 16-slice and the process is started.

4.2.1.4.1.2. Accepted Presentation Contexts

The presentation contexts are defined in the next table.

Table 14: Acceptable Presentation Contexts for (Real-World) Activity – Verification as SCP

Presentation Context Table					
Abstract Syntax		Transfer Syntax		Role	Extended Negotiation
Name	UID	Name List	UID List		
Verification SOP Class	1.2.840.10008.1.1	Explicit VR Big Endian	1.2.840.10008.1.2.2	SCP	None
		Explicit VR Little Endian	1.2.840.10008.1.2.1		
		Implicit VR Little Endian	1.2.840.10008.1.2		

4.2.1.4.1.3. SOP Specific Conformance for Verification SOP Class

This section and sub-section include the manufacturer SOP and Dataset specific information as well the status codes and their corresponding behavior.

4.2.1.4.1.3.1. Dataset Specific Conformance for Verification C-ECHO SCP

Detail regarding the Dataset Specific response behavior will be reported in this section.

This part of the section includes the dataset specific behavior, i.e. error codes, error and exception handling, time-outs, etc.

Table 15: Status Response

Service Status	Error Code	Further Meaning	Behavior
Success	0000	Success	The C-ECHO message is successfully received.
Failure	C000	Error- Cannot Understand	In all other situation then success.

4.2.1.4.2. (Real-World) Activity – Image Import

4.2.1.4.2.1. Description and Sequencing of Activities

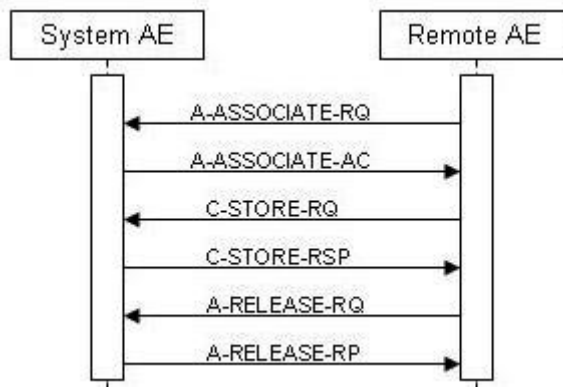

Figure 6: (Real World) Activity - Image Import

The Storage SCP function will only accept images as retrieve command. Storage from remote is not accepted for this modality in all other situations.

4.2.1.4.2.2. Accepted Presentation Contexts

The presentation contexts are defined in the next table.

Table 16: Acceptable Presentation Contexts for (Real-World) Activity – Image Import

Presentation Context Table					
Abstract Syntax		Transfer Syntax		Role	Extended Negotiation
Name	UID	Name List	UID List		
CT Image Storage SOP Class	1.2.840.10008.5.1.4.1.1.2	Explicit VR Big Endian	1.2.840.10008.1.2.2	SCP	None
		Explicit VR Little Endian	1.2.840.10008.1.2.1		
		Implicit VR Little Endian	1.2.840.10008.1.2		
Secondary Capture Image Storage SOP Class	1.2.840.10008.5.1.4.1.1.7	Explicit VR Big Endian	1.2.840.10008.1.2.2	SCP	None
		Explicit VR Little Endian	1.2.840.10008.1.2.1		
		Implicit VR Little Endian	1.2.840.10008.1.2		

4.2.1.4.2.3. SOP Specific Conformance for Storage SOP Classes

This section and sub-section include the manufacturer SOP and Dataset specific information as well the status codes and their corresponding behavior.

4.2.1.4.2.3.1. Dataset Specific Conformance for C-STORE-RSP

Detail regarding the Dataset Specific response behavior will be reported in this section. This includes the dataset specific behavior, i.e. error codes, error and exception handling, time-outs, etc.

Table 17: Status Response

Service Status	Error Code	Further Meaning	Behavior
Success	0000	Successful stored	

4.2.2. Print

Detail of this specific Application Entity is specified in this section.

4.2.2.1. SOP Classes

This Application Entity provides Standard Conformance to the following SOP Classes.

Table 18: SOP Classes for Print

SOP Class Name	SOP Class UID	SCU	SCP
Basic Color Print Management Meta SOP Class	1.2.840.10008.5.1.1.18	Yes	No
>Basic Color Image Box SOP Class	1.2.840.10008.5.1.1.4.1	Yes	No
>Basic Film Box SOP Class	1.2.840.10008.5.1.1.2	Yes	No
>Basic Film Session SOP Class	1.2.840.10008.5.1.1.1	Yes	No
>Printer SOP Class	1.2.840.10008.5.1.1.16	Yes	No
Basic Grayscale Print Management Meta SOP Class	1.2.840.10008.5.1.1.9	Yes	No
>Basic Film Box SOP Class	1.2.840.10008.5.1.1.2	Yes	No
>Basic Film Session SOP Class	1.2.840.10008.5.1.1.1	Yes	No
>Basic Grayscale Image Box SOP Class	1.2.840.10008.5.1.1.4	Yes	No
>Printer SOP Class	1.2.840.10008.5.1.1.16	Yes	No

Note: Any SOP specific behavior is documented later in the conformance statement in the applicable SOP specific conformance section.

4.2.2.2. Association Policies

Each AE specification contains a description of the general association establishment and acceptance policies of the AE.

4.2.2.2.1. General

The DICOM standard application context is specified below.

Table 19: DICOM Application Context

Description	Value
Application Context Name	1.2.840.10008.3.1.1.1

4.2.2.2.2. Number of Associations

The number of simultaneous associations that an Application Entity may support as a Initiator or Acceptor is specified here.

Table 20: Number of associations as an Association Initiator for this AE

Description	Value
Maximum number of simultaneous associations	1

Table 21: Number of associations as an Association Acceptor for this AE

Description	Value
Maximum number of simultaneous associations	0

4.2.2.2.3. Asynchronous Nature

The implementation supports negotiation of multiple outstanding transactions, along with the maximum number of outstanding transactions supported.

Table 22: Asynchronous nature as an Association Initiator for this AE

Description	Value
Maximum number of outstanding asynchronous transactions	none

4.2.2.2.4. Implementation Identifying Information

The value supplied for Implementation Class UID and version name are documented here.

Table 23: DICOM Implementation Class and Version for Print

Implementation Class UID	1.2.840.113704.9.1000.1.1
Implementation Version Name	MX 16-slice 1.0

4.2.2.2.5. Communication Failure Handling

The behavior of the AE during communication failure is summarized in the next table.

Table 24: Communication Failure Behavior

Exception	Behavior
Timeout	The Association is aborted.

4.2.2.3. Association Initiation Policy**4.2.2.3.1. (Real-World) Activity – Print Management As SCU****4.2.2.3.1.1. Description and Sequencing of Activities**

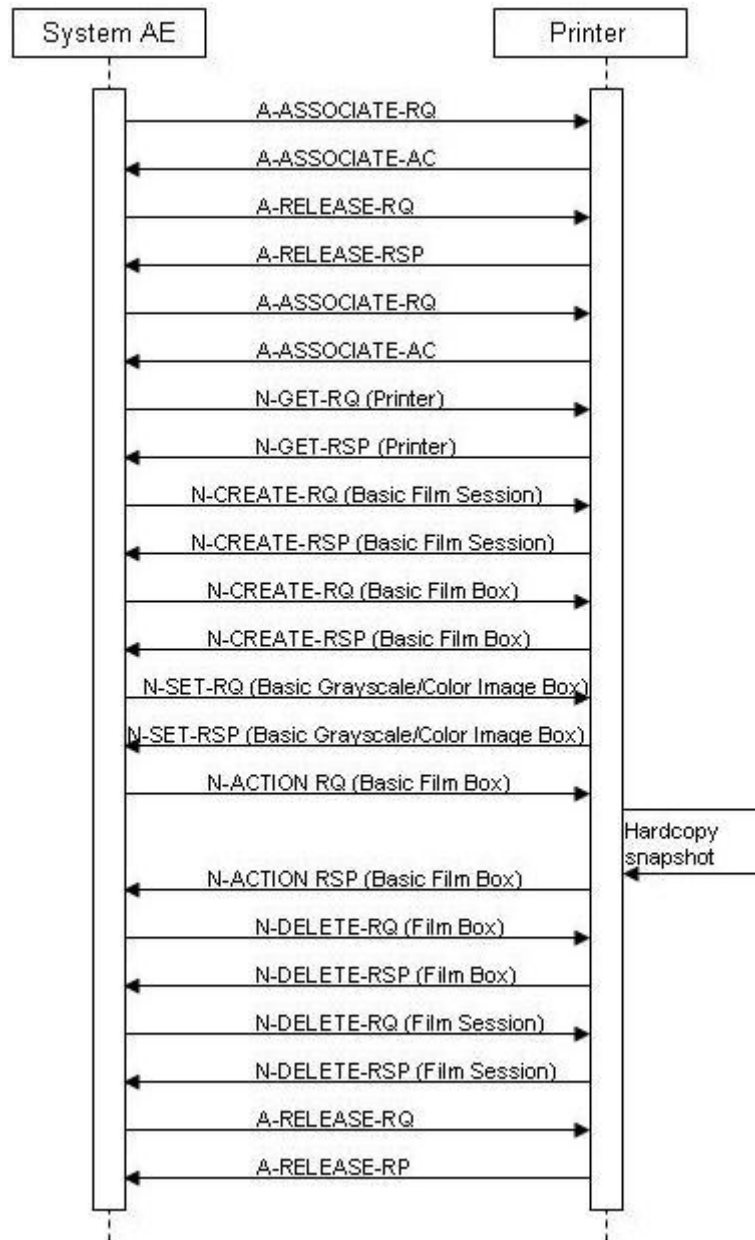

Figure 7: (Real World) Activity - Print Management as SCU

A typical sequence of Dimse messages sent over an association between Hardcopy AE and a Printer is illustrated in above figure.

- Print AE opens an association with the printer.
- N-GET on the Printer SOP Class is used to obtain current printer status information. If the printer reports an status of failure, the print-job is switched to a failed state and the user informed.
- N-CREATE on the Film Session SOP Class creates a Film Session.
- N-CREATE on the Film Box SOP Class creates a film box linked to the film session. A single image box will be created as the result of the operation. (Print AE only use the format STANDARD\1,1)
- N-SET on the Image Box (Grayscale or Color) SOP Class transfers the contents of the film sheet to the printer.

- N-ACTION on the Film Box SOP Class instructs the printer to print the film box.
- The printer prints the requested number of film sheets.
- N-DELETE on the FILM BOX SOP Class deletes the Film Box SOP Instance.
- N-DELETE on the Film Session SOP Class deletes the complete Film Session SOP Instance hierarchy.
- Print AE close the association with the printer.

4.2.2.3.1.2. Proposed Presentation Contexts

The presentation contexts are defined in the next table.

Table 25: Proposed Presentation Contexts for (Real-World) Activity – Print Management As SCU

Presentation Context Table					
Abstract Syntax		Transfer Syntax		Role	Extended Negotiation
Name	UID	Name List	UID List		
Basic Color Print Management Meta SOP Class	1.2.840.10008.5.1.1.18			SCU	None
>Basic Color Image Box SOP Class	1.2.840.10008.5.1.1.4.1	Explicit VR Big Endian	1.2.840.10008.1.2.2	SCU	None
		Explicit VR Little Endian	1.2.840.10008.1.2.1		
		Implicit VR Little Endian	1.2.840.10008.1.2		
>Basic Film Box SOP Class	1.2.840.10008.5.1.1.2	Explicit VR Big Endian	1.2.840.10008.1.2.2	SCU	None
		Explicit VR Little Endian	1.2.840.10008.1.2.1		
		Implicit VR Little Endian	1.2.840.10008.1.2		
>Basic Film Session SOP Class	1.2.840.10008.5.1.1.1	Explicit VR Big Endian	1.2.840.10008.1.2.2	SCU	None
		Explicit VR Little Endian	1.2.840.10008.1.2.1		
		Implicit VR Little Endian	1.2.840.10008.1.2		
>Printer SOP Class	1.2.840.10008.5.1.1.16	Explicit VR Big Endian	1.2.840.10008.1.2.2	SCU	None
		Explicit VR Little Endian	1.2.840.10008.1.2.1		
		Implicit VR Little Endian	1.2.840.10008.1.2		
Basic Grayscale Print Management Meta SOP Class	1.2.840.10008.5.1.1.9			SCU	None
>Basic Film Box SOP Class	1.2.840.10008.5.1.1.2	Explicit VR Big Endian	1.2.840.10008.1.2.2	SCU	None
		Explicit VR Little Endian	1.2.840.10008.1.2.1		
		Implicit VR Little Endian	1.2.840.10008.1.2		
>Basic Film Session SOP Class	1.2.840.10008.5.1.1.1	Explicit VR Big Endian	1.2.840.10008.1.2.2	SCU	None
		Explicit VR Little Endian	1.2.840.10008.1.2.1		
		Implicit VR Little Endian	1.2.840.10008.1.2		
>Basic Grayscale Image Box SOP Class	1.2.840.10008.5.1.1.4	Explicit VR Big Endian	1.2.840.10008.1.2.2	SCU	None
		Explicit VR Little Endian	1.2.840.10008.1.2.1		
		Implicit VR Little Endian	1.2.840.10008.1.2		
>Printer SOP Class	1.2.840.10008.5.1.1.16	Explicit VR Big Endian	1.2.840.10008.1.2.2	SCU	None
		Explicit VR Little Endian	1.2.840.10008.1.2.1		
		Implicit VR Little Endian	1.2.840.10008.1.2		

This section specifies each IOD created (including private IOD's).

Abbreviations used in the Module table for the column "Presence of Value" are:
 ALWAYS The attribute is always present with a value

EMPTY	The attribute is always present without any value (attribute sent zero length)
VNAP	The attribute is always present and its Value is Not Always Present (attribute sent zero length if no value is present)
ANAP	The attribute is present under specified condition – if present then it will always have a value
VNAPCV	The attribute is present under specified condition – if present then its Value is Not Always Present (attribute sent zero length if condition applies and no value is present)
ANAPEV	The attribute is present under specified condition – if present then it will not have any value

The abbreviations used in the Module table for the column "Source" are:

AUTO	The attribute value is generated automatically
CONFIG	The attribute value source is a configurable parameter
COPY	The attribute value source is another SOP instance
FIXED	The attribute value is hard-coded in the application
IMPLICIT	The attribute value source is a user-implicit setting
MPPS	The attribute value is the same as that use for Modality Performed Procedure Step
MWL	The attribute value source is a Modality Worklist
USER	The attribute value source is explicit user input

4.2.2.3.1.3. SOP Specific Conformance for Basic Color Image Box SOP Class of the Basic Color Print Management Meta SOP Class

This section and sub-section include the manufacturer SOP and Dataset specific information as well the status codes and their corresponding behavior.

4.2.2.3.1.3.1. Dataset Specific Conformance for Basic Color Image Box SOP Class N-SET-SCU

Detail regarding the Dataset Specific response behavior will be reported in this section.

Table 26: Image Box Pixel Presentation Module

Attribute Name	Tag	VR	Value	Presence of Value	Source	Comment
Image Box Position	2020,0010	US		ALWAYS	AUTO	
Polarity	2020,0020	CS	NORMAL	ALWAYS	FIXED	
Basic Color Image Sequence	2020,0111	SQ		ALWAYS	AUTO	
>Bits Allocated	0028,0100	US	8	ALWAYS	FIXED	
>Bits Stored	0028,0101	US	8	ALWAYS	FIXED	
>Columns	0028,0011	US		ALWAYS	AUTO	
>High Bit	0028,0102	US	7	ALWAYS	FIXED	
>Photometric Interpretation	0028,0004	CS	RGB	ALWAYS	FIXED	
>Pixel Aspect Ratio	0028,0034	IS	Value 1: 1\1	ALWAYS	FIXED	
>Pixel Data	7FE0,0010	O W/ OB		ALWAYS	AUTO	
>Pixel Representation	0028,0103	US		ALWAYS	AUTO	
>Planar Configuration	0028,0006	US	0	ALWAYS	FIXED	
>Rows	0028,0010	US		ALWAYS	AUTO	
>Samples per Pixel	0028,0002	US	3	ALWAYS	FIXED	

This part of the section includes the dataset specific behavior, i.e. error codes, error and exception handling, time-outs, etc.

Table 27: Status Response

Service Status	Error Code	Further Meaning	Behavior
Success	0000	Success	The SCP has completed the operation successfully
Error	*	All error numbers	Error is logged, and print job is marked as failure
Warning	*	All warning numbers	Warning is logged, print job continued

4.2.2.3.1.4. SOP Specific Conformance for Basic Film Box SOP Class of the Basic Color Print Management Meta SOP Class

This section and sub-section include the manufacturer SOP and Dataset specific information as well the status codes and their corresponding behavior.

4.2.2.3.1.4.1. Dataset Specific Conformance for Basic Film Box SOP Class N-CREATE-SCU

Detail regarding the Dataset Specific response behavior will be reported in this section.

Table 28: Basic Film Box Presentation Module

Attribute Name	Tag	VR	Value	Presence of Value	Source	Comment
Film Orientation	2010,0040	CS		ALWAYS	CONFIG	
Film Size ID	2010,0050	CS		ALWAYS	CONFIG	
Image Display Format	2010,0010	ST	STANDARD\1,1	ALWAYS	FIXED	
Magnification Type	2010,0060	CS		ALWAYS	AUTO	
Max Density	2010,0130	US		ALWAYS	AUTO	
Min Density	2010,0120	US		ALWAYS	AUTO	
Trim	2010,0140	CS	NO	ALWAYS	FIXED	

Table 29: Basic Film Box Relationship Module

Attribute Name	Tag	VR	Value	Presence of Value	Source	Comment
Referenced Film Session Sequence	2010,0500	SQ		ALWAYS	AUTO	
>Referenced SOP Class UID	0008,1150	UI		ALWAYS	AUTO	
>Referenced SOP Instance UID	0008,1155	UI		ALWAYS	AUTO	

This part of the section includes the dataset specific behavior, i.e. error codes, error and exception handling, time-outs, etc.

Table 30: Status Response

Service Status	Error Code	Further Meaning	Behavior
Success	0000	Success	The SCP has completed the operation successfully.
Error	*	All error numbers	Error is logged and print job is marked as failure.
Warning	*	All warning numbers	Warning is logged and print job continued.

4.2.2.3.1.4.2. Dataset Specific Conformance for Basic Film Box SOP Class N-ACTION-SCU

Detail regarding the Dataset Specific response behavior will be reported in this section.

This part of the section includes the dataset specific behavior, i.e. error codes, error and exception handling, time-outs, etc.

Table 31: Status Response

Service Status	Error Code	Further Meaning	Behavior
Success	0000	Matching is complete	The SCU has successfully completed
*	*	All other situations	The SCU has successfully completed

4.2.2.3.1.4.3. Dataset Specific Conformance for Basic Film Box SOP Class N-DELETE-SCU

Detail regarding the Dataset Specific response behavior will be reported in this section.

This part of the section includes the dataset specific behavior, i.e. error codes, error and exception handling, time-outs, etc.

Table 32: Status Response

Service Status	Error Code	Further Meaning	Behavior
Success	0000	Job successfully completed	The SCU has successfully completed
*	*	All other situations	The SCU has successfully completed

4.2.2.3.1.5. SOP Specific Conformance for Basic Film Session SOP Class of the Basic Color Print Management Meta SOP Class

This section and sub-section include the manufacturer SOP and Dataset specific information as well the status codes and their corresponding behavior.

4.2.2.3.1.5.1. Dataset Specific Conformance for Basic Film Session SOP Class N-CREATE-SCU

Detail regarding the Dataset Specific response behavior will be reported in this section.

Table 33: Basic Film Session Presentation Module

Attribute Name	Tag	VR	Value	Presence of Value	Source	Comment
Film Destination	2000,0040	CS		ALWAYS	CONFIG	
Film Session Label	2000,0050	LO		ALWAYS	FIXED	
Medium Type	2000,0030	CS		ALWAYS	CONFIG	
Number of Copies	2000,0010	IS		ALWAYS	CONFIG	
Print Priority	2000,0020	CS		ALWAYS	FIXED	

This part of the section includes the dataset specific behavior, i.e. error codes, error and exception handling, time-outs, etc.

Table 34: Status Response

Service Status	Error Code	Further Meaning	Behavior
Success	0000	Success	The SCP has completed the operation successfully.
Error	*	All error numbers	Error is logged and print job is marked as failure.
Warning	*	All warning numbers	Warning is logged and print job continued.

4.2.2.3.1.5.2. Dataset Specific Conformance for Basic Film Session SOP Class N-DELETE-SCU

Detail regarding the Dataset Specific response behavior will be reported in this section.

This part of the section includes the dataset specific behavior, i.e. error codes, error and exception handling, time-outs, etc.

Table 35: Status Response

Service Status	Error Code	Further Meaning	Behavior
Success	0000	Success	The SCP has completed the operation successfully
*	*	Error code <>0000	Print job continued

4.2.2.3.1.6. SOP Specific Conformance for Printer SOP Class of the Basic Color Print Management Meta SOP Class

This section and sub-section include the manufacturer SOP and Dataset specific information as well the status codes and their corresponding behavior.

4.2.2.3.1.6.1. Dataset Specific Conformance for Printer SOP Class N-EVENT-REPORT-SCP

The DIMSE N-EVENT-REPORT of the Printer SOP Class is not supported by the MX 16-slice.

4.2.2.3.1.6.2. Dataset Specific Conformance for Printer SOP Class N-GET-SCU

Detail regarding the Dataset Specific response behavior will be reported in this section.

This part of the section includes the dataset specific behavior, i.e. error codes, error and exception handling, time-outs, etc.

Table 36: Status Response

Service Status	Error Code	Further Meaning	Behavior
Success	0000	Success	The SCP has completed the operation successfully
Error	*	Error during printing	Error is logged and print job is marked as failure
Warning	*	Warning during printing	The MX 16-slice does not react on this status and finish print job

4.2.2.3.1.7. SOP Specific Conformance for Basic Film Box SOP Class of the Basic Grayscale Print Management Meta SOP Class

This section and sub-section include the manufacturer SOP and Dataset specific information as well the status codes and their corresponding behavior.

4.2.2.3.1.7.1. Dataset Specific Conformance for Basic Film Box SOP Class N-CREATE-SCU

Detail regarding the Dataset Specific response behavior will be reported in this section.

Table 37: Basic Film Box Presentation Module

Attribute Name	Tag	VR	Value	Presence of Value	Source	Comment
Film Orientation	2010,0040	CS		ALWAYS	CONFIG	
Film Size ID	2010,0050	CS		ALWAYS	CONFIG	
Image Display Format	2010,0010	ST	STANDARD\1,1	ALWAYS	FIXED	
Magnification Type	2010,0060	CS		ALWAYS	AUTO	
Max Density	2010,0130	US		ALWAYS	AUTO	
Min Density	2010,0120	US		ALWAYS	AUTO	
Trim	2010,0140	CS	NO	ALWAYS	FIXED	

Table 38: Basic Film Box Relationship Module

Attribute Name	Tag	VR	Value	Presence of Value	Source	Comment
Referenced Film Session Sequence	2010,0500	SQ		ALWAYS	AUTO	
>Referenced SOP Class UID	0008,1150	UI		ALWAYS	AUTO	
>Referenced SOP Instance UID	0008,1155	UI		ALWAYS	AUTO	

This part of the section includes the dataset specific behavior, i.e. error codes, error and exception handling, time-outs, etc.

Table 39: Status Response

Service Status	Error Code	Further Meaning	Behavior
Success	0000	Success	The SCP has completed the operation successfully.
Error	*	All error numbers	Error is logged and print job is marked as failure.
Warning	*	All warning numbers	Warning is logged and print job continued.

4.2.2.3.1.7.2. Dataset Specific Conformance for Basic Film Box SOP Class N-ACTION-SCU

Detail regarding the Dataset Specific response behavior will be reported in this section.

This part of the section includes the dataset specific behavior, i.e. error codes, error and exception handling, time-outs, etc.

Table 40: Status Response

Service Status	Error Code	Further Meaning	Behavior
Success	0000	Success	The SCP has completed the operation successfully
*	*	Error code <>0000	Print job continued.

4.2.2.3.1.7.3. Dataset Specific Conformance for Basic Film Box SOP Class N-DELETE-SCU

Detail regarding the Dataset Specific response behavior will be reported in this section.

This part of the section includes the dataset specific behavior, i.e. error codes, error and exception handling, time-outs, etc.

Table 41: Status Response

Service Status	Error Code	Further Meaning	Behavior
Success	0000	Success	The SCP has completed the operation successfully
*	*	Error code <>0000	Print job continued

4.2.2.3.1.8. SOP Specific Conformance for Basic Film Session SOP Class of the Basic Grayscale Print Management Meta SOP Class

This section and sub-section include the manufacturer SOP and Dataset specific information as well the status codes and their corresponding behavior.

4.2.2.3.1.8.1. Dataset Specific Conformance for Basic Film Session SOP Class N-CREATE-SCU

Detail regarding the Dataset Specific response behavior will be reported in this section.

Table 42: Basic Film Session Presentation Module

Attribute Name	Tag	VR	Value	Presence of Value	Source	Comment
Film Destination	2000,0040	CS		ALWAYS	CONFIG	
Film Session Label	2000,0050	LO	Philips and Neusoft Medical Systems	ALWAYS	FIXED	
Medium Type	2000,0030	CS		ALWAYS	CONFIG	
Number of Copies	2000,0010	IS		ALWAYS	CONFIG	
Print Priority	2000,0020	CS		ALWAYS	FIXED	

This part of the section includes the dataset specific behavior, i.e. error codes, error and exception handling, time-outs, etc.

Table 43: Status Response

Service Status	Error Code	Further Meaning	Behavior
Success	0000	Success	The SCP has completed the operation successfully
Error	0106	Invalid attribute value	The association is released after the received error. Does not send film to printer.
	*	Other error numbers	Error is ignored, print job continued.
Warning	*	All warning numbers	Warning is ignored, print job continued.

4.2.2.3.1.8.2. Dataset Specific Conformance for Basic Film Session SOP Class N-DELETE-SCU

Detail regarding the Dataset Specific response behavior will be reported in this section.

This part of the section includes the dataset specific behavior, i.e. error codes, error and exception handling, time-outs, etc.

Table 44: Status Response

Service Status	Error Code	Further Meaning	Behavior
Success	0000	Success	The SCP has completed the operation successfully
*	*	Error code <>0000	Print job continued

4.2.2.3.1.9. SOP Specific Conformance for Basic Grayscale Image Box SOP Class of the Basic Grayscale Print Management Meta SOP Class

This section and sub-section include the manufacturer SOP and Dataset specific information as well the status codes and their corresponding behavior.

4.2.2.3.1.9.1. Dataset Specific Conformance for Basic Grayscale Image Box SOP Class N-SET-SCU

Detail regarding the Dataset Specific response behavior will be reported in this section.

Table 45: Image Box Pixel Presentation Module

Attribute Name	Tag	VR	Value	Presence of Value	Source	Comment
Image Box Position	2020,0010	US		ALWAYS	AUTO	
Polarity	2020,0020	CS	NORMAL	ALWAYS	FIXED	
Basic Grayscale Image Sequence	2020,0110	SQ		ALWAYS	AUTO	
>Bits Allocated	0028,0100	US	8	ALWAYS	FIXED	
>Bits Stored	0028,0101	US	8	ALWAYS	FIXED	
>Columns	0028,0011	US		ALWAYS	AUTO	
>High Bit	0028,0102	US	7	ALWAYS	FIXED	
>Photometric Interpretation	0028,0004	CS	MONOCHROME2	ALWAYS	FIXED	

>Pixel Aspect Ratio	0028,0034	IS	Value 1: 1\1	ALWAYS	FIXED	
>Pixel Data	7FE0,0010	O W/ OB		ALWAYS	AUTO	
>Pixel Representation	0028,0103	US		ALWAYS	AUTO	
>Rows	0028,0010	US		ALWAYS	AUTO	
>Samples per Pixel	0028,0002	US	1	ALWAYS	FIXED	

This part of the section includes the dataset specific behavior, i.e. error codes, error and exception handling, time-outs, etc.

Table 46: Status Response

Service Status	Error Code	Further Meaning	Behavior
Success	0000	Success	The SCP has completed the operation successfully
Error	*	All error numbers	The error is logged and print job is marked as failure.
Warning	*	All warning numbers	The warning is ignored. Print job continue.

4.2.2.3.1.10. SOP Specific Conformance for Printer SOP Class of the Basic Grayscale Print Management Meta SOP Class

This section and sub-section include the manufacturer SOP and Dataset specific information as well the status codes and their corresponding behavior.

4.2.2.3.1.10.1. Dataset Specific Conformance for Printer SOP Class N-EVENT-REPORT-SCP

The DIMSE N-EVENT-REPORT of the Printer SOP Class is not supported by the MX 16-slice.

4.2.2.3.1.10.2. Dataset Specific Conformance for Printer SOP Class N-GET-SCU

Detail regarding the Dataset Specific response behavior will be reported in this section.

This part of the section includes the dataset specific behavior, i.e. error codes, error and exception handling, time-outs, etc.

Table 47: Status Response

Service Status	Error Code	Further Meaning	Behavior
Success	0000	Success	The SCP has completed the operation successfully
Error	*	Error during printing	Error is logged and print job is marked as failure.
Warning	*	Warning during printing	MX 16-slice does not react on this status and finish printing

4.2.2.4. Association Acceptance Policy

The Printer AE does not handle association acceptance policy

4.2.3. QRSCU

Detail of this specific Application Entity is specified in this section.

4.2.3.1. SOP Classes

This Application Entity provides Standard Conformance to the following SOP Classes.

Table 48: SOP Classes for QRSCU

SOP Class Name	SOP Class UID	SCU	SCP
Study Root QR Information Model - FIND SOP Class	1.2.840.10008.5.1.4.1.2.2.1	Yes	No
Study Root QR Information Model - MOVE SOP Class	1.2.840.10008.5.1.4.1.2.2.2	Yes	No
Verification SOP Class	1.2.840.10008.1.1	Yes	No

Note: Any SOP specific behavior is documented later in the conformance statement in the applicable SOP specific conformance section.

4.2.3.2. Association Policies

Each AE specification contains a description of the general association establishment and acceptance policies of the AE.

4.2.3.2.1. General

The DICOM standard application context is specified below.

Table 49: DICOM Application Context

Description	Value
Application Context Name	1.2.840.10008.3.1.1.1

4.2.3.2.2. Number of Associations

The number of simultaneous associations that an Application Entity may support as a Initiator or Acceptor is specified here.

Table 50: Number of associations as an Association Initiator for this AE

Description	Value
Maximum number of simultaneous associations	1

Table 51: Number of associations as an Association Acceptor for this AE

Description	Value
Maximum number of simultaneous associations	0

4.2.3.2.3. Asynchronous Nature

The implementation supports negotiation of multiple outstanding transactions, along with the maximum number of outstanding transactions supported.

Table 52: Asynchronous nature as an Association Initiator for this AE

Description	Value
Maximum number of outstanding asynchronous transactions	none

4.2.3.2.4. Implementation Identifying Information

The value supplied for Implementation Class UID and version name are documented here.

Table 53: DICOM Implementation Class and Version for QRSCU

Implementation Class UID	1.2.840.113704.9.1000.1.1
Implementation Version Name	MX 16-slice 1.0

4.2.3.2.5. Communication Failure Handling

The behavior of the AE during communication failure is summarized in the next table.

Table 54: Communication Failure Behavior

Exception	Behavior
Timeout	The Association is aborted using A-ABORT.
Association aborted	The Association is aborted using A-ABORT.
DIMSE Timeout	The Association is aborted using A-ABORT.

4.2.3.3. Association Initiation Policy

The behavior of this Application Entity is summarized in the next Table.

Table 55: Response Status Handler Behavior

Service Status	Error Code	Further Meaning	Behavior
Success	0000	Matching is complete	The SCP has successfully returned all matching information

4.2.3.3.1. (Real-World) Activity – Verification as SCU

4.2.3.3.1.1. Description and Sequencing of Activities

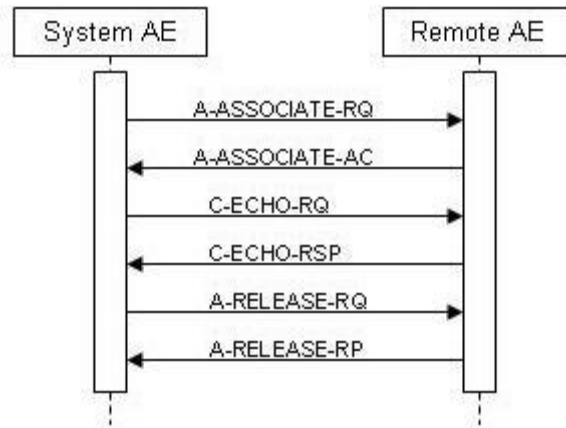

Figure 8: (Real World) Activity - Verification as SCU

The user can do verification by using the server menu for configuration QRSCU setting by click on the "Test" button.
 The system sends out a DICOM Association message following by the C-ECHO message.

4.2.3.3.1.2. Proposed Presentation Contexts

The presentation contexts are defined in the next table.

Table 56: Proposed Presentation Contexts for (Real-World) Activity – Verification as SCU

Presentation Context Table					
Abstract Syntax		Transfer Syntax		Role	Extended Negotiation
Name	UID	Name List	UID List		
Verification SOP Class	1.2.840.10008.1.1	Explicit VR Big Endian	1.2.840.10008.1.2.2	SCU	None
		Explicit VR Little Endian	1.2.840.10008.1.2.1		
		Implicit VR Little Endian	1.2.840.10008.1.2		

4.2.3.3.1.3. SOP Specific Conformance for Verification SOP Class

This section and sub-section include the manufacturer SOP and Dataset specific information as well the status codes and their corresponding behavior.

4.2.3.3.1.3.1. Dataset Specific Conformance for Verification C-ECHO SCU

Detail regarding the Dataset Specific response behavior will be reported in this section.

This part of the section includes the dataset specific behavior, i.e. error codes, error and exception handling, time-outs, etc.

Table 57: Status Response

Service Status	Error Code	Further Meaning	Behavior
Success	0000	Communication with remote system is successful	The text "Connection Succeeded" is popup.
*	*	Failed communication	The text "Connection Failed" is popup

4.2.3.3.2. (Real-World) Activity – FIND As SCU

4.2.3.3.2.1. Description and Sequencing of Activities

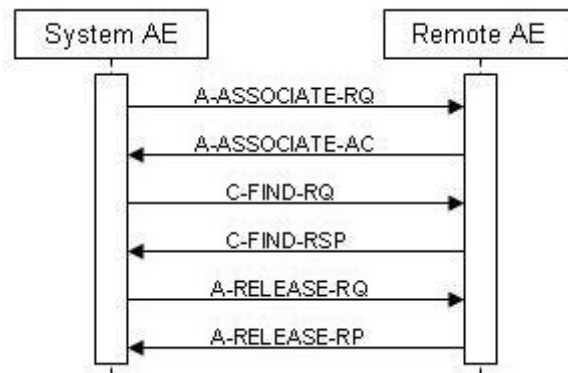

Figure 9: (Real World) Activity - Find as SCU

The Patient Data Manager initiates an association when the user clicks on the icon of "remote devices" in the devices tool-bar. The Patient Data Manager searches (C-FIND) by study level following by Series level. The association remains open until the user explicitly closes it by clicking again on the device icon - the Query will be closed with a A-RELEASE.

4.2.3.3.2.2. Proposed Presentation Contexts

Each time an association is initiated, the association initiator propose a number of presentation contexts to be used on that association. In this subsection, the presentation context proposed by Patient Data Manager for (Real World) Activity - C-FIND (SCU) are defined.

Table 58: Proposed Presentation Contexts for (Real-World) Activity – FIND As SCU

Presentation Context Table					
Abstract Syntax		Transfer Syntax		Role	Extended Negotiation
Name	UID	Name List	UID List		
Study Root QR Information Model - FIND	1.2.840.10008.5.1.4.1.2.2.1	Explicit VR Big Endian	1.2.840.10008.1.2.2	SCU	None
		Explicit VR Little Endian	1.2.840.10008.1.2.1		

Presentation Context Table					
Abstract Syntax		Transfer Syntax		Role	Extended Negotiation
Name	UID	Name List	UID List		
SOP Class		Implicit VR Little Endian	1.2.840.10008.1.2		

4.2.3.3.2.3. SOP Specific Conformance for Study Root QR Information Model - FIND SOP Class

This section and sub-section include the manufacturer SOP and Dataset specific information as well the status codes and their corresponding behavior.

4.2.3.3.2.3.1. Dataset Specific Conformance for Study Root QR Information Model - FIND SOP Class C-FIND-SCU

Detail regarding the Dataset Specific response behavior will be reported in this section.

Table 59: Supported Query Keys for Study Root Information Model

Study Root Information Model				
Attribute Name	Tag	VR	Type Of Matching	Comment
Query/Retrieve Level Specific Character Set	0008,0052	CS	Single Value	Study, Series, Image
	0008,0005	CS		
Q/R Image level				
Instance Number	0020,0013	IS		
Series Instance UID	0020,000E	UI	List Of UID,Universal	
SOP Instance UID	0008,0018	UI		
Study Instance UID	0020,000D	UI	List Of UID,Universal	
Q/R Series level				
Body Part Examined	0018,0015	CS		
Laterality	0020,0060	CS		
Modality	0008,0060	CS		
Operators' Name	0008,1070	PN		
Patient ID	0010,0020	LO	Single Value,Universal,WildCard	
Patient Position	0018,5100	CS		
Performed Procedure Step Description	0040,0254	LO		
Performed Procedure Step Start Date	0040,0244	DA		
Performed Procedure Step Start Time	0040,0245	TM		
Protocol Name	0018,1030	LO		
Series Date	0008,0021	DA		
Series Description	0008,103E	LO		
Series Instance UID	0020,000E	UI	List Of UID,Universal	
Series Number	0020,0011	IS		
Series Time	0008,0031	TM		
Study Instance UID	0020,000D	UI	List Of UID,Universal	
Performed Protocol Code Sequence	0040,0260	SQ		
Request Attributes Sequence	0040,0275	SQ		

Q/R Study level			
Accession Number	0008,0050	SH	
Additional Patient History	0010,21B0	LT	
Admitting Diagnoses Description	0008,1080	LO	
Ethnic Group	0010,2160	SH	
Interpretation Author (retired)	4008,010C	PN	
Modalities in Study	0008,0061	CS	
Name of Physician(s) Reading Study	0008,1060	PN	
Number of Patient Related Instances	0020,1204	IS	
Number of Patient Related Series	0020,1202	IS	
Number of Patient Related Studies	0020,1200	IS	
Number of Study Related Instances	0020,1208	IS	
Number of Study Related Series	0020,1206	IS	
Occupation	0010,2180	SH	
Other Patient IDs	0010,1000	LO	
Other Patient Names	0010,1001	PN	
Other Study Numbers (retired)	0020,1070	IS	
Patient Comments	0010,4000	LT	
Patient ID	0010,0020	LO	Single Value, Universal, WildCard
Patient's Age	0010,1010	AS	
Patient's Birth Date	0010,0030	DA	
Patient's Birth Time	0010,0032	TM	
Patient's Name	0010,0010	PN	Single Value, Universal, WildCard
Patient's Sex	0010,0040	CS	Single Value, Universal
Patient's Size	0010,1020	DS	
Patient's Weight	0010,1030	DS	
Physician(s) of Record	0008,1048	PN	
Referring Physician's Name	0008,0090	PN	Single Value, Universal
Study Date	0008,0020	DA	Range, Universal
Study Description	0008,1030	LO	
Study ID	0020,0010	SH	Single Value, Universal
Study Instance UID	0020,000D	UI	List Of UID, Universal
Study Time	0008,0030	TM	
Referenced Patient Sequence	0008,1120	SQ	
Referenced Study Sequence	0008,1110	SQ	

This part of the section includes the dataset specific behavior, i.e. error codes, error and exception handling, time-outs, etc.

Table 60: Status Response

Service Status	Error Code	Further Meaning	Behavior
Success	0000	Matching is complete	The SCU has successfully returned all matching information
*	*	Failed Communication	Error code is logged. The Association is aborted using A-ABORT

4.2.3.3.3. (Real-World) Activity – MOVE As SCU

4.2.3.3.3.1. Description and Sequencing of Activities

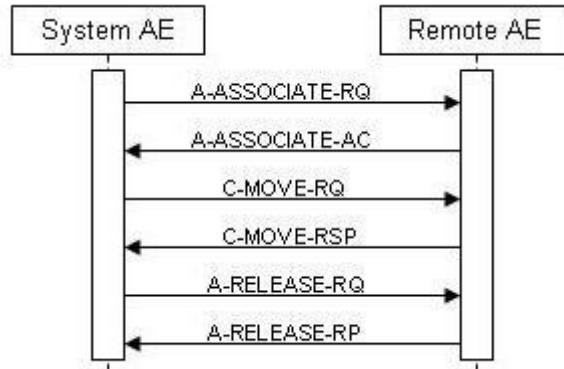

Figure 10: (Real World) Activity - MOVE as SCU

Patient Data Manager initiates an association when some application asks for images transfer from a specified source device to a specified target device. If Patient Data Manager fails to move all the required images, it waits for some default duration and then release initiate the association.

4.2.3.3.3.2. Proposed Presentation Contexts

Each time an association is initiated, the association initiator proposes a number of presentation contexts to be used on that association. In this subsection, the presentation contexts proposed by Patient Data manager for (Real World) Activity - MOVE as SCU are defined.

Table 61: Proposed Presentation Contexts for (Real-World) Activity – MOVE As SCU

Presentation Context Table					
Abstract Syntax		Transfer Syntax		Role	Extended Negotiation
Name	UID	Name List	UID List		
Study Root QR Information Model - MOVE SOP Class	1.2.840.10008.5.1.4.1.2.2.2	Explicit VR Big Endian	1.2.840.10008.1.2.2	SCU	None
		Explicit VR Little Endian	1.2.840.10008.1.2.1		
		Implicit VR Little Endian	1.2.840.10008.1.2		

4.2.3.3.3.3. SOP Specific Conformance for Study Root QR Information Model - MOVE SOP Class

This section and sub-section include the manufacturer SOP and Dataset specific information as well the status codes and their corresponding behavior.

4.2.3.3.3.1. Dataset Specific Conformance for Study Root QR Information Model - MOVE SOP Class C-MOVE-SCU

Detail regarding the Dataset Specific response behavior will be reported in this section.

Table 62: Identifiers for MOVE Study Root Information Model as SCU

Study Root Information Model			
Attribute Name	Tag	VR	Comment
Query/Retrieve Level	0008,0052	CS	
Q/R Image level			
Series Instance UID	0020,000E	UI	
SOP Instance UID	0008,0018	UI	
Study Instance UID	0020,000D	UI	
Q/R Series level			
Series Instance UID	0020,000E	UI	
Study Instance UID	0020,000D	UI	
Q/R Study level			
Study Instance UID	0020,000D	UI	

This part of the section includes the dataset specific behavior, i.e. error codes, error and exception handling, time-outs, etc.

Table 63: Status Response

Service Status	Error Code	Further Meaning	Behavior
Success	0000	Success	The SCU has successfully returned all matching information
Error	*	All error codes	Error code is logged. The Association is aborted using A-ABORT
Warning	*	All warning codes	Error code is logged. The Association is aborted using A-ABORT

4.2.3.4. Association Acceptance Policy

The RIS does not handle association acceptance policy.

4.2.4. RIS

Detail of this specific Application Entity is specified in this section.

4.2.4.1. SOP Classes

This Application Entity provides Standard Conformance to the following SOP Classes.

Table 64: SOP Classes for RIS

SOP Class Name	SOP Class UID	SCU	SCP
Modality Performed Procedure Step SOP Class	1.2.840.10008.3.1.2.3.3	Yes	No
Modality Worklist Information Model - FIND SOP Class	1.2.840.10008.5.1.4.31	Yes	No
Verification SOP Class	1.2.840.10008.1.1	Yes	No

Note: Any SOP specific behavior is documented later in the conformance statement in the applicable SOP specific conformance section.

4.2.4.2. Association Policies

Each AE specification contains a description of the general association establishment and acceptance policies of the AE.

4.2.4.2.1. General

The DICOM standard application context is specified below.

Table 65: DICOM Application Context

Description	Value
Application Context Name	1.2.840.10008.3.1.1.1

4.2.4.2.2. Number of Associations

The number of simultaneous associations that an Application Entity may support as a Initiator or Acceptor is specified here.

Table 66: Number of associations as an Association Initiator for this AE

Description	Value
Maximum number of simultaneous associations	1

Table 67: Number of associations as an Association Acceptor for this AE

Description	Value
Maximum number of simultaneous associations	0

4.2.4.2.3. Asynchronous Nature

The implementation supports negotiation of multiple outstanding transactions, along with the maximum number of outstanding transactions supported.

Table 68: Asynchronous nature as an Association Initiator for this AE

Description	Value
Maximum number of outstanding asynchronous transactions	none

4.2.4.2.4. Implementation Identifying Information

The value supplied for Implementation Class UID and version name are documented here.

Table 69: DICOM Implementation Class and Version for RIS

Implementation Class UID	1.2.840.113704.9.1000.1.1
Implementation Version Name	MX 16-slice 1.0

4.2.4.2.5. Communication Failure Handling

The behavior of the AE during communication failure is summarized in the next table.

Table 70: Communication Failure Behavior

Exception	Behavior
Timeout	The association is aborted using A-ABORT.
Association aborted	A message: "Worklist connection failed" is popup

4.2.4.3. Association Initiation Policy

The behavior of this Application Entity is summarized in the next Table.

Table 71: Response Status Handler Behavior

Service Status	Error Code	Further Meaning	Behavior
Success	0000	Matching is completed	The SCP has successfully returned all matching information
*	*		The SCP does not complete the matching

4.2.4.3.1. (Real-World) Activity – Verification as SCU

4.2.4.3.1.1. Description and Sequencing of Activities

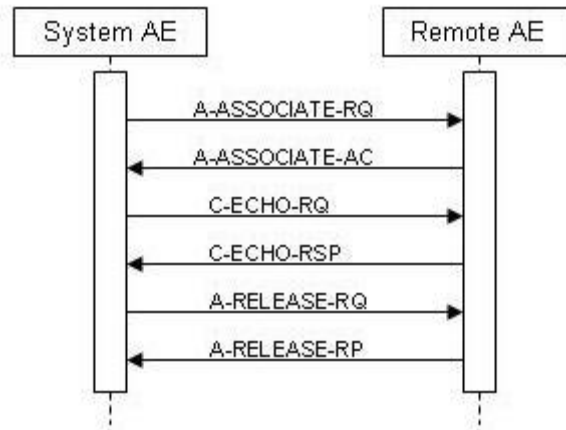

Figure 11: (Real World) Activity - Verification as SCU

The user can do verification by using the server menu for configuration RIS setting by click on the "Test" button.

The system sends out a DICOM Association message following by the C-ECHO message.

4.2.4.3.1.2. Proposed Presentation Contexts

The presentation contexts are defined in the next table.

Table 72: Proposed Presentation Contexts for (Real-World) Activity – Verification as SCU

Presentation Context Table					
Abstract Syntax		Transfer Syntax		Role	Extended Negotiation
Name	UID	Name List	UID List		
Verification SOP Class	1.2.840.10008.1.1	Explicit VR Big Endian	1.2.840.10008.1.2.2	SCU	None
		Explicit VR Little Endian	1.2.840.10008.1.2.1		
		Implicit VR Little Endian	1.2.840.10008.1.2		

4.2.4.3.1.3. SOP Specific Conformance for Verification SOP Class

This section and sub-section include the manufacturer SOP and Dataset specific information as well the status codes and their corresponding behavior.

4.2.4.3.1.3.1. Dataset Specific Conformance for Verification C-ECHO SCU

Detail regarding the Dataset Specific response behavior will be reported in this section.

This part of the section includes the dataset specific behavior, i.e. error codes, error and exception handling, time-outs, etc.

Table 73: Status Response

Service Status	Error Code	Further Meaning	Behavior
Success	0000	Communication with remote system is successful	The text "Connection Succeeded" is popup
*	*	Failed communication	Error code is logged and the text "Connection Failed" is popup

4.2.4.3.2. (Real-World) Activity – Modality worklist As SCU

4.2.4.3.2.1. Description and Sequencing of Activities

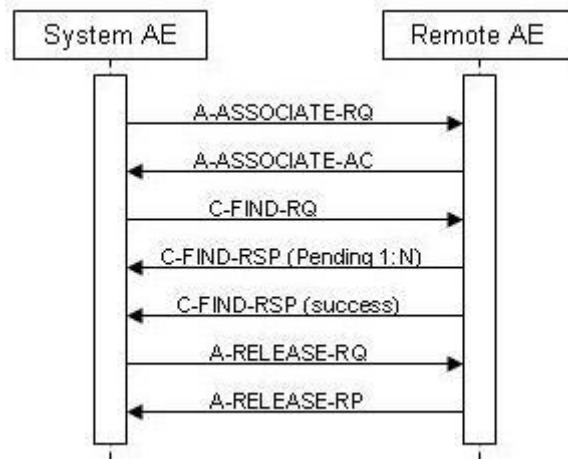

Figure 12: (Real World) Activity - Worklist request

The request for a worklist update is initiated by the user interaction, i.e. pressing the button "Scheduled" and "Worklist". A Query is send to the RIS for retrieve the patients. Default the Modality "CT" and "Today" for date is filled in.

By pressing on button "Search" a sub selection can be made for the Query request.

After retrieval of all responses the system will access the local database to or update patient demographic data. To protect the system from overflow a configurable limit is implemented.

The system will initiate an association in order to issue a C-FIND request according to the Modality Worklist Information Model.

4.2.4.3.2.2. Proposed Presentation Contexts

The presentation contexts are defined in the next table.

Table 74: Proposed Presentation Contexts for (Real-World) Activity – Modality worklist As SCU

Presentation Context Table					
Abstract Syntax		Transfer Syntax		Role	Extended Negotiation
Name	UID	Name List	UID List		
Modality Worklist Information Model - FIND SOP Class	1.2.840.10008.5.1.4.31	Explicit VR Big Endian	1.2.840.10008.1.2.2	SCU	None
		Explicit VR Little Endian	1.2.840.10008.1.2.1		
		Implicit VR Little Endian	1.2.840.10008.1.2		

4.2.4.3.2.3. SOP Specific Conformance for Modality Worklist Information Model - FIND SOP Class

This section and sub-section include the manufacturer SOP and Dataset specific information as well the status codes and their corresponding behavior.

4.2.4.3.2.3.1. Dataset Specific Conformance for Modality Worklist Information Model - FIND SOP Class C-FIND-SCU

Detail regarding the Dataset Specific response behavior will be reported in this section. The table below should be read as follows:

Attribute Name: Attributes supported to build a Modality Worklist Request Identifier.

Tag: DICOM tag for this attribute.

VR: DICOM VR for this attribute.

M: Matching Keys for (automatic) Worklist Update.

R: Return Keys. An “X” will indicate that this attribute as Return Key with

zero length for Universal Matching.

Q: Interactive Query Key. An “X” will indicate that this attribute as matching key can be used.

D: Displayed Keys. An “X” indicates that this Worklist attribute is displayed to the user during a patient registration dialog.

IOD: An “X” indicates that this Worklist attribute is included into all object Instances created during performance of the related Procedure

Step.

Type of matching: The following types of matching exists:

- Single Value Matching
- List of UID Matching
- Wild Card Matching
- Range Matching
- Sequence Matching
- Universal Matching

Table 75: Worklist Request Identifier

Attribute Name	Tag	VR	M	R	Q	D	IOD	Type of Matching	Comment
Patient Identification Module									
Other Patient IDs	0010,1000	LO		X	X	X	X		
Patient ID	0010,0020	LO	X		X	X	X	Single Value, Universal, WildCard	

Attribute Name	Tag	VR	M	R	Q	D	IOD	Type of Matching	Comment
Patient's Name	0010,0010	PN	X		X	X	X	Single Value, Universal, WildCard	
Patient Demographic Module									
Patient Comments	0010,4000	LT		X	X	X			
Patient's Age	0010,1010	AS		X	X	X			
Patient's Birth Date	0010,0030	DA		X	X	X			
Patient's Sex	0010,0040	CS		X	X	X			
Patient's Size	0010,1020	DS		X	X	X			
Patient's Weight	0010,1030	DS		X	X	X			
Scheduled Procedure Step Module									
Scheduled Procedure Step Sequence	0040,0100	SQ							
>Modality	0008,0060	CS	X				X	Single Value, Universal	
>Scheduled Performing Physician's Name	0040,0006	PN		X	X				
>Scheduled Procedure Step Description	0040,0007	LO		X	X		X		
>Scheduled Procedure Step ID	0040,0009	SH		X	X				
>Scheduled Procedure Step Start Date	0040,0002	DA	X	X	X			Range, Single Value, Universal	
>Scheduled Procedure Step Start Time	0040,0003	TM		X	X				
>Scheduled Station AE Title	0040,0001	AE		X	X				
>Scheduled Station Name	0040,0010	SH		X	X				
>Scheduled Protocol Code Sequence	0040,0008	SQ		X	X		X		
Requested Procedure Module									
Requested Procedure Description	0032,1060	LO		X	X		X		
Requested Procedure ID	0040,1001	SH		X	X		X		
Study Instance UID	0020,000D	UI		X	X		X		
Referenced Study Sequence	0008,1110	SQ			X		X		
Requested Procedure Code Sequence	0032,1064	SQ		X	X		X		
>Code Value	0008,0100	SH							
>Coding Scheme Designator	0008,0102	SH							
Imaging Service Request Module									
Accession Number	0008,0050	SH	X	X	X	X		Single Value	
Referring Physician's Name	0008,0090	PN	X	X	X	X		Single Value, Universal, WildCard	
Requesting Physician	0032,1032	PN		X	X	X			
SOP Common Module									
Specific Character Set	0008,0005	CS	X						

This part of the section includes the dataset specific behavior, i.e. error codes, error and exception handling, time-outs, etc.

Table 76: Status Response

Service Status	Error Code	Further Meaning	Behavior
Success	0000	Matching is complete	The SCU has successfully returned all matching information
*	*	All other error codes	Error code is logged. The association is aborted using A-Abort and the worklist query is marked as failed

4.2.4.3.3. (Real-World) Activity – Modality Performed Procedure Step As SCU

4.2.4.3.3.1. Description and Sequencing of Activities

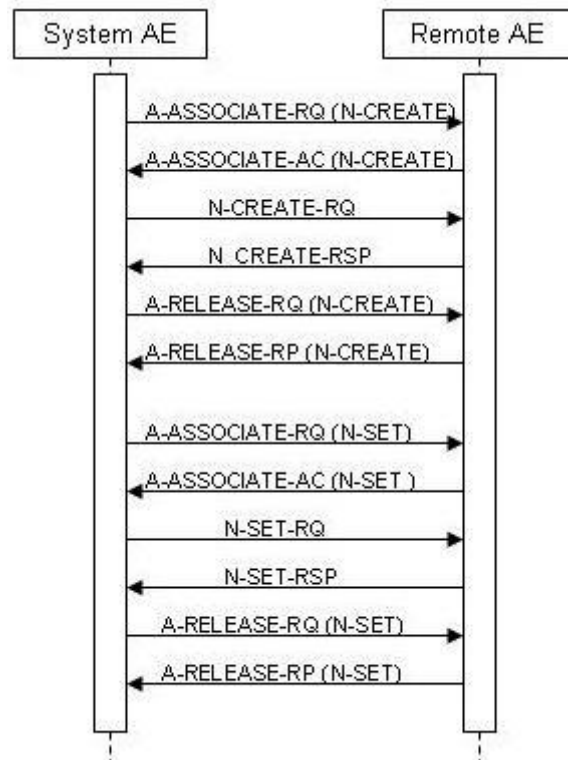

Figure 13: (Real World) Activity - MPPS as SCU

After patient registration, the system create a MPPS SOP Instance. An association to the configured MPPS SCP is established.

A manual update can be performed with the MPPS user interface where it is possible to set the final state of the MPPS to "COMPLETED". A MPPS instances has been sent.

The system supports creation of "unscheduled cases" by allowing MPPS Instance to be communication for locally registered patients.

N-CREATE request according to the create MPPS SOP Instance operation or a N-SET requests to update the contents and state of the MPPS.

A possible sequence of interaction between workflow and a departmental scheduler can be:

- The AE opens an association between the workflow with the departmental scheduler.
- The AE send a N-CREATE request to the scheduler to create an MPPS instance with status "IN PROCESS"
- The AE close the association. All images are acquired and stored in the local database.
- The AE open and association with the scheduler again.

- The AE sends an N-SET request to the scheduler to update the MPPS instance with status "COMPLETED".
- The AE closed the association with the scheduler again.

4.2.4.3.3.2. Proposed Presentation Contexts

The presentation contexts are defined in the next table.

Table 77: Proposed Presentation Contexts for (Real-World) Activity – Modality Performed Procedure Step As SCU

Presentation Context Table					
Abstract Syntax		Transfer Syntax		Role	Extended Negotiation
Name	UID	Name List	UID List		
Modality Performed Procedure Step SOP Class	1.2.840.10008.3.1.2.3.3	Explicit VR Big Endian	1.2.840.10008.1.2.2	SCU	None
		Explicit VR Little Endian	1.2.840.10008.1.2.1		
		Implicit VR Little Endian	1.2.840.10008.1.2		

4.2.4.3.3.3. SOP Specific Conformance for Modality Performed Procedure Step SOP Class

This section and sub-section include the manufacturer SOP and Dataset specific information as well the status codes and their corresponding behavior.

4.2.4.3.3.3.1. Dataset Specific Conformance for Modality Performed Procedure Step SOP Class N-CREATE-SCU

Detail regarding the Dataset Specific response behavior will be reported in this section.

Table 78: MPPS Request Identifiers for N-CREATE-RQ

Attribute Name	Tag	VR	Value	Comment
Performed Procedure Step Relationship Module				
Patient ID	0010,0020	LO		
Patient's Birth Date	0010,0030	DA		
Patient's Name	0010,0010	PN		
Patient's Sex	0010,0040	CS		
Referenced Patient Sequence	0008,1120	SQ		
Scheduled Step Attributes Sequence	0040,0270	SQ		
>Accession Number	0008,0050	SH		
>Requested Procedure Description	0032,1060	LO		
>Requested Procedure ID	0040,1001	SH		
>Scheduled Procedure Step Description	0040,0007	LO		
>Scheduled Procedure Step ID	0040,0009	SH		
>Study Instance UID	0020,000D	UI		
>Referenced Study Sequence	0008,1110	SQ		
>Scheduled Protocol Code Sequence	0040,0008	SQ		

Attribute Name	Tag	VR	Value	Comment
Performed Procedure Step Information Module				
Performed Location	0040,0243	SH		
Performed Procedure Step Description	0040,0254	LO		
Performed Procedure Step End Date	0040,0250	DA		
Performed Procedure Step End Time	0040,0251	TM		
Performed Procedure Step ID	0040,0253	SH		
Performed Procedure Step Start Date	0040,0244	DA		
Performed Procedure Step Start Time	0040,0245	TM		
Performed Procedure Step Status	0040,0252	CS		
Performed Procedure Type Description	0040,0255	LO		
Performed Station AE Title	0040,0241	AE		
Performed Station Name	0040,0242	SH		
Procedure Code Sequence	0008,1032	SQ		
Image Acquisition Results Module				
Modality	0008,0060	CS		
Study ID	0020,0010	SH		
Performed Protocol Code Sequence	0040,0260	SQ		
Performed Series Sequence	0040,0340	SQ		
SOP Common Module				
Specific Character Set	0008,0005	CS		

This part of the section includes the dataset specific behavior, i.e. error codes, error and exception handling, time-outs, etc.

Table 79: Status Response

Service Status	Error Code	Further Meaning	Behavior
Success	0000	Success	The SCP has completed
*	*	All other error codes	Error code is logged. The SCP cannot completed. The N-Set message will not perform

4.2.4.3.3.3.2. Dataset Specific Conformance for Modality Performed Procedure Step SOP Class N-SET-SCU

Detail regarding the Dataset Specific response behavior will be reported in this section.

Table 80: MPPS Request Identifiers for N-SET-RQ

Attribute Name	Tag	VR	Value	Comment
Performed Procedure Step Information Module				
Performed Procedure Step End Date	0040,0250	DA		
Performed Procedure Step End Time	0040,0251	TM		
Performed Procedure Step Status	0040,0252	CS		
Image Acquisition Results Module				
Performed Series Sequence	0040,0340	SQ		

Attribute Name	Tag	VR	Value	Comment
>Operators' Name	0008,1070	PN		
>Performing Physician's Name	0008,1050	PN		
>Protocol Name	0018,1030	LO		
>Retrieve AE Title	0008,0054	AE		
>Series Description	0008,103E	LO		
>Series Instance UID	0020,000E	UI		
>Referenced Image Sequence	0008,1140	SQ		
>Referenced Non-Image Composite SOP Instance Sequence	0040,0220	SQ		
Radiation Dose Module				
Comments on Radiation Dose	0040,0310	ST		
Total Number of Exposures	0040,0301	US		
Exposure Dose Sequence	0040,030E	SQ		
Additional Module				
Implementor ID group 00E1	00E1,0010	LO		
ELSCINT1_DLP_TOTAL (private)	00E1,1021	DS		

This part of the section includes the dataset specific behavior, i.e. error codes, error and exception handling, time-outs, etc.

Table 81: Status Response

Service Status	Error Code	Further Meaning	Behavior
Success	0000	Success	The SCP has completed
*	*	All other error codes	Error code is logged. The SCP cannot completed

4.2.4.4. Association Acceptance Policy

The RIS AE does not handle association acceptance policy

4.2.5. StorageSCU

Detail of this specific Application Entity is specified in this section.

4.2.5.1. SOP Classes

This Application Entity provides Standard Conformance to the following SOP Classes.

Table 82: SOP Classes for StorageSCU

SOP Class Name	SOP Class UID	SCU	SCP
CT Image Storage SOP Class	1.2.840.10008.5.1.4.1.1.2	Yes	No
Secondary Capture Image Storage SOP Class	1.2.840.10008.5.1.4.1.1.7	Yes	No
Storage Commitment Push Model SOP Class	1.2.840.10008.1.20.1	Yes	No
Verification SOP Class	1.2.840.10008.1.1	Yes	No

Note: Any SOP specific behavior is documented later in the conformance statement in the applicable SOP specific conformance section.

4.2.5.2. Association Policies

Each AE specification contains a description of the general association establishment and acceptance policies of the AE.

4.2.5.2.1. General

The DICOM standard application context is specified below.

Table 83: DICOM Application Context

Description	Value
Application Context Name	1.2.840.10008.3.1.1.1

4.2.5.2.2. Number of Associations

The number of simultaneous associations that an Application Entity may support as a Initiator or Acceptor is specified here.

Table 84: Number of associations as an Association Initiator for this AE

Description	Value
Maximum number of simultaneous associations	1

Table 85: Number of associations as an Association Acceptor for this AE

Description	Value
Maximum number of simultaneous associations	0

4.2.5.2.3. Asynchronous Nature

The implementation supports negotiation of multiple outstanding transactions, along with the maximum number of outstanding transactions supported.

Table 86: Asynchronous nature as an Association Initiator for this AE

Description	Value
Maximum number of outstanding asynchronous transactions	none

4.2.5.2.4. Implementation Identifying Information

The value supplied for Implementation Class UID and version name are documented here.

Table 87: DICOM Implementation Class and Version for StorageSCU

Implementation Class UID	1.2.840.113704.9.1000.1.1
Implementation Version Name	MX 16-slice 1.0

4.2.5.2.5. Communication Failure Handling

The behavior of the AE during communication failure is summarized in the next table.

Table 88: Communication Failure Behavior

Exception	Behavior
Timeout	The association is aborted using A-ABORT.
Association aborted	The association is aborted using A-ABORT.
DIMSE Timeout	The association is aborted using A-ABORT

4.2.5.3. Association Initiation Policy**4.2.5.3.1. (Real-World) Activity – Verification as SCU****4.2.5.3.1.1. Description and Sequencing of Activities**

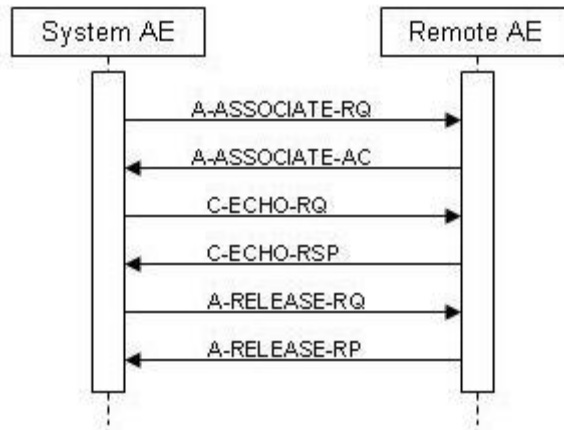

Figure 14: (Real World) Activity - Verification as SCU

The user can do verification by using the server menu for configuration RIS setting by click on the "Test" button.

The system sends out a DICOM Association message following by the C-ECHO message.

4.2.5.3.1.2. Proposed Presentation Contexts

The presentation contexts are defined in the next table.

Table 89: Proposed Presentation Contexts for (Real-World) Activity – Verification as SCU

Presentation Context Table					
Abstract Syntax		Transfer Syntax		Role	Extended Negotiation
Name	UID	Name List	UID List		
Verification SOP Class	1.2.840.10008.1.1	Explicit VR Big Endian	1.2.840.10008.1.2.2	SCU	None
		Explicit VR Little Endian	1.2.840.10008.1.2.1		
		Implicit VR Little Endian	1.2.840.10008.1.2		

4.2.5.3.1.3. SOP Specific Conformance for Verification SOP Class

This section and sub-section include the manufacturer SOP and Dataset specific information as well the status codes and their corresponding behavior.

4.2.5.3.1.3.1. Dataset Specific Conformance for Verification C-ECHO SCU

Detail regarding the Dataset Specific response behavior will be reported in this section.

This part of the section includes the dataset specific behavior, i.e. error codes, error and exception handling, time-outs, etc.

Table 90: Status Response

Service Status	Error Code	Further Meaning	Behavior
Success	0000	Communication with remote system is successful	The text "Connection Succeeded" is popup
*	*	Failed communication	Error code is logged and the text "Connection Failed" is popup

4.2.5.3.2. (Real-World) Activity – Image Export

4.2.5.3.2.1. Description and Sequencing of Activities

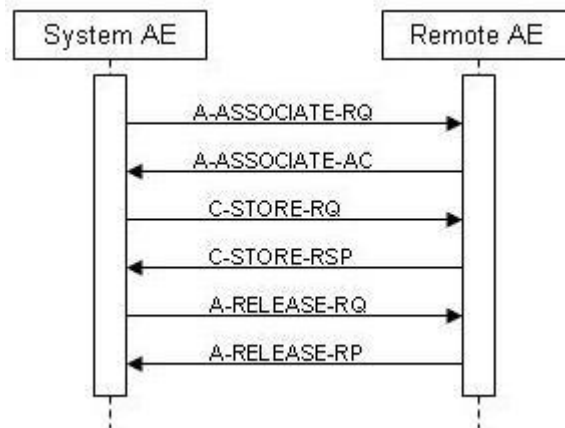

Figure 15: (Real World) Activity - Image Export

User can select a Study(s), Series or Image(s) and send (Copy To) them to the remote system.
 During the transfer include if available the storage commitment the job will stay in the queue.
 After the job is finished the queue is cleaned for this job.

Another way of sending is the AutoStore option. This will be used during scanning after every plan. If a plan is finished the job is send to the selected remote system(s).
 In this situation there is no queuing of the jobs.

The third method of sending is the save of the changes made in the viewer (ex. annotations). There can be saved as secondary and primary to local, media or remote systems. Also these jobs will not be queued.
 By saving of primary the original image will be saved. Updates in the viewer can only saved by secondary and as Secondary Capture SOP Class.

The MX 16-slice attempts to initiate a new association in order to issue a C-STORE requests. If the stored job contains multiple images then multiple C-STORE requests will be issued over de same association.

If the remote system is configured as an archive device the MX 16-slice will send a Storage Commitment after the association of the C-STORE is released.

4.2.5.3.2.2. Proposed Presentation Contexts

The presentation contexts are defined in the next table.

Table 91: Proposed Presentation Contexts for (Real-World) Activity – Image Export

Presentation Context Table					
Abstract Syntax		Transfer Syntax		Role	Extended Negotiation
Name	UID	Name List	UID List		
CT Image Storage SOP Class	1.2.840.10008.5.1.4.1.1.2	Explicit VR Big Endian	1.2.840.10008.1.2.2	SCU	None
		Explicit VR Little Endian	1.2.840.10008.1.2.1		
		Implicit VR Little Endian	1.2.840.10008.1.2		
Secondary Capture Image Storage SOP Class	1.2.840.10008.5.1.4.1.1.7	Explicit VR Big Endian	1.2.840.10008.1.2.2	SCU	None
		Explicit VR Little Endian	1.2.840.10008.1.2.1		
		Implicit VR Little Endian	1.2.840.10008.1.2		

4.2.5.3.2.3. SOP Specific Conformance for Storage SOP Classes

This section and sub-section include the manufacturer SOP and Dataset specific information as well the status codes and their corresponding behavior.

4.2.5.3.2.3.1. Dataset Specific Conformance for C-STORE-RQ

Detail regarding the Dataset Specific response behavior will be reported in this section. This includes the dataset specific behavior, i.e. error codes, error and exception handling, time-outs, etc.

Table 92: Status Response

Service Status	Error Code	Further Meaning	Behavior
Success	0000	Successful stored	The SCP has completed
Failure	A7xx	Out of Resources	Error code is logged and connection is closed
	A9xx	Error: Data Set does not match SOP Class	Error code is logged and connection is closed
	Cxxx	Error: cannot understand	Error code is logged and connection is closed
Warning	*	Unknown Failures	Error code is logged and connection is closed
	0107	Attribute List Error	Error code is logged and C-Store continued
	0116	Attribute Value Out of Range	Error code is logged and C-Store continued
	B000	Coercion of Data Elements	Error code is logged and C-Store continued
	B007	Data Set does not match SOP Class	Error code is logged and C-Store continued
	B006	Elements Discarded	Error code is logged and C-Store continued

4.2.5.3.3. (Real-World) Activity – Storage Commitment Push Model AS SCU

4.2.5.3.3.1. Description and Sequencing of Activities

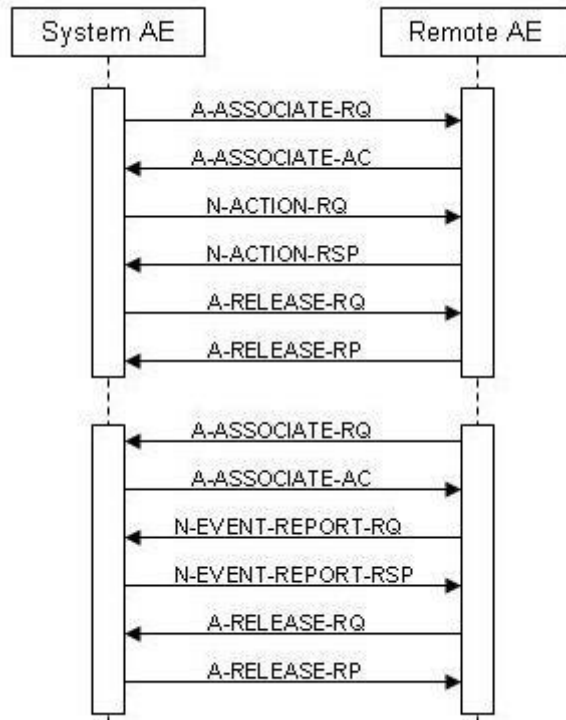

Figure 16: (Real World) Activity - Asynchronous Storage Commitment Push model as SCU

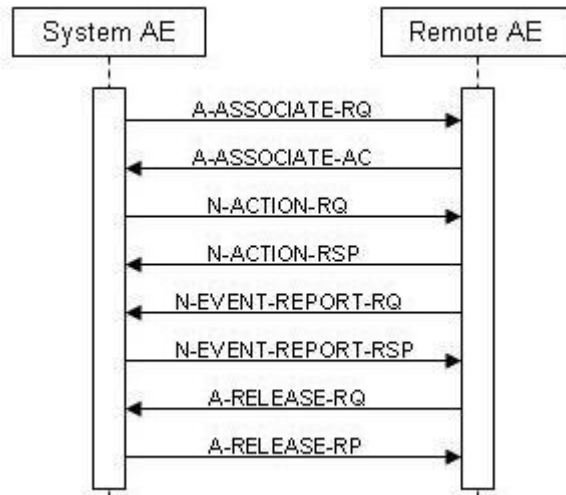

Figure 17: (Real World) Activity - Synchronous Storage Commitment Push model as SCU

If the remote system is configured as an archive device the system will after the images are sent close the connection.

In a new association a storage commitment request (N-ACTION) will be done. The association stays open for a maximum of the timeout. Inside this timeout the N-EVENT-REPORT-RQ of the remote system can be received. This will be called synchronous storage commitment.

4.2.5.3.3.2. Proposed Presentation Contexts

The presentation contexts are defined in the next table.

Table 93: Proposed Presentation Contexts for (Real-World) Activity – Storage Commitment Push Model AS SCU

Presentation Context Table					
Abstract Syntax		Transfer Syntax		Role	Extended Negotiation
Name	UID	Name List	UID List		
Storage Commitment Push Model SOP Class	1.2.840.10008.1.20.1	Explicit VR Big Endian	1.2.840.10008.1.2.2	SCU	None
		Explicit VR Little Endian	1.2.840.10008.1.2.1		
		Implicit VR Little Endian	1.2.840.10008.1.2		

4.2.5.3.3.3. SOP Specific Conformance for Storage Commitment Push Model SOP Class

This section and sub-section include the manufacturer SOP and Dataset specific information as well as the status codes and their corresponding behavior.

4.2.5.3.3.3.1. Dataset Specific Conformance for Storage Commitment Push Model SOP Class N-EVENT-REPORT-SCP

Detail regarding the Dataset Specific response behavior will be reported in this section.

This part of the section includes the dataset specific behavior, i.e. error codes, error and exception handling, time-outs, etc.

Table 94: Storage Commitment attribute for N-EVENT-REPORT

Event TypeName	EVENTType ID	Attribute Name	Tag	Commit
StorageCommitmentRequestSuccessful	1	Transaction UID	0008,1195	
		Referenced SOP Sequence	0008,1199	
		>Referenced SOP Class UID	0008,1150	
		>Referenced SOP Instance UID	0008,1155	
StorageCommitmentRequestCompleteFailures Exist	1	Transaction UID	0008,1195	
		Referenced SOP Sequence	0008,1199	
		>Referenced SOP Class UID	0008,1150	
		>Referenced SOP Instance UID	0008,1155	
	2	Transaction UID	0008,1195	
		Failed SOP Sequence	0008,1198	
		>Referenced SOP Class UID	0008,1150	
		>Referenced SOP Instance UID	0008,1155	
		>Failure Reason	0008,1197	

On receiving a storage commitment result with Event Type ID 1 (Storage Commitment Request Successful) the Application Entity will mark these images as committed. On receiving a storage commitment result with Event Type ID 2 (Storage Commitment Request Complete - Failures Exist) the Application Entity will behave as described in next table.

Table 95: Storage Commitment N-EVENT-REPORT Failure Handling Behavior

ServiceStatus	Error Code	Further Meaning	Description
Failure	0110	Processing Failure	

Table 96: Status Response

Service Status	Error Code	Further Meaning	Behavior
Success	0000	Success	The SCP has complete his job

4.2.5.3.3.3.2. Dataset Specific Conformance for Storage Commitment Push Model SOP Class N-ACTION-SCU

Detail regarding the Dataset Specific response behavior will be reported in this section.

Table 97: Storage Commitment Attribute for N-ACTION-RQ

Attribute Name	Tag	Comment
Storage Commitment Module		
Transaction UID	0008,1195	
Referenced SOP Sequence	0008,1199	
>Referenced SOP Class UID	0008,1150	
>Referenced SOP Instance UID	0008,1155	

This part of the section includes the dataset specific behavior, i.e. error codes, error and exception handling, time-outs, etc.

Table 98: Status Response

Service Status	Error Code	Further Meaning	Behavior
Success	0000	Success	The SCP has completed
*	*	All other error codes	Error code is logged. The SCP does not completed the job

4.2.5.4. Association Acceptance Policy

The StorageSCU AE does not handle the association acceptance policy

4.3. Network Interfaces

4.3.1. Physical Network Interfaces

The System provides only DICOM V3.0 TCP/IP Network Communication Support as defined in PS 3.8 of the standard.

TCP/IP is the only protocol stack supported.

The MX 16-slice inherits its TCP/IP stack from Windows XP (i.e. the operation system platform).

The MX 16-slice supports a single network interface: Ethernet ISO. 802.3 with supported physical medium include:

- IEEE 802.3-1995, 10BASE-T
- IEEE 802.3-1995, 100BASE-TX (Fast Ethernet)
- IEEE 802.3, 1000BASE-X (Fiber Optic Gigabit Ethernet).

4.3.2. Additional Protocols

Not applicable

4.4. Configuration

Any implementation's DICOM conformance may be dependent upon configuration, which takes place at the time of installation. Issues concerning configuration are addressed in this section.

4.4.1. AE Title/Presentation Address Mapping

An important installation issue is the translation from AE title to presentation address. How this is to be performed is described here.

4.4.1.1. Local AE Titles

The local AE title mapping and configuration are specified as:

Table 99: AE Title configuration table

Application Entity	Default AE Title	Default TCP/IP Port
RIS AE (worklist)	CHORUS_MOD	
RIS AE (MPPS)	CHORUS_MOD	
StorageSCU AE (STORE)	CHORUS_MOD	
StorageSCU AE (Storage Commitment)	CHORUS_MOD	204
Print AE	CHORUS_MOD	
QRSCU AE	CHORUS_MOD	
DICOMSCP AE	CHORUS_MOD	104

4.4.1.2. Remote AE Title/Presentation Address Mapping

The configuration of the remote application is specified here.

Table 100: Defined remote parameters worklist for RIS AE

Description	Default
Worklist AE	
Worklist Port	
Worklist IP	

Table 101: Defined remote parameters MPPS for RIS AE

Description	Default
MPPS AE	
MPPS Port	
MPPS IP	

Table 102: Defined remote parameters StorageSCU AE

Description	Default
RemoteAE	
IP	
Port	
Remote Commit AE	
Remote Commit IP	
Remote Commit port	

Table 103: Defined remote parameters QRSCU AE

Description	Default
Remote AE	
IP	
Port	

Table 104: Defined remote parameters DICOM SCP

Description	Default
Calling Title	

4.4.2. Parameters

The specification of important operational parameters, their default value and range (if configurable) are specified here.

Table 105: Configuration Parameters Table

Parameter	Configurable	Default Value
General Parameter		
Max PDU receive size	No	0 (=65535)
Max PDU send size	No	0 (=65535)
RIS AE Specific Parameters		
Max Patient Count (worklist)	Yes	100
ARTimeout (worklist)	Yes	10 seconds

Parameter	Configurable	Default Value
DIMSE Timeout (worklist)	Yes	20 seconds
ARTimeout (MPPS)	Yes	10 seconds
DIMSE Timeout (MPPS)	Yes	60 seconds
StorageSCU AE Specific Parameters		
ARTimeout (storage)	Yes	10 seconds
DIMSE Timeout (storage)	Yes	30 seconds
ARTimeout (Storage Commitment)	Yes	10 seconds
DIMSE Timeout (storage Commitment)	Yes	10 seconds
QRSCU AE Specific Parameters		
ARTimeout	Yes	10 seconds
DIMSE Timeout	No	7200 seconds
DICOM SCP AE Specific Parameters		
ARTimeout	Yes	10 seconds
DIMSE Timeout	Yes	10 seconds
Print AE Specific Parameters		

5. MEDIA INTERCHANGE

5.1. Implementation model

The implementation model identifies the DICOM Application Entities for Media in specific implementation and relates the Application Entities to Real-World Activities.

5.1.1. Application Data Flow Diagram

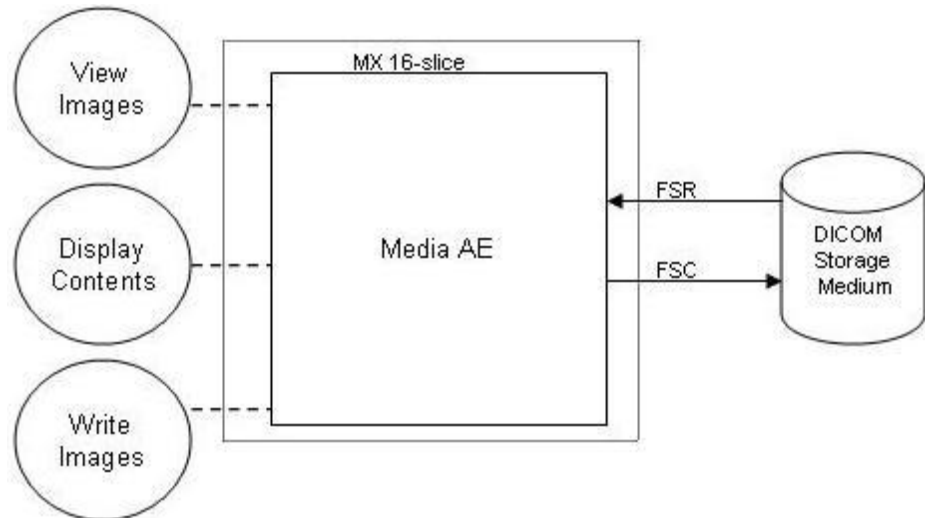

Figure 18: Media Application Data Flow Diagram

5.1.2. Functional Definitions of AE's

The MX 16-slice can write and read to different media's.
 The DICOM Standard protocol is used for writing to CD's and DVD's.
 For other media their own protocol is used.

The images on the CD or DVD can be viewed with the on CD or DVD available viewer.

The MX 16-slice cannot update a CD or DVD. An error message will be popup.

5.1.3. Sequencing of Real World Activities

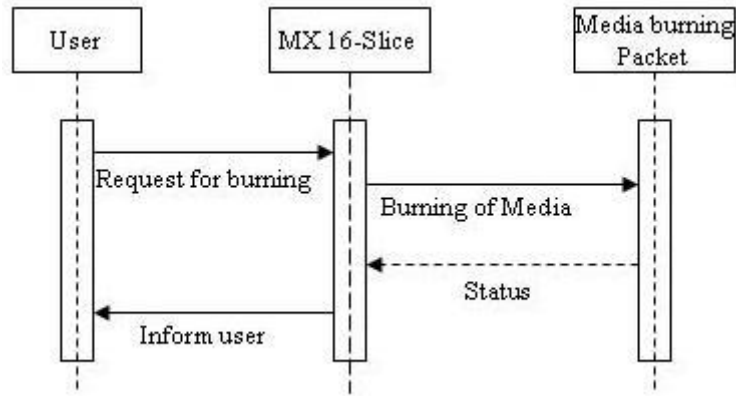

Figure 19: Sequence of Real World Activities - Media

After selection of the studies for the media the system check if the media is already used.
 An error message will be generated as popup on the screen if media is used.
 The MX 16-slice check for the size on the media. All selected images must be inside the maximum size of the one media.

5.2. AE Specifications

This section in the DICOM Conformance Statement specifies a set of Media Application Entities.

5.2.1. Media MX 16-slice Media - Specification

Table 106: AE Media MX 16-slice related Application Profiles, RWA activities and roles

Supported Application Profile	Identifier	Real-World Activities	Roles
General Purpose CD-R Interchange	STD-GEN-CD	Create File-set	FSC
		Read File-set	FSR

5.2.1.1. File Meta Information for the Media MX 16-slice

Table 107: File Meta Information for the Media MX 16-slice

Implementation Class UID	1.3.6.1.4.1.22275.0.0.1.0.0.0
Implementation Version Name	. MICDicomEngine10

5.2.1.2. Real-World Activities

The AE specification contains a description of the Real-World Activities, which invoke the particular AE.

5.2.1.2.1. RWA - Read File-set

This Media Application Entity has a File-set Reader functionality which is described here.

5.2.1.2.1.1. Media Storage Application Profile

The MX 16-slice use the default "General Purpose CD-R" application profile for reading the CD or DVD.

The MX 16-slice will read the CD or DVD for the "CT Image" and "Secondary Capture" SOP classes.

Reads images can be displayed with the MX 16-slice viewer.

5.2.1.2.1.1.1. Options

Not applicable.

5.2.1.2.2. RWA - Create File-set

This Media Application Entity has a File-set Creator functionality which is described here.

5.2.1.2.2.1. Media Storage Application Profile

The MX 16-slice write CD and DVD by using the "General Purpose CD-R Interchange" application profile.

The MX 16-slice can write more study of different patient on the same CD or DVD in one process.

Update of CD or DVD with a new study is not possible.

5.2.1.2.2.1.1. Options

Not applicable.

5.3. Augmented and Private Application Profiles

Not applicable

5.4. Media Configuration

Not applicable

6. SUPPORT OF CHARACTER SETS

Any support for character sets beyond the default character repertoire in Network and Media services is described here.

Table 108: Supported DICOM Character Sets of MX16-slice - Chorus - Neusoft

Character Set Description	Defined Term	ESC Sequence	ISO Registration Number	Code Element	Character Set
GB18030	GB18030	-	-	-	-
		-	-	-	-
Latin alphabet No. 1	ISO_IR 100	-	ISO-IR 6	G0	ISO 646
		-	ISO-IR 100	G1	Supplementary set of ISO 8859
Latin alphabet No. 2	ISO_IR 101	-	ISO-IR 6	G0	ISO 646
		-	ISO-IR 101	G1	Supplementary set of ISO 8859
Cyrillic	ISO_IR 144	-	ISO-IR 6	G0	ISO 646
		-	ISO-IR 144	G1	Supplementary set of ISO 8859
Unicode in UTF-8	ISO_IR 192	-	-	-	-
		-	-	-	-
Default repertoire	-	-	ISO-IR 6	G0	ISO 646
		-	-	-	-

7. SECURITY

7.1. Security Profiles

This version of the MX 16-slice does not satisfy the security as describe in the DICOM Standard.

7.1.1. Security use Profiles

Not applicable

7.1.2. Security Transport Connection Profiles

Not applicable

7.1.3. Digital Signature Profiles

Not applicable

7.1.4. Media Storage Security Profiles

Not applicable

7.1.5. Attribute Confidentiality Profiles

Not applicable

7.1.6. Network Address Management Profiles

Not applicable

7.1.7. Time Synchronization Profiles

Not applicable

7.1.8. Application Configuration Management Profiles

Not applicable

7.1.9. Audit Trail Profiles

Not applicable

7.2. Association Level Security

Not applicable

7.3. Application Level Security

Not applicable

8. ANNEXES OF APPLICATION "APPLICATION MX 16-SLICE"

8.1. IOD Contents

8.1.1. Created SOP Instance

This section specifies each IOD created by this application.

This section specifies each IOD created (including private IOD's). It should specify the attribute name, tag, VR, and value. The value should specify the range and source (e.g. user input, Modality Worklist, automatically generated, etc.). For content items in templates, the range and source of the concept name and concept values should be specified. Whether the value is always present or not shall be specified.

Abbreviations used in the IOD tables for the column "Presence of Module" are:

ALWAYS The module is always present
 CONDITIONAL The module is used under specified condition

Abbreviations used in the Module table for the column "Presence of Value" are:

ALWAYS The attribute is always present with a value
 EMPTY The attribute is always present without any value (attribute sent zero length)
 VNAP The attribute is always present and its Value is Not Always Present (attribute sent zero length if no value is present)
 ANAP The attribute is present under specified condition – if present then it will always have a value
 ANAPCV The attribute is present under specified condition – if present then its Value is Not Always Present (attribute sent zero length if condition applies and no value is present)
 ANAPEV The attribute is present under specified condition – if present then it will not have any value

The abbreviations used in the Module table for the column "Source" are:

AUTO The attribute value is generated automatically
 CONFIG The attribute value source is a configurable parameter
 COPY The attribute value source is another SOP instance
 FIXED The attribute value is hard-coded in the application
 IMPLICIT The attribute value source is a user-implicit setting
 MPPS The attribute value is the same as that use for Modality Performed Procedure Step
 MWL The attribute value source is a Modality Worklist
 USER The attribute value source is explicit user input

8.1.1.1. List of created SOP Classes

Table 109: List of created SOP Classes

SOP Class Name	SOP Class UID
CT Image Storage SOP Class	1.2.840.10008.5.1.4.1.1.2
Secondary Capture Image Storage SOP Class	1.2.840.10008.5.1.4.1.1.7

8.1.1.2. CT Image Storage SOP Class

Table 110: IOD of Created CT Image Storage SOP Class Instances

Information Entity	Module	Presence Of Module
Patient	Patient Module	
Study	General Study Module	
Study	Patient Study Module	
Series	General Series Module	
Frame of Reference	Frame of Reference Module	
Equipment	General Equipment Module	
Image	General Image Module	
Image	Image Plane Module	
Image	Image Pixel Module	
Image	Contrast/Bolus Module	
Image	CT Image Module	
Image	VOI LUT Module	
Image	SOP Common Module	
	Additional Module	

Table 111: Patient Module

Attribute Name	Tag	VR	Value	Presence of Value	Source	Comment
Patient Comments	0010,4000	LT		VNAP	MWL, USER	
Patient ID	0010,0020	LO		ALWAYS	MWL, USER	
Patient's Birth Date	0010,0030	DA		ALWAYS	MWL, USER	
Patient's Name	0010,0010	PN		ALWAYS	MWL, USER	
Patient's Sex	0010,0040	CS	F, M, O	ALWAYS	MWL, USER	

Table 112: General Study Module

Attribute Name	Tag	VR	Value	Presence of Value	Source	Comment
Accession Number	0008,0050	SH		VNAP	AUTO	
Referring Physician's Name	0008,0090	PN		VNAP	USER	
Study Date	0008,0020	DA		ALWAYS	AUTO	
Study Description	0008,1030	LO		VNAP	USER	
Study ID	0020,0010	SH		ALWAYS	AUTO, MWL	
Study Instance UID	0020,000D	UI		ALWAYS	AUTO, MWL	
Study Time	0008,0030	TM		ALWAYS	AUTO	

Table 113: Patient Study Module

Attribute Name	Tag	VR	Value	Presence of Value	Source	Comment
Patient's Age	0010,1010	AS		ALWAYS	MWL, USER	
Patient's Size	0010,1020	DS		ALWAYS	AUTO, MWL, USER	
Patient's Weight	0010,1030	DS		ALWAYS	AUTO, MWL, USER	

Table 114: General Series Module

Attribute Name	Tag	VR	Value	Presence of Value	Source	Comment
Modality	0008,0060	CS	CT	ALWAYS	FIXED	
Operators' Name	0008,1070	PN		VNAP	USER	
Patient Position	0018,5100	CS		ALWAYS	USER	
Protocol Name	0018,1030	LO		ALWAYS	USER	
Series Description	0008,103E	LO		VNAP	MWL, USER	
Series Instance UID	0020,000E	UI		ALWAYS	AUTO	
Series Number	0020,0011	IS		ALWAYS	AUTO	

Table 115: Frame of Reference Module

Attribute Name	Tag	VR	Value	Presence of Value	Source	Comment
Frame of Reference UID	0020,0052	UI		ALWAYS	AUTO	
Position Reference Indicator	0020,1040	LO		VNAP	AUTO	

Table 116: General Equipment Module

Attribute Name	Tag	VR	Value	Presence of Value	Source	Comment
Institution Name	0008,0080	LO		VNAP	CONFIG	
Manufacturer	0008,0070	LO	PNMS	ALWAYS	CONFIG	
Manufacturer's Model Name	0008,1090	LO	MX 16	ALWAYS	CONFIG	
Pixel Padding Value	0028,0120	US /SS		ALWAYS	AUTO	
Software Version(s)	0018,1020	LO	Value 1: MX 16-slice 1.0	ALWAYS	CONFIG	
Spatial Resolution	0018,1050	DS		ALWAYS	AUTO	

Table 117: General Image Module

Attribute Name	Tag	VR	Value	Presence of Value	Source	Comment
Acquisition Date	0008,0022	DA		ALWAYS	AUTO	
Acquisition Time	0008,0032	TM		ALWAYS	AUTO	
Content Date	0008,0023	DA		ALWAYS	AUTO	
Content Time	0008,0033	TM		ALWAYS	AUTO	
Instance Number	0020,0013	IS		ALWAYS	AUTO	

Table 118: Image Plane Module

Attribute Name	Tag	VR	Value	Presence of Value	Source	Comment
Image Orientation (Patient)	0020,0037	DS		ALWAYS	AUTO	
Image Position (Patient)	0020,0032	DS		ALWAYS	AUTO	
Pixel Spacing	0028,0030	DS		ALWAYS	AUTO	
Slice Location	0020,1041	DS		ALWAYS	AUTO	
Slice Thickness	0018,0050	DS		VNAP	AUTO	

Table 119: Image Pixel Module

Attribute Name	Tag	VR	Value	Presence of Value	Source	Comment
Columns	0028,0011	US	512	ALWAYS	AUTO	
Pixel Data	7FE0,0010	O W/ OB		ALWAYS	AUTO	
Pixel Representation	0028,0103	US	0	ALWAYS	AUTO	
Rows	0028,0010	US	512	ALWAYS	AUTO	

Table 120: Contrast/Bolus Module

Attribute Name	Tag	VR	Value	Presence of Value	Source	Comment
Contrast/Bolus Agent	0018,0010	LO		VNAP	AUTO	

Table 121: CT Image Module

Attribute Name	Tag	VR	Value	Presence of Value	Source	Comment
Acquisition Number	0020,0012	IS		ALWAYS	AUTO	
Bits Allocated	0028,0100	US	16	ALWAYS	AUTO	
Bits Stored	0028,0101	US	12	ALWAYS	AUTO	
Convolution Kernel	0018,1210	SH		ANAPCV	AUTO	
CTDIvol	0018,9345	FD		ANAPCV	AUTO	
Data Collection Diameter	0018,0090	DS		ANAPCV	AUTO	
Distance Source to Detector	0018,1110	DS		ANAPCV	AUTO	
Distance Source to Patient	0018,1111	DS		ANAPCV	AUTO	
Exposure	0018,1152	IS		ANAPCV	AUTO	
Exposure in μ As	0018,1153	IS		ANAPCV	AUTO	
Exposure Time	0018,1150	IS		ANAPCV	AUTO	
Filter Type	0018,1160	SH		ANAPCV	AUTO	
Gantry/Detector Tilt	0018,1120	DS		ANAPCV	AUTO	
High Bit	0028,0102	US	11	ALWAYS	AUTO	
Image Type	0008,0008	CS	Value 1: ORIGINAL, Value 2: PRIMARY, Value 3: AXIAL, LOCALIZER	ALWAYS	AUTO	
KVP	0018,0060	DS		ALWAYS	AUTO	
Photometric Interpretation	0028,0004	CS	MONOCHROME2	ALWAYS	AUTO	
Reconstruction Diameter	0018,1100	DS		ANAPCV	AUTO	
Rescale Intercept	0028,1052	DS		ALWAYS	AUTO	
Rescale Slope	0028,1053	DS	1	ALWAYS	AUTO	
Revolution Time	0018,9305	FD		ANAPCV	AUTO	
Rotation Direction	0018,1140	CS	CW	ANAPCV	FIXED	
Samples per Pixel	0028,0002	US	1	ALWAYS	AUTO	
Scan Options	0018,0022	CS	Value 1: AXIAL,SURVIEW, HELICAL	ALWAYS	AUTO	
Spiral Pitch Factor	0018,9311	FD		ANAPCV	AUTO	
Table Feed per Rotation	0018,9310	FD		ANAPCV	AUTO	
Table Height	0018,1130	DS		ANAPCV	AUTO	
Table Speed	0018,9309	FD		ANAPCV	AUTO	
X-ray Tube Current	0018,1151	IS		ANAPCV	AUTO	

Table 122: VOI LUT Module

Attribute Name	Tag	VR	Value	Presence of Value	Source	Comment
Window Center	0028,1050	DS		ALWAYS	AUTO	
Window Width	0028,1051	DS		ALWAYS	AUTO	

Table 123: SOP Common Module

Attribute Name	Tag	VR	Value	Presence of Value	Source	Comment
SOP Class UID	0008,0016	UI		ALWAYS	FIXED	
SOP Instance UID	0008,0018	UI		ALWAYS	AUTO	
Specific Character Set	0008,0005	CS		ANAP	CONFIG, MWL	

Table 124: Additional Module

Attribute Name	Tag	VR	Value	Presence of Value	Source	Comment
Spacing Between Slices	0018,0088	DS		ALWAYS	AUTO	
Scan Arc	0018,1143	DS		ALWAYS	AUTO	
X Focus Center	0018,1183	DS		ALWAYS	AUTO	
Y Focus Center	0018,1184	DS		ALWAYS	AUTO	
CTDIvol	0018,9345	FD		ALWAYS	AUTO	
Implementor ID group 00E1	00E1,0010	LO		ALWAYS	AUTO	
ELSCINT1_TOTAL_SAVING_D OSE	00E1,1037	DS		ALWAYS	AUTO	
Private (00E1,103E)	00E1,103E	IS		ALWAYS	AUTO	
Private (00E1,10C4)	00E1,10C4	DS		ALWAYS	AUTO	
Implementor ID group 01E1	01E1,0010	LO		ALWAYS	AUTO	
Phantom Type (private)	01E1,1026	CS	BODY 32, HEAD 16	ALWAYS	AUTO	
Implementor ID group 01F1	01F1,0010	LO		ALWAYS	AUTO	
Focal Spot Resolution	01F1,1002	CS	STANDARD, HIGH	ALWAYS	AUTO	
Angular Sampling Density	01F1,1004	CS		ALWAYS	AUTO	
Acquisition Length	01F1,1008	DS		ALWAYS	AUTO	
Private (01F1,100E)	01F1,100E	FL		ALWAYS	AUTO	
Table Increment	01F1,1028	DS		ALWAYS	AUTO	
Cycle Time	01F1,1033	DS		ALWAYS	AUTO	
Private (01F1,1045)	01F1,1045	IS		ALWAYS	AUTO	
Private (01F1,1049)	01F1,1049	DS		ALWAYS	AUTO	
Private (01F1,104B)	01F1,104B	SH		ALWAYS	AUTO	
Private (01F1,104C)	01F1,104C	SH		ALWAYS	AUTO	
Private (01F1,104D)	01F1,104D	SH		ALWAYS	AUTO	
Private (01F1,104E)	01F1,104E	LO		ALWAYS	AUTO	
Implementor ID group 01F9	01F9,0010	LO		ALWAYS	AUTO	
SP Filter (private)	01F9,1001	LO		ALWAYS	AUTO	
Adaptive Filter (private)	01F9,1004	IS		ALWAYS	AUTO	
Recon Increatment (private)	01F9,1005	IS		ALWAYS	AUTO	
Private (01F9,1008)	01F9,1008	DS		ALWAYS	AUTO	
Private (01F1,1009)	01F9,1009	DS		ALWAYS	AUTO	

8.1.1.3. Secondary Capture Image Storage SOP Class

Table 125: IOD of Created Secondary Capture Image Storage SOP Class Instances

Information Entity	Module	Presence Of Module
Patient	Patient Module	
Study	General Study Module	
Study	Patient Study Module	
Series	General Series Module	
Equipment	General Equipment Module	
Image	General Image Module	
Image	Image Pixel Module	
Equipment	SC Equipment Module	
Image	SC Image Module	
Image	VOI LUT Module	
Image	SOP Common Module	
	Additional Module	

Table 126: Patient Module

Attribute Name	Tag	VR	Value	Presence of Value	Source	Comment
Ethnic Group	0010,2160	SH		ANAPCV	COPY	

Other Patient IDs	0010,1000	LO		ANAPCV	COPY	
Patient Comments	0010,4000	LT		ANAPCV	COPY	
Patient ID	0010,0020	LO		VNAP	COPY	
Patient's Birth Date	0010,0030	DA		VNAP	COPY	
Patient's Name	0010,0010	PN		VNAP	COPY	
Patient's Sex	0010,0040	CS	F, M, O	VNAP	COPY	

Table 127: General Study Module

Attribute Name	Tag	VR	Value	Presence of Value	Source	Comment
Accession Number	0008,0050	SH		VNAP	AUTO	
Referring Physician's Name	0008,0090	PN		VNAP	USER	
Study Date	0008,0020	DA		VNAP	AUTO	
Study Description	0008,1030	LO		ANAPCV	CONFIG, MWL, USER	
Study ID	0020,0010	SH		VNAP	AUTO, USER	
Study Instance UID	0020,000D	UI		ALWAYS	AUTO, MWL	
Study Time	0008,0030	TM		VNAP	AUTO	

Table 128: Patient Study Module

Attribute Name	Tag	VR	Value	Presence of Value	Source	Comment
Patient's Age	0010,1010	AS		ANAPCV	MWL, USER	
Patient's Size	0010,1020	DS		ANAPCV	MWL, USER	
Patient's Weight	0010,1030	DS		ANAPCV	MWL, USER	

Table 129: General Series Module

Attribute Name	Tag	VR	Value	Presence of Value	Source	Comment
Series Description	0008,103E	LO		ANAPCV	AUTO	
Series Instance UID	0020,000E	UI		ALWAYS	AUTO	
Series Number	0020,0011	IS		VNAP	AUTO	

Table 130: General Equipment Module

Attribute Name	Tag	VR	Value	Presence of Value	Source	Comment
Device Serial Number	0018,1000	LO		ANAPCV	CONFIG	
Institution Address	0008,0081	ST		ANAPCV	CONFIG	
Institution Name	0008,0080	LO		ANAPCV	CONFIG	
Institutional Department Name	0008,1040	LO		ANAPCV	CONFIG	
Manufacturer	0008,0070	LO		VNAP	CONFIG	
Manufacturer's Model Name	0008,1090	LO		ANAPCV	CONFIG	
Software Version(s)	0018,1020	LO		ANAPCV	CONFIG	
Station Name	0008,1010	SH		ANAPCV	CONFIG	

Table 131: General Image Module

Attribute Name	Tag	VR	Value	Presence of Value	Source	Comment
Burned In Annotation	0028,0301	CS		ALWAYS	AUTO	
Content Date	0008,0023	DA		ALWAYS	AUTO	
Content Time	0008,0033	TM		ALWAYS	AUTO	
Image Comments	0020,4000	LT		ANAP	AUTO	

Image Type	0008,0008	CS	Value 1: DERIVED, Value 2: SECONDARY	ALWAYS	AUTO	
Instance Number	0020,0013	IS		ALWAYS	AUTO	
Patient Orientation	0020,0020	CS		ALWAYS	USER	

Table 132: Image Pixel Module

Attribute Name	Tag	VR	Value	Presence of Value	Source	Comment
Bits Allocated	0028,0100	US	8, 16	ALWAYS	AUTO	
Bits Stored	0028,0101	US	8, 12	ALWAYS	AUTO	
Columns	0028,0011	US		ALWAYS	AUTO	
High Bit	0028,0102	US	7, 11	ALWAYS	AUTO	
Photometric Interpretation	0028,0004	CS	MONOCHROME2, RGB	ALWAYS	AUTO	
Pixel Data	7FE0,0010	O W/ OB		ANAP	AUTO	
Pixel Representation	0028,0103	US	0	ALWAYS	AUTO	
Planar Configuration	0028,0006	US	0	ANAP	AUTO	
Rows	0028,0010	US		ALWAYS	AUTO	
Samples per Pixel	0028,0002	US	1, 3	ALWAYS	AUTO	

Table 133: SC Equipment Module

Attribute Name	Tag	VR	Value	Presence of Value	Source	Comment
Conversion Type	0008,0064	CS	WSD	ALWAYS	CONFIG	
Modality	0008,0060	CS	CT	ANAPCV	CONFIG	
Secondary Capture Device Manufacturer	0018,1016	LO	PNMS	ANAPCV	CONFIG	
Secondary Capture Device Manufacturer's Model Name	0018,1018	LO	MX 16-slice 1.0	ANAPCV	CONFIG	
Secondary Capture Device Software Version(s)	0018,1019	LO		ANAPCV	CONFIG	

Table 134: SC Image Module

Attribute Name	Tag	VR	Value	Presence of Value	Source	Comment
Date of Secondary Capture	0018,1012	DA		ANAP	AUTO	
Time of Secondary Capture	0018,1014	TM		ANAP	AUTO	

Table 135: VOI LUT Module

Attribute Name	Tag	VR	Value	Presence of Value	Source	Comment
Window Center	0028,1050	DS		ANAP	AUTO	
Window Width	0028,1051	DS		ANAP	AUTO	

Table 136: SOP Common Module

Attribute Name	Tag	VR	Value	Presence of Value	Source	Comment
Instance Creation Date	0008,0012	DA		ANAPCV	AUTO	
Instance Creation Time	0008,0013	TM		ANAPCV	AUTO	
SOP Class UID	0008,0016	UI		ALWAYS	AUTO	
SOP Instance UID	0008,0018	UI		ALWAYS	AUTO	
Specific Character Set	0008,0005	CS		ANAP	AUTO	

Table 137: Additional Module

Attribute Name	Tag	VR	Value	Presence of Value	Source	Comment
Distance Source to Detector	0018,1110	DS		ALWAYS	AUTO	

Total Number of Exposures	0040,0301	US		ALWAYS	AUTO	
Comments on Radiation Dose	0040,0310	ST		ALWAYS	AUTO	
Implementor ID group 00E1	00E1,0010	LO	ELSCINT1	ALWAYS	AUTO	
ELSCINT1_DLP_TOTAL (private)	00E1,1021	DS		ALWAYS	AUTO	
Exposure Dose Sequence	0040,030E	SQ		ALWAYS	AUTO	
>Series Description	0008,103E	LO		VNAP	AUTO	
>KVP	0018,0060	DS		ALWAYS	AUTO	
>Exposure Time	0018,1150	IS		ALWAYS	AUTO	
>Exposure	0018,1152	IS		ALWAYS	AUTO	
>Radiation Mode	0018,115A	CS		ALWAYS	AUTO	
>Filter Type	0018,1160	SH		ALWAYS	AUTO	
>Scan Length	0018,1302	IS		ALWAYS	AUTO	
>Filter Material	0018,7050	CS		ALWAYS	AUTO	
>X-Ray Tube Current in mA	0018,8151	DS		ALWAYS	AUTO	
>Acquisition Type	0018,9302	CS		ALWAYS	AUTO	
>Single Collimation Width	0018,9306	FD		ALWAYS	AUTO	
>Total Collimation Width	0018,9307	FD		ALWAYS	AUTO	
>Spiral Pitch Factor	0018,9311	FD		ALWAYS	AUTO	
>Estimated Dose Saving	0018,9324	FD		ALWAYS	AUTO	
>CTDIvol	0018,9345	FD		ALWAYS	AUTO	
>Series Number	0020,0011	IS		ANAP	AUTO	
>Implementor ID group 00E1	00E1,0010	LO	ELSCINT1	ALWAYS	AUTO	
>ELSCINT1_DLP_TOTAL (private)	00E1,1021	DS		ALWAYS	AUTO	
>Implementor ID group 01E1	01E1,0010	LO	ELSCINT1	ALWAYS	AUTO	
>Private (01E1,1026)	01E1,1026	CS		ALWAYS	AUTO	

8.1.2. Usage of Attributes from Received IOD

Not applicable

Table 138: Functionalities

Functionality	Type1	Optional	Private
Viewer	X		

8.1.2.1. Usage of the Functionality Viewer

The following table lists the supported SOP Classes which can be used by this application.

Table 139: Supported SOP Classes for functionality Viewer

SOP Class name	SOP Class UID
CT Image Storage SOP Class	1.2.840.10008.5.1.4.1.1.2
Secondary Capture Image Storage SOP Class	1.2.840.10008.5.1.4.1.1.7

8.1.3. Attribute Mapping

In this section the mapping between the Modality Worklist, Storage and Modality Performed Procedure Step is specified.

Table 140: Attribute mapping during Modality Workflow

Name	WLM tag	MPPSCreate tag	MPPSSet tag	Image IODtag
Specific Character Set	0008,0005	0008,0005		0008,0005
Operator's Name			0008,1030	0008,1030
Patient's Name	0010,0010	0010,0010		0010,0010
Patient ID	0010,0020	0010,0020		0010,0020
Patient's Birth Date	0010,0030	0010,0030		0010,0030
Patient Sex	0010,0040			0010,0040
Study Instance UID	0020,000D	0020,000D		0020,000D
Series Instance UID			0020,000E	0020,000E
Modality	0008,0060	0008,0060		0008,0060

8.1.4. Coerced/Modified fields

Not applicable

8.2. Data Dictionary of Private Attributes

Not applicable

8.3. Coded Terminology and Templates

This application supports the following Coded Terminology and templates as described in the sub-sections.

8.3.1. Context Groups

Not applicable

8.3.2. Template Specifications

Not applicable

8.3.3. Private code definitions

This system generated private DICOM attributes. These are not listed in this document.

8.4. Grayscale Image consistency

Not applicable

8.5. Standard Extended/Specialized/Private SOPs

Not applicable

8.6. Private Transfer Syntaxes

Not applicable