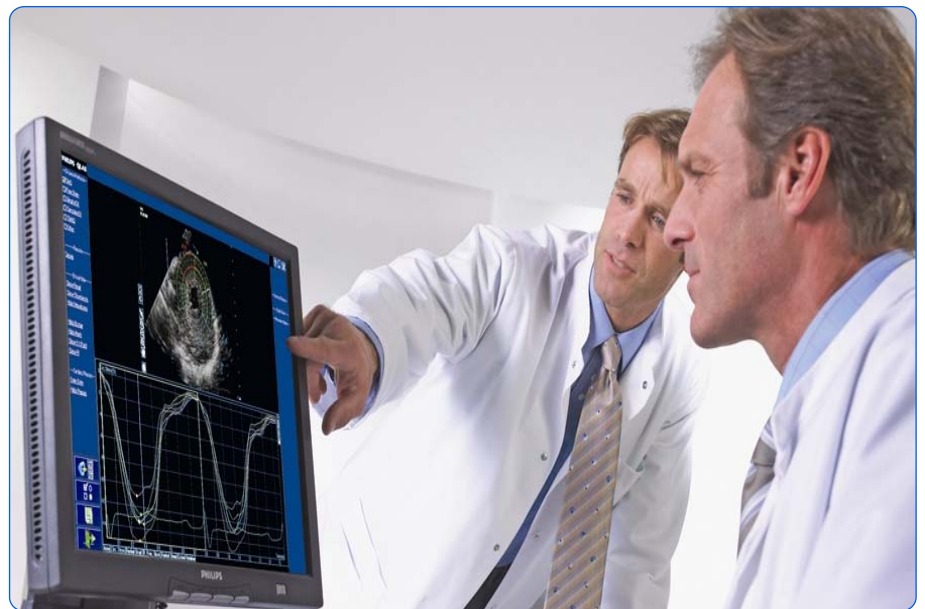

DICOM

Conformance Statement

Q-Station R1.1

000248000000012 Rev A

2011-02-07



PHILIPS

Issued by:

Philips Ultrasound, Inc., a Philips Healthcare company,

3000 Minuteman Road
Andover, MA
USA

Email: dicom@philips.com
Internet: <http://www.healthcare.philips.com/connectivity>

Document Number: 00024800000012 Rev. A
Date: 7 February 2011

1 DICOM CONFORMANCE STATEMENT OVERVIEW

Q-Station is interoperable with systems providing a DICOM interface. Clinical users can select patient image data for basic viewing; post processing, data transfer or print. Q-Station stores medical data in its local storage. The local storage has a limited capacity and is not intended for long term archiving purposes.

Table 1: Network Services

SOP Class		User of Service (SCU)	Provider of Service (SCP)
Name	UID		
Other			
Verification SOP Class	1.2.840.10008.1.1	Yes	Yes
Print Management			
Basic Grayscale Print Management Meta SOP Class	1.2.840.10008.5.1.1.9	Yes	No
>Basic Film Box SOP Class	1.2.840.10008.5.1.1.2	Yes	No
>Basic Film Session SOP Class	1.2.840.10008.5.1.1.1	Yes	No
>Basic Grayscale Image Box SOP Class	1.2.840.10008.5.1.1.4	Yes	No
>Printer SOP Class	1.2.840.10008.5.1.1.16	Yes	No
Basic Color Print Management Meta SOP Class	1.2.840.10008.5.1.1.18	Yes	No
>Basic Color Image Box SOP Class	1.2.840.10008.5.1.1.4.1	Yes	No
>Basic Film Box SOP Class	1.2.840.10008.5.1.1.2	Yes	No
>Basic Film Session SOP Class	1.2.840.10008.5.1.1.1	Yes	No
>Printer SOP Class	1.2.840.10008.5.1.1.16	Yes	No
Presentation LUT Shape SOP Class	1.2.840.10008.5.1.1.23	Yes	No
Query/Retrieve			
Patient Root Query/Retrieve Information Model - FIND SOP Class	1.2.840.10008.5.1.4.1.2.1.1	Yes	No
Patient Root Query/Retrieve Information Model - MOVE SOP Class	1.2.840.10008.5.1.4.1.2.1.2	Yes	No
Study Root Query/Retrieve Information Model - FIND SOP Class	1.2.840.10008.5.1.4.1.2.2.1	Yes	No
Study Root Query/Retrieve Information Model - MOVE SOP Class	1.2.840.10008.5.1.4.1.2.2.2	Yes	No
Transfer			
Ultrasound Multi-frame Image Storage SOP Class	1.2.840.10008.5.1.4.1.1.3.1	Yes	Yes
Ultrasound Image Storage SOP Class	1.2.840.10008.5.1.4.1.1.6.1	Yes	Yes
Secondary Capture Image Storage SOP Class	1.2.840.10008.5.1.4.1.1.7	Yes	Yes
General ECG Waveform Storage SOP Class	1.2.840.10008.5.1.4.1.1.9.1.2	Yes	Yes
Basic Text SR SOP Class	1.2.840.10008.5.1.4.1.1.88.11	Yes	Yes
Enhanced SR SOP Class	1.2.840.10008.5.1.4.1.1.88.22	Yes	Yes
Comprehensive SR SOP Class	1.2.840.10008.5.1.4.1.1.88.33	Yes	Yes
Encapsulated PDF Storage	1.2.840.10008.5.1.4.1.1.104.1	Yes	Yes

Table 2: Media Services

Media Storage Application Profile	Write Files (FSC / FSU)	Read Files (FSR)
Compact Disk – Recordable		
General Purpose CD-R Interchange	Yes / No	Yes
STD-US-SC-MF-CD-R	Yes/No	Yes
DVD		
General Purpose DVD Interchange with JPEG	Yes / No	Yes
USB		
General Purpose USB Interchange with JPEG	Yes / Yes	Yes

2 TABLE OF CONTENTS

1	DICOM CONFORMANCE STATEMENT OVERVIEW	3
2	TABLE OF CONTENTS	5
3	INTRODUCTION	7
3.1	Revision History	7
3.2	Audience	7
3.3	Remarks	7
3.4	Definitions, Terms and Abbreviations	8
3.5	References	9
4	NETWORKING	10
4.1	Implementation model	10
4.1.1	Application Data Flow	10
4.1.2	Functional Definition of AE's	11
4.1.3	Sequencing of Real World Activities	11
4.2	AE Specifications	12
4.2.1	Q-Station Network AE	12
4.3	Network Interfaces	43
4.3.1	Physical Network Interfaces	43
4.3.2	Additional Protocols	43
4.4	Configuration	43
4.4.1	AE Title/Presentation Address Mapping	43
4.4.2	Parameters	44
5	MEDIA INTERCHANGE	45
5.1.1	Application Data Flow Diagram	45
5.1.2	Functional Definitions of AE's	45
5.1.3	Sequencing of Real World Activities	45
5.1.4	File Meta Information for Implementation Class and Version	45
5.2.1	Q-Station	46
5.3.1	Augmented Application Profiles	47
5.3.2	Private Application Profiles	47
5.4	Media Configuration	47
6	SUPPORT OF CHARACTERSETS	48

7	SECURITY	50
7.1	Security Profiles	50
7.1.1	Audit Trail Component.....	50
7.2	Association Level Security	50
7.3	Application Level Security.....	50
8	ANNEXES OF APPLICATION "Q-Station"	51
8.1	IOD Contents.....	51
8.1.1	Created SOP Instance.....	51
8.1.2	Usage of Attributes from Received IOD	63
8.1.3	Attribute Mapping	64
8.1.4	Coerced/Modified fields	64
8.2	Data Dictionary of Private Attributes	65
8.3	Coded Terminology and Templates.....	65
8.4	Grayscale Image consistency	65
8.5	Standard Extended/Specialized/Private SOPs	65
8.5.1	Specialized SOP Classes.....	65
8.6	Private Transfer Syntaxes	65
9	ANNEXES OF APPLICATION "QLAB"	66
9.1	IOD Contents.....	66
9.1.1	Created SOP Instance.....	66
9.1.1.1	List of Created SOP Classes.....	66
	Appendix A – Structured Reporting.....	72
A.1	Wall Motion Analysis (TID 5204)	72

3 INTRODUCTION

The introduction specifies product and relevant disclaimers as well as any general information that the vendor feels is appropriate.

3.1 Revision History

The revision history provides dates and differences of the different releases.

Table 3: Revision History

Document Version	Date of Issue	Author	Description
A	February 7, 2011	IOCC-Best	Initial release for this Q-Station update. New Document Number used.

3.2 Audience

This Conformance Statement is intended for:

- (Potential) customers
- System integrators of medical equipment
- Marketing staff interested in system functionality
- Software designers implementing DICOM interfaces

It is assumed that the reader is familiar with the DICOM standard.

3.3 Remarks

The DICOM Conformance Statement is contained in chapter 4 through 8 and follows the contents and structuring requirements of DICOM PS 3.2.

This DICOM Conformance Statement by itself does not guarantee successful interoperability of Philips equipment with non-Philips equipment. The user (or user's agent) should be aware of the following issues:

- **Interoperability**
Interoperability refers to the ability of application functions, distributed over two or more systems, to work successfully together. The integration of medical devices into an IT environment may require application functions that are not specified within the scope of DICOM. Consequently, using only the information provided by this Conformance Statement does not guarantee interoperability of Philips equipment with non-Philips equipment.
It is the user's responsibility to analyze thoroughly the application requirements and to specify a solution that integrates Philips equipment with non-Philips equipment.
- **Validation**
Philips equipment has been carefully tested to assure that the actual implementation of the DICOM interface corresponds with this Conformance Statement.
Where Philips equipment is linked to non-Philips equipment, the first step is to compare the relevant Conformance Statements. If the Conformance Statements indicate that successful information exchange should be possible, additional validation tests will be necessary to ensure the functionality, performance, accuracy and stability of image and image related data. It is the responsibility of the user (or user's agent) to specify the appropriate test suite and to carry out the additional validation tests.

- **New versions of the DICOM Standard**

The DICOM Standard will evolve in future to meet the user’s growing requirements and to incorporate new features and technologies. Philips is actively involved in this evolution and plans to adapt its equipment to future versions of the DICOM Standard. In order to do so, Philips reserves the right to make changes to its products or to discontinue its delivery.

The user should ensure that any non-Philips provider linking to Philips equipment also adapts to future versions of the DICOM Standard. If not, the incorporation of DICOM enhancements into Philips equipment may lead to loss of connectivity (in case of networking) and incompatibility (in case of media).

3.4 Definitions, Terms and Abbreviations

DICOM definitions, terms and abbreviations are used throughout this Conformance Statement. For a description of these, see NEMA PS 3.3 and PS 3.4.

The word Philips in this document refers to Philips Healthcare. The term Q-Station is used in this document to refer to Q-Station 1.0.

The following acronyms and abbreviations are used in this document.

ACC	American College of Cardiology
ACR	American College of Radiology
AE	Application Entity
ANSI	American National Standard Institute
AP	Application Profile
BOT	Basic Offset Table
CD	Compact Disc
CD-R	CD-Recordable
CD-M	CD-Medical
DCR	Dynamic Cardio Review
DICOM	Digital Imaging and Communications in Medicine
DIMSE	DICOM Message Service Element
DIMSE-C	DIMSE-Composite
DIMSE-N	DIMSE-Normalized
EBE	DICOM Explicit VR Big Endian
ELE	DICOM Explicit VR Little Endian
FSC	File-set Creator
FSR	File-set Reader
FSU	File-set Updater
GUI	Graphic User Interface
HIS	Hospital Information System
HL7	Health Level Seven
ILE	DICOM Implicit VR Little Endian
IOD	Information Object Definition
ISIS	Information System – Imaging System
Na	Not applicable
NEMA	National Electrical Manufacturers Association
PDU	Protocol Data Unit
RWA	Real-World Activity
SC	Secondary Capture
SCM	Study Component Management
SCP	Service Class Provider
SCU	Service Class User
SOP	Service Object Pair
TCP/IP	Transmission Control Protocol/Internet Protocol
UID	Unique Identifier
US	Ultrasound
USMF	Ultrasound Multi-frame

3.5 References

[DICOM] Digital Imaging and Communications in Medicine, Part 1 – 18
(NEMA PS 3.1– PS 3.18),
National Electrical Manufacturers Association (NEMA)
Publication Sales 1300 N. 17th Street, Suite 1847
Rosslyn, Virginia. 22209, United States of America
Internet: <http://medical.nema.org/>

Note that at any point in time the official standard consists of the most recent yearly edition of the base standard (currently 2008) plus all the supplements and correction items that have been approved as Final Text.

4 NETWORKING

This section contains the networking related services (vs. the media related ones).

4.1 Implementation model

The implementation model consists of three sections:

- The application data flow diagram, specifying the relationship between the Application Entities and the “external world” or Real-World Activities,
- A functional description of each Application Entity, and
- The sequencing constraints among them.

4.1.1 Application Data Flow

Q-Station R1.1 implements one network application entity: the Q-Station Network AE.

The following figure shows the networking application data flow as a functional overview of the application entity. On the left the local Real-World Activities are presented, whereas on the right the remote Real-World Activities are presented.

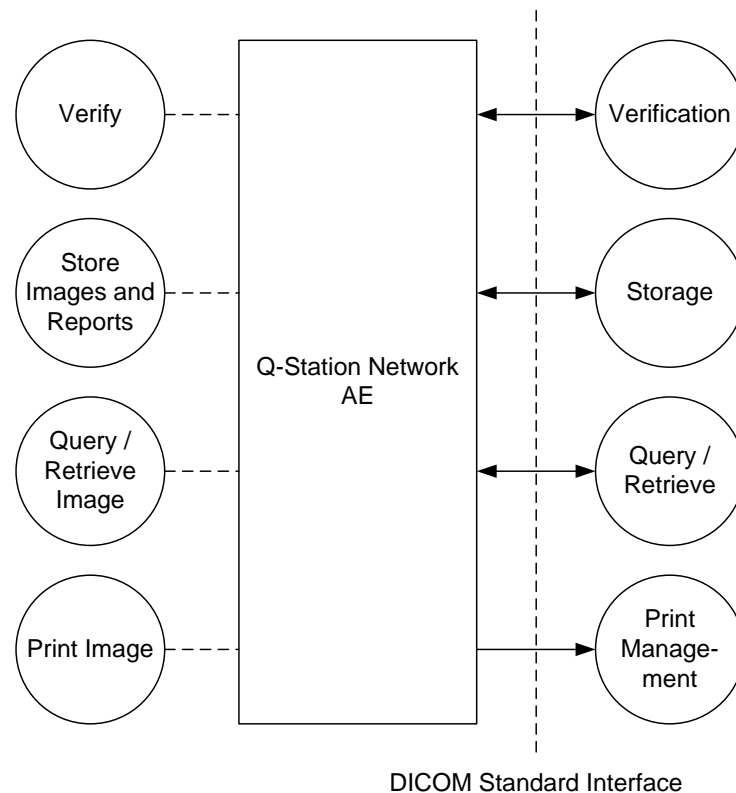

Figure 1: Application Data Flow Diagram

Q-Station R1.1 incorporates the following functionality:

- Import images to a local database;
- Export images from the local database to a network DICOM node;
- Query and retrieve images from a remote DICOM node;
- Query and retrieve images from the local database;
- Print grayscale and color images from the local database on a DICOM printer.

4.1.2 Functional Definition of AE's

This section contains a functional definition for each individual local Application Entity. This describes in general terms the functions to be performed by the AE, and the DICOM services used to accomplish these functions. In this sense, "DICOM services" refers not only to DICOM Service Classes, but also to lower level DICOM services, such as Association Services.

4.1.2.1 Functional Definition of Q-Station Network AE

Q-Station incorporates the following functionality:

- The Q-Station Network AE can verify application level communication by using the Verification service both as SCU and SCP (Verify).
- The Q-Station Network AE can store images by using the Storage service both as SCU and SCP (Store Image).
- The Q-Station Network AE can find and move images by using the Query/Retrieve service as SCU (Query/Retrieve Image).
- The Q-Station Network AE can print images by using the Print Management service as SCU (Print Image).

4.1.3 Sequencing of Real World Activities

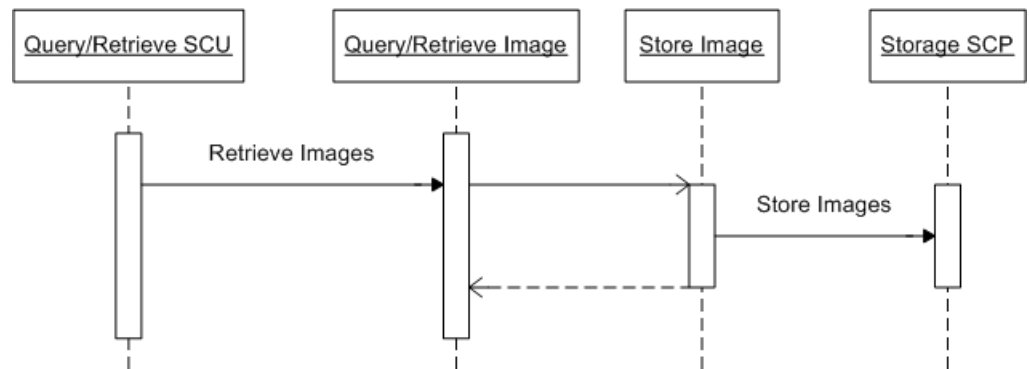

Figure 2: Sequencing of Retrieve

4.2 AE Specifications

The next section in the DICOM Conformance Statement is a set of application entity specifications. There are as many of these subsections as there are different AE's in the implementation.

4.2.1 Q-Station Network AE

Detail of this specific Application Entity is specified in this section.

4.2.1.1 SOP Classes

This Application Entity provides Standard Conformance to the following SOP Classes.

Table 4: SOP Classes for Q-Station Network AE

SOP Class Name	SOP Class UID	SCU	SCP
Verification SOP Class	1.2.840.10008.1.1	Yes	Yes
Basic Grayscale Print Management Meta SOP Class	1.2.840.10008.5.1.1.9 *	Yes	No
>Basic Film Box SOP Class	1.2.840.10008.5.1.1.2	Yes	No
>Basic Film Session SOP Class	1.2.840.10008.5.1.1.1	Yes	No
>Basic Grayscale Image Box SOP Class	1.2.840.10008.5.1.1.4	Yes	No
>Printer SOP Class	1.2.840.10008.5.1.1.16	Yes	No
Basic Color Print Management Meta SOP Class	1.2.840.10008.5.1.1.18 *	Yes	No
>Basic Color Image Box SOP Class	1.2.840.10008.5.1.1.4.1	Yes	No
>Basic Film Box SOP Class	1.2.840.10008.5.1.1.2	Yes	No
>Basic Film Session SOP Class	1.2.840.10008.5.1.1.1	Yes	No
>Printer SOP Class	1.2.840.10008.5.1.1.16	Yes	No
Presentation LUT Shape SOP Class	1.2.840.10008.5.1.1.23 *	Yes	No
Ultrasound Multi-frame Image Storage SOP Class	1.2.840.10008.5.1.4.1.1.3.1	Yes	Yes
Ultrasound Image Storage SOP Class	1.2.840.10008.5.1.4.1.1.6.1	Yes	Yes
Secondary Capture Image Storage SOP Class	1.2.840.10008.5.1.4.1.1.7	Yes	Yes
General ECG Waveform Storage SOP Class	1.2.840.10008.5.1.4.1.1.9.1.2	Yes	Yes
Basic Text SR SOP Class	1.2.840.10008.5.1.4.1.1.88.11	Yes	Yes
Enhanced SR SOP Class	1.2.840.10008.5.1.4.1.1.88.22	Yes	Yes
Comprehensive SR SOP Class	1.2.840.10008.5.1.4.1.1.88.33	Yes	Yes
Encapsulated PDF Storage	1.2.840.10008.5.1.4.1.1.104.1	Yes	Yes
Patient Root Query/Retrieve Information Model - FIND SOP Class	1.2.840.10008.5.1.4.1.2.1.1	Yes	No
Patient Root Query/Retrieve Information Model - MOVE SOP Class	1.2.840.10008.5.1.4.1.2.1.2	Yes	No
Study Root Query/Retrieve Information Model - FIND SOP Class	1.2.840.10008.5.1.4.1.2.2.1	Yes	No
Study Root Query/Retrieve Information Model - MOVE SOP Class	1.2.840.10008.5.1.4.1.2.2.2	Yes	No

* Presentation LUT Shape SOP Class is only used in the Print Meta SOP Classes

Note: Any SOP specific behavior is documented later in the conformance statement in the applicable SOP specific conformance section.

4.2.1.2 Association Policies

Each AE specification contains a description of the general association establishment and acceptance policies of the AE.

4.2.1.2.1 General

The DICOM standard application context has specified.

Table 5: DICOM Application Context

Application Context Name	1.2.840.10008.3.1.1.1
--------------------------	-----------------------

4.2.1.2.2 Number of Associations

The number of simultaneous associations that an Application Entity may support as a Initiator or Acceptor is specified.

Table 6: Number of Associations as an Association Initiator for Q-Station Network AE

Maximum number of simultaneous associations	4
---	---

Table 7: Number of Associations as an Association Acceptor for Q-Station Network AE

Maximum number of simultaneous associations	Limited to configured devices
---	-------------------------------

4.2.1.2.3 Asynchronous Nature

If the implementation supports negotiation of multiple outstanding transactions this is stated here, along with the maximum number of outstanding transactions supported.

Table 8: Asynchronous Nature as an Association Initiator for Q-Station Network AE

Maximum number of outstanding asynchronous transactions	The Q-Station Network AE does not support asynchronous operations and will not perform asynchronous window negotiation. The only exceptions are for reports from Print Management operations.
---	---

4.2.1.2.4 Implementation Identifying Information

The value supplied for Implementation Class UID and version name are documented here.

Table 9: DICOM Implementation Class and Version for Q-Station Network AE

Implementation Class UID	1.3.46.670589.5.2.10
Implementation Version Name	81.302.3.2

4.2.1.2.5 Communication Failure Handling

The behavior of the AE during communication failure is summarized in next table.

Table 10: Communication Failure Behavior

Exception	Behavior
ARTIM Timeout	The association setup fails; the reason is logged and reported to the user.

4.2.1.3 Association Initiation Policy

This describes the conditions under which the AE will initiate an association. The behavior of the AE during association rejection is summarized in next table.

Table 11: DICOM Association Rejection Handling

Result	Source	Reason/Diagnosis	Behavior
1 – rejected-permanent	1 – DICOM UL service-user	1 – no-reason-given	Association is not established. The following error is logged. Association rejected by peer (1: REJECT_RESULT _permanent, 1: REJECT_SOURCE_dul_user, 1: REJECT_REASON _no_reason_given)
		2 – application-context-name-not-supported	Association is not established. The following error is logged. Association rejected by peer (1: REJECT_RESULT _permanent, 1: REJECT_SOURCE_dul_user, 2: REJECT_REASON _application_context_not_support)
		3 – calling-AE-title-not-recognized	Association is not established. The following error is logged. Association rejected by peer (1: REJECT_RESULT _permanent, 1: REJECT_SOURCE_dul_user, 3: REJECT_REASON _calling_aetitle_not_recognized)
		7 – called-AE-title-not-recognized	Association is not established. The following error is logged. Association rejected by peer (1: REJECT_RESULT _permanent, 1: REJECT_SOURCE_dul_user, 7: REJECT_REASON _called_aetitle_not_recognized)

	2 – DICOM UL service-provider (ACSE related function)	1 – no-reason-given	Association is not established. The following error is logged. Error: UserRecoverable: impl.dicom.access.PEER: Associationrejected by peer (1: REJECT_RESULT _permanent, 2: REJECT_SOURCE _dul_provider (acse), 1: REJECT_REASON _no_reason_given)
		2 – protocol-version-not-supported	Association is not established. The following error is logged. Association rejected by peer (1: REJECT_RESULT _permanent, 2: REJECT_SOURCE _dul_provider (acse), 2: REJECT_REASON _application_context_not_support)
	3 – DICOM UL service-provider (presentation related function)	1 – temporary-congestion	Association is not established. The following error is logged. Association rejected by peer (1: REJECT_RESULT _permanent, 3: REJECT_SOURCE _dul_provider (presentation), 1: REJECT_REASON _no_reason_given)
		2 – local-limit-exceeded	Association is not established. The following error is logged. Association rejected by peer (1: REJECT_RESULT _permanent, 3: REJECT_SOURCE _dul_provider (presentation), 2: REJECT_REASON _application_context_not_support)

Result	Source	Reason/Diagnosis	Behavior
2 – rejected-transient	1 – DICOM UL service-user	1 – no-reason-given	Association is not established. The following error is logged. Association rejected by peer (2: REJECT_RESULT_transient, 1: REJECT_SOURCE_dul_user, 1: REJECT_REASON_no_reason_given)
		2 – application-context-name-not-supported	Association is not established. The following error is logged. Association rejected by peer (2: REJECT_RESULT_transient, 1: REJECT_SOURCE_dul_user, 2: REJECT_REASON_application_context_not_support)
		3 – calling-AE-title-not-recognized	Association is not established. The following error is logged. Association rejected by peer (2: REJECT_RESULT_transient, 1: REJECT_SOURCE_dul_user, 3: REJECT_REASON_calling_aetitle_not_recognized)
		7 – called-AE-title-not-recognized	Association is not established. The following error is logged. Association rejected by peer (2: REJECT_RESULT_transient, 1: REJECT_SOURCE_dul_user, 7: REJECT_REASON_called_aetitle_not_recognized)
	2 – DICOM UL service-provider (ACSE related function)	1 – no-reason-given	Association is not established. The following error is logged. Association rejected by peer (2: REJECT_RESULT_transient, 2: REJECT_SOURCE_dul_provider (acse), 1: REJECT_REASON_no_reason_given)
		2 – protocol-version-not-supported	Association is not established. The following error is logged. Association rejected by peer (2: REJECT_RESULT_transient, 2: REJECT_SOURCE_dul_provider (acse), 2: REJECT_REASON_application_context_not_support)
	3 – DICOM UL service-provider (presentation related function)	1 – temporary-congestion	Association is not established. The following error is logged. Association rejected by peer (2: REJECT_RESULT_transient, 3: REJECT_SOURCE_dul_provider (presentation), 1: REJECT_REASON_no_reason_given)
		2 – local-limit-exceeded	Association is not established. The following error is logged. Association rejected by peer (2: REJECT_RESULT_transient, 3: REJECT_SOURCE_dul_provider (presentation), 2: REJECT_REASON_application_context_not_support)

The behavior of the AE during association abort is summarized in Table 12.

Table 12: DICOM Association Abort Handling

Source	Reason/Diagnosis	Behavior
0 – DICOM UL service-user	0 – reason-not-specified	<p>When received, Q-Station terminates the connection with the following log: Association ABORTED by peer (0: ABORT_SOURCE_dul_user, 0: ABORT_REASON_not_specified).</p> <p>Sent when:</p> <ul style="list-style-type: none"> • N-EVENT-REPORT for printing received with status FAILURE. • Abort is issued to an executing job that utilizes this network connection (ExportNetwork/ ArchiveNetwork/ DICOMCopy/ DICOMMove) • Any other problem than ones specified for Q-Station Network AE SCU in the rows below. (Examples: Problem while decoding the DICOM stream, SCU was unable to send the Response to SCP, Error writing to SCU stream).
2 – DICOM UL service-provider	0 – reason-not-specified	<p>When received, Q-Station Network AE terminates the connection with the following log: Association ABORTED by peer (2: ABORT_SOURCE_dul_provider, 0: ABORT_REASON_not_specified)</p> <p>Sent when:</p> <ul style="list-style-type: none"> • There are problems in SCU/SCP role negotiation. • Any other problem than ones specified for Q-Station Network AE SCU in the rows below. (Example: Problem while decoding the DICOM
	1 – unrecognized-PDU	<p>When received, the Q-Station Network AE terminates the connection with the following log: Association ABORTED by peer (2: ABORT_SOURCE_dul_provider, 1: ABORT_REASON_unrecognized_pdu).</p> <p>Sent when:</p> <ul style="list-style-type: none"> • An unrecognized PDU type is received⁴.
	2 – unexpected-PDU	<p>When received, the Q-Station Network AE terminates the connection with the following log: Association ABORTED by peer (2: ABORT_SOURCE_dul_provider, 2: ABORT_REASON_unexpected_pdu).</p> <p>Sent when:</p> <ul style="list-style-type: none"> • The received PDU type is not expected in the current state of connection⁵.
	4 – unrecognized-PDU parameter	<p>When received, the Q-Station Network AE terminates the connection with the following log: Association ABORTED by peer (2: ABORT_SOURCE_dul_provider, 4: ABORT_REASON_unrecognized_pdu_parameter).</p> <p>Sent when:</p> <ul style="list-style-type: none"> • An unrecognized Associate PDU item is received.

Source	Reason/Diagnosis	Behavior
	5 – unexpected-PDU parameter	<p>When received, the Q-Station Network AE terminates the connection with the following log: Association ABORTED by peer (2: ABORT_SOURCE_dul_provider, 5: ABORT_REASON _unexpected_pdu_parameter).</p> <p>Sent when:</p> <ul style="list-style-type: none"> • One of the Associate PDU items is received more than once². • One of the Associate PDU items is received unexpectedly².
	6 – invalid-PDU-parameter value	<p>When received, the Q-Station Network AE terminates the connection with the following log: Association ABORTED by peer (2: ABORT_SOURCE_dul_provider, 6: ABORT_REASON _invalid_pdu_parameter).</p> <p>Sent when:</p> <ul style="list-style-type: none"> • One of the Associate PDU items is received more than once³. • One of the Associate PDU items is not received³. • There is mismatch in the application context names between the SCU and the SCP. • Illegal Asynchronous Operations Window invoke value is received. • Illegal Asynchronous Operations Window perform value is received. • Unknown presentation context id is received. • Unknown abstract syntax is received. • The length or the format of a received PDU item is invalid.

The behavior of the AE during DICOM communication failure is summarized in Table 13.

Table 13: DICOM Command Communication Failure Behavior

Exception	Behavior
Reply Time-out	The association is aborted using A-ABORT and command marked as failed. The reason is logged and reported to the user.

4.2.1.3.1 (Real-World) Activity – Verification as SCU

4.2.1.3.1.1. Description and Sequencing of Activities

The Q-Station Network AE implements the Verification service class / Verification SOP class to verify application level communication.

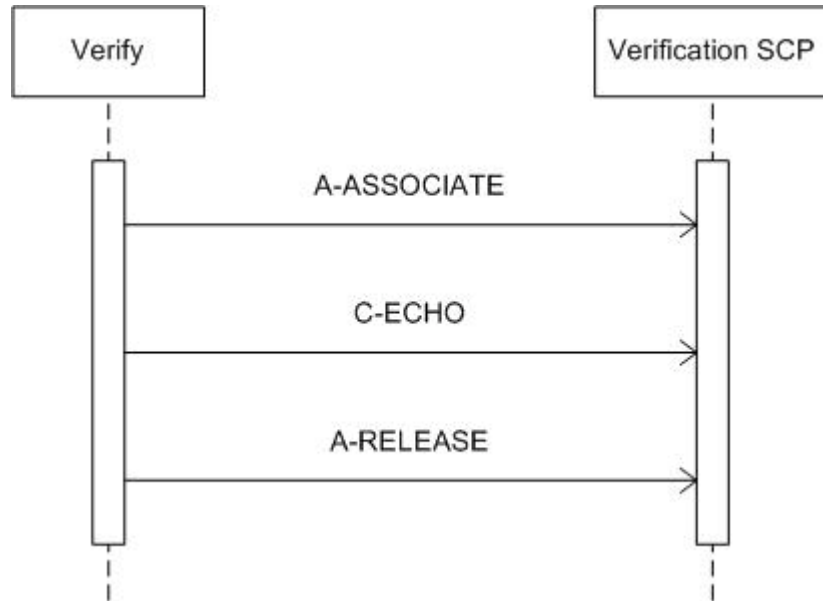

Figure 4: Data Flow Diagram – Verify

4.2.1.3.1.2 Proposed Presentation Contexts

Table 14: Proposed Presentation Contexts for (Real-World) Activity – Verification as SCU

Presentation Context Table					
Abstract Syntax		Transfer Syntax		Role	Extended Negotiation
Name	UID	Name List	UID List		
Verification SOP Class	1.2.840.10008.1.1	Implicit VR Little Endian	1.2.840.10008.1.2	SCU	None
		Explicit VR Little Endian	1.2.840.10008.1.2.1		
		Explicit VR Big Endian	1.2.840.10008.1.2.2		

4.2.1.3.1.3 SOP Specific Conformance for Verification SOP Class

The Q-Station Network AE provides standard conformance to the DICOM Verification service class.

All details regarding the specific conformance, including response behavior to all status codes, both from an application level and communication errors are provided in Table 15.

4.2.1.3.1.3.1 Dataset Specific Conformance for Verification C-ECHO SCU

Table 15: C-ECHO Command Response Status Handling Behavior

Service Status	Code	Further Meaning	Behavior
Success	0000	Confirmation	The SCP has successfully returned a verification response.

4.2.1.3.2 (Real-World) Activity – Print Management as SCU

4.2.1.3.2.1 Description and Sequencing of Activities

The Q-Station Network AE implements the Print Management service class as part of the Print component to send selected images to a printer (SCP).

As a result, the Q-Station Network AE will initiate an association to the selected printer and use it to send the Print Service Elements of the Print SOP Classes. If the association could not be established, the Q-Station Network AE will retry to establish an association every 20 seconds during the next hour.

Q-Station allows having a print preview first.

In case of a print job association the printer status is requested in that association. The received printer status is displayed in the Printer Status Tool. On a failure printer status the Q-Station Network AE will retry and request the printer status every 20 seconds during the next hour.

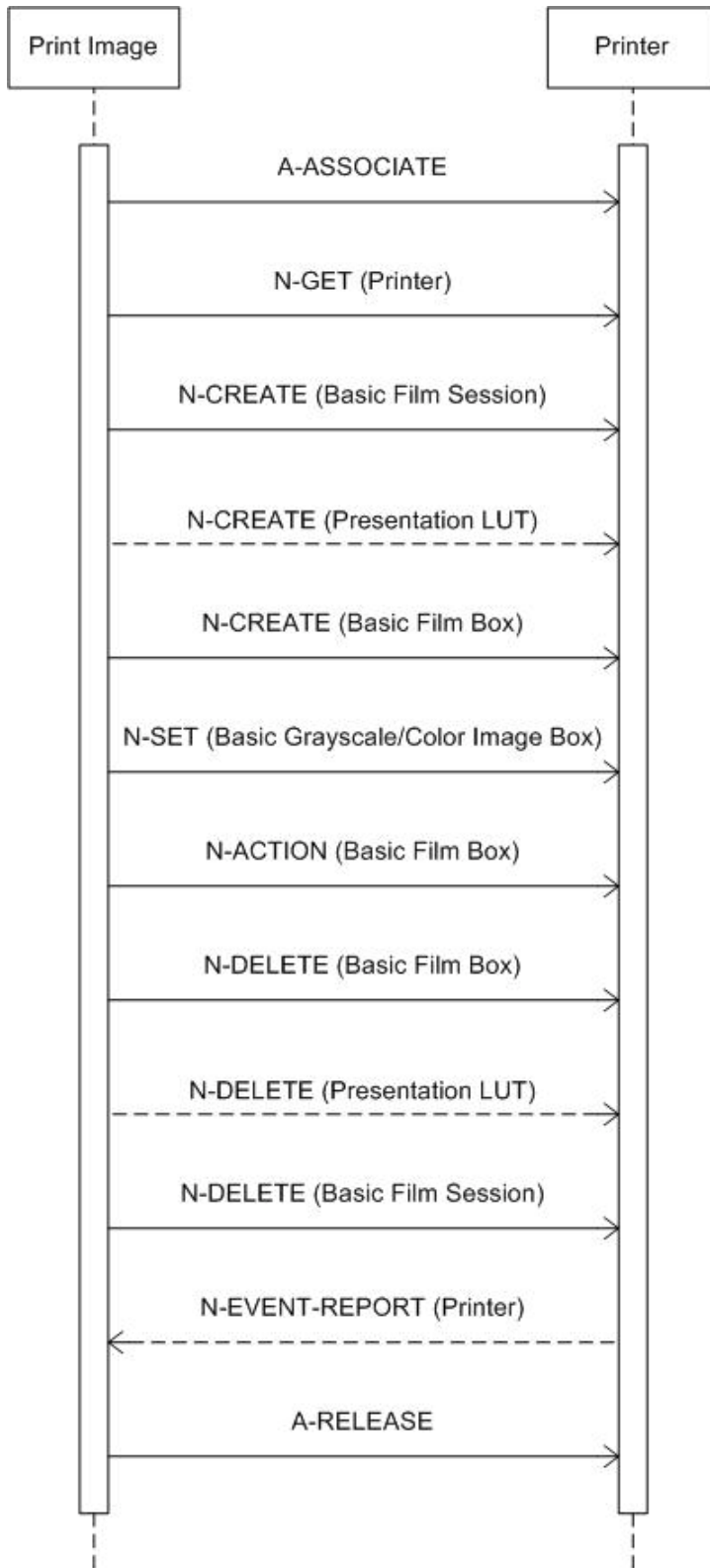

Figure 5: Data Flow Diagram – Print Image

4.2.1.3.2.2 Proposed Presentation Contexts

Table 16: Proposed Presentation Contexts for (Real-World) Activity – Print Management as SCU

Presentation Context Table					
Abstract Syntax		Transfer Syntax		Role	Extended Negotiation
Name	UID	Name List	UID List		
Basic Grayscale Print Management Meta SOP Class	1.2.840.10008.5.1.1.9	Explicit VR Little Endian	1.2.840.10008.1.2.1	SCU	None
		Implicit VR Little Endian	1.2.840.10008.1.2		
		Explicit VR Big Endian	1.2.840.10008.1.2.2		
>Basic Color Image Box SOP Class	1.2.840.10008.5.1.1.4.1	Explicit VR Little Endian	1.2.840.10008.1.2.1	SCU	None
		Implicit VR Little Endian	1.2.840.10008.1.2		
		Explicit VR Big Endian	1.2.840.10008.1.2.2		
>Basic Film Box SOP Class	1.2.840.10008.5.1.1.2	Explicit VR Little Endian	1.2.840.10008.1.2.1	SCU	None
		Implicit VR Little Endian	1.2.840.10008.1.2		
		Explicit VR Big Endian	1.2.840.10008.1.2.2		
>Basic Film Session SOP Class	1.2.840.10008.5.1.1.1	Explicit VR Little Endian	1.2.840.10008.1.2.1	SCU	None
		Implicit VR Little Endian	1.2.840.10008.1.2		
		Explicit VR Big Endian	1.2.840.10008.1.2.2		
>Printer SOP Class	1.2.840.10008.5.1.1.16	Explicit VR Little Endian	1.2.840.10008.1.2.1	SCU	None
		Implicit VR Little Endian	1.2.840.10008.1.2		
		Explicit VR Big Endian	1.2.840.10008.1.2.2		
Presentation LUT Shape SOP Class	1.2.840.10008.5.1.1.23	Explicit VR Little Endian	1.2.840.10008.1.2.1	SCU	None
		Implicit VR Little Endian	1.2.840.10008.1.2		
		Explicit VR Big Endian	1.2.840.10008.1.2.2		
Basic Color Print Management Meta SOP Class	1.2.840.10008.5.1.1.18	Explicit VR Little Endian	1.2.840.10008.1.2.1	SCU	None
		Implicit VR Little Endian	1.2.840.10008.1.2		
		Explicit VR Big Endian	1.2.840.10008.1.2.2		
>Basic Film Box SOP Class	1.2.840.10008.5.1.1.2	Explicit VR Big Endian	1.2.840.10008.1.2.2	SCU	None
		Explicit VR Little Endian	1.2.840.10008.1.2.1		
		Implicit VR Little Endian	1.2.840.10008.1.2		
>Basic Film Session SOP Class	1.2.840.10008.5.1.1.1	Explicit VR Big Endian	1.2.840.10008.1.2.2	SCU	None
		Explicit VR Little Endian	1.2.840.10008.1.2.1		
		Implicit VR Little Endian	1.2.840.10008.1.2		
>Basic Grayscale Image Box SOP Class	1.2.840.10008.5.1.1.4	Explicit VR Big Endian	1.2.840.10008.1.2.2	SCU	None
		Explicit VR Little Endian	1.2.840.10008.1.2.1		
		Implicit VR Little Endian	1.2.840.10008.1.2		
>Printer SOP Class	1.2.840.10008.5.1.1.16	Explicit VR Big Endian	1.2.840.10008.1.2.2	SCU	None
		Explicit VR Little Endian	1.2.840.10008.1.2.1		
		Implicit VR Little Endian	1.2.840.10008.1.2		
Presentation LUT Shape SOP Class	1.2.840.10008.5.1.1.23	Explicit VR Little Endian	1.2.840.10008.1.2.1	SCU	None
		Implicit VR Little Endian	1.2.840.10008.1.2		
		Explicit VR Big Endian	1.2.840.10008.1.2.2		

See section 8.1 for specification for each IOD created (including private IOD's).

4.2.1.3.2.3 SOP Specific Conformance for Print Management Meta SOP Classes

Q-Station provides standard conformance to the Basic Grayscale Print Management Meta SOP Class and the Basic Color Print Management Meta SOP Class. Note that associations are proposed for either color or grayscale printing, not for both.

The following optional SOP classes from these Meta SOP classes are not supported:

- Print Job SOP class (can be used to get a notification that a job is ready);
- Basic Annotations Box SOP class;
- Reference Image Box SOP class.

The grayscale standard display function adjusts the brightness such that equal changes in P-Values will result in the same level of perceptibility.

DICOM color print is supported as Planar Interleaved method as well as Pixel Interleaved. The Planar Interleaved method is mandatory according to DICOM standard and means that each color plane (R, G, B) is rendered separately. So each image must be rendered three times. This means that Planar Interleaved will be time consuming. For this reason the default method for DICOM color print will be set to Pixel Interleaved, where as the printer supports this.

The applied order of Print Service Elements (DIMSE's) is specified in Figure 5. Refer to section 8.1.1 for a description of the applied optional attributes in these Service Elements (i.e. non-mandatory attributes as Print SCU). Note that the Service Elements order is not specified by the DICOM standard.

Overlay, Annotation (showing the values of some major identifying attributes) and Shutter information is processed in the images sent to the printer (i.e. burnt-in into the image).

The Status Codes of DIMSE Responses (Success, Warning, Failure) as returned by the printer will also be logged (for service purposes) and are mapped onto general print job status messages towards the operator. These User Interface messages indicate:

- "Job Completed" and has the meaning that the print job is accepted by the printer; the actual printing will be done afterwards.
- "Print Error" indicates that a failure occurred during the DICOM Print. Also, most warning cases (like default printer values applied on optional print attributes) are interpreted as a print error because this will mostly result in a different print quality or print layout than expected.

The following implementation remarks are important to achieve successful printing:

- The number of Film Boxes per Film Session is one.
- The number of images per Film Box is one.
- The images to be printed on one film are rendered by Q-Station Network AE into one logical image. This logical image is very large, depending on the pixel matrix size (pixels per line, lines per image), use of color or not. A rough indication is 20 MBytes for grayscale and 80 Mbytes for color. One should take this into account when selecting the DICOM printer and the printer configuration (e.g. the amount of memory).

The Q-Station Network AE does not send an attribute list to the printer. Therefore the mandatory attributes listed in section 8.1.1 are the only attributes that are required to be supported by the printer.

4.2.1.3.2.1 SOP Specific Conformance for Basic Color Print Management Meta

SOP Class

Image Box

4.2.1.3.2.1.1 Dataset Specific Conformance for Basic Color Image Box N- SET SCU

All details regarding the specific conformance, including response behavior to all status codes, both from an application level and communication errors are provided in Table 17.

Table 17: N-SET Command Response Status Handling Behavior

Service Status	Code	Further Meaning	Behavior
Success	0000	Image successfully stored in image box.	The print job continues and completes.
Failure	Xxxx	(any failure)	Print job fails, the error is logged, and the association is released.
Warning	B604	Image size is larger than image box size, the image has been de-magnified.	The print job continues and the warning is logged.
	B605	Requested Min Density or Max Density outside of printer's operating range. The printer will use its respective minimum or maximum density value instead.	The print job continues and the warning is logged.
	B609	Image size is larger than the image box size. The image has been cropped to fit.	The print job continues and the warning is logged.
	B60A	Image size or combined print image size is larger than the image box size. Image or combined print image has been decimated to fit.	The print job continues and the warning is logged.
	0107	(not defined)	The print job continues and the warning is logged.
	0116		
	B600		
	B601		
	B602		
	B603		
B606			
B608			
Xxxx	(any other warning)	Print job fails, the warning is logged, and the association is released.	

Film Box

4.2.1.3.2.1.2 Dataset Specific Conformance for Basic Film Box N-ACTION SCU

Table 18: N-ACTION Command Response Status Handling Behavior

Service Status	Code	Further Meaning	Behavior
Success	0000	Film accepted for printing.	The print job continues and completes.
Failure	Xxxx	(any failure)	Print job fails, the error is logged, and the association is released.
Warning	B603	Film Box SOP Instance hierarchy does not contain Image Box SOP Instances (empty page).	The print job continues and the warning is logged.
	B604	Image size is larger than image box size, the image has been de-magnified.	The print job continues and the warning is logged.
	B609	Image size is larger than the image box size. The image has been cropped to fit.	The print job continues and the warning is logged.
	B60A	Image size or combined print image size is larger than the image box size. Image or combined print image has been decimated to fit.	The print job continues and the warning is logged.
	0107	(not defined)	The print job continues and the warning is logged.
	0116		
	B600		
	B601		
	B602		
	B605		
B606			
B608			
xxxx	(any other warning)	Print job fails, the warning is logged, and the association is released.	

4.2.1.3.2.1.3 Dataset Specific Conformance for Basic Film Box N- CREATE SCU

All details regarding the specific conformance, including response behavior to all status codes, both from an application level and communication errors are provided in Table 19.

Table 19: N-CREATE Command Response Status Handling Behavior

Service Status	Code	Further Meaning	Behavior
Success	0000	Film Box successfully created.	The print job continues and completes.
Failure	xxxx	(any failure)	Print job fails, the error is logged, and the association is released.
Warning	B605	Requested Min Density or Max Density outside of printer's operating range. The printer will use its respective minimum or maximum density value instead.	The print job continues and the warning is logged.
	0107	(not defined)	The print job continues and the warning is logged.
	0116		
	B600		
	B601		
	B602		
	B603		
	B604		
	B606		
	B608		
	B609		
	B60A		
	xxxx	(any other warning)	Print job fails, the warning is logged, and the association is released.

4.2.1.3.2.1.4 Dataset Specific Conformance for Basic Film Box N-DELETE SCU

All details regarding the specific conformance, including response behavior to all status codes, both from an application level and communication errors are provided in Table 20.

Table 20: N-DELETE Command Response Status Handling Behavior

Service Status	Code	Further Meaning	Behavior
Success	0000	-	Continue with print job.
Failure	xxxx	(any failure)	Print job fails, the error is logged, and the association is released.
Warning	xxxx	(any warning)	Print job fails, the warning is logged, and the association is released.

Film Session

4.2.1.3.2.1.5 Dataset Specific Conformance for Basic Film Session N-CREATE SCU

All details regarding the specific conformance, including response behavior to all status codes, both from an application level and communication errors are provided in Table 21.

Table 21: N-CREATE Command Response Status Handling Behavior

Service Status	Code	Further Meaning	Behavior
Success	0000	Film session successfully created.	The print job continues and completes.
Failure	xxxx	(any failure)	Print job fails, the error is logged, and the association is released.
Warning	B600	Memory allocation not supported.	The print job continues and the warning is logged.
	0107	(not defined)	The print job continues and the warning is logged.
	0116		
	B601		
	B602		
	B603		
	B604		
	B605		
	B606		
	B608		
B609			
B60A			
	xxxx	(any other warning)	Print job fails, the warning is logged, and the association is released.

4.2.1.3.2.1.6 Dataset Specific Conformance for Basic Film Session N- DELETE SCU

All details regarding the specific conformance, including response behavior to all status codes, both from an application level and communication errors are provided in Table 22.

Table 22: N-DELETE Command Response Status Handling Behavior

Service Status	Code	Further Meaning	Behavior
Success	0000	-	Continue with print job.
Failure	xxxx	(any failure)	Print job fails, the error is logged, and the association is released.
Warning	xxxx	(any warning)	Print job fails, the warning is logged, and the association is released.

Printer

4.2.1.3.2.1.7 Dataset Specific Conformance for Printer N-EVENT-REPORT SCU

Table 23: N-EVENT-REPORT Status Handling Behavior

Event Type Name	Event Type ID	Behavior
Normal	1	The N-EVENT-REPORT-RSP is sent to the SCP with: Status = 0 Event Type ID = 1 Information is logged: N-EVENT-REPORT received, type: NORMAL
Warning	2	The N-EVENT-REPORT-RSP is sent to the SCP with: Status = 0 Event Type ID = 2 Warning is logged: N-EVENT-REPORT received, type: WARNING Status info: <Status info>

Failure	3	<p>The N-EVENT-REPORT-RSP is sent to the SCP with: Status = 0 Event Type ID = 3</p> <p>Error is Logged: N-EVENT-REPORT received, type: FAILURE Status info: <Status info></p> <p>Printer status is set to DICOM_PRINTER_STATUS_FAILURE</p> <p>The print job retries the print operation.</p>
---------	---	--

All possible status responses are provided in Table 24.

Table 24: N-EVENT-REPORT Status Response

Service Status	Code	Further Meaning	Description
Success	0000	-	The result is logged.

4.2.1.3.2.1.8 Dataset Specific Conformance for Printer N-GET SCU

All details regarding the specific conformance, including response behavior to all status codes, both from an application level and communication errors are provided in Table 25.

Table 25: N-GET Command Response Status Handling Behavior

Service Status	Code	Further Meaning	Behavior
Success	0000	Successful command	The print job continues and completes.
Failure	Xxxx	(any failure)	Print job fails, the error is logged, and the association is released.
Warning	0001	Requested optional attributes are not supported.	The print job continues and the warning is logged.
	Xxxx	(any other warning)	Print job fails, the warning is logged, and the association is released.

4.2.1.3.2.2 SOP Specific Conformance for Basic Grayscale Print Management Meta SOP Class

Image Box

4.2.1.3.2.2.1 Dataset Specific Conformance for Basic Grayscale Image Box N-SET SCU

All details regarding the specific conformance, including response behavior to all status codes, both from an application level and communication errors are provided in Table 26.

Table 26: N-SET Command Response Status Handling Behavior

Service Status	Code	Further Meaning	Behavior
Success	0000	Successful command	The print job continues and completes.
Failure	xxxx	(any failure)	Print job fails, the error is logged, and the association is released.
Warning	B604	Image size is larger than image box size, the image has been de-magnified.	The print job continues and the warning is logged.
	B609	Image size is larger than the image box size. The image has been cropped to fit.	The print job continues and the warning is logged.

	B60A	Image size or combined print image size is larger than the image box size. Image or combined print image has been decimated to fit.	The print job continues and the warning is logged.
	0107	(not defined)	The print job continues and the warning is logged.
	0116		
	B600		
	B601		
	B602		
	B603		
	B605		
	B606		
	B608		
	xxxx	(any other warning)	Print job fails, the warning is logged, and the association is released.

Film Box

4.2.1.3.2.2.2 Dataset Specific Conformance for Basic Film Box N-ACTION SCU

All details regarding the specific conformance, including response behavior to all status codes, both from an application level and communication errors are provided in Table 27.

Table 27: N-ACTION Command Response Status Handling Behavior

Service Status	Code	Further Meaning	Behavior
Success	0000	Film accepted for printing.	The print job continues and completes.
Failure	xxxx	(any failure)	Print job fails, the error is logged, and the association is released.
Warning	B603	Film Box SOP Instance hierarchy does not contain Image Box SOP Instances (empty page).	The print job continues and the warning is logged.
	B604	Image size is larger than image box size, the image has been de-magnified.	The print job continues and the warning is logged.
	B609	Image size is larger than the image box size. The image has been cropped to fit.	The print job continues and the warning is logged.
	B60A	Image size or combined print image size is larger than the image box size. Image or combined print image has been decimated to fit.	The print job continues and the warning is logged.
	0107	(not defined)	The print job continues and the warning is logged.
	0116		
	B600		
	B601		
	B602		
	B605		
B606			
B608			
	xxxx	(any other warning)	Print job fails, the warning is logged, and the association is released.

4.2.1.3.2.2.3 Dataset Specific Conformance for Basic Film Box N- CREATE SCU

All details regarding the specific conformance, including response behavior to all status codes, both from an application level and communication errors are provided in Table 28.

Table 28: N-CREATE Command Response Status Handling Behavior

Service Status	Code	Further Meaning	Behavior
Success	0000	Film Box successfully created.	The print job continues and completes.
Failure	xxxx	(any failure)	Print job fails, the error is logged, and the association is released.
Warning	B605	Requested Min Density or Max Density outside of printer's operating range. The printer will use its respective minimum or maximum density value instead.	The print job continues and the warning is logged.
	0107	(not defined)	The print job continues and the warning is logged.
	0116		
	B600		
	B601		
	B602		
	B603		
	B604		
	B606		
	B608		
	B609		
	B60A		
	xxxx	(any other warning)	

4.2.1.3.2.2.4 Dataset Specific Conformance for Basic Film Box N-DELETE SCU

All details regarding the specific conformance, including response behavior to all status codes, both from an application level and communication errors are provided in Table 29.

Table 29: N-DELETE Command Response Status Handling Behavior

Service Status	Code	Further Meaning	Behavior
Success	0000	Successful command	The print job continues and completes.
Failure	xxxx	(any failure)	Print job fails, the error is logged, and the association is released.
Warning	xxxx	(any warning)	Print job fails, the warning is logged, and the association is released.

Film Session

4.2.1.3.2.2.5 Dataset Specific Conformance for Basic Film Session N- CREATE SCU

All details regarding the specific conformance, including response behavior to all status codes, both from an application level and communication errors are provided in Table 30.

Table 30: N-CREATE Command Response Status Handling Behavior

Service Status	Code	Further Meaning	Behavior
Success	0000	Film session successfully created.	The print job continues and completes.
Failure	xxxx	(any failure)	Print job fails, the error is logged, and the association is released.
Warning	B600	Memory allocation not supported.	The print job continues and the warning is logged.
	0107	(not defined)	The print job continues and the warning is logged.
	0116		
	B601		
	B602		
	B603		
	B604		
	B605		
	B606		
	B608		
	B609		
	B60A		
	xxxx		

4.2.1.3.2.2.6 Dataset Specific Conformance for Basic Film Session N- DELETE SCU

All details regarding the specific conformance, including response behavior to all status codes, both from an application level and communication errors are provided in Table 31.

Table 31: N-DELETE Command Response Status Handling Behavior

Service Status	Code	Further Meaning	Behavior
Success	0000	-	Continue with print job.
Failure	xxxx	(any failure)	Print job fails, the error is logged, and the association is released.
Warning	xxxx	(any warning)	Print job fails, the warning is logged, and the association is released.

Printer

4.2.1.3.2.2.7 Dataset Specific Conformance for Printer N-EVENT-REPORT SCU

Table 32: N-EVENT-REPORT Status Handling Behavior

Event Type Name	Event Type ID	Behavior
Normal	1	The N-EVENT-REPORT-RSP is sent to the SCP with: Status = 0 Event Type ID = 1 Information is logged: N-EVENT-REPORT received, type: NORMAL
Warning	2	The N-EVENT-REPORT-RSP is sent to the SCP with: Status = 0 Event Type ID = 2 Warning is logged: N-EVENT-REPORT received, type: WARNING Status info: <Status info>
Failure	3	The N-EVENT-REPORT-RSP is sent to the SCP with: Status = 0 Event Type ID = 3 Error is Logged: N-EVENT-REPORT received, type: FAILURE Status info: <Status info> Printer status is set to DICOM_PRINTER_STATUS_FAILURE The print job retries the print operation.

All possible status responses are provided in Table 33.

Table 33: N-EVENT-REPORT Status Response

Service Status	Code	Further Meaning	Description
Success	0000	-	The result is logged.

4.2.1.3.2.2.8 Dataset Specific Conformance for Printer N-GET SCU

All details regarding the specific conformance, including response behavior to all status codes, both from an application level and communication errors are provided in Table 34.

Table 34: N-GET Command Response Status Handling Behavior

Service Status	Code	Further Meaning	Behavior
Success	0000	Successful command	The print job continues and completes.
Failure	xxxx	(any failure)	Print job fails, the error is logged, and the association is released.
Warning	xxxx	(any warning)	Print job fails, the warning is logged, and the association is released.

4.2.1.3.3 (Real-World) Activity – FIND as SCU

4.2.1.3.3.1 Description and Sequencing of Activities

Q-Station Network AE initiates associations to systems to query their databases using the C-FIND command.

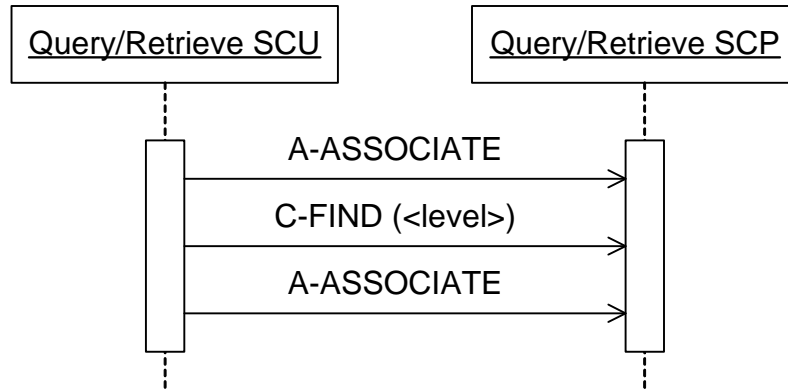

Figure 6: Data Flow Diagram – FIND as SCU

Q-Station implements the Query/Retrieve service class to find selected studies per Query/Retrieve SCP. When querying a remote database, Q-Station initiates an association to the selected peer entity, sends a C-FIND request and receives the related C-FIND responses. The association is released after a specific time-out.

4.2.1.3.3.2 Proposed Presentation Contexts

Table 35: Proposed Presentation Contexts for (Real-World) Activity – FIND as SCU

Presentation Context Table					
Abstract Syntax		Transfer Syntax		Role	Extended Negotiation
Name	UID	Name List	UID List		
Patient Root Query/Retrieve Information Model - FIND SOP Class	1.2.840.10008.5.1.4.1.2.1.1	Explicit VR Big Endian	1.2.840.10008.1.2.2	SCU	None
		Explicit VR Little Endian	1.2.840.10008.1.2.1		
		Implicit VR Little Endian	1.2.840.10008.1.2		
Study Root Query/Retrieve Information Model - FIND SOP Class	1.2.840.10008.5.1.4.1.2.2.1	Explicit VR Big Endian	1.2.840.10008.1.2.2	SCU	None
		Explicit VR Little Endian	1.2.840.10008.1.2.1		
		Implicit VR Little Endian	1.2.840.10008.1.2		

4.2.1.3.3.3. SOP Specific Conformance for Patient Root Query/Retrieve Information Model - FIND SOP Class

4.2.1.3.3.3.1 Dataset Specific Conformance for Patient Root Q/R Information Model - FIND SOP Class SCU

Table 36: Requested Query Keys for Patient Root Q/R Information Model - FIND SOP Class SCU

Attribute Name	Tag	VR	Type Of Matching	Comment
Query/Retrieve Level	0008,0052	CS	Single Value	
Q/R Patient level				
Patient ID	0010,0020	LO	Single Value, Universal, WildCard	
Patient's Name	0010,0010	PN	Single Value, Universal, WildCard	
Q/R Study level				
Study Date	0008,0020	DA	Range, Single Value, Universal	
Accession Number	0008,0050	SH	Single Value, Universal, WildCard	
Patient's Name	0010,0010	PN	Single Value, Universal, WildCard	
Patient ID	0010,0020	LO	Single Value, Universal, WildCard	
Study ID	0020,0010	SH		
Q/R Series level				
Modality	0008,0060	CS	Single Value Matching	
Study Instance UID	0020,000D	UI	Single Value, Universal, WildCard	
Series Instance UID	0020,000E	UI	Single Value, Universal, WildCard	
Series Number	0020,0011	IS	Single Value, Universal, WildCard	

4.2.1.3.3.4 SOP Specific Conformance for Study Root Query/Retrieve Information Model - FIND SOP Class SCU

4.2.1.3.3.4.1 Dataset Specific Conformance for Study Root Q/R Information Model - FIND SOP Class SCU

Table 37: Supported Query Keys for Study Root Q/R Information Model - FIND SOP Class SCU

Attribute Name	Tag	VR	Type Of Matching	Comment
Query/Retrieve Level	0008,0052	CS	Single Value	
Q/R Study level				
Study Date	0008,0020	DA	Range, Single Value, Universal	
Accession Number	0008,0050	SH	Single Value, Universal, WildCard	
Patient's Name	0010,0010	PN	Single Value, Universal, WildCard	
Patient ID	0010,0020	LO	Single Value, Universal, WildCard	
Study ID	0020,0010	SH		
Q/R Series level				
Modality	0008,0060	CS	Single Value Matching	
Study Instance UID	0020,000D	UI	Single Value, Universal, WildCard	
Series Instance UID	0020,000E	UI	Single Value, Universal, WildCard	
Series Number	0020,0011	IS	Single Value, Universal, WildCard	

4.2.1.3.4 (Real-World) Activity – MOVE as SCU

4.2.1.3.4.1 Description and Sequencing of Activities

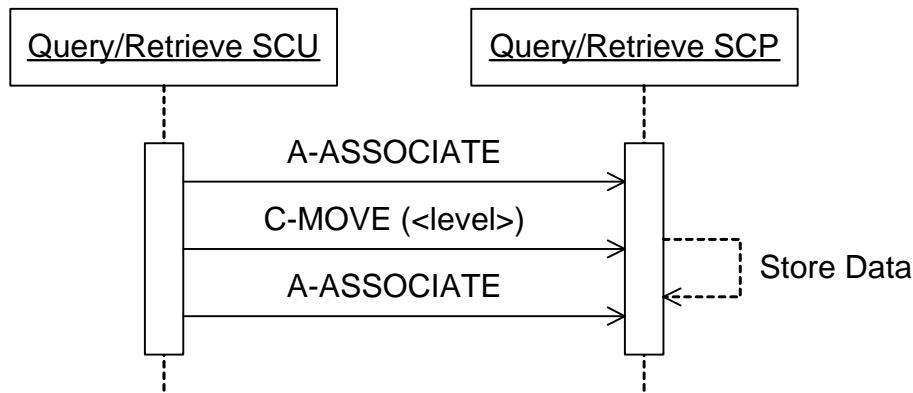

Figure 7: Data Flow Diagram – MOVE as SCU

Q-Station implements the Query/Retrieve service class to move selected studies per Query/Retrieve SCP. After receiving C-FIND responses one is able to copy all or selected images in a patient folder from a remote database to the local database. Q-Station initiates an association to the selected peer entity, sends a C-MOVE request and receives the related C-MOVE responses. The association is released after the final C-MOVE response (when all selected images have been transmitted).

4.2.1.3.4.2 Proposed Presentation Contexts

Table 38: Proposed Presentation Contexts for (Real-World) Activity – MOVE as SCU

Presentation Context Table					
Abstract Syntax		Transfer Syntax		Role	Extended Negotiation
Name	UID	Name List	UID List		
Patient Root Query/Retrieve Information Model - MOVE SOP Class	1.2.840.10008.5.1.4.1.2.1.2	Explicit VR Big Endian	1.2.840.10008.1.2.2	SCU	None
		Explicit VR Little Endian	1.2.840.10008.1.2.1		
		Implicit VR Little Endian	1.2.840.10008.1.2		
Study Root Query/Retrieve Information Model - MOVE SOP Class	1.2.840.10008.5.1.4.1.2.2.2	Explicit VR Big Endian	1.2.840.10008.1.2.2	SCU	None
		Explicit VR Little Endian	1.2.840.10008.1.2.1		
		Implicit VR Little Endian	1.2.840.10008.1.2		

4.2.1.3.4.3 SOP Specific Conformance for Patient Root Query/Retrieve Information Model - MOVE SOP Class

4.2.1.3.4.3.1 Dataset Specific Conformance for Patient Root Q/R Information Model - MOVE SOP Class SCU

Table 39: Identifiers for Patient Root Q/R Information Model - MOVE SOP Class

SCU

Attribute Name	Tag	VR	Comment
Patient Root Information Model			
Query/Retrieve Level	0008,0052	CS	
Q/R Patient level			
Patient ID	0010,0020	LO	
Q/R Study level			
Patient ID	0010,0020	LO	
Study Instance UID	0020,000D	UI	
Q/R Series level			
Patient ID	0010,0020	LO	
Study Instance UID	0020,000D	UI	
Series Instance UID	0020,000E	UI	

4.2.1.3.4.4 SOP Specific Conformance for Study Root Query/Retrieve Information Model - MOVE SOP Class

4.2.1.3.4.4.1 Dataset Specific Conformance for Study Root Query/Retrieve Information Model - MOVE SOP Class SCU

Table 40: Identifiers for Study Root Query/Retrieve Information Model - MOVE SOP Class SCU

Attribute Name	Tag	VR	Comment
Study Root Information Model			
Query/Retrieve Level	0008,0052	CS	
Q/R Study level			
Study Instance UID	0020,000D	UI	
Q/R Series level			
Study Instance UID	0020,000D	UI	
Series Instance UID	0020,000E	UI	

4.2.1.3.5 (Real-World) Activity – Image Export

4.2.1.3.5.1 Description and Sequencing of Activities

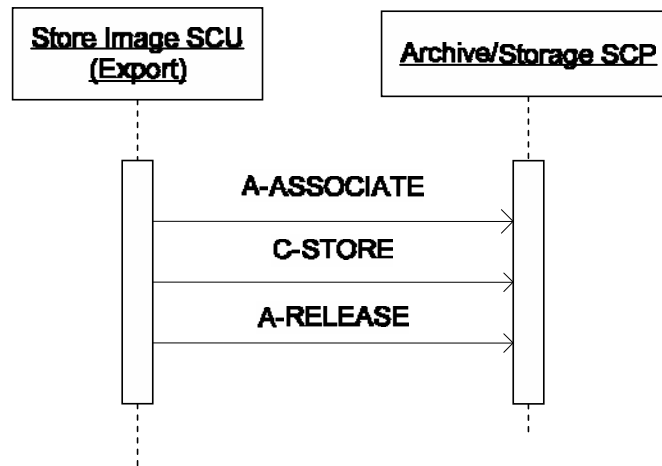

Figure 8: Data Flow Diagram – Store Image – Storage as SCU

Q-Station implements the Storage service class as part of Q-Station to store selected images to an archive or other storage SCP. All actual selected images are exported using one and the same association. Q-Station waits for synchronous report until, after a configurable time passed, it will release the association

4.2.1.3.5.2 Proposed Presentation Contexts

Table 41: Proposed Presentation Contexts for (Real-World) Activity – Image Export

Presentation Context Table					
Abstract Syntax		Transfer Syntax		Role	Ext. Negotiation
Name	UID	Name List*	UID List		
Ultrasound Multi-frame Image Storage SOP Class	1.2.840.10008.5.1.4.1.1.3.1	Not configurable	Ref. section 4.4.2	SCU	None
Ultrasound Image Storage SOP Class	1.2.840.10008.5.1.4.1.1.6.1	Not configurable	Ref. section 4.4.2	SCU	None
Secondary Capture Image Storage SOP Class	1.2.840.10008.5.1.4.1.1.7	Not configurable	Ref. section 4.4.2	SCU	None
General ECG Waveform Storage SOP Class	1.2.840.10008.5.1.4.1.1.9.1.2	Not configurable	Ref. section 4.4.2	SCU	None
Basic Text SR SOP Class	1.2.840.10008.5.1.4.1.1.88.11	Not configurable	Ref. section 4.4.2	SCU	None
Comprehensive SR SOP Class	1.2.840.10008.5.1.4.1.1.88.33	Not configurable	Ref. section 4.4.2	SCU	None
Enhanced SR SOP Class	1.2.840.10008.5.1.4.1.1.88.22	Not configurable	Ref. section 4.4.2	SCU	None
Encapsulated PDF Storage	1.2.840.10008.5.1.4.1.1.104.1	Not configurable	Ref. section 4.4.2	SCU	None

* Note: The Transfer syntax is not configurable, it will be as negotiated.

4.2.1.3.5.3. SOP Specific Conformance for Storage SOP Classes

Q-Station can be configured to stop the transfer of data when Q-Station receives an unsuccessful store response. Furthermore Q-Station can be configured in such a way that images can be converted to Secondary Captures.

Q-Station will transmit all optional or private image attributes. Also Q-Station can create attributes that are not in the image: these new attributes are exported along with the image (e.g. when the SCP does not support presentation state objects).

The object supplier shall be responsible for the presence of DICOM UIDs. The export job will transparently exchange this UID when the image is exported in 'DICOM 2000' format (i.e. separate Presentation State).

The following choices are supported concerning the export of private objects:

- The object can be exported as a private SOP class instance.
- The object is not exported at all.

Following remarks hold for the standard DICOM SOP Classes:

- Q-Station supports the following Photometric Interpretations for non-compressed images:
 - MONOCHROME1;
 - MONOCHROME2;
 - PALETTE COLOR;
 - RGB;
 - YBR_FULL;
 - YBR_FULL_422;
 - YBR_PARTIAL_422;
 - YBR_ICT;
 - YBR_RCT.
- Q-Station can convert Transfer Syntaxes from internal to external values. So Q-Station can convert from internally JPEG compressed/uncompressed pixel data to external JPEG compressed/uncompressed pixel data.
- JPEG Lossless (NH-FOP) compresses all bits denoted by the attribute DICOM_BITS_ALLOCATED. Therefore, any overlays encoded in the pixel data are also encoded and decoded.
- In case of both source (internal) and target compressed pixel data, decompression of the source pixel data and compression to the target pixel data only takes place in the following cases:
 - The source and target compression formats are different; or:
 - The source pixel data is multi-frame without a BOT.
- The BOT in compressed pixel data is filled if:
 - this is explicitly configured; or:
 - group length attributes are configured.

Q-Station allows import of mixed series: a series containing a maximum of 2 Secondary Capture images in addition to images from another SOP class.

All details regarding the specific conformance, including response behavior to all status codes, both from an application level and communication errors are provided in Table 43.

Table 42: C-STORE Command Response Status Handling Behavior

Service Status	Code	Further Meaning	Behavior
Success	0000	Storage is complete	Progress of the export job is updated and connection is retained for the next store. If the store of all the SOP instances is completed then the connection is released.
Failure	A7xx	Refused – Out of resources	Error is logged and the export job fails. Connection is released.
	A9xx	Error – Data set does not match SOP class	Error is logged and the export job fails. Connection is released.
	Cxxx	Error – Cannot understand	Error is logged and the export job fails. Connection is released.
Warning	B000	Coercion of data elements	Warning is logged and the export job continues. Connection is not released.
	B006	Elements discarded	Warning is logged and the export job continues. Connection is not released.
	B007	Data set does not match SOP class	Warning is logged and the export job continues. Connection is not released.

4.2.1.4 Association Acceptance Policy

This describes the conditions under which the AE will initiate an association. The behavior of the AE during association rejection is summarized in next table

4.2.1.4.1 (Real-World) Activity – Verification as SCP

4.2.1.4.1.1 Description and Sequencing of Activities

Q-Station accepts Associations from configured systems that wish to verify application level communication using the C-ECHO command.

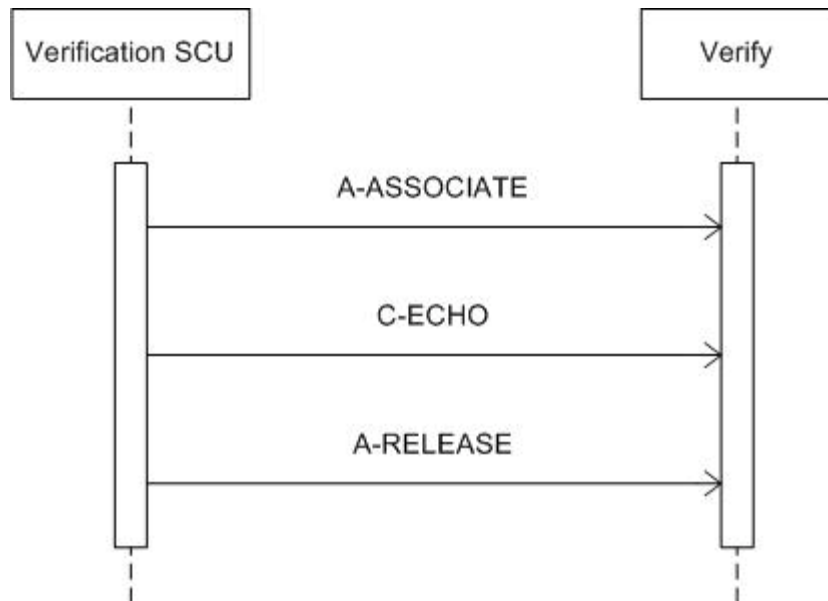

Figure 11: Data Flow Diagram – Verify

4.2.1.4.1.2 Accepted Presentation Contexts

Q-Station accepts all contexts in the intersection of the proposed and acceptable Presentation Contexts. This means that multiple proposed presentation contexts with

the same SOP class but different transfer syntaxes are accepted by Q-Station as far as those transfer syntaxes are part of the acceptable transfer syntaxes. There is no check for duplicate contexts and these are therefore accepted.

Table 43: Acceptable Presentation Contexts for (Real-World) Activity – Verification as SCP

Presentation Context Table					
Abstract Syntax		Transfer Syntax		Role	Extended Negotiation
Name	UID	Name List	UID List		
Verification SOP Class	1.2.840.10008.1.1	Explicit VR Big Endian	1.2.840.10008.1.2.2	SCP	None
		Explicit VR Little Endian	1.2.840.10008.1.2.1		
		Implicit VR Little Endian	1.2.840.10008.1.2		

4.2.1.4.1.3 SOP Specific Conformance for Verification SOP Class

4.2.1.4.1.3.1 Dataset Specific Conformance for Verification C-ECHO SCP

Q-Station provides standard conformance to the DICOM Verification service class. All possible status responses are described in Table 44.

Table 44: Q-Station C-ECHO Status Response

Service Status	Code	Further Meaning	Description
Success	0000	Confirmation	Confirm the verification request.

4.2.1.4.2 (Real-World) Activity – FIND as SCP

Q-Station does not support Find as SCP.

4.2.1.4.3 (Real-World) Activity – MOVE as SCP

Q-Station does not support Move as SCP.

4.2.1.4.4 (Real-World) Activity – Image Import

4.2.1.4.4.1 Description and Sequencing of Activities

Q-Station accepts associations from configured systems that wish to store images in the Q-Station database using the C-STORE command.

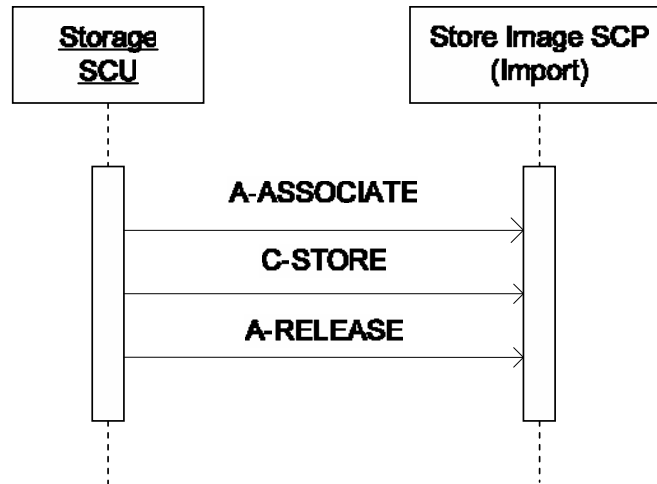

Figure 14: Data Flow Diagram – Store Image – Storage as SCP

4.2.1.4.4.2 Accepted Presentation Contexts

Q-Station accepts all contexts in the intersection of the proposed and acceptable Presentation Contexts. This means that multiple proposed presentation contexts with the same SOP class but different transfer syntaxes are accepted by Q-Station as far as those transfer syntaxes are part of the acceptable transfer syntaxes. There is no check for duplicate contexts and these are therefore accepted.

Table 45: Acceptable Presentation Contexts for (Real-World) Activity – Image Import

Presentation Context Table					
Abstract Syntax		Transfer Syntax		Role	Ext. Negotiation
Name	UID	Name List*	UID List		
Ultrasound Multi-frame Image Storage SOP Class	1.2.840.10008.5.1.4.1.1.3.1	Not configurable	Ref. section 4.4.2	SCP	None
Ultrasound Image Storage SOP Class	1.2.840.10008.5.1.4.1.1.6.1	Not configurable	Ref. section 4.4.2	SCP	None
Secondary Capture Image Storage SOP Class	1.2.840.10008.5.1.4.1.1.7	Not configurable	Ref. section 4.4.2	SCP	None
General ECG Waveform Storage SOP Class	1.2.840.10008.5.1.4.1.1.9.1.2	Not configurable	Ref. section 4.4.2	SCP	None
Basic Text SR SOP Class	1.2.840.10008.5.1.4.1.1.88.11	Not configurable	Ref. section 4.4.2	SCP	None
Comprehensive SR SOP Class	1.2.840.10008.5.1.4.1.1.88.33	Not configurable	Ref. section 4.4.2	SCP	None
Enhanced SR SOP Class	1.2.840.10008.5.1.4.1.1.88.22	Not configurable	Ref. section 4.4.2	SCP	None
Encapsulated PDF Storage	1.2.840.10008.5.1.4.1.1.104.1	Not configurable	Ref. section 4.4.2	SCP	None

* Note: The Transfer syntax is not configurable, it will be as negotiated.

4.2.1.4.4.3 SOP Specific Conformance for Storage SOP Classes

Q-Station will only accept associations from configured systems. Q-Station may provide level 2 (full) conformances, depending on the implemented database. All possible status responses are described in Table 46.

Remarks:

- Pixel data will be stored as received.
- A non-empty BOT may be present in imported JPEG encoded pixel data.
- Value Representation 'UN' (Unknown) is supported, and shall be used for any attributes not known to Q-Station and received per implicit transfer (ILE).
- Images must contain the minimum set of attributes prescribed by DICOM. Otherwise the default behavior is that the image is rejected and the association aborted.

Table 46: Q-Station C-STORE Status Response

Service Status	Code	Further Meaning	Description
Success	0000	-	Successful completion of the store request.
Failure	A700	Refused – Out of resources	Not enough resources available to do a store.
	C000	Error – Cannot understand	Any other exception generated during the store.

4.3 Network Interfaces

4.3.1 Physical Network Interfaces

Protocols used:

- The TCP/IP stack from the Windows operating system is used.
- DICOM V3.0 TCP/IP is supported.

4.3.2 Additional Protocols

No additional protocols are used.

4.4 Configuration

Any implementation's DICOM conformance may be dependent upon configuration, which takes place at the time of installation. Issues concerning configuration is addressed in this section.

4.4.1 AE Title/Presentation Address Mapping

4.4.1.1 Local AE Titles

The Q-Station User Interface only allows one AE to be configured.

The following AE specific information must be available to configure a local AE:

- AE title.
- Port number (note that normally all local Q-Station AE's will have a different port number).

The Hostname and IP Address are set from the host PC. The host must be set to use IPv4.

4.4.1.2 Remote AE Title/Presentation Address Mapping

One or more remote AE's may be configured.

The following AE specific information must be available to configure a remote AE:

- AE title.
- Hostname or IP address (or both).
- Port number.

4.4.2 Parameters

In Table 47 an overview is given of some important configuration attributes related to the DICOM behavior of Q-Station.

Table 47: Configuration Parameters table

Parameter	Configurable	Default Value
General Parameters		
Time-out waiting for acceptance or rejection response to an association Open request. (Application level time-out / ARTIM)	Yes	60 [s] (set 0 for no time-out)
General DIMSE level time-out values	No	-
Time-out waiting for response to TCP/IP connect request. (Low-level time-out)	OS	-
Time-out waiting for acceptance of a TCP/IP message over the network. (Low-level time-out)	OS	-
Time-out for waiting for data between TCP/IP packets. (Low-level time-out)	OS	-
Any changes to default TCP/IP settings, such as configurable stack parameters.	OS	-
AE Specific Parameters		
Size constraint in maximum object size	No	-
Maximum PDU size the AE can send and receive	No	0
Association time-out SCP	No	0 (no time-out)
Association time-out SCU	No	0 (no time-out; set -1 for immediate time-out, or else value in [s])
AE specific DIMSE level time-out values	No	300 [s] (set 0 for no time-out)
Number of simultaneous associations by service and/or SOP class	No	1 per service/SOP class
SOP Class support	No	All supported SOP classes
Transfer Syntax support*	No	ELE 1.2.840.10008.1.2.1 EBE 1.2.840.10008.1.2.2 ILE 1.2.840.10008.1.2 JPEG Lossless (NH-FOP) 1.2.840.10008.1.2.4.70 JPEG Baseline 1.2.840.10008.1.2.4.50 JPEG Extended 1.2.840.10008.1.2.4.51 JPEG 2000 (Lossless Only) 1.2.840.10008.1.2.4.90 JPEG 2000 1.2.840.10008.1.2.4.91 RLE 1.2.840.10008.1.2.5

* All transfer syntaxes are proposed for every SOP class.

5 MEDIA INTERCHANGE

5.1.1 Application Data Flow Diagram

Q-Station implements one media application entity: Q-Station.

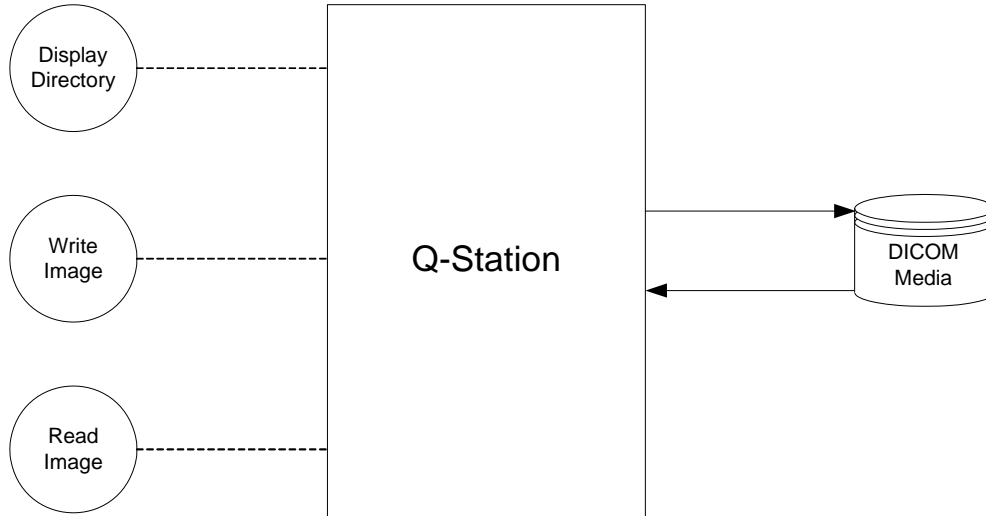

Figure 15: Application Data Flow Diagram

DICOM Media is defined per Application Profile as specified in Table 51.

5.1.2 Functional Definitions of AE's

Q-Station implements the following functions for DICOM media.

- Write a DICOM file-set onto the medium.
- Create a DICOMDIR file.
- Read the DICOMDIR file from the medium.
- Read selected images from the medium.

5.1.3 Sequencing of Real World Activities

Not applicable.

5.1.4 File Meta Information for Implementation Class and Version

The following values are assigned to the File Meta Information attributes (see PS 3.10) that pertain to the Implementation Class and Version.

Table 48: DICOM Implementation Class and Version for Q-Station

File Meta Information Version	00, 01
Implementation Class UID	1.3.46.670589.5.2.10
Implementation Version Name	81.302.3.2

5.2 AE Specifications

5.2.1 Q-Station

Q-Station provides standard conformance to the DICOM interchange option of the media storage service class, and follows the specifications as defined in the DICOM standard – Media Storage and File Format for Data Interchange (PS 3.10) and Media Storage Application Profiles (PS 3.11).

Q-Station supports multi-patient and multi-session for CD-R media (both reading and writing). Table 49 shows for each Application Profile in the first column the real-world activities in the second column, the roles required for each of these real-world activities in the third column, and the related service class option in the fourth column.

Table 49: AE Related Application Profiles, Real-World Activities, and Roles

Supported Application Profile	Real-World Activity	Roles	SC Option
STD-GEN-CD	Display Directory	FSR	Interchange
	Read Image	FSR	Interchange
	Write Image	FSC	Interchange
STD-US-SC-MF-CD-R	Display Directory	FSR	Interchange
	Read Image	FSR	Interchange
	Write Image	FSC	Interchange
STD-GEN-DVD-JPEG	Display Directory	FSR	Interchange
	Read Image	FSR	Interchange
	Write Image	FSC	Interchange
STD-GEN-USB-JPEG	Display Directory	FSR	Interchange
	Read Image	FSR	Interchange
	Write Image	FSC/FSU	Interchange

5.2.1.1 File Meta Information for Q-Station

Q-Station has no specific File Meta Information.

5.2.1.2 Real-World Activities

5.2.1.2.1 Display Directory

Q-Station will act as a FSR when reading the directory of the medium. This allows the System Integrator to see the results in an overview of the patients, studies, series presentation states and images.

Q-Station will not access DICOM media when either:

- Patient ID is absent; or
- Study Instance UID has no value; or
- Series Instance UID has no value.

5.2.1.2.1.1 Media Storage Application Profile

Refer to Table 49.

5.2.1.2.2 Read Image

Q-Station will act as a FSR when reading all/selected images from DICOM media.

5.2.1.2.2.1 Media Storage Application Profile

Refer to Table 49.

5.2.1.2.3 Write Image

Q-Station acts as an FSC when writing DICOM objects onto CD/DVD or USB DICOM media. Q-Station can also store private attributes.

Q-Station additionally acts as an FSU when writing DICOM objects onto USB.

When Q-Station has to write objects to DICOM media, it can encounter the following situation.

The objects were previously received via C-STORE operations. Some attributes in the received images have a zero-length value (type 2 attributes). However, the Application Profile specifies some of these attributes as type 1: they must have a value. In such cases Q-Station supplies a value for the following attributes (if necessary):

- Patient ID;
- Study ID;
- Series Number;
- Instance number;
- Study Date;
- Study Time.

The mechanism of generating a value for Patient ID is to create a new value (i.e. Study Instance UID) for each new study written to the medium, even if this study belongs to a patient recorded earlier.

Study ID is assigned the value of the first Requested Procedure ID (0040,1001) encountered in the Request Attributes Sequence (0040,0275).

5.2.1.2.3.1 Media Storage Application Profile

See Table 50 for a Private SOP Class used for Media Export of Draft Reports.

Table 50: IODs, SOP Classes and Transfer Syntaxes for Media Write

Information Object Definition	SOP Class UID	Transfer Syntax	Transfer Syntax UID
Private Draft Report Storage	1.3.46.670589.2.8.1.1	ILE	1.2.840.10008.1.2

5.3 Augmented and Private Application Profiles

5.3.1 Augmented Application Profiles

5.3.1.1 Augmented Application Profile Descriptions

5.3.1.1.1 SOP Class Augmentations

Draft Reports are stored to media using a Private SOP class which is an augmentation to the standard AP.

5.3.1.1.2 Directory Augmentations

Instances of the private SOP classes may be written on the media. This requires a Directory Record Type (0004,1430) with the value "PRIVATE" and configuration of the required Private Record UID. This UID is used to define a non-standard type of Directory Record by reference to its position in a private extension to the DICOM Basic Directory IOD Information Model.

5.3.1.1.3 Other Augmentations

Not applicable.

5.3.2 Private Application Profiles

Not applicable.

5.4 Media Configuration

DICOM Media Configuration choices are on Q-Station using the Tools>Customize

CD/DVD Write Preferences dialog box. It contains the following choices:

Media Type: CD or DVD

Multiple patients on Media: Yes or No

DICOM Viewer: Yes or No

No other configuration options are available.

6 SUPPORT OF CHARACTER SETS

Q-Station supports all character sets currently defined by DICOM except for the multi-byte character sets without code extensions. Thus Q-Station supports the following character repertoires.

Table 51: Supported DICOM Character Sets of Q-Station

Character Set Description	Defined Term	ESC Sequence	ISO Registration Number	Code Element	Character Set
Single-byte Character Sets without Code Extensions					
Default repertoire	-	-	ISO-IR 6	G0	ISO 646
Japanese	ISO_IR 13	-	ISO-IR 14	G0	JIS X 0201: Romaji
		-	ISO-IR 13	G1	JIS X 0201: Katakana
Latin alphabet No. 1	ISO_IR 100	-	ISO-IR 6	G0	ISO 646
		-	ISO-IR 100	G1	Supplementary set of ISO 8859
Latin alphabet No. 2	ISO_IR 101	-	ISO-IR 6	G0	ISO 646
		-	ISO-IR 101	G1	Supplementary set of ISO 8859
Latin alphabet No. 3	ISO_IR 109	-	ISO-IR 6	G0	ISO 646
		-	ISO-IR 109	G1	Supplementary set of ISO 8859
Latin alphabet No. 4	ISO_IR 110	-	ISO-IR 6	G0	ISO 646
		-	ISO-IR 110	G1	Supplementary set of ISO 8859
Greek	ISO_IR 126	-	ISO-IR 6	G0	ISO 646
		-	ISO-IR 126	G1	Supplementary set of ISO 8859
Arabic	ISO_IR 127	-	ISO-IR 6	G0	ISO 646
		-	ISO-IR 127	G1	Supplementary set of ISO 8859
Hebrew	ISO_IR 138	-	ISO-IR 6	G0	ISO 646
		-	ISO-IR 138	G1	Supplementary set of ISO 8859
Cyrillic	ISO_IR 144	-	ISO-IR 6	G0	ISO 646
		-	ISO-IR 144	G1	Supplementary set of ISO 8859
Latin alphabet No. 5	ISO_IR 148	-	ISO-IR 6	G0	ISO 646
		-	ISO-IR 148	G1	Supplementary set of ISO 8859
Thai	ISO_IR 166	-	ISO-IR 6	G0	ISO 646
		-	ISO-IR 166	G1	TIS 620-2533 (1990)

Single-byte Character Sets with Code Extensions					
Default repertoire	ISO 2022 IR 6	ESC 02/08 04/02	ISO-IR 6	G0	ISO 646
Japanese	ISO 2022 IR 13	ESC 02/08 04/10	ISO-IR 14	G0	JIS X 0201: Romaji
		ESC 02/09 04/09	ISO-IR 13	G1	JIS X 0201: Katakana
Latin alphabet No. 1	ISO 2022 IR 100	ESC 02/08 04/02	ISO-IR 6	G0	ISO 646
		ESC 02/13 04/01	ISO-IR 100	G1	Supplementary set of ISO 8859
Latin alphabet No. 2	ISO 2022 IR 101	ESC 02/08 04/02	ISO-IR 6	G0	ISO 646
		ESC 02/13 04/02	ISO-IR 101	G1	Supplementary set of ISO 8859
Latin alphabet No. 3	ISO 2022 IR 109	ESC 02/08 04/02	ISO-IR 6	G0	ISO 646
		ESC 02/13 04/03	ISO-IR 109	G1	Supplementary set of ISO 8859

Character Set Description	Defined Term	ESC Sequence	ISO Registration Number	Code Element	Character Set
Latin alphabet No. 4	ISO 2022 IR 110	ESC 02/08 04/02	ISO-IR 6	G0	ISO 646
		ESC 02/13 04/04	ISO-IR 110	G1	Supplementary set of ISO 8859
Greek	ISO 2022 IR 126	ESC 02/08 04/02	ISO-IR 6	G0	ISO 646
		ESC 02/13 04/06	ISO-IR 126	G1	Supplementary set of ISO 8859
Arabic	ISO 2022 IR 127	ESC 02/08 04/02	ISO-IR 6	G0	ISO 646
		ESC 02/13 04/07	ISO-IR 127	G1	Supplementary set of ISO 8859
Hebrew	ISO 2022 IR 138	ESC 02/08 04/02	ISO-IR 6	G0	ISO 646
		ESC 02/13 04/08	ISO-IR 138	G1	Supplementary set of ISO 8859
Cyrillic	ISO 2022 IR 144	ESC 02/08 04/02	ISO-IR 6	G0	ISO 646
		ESC 02/13 04/12	ISO-IR 144	G1	Supplementary set of ISO 8859
Latin alphabet No. 5	ISO 2022 IR 148	ESC 02/08 04/02	ISO-IR 6	G0	ISO 646
		ESC 02/13 04/13	ISO-IR 148	G1	Supplementary set of ISO 8859
Thai	ISO 2022 IR 166	ESC 02/08 04/02	ISO-IR 6	G0	ISO 646
		ESC 02/13 05/04	ISO-IR 166	G1	TIS 620-2533 (1990)

The preferred character set can be configured. If not configured, the default character set shall be ISO-IR 100.

When an unsupported character set is received it shall be tried and decoded according the preferred character set.

Unsupported characters shall be displayed as “?”.

7 SECURITY

7.1 Security Profiles

Q-Station does not fully support DICOM security profiles. However, it does support security measures that will be used for the generation of audit records. Q-Station components for security measures are:

- Audit Trail Component

7.1.1 Audit Trail Component

The Audit Trail Component of Q-Station allows security officers in an institution to audit activities, to detect non-compliant behavior in the enterprise, and to facilitate detection of improper creation, access, modification and deletion of Protected Health Information (PHI), where PHI data is considered as information records (Registration, Order, Study/Procedure, Reports and to a lesser degree Images/Presentation States), and not the flow of information between the systems.

The messages are created and sent to a syslog server according to the syslog protocol. The time that is used will be the local time of the system. The syslog server is an element of the Hospital infrastructure.

7.2 Association Level Security

Q-Station accepts associations only from known applications or an application whose “calling AE Title” is defined in its configuration file. Q-Station will reject association requests from unknown applications, i.e. applications that offer an unknown “calling AE title”. An application entity (AE) is known if – and only if – it is defined during configuration of Q-Station, which is done via the configuration application.

7.3 Application Level Security

Q-Station supports security measures for:

- generation of audit trail records
- access control and user authentication.

8 ANNEXES OF APPLICATION "Q-Station"

8.1 IOD Contents

8.1.1 Created SOP Instance

This section specifies each IOD created by Q-Station, including the attribute name, tag, VR, and value (range, condition and source).

Defined abbreviations are:

ALWAYS	the module shall always be present
EMPTY	the (mandatory) module shall not contain any attributes
CONDITIONAL	the module may be present under specified condition
NEVER	the module shall never be present
ALWAYS	the attribute shall always be present with value
ANAP	the attribute shall be present with value under specified condition
EMPTY	the attribute shall always be present without value
ANAPEV	the attribute shall be present without value under specified condition
VNAP	the attribute shall always be present, either with or without value
ANAPCV	the attribute shall be present, either with or without value, under specified condition
AUTO	the attribute value is generated automatically
CONFIG	the attribute value source is a configurable parameter
COPY	the attribute value source is another SOP instance
FIXED	the attribute value is hard-coded in the application
IMPLICIT	the attribute value source is a user-implicit setting
USER	the attribute value source is explicit user input

8.1.1.1 Basic Directory IOD

Table 52: Modules of the Basic Directory IOD

Information Entity	Module Name	Usage
Media	File-set Identification Module	ALWAYS
	Directory Information Module	ALWAYS

Table 53: Created Basic Directory IOD Attributes

Name	Tag	VR	Definition	Comment
File-set Identification Module				
File-set ID	0004,1130	CS	ALWAYS, AUTO	-
Specific Character Set of File-set Descriptor File	0004,1142	CS	ANAP, AUTO	-
Directory Information Module				
Offset of the First Directory Record of the Root Directory Entity	0004,1200	UL	ALWAYS, AUTO	-
Offset of the Last Directory Record of the Root Directory Entity	0004,1202	UL	ALWAYS, AUTO	-
File-set Consistency Flag	0004,1212	US	ALWAYS, AUTO	-
Directory Record Sequence	0004,1220	SQ	ALWAYS, AUTO	-
> Offset of the Next Directory Record	0004,1400	UL	ANAP, AUTO	-

Name	Tag	VR	Definition	Comment
> Record In-use Flag	0004,1410	US	ANAP, AUTO	-
> Offset of Referenced Lower-Level Directory Entity	0004,1420	UL	ANAP, AUTO	-
> Directory Record Type	0004,1430	CS	ANAP, AUTO	-
> Referenced File ID	0004,1500	CS	ANAP, AUTO	-
> Referenced SOP Class UID in File	0004,1510	UI	ANAP, AUTO	-
> Referenced SOP Instance UID in File	0004,1511	UI	ANAP, AUTO	-
> Referenced Transfer Syntax UID in File	0004,1512	UI	ANAP, AUTO	-
> Patient Keys				
> Specific Character Set	0008,0005	CS	ANAP, AUTO	-
> Patient's Name	0010,0010	PN	VNAP, USER	-
> Patient ID	0010,0020	LO	ALWAYS, USER	-
> Patient's Birth Date	0010,0030	DA	VNAP, USER	-
> Patient's Sex	0010,0040	CS	VNAP, USER	-
> Study Keys				
> Specific Character Set	0008,0005	CS	ANAP, AUTO	-
> Study Date	0008,0020	DA	ALWAYS, AUTO	-
> Study Time	0008,0030	TM	ALWAYS, AUTO	-
> Accession Number	0008,0050	SH	VNAP, USER	-
> Modalities in Study	0008,0061	CS	ALWAYS, AUTO	-
> Referring Physician's Name	0008,0090	PN	VNAP, USER	-
> Study Description	0008,1030	LO	EMPTY, AUTO	-
> Study Instance UID	0020,000D	UI	ANAP, AUTO	-
> Study ID	0020,0010	SH	ALWAYS, AUTO	-
> Series Keys				
> Specific Character Set	0008,0005	CS	ANAP, AUTO	-
> Series Date	0008,0021	DA	ALWAYS, AUTO	-
> Series Time	0008,0031	TM	ALWAYS, AUTO	-
> Modality	0008,0060	CS	ALWAYS, AUTO	-
> Series Description	0008,103E	LO	ALWAYS, AUTO	-
> Body Part Examined	0018,0015	CS	ALWAYS, IMPLICIT	-
> Series Instance UID	0020,000E	UI	ALWAYS, AUTO	-
> Series Number	0020,0011	IS	ALWAYS, AUTO	-
> Image Keys				
> Specific Character Set	0008,0005	CS	ANAP, AUTO	-

Name	Tag	VR	Definition	Comment
> Image Type	0008,0008	CS	ALWAYS, AUTO	-
> SOP Instance UID	0008,0018	UI	ALWAYS, AUTO	-
> Instance Number	0020,0013	IS	ALWAYS, AUTO	-
> Presentation Keys				
> Specific Character Set	0008,0005	CS	ANAP, AUTO	-
> Referenced Series Sequence	0008,1115	SQ	ALWAYS, AUTO	-
>> Referenced Image Sequence	0008,1140	SQ	ANAP, AUTO	-
>>> Referenced SOP Class UID	0008,1150	UI	ALWAYS	-
>>> Referenced SOP Instance UID	0008,1155	UI	ALWAYS	-
>> Series Instance UID	0020,000E	UI	ALWAYS	-
> Instance Number	0020,0013	IS	ALWAYS, AUTO	-
> Content Label	0070,0080	CS	ALWAYS	-
> Content Description	0070,0081	LO	VNAP	-
> Presentation Creation Date	0070,0082	DA	ALWAYS	-
> Presentation Creation Time	0070,0083	TM	ALWAYS	-
> Content Creator's Name	0070,0084	PN	VNAP	-
> Private Keys				
>	-	-	-	As per configuration.

8.1.1.3 Basic Film Session IOD

Table 54: Modules of the Basic Film Session IOD

Information Entity	Module Name	Usage
Image	SOP Common Module	EMPTY
Film	Basic Film Session Presentation Module	ALWAYS (N-CREATE)
	Basic Film Session Relationship Module	EMPTY

Table 55: Created Basic Film Session IOD Attributes

Name	Tag	VR	Definition	Comment
Basic Film Session Presentation Module				
Number of Copies	2000,0010	IS	ALWAYS, IMPLICIT	-
Print Priority	2000,0020	CS	ALWAYS, AUTO	-
Medium Type	2000,0030	CS	ALWAYS, IMPLICIT	-
Film Destination	2000,0040	CS	ALWAYS, AUTO	-
Film Session Label	2000,0050	LO	ALWAYS, AUTO	-

8.1.1.4 Presentation LUT Shape IOD

Table 56: Modules of the Presentation LUT Shape IOD

Information Entity	Module Name	Usage
Image	SOP Common Module	EMPTY
Film	Presentation LUT Module	CONDITIONAL (N-CREATE)

Table 57: Created Presentation LUT Shape IOD Attributes

Name	Tag	VR	Definition	Comment
Presentation LUT Shape Module				
Presentation LUT Shape	(2050,0020)	CS	CONDIT ONAL, AUTO	"IDENTITY"

8.1.1.5 Basic Film Box IOD

Table 58: Modules of the Basic Film Box IOD

Information Entity	Module Name	Usage
Image	SOP Common Module	EMPTY
Film	Basic Film Box Presentation Module	ALWAYS (N-CREATE)
	Basic Film Box Relationship Module	ALWAYS
	Presentation LUT Shape Module	CONDITIONAL

Table 59: Created Basic Film Box IOD Attributes

Name	Tag	VR	Definition	Comment
Basic Film Box Presentation Module				
Image Display Format	(2010,0010)	ST	ALWAYS, AUTO	-
Film Orientation	(2010,0040)	CS	ALWAYS, IMPLICIT / CONFIG	-
Film Size ID	(2010,0050)	CS	ALWAYS, IMPLICIT / CONFIG	-
Magnification Type	(2010,0060)	CS	ALWAYS, AUTO	-
Max Density	(2010,0130)	US	ALWAYS, AUTO	-
Trim	(2010,0140)	CS	ALWAYS, AUTO	-
Configuration Information	(2010,0150)	ST	ALWAYS, AUTO	-
Illumination	(2010,015e)	US	ALWAYS, AUTO	-
Reflected Ambient Light	(2010,0160)	US	ALWAYS, AUTO	-
Basic Film Box Relationship Module				
Referenced Film Session Sequence	(2010,0500)	SQ	ALWAYS, AUTO	-
> Referenced SOP Class UID	(0008,1150)	UI	ALWAYS, AUTO	-
> Referenced SOP Instance UID	(0008,1155)	UI	ALWAYS, AUTO	-
Presentation LUT Shape Relationship Module				

Referenced Presentation LUT Sequence	(2050,0500)	SQ	CONDITIONAL, AUTO	-
> Referenced SOP Class UID	(0008,1150)	UI	ALWAYS, AUTO	-
> Referenced SOP Instance UID	(0008,1155)	UI	ALWAYS, AUTO	-

8.1.1.6 Basic Grayscale Image Box IOD

Table 60: Modules of the Basic Grayscale Image Box IOD

Information Entity	Module Name	Usage
Image	SOP Common Module	EMPTY
	Image Box Pixel Presentation Module	ALWAYS (N-SET)

Table 61: Created Basic Grayscale Image Box IOD Attributes

Name	Tag	VR	Definition	Comment
Image Box Pixel Presentation Module				
Image Position	(2020,0010)	US	ALWAYS, AUTO	-
Polarity	(2020,0020)	CS	ALWAYS, AUTO	-
Basic Grayscale Image Sequence	(2020,0110)	SQ	ALWAYS, AUTO	-
> Samples per Pixel	(0028,0002)	US	ALWAYS, AUTO	-
> Photometric Interpretation	(0028,0004)	CS	ALWAYS, IMPLICIT	-
> Rows	(0028,0010)	US	ALWAYS, IMPLICIT	-
> Columns	(0028,0011)	US	ALWAYS, IMPLICIT	-
> Bits Allocated	(0028,0100)	US	ALWAYS, AUTO	-
> Bits Stored	(0028,0101)	US	ALWAYS, IMPLICIT	-
> High Bit	(0028,0102)	US	ALWAYS, AUTO	-
> Pixel Representation	(0028,0103)	US	ALWAYS, AUTO	-
> Pixel Data	(7FE0,0010)	OB OW	ALWAYS, AUTO	-

8.1.1.7 Basic Color Image Box IOD

Table 62: Modules of the Basic Color Image Box IOD

Information Entity	Module Name	Usage
Image	SOP Common Module	EMPTY
	Image Box Pixel Presentation Module	ALWAYS (N-SET)

Table 63: Created Basic Color Image Box IOD Attributes

Name	Tag	VR	Definition	Comment
Image Box Pixel Presentation Module				
Image Position	(2020,0010)	US	ALWAYS, AUTO	-
Polarity	(2020,0020)	CS	ALWAYS, AUTO	-
Basic Color Image Sequence	(2020,0111)	SQ	ALWAYS, AUTO	-
> Samples per Pixel	(0028,0002)	US	ALWAYS, AUTO	-
> Photometric Interpretation	(0028,0004)	CS	ALWAYS, IMPLICIT	-
> Planar Configuration	(0028,0006)	US	ALWAYS, AUTO	-
> Rows	(0028,0010)	US	ALWAYS, IMPLICIT	-
> Columns	(0028,0011)	US	ALWAYS, IMPLICIT	-
> Bits Allocated	(0028,0100)	US	ALWAYS, AUTO	-
> Bits Stored	(0028,0101)	US	ALWAYS, IMPLICIT	-
> High Bit	(0028,0102)	US	ALWAYS, AUTO	-
> Pixel Representation	(0028,0103)	US	ALWAYS, AUTO	-
> Pixel Data	(7FE0,0010)	OB OW	ALWAYS, AUTO	-

8.1.1.8 Printer IOD

Table 64: Modules of the Printer IOD

Information Entity	Module Name	Usage
Image	SOP Common Module	EMPTY
Printer	Printer Module	EMPTY (N-GET)

Table 65: Created Printer IOD Attributes

Name	Tag	VR	Definition	Comment
Printer Module				
-	-	-	-	-

8.1.1.9 Secondary Capture IOD

Table 66: SC Image Patient Module Attributes

Name	Tag	VR	Definition	Comment
Patient's Name	(0010,0010)	PN	ALWAYS, AUTO	
Patient ID	(0010,0020)	LO	ALWAYS, AUTO	
Patient's Birth Date	(0010,0030)	DA	VNAP	Attribute must be present in original study
Patient's Sex	(0010,0040)	CS	VNAP	Attribute must be present in original study
Patient's Size	(0010,1030)	DS	VNAP	Attribute must be present in original study
Patient's Weight	(0010,1040)	DS	VNAP	Attribute must be present in original study
Patient Comments	(0010,4000)	LT	VNAP	

Table 67: SC Image General Study Module Attributes

Name	Tag	VR	Definition	Comment
Study Instance UID	(0020,000D)	UI	ALWAYS, AUTO	
Study Date	(0008,0020)	DA	ALWAYS, AUTO	
Study Time	(0008,0030)	TM	ALWAYS, AUTO	
Referring Physician's Name	(0008,0090)	PN	VNAP	Attribute must be present in original study
Study ID	(0020,0010)	SH	ALWAYS, AUTO	
Accession Number	(0008,0050)	SH	VNAP	Attribute must be present in original study
Study Description	(0008,1030)	LO	VNAP	Attribute must be present in original study

Table 68: SC Image General Series Module Attributes

Name	Tag	VR	Definition	Comment
Modality	(0008,0060)	CS	ALWAYS, AUTO	
Series Instance UID	(0020,000E)	UI	ALWAYS, AUTO	
Series Number	(0020,0011)	IS	ALWAYS, AUTO	
Series Date	(0008,0021)	DA	ALWAYS, AUTO	
Series Time	(0008,0031)	TM	ALWAYS, AUTO	
Protocol Name	(0018,1030)	LO	ANAP	Attribute must be present in original study
Operator's Name	(0008,1070)	PN	VNAP	Attribute must be present in original study
Referenced Performed Procedure Step Sequence	(0008,1111)	SQ	ALWAYS, AUTO	
> Referenced SOP Class UID	(0008,1150)	UI	ANAP	Only if SQ has one or more items
> Referenced SOP Instance UID	(0008,1155)	UI	ANAP	Only if SQ has one or more items

Performed Procedure Step ID	(0040,0253)	SH	ANAP	
Performed Procedure Step Start Date	(0040,0244)	DA	ANAP	
Performed Procedure Step Start Time	(0040,0245)	TM	ANAP	
Performed Procedure Step Description	(0040,0254)	LO	ANAP	
Comments on the Performed Procedure Steps	(0040,0280)	ST	ANAP	

Table 69: SC General Equipment Module Attributes

Name	Tag	VR	Definition	Comment
Manufacturer	(0008,0070)	LO	ALWAYS, AUTO	
Institution Name	(0008,0080)	LO	ALWAYS, AUTO	
Station Name	(0008,1010)	SH	ALWAYS, AUTO	
Manufacturer's Model Name	(0008,1090)	LO	VNAP	
Device Serial Number	(0018,1000)	LO	ALWAYS, AUTO	
Software Versions	(0018,1020)	LO	ALWAYS, AUTO	

Table 70: SC Equipment Module Attributes

Name	Tag	VR	Definition	Comment
Conversion Type	(0008,0064)	CS	ALWAYS, AUTO	
Modality	(0008,0050)	CS	ALWAYS, AUTO	

Table 71: SC General Image Module Attributes

Name	Tag	VR	Definition	Comment
Instance Number	(0020,0013)	IS	ALWAYS, AUTO	
Patient Orientation	(0020,0020)	CS	ALWAYS, EMPTY	
Image Type	(0008,0008)	CS	ALWAYS, AUTO	
Image Comments	(0020,4000)	LT	ALWAYS, AUTO	
Lossy Image Compression	(0028,2110)	CS	ALWAYS, AUTO	
Lossy Image Compression Ratio	(0028,2112)	DS	ANAP	
Lossy Image Compression Method	(0028,2114)	CS	ANAP	
Presentation Intent Type	(0008,0068)	CS	ALWAYS, AUTO	

Table 72: SC Image Pixel Module Attributes

Name	Tag	VR	Definition	Comment
Samples per Pixel	(0028,0002)	US	ALWAYS, AUTO	
Photometric Interpretation	(0028,0004)	CS	ALWAYS, AUTO	
Row	(0028,0010)	US	ALWAYS, AUTO	

Columns	(0028,0011)	US	ALWAYS, AUTO	
Bits Allocated	(0028,0100)	US	ALWAYS, AUTO	
Bits Stored	(0028,0101)	US	ALWAYS, AUTO	
High Bit	(0028,0102)	US	ALWAYS, AUTO	
Pixel Representation	(0028,0103)	US	ALWAYS, AUTO	
Pixel Data	(7FE0,0010)	OB / OW	ALWAYS, AUTO	
Planar Configuration	(0028,0006)	US	ALWAYS, AUTO	

Table 73: SC Image Module Attributes

Name	Tag	VR	Definition	Comment
Date of Secondary Capture	(0018,1012)	DA	ALWAYS, AUTO	
Time of Secondary Capture	(0018,1014)	TM	ALWAYS, AUTO	

Table 74: SC SOP Common Module Attributes

Name	Tag	VR	Definition	Comment
SOP Class UID	(0008,0016)	UI	ALWAYS, AUTO	
SOP Instance UID	(0008,0018)	UI	ALWAYS, AUTO	
Instance Creation Date	(0008,0012)	DA	ALWAYS, AUTO	
Instance Creation Time	(0008,0013)	TM	ALWAYS, AUTO	
Instance Number	(0020,0013)	IS	ALWAYS, AUTO	

Table 75: SC Private Attributes

Name	Tag	VR	Definition	Comment
Private Attribute	(2001,0010)	LO	ANAP	
Private Attribute	(2001,1063)	CS	ANAP	

Table 76: Encapsulated PDF Patient Module Attributes

Name	Tag	VR	Definition	Comment
Patient's Name	(0010,0010)	PN	ALWAYS, AUTO	
Patient ID	(0010,0020)	LO	ALWAYS, AUTO	
Patient's Birth Date	(0010,0030)	DA	VNAP	Attribute must be present in original study
Patient's Sex	(0010,0040)	CS	VNAP	Attribute must be present in original study

Table 77: Encapsulated PDF General Study Module Attributes

Name	Tag	VR	Definition	Comment
Study Instance UID	(0020,000D)	UI	ALWAYS, AUTO	
Study Date	(0008,0020)	DA	ALWAYS, AUTO	
Study Time	(0008,0030)	TM	ALWAYS, AUTO	
Referring Physician's Name	(0008,0090)	PN	VNAP	Attribute must be present in original study
Study ID	(0020,0010)	SH	ALWAYS, AUTO	
Accession Number	(0008,0050)	SH	VNAP	Attribute must be present in original study

Table 78: Encapsulated PDF Encapsulated Document Series Attributes

Name	Tag	VR	Definition	Comment
Modality	(0008,0060)	CS	ALWAYS, AUTO	
Series Instance UID	(0020,000E)	UI	ALWAYS, AUTO	
Series Number	(0020,0011)	IS	ALWAYS, AUTO	
Performed Procedure Step ID	(0040,0253)	IS	ALWAYS, AUTO	
Performed Procedure Step Start Date	(0040,0244)	DA	ALWAYS, AUTO	
Performed Procedure Step Start Time	(0040,0245)	TM	ALWAYS, AUTO	

Table 79: Encapsulated PDF General Equipment Module Attributes

Name	Tag	VR	Definition	Comment
Manufacturer	(0008,0070)	LO	ALWAYS, AUTO	
Manufacturer's Model Name	(0008,1090)	LO	VNAP	
Software Versions	(0018,1020)	LO	ALWAYS, AUTO	

Table 80: Encapsulated PDF SC Equipment Module Attributes

Name	Tag	VR	Definition	Comment
Conversion Type	(0008,0064)	CS	ALWAYS, AUTO	
Modality	(0008,0050)	CS	ALWAYS, AUTO	

Table 81: Encapsulated PDF Encapsulated Document Module Attributes

Name	Tag	VR	Definition	Comment
Instance Number	(0020,0013)	IS	ALWAYS, AUTO	
Content Date	(0008,0023)	DA	ALWAYS, AUTO	
Content Time	(0008,0033)	TM	ALWAYS, AUTO	
Acquisition DateTime	(0008,002A)	DT	ALWAYS, AUTO	
Burned In Annotation	(0028,0301)	CS	ALWAYS, AUTO	
Source Image Sequence	(0042,0013)	SQ	ALWAYS, AUTO	
Document Title	(0042,0010)	ST	ALWAYS, AUTO	
Concept Name Code Sequence	(0040,A043)	SQ	ALWAYS, AUTO	
MIME Type of Encapsulated Document	(0042,0012)	LO	ALWAYS, AUTO	
Encapsulated Document	(0042,0011)	OB	ALWAYS, AUTO	

Table 82: Encapsulated PDF SOP Common Module Attributes

Name	Tag	VR	Definition	Comment
Specific Character Set	(0008,0005)	CS	ALWAYS, AUTO	
SOP Class UID	(0008,0016)	UI	ALWAYS, AUTO	
SOP Instance UID	(0008,0018)	UI	ALWAYS, AUTO	
Instance Creation Date	(0008,0012)	DA	ALWAYS, AUTO	
Instance Creation Time	(0008,0013)	TM	ALWAYS, AUTO	
Instance Number	(0020,0013)	IS	ALWAYS, AUTO	

Table 83: Encapsulated PDF Private Attributes

Name	Tag	VR	Definition	Comment
Private Attribute	(2001,0010)	LO	ANAP	
Private Attribute	(2001,1063)	CS	ANAP	

Table 84: Private Draft Report Patient Module Attributes

Name	Tag	VR	Definition	Comment
Patient's Name	(0010,0010)	PN	ALWAYS, AUTO	
Patient ID	(0010,0020)	LO	ALWAYS, AUTO	
Patient's Birth Date	(0010,0030)	DA	VNAP	Attribute must be present in original study
Patient's Sex	(0010,0040)	CS	VNAP	Attribute must be present in original study
Patient's Size	(0010,1020)	DS	VNAP	
Patient's Weight	(0010,1030)	DS	VNAP	
Patient Comments	(0010,4000)	LT	VNAP	

Table 85: Private Draft Report General Study Module Attributes

Name	Tag	VR	Definition	Comment
Study Instance UID	(0020,000D)	UI	ALWAYS, AUTO	
Study Date	(0008,0020)	DA	ALWAYS, AUTO	
Study Time	(0008,0030)	TM	ALWAYS, AUTO	
Referring Physician's Name	(0008,0090)	PN	VNAP	Attribute must be present in original study
Study Description	(0008,1030)	LO	VNAP	
Study ID	(0020,0010)	SH	ALWAYS, AUTO	
Accession Number	(0008,0050)	SH	VNAP	Attribute must be present in original study

Table 86: Private Draft Report Encapsulated Document Series Attributes

Name	Tag	VR	Definition	Comment
Series Date	(0008,0021)	DA	ALWAYS, AUTO	
Series Time	(0008,0031)	TM	ALWAYS, AUTO	
Modality	(0008,0060)	CS	ALWAYS, AUTO	
Series Instance UID	(0020,000E)	UI	ALWAYS, AUTO	
Series Number	(0020,0011)	IS	ALWAYS, AUTO	
Referenced Performed Procedure Step Sequence	(0008,1111)	SQ	ALWAYS, AUTO	
> Referenced SOP Class UID	(0008,1150)	UI	ALWAYS, AUTO	
> Referenced SOP Instance UID	(0008,1155)	UI	ALWAYS, AUTO	
Performed Procedure Step ID	(0040,0253)	IS	ALWAYS, AUTO	
Performed Procedure Step Start Date	(0040,0244)	DA	ALWAYS, AUTO	

Performed Procedure Step Start Time	(0040,0245)	TM	ALWAYS, AUTO	
Comments on the Performed Procedure Step	(0040,0280)	ST	VNAP	

Table 87: Private Draft Report Encapsulated Document Module Attributes

Name	Tag	VR	Definition	Comment
Instance Number	(0020,0013)	IS	ALWAYS, AUTO	
Content Date	(0008,0023)	DA	ALWAYS, AUTO	
Content Time	(0008,0033)	TM	ALWAYS, AUTO	
Acquisition DateTime	(0008,002A)	DT	ALWAYS, AUTO	
Document Title	(0042,0010)	ST	ALWAYS, AUTO	
Concept Name Code Sequence	(0040,A043)	SQ	ALWAYS, AUTO	
Completion Flag	(0040,A491)	CS	ALWAYS, AUTO	
Verification Flag	(0040,A493)	CS	ALWAYS, AUTO	
MIME Type of Encapsulated Document	(0042,0012)	LO	ALWAYS, AUTO	
Encapsulated Document	(0042,0011)	OB	ALWAYS, AUTO	

Table 88: Private Draft Report SOP Common Module Attributes

Name	Tag	VR	Definition	Comment
SOP Class UID	(0008,0016)	UI	ALWAYS, AUTO	
SOP Instance UID	(0008,0018)	UI	ALWAYS, AUTO	
Instance Number	(0020,0013)	IS	ALWAYS, AUTO	

Table 89: Private Draft Report Private Attributes

Name	Tag	VR	Definition	Comment
Private Attribute	(2001,0010)	LO	ALWAYS, AUTO	
Private Attribute	(2001,1063)	CS	ALWAYS, AUTO	
Private Attribute	(2007,001F)	LO	ALWAYS, AUTO	
Private Attribute	(2007,1F11)	OB	ALWAYS, AUTO	
Private Attribute	(2007,1F12)	SQ	ALWAYS, AUTO	

8.1.2 Usage of Attributes from Received IOD

Q-Station only accepts all valid DICOM IOD's specified in this document.
Some SOP Classes will not be viewable because they are application dependant.

8.1.3 Attribute Mapping

8.1.3.1 Mapping Rules for Exporting Q-Station Images According to DICOM Presentation State and DICOM Composite Images

For DICOM image export, the Presentation State information is applied to the image(s) and its attributes are sent out as DICOM composite.

8.1.4 Coerced/Modified fields

Upon export of composite instances a de-normalization can take place by assembling data from the various entities in the hierarchy. The selection of the attributes takes place based upon what is present in Q-Station at the initiation of the export. A description is given in the following subsections per instance level.

8.1.4.1 Patient

If the patient ID attribute is absent during instance import (has no value – zero-length) the following mapping will take place.

1. When a Patient ID is absent and one of Patient's Name/Patient's Birth Date are absent then a new UID is generated for Patient ID.
Otherwise Patient ID is generated by appending "EMPTYPatientID_" + <Patient's Name> + "_" + <Patient's Birth Date>.
It will be ensured that all instances belonging to a particular study will get the same Patient ID.
2. For Storage SCP, when two or more SOP Instances have the same Patient ID and different values for Patient's Name/Patient's Birth Date, then a new Patient ID is created by appending "!" + <UID> to the Patient ID. The original Patient ID is added to the Other Patient IDs.

8.1.4.2 Study

During import, the value of Study ID attribute is determined as follows:

1. Retrieved from the composite image.
2. If not present in the composite image, Study ID is assigned the value of the first Requested Procedure ID (0040,1001) encountered in the Request Attributes Sequence (0040,0275) in the composite image.
3. Otherwise Study ID remains empty.

During Export, in the absence of Study attribute values, the Examination attributes will be taken as a best guess for the following Study attributes.

Table 90: Mapping of Study Attributes

Examination Attribute	Value	DICOM Attribute
Study Date (0008,0020)	Has value	Study date (0008,0020) is sent out
	Not present or has no value	Study date (0008,0020) is filled with Performed Procedure Step Start Date (0040,0244)
Study Time (0008,0030)	Has value	Study Time (0008,0030) is sent out
	Not present or has no value	Study Time (0008,0030) is filled with Performed Procedure Step Start Time (0040,0245)

This implies that upon export of each Examination, within the same Study, different values for these attributes may be sent out. The receiving station, e.g. a PACS system, will apply its own rules for guaranteeing consistency of its own database.

8.1.4.3 Examination

If all of the Performed Procedure Step attributes in Table 91 are missing from the composite image, then the mapping is as specified.

Table 91: Mapping of Examination attributes

Performed Procedure Step Attribute	Tag	Composite image Attribute	Tag
Performed Procedure Step Start Date	0040,0244	Study Date	0008,0020
Performed Procedure Step Start Time	0040,0245	Study Time	0008,0030
Performed Procedure Step ID	0040,0253	Study ID	0020,0010
Performed Procedure Step Description	0040,0254	Study Description	0008,1030

8.2 Data Dictionary of Private Attributes

See section 8.1.1.

8.3 Coded Terminology and Templates

Q-Station does not implement any specific support for coded terminology and templates.

8.4 Grayscale Image consistency

Q-Station does not implement any specific support for grayscale image consistency.

8.5 Standard Extended/Specialized/Private SOPs

8.5.1 Specialized SOP Classes

Q-Station supports only one Private SOP Class, 1.3.46.670589.2.8.1.1, used only for storing of Draft Reports to DICOM Media. It is not used for network storage as only Approved reports may be exported via DICOM, and those are only in Encapsulated PDF.

8.6 Private Transfer Syntaxes

Q-Station does not support any private transfer syntaxes.

9 ANNEXES OF APPLICATION "QLAB"

9.1 IOD Contents

9.1.1 Created SOP Instance

This section specifies each IOD created by Q-LAB, including the attribute name, tag, VR, and value (range, condition and source).

Defined abbreviations are:

ALWAYS	the module shall always be present
EMPTY	the (mandatory) module shall not contain any attributes
CONDITIONAL	the module may be present under specified condition
NEVER	the module shall never be present
ALWAYS	the attribute shall always be present with value
ANAP	the attribute shall be present with value under specified condition
EMPTY	the attribute shall always be present without value
ANAPEV	the attribute shall be present without value under specified condition
VNAP	the attribute shall always be present, either with or without value
ANAPCV	the attribute shall be present, either with or without value, under specified condition
AUTO	the attribute value is generated automatically
CONFIG	the attribute value source is a configurable parameter
COPY	the attribute value source is another SOP instance
FIXED	the attribute value is hard-coded in the application
IMPLICIT	the attribute value source is a user-implicit setting
USER	the attribute value source is explicit user input

9.1.1.1 List of Created SOP Classes

Table 93: List of Created SOP Classes

SOP Class Name	SOP Class UID
Ultrasound Multi-frame Image Storage SOP Class	1.2.840.10008.5.1.4.1.1.3.1
Secondary Capture Image Storage SOP Class	1.2.840.10008.5.1.4.1.1.7
Comprehensive SR SOP Class	1.2.840.10008.5.1.4.1.1.88.33

9.1.1.2 Ultrasound Multi-frame Image Storage IOD

Note: The existence of certain attributes in exported images depends on the source system of the image.

Table 94: MF Patient Module Attributes

Name	Tag	VR	Definition	Comment
Patient's Name	(0010,0010)	PN	ALWAYS, COPY	From source image
Patient ID	(0010,0020)	LO	ALWAYS, COPY	From source image
Patient's Birth Date	(0010,0030)	DA	ALWAYS, COPY	From source image
Patient's Sex	(0010,0040)	CS	VNAP, COPY	From source image
Patient's Size	(0010,1030)	DS	VNAP, COPY	From source image

Patient's Weight	(0010,1040)	DS	VNAP, COPY	From source image
Patient Comments	(0010,4000)	LT	VNAP, COPY	From source image

Table 95: MF General Study Module Attributes

Name	Tag	VR	Definition	Comment
Study Instance UID	(0020,000D)	UI	ALWAYS, COPY	From source image
Study Date	(0008,0020)	DA	ALWAYS, COPY	From source image
Study Time	(0008,0030)	TM	ALWAYS, COPY	From source image
Referring Physician's Name	(0008,0090)	PN	VNAP, COPY	From source image
Study ID	(0020,0010)	SH	ALWAYS, COPY	From source image
Accession Number	(0008,0050)	SH	VNAP, COPY	From source image
Study Description	(0008,1030)	LO	VNAP, COPY	From source image

Table 96: MF General Series Module Attributes

Name	Tag	VR	Definition	Comment
Modality	(0008,0060)	CS	ALWAYS, COPY	From source image
Series Instance UID	(0020,000E)	UI	ALWAYS, COPY	From source image
Series Number	(0020,0011)	IS	ALWAYS, COPY	From source image
Series Date	(0008,0021)	DA	ALWAYS, COPY	From source image
Series Time	(0008,0031)	TM	ALWAYS, COPY	From source image
Protocol Name	(0018,1030)	LO	VNAP, COPY	From source image
Operator's Name	(0008,1070)	PN	VNAP, COPY	From source image
Series Description	(0008, 103E)	LO	VNAP, COPY	From source image
Referenced Performed Procedure Step Sequence	(0008,1111)	SQ	ALWAYS, COPY	From source image
> Referenced SOP Class UID	(0008,1150)	UI	ALWAYS, COPY	From source image
> Referenced SOP Instance UID	(0008,1155)	UI	ALWAYS, COPY	From source image
Performed Procedure Step ID	(0040,0253)	SH	ALWAYS, COPY	From Study ID
Performed Procedure Step Start Date	(0040,0244)	DA	ALWAYS, COPY	From Study Date
Performed Procedure Step Start Time	(0040,0245)	TM	ALWAYS, COPY	From Study Time
Performed Procedure Step Description	(0040,0254)	LO	ALWAYS, COPY	From Study Description
Comments on the Performed Procedure Steps	(0040,0280)	ST	VNAP, COPY	From source image

Table 97: MF General Image Module Attributes

Name	Tag	VR	Definition	Comment
Instance Number	(0020,0013)	IS	ALWAYS, COPY	From source image
Patient Orientation	(0020,0020)	CS	ANAP, EMPTY	Empty if present
Image Type	(0008,0008)	CS	ALWAYS, COPY	From source image
Image Comments	(0020,4000)	LT	VNAP, COPY	From source image
Content Date	(0008,0023)	DA	ALWAYS, COPY	From source image
Content Time	(0008,0033)	TM	ALWAYS, COPY	From source image
Lossy Image Compression	(0028,2110)	CS	ANAP, COPY	From source image
Lossy Image Compression Ratio	(0028,2112)	DS	ANAP, COPY	From source image
Lossy Image Compression Method	(0028,2114)	CS	ANAP, COPY	From source image
Presentation Intent Type	(0008,0068)	CS	ALWAYS, AUTO	From source image

Table 98: MF Image Pixel Module Attributes

Name	Tag	VR	Definition	Comment
Samples per Pixel	(0028,0002)	US	ALWAYS, AUTO	Subject to Association Negotiation
Photometric Interpretation	(0028,0004)	CS	ALWAYS, AUTO	Subject to Association Negotiation
Row	(0028,0010)	US	ALWAYS, COPY	From source image
Columns	(0028,0011)	US	ALWAYS, COPY	From source image
Bits Allocated	(0028,0100)	US	ALWAYS, COPY	From source image
Bits Stored	(0028,0101)	US	ALWAYS, COPY	From source image
High Bit	(0028,0102)	US	ALWAYS, COPY	From source image
Pixel Representation	(0028,0103)	US	ALWAYS, COPY	From source image
Pixel Data	(7FE0,0010)	OB / OW	ALWAYS, COPY	From source image
Planar Configuration	(0028,0006)	US	ANAP, COPY	From source image

Table 99: MF CINE Module Attributes

Name	Tag	VR	Definition	Comment
Frame Time	(0018,1063)	DS	ANAPCV, COPY	Mutually exclusive with Frame Time Vector
Frame Time Vector	(0018,1065)	DS	ANAPCV, COPY	Mutually exclusive with Frame Time
Recommended Display Frame Rate	(0008,2144)	IS	ANAP, COPY	From source image
Cine Rate	(0018,0040)	IS	ANAP, COPY	From source image
Series Duration	(0018,0072)	DS	ANAP, COPY	From source image

Table 100: MF MODULE Attributes

Name	Tag	VR	Definition	Comment
Number of Frames	(0028,0008)	IS	ALWAYS, COPY	From source image
Frame Increment Pointer	(0028,0009)	AT	ALWAYS, COPY	From source image

Table 101: MF SOP Common Module Attributes

Name	Tag	VR	Definition	Comment
SOP Class UID	(0008,0016)	UI	ALWAYS, COPY	From source image
SOP Instance UID	(0008,0018)	UI	ALWAYS, COPY	From source image
Instance Creation Date	(0008,0012)	DA	ALWAYS, COPY	From source image
Instance Creation Time	(0008,0013)	TM	ALWAYS, COPY	From source image
Instance Number	(0020,0013)	IS	ALWAYS, COPY	From source image

9.1.1.3 Secondary Capture IOD**Table 102: SC Image Patient Module Attributes**

Name	Tag	VR	Definition	Comment
Patient's Name	(0010,0010)	PN	ALWAYS, AUTO	
Patient ID	(0010,0020)	LO	ALWAYS, AUTO	
Patient's Birth Date	(0010,0030)	DA	VNAP	Attribute must be present in original study
Patient's Sex	(0010,0040)	CS	VNAP	Attribute must be present in original study
Patient's Size	(0010,1030)	DS	ANAP	Attribute must be present in original study
Patient's Weight	(0010,1040)	DS	ANAP	Attribute must be present in original study
Patient Comments	(0010,4000)	LT	VNAP	

Table 103: SC Image General Study Module Attributes

Name	Tag	VR	Definition	Comment
Study Instance UID	(0020,000D)	UI	ALWAYS, AUTO	
Study Date	(0008,0020)	DA	ALWAYS, AUTO	
Study Time	(0008,0030)	TM	ALWAYS, AUTO	
Referring Physician's Name	(0008,0090)	PN	VNAP	Attribute must be present in original study
Study ID	(0020,0010)	SH	ALWAYS, AUTO	
Accession Number	(0008,0050)	SH	VNAP	Attribute must be present in original study
Study Description	(0008,1030)	LO	VNAP	Attribute must be present in original study

Table 104: SC Image General Series Module Attributes

Name	Tag	VR	Definition	Comment
Modality	(0008,0060)	CS	ALWAYS, AUTO	
Series Instance UID	(0020,000E)	UI	ALWAYS, AUTO	
Series Number	(0020,0011)	IS	ALWAYS, AUTO	
Series Date	(0008,0021)	DA	ALWAYS, AUTO	
Series Time	(0008,0031)	TM	ALWAYS, AUTO	
Protocol Name	(0018,1030)	LO	ANAP	Attribute must be present in original study
Operator's Name	(0008,1070)	PN	VNAP	Attribute must be present in original study
Series Description	(0008, 103E)	LO	ALWAYS, AUTO	
Referenced Performed Procedure Step Sequence	(0008,1111)	SQ	ALWAYS, AUTO	
> Referenced SOP Class UID	(0008,1150)	UI	ANAP	Only if SQ has one or more items
> Referenced SOP Instance UID	(0008,1155)	UI	ANAP	Only if SQ has one or more items
Performed Procedure Step ID	(0040,0253)	SH	ANAP	
Performed Procedure Step Start Date	(0040,0244)	DA	ANAP	
Performed Procedure Step Start Time	(0040,0245)	TM	ANAP	
Performed Procedure Step Description	(0040,0254)	LO	ANAP	
Comments on the Performed Procedure Steps	(0040,0280)	ST	ANAP	

Table 105: SC Equipment Module Attributes

Name	Tag	VR	Definition	Comment
Conversion Type	(0008,0064)	CS	ALWAYS, AUTO	
Modality	(0008,0050)	CS	ANAP	

Table 106: SC General Image Module Attributes

Name	Tag	VR	Definition	Comment
Instance Number	(0020,0013)	IS	ALWAYS, AUTO	
Patient Orientation	(0020,0020)	CS	ALWAYS, EMPTY	
Image Type	(0008,0008)	CS	ALWAYS, AUTO	
Image Comments	(0020,4000)	LT	ALWAYS, AUTO	
Lossy Image Compression	(0028,2110)	CS	ALWAYS, AUTO	
Lossy Image Compression Ratio	(0028,2112)	DS	ANAP	
Lossy Image Compression Method	(0028,2114)	CS	ANAP	
Presentation Intent Type	(0008,0068)	CS	ALWAYS, AUTO	

Table 107: SC Image Pixel Module Attributes

Name	Tag	VR	Definition	Comment
Samples per Pixel	(0028,0002)	US	ALWAYS, AUTO	
Photometric Interpretation	(0028,0004)	CS	ALWAYS, AUTO	
Row	(0028,0010)	US	ALWAYS, AUTO	
Columns	(0028,0011)	US	ALWAYS, AUTO	
Bits Allocated	(0028,0100)	US	ALWAYS, AUTO	
Bits Stored	(0028,0101)	US	ALWAYS, AUTO	
High Bit	(0028,0102)	US	ALWAYS, AUTO	
Pixel Representation	(0028,0103)	US	ALWAYS, AUTO	
Pixel Data	(7FE0,0010)	OB / OW	ALWAYS, AUTO	
Planar Configuration	(0028,0006)	US	ALWAYS, AUTO	

Table 108: SC Image Module Attributes

Name	Tag	VR	Definition	Comment
Date of Secondary Capture	(0018,1012)	DA	ALWAYS, AUTO	
Time of Secondary Capture	(0018,1014)	TM	ALWAYS, AUTO	

Table 109: SC SOP Common Module Attributes

Name	Tag	VR	Definition	Comment
SOP Class UID	(0008,0016)	UI	ALWAYS, AUTO	
SOP Instance UID	(0008,0018)	UI	ALWAYS, AUTO	
Instance Creation Date	(0008,0012)	DA	ALWAYS, AUTO	
Instance Creation Time	(0008,0013)	TM	ALWAYS, AUTO	
Instance Number	(0020,0013)	IS	ALWAYS, AUTO	

Table 110: SC Private Attributes

Name	Tag	VR	Definition	Comment
Private Attribute	(2001,0010)	LO	ANAP	
Private Attribute	(2001,1063)	CS	ANAP	

9.1.1.4 Comprehensive SR IOD

Implemented using Template ID 5200 for Adult Echo with private tags.

Appendix A – Structured Reporting

A.1 Wall Motion Analysis (TID 5204)

This template is invoked as many times as the number of the Wall Motion stages done for the stress study. Use of the template TID 5204 in the context of Q-Station 1.0 is described in the following table.

No	NL	REL WITH PARENT	VT	Concept Name	Comments
1			CONTAINER	EV (121070, DCM, "Findings")	
2	>	HAS CONCEPT MOD	CODE	EV (121058, DCM, "Procedure reported")	DT (P5-B3121, SRT, "Echocardiography for Determining Ventricular Contraction")
6	>	CONTAINS	NUM	DT (125202, DCM, "LV Wall Motion Score Index")	Q-Station 1.0 computes the Wall Motion Score index from the assessment done on the Wall segments for that particular stage.
7	>>	HAS CONCEPT MOD	CODE	EV (G-E048, SRT, "Assessment Scale")	Q-Station 1.0 uses the 5 Point Segment Finding Scale for Wall motion score index. Concept from BCID 12238 is used here.
8	>	CONTAINS	CONTAINER	EV (121070, DCM, "Findings")	
9	>>	HAS CONCEPT MOD	CODE	EV (G-C0E3, SRT, "Finding Site")	DT (T-D0772, SRT, "Myocardial Wall")
10	>>	CONTAINS	CODE	EV (LN, 18179-2, "Wall Segment")	Q-Station 1.0 performs Wall motion analysis based on 17-segment assessment. Concepts for the segments are taken from the BCID 3717.
11	>>>	HAS PROPERTIES	CODE	EV (F-32050, SRT, "Cardiac Wall Motion")	Concepts from DCID 3703 are used here. This row will be present only if row 12 is absent.
12	>>>	HAS PROPERTIES	CODE	EV (G-C504, SRT, "Associated Morphology")	Concepts from DCID 3704 are used here. This row will be present only if row 11 is absent.
13	>>>	HAS PROPERTIES	NUM	DT (G-C1E3, SRT, "Score")	

* * * End Of Document * * *