

DICOM Conformance Statement

Zenition 70 R5.1

For versions 5.1.7 and higher (i.e. 5.1.7, 5.1.8, etc.)



Issued by:

Philips Medical Systems Nederland BV, a Philips Healthcare company,

P.O. Box 10.000
5680 DA Best
The Netherlands

Internet: <https://www.philips.com/healthcare/about/customer-support>

Doc Id: *ICAP-PF.0029880*

Date: 21-Aug-2020

1. DICOM Conformance Statement Overview

Zenition 70 is a surgery mobile C-arm X-ray image generation system and provides the following DICOM data exchange features:

- Query a Radiology information system for a modality worklist.
- Send Modality Performed Procedure Step Status to Radiology information system (Advanced DICOM package).
- Print images from the local database on a DICOM printer (Standard DICOM package).
- Write DICOM media (Store to media package (DICOM CD/DVD and USB)
- Creates and Export images/ Radiation Dose Structure Reports (RDSRs) from the local database to a remote database (Standard DICOM package).
- Request storage commitment (Advanced DICOM package).
- Query and retrieve images from a remote database (Image Viewer Application)
- Read DICOM media (Image Viewer Application).
- The system is verified as DIN 6862-2 compliant.

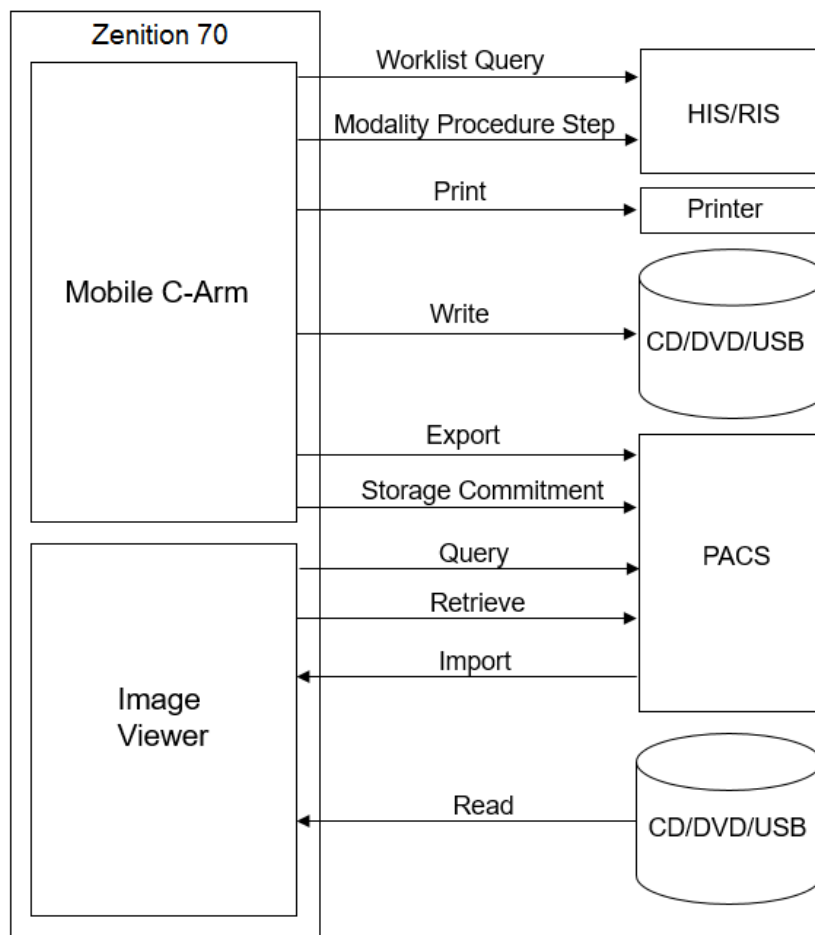

Figure 1: System Overview of Mobile C-Arm with integrated Image Viewer

The following table provides an overview of all network services as provided by Zenition 70.

Table 1: Network Services

SOP Class		User of Service (SCU)	Provider of Service (SCP)	Display
Name	UID			
Other				
Verification SOP Class	1.2.840.10008.1.1	Yes	Yes	NA
Print Management				
Basic Grayscale Print Management Meta SOP Class	1.2.840.10008.5.1.1.9	Yes	No	NA
>Basic Film Session SOP Class	1.2.840.10008.5.1.1.1	Yes	No	NA
>Printer SOP Class	1.2.840.10008.5.1.1.16	Yes	No	NA
>Basic Film Box SOP Class	1.2.840.10008.5.1.1.2	Yes	No	NA
>Basic Grayscale Image Box SOP Class	1.2.840.10008.5.1.1.4	Yes	No	NA
Query/Retrieve				
Study Root QR Information Model - FIND SOP Class	1.2.840.10008.5.1.4.1.2.2.1	Yes	No	NA
Study Root QR Information Model - MOVE SOP Class	1.2.840.10008.5.1.4.1.2.2.2	Yes	No	NA
Transfer				
X-Ray Angiographic Image Storage SOP Class	1.2.840.10008.5.1.4.1.1.12.1	Yes	Yes	Yes
Secondary Capture Image Storage SOP Class	1.2.840.10008.5.1.4.1.1.7	Yes	Yes	Yes
X-Ray Radiation Dose SR	1.2.840.10008.5.1.4.1.1.88.67	Yes	No	No
Computed Radiography Image Storage SOP Class	1.2.840.10008.5.1.4.1.1.1	No	Yes	Yes
Digital X-Ray Image Storage - For Pres. SOP	1.2.840.10008.5.1.4.1.1.1.1	No	Yes	Yes
Digital Mammography X-Ray Image Storage - Pres. SOP	1.2.840.10008.5.1.4.1.1.1.2	No	Yes	Yes
Digital Mammography X-Ray Image Storage - Proc. SOP	1.2.840.10008.5.1.4.1.1.1.2.1	No	Yes	Yes
Grayscale Softcopy Presentation State Storage SOP Class	1.2.840.10008.5.1.4.1.1.11.1	No	Yes	Yes
X-Ray Radiofluoroscopic Image Storage SOP Class	1.2.840.10008.5.1.4.1.1.12.2	No	Yes	Yes
MR Image Storage SOP Class	1.2.840.10008.5.1.4.1.1.4	No	Yes	Yes
Ultrasound Image Storage SOP Class	1.2.840.10008.5.1.4.1.1.6.1	No	Yes	Yes
CT Image Storage SOP Class	1.2.840.10008.5.1.4.1.1.2	No	Yes	Yes
Basic Text SR Storage SOP Class	1.2.840.10008.5.1.4.1.1.88.11	No	Yes	No
Enhanced SR Storage SOP Class	1.2.840.10008.5.1.4.1.1.88.22	No	Yes	No
Comprehensive SR Storage SOP Class	1.2.840.10008.5.1.4.1.1.88.33	No	Yes	No
Key Object Selection Document Storage SOP Class	1.2.840.10008.5.1.4.1.1.88.59	No	Yes	No
PET Image Storage SOP Class	1.2.840.10008.5.1.4.1.1.128	No	Yes	Yes
NM Image Storage SOP Class	1.2.840.10008.5.1.4.1.1.20	No	Yes	Yes
12-lead ECG Waveform Storage SOP Class	1.2.840.10008.5.1.4.1.1.9.1.1	No	Yes	No
General ECG Waveform Storage SOP Class	1.2.840.10008.5.1.4.1.1.9.1.2	No	Yes	Yes
Ambulatory ECG Waveform Storage SOP Class	1.2.840.10008.5.1.4.1.1.9.1.3	No	Yes	No
Hemodynamic Waveform Storage SOP Class	1.2.840.10008.5.1.4.1.1.9.2.1	No	Yes	No
Enhanced MR Image Storage SOP Class	1.2.840.10008.5.1.4.1.1.4.1	No	Yes	Yes
RAW Data Image Storage SOP Class	1.2.840.10008.5.1.4.1.1.66	No	Yes	Yes
Branchy Treatment Record Storage SOP Class	1.2.840.10008.5.1.4.1.1.481.6	No	Yes	No
RT Treatment Summary Record Storage SOP Class	1.2.840.10008.5.1.4.1.1.481.7	No	Yes	No
MR Spectroscopy Storage SOP Class	1.2.840.10008.5.1.4.1.1.4.2	No	Yes	No
Multi-frame Single Bit Secondary Capture Image Storage	1.2.840.10008.5.1.4.1.1.7.1	No	Yes	Yes
Multi-frame Grayscale Word Secondary Capture Image Storage SOP Class	1.2.840.10008.5.1.4.1.1.7.3	No	Yes	Yes
Multi-frame True Color Secondary Capture Image Storage SOP Class	1.2.840.10008.5.1.4.1.1.7.4	No	Yes	Yes

SOP Class		User of Service (SCU)	Provider of Service (SCP)	Display
Name	UID			
RT Image Storage SOP Class Storage SOP Class	1.2.840.10008.5.1.4.1.1.481.1	No	Yes	Yes
RT Dose Storage SOP Class Storage SOP Class	1.2.840.10008.5.1.4.1.1.481.2	No	Yes	No
RT Structure Set Storage SOP Class	1.2.840.10008.5.1.4.1.1.481.3	No	Yes	No
RT Beams Treatment	1.2.840.10008.5.1.4.1.1.481.4	No	Yes	No
RT Plan Storage Transfer	1.2.840.10008.5.1.4.1.1.481.5	No	Yes	No
Workflow Management				
Modality Worklist Information Model - FIND SOP Class	1.2.840.10008.5.1.4.31	Yes	No	NA
Modality Performed Procedure Step SOP Class	1.2.840.10008.3.1.2.3.3	Yes	No	NA
Storage Commitment Push Model SOP Class	1.2.840.10008.1.20.1	Yes	No	NA

The following table provides an overview of all media services as provided by the ZENITION 70 .

Note: After data is written to CD/DVD, the CD/DVD is finalized; the finalized CD/DVD can be read on almost every CD/DVD reader. Currently Zenition 70 supports the FSC service for CD-R(W),DVD-R,DVD-RW and DVD+R(W) media; and the FSR service accepts DVD+R(W),DVD-R(W) DVD-R/-RW, DVD-R,DVD-RW and CD-R(W).

Table 2: Media Services

Media Storage Application Profile	File-set Creator (FSC)	File-set Updater (FSU)	File-set Reader (FSR)
Compact Disk-Recordable			
General Purpose CD-R Interchange	Yes	No	Yes
DVD			
General Purpose DVD Interchange with JPEG	Yes	No	Yes
USB			
General Purpose USB Media Interchange with JPEG	Yes	No	Yes

2. Table of Contents

1.	DICOM CONFORMANCE STATEMENT OVERVIEW	3
2.	TABLE OF CONTENTS	6
3.	INTRODUCTION	9
3.1.	REVISION HISTORY	9
3.2.	AUDIENCE.....	9
3.3.	REMARKS	9
3.4.	DEFINITIONS, TERMS AND ABBREVIATIONS	10
3.5.	REFERENCES.....	11
4.	NETWORKING	12
4.1.	IMPLEMENTATION MODEL	12
4.1.1.	Application Data Flow.....	12
4.1.2.	Functional Definition of AE's	13
4.1.2.1.	Functional Definition of Mobile C-Arm AE.....	14
4.1.2.2.	Functional Definition of Image Viewer AE.....	14
4.1.3.	Sequencing of Real World Activities	14
4.2.	AE SPECIFICATIONS	15
4.2.1.	Mobile C-Arm AE.	15
4.2.1.1.	SOP Classes	15
4.2.1.2.	Association Policies.....	16
4.2.1.2.1.	General.....	16
4.2.1.2.2.	Number of Associations.....	16
4.2.1.2.3.	Asynchronous Nature	16
4.2.1.2.4.	Implementation Identifying Information	16
4.2.1.2.5.	Communication Failure Handling.....	17
4.2.1.3.	Association Initiation Policy	17
4.2.1.3.1.	(Real-World) Activity – Verification as SCU.....	17
4.2.1.3.2.	(Real-World) Activity – Modality worklist As SCU	18
4.2.1.3.3.	(Real-World) Activity – Modality Performed Procedure Step As SCU.....	23
4.2.1.3.4.	(Real-World) Activity – Image Export.....	28
4.2.1.3.5.	(Real-World) Activity – Storage Commitment Push Model AS SCU	30
4.2.1.3.6.	(Real-World) Activity - Print Management as SCU	33
4.2.1.4.	Association Acceptance Policy	38
4.2.2.	Image Viewer AE.	38
4.2.2.1.	SOP Classes	39
4.2.2.2.	Association Policies.....	40
4.2.2.2.1.	General.....	40
4.2.2.2.2.	Number of Associations.....	40
4.2.2.2.3.	Asynchronous Nature	40
4.2.2.2.4.	Implementation Identifying Information	40
4.2.2.2.5.	Communication Failure Handling.....	41
4.2.2.3.	Association Initiation Policy	41
4.2.2.3.1.	(Real-World) Activity – FIND as SCU	42
4.2.2.3.2.	(Real-World) Activity – MOVE as SCU	44
4.2.2.4.	Association Acceptance Policy	45
4.2.2.4.1.	(Real-World) Activity – Verification as SCP	46
4.2.2.4.2.	(Real-World) Activity – Image Import.....	48
4.3.	NETWORK INTERFACES.....	52
4.3.1.	Physical Network Interfaces	52
4.3.2.	Additional Protocols	52
4.4.	CONFIGURATION.....	52
4.4.1.	AE Title/Presentation Address Mapping.....	53

4.4.1.1.	Local AE Titles.....	53
4.4.1.2.	Remote AE Title/Presentation Address Mapping.....	53
4.4.2.	Parameters.....	53
5.	MEDIA INTERCHANGE	57
5.1.	IMPLEMENTATION MODEL	57
5.1.1.	Application Data Flow Diagram	57
5.1.2.	Functional Definitions of AE's.....	58
5.1.3.	Sequencing of Real World Activities	58
5.2.	AE SPECIFICATIONS	59
5.2.1.	Mobile Surgery System Media - Specification	59
5.2.1.1.	File Meta Information for the Image Viewer AE	60
5.2.1.2.	File Meta Information for the Mobile C-Arm AE	60
5.2.1.3.	Real-World Activities.....	60
5.2.1.3.1.	RWA - Read File-set.....	60
5.2.1.3.2.	RWA - Create File-set.....	61
5.3.	AUGMENTED AND PRIVATE APPLICATION PROFILES.....	62
5.3.1.	Augmented Application Profiles	62
5.3.1.1.	Augmented Application Profile AUG-GEN-DVD-JPEG SOP Class Augmentations	62
5.3.1.2.	Directory Augmentations	62
5.3.1.3.	Other Augmentations.....	62
5.3.2.	Private Application Profiles.....	62
5.4.	MEDIA CONFIGURATION	62
6.	SUPPORT OF CHARACTER SETS.....	63
7.	SECURITY	64
7.1.	SECURITY PROFILES	64
7.1.1.	Security use Profiles	64
7.1.2.	Security Transport Connection Profiles	64
7.1.3.	Digital Signature Profiles	64
7.1.4.	Media Storage Security Profiles	64
7.1.5.	Attribute Confidentiality Profiles	64
7.1.6.	Network Address Management Profiles	66
7.1.7.	Time Synchronization Profiles	66
7.1.8.	Application Configuration Management Profiles.....	66
7.1.9.	Audit Trail Profiles	66
7.2.	ASSOCIATION LEVEL SECURITY.....	66
7.3.	APPLICATION LEVEL SECURITY	67
8.	ANNEXES OF APPLICATION "MOBILE C-ARM AE"	68
8.1.	IOD CONTENTS	68
8.1.1.	Created SOP Instance	68
8.1.1.1.	List of created SOP Classes	68
8.1.1.2.	Secondary Capture Image Storage SOP Class	68
8.1.1.3.	X-Ray Angiographic Image Storage SOP Class	72
8.1.1.4.	X-Ray Radiation Dose SR	76
8.1.1.5.	Radiation Dose Structured Report.....	79
8.1.1.5.1.	TID 10001 Projection X-Ray Radiation Dose.....	79
8.1.1.5.2.	TID 10002 Accumulated X-Ray Dose	79
8.1.1.5.3.	TID 10003 Irradiation Event X-Ray Data	81
8.1.1.5.4.	TID 10004 Accumulated Projection X-Ray Dose	82
8.1.1.5.5.	TID 1002 Observer Context.....	82
8.1.1.5.6.	TID 1004 Device Observer Identifying Attributes	82
8.1.1.5.7.	TID 1020 Person Participant.....	83
8.1.1.5.8.	TID 1021 Device Participant.....	83
8.1.2.	Usage of Attributes from Received IOD	83

- 8.1.3. Attribute Mapping 83
- 8.1.4. Coerced/Modified fields 85
- 8.2. DATA DICTIONARY OF PRIVATE ATTRIBUTES 85**
- 8.3. CODED TERMINOLOGY AND TEMPLATES 86**
- 8.3.1. Context Groups 86

3. Introduction

The introduction specifies product and relevant disclaimers as well as any general information that the vendor feels is appropriate.

3.1. Revision History

The revision history provides dates and differences of the different releases.

Table 3: Revision History

Document Version	Date of Issue	Description of change
01	21-Aug-2020	Approved initial version for Zenition 70 R5.1.x, where x is 7 or higher (i.e. 5.1.7, 5.1.8, etc.)

3.2. Audience

This Conformance Statement is intended for:

- (Potential) customers
- System integrators of medical equipment
- Marketing staff interested in system functionality
- Software designers implementing DICOM interfaces

It is assumed that the reader is familiar with the DICOM standard.

3.3. Remarks

The DICOM Conformance Statement is contained in chapter 4 through 8 and follows the contents and structuring requirements of DICOM PS 3.2.

This DICOM Conformance Statement by itself does not guarantee successful interoperability of Philips equipment with non-Philips equipment. The user (or user's agent) should be aware of the following issues:

- **Interoperability**
Interoperability refers to the ability of application functions, distributed over two or more systems, to work successfully together. The integration of medical devices into an IT environment may require application functions that are not specified within the scope of DICOM. Consequently, using only the information provided by this Conformance Statement does not guarantee interoperability of Philips equipment with non-Philips equipment.
It is the user's responsibility to analyze thoroughly the application requirements and to specify a solution that integrates Philips equipment with non-Philips equipment.
- **Validation**
Philips equipment has been carefully tested to ensure that the actual implementation of the DICOM interface corresponds with this Conformance Statement.
Where Philips equipment is linked to non-Philips equipment, the first step is to compare the relevant Conformance Statements. If the Conformance Statements indicate that successful information exchange should be possible, additional validation tests will be necessary to ensure the functionality, performance, accuracy and stability of image and image related data. It is the responsibility of the user (or user's agent) to specify the appropriate test suite and to carry out the additional validation tests.
- **New versions of the DICOM Standard**
The DICOM Standard will evolve in future to meet the user's growing requirements and to incorporate new features and technologies. Philips is actively involved in this evolution and plans to adapt its equipment to future versions of the DICOM Standard. In order to do so, Philips reserves the right to make changes to its products or to discontinue its delivery. The user should ensure that any non-Philips provider linking to Philips equipment also adapts to future versions of the DICOM Standard. If not, the incorporation of DICOM enhancements into Philips equipment may lead to loss of connectivity (in case of networking) and incompatibility (in case of media).

3.4. Definitions, Terms and Abbreviations

Table 4: Definitions, Terms and Abbreviations

Abbreviations/ Terms	Explanation
AE	Application Entity
AP	Application Profile
CD	Compact Disc
CD-R	CD-Recordable
CD-M	CD-Medical
CR	Computed Radiography
CT	Computed Tomography
DICOM	Digital Imaging and Communication in Medicine
DIMSE	DICOM Message Service Element
DIMSE-C	DIMSE-Composite
DIMSE-N	DIMSE-Normalized
EBE	Explicit VR Big Endian
ELE	Explicit VR Little Endian
FSC	File-set Creator
FSR	File-set Reader
FSU	File-set Updater
GUI	Graphic User Interface
HIS	Hospital Information System
HL7	Health Level Seven
ILE	Implicit VR Little Endian
IOD	Information Object Definition
MPPS	Modality Performed Procedure Step
MR	Magnetic Resonance
NEMA	National Electrical Manufacturers Association
NM	Nuclear Medicine
PDU	Protocol Data Unit
RDSR	Radiation Dose Structure Report
RF	X-Ray Radiofluoroscopic
RIS	Radiology Information System
RT	Radiotherapy
RWA	Real-World Activity
SC	Secondary Capture
SCM	Study Component Management
SCP	Service Class Provider
SCU	Service Class User
SOP	Service Object Pair
SR	Structure Report(s)
TCP/IP	Transmission Control Protocol/ Internet Protocol
UID	Unique Identifier
US	Ultrasound
WLM	Worklist Management
XA	X-Ray Angiographic

3.5. References

[DICOM] Digital Imaging and Communications in Medicine, Parts 1 - 21 (NEMA PS 3.1- PS 3.21),
National Electrical Manufacturers Association
1300 North 17th Street
Suite 900
Arlington, Virginia 22209
Internet: <https://www.dicomstandard.org/current>

Note that at any point in time the official standard consists of the most recent yearly edition of the base standard (currently 2019) plus all the supplements and correction items that have been approved as Final Text.

4. Networking

This section contains the networking related services.

4.1. Implementation model

The implementation model consists of three sections:

- The application data flow diagram, specifying the relationship between the Application Entities and the "external world" or Real-World Activities,
- A functional description of each Application Entity, and
- The sequencing constraints among them.

4.1.1. Application Data Flow

For Zenition 70, two application entities are implemented: the Mobile C-Arm AE and the Image Viewer AE.

The Mobile C-Arm AE is responsible for all networking functionality concerning acquisitions by the Zenition 70 System. The Image Viewer is responsible for viewing Images from remote system

The operator retrieve's the Data from the RIS Server using worklist query.

The operator can select and perform an examination (may be scheduled per worklist), resulting in MPPS update being sent to the RIS. 2 MPPS Jobs are sent one in progress and another as completed. The Operator can print images on a DICOM network printer using the Basic Grayscale Print Management Meta SOP class. Then the operator can export the acquired images; the images in the examination may be exported as separate Secondary Capture images, as XA images. If applicable, the Mobile C-Arm AE automatically sends a Storage Commitment request for those images. When the examination is closed, (optionally) an RDSR is automatically generated (Export).

In service mode the service operator can verify application level communication.

The Intention of Image Viewer AE is to view images. The images can be Imported or Query/Retrieve from a remote node.

The Mobile C-Arm can work only on-line. Therefore when the network connection is lost and reconnected, the acquired images and dose reports that have to be transferred by the Mobile C-Arm AE will not be transferred and all the submitted jobs will fail.

If the Mobile C-Arm is disconnected from the network, then Query/Retrieve and Worklist Queries will fail. These requests will not be queued.

The networking application data flow is shown in the following figures.

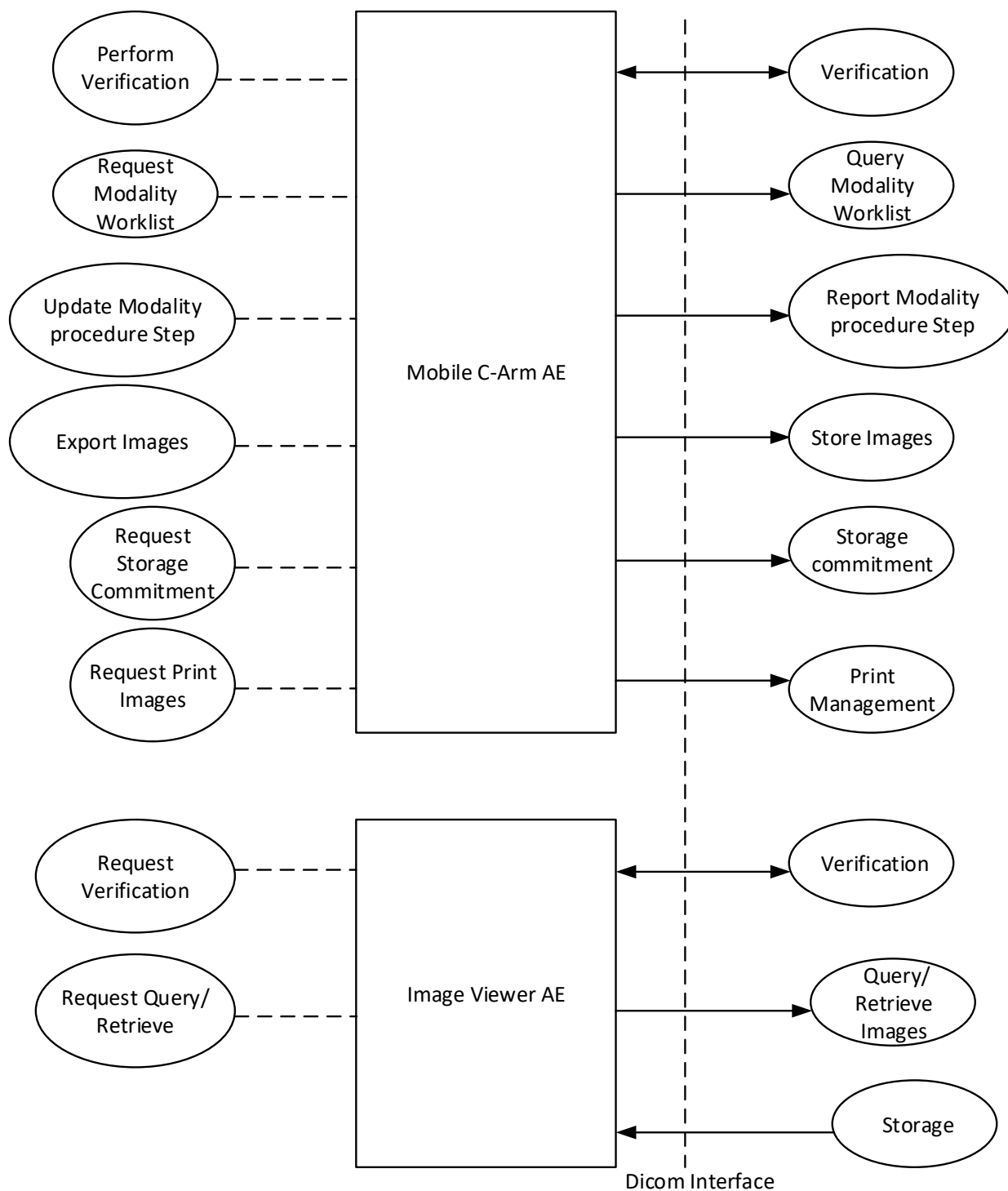

Figure 2: Application Data Flow Diagram Mobile C-Arm AE with integrated Image Viewer AE

4.1.2. Functional Definition of AE's

This section contains a functional definition for each individual local Application Entity.

© 2020 Koninklijke Philips N.V.

4.1.2.1. Functional Definition of Mobile C-Arm AE

The Mobile C-Arm AE will act as SCU for Verification (Check), for Basic Worklist Management (Get Worklist), and for Modality Performed Procedure step, instance Export, Storage Commitment, and Print Management. Initiated by the operator the Mobile C-Arm AE will propose the required presentation contexts for an association with the peer SCP. For Storage Commitment the Mobile C-Arm AE can accept associations for asynchronous event reports.

4.1.2.2. Functional Definition of Image Viewer AE

The Image Viewer AE can retrieve and view images from a foreign storage SCU (Query/Retrieve Image). The operator initiates a query request and selects examinations from the query response. The operator initiates a retrieve request for the selected images. The Image Viewer AE as storage SCP waits for an association to import the requested images (Query/Retrieve Image).

4.1.3. Sequencing of Real World Activities

The following figures describe the sequencing constraints of some typical acquisitions per scheduled procedure step.

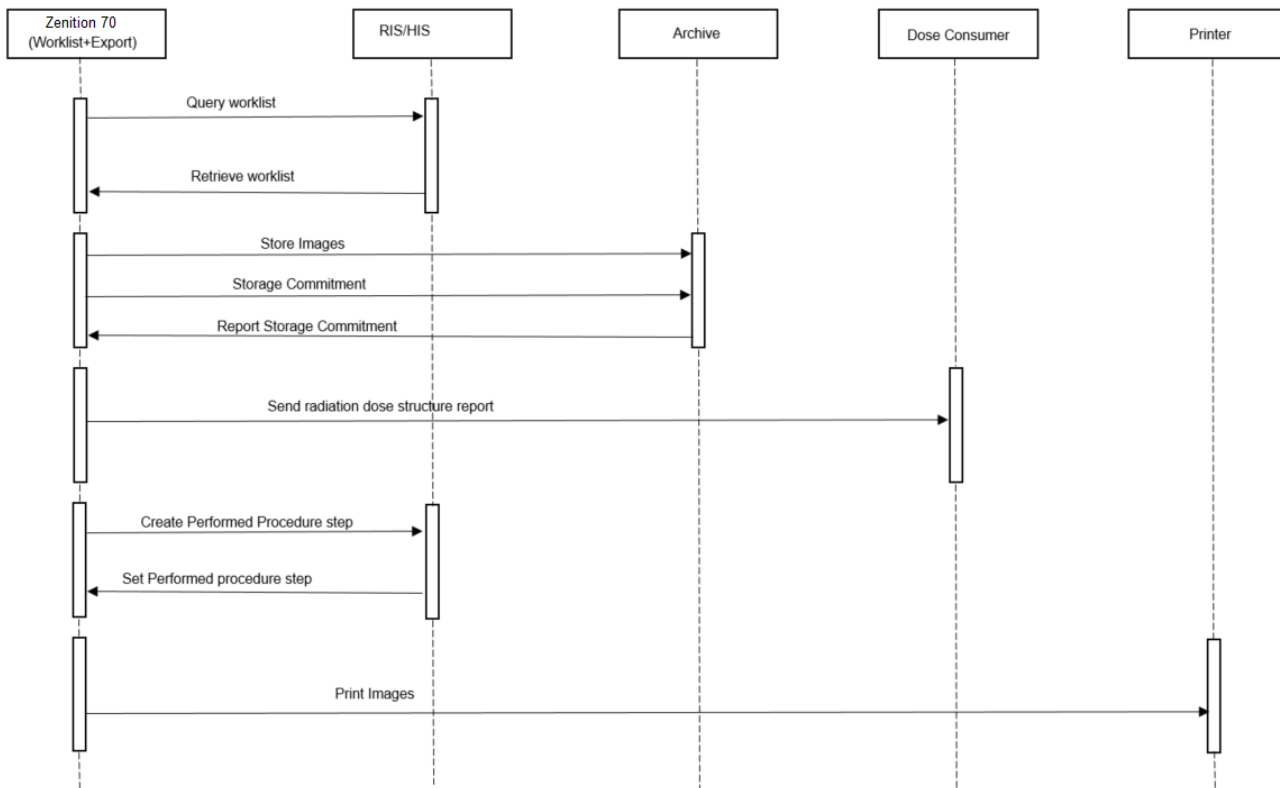

Figure 3: Typical Acquisition Archive Storage Sequencing Constraint.

Note that an acquisition may also be started manually, i.e. without using a worklist.

The following figure describes the sequencing constraints of a typical Query/Retrieve action.

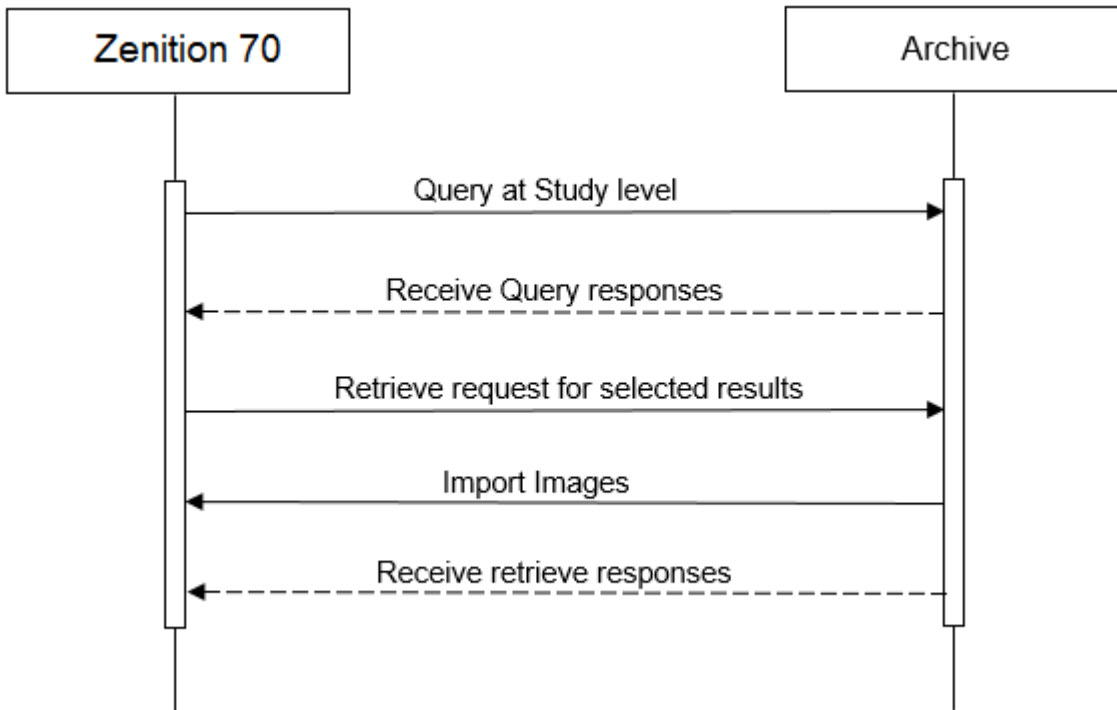

Figure 4: Typical Query/Retrieve Sequencing Constraint

4.2. AE Specifications

This section in the DICOM Conformance Statement is a set of Application Entity specifications. There are as many of these subsections as there are different AE's in the implementation.

4.2.1. Mobile C-Arm AE.

Details of this specific Application Entity is specified in this section.

4.2.1.1. SOP Classes

This Application Entity provides Standard Conformance to the following SOP Classes.

Table 5: SOP Classes for Console Network AE

SOP Class Name	SOP Class UID	SCU	SCP
Verification SOP Class	1.2.840.10008.1.1	Yes	Yes
Storage Commitment Push Model SOP Class	1.2.840.10008.1.20.1	Yes	No
Modality Performed Procedure Step SOP Class	1.2.840.10008.3.1.2.3.3	Yes	No
X-Ray Angiographic Image Storage SOP Class	1.2.840.10008.5.1.4.1.1.12.1	Yes	No
Secondary Capture Image Storage SOP Class	1.2.840.10008.5.1.4.1.1.7	Yes	No
X-Ray Radiation Dose SR	1.2.840.10008.5.1.4.1.1.88.67	Yes	No
Modality Worklist Information Model - FIND SOP Class	1.2.840.10008.5.1.4.31	Yes	No
Basic Grayscale Print Management Meta SOP Class	1.2.840.10008.5.1.1.9	Yes	No

© 2020 Koninklijke Philips N.V.

SOP Class Name	SOP Class UID	SCU	SCP
>Basic Film Session SOP Class	1.2.840.10008.5.1.1.1	Yes	No
>Printer SOP Class	1.2.840.10008.5.1.1.16	Yes	No
>Basic Film Box SOP Class	1.2.840.10008.5.1.1.2	Yes	No
>Basic Grayscale Image Box SOP Class	1.2.840.10008.5.1.1.4	Yes	No

Note: Any SOP specific behavior is documented later in the conformance statement in the applicable SOP specific conformance section.

4.2.1.2. Association Policies

Each AE specification contains a description of the general association establishment and acceptance policies of the AE.

4.2.1.2.1. General

The DICOM standard application context is specified below.

Table 6: DICOM Application Context

Description	Value
Application Context Name	1.2.840.10008.3.1.1.1

4.2.1.2.2. Number of Associations

The number of simultaneous associations that the Console Store AE as initiator supports is specified in table below.

Table 7: Number of associations as an Association Initiator for this AE

Description	Value
Maximum number of simultaneous associations	3

Table 8: Number of associations as an Association Acceptor for this AE

Description	Value
Maximum number of simultaneous associations	3

4.2.1.2.3. Asynchronous Nature

The Mobile C-Arm AE only supports asynchronous operations for Storage Commitment report. It will not perform asynchronous window negotiation.

4.2.1.2.4. Implementation Identifying Information

The value supplied for Implementation Class UID and version name are documented here.

Table 9: DICOM Implementation Class and Version for Mobile C-Arm AE.

Implementation Class UID	1.3.46.670589.7.70.5.1
Implementation Version Name	5.1.x where 'x' is the detailed application version, i.e. 5.1.7, 5.1.8 etc.

4.2.1.2.5. Communication Failure Handling

The behavior of the AE during communication failure is summarized in the table below:

Table 10: Communication Failure Behavior

Exception	Behavior
General	In the DFI the error is logged including a description of the problem. Those are the standard notifications when an association cannot be established.
Not connected	Network Shutdown is logged e.g. ARTIM Timeout

4.2.1.3. Association Initiation Policy

This describes the conditions under which the AE will initiate an association.

The behavior of the AE during DICOM communication failure is summarized in the below table.

Table 11: DICOM Command Communication Failure Behavior

Exception	Behavior
Association setup failure	The association is aborted and the command marked as failed. The reason is logged and reported in the log file.
Network timeout behavior	See section 4.4.2 for corresponding configurable time to wait parameters.

4.2.1.3.1. (Real-World) Activity – Verification as SCU

4.2.1.3.1.1. Description and Sequencing of Activities

In service mode the Mobile C-Arm AE can send a verification request (C-ECHO) to verify application level communication. This verification is initiated on a separate service system by using the "Check" function of the Zenition 70 program.

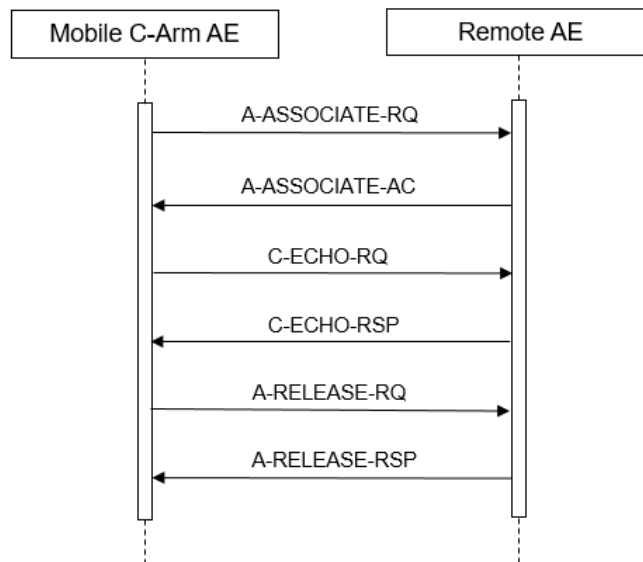

Figure 5: (Real World) Activity - Verification as SCU

The system sends a DICOM Association request message. After the Association accept is received a C-ECHO message is send.

4.2.1.3.1.2. Proposed Presentation Contexts

The presentation contexts are defined in the table below

Table 12: Proposed Presentation Contexts for (Real-World) Activity – Verification as SCU

Presentation Context Table					
Abstract Syntax		Transfer Syntax		Role	Extended Negotiation
Name	UID	Name List	UID List		
Verification SOP Class	1.2.840.10008.1.1	Explicit VR Little Endian	1.2.840.10008.1.2.1	SCU	None
		Implicit VR Little Endian	1.2.840.10008.1.2		
		Explicit VR Big Endian	1.2.840.10008.1.2.2		

4.2.1.3.1.3. SOP Specific Conformance for Verification SOP Class

This section and sub-section include the manufacturer SOP and Dataset specific information as well the status codes and their corresponding behavior.

4.2.1.3.1.3.1. Dataset Specific Conformance for Verification C-ECHO SCU

Details regarding the Dataset Specific response behavior will be reported in this section.

This part of the section includes the dataset specific behavior, i.e. error codes, error and exception handling, time-outs, etc.

Table 13: Status Response

Service Status	Error Code	Further Meaning	Behavior
Success	0000	Communication with remote system is successful	Popup message "Connection Succeeded" appears.
Failure	<xxxx>	Failed communication	Popup message "Connection Failed" appears.

4.2.1.3.2. (Real-World) Activity – Modality worklist As SCU

4.2.1.3.2.1. Description and Sequencing of Activities

The Mobile C-Arm AE can send a modality worklist query (C-FIND) to update the Mobile C-Arm worklist.

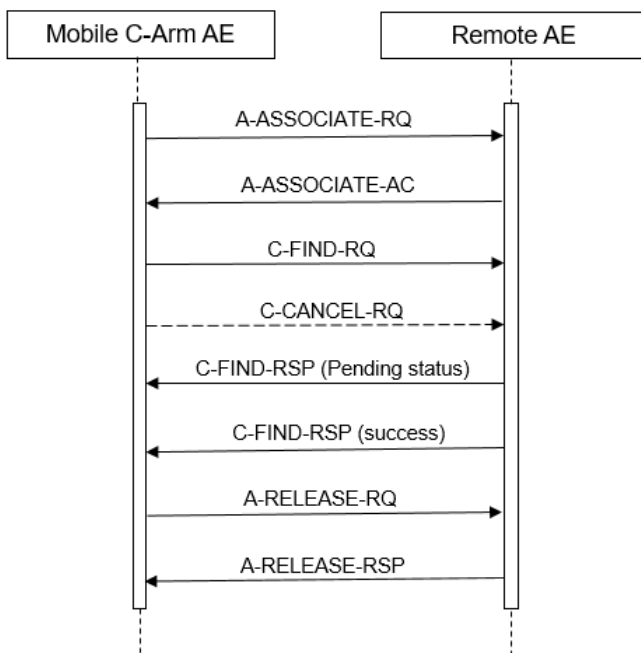

Figure 6: (Real World) Activity - Worklist request

The worklist query is initiated by selecting "Get Worklist". Then the Mobile C-Arm AE opens an association and sends a modality worklist query. The DMWL SCP (RIS/HIS) returns the applicable worklist; a response with status Pending is received for each new entry, the final response has status Success. After the final response the Mobile C-Arm AE releases the association.

Manually initiated queries can be cancelled by pressing the "Cancel" button on the user interface. In that case the DICOM association will be aborted immediately.

The contents of the received worklist are compared with the contents of the previous worklist. In case there are any changes, the Mobile C-Arm patient file is updated. A unique match of the following attributes identifies a worklist entry.

Table 14: Matching Criteria for Identifying Worklist Entries

Attribute Name	Tag
Scheduled Procedure Step ID	(0040,0009)
Accession Number	(0008,0050)
Requested Procedure ID	(0040,1001)

If none of these identification attributes is present then the received worklist entry is ignored.

4.2.1.3.2.2. Proposed Presentation Contexts

The presentation contexts are defined in the table below:

Table 15: Proposed Presentation Contexts for (Real-World) Activity – Modality worklist As SCU

Presentation Context Table					
Abstract Syntax		Transfer Syntax		Role	Extended Negotiation
Name	UID	Name List	UID List		
Modality Worklist Information Model - FIND SOP Class	1.2.840.10008.5.1.4.31	Explicit VR Little Endian	1.2.840.10008.1.2.1	SCU	None
		Implicit VR Little Endian	1.2.840.10008.1.2.		
		Explicit VR Big Endian	1.2.840.10008.1.2.2		

4.2.1.3.2.3. SOP Specific Conformance for Modality Worklist Information Model - FIND SOP Class

This section and sub-section include the manufacturer SOP and Dataset specific information as well the status codes and their corresponding behavior.

The Mobile C-Arm AE provides standard conformance to the Modality Worklist SOP class.

The Mobile C-Arm AE can contain a number of 250 worklist entries. If the sum of current and new worklist entries exceeds 250 then not all new entries added before the Mobile C-Arm AE releases the association. The Mobile C-Arm AE will show a message stating that the maximum number of examinations was reached.

Mobile C-Arm provides a broad query with the following attributes:

- Scheduled Procedure Step Start Date
- Modality Type
- Scheduled Station AE Title
- Scheduled Station Name

These query attributes are fixed. These fixed attributes can be configured.

A patient specific worklist query is possible with the following attributes:

- Scheduled Procedure Step Start Date (configured value)
- Modality Type (configured value)
- Patient Name
- Patient ID
- Accession Number
- Requested Procedure ID

The table in the next section provides the list of query attributes, displayed attributes, required attributes, etc. The table also lists the type of matching for the query attributes.

4.2.1.3.2.3.1 Dataset Specific Conformance for Modality Worklist Information Model - FIND SOP Class C-FIND-SCU

Details regarding the Dataset Specific response behavior will be reported in this section.

Attribute Name: Attributes supported to build a Modality Worklist Request Identifier.

- Tag: DICOM tag for this attribute.
- VR: DICOM VR for this attribute.
- M: Matching Keys for (automatic) Worklist Update.
- R: Return Keys. An "X" will indicate that this attribute as Return Key with zero length for Universal Matching.
- Q: Interactive Query Key. An "X" will indicate that this attribute as matching key can be used.
- D: Displayed Keys. An "X" indicates that this Worklist attribute is displayed to the user during a patient registration dialog.

IOD: An "X" indicates that this Worklist attribute is included into all object Instances created during performance of the related Procedure Step.

Type of matching: The following types of matching exists:

- Single Value Matching
- List of UID Matching
- Wild Card Matching
- Range Matching
- Sequence Matching
- Universal Matching

Table 16: Worklist Request Identifier

Attribute Name	Tag	VR	M	R	Q	D	IOD	Type of Matching	Comment
Patient Identification Module									
Other Patient IDs	0010,1000	LO		X			X	Universal	
Other Patient Names	0010,1001	PN		X		X	X	Universal	
Patient ID	0010,0020	LO		X	X	X	X	Single Value, WildCard	
Patient's Name	0010,0010	PN		X	X	X	X	WildCard	
Patient Demographic Module									
Patient's Birth Date	0010,0030	DA		X		X	X	Universal	
Patient's Birth Time	0010,0032	TM		X			X	Universal	
Patient's Sex	0010,0040	CS		X		X	X	Universal	
Patient's Weight	0010,1030	DS		X		X	X	Universal	
Patient Medical Module									
Allergies	0010,2110	LO		X		X		Universal	
Medical Alerts	0010,2000	LO		X		X		Universal	
Special Needs	0038,0050	LO		X		X		Universal	
Visit Relationship Module									
Referenced Patient Sequence	0008,1120	SQ		X			X		
>Referenced SOP Class UID	0008,1150	UI		X			X	Universal	
>Referenced SOP Instance UID	0008,1155	UI		X			X	Universal	
SOP Common Module									
Specific Character Set	0008,0005	CS		X			X	Universal	Present if expanded/replacement character set used.
Scheduled Procedure Step Module									
Scheduled Procedure Step Sequence	0040,0100	SQ		X					
>Modality	0008,0060	CS		X	X	X	X	Single Value	
>Pre-Medication	0040,0012	LO		X		X		Universal	
>Requested Contrast Agent	0032,1070	LO		X		X		Universal	
>Scheduled Performing Physician's Name	0040,0006	PN		X		X	X	Universal	
>Scheduled Procedure Step Description	0040,0007	LO		X		X	X	Universal	
>Scheduled Procedure Step ID	0040,0009	SH		X			X	Universal	
>Scheduled Procedure Step Location	0040,0011	SH		X		X		Universal	
>Scheduled Procedure Step Start Date	0040,0002	DA		X	X	X	X	Range	

Attribute Name	Tag	VR	M	R	Q	D	IOD	Type of Matching	Comment
>Scheduled Procedure Step Start Time	0040,0003	TM		X		X	X	Universal	
>Scheduled Station AE Title	0040,0001	AE		X	X		X	Single Value	
>Scheduled Station Name	0040,0010	SH		X		X	X	Single Value	
>Scheduled Protocol Code Sequence	0040,0008	SQ		X			X		
>>Code Meaning	0008,0104	LO		X			X	Universal	
>>Code Value	0008,0100	SH		X			X	Universal	
>>Coding Scheme Designator	0008,0102	SH		X			X	Universal	
>>Coding Scheme Version	0008,0103	SH		X			X	Universal	
Requested Procedure Module									
Requested Procedure Description	0032,1060	LO		X		X	X	Universal	
Requested Procedure ID	0040,1001	SH		X	X	X	X	Single Value	
Study Instance UID	0020,000D	UI		X			X	Universal	
Referenced Study Sequence	0008,1110	SQ		X			X		
>Referenced SOP Class UID	0008,1150	UI		X			X	Universal	
>Referenced SOP Instance UID	0008,1155	UI		X			X	Universal	
Reason for the Requested Procedure	0040,1002	LO		X			X	Universal	
Reason for Requested Procedure Code Sequence	0040,100A	SQ		X			X	Universal	configurable
>Code Meaning	0008,0104	LO		X			X	Universal	configurable
>Code Value	0008,0100	SH		X			X	Universal	configurable
>Coding Scheme Designator	0008,0102	SH		X			X	Universal	configurable
>Coding Scheme Version	0008,0103	SH		X			X	Universal	configurable
Requested Procedure Code Sequence	0032,1064	SQ		X			X		
>Code Meaning	0008,0104	LO		X			X	Universal	
>Code Value	0008,0100	SH		X			X	Universal	
>Coding Scheme Designator	0008,0102	SH		X			X	Universal	
>Coding Scheme Version	0008,0103	SH		X			X	Universal	
Imaging Service Request Module									
Accession Number	0008,0050	SH		X	X	X	X	Single Value	
Referring Physician's Name	0008,0090	PN		X		X	X	Universal	
Placer Order Number / Imaging Service Request	0040,2016	LO		X			X	Universal	
Filler Order Number / Imaging Service Request	0040,2017	LO		X			X	Universal	
Visit Admission Module									
Admitting Diagnoses Description	0008,1080	LO		X			X	Universal	
Admitting Diagnoses Code Sequence	0008,1084	SQ		X			X	Universal	
>Code Meaning	0008,0104	LO		X			X	Universal	
>Code Value	0008,0100	SH		X			X	Universal	
>Coding Scheme Designator	0008,0102	SH		X			X	Universal	
>Coding Scheme Version	0008,0103	SH		X			X	Universal	

The default Query Configuration is set to Modality (OT) and Date (Today). Optionally, additional matching for the own AET and/or own Station Name is configurable.

This part of the section includes the dataset specific behavior, i.e. error codes, error and exception handling, time-outs, etc.

Table 17: Status Response

Service Status	Error Code	Further Meaning	Behavior
Success	0000	Matching is complete	The SCU has successfully returned all matching information. Association Release RQ message sent to RIS
Failure	A700	Refused - Out of resources	Processing of the matches and the association is terminated. A message appears in the GUI. A message appears in the GUI as "error in digital fluoroscopy imaging sub system "
	A900	Failed - Identifier does not match SOP class	The association is terminated and the status is logged into the system error log. A message appears in the GUI as "error in digital fluoroscopy imaging sub system "
	Cxxx	Failed - Unable to process	Processing of the matches and the association is terminated. A message appears in the GUI as "error in digital fluoroscopy imaging sub system "
Pending	FF00	Matches are continuing - Current match is supplied and any optional keys were supported in the same manner as required keys	Processing of the matches continues.
	FF01	Matches are continuing - Warning that one or more optional keys were not supported for existence for this identifier	Processing of the matches continues without any warnings or errors.

4.2.1.3.3. (Real-World) Activity – Modality Performed Procedure Step As SCU

4.2.1.3.3.1. Description and Sequencing of Activities

After an acquisition the Mobile C-Arm AE sends related MPPS data to a Study Management SCP (RIS/HIS). Then the acquired image is stored or printed according the settings as specified by the operator.

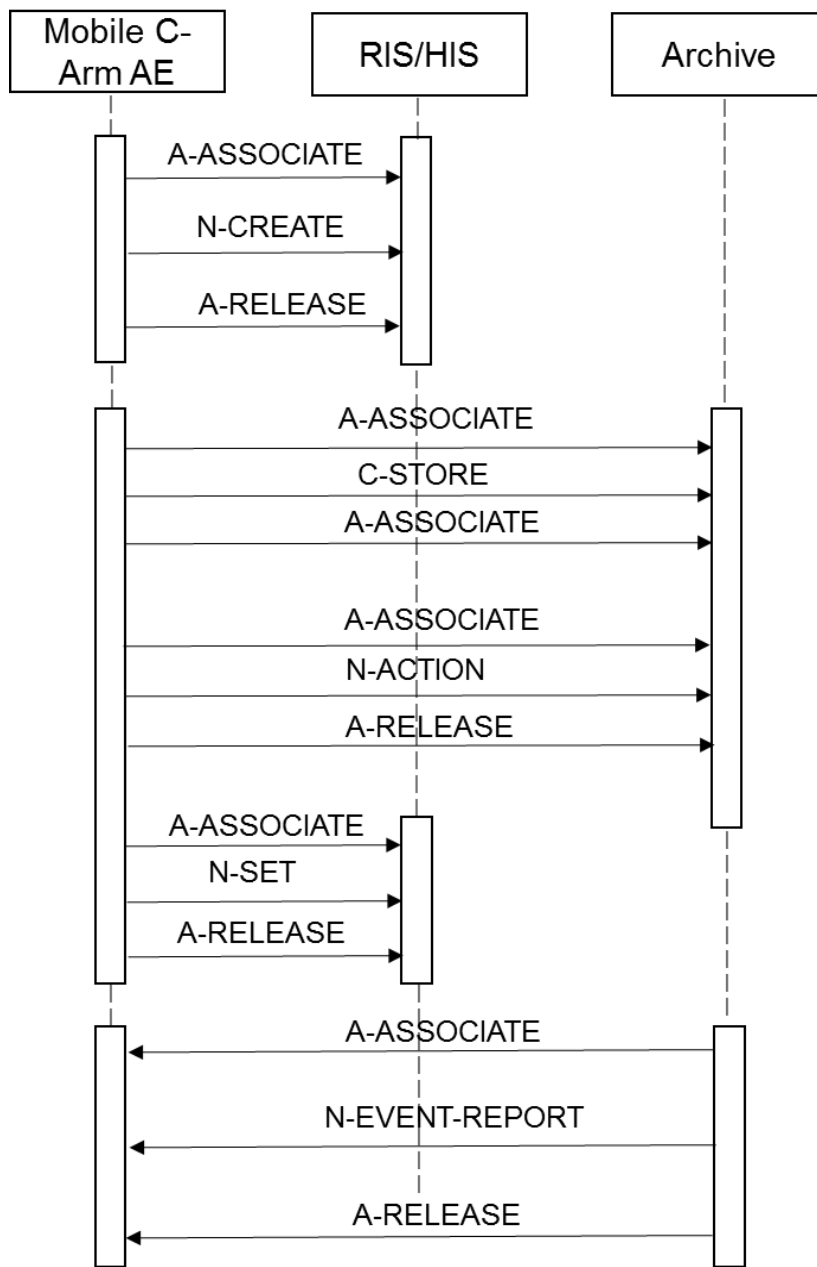

Figure 7: (Real World) Activity - MPPS as SCU

The Modality Performed Procedure Step for a specific exam happens in two steps.

An examination is selected from Scheduled work list (or added new examination within the system).

Examination is started.

Acquisition is started. At this moment MPPS N-CREATE with status "IN PROGRESS" will be sent to RIS when first image is acquired within an examination.

When operator selects the acquired images and exports them to the DICOM network node that is configured to trigger MPPS, then after the images are exported, MPPS N-SET will be sent to RIS with status either COMPLETED or DISCONTINUED.

When additional images are selected and exported, then new instance of MPPS N-CREATE and N-SET will be created and sent to RIS. If at system configuration "Append MPPS for additional exported images" is no, then no new MPPS messages are sent to RIS.

4.2.1.3.3.2. Proposed Presentation Contexts

The presentation contexts are defined in below table below:

Table 18: Proposed Presentation Contexts for (Real-World) Activity – Modality Performed Procedure Step As SCU

Presentation Context Table					
Abstract Syntax		Transfer Syntax		Role	Extended Negotiation
Name	UID	Name List	UID List		
Modality Performed Procedure Step SOP Class	1.2.840.10008.3.1.2.3.3	Explicit VR Big Endian	1.2.840.10008.1.2.2	SCU	None
		Explicit VR Little Endian	1.2.840.10008.1.2.1		
		Implicit VR Little Endian	1.2.840.10008.1.2		

4.2.1.3.3.3. SOP Specific Conformance for Modality Performed Procedure Step SOP Class

This section and sub-section includes the manufacturer SOP and Dataset specific information as well the status codes and their corresponding behavior.

The Mobile C-Arm AE provides standard conformance to the Modality Performed Procedure Step SOP class.

4.2.1.3.3.3.1 Dataset Specific Conformance for Modality Performed Procedure Step SOP Class N-CREATE-SCU

The content of the MPPS N-CREATE-RQ message is specified in the table below

Table 19: MPPS Request Identifiers for N-CREATE-RQ

Attribute Name	Tag	VR	Value	Comment
SOP Common Module				
Specific Character Set	0008,0005	CS	ISO_IR 100	Present if expanded/replacement character set used.
Performed Procedure Step Relationship Module				
Patient ID	0010,0020	LO		From WLM or entered by user.
Patient's Birth Date	0010,0030	DA		From WLM or entered by user.
Patient's Name	0010,0010	PN		From WLM or entered by user.
Patient's Sex	0010,0040	CS	F, M, O	From WLM or entered by user.
Referenced Patient Sequence	0008,1120	SQ		EMPTY or from WLM
>Referenced SOP Class UID	0008,1150	UI		From WLM
>Referenced SOP Instance UID	0008,1155	UI		From WLM
Scheduled Step Attributes Sequence	0040,0270	SQ		
>Accession Number	0008,0050	SH		From WLM or entered by User.
>Requested Procedure Description	0032,1060	LO		EMPTY or from WLM.
>Requested Procedure ID	0040,1001	SH		EMPTY or from WLM.
>Scheduled Procedure Step Description	0040,0007	LO		EMPTY or from WLM.
>Scheduled Procedure Step ID	0040,0009	SH		EMPTY or from WLM.
>Study Instance UID	0020,000D	UI		Newly generated or from WLM/
>Referenced Study Sequence	0008,1110	SQ		EMPTY or from WLM.
>>Referenced SOP Class UID	0008,1150	UI		From WLM.

Attribute Name	Tag	VR	Value	Comment
>>Referenced SOP Instance UID	0008,1155	UI		From WLM.
>Scheduled Protocol Code Sequence	0040,0008	SQ		EMPTY or from WLM
>>Code Meaning	0008,0104	LO		From WLM.
>>Code Value	0008,0100	SH		From WLM.
>>Coding Scheme Designator	0008,0102	SH		From WLM.
>>Coding Scheme Version	0008,0103	SH		From WLM.
Performed Procedure Step Information Module				
Performed Location	0040,0243	SH		EMPTY
Performed Procedure Step Description	0040,0254	LO		Copied from Requested Procedure Description (0032, 1060) or Scheduled Procedure Step description (0040, 0007) of MWL. If MWL is empty, then Examination Type is used.
Performed Procedure Step End Date	0040,0250	DA		EMPTY
Performed Procedure Step End Time	0040,0251	TM		EMPTY
Performed Procedure Step ID	0040,0253	SH		Running counter.
Performed Procedure Step Start Date	0040,0244	DA		Exam date, format: <yyyymmdd>
Performed Procedure Step Start Time	0040,0245	TM		Exam time, format: <hhmmss>
Performed Procedure Step Status	0040,0252	CS	IN PROGRESS	
Performed Procedure Type Description	0040,0255	LO		EMPTY
Performed Station AE Title	0040,0241	AE		System AE Title.
Performed Station Name	0040,0242	SH		
Procedure Code Sequence	0008,1032	SQ		EMPTY or from WLM ->Requested Procedure Code Sequence.
>Code Meaning	0008,0104	LO		From WLM.
>Code Value	0008,0100	SH		From WLM.
>Coding Scheme Designator	0008,0102	SH		From WLM.
>Coding Scheme Version	0008,0103	SH		From WLM.
Performed Procedure Step Discontinuation Reason Code Sequence	0040,0281	SQ		Present if Performed Procedure Step Status is DISCONTINUED
Image Acquisition Results Module				
Modality	0008,0060	CS		From WLM.
Study ID	0020,0010	SH		EMPTY or from WLM->Requested Procedure ID
Performed Protocol Code Sequence	0040,0260	SQ		EMPTY
Performed Series Sequence	0040,0340	SQ		EMPTY
Radiation Dose Module				
Entrance Dose	0040,0302	US		Attribute is sent with an appropriate value
Entrance Dose in mGy	0040,8302	DS		Attribute is sent with an appropriate value
Image and Fluoroscopy Area Dose Product	0018,115E	DS		Accumulated DAP in dGy*cm*cm
Total Number of Exposures	0040,0301	US		Total number of exposures done.
Total Time of Fluoroscopy	0040,0300	US		Total time of fluoroscopy exposure in seconds.

This part of the section includes the dataset specific behavior, i.e. error codes, error and exception handling, time-outs, etc.

Table 20: Status Response

Service Status	Error Code	Further Meaning	Behavior
Success	0000	Success	The SCP has received the MPPS message. Association will be released.
Failure	0105	No such attribute	The association is aborted and the MPPS service request is marked as failed in the export queue. The job viewer is displayed with error message "Please check if the selected target is working properly . To retry the transfer ,click the Redo button in the job viewer."
	0110	Processing failure - Performed procedure step object may no longer be updated	The association is aborted and the MPPS service request is marked as failed in the Job Viewer. Error message is displayed as "Please check if the selected target is working properly . To retry the transfer ,click the Redo button in the job viewer."
Warning	0107	Attribute list error	The MPPS service request is considered successful
Failed	0116	Attribute value out of range	The MPPS service request is considered successful

4.2.1.3.3.3.2 Dataset Specific Conformance for Modality Performed Procedure Step SOP Class N-SET-SCU

The content of the MPPS N-SET-RQ message is specified in the table below.

Table 21: MPPS Request Identifiers for N-SET-RQ

Attribute Name	Tag	VR	Value	Comment
Performed Procedure Step Information Module				
Performed Procedure Step Description	0040,0254	LO		EMPTY
Performed Procedure Step End Date	0040,0250	DA		
Performed Procedure Step End Time	0040,0251	TM		
Performed Procedure Step Status	0040,0252	CS	COMPLETED, DISCONTINUED	
Performed Procedure Type Description	0040,0255	LO		EMPTY
Performed Procedure Step Discontinuation Reason Code Sequence	0040,0281	SQ		Present if Performed Procedure Step Status is DISCONTINUED
>Code Meaning	0008,0104	LO		
>Code Value	0008,0100	SH		
>Coding Scheme Designator	0008,0102	SH		
>Coding Scheme Version	0008,0103	SH		
Image Acquisition Results Module				
Performed Series Sequence	0040,0340	SQ		
>Operators' Name	0008,1070	PN		Performing Technologist.
>Performing Physician's Name	0008,1050	PN		EMPTY or copied from Scheduled Performing Physician's name if provided by MWL, or can entered by operator.
>Protocol Name	0018,1030	LO		User selectable in MPPS panel.
>Retrieve AE Title	0008,0054	AE		EMPTY
>Series Description	0008,103E	LO		EMPTY

Attribute Name	Tag	VR	Value	Comment
>Series Instance UID	0020,000E	UI		Reference to series.
>Referenced Image Sequence	0008,1140	SQ		Reference to all sent images.
>>Referenced SOP Class UID	0008,1150	UI		1.2.840.10008.5.1.4.1.1.12.1
>>Referenced SOP Instance UID	0008,1155	UI		
>Referenced Non-Image Composite SOP Instance Sequence	0040,0220	SQ		EMPTY.

Radiation Dose Module

Entrance Dose	0040,0302	US		Attribute is sent with an appropriate value
Entrance Dose in mGy	0040,8302	DS		Attribute is sent with an appropriate value
Image and Fluoroscopy Area Dose Product	0018,115E	DS		Accumulated DAP in dGy*cm*cm
Total Number of Exposures	0040,0301	US		Total number of exposures done.
Total Time of Fluoroscopy	0040,0300	US		Total time of fluoroscopy exposure in seconds.

This part of the section includes the dataset specific behavior, i.e. error codes, error and exception handling, time-outs, etc.

Table 22: Status Response

Service Status	Error Code	Further Meaning	Behavior
Success	0000	Success	The SCP has completed the MPPS service request successfully
Failure	0105	No such attribute	The association is aborted and the MPPS service request is marked as failed in the Job Viewer .Error message is displayed as "Please check if the selected target is working properly . To retry the transfer ,click the Redo button in the job viewer."
	0110	Processing failure - Performed procedure step object may no longer be updated	The association is aborted and the MPPS service request is marked as failed in the Job Viewer .Error message is displayed as "Please check if the selected target is working properly . To retry the transfer , click the Redo button in the job viewer."
Warning	0107	Attribute list error	The MPPS service request is considered successful.
	0106	Attribute value out of range	The MPPS service request is considered successful.

4.2.1.3.4. (Real-World) Activity – Image Export

4.2.1.3.4.1. Description and Sequencing of Activities

After selection of an instance file, the file will be sent when initiating the Send command. The Mobile C-Arm AE initiates one association to the preconfigured peer system and uses it to send the selected instance and runs via CSTORE requests (and receives the associated C-STORE responses). The association is released after successful transfer of the instances or when an error occurs.

The following instances are supported:

- Images
- RDSRs

The Mobile C-Arm AE handles each send request one after another.

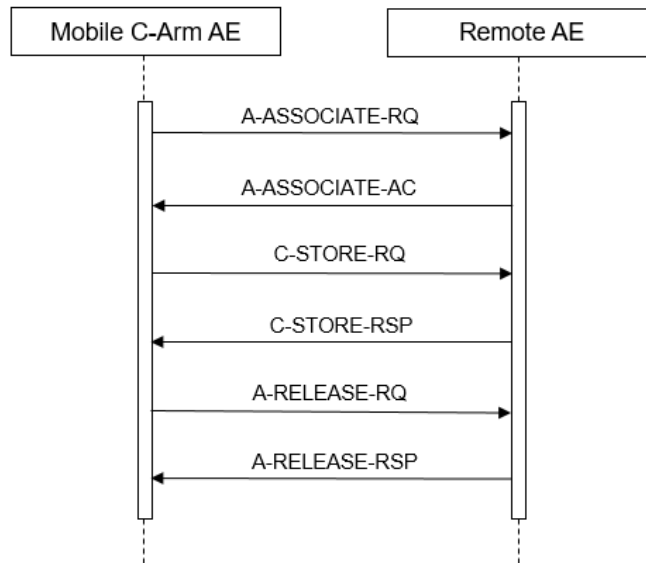

Figure 8: (Real World) Activity – Image export

4.2.1.3.4.2. Proposed Presentation Contexts

The presentation contexts proposed by the Console AE for Image Export are defined in Table below.

Table 23: Proposed Presentation Contexts for (Real-World) Activity – Image Export

Presentation Context Table					
Abstract Syntax		Transfer Syntax		Role	Extended Negotiation
Name	UID	Name List	UID List		
X-Ray Angiographic Image Storage SOP Class	1.2.840.10008.5.1.4.1.1.12.1	Explicit VR Little Endian	1.2.840.10008.1.2.1	SCU	None
		Implicit VR Little Endian	1.2.840.10008.1.2		
		Explicit VR Big Endian	1.2.840.10008.1.2.2		
Secondary Capture Image Storage SOP Class	1.2.840.10008.5.1.4.1.1.7	Explicit VR Big Endian	1.2.840.10008.1.2.2	SCU	None
		Explicit VR Little Endian	1.2.840.10008.1.2.1		
		Implicit VR Little Endian	1.2.840.10008.1.2		
X-Ray Radiation Dose SR	1.2.840.10008.5.1.4.1.1.88.67	Explicit VR Big Endian	1.2.840.10008.1.2.2	SCU	None
		Explicit VR Little Endian	1.2.840.10008.1.2.1		
		Implicit VR Little Endian	1.2.840.10008.1.2		

4.2.1.3.4.3. SOP Specific Conformance for Storage SOP Class

This section and sub-section includes the manufacturer SOP and Dataset specific information as well the status codes and their corresponding behavior.

The Mobile C-Arm AE provides standard conformance to the Storage SOP classes.

The Mobile C-Arm administration is based on Examinations, where each Examination is mapped to one Study (for one Patient). An Examination consists of one or more Runs, where each Run is mapped to one Series.

Note that a Secondary Capture Series can contain one or more Secondary Capture Images, though an XA Series can contain only one multi-frame XA Image of one or more Frames.

Upon receiving a C-STORE response with status Error or Refused, the Mobile C-Arm AE will release the association. The transfer of all of the selected images of the examination will be considered failed. The operator may retry export jobs manually.

4.2.1.3.4.3.1 Dataset Specific Conformance for C-STORE-RQ

The possible Status Responses for the export Images storage are shown in table below.

Table 24: C-STORE-RQ Status Response

Service Status	Code	Further Meaning	Behavior
Success	0000	Success	The SCP has completed the Storage service request successfully.
Failure	A7xx	Refused:Out of resources	Image transfer is considered failed. Images remain in queue. User can initiate retry. Status is logged in system file. Job viewer displays the status of job as failed
	A9xx	Error: Data set does not match SOP class	Image transfer is considered failed. Images remain in queue. User can initiate retry. Status is logged in system file. Job viewer displays the status of job as failed
	C000	Error: Cannot understand	Image transfer is considered failed. Images remain in queue. User can initiate retry. Status is logged in system file. Job viewer displays the status of job as failed
Warning	B000	Coercion of data elements	Image transfer is considered successful. Status is logged in system file.
	B006	Elements discarded	Image transfer is considered successful. Status is logged in system file.
	B007	Data set does not match SOP class	Image transfer is considered successful. Status is logged in system file.

4.2.1.3.5. (Real-World) Activity – Storage Commitment Push Model AS SCU

4.2.1.3.5.1. Description and Sequencing of Activities

If the configured storage DICOM node is Archive, then Storage commitment is initiated by Mobile C-Arm. Mobile C-Arm supports asynchronous storage commitment.

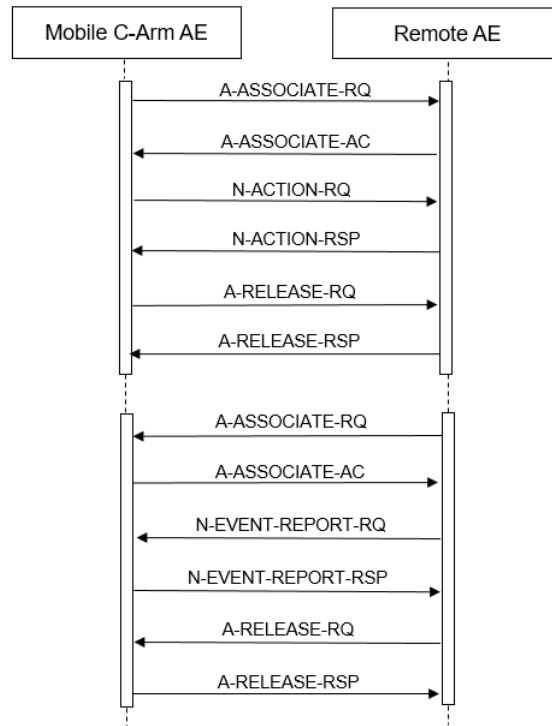

Figure 9: (Real World) Activity - Synchronous Storage Commitment Push model as SCU

4.2.1.3.5.2. Proposed Presentation Contexts

The proposed presentation contexts for Storage Commitment Push Model as SCU are defined in Table below.

Table 25: Proposed Presentation Contexts for (Real-World) Activity – Storage Commitment Push Model AS SCU

Presentation Context Table					
Abstract Syntax		Transfer Syntax		Role	Extended Negotiation
Name	UID	Name List	UID List		
Storage Commitment Push Model SOP Class	1.2.840.10008.1.20.1	Explicit VR Little Endian	1.2.840.10008.1.2.1	SCU	None
		Implicit VR Little Endian	1.2.840.10008.1.2		
		Explicit VR Little Endian	1.2.840.10008.1.2.2		

4.2.1.3.5.3. SOP Specific Conformance for Storage Commitment Push Model SOP Class

This section and sub-section includes the manufacturer SOP and Dataset specific information as well the status codes and their corresponding behavior.

The Mobile C-Arm AE provides standard conformance to the Storage Commitment Push Model SOP class for Asynchronous storage commitment.

4.2.1.3.5.3.1 Dataset Specific Conformance for Storage Commitment Push Model SOP Class N-ACTION-SCU

Details regarding the Dataset Specific response behavior will be reported in this section.

Table 26: Storage Commitment Attribute for N-ACTION-RQ

Attribute Name	Tag	Comment
Storage Commitment Module		
Transaction UID	0008,1195	Generated Unique ID each transaction.
Referenced SOP Sequence	0008,1199	References to all images sent.
>Referenced SOP Class UID	0008,1150	References to send SOP Class.
>Referenced SOP Instance UID	0008,1155	References to all images sent.

This part of the section includes the dataset specific behavior, i.e. error codes, error and exception handling, time-outs, etc

Table 27: Status Response

Service Status	Error Code	Further Meaning	Behavior
Success	0000	Success	The SCP has completed the Storage Commitment service request successfully.
Failure	<xxxx>	All other error codes	The association is aborted and the storage commitment is marked as failed.

4.2.1.3.5.3.2 Dataset Specific Conformance for Storage Commitment Push Model SOP Class N-EVENT-REPORT-SCU

Details regarding the Dataset Specific response behavior will be reported in this section.

This part of the section includes the dataset specific behavior, i.e. error codes, error and exception handling, time-outs, etc.

Table 28: Storage Commitment - N-EVENT-REPORT Behavior

Event Type Name	Event Type ID	Behavior
Storage Commitment Request Successful	1	The Referenced SOP Instances under Referenced SOP Sequence (0008, 1199) are marked within the database as "Stored & Committed (SC)" to the value of Retrieve AE Title (0008, 0054).
Storage Commitment Request Complete - Failures Exist	2	In case of a "Failure Exist" situation (Referenced SOP Instances under Failed SOP Sequence (0008, 1198)), all of the stored SOP Instances for that examination are considered as failed for storage commitment. A send job that failed storage commitment will not be automatically restarted but can be resumed by the user.

Table 29: Storage Commitment N-EVENT-REPORT Failure Handling Behavior

Service Status	Error Code	Further Meaning	Description
Success	0000	Success	The Mobile C-Arm AE has completed the operation successfully.
Failure	*	Any other failure status code	The association is aborted and the storage commit NEVENT-REPORT is marked as failed

4.2.1.3.6. (Real-World) Activity - Print Management as SCU

4.2.1.3.6.1. Description and Sequencing of Activities

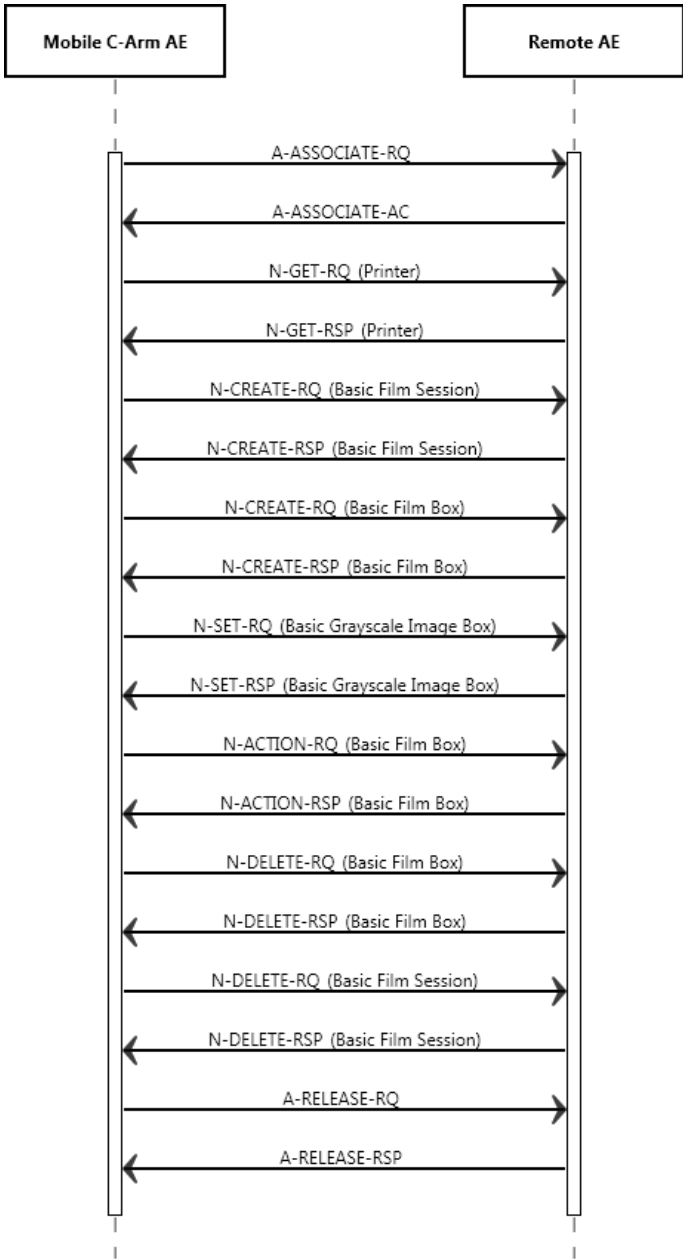

Figure 10: (Real World) Activity - Print Management as SCU

Based on the selected layout, the Mobile C-Arm AE will create a Film Session containing a single Film Box. The content of the Image Box will be filled for the print request (Film Box level). Once the print session has completed the Film Session will be deleted. A new Film Box is created for each successive film within the Film Session.

The Mobile C-Arm AE is implemented to acquire grayscale images and thus to negotiate for Basic Grayscale Print Management. The processing of a print job can be cancelled at any time; then the Mobile C-Arm AE will abort the processing immediately.

Before a queued print job is actually started, the system will retrieve the printer status. Upon receiving a normalized service response (N-GET) containing a Failure or Warning status, the Mobile C-Arm AE does not start the export job.

Upon receiving a print command response with failure status, the Mobile C-Arm AE will release the association. The transfer of all of the selected images of the examination will be considered failed. The operator may retry export jobs manually.

4.2.1.3.6.2. Proposed Presentation Contexts

The presentation contexts are defined in the next table.

Table 30: Proposed Presentation Contexts for (Real-World) Activity – Print Management As SCU

Presentation Context Table					
Abstract Syntax		Transfer Syntax		Role	Extended Negotiation
Name	UID	Name List	UID List		
Basic Grayscale Print Management Meta SOP Class	1.2.840.10008.5.1.1.9			SCU	None
>Basic Film Session SOP Class	1.2.840.10008.5.1.1.1	Explicit VR Little Endian	1.2.840.10008.1.2.1	SCU	None
		Implicit VR Little Endian	1.2.840.10008.1.2		
		Explicit VR Big Endian	1.2.840.10008.1.2.2		
>Printer SOP Class	1.2.840.10008.5.1.1.16	Explicit VR Little Endian	1.2.840.10008.1.2.1	SCU	None
		Implicit VR Little Endian	1.2.840.10008.1.2		
		Explicit VR Big Endian	1.2.840.10008.1.2.2		
>Basic Film Box SOP Class	1.2.840.10008.5.1.1.2	Explicit VR Little Endian	1.2.840.10008.1.2.1	SCU	None
		Implicit VR Little Endian	1.2.840.10008.1.2		
		Explicit VR Big Endian	1.2.840.10008.1.2.2		
>Basic Grayscale Image Box SOP Class	1.2.840.10008.5.1.1.4	Explicit VR Little Endian	1.2.840.10008.1.2.1	SCU	None
		Implicit VR Little Endian	1.2.840.10008.1.2		
		Explicit VR Big Endian	1.2.840.10008.1.2.2		

Abbreviations used in the Module table for the column "Presence of Value" are:

ALWAYS	The attribute is always present with a value
EMPTY	The attribute is always present without any value (attribute sent zero length)
VNAP	The attribute is always present and its Value is Not Always Present (attribute sent zero length if no value is present)
ANAP	The attribute is present under specified condition – if present then it will always have a value
ANAPCV	The attribute is present under specified condition – if present then its Value is Not Always Present (attribute sent zero length if condition applies and no value is present)
ANAPEV	The attribute is present under specified condition – if present then it will not have any value

The abbreviations used in the Module table for the column "Source" are:

AUTO	The attribute value is generated automatically
CONFIG	The attribute value source is a configurable parameter
COPY	The attribute value source is another SOP instance
FIXED	The attribute value is hard-coded in the application
IMPLICIT	The attribute value source is a user-implicit setting
USER	The attribute value source is explicit user input

4.2.1.3.6.3. SOP Specific Conformance for Basic Film Session SOP Class of the Basic Grayscale Print Management Meta SOP Class

This section and sub-section include the manufacturer SOP and Dataset specific information as well the status codes and their corresponding behavior.

4.2.1.3.6.3.1 Dataset Specific Conformance for Basic Film Session N-ACTION SCU

Details regarding the Dataset Specific response behavior will be reported in this section.

This part of the section includes the dataset specific behavior, i.e. error codes, error and exception handling, time-outs, etc.

Table 31: Status Response

Service Status	Error Code	Further Meaning	Behavior
Success	0000	Film accepted for printing	Normal completion
Warning	B6XX		Print Film Session considered successful. Status logged in system file.
Failure	C6XX		Print Film Session considered failed. Status logged in system file.

4.2.1.3.6.3.2 Dataset Specific Conformance for Basic Film Session Presentation Module

Details regarding the Dataset Specific response behavior will be reported in this section.

Table 32: Basic Film Session Presentation Module

Attribute Name	Tag	VR	Value	Presence of Value	Source	Comment
Number of Copies	2000,0010	IS		ALWAYS	CONFIG	Integer (1-99)
Print Priority	2000,0020	CS	HIGH, LOW, MED	ALWAYS	CONFIG	
Medium Type	2000,0030	CS	BLUE FILM, CLEAR FILM, CURRENT,	ALWAYS	CONFIG	
Film Destination	2000,0040	CS	BIN_i (i=Integer), CURRENT, MAGAZINE, PROCESSOR,DEFAULT	ALWAYS	CONFIG	(i=Integer)
Film Session Label	2000,0050	LO	DICOM	ALWAYS	AUTO	Equal to Exam Type

Note: The default values are printer type dependent.

This part of the section includes the dataset specific behavior, i.e. error codes, error and exception handling, time-outs, etc.

Table 33: Status Response

Service Status	Error Code	Further Meaning	Behavior
Success	0000	Film Session successfully created	Normal completion
Warning	B6XX		Print Film Session considered successful. Status logged in system file.
Failure	C6XX		Print Film Session considered failed. Status logged in system file.

4.2.1.3.6.4. SOP Specific Conformance for Printer SOP Class of the Basic Grayscale Print Management Meta SOP Class

This section and sub-section include the manufacturer SOP and Dataset specific information as well the status codes and their corresponding behavior.

4.2.1.3.6.4.1 Dataset Specific Conformance for Printer N-GET SCU.

Details regarding the Dataset Specific response behavior will be reported in this section.

© 2020 Koninklijke Philips N.V.

Table 34: Printer Module

Attribute Name	Tag	VR	Value	Presence of Value	Source	Comment
Printer Status	2110,0010	CS		ALWAYS	AUTO	Provided by printer
Printer Status Info	2110,0020	CS		ALWAYS	AUTO	Provided by printer

Note: Only in case that the printer responds with a Printer status of "NORMAL" or "WARNING" the Mobile C-Arm AE continues printing of the images.

4.2.1.3.6.4.2 Dataset Specific Conformance for Printer N-EVENT-REPORT SCU

Details regarding the Dataset Specific response behavior will be reported in this section.

This part of the section includes the dataset specific behavior, i.e. error codes, error and exception handling, time-outs, etc.

Table 35: Printer - N-EVENT-REPORT Behavior

Event Type Name	Event Type ID	Behavior
NORMAL	1	When evaluated, the Mobile C-Arm AE sends response. The event is logged. The print job continues.
WARNING	2	When evaluated, the Mobile C-Arm AE sends response. The event is logged. The print job continues.
FAILURE	3	When evaluated, the Mobile C-Arm AE sends response. The event is logged. The print job gets aborted and is marked as failed.

4.2.1.3.6.5. SOP Specific Conformance for Basic Film Box SOP Class of the Basic Grayscale Print Management Meta SOP Class

This section and sub-section include the manufacturer SOP and Dataset specific information as well the status codes and their corresponding behavior.

4.2.1.3.6.5.1 Dataset Specific Conformance for Basic Film Box N-ACTION-SCU.

Details regarding the Dataset Specific response behavior will be reported in this section.

Table 36: Status Response

Service Status	Error Code	Further Meaning	Behavior
Success	0000	Success	The print job continues.
Failure	C602	Unable to create print job SOP instance – print queue is full.	The print job is marked as failed; the reason is reported and logged.
	C603	Image size is larger than image box size	The print job is marked as failed; the reason is reported and logged.
	C613	Combined print image size is larger than image box size.	The print job is marked as failed; the reason is reported and logged.
Warning	B603	Film Box SOP instance hierarchy does not contain Image Box SOP instances.	The print job continues and the warning is reported and logged.
	B604	Image size is larger than image box size – the image has been Demagnetized.	The print job continues and the warning is reported and logged.
	B609	Image size is larger than image box size – the image has been cropped to fit	The print job continues and the warning is reported and logged.
	B60A	Image size or combined print image size is larger than image box size – the image or combined print image has been decimated to fit.	The print job continues and the warning is reported and logged.

4.2.1.3.6.5.2 Dataset Specific Conformance for Basic Film Box N-CREATE-SCU.

Details regarding the Dataset Specific response behavior will be reported in this section.

Table 37: Basic Film Box Presentation Module

Attribute Name	Tag	VR	Value	Presence of Value	Source	Comment
Image Display Format	2010,0010	ST	STANDARD\1,1, STANDARD\1,2, STANDARD\2,2, STANDARD\2,3	ALWAYS	USER	
Film Orientation	2010,0040	CS	LANDSCAPE, PORTRAIT,DEFAULT	ALWAYS	CONFIG	
Film Size ID	2010,0050	CS	10INX12IN, 10INX14IN, 11INX11IN, 11INX14IN, 11INX17IN, 14INX14IN, 14INX17IN, 24CMX24CM, 24CMX30CM, 8_5INX11IN, 8INX10IN, A3, A4, CURRENT	ALWAYS	CONFIG	
Magnification Type	2010,0060	CS	BILINEAR, CUBIC, NONE, REPLICATE,DEFAULT	ALWAYS	CONFIG	
Smoothing Type	2010,0080	CS	1, 10, 11, 12, 13, 14, 140, 15, 2, 3, 4, 5, 6, 7, 8, 9, ENHANCED, ENHANCED1, MEDIUM, NORMAL, SHARP, SMOOTH	ALWAYS	CONFIG	
Border Density	2010,0100	CS	BLACK, OD (integer), WHITE	ALWAYS	CONFIG	(i), integer range: 0..1000
Empty Image Density	2010,0110	CS	BLACK, WHITE	ALWAYS	CONFIG	
Min Density	2010,0120	US	0..1000	ALWAYS	CONFIG	
Max Density	2010,0130	US	0..1000	ALWAYS	CONFIG	
Trim	2010,0140	CS	NO, YES,DEFAULT	ALWAYS	CONFIG	
Configuration Information	2010,0150	ST	LUT	ALWAYS	CONFIG	Printer configurable character string (max. 1024 char.)

Table 38: Basic Film Box Relationship Module

Attribute Name	Tag	VR	Value	Presence of Value	Source	Comment
Referenced Film Session Sequence	2010,0500	SQ		ALWAYS	AUTO	
>Referenced SOP Class UID	0008,1150	UI	1.2.840.10008.5.1.1.1	ALWAYS	AUTO	
>Referenced SOP Instance UID	0008,1155	UI	1.5.52.10587658484.2.0. 1.22.506.2	ALWAYS	AUTO	

Note: The default values and ranges are printer type dependent.

This part of the section includes the dataset specific behavior, i.e. error codes, error and exception handling, time-outs, etc.

Table 39: Status Response

Service Status	Error Code	Further Meaning	Behavior
Success	0000	Film Box successfully created	Normal completion
Warning	B6XX		Print Film Session considered successful. Status logged in system file.
Failure	C6XX		Print Film Session considered failed. Status logged in system file.

4.2.1.3.6.6. SOP Specific Conformance for Basic Grayscale Image Box SOP Class of the Basic Grayscale Print Management Meta SOP Class

This section and sub-section includes the manufacturer SOP and Dataset specific information as well the status codes and their corresponding behavior.

4.2.1.3.6.6.1 Dataset Specific Conformance for Basic Grayscale Image Box N-SET SCU

Detail regarding the Dataset Specific response behavior will be reported in this section.

Table 40: Image Box Pixel Presentation Module

Attribute Name	Tag	VR	Value	Presence of Value	Source	Comment
Image Box Position	2020,0010	US		ALWAYS	AUTO	Generated
Polarity	2020,0020	CS	NORMAL, REVERSE,DEFAULT	ALWAYS	CONFIG	
Basic Grayscale Image Sequence	2020,0110	SQ		ALWAYS	AUTO	
>Samples per Pixel	0028,0002	US	1	ALWAYS	FIXED	
>Photometric Interpretation	0028,0004	CS	MONOCHROME2	ALWAYS	FIXED	
>Rows	0028,0010	US	1024	ALWAYS	FIXED	
>Columns	0028,0011	US	1024	ALWAYS	FIXED	
>Bits Allocated	0028,0100	US	16	ALWAYS	FIXED	
>Bits Stored	0028,0101	US	16	ALWAYS	FIXED	
>High Bit	0028,0102	US	15	ALWAYS	FIXED	
>Pixel Representation	0028,0103	US	0x0000	ALWAYS	FIXED	
>Pixel Data	7FE0,0010	O W/ OB		ALWAYS	AUTO	

Note: The default values are printer type dependent.

This part of the section includes the dataset specific behavior, i.e. error codes, error and exception handling, time-outs, etc.

Table 41: Status Response

Service Status	Error Code	Further Meaning	Behavior
Success	0000	Image successfully stored in Image Box	Normal completion
Warning	B6XX		Print Film Session considered successful. Status logged in system file.
Failure	C6XX		Print Film Session considered failed. Status logged in system file.

4.2.1.4. Association Acceptance Policy

Not applicable.

4.2.2. Image Viewer AE.

Details of this specific Application Entity is specified in this section.

© 2020 Koninklijke Philips N.V.

4.2.2.1. SOP Classes

This Application Entity provides Standard Conformance to the following SOP Classes.

Table 42: SOP Classes for Image Viewer AE

SOP Class Name	SOP Class UID	SCU	SCP
Verification SOP Class	1.2.840.10008.1.1	No	Yes
Computed Radiography Image Storage SOP Class	1.2.840.10008.5.1.4.1.1.1	No	Yes
CT Image Storage SOP Class	1.2.840.10008.5.1.4.1.1.2	No	Yes
Digital X-Ray Image Storage - For Pres. SOP	1.2.840.10008.5.1.4.1.1.1.1	No	Yes
Basic Text SR Storage SOP Class	1.2.840.10008.5.1.4.1.1.88.11	No	Yes
Enhanced SR Storage SOP Class	1.2.840.10008.5.1.4.1.1.88.22	No	Yes
Comprehensive SR Storage SOP Class	1.2.840.10008.5.1.4.1.1.88.33	No	Yes
Key Object Selection Document Storage SOP Class	1.2.840.10008.5.1.4.1.1.88.59	No	Yes
Digital X-Ray Image Storage - For Processing	1.2.840.10008.5.1.4.1.1.1.1.1	No	Yes
PET Image Storage SOP Class	1.2.840.10008.5.1.4.1.1.128	No	Yes
Digital Mammography X-Ray Image Storage - Pres. SOP	1.2.840.10008.5.1.4.1.1.1.2	No	Yes
Digital Mammography X-Ray Image Storage - Proc. SOP	1.2.840.10008.5.1.4.1.1.1.2.1	No	Yes
NM Image Storage SOP Class	1.2.840.10008.5.1.4.1.1.20	No	Yes
12-lead ECG Waveform Storage SOP Class	1.2.840.10008.5.1.4.1.1.9.1.1	No	Yes
General ECG Waveform Storage SOP Class	1.2.840.10008.5.1.4.1.1.9.1.2	No	Yes
Ambulatory ECG Waveform Storage SOP Class	1.2.840.10008.5.1.4.1.1.9.1.3	No	Yes
Hemodynamic Waveform Storage SOP Class	1.2.840.10008.5.1.4.1.1.9.2.1	No	Yes
Enhanced MR Image Storage SOP Class	1.2.840.10008.5.1.4.1.1.4.1	No	Yes
RAW Data Image Storage SOP Class SOP Class	1.2.840.10008.5.1.4.1.1.66	No	Yes
Brachy Treatment Record Storage SOP Class	1.2.840.10008.5.1.4.1.1.481.6	No	Yes
RT Treatment Summary Record Storage SOP Class	1.2.840.10008.5.1.4.1.1.481.7	No	Yes
MRSpectroscopy Storage SOP Class	1.2.840.10008.5.1.4.1.1.4.2	No	Yes
Multi-frame Single Bit Secondary Capture Image Storage	1.2.840.10008.5.1.4.1.1.7.1	No	Yes
Multi-frame Grayscale Byte Secondary Capture Image Storage	1.2.840.10008.5.1.4.1.1.7.2	No	Yes
Multi-frame Grayscale Word Secondary Capture Image Storage SOP Class	1.2.840.10008.5.1.4.1.1.7.3	No	Yes
Multi-frame True Color Secondary Capture Image Image Storage SOP Class	1.2.840.10008.5.1.4.1.1.7.4	No	Yes
RT Image Storage SOP Class Storage SOP Class	1.2.840.10008.5.1.4.1.1.481.1	No	Yes
RT Dose Storage SOP Class Storage SOP Class	1.2.840.10008.5.1.4.1.1.481.2	No	Yes
RT Structure Set Storage SOP Class	1.2.840.10008.5.1.4.1.1.481.3	No	Yes
RT Beams Treatment	1.2.840.10008.5.1.4.1.1.481.4	No	Yes
RT Plan Storage Transfer	1.2.840.10008.5.1.4.1.1.481.5	No	Yes
Workflow (private)	1.3.46.670589.2.9.1.1	No	Yes
Specimen	Supplement 122 + CP800	No	Yes
Surface Segmentation Storage SOP Class	1.2.840.10008.5.1.4.1.1.66.5	No	Yes
X-Ray 3D Craniofacial Image Storage SOP Class	1.2.840.10008.5.1.4.1.1.13.1.2	No	Yes
Enhanced PET Storage SOP Class	1.2.840.10008.5.1.4.1.1.130	No	Yes
Grayscale Softcopy Presentation State Storage SOP Class	1.2.840.10008.5.1.4.1.1.11.1	No	Yes
X-Ray Angiographic Image Storage SOP Class	1.2.840.10008.5.1.4.1.1.12.1	No	Yes
X-Ray Radiofluoroscopic Image Storage SOP Class	1.2.840.10008.5.1.4.1.1.12.2	No	Yes
Ultrasound Multi-frame Image Storage SOP Class	1.2.840.10008.5.1.4.1.1.3.1	No	Yes
MR Image Storage SOP Class	1.2.840.10008.5.1.4.1.1.4	No	Yes

SOP Class Name	SOP Class UID	SCU	SCP
Ultrasound Image Storage SOP Class	1.2.840.10008.5.1.4.1.1.6.1	No	Yes
Secondary Capture Image Storage SOP Class	1.2.840.10008.5.1.4.1.1.7	No	Yes
Patient Root QR Information Model - FIND SOP Class	1.2.840.10008.5.1.4.1.2.1.1	Yes	No
Patient Root QR Information Model - MOVE SOP Class	1.2.840.10008.5.1.4.1.2.1.2	Yes	No
Study Root QR Information Model - FIND SOP Class	1.2.840.10008.5.1.4.1.2.2.1	Yes	No
Study Root QR Information Model - MOVE SOP Class	1.2.840.10008.5.1.4.1.2.2.2	Yes	No
PatientStudy Only QR Info. Model - FIND SOP Class (Retired)	1.2.840.10008.5.1.4.1.2.3.1	Yes	No
PatientStudy Only QR Info. Model - MOVE SOP Class (Retired)	1.2.840.10008.5.1.4.1.2.3.2	Yes	No
PIIM specialized Presentation State	1.3.46.670589.2.2.1.1	No	Yes
XRAY Specialized	1.3.46.670589.2.3.1.1	No	Yes

Note: Any SOP specific behavior is documented later in the conformance statement in the applicable SOP specific conformance section.

4.2.2.2. Association Policies

Each AE specification contains a description of the general association establishment and acceptance policies of the AE.

4.2.2.2.1. General

The DICOM standard application context is specified below.

Table 43: DICOM Application Context

Description	Value
Application Context Name	1.2.840.10008.3.1.1.1

4.2.2.2.2. Number of Associations

The number of simultaneous associations that the Console Store AE as initiator supports is specified in table below.

Table 44: Number of associations as an Association Initiator for this AE

Description	Value
Maximum number of simultaneous associations	1

Table 45: Number of associations as an Association Acceptor for this AE

Description	Value
Maximum number of simultaneous associations	configurable

4.2.2.2.3. Asynchronous Nature

The Mobile C-Arm AE only supports asynchronous operations for Storage Commitment report. It will not perform asynchronous window negotiation.

4.2.2.2.4. Implementation Identifying Information

The value supplied for Implementation Class UID and version name are documented here.

Table 46: DICOM Implementation Class and Version for Image Viewer AE.

Implementation Class UID	1.3.46.670589.54.2.17.4
Implementation Version Name	17.4.0.0

4.2.2.2.5. Communication Failure Handling

The behavior of the AE during communication failure is summarized in the table below:

Table 47: Communication Failure Behavior

Exception	Behavior
ARTIM Timeout	The job fails in case of association setup. The reason is logged and reported to the operator.
Reply Timeout	The job fails and the association is aborted. The reason is logged and reported to the operator.
Association Timeout	The association is released.
Association Aborted	The job fails. The reason is logged and reported to the operator.

4.2.2.3. Association Initiation Policy

The Application Entity will response on a received reject Association attempts as shown in next table.

Table 48: Association Rejection response

Result	Source	Reason/Diagnosis	Explanation
1 - rejected-permanent	1 - DICOM UL service-user	1 - no-reason-given	-
		2 - application-context-name-not supported	-
		3 - calling-AE-title-not-recognized	-
		7 - called-AE-title-not-recognized	-
	2 - DICOM UL service-provider (ACSE related function)	1 - no-reason-given	-
		2 - protocol-version-not-supported	-
2 - rejected-transient	1 - DICOM UL service-user	1 - no-reason-given	-
		2 - application-context-name-not-supported	-
		3 - calling-AE-title-not-recognized	-
		7 - called-AE-title-not-recognized	-
	2 - DICOM UL service-provider (ACSE related function)	1 - no-reason-given	-
		2 - protocol-version-not-supported	-
3 - DICOM UL service-provider (Presentation related function)	1 - temporary congestion	-	
	2 - local-limit-exceeded	-	

The behavior of the AE on receiving an association abort is summarized in next table.

Table 49: Association Abort Handling

Source	Reason/Diagnosis	Behavior
0 - DICOM UL service-user (initiated abort)	0 - reason-not-specified	-
2 - DICOM UL service-provider (initiated abort)	0 - reason-not-specified	-
	1 - unrecognized-PDU	-

Source	Reason/Diagnosis	Behavior
	2 - unexpected-PDU	-
	4 - unrecognized-PDU parameter	-
	5 - unexpected-PDU parameter	-
	6 - invalid-PDU-parameter value	-

4.2.2.3.1. (Real-World) Activity – FIND as SCU

4.2.2.3.1.1. Description and Sequencing of Activities

For viewing images, the operator can use the Image Viewer AE to query a remote archive and select the images to retrieve. The Image Viewer AE then sends a retrieve request and accepts the related images.

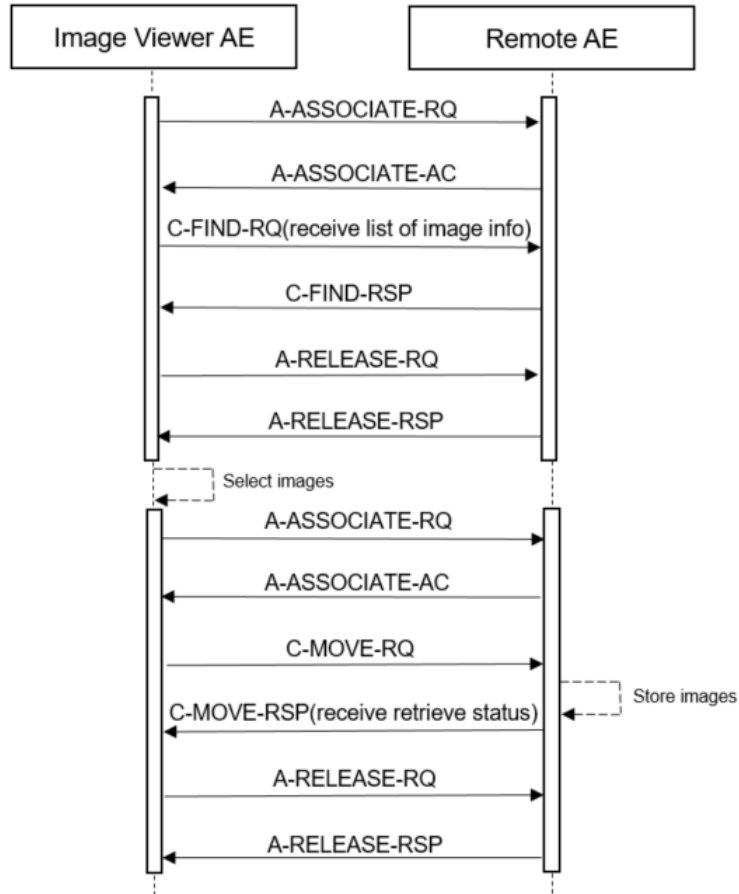

Figure 11: (Real World) Activity – FIND as SCU

The operator queries a remote archive, using the query tool in the data handling facility. The Image Viewer AE initiates an association to the selected peer entity (Archive) and uses it to send Query (C-FIND) requests and receive subsequent responses. The association is released when the execution of the query completes and the Query/Retrieve dialog on the GUI is closed. The matching images are then displayed in a patient folder and the received images can be retrieved to remote archive.

4.2.2.3.1.2. Proposed Presentation Contexts

The presentation contexts are defined in the next table.

Table 50: Proposed Presentation Contexts for (Real-World) Activity – FIND as SCU

Presentation Context Table					
Abstract Syntax		Transfer Syntax		Role	Extended Negotiation
Name	UID	Name List	UID List		
Study Root QR Information Model - FIND SOP Class	1.2.840.10008.5.1.4.1.2.1.1	Explicit VR Big Endian	1.2.840.10008.1.2.2	SCU	None
		Explicit VR Little Endian	1.2.840.10008.1.2.1		
		Implicit VR Little Endian	1.2.840.10008.1.2		

Note: For performance reasons the ELE transfer syntax is preferred.

4.2.2.3.1.3. SOP Specific Conformance for Study Root QR Information Model – FIND SOP Class

This section and sub-section includes the manufacturer SOP and Dataset specific information as well the status codes and their corresponding behavior.

4.2.2.3.1.3.1. Dataset Specific Conformance for Study Root QR Information Model – FIND SOP Class

Details regarding the Dataset Specific response behavior will be reported in this section.

The Image Viewer AE will not generate queries containing optional keys.

The Image Viewer AE will not generate relational queries.

In the following table the supported query keys for each query level are described.

Universal matching shall be supported as default.

Table 51: C-FIND-RQ Dataset Specification

Patient Root QR Information Model - FIND SOP Class					
Attribute Name	Tag	VR	Type of Matching	Comment	
Query/Retrieve Level	0008,0052	CS	Single Value	Patient, Study, Series	
Study Level keys					
Patient's Name	0010,0010	PN	Single Value, Universal, Wildcard		
Patient ID	0010,0020	LO	Single Value, Universal, WildCard		
Patient's Birth Date	0010,0030	DA	Single Value, Universal		
Other Patient Ids	0010,1000	LO	Single Value, Universal, WildCard		
Study Date	0008,0020	DA	Universal, Range, Universal		
Study Time	0008,0030	TM	Universal		
Accession Number	0008,0050	SH	Universal		
Study Instance UID	0020,000D	UI	Unique		
Study ID	0020,0010	SH	Universal		
Series Level Keys					
Modality	0008,0060	CS	Universal		
Series Instance UID	0020,000E	UI	Unique		
Series Number	0020,0011	IS	Universal		

This part of the section includes the dataset specific behavior, i.e. error codes, error and exception handling, time-outs, etc.

Table 52: Status Response

Service Status	Error Code	Further Meaning	Behavior
Success	0000	Matching is complete	The find results are displayed.
Failure	A700	Refused - Out of resources	No find results are displayed. The reason is logged.
	A900	Failed - Identifier does not match SOP class	No find results are displayed. The reason is logged.
	Cxxx	Failed - Unable to process	No find results are displayed. The reason is logged.
Cancel	FE00	Matching terminated due to Cancel Request	No find results are displayed. The reason is logged.
Pending	FF00	Matches are continuing - Current match is supplied and any optional keys were supported in the same manner as required keys	The find command continues.
	FF01	Matches are continuing - Warning that one or more optional keys were not supported for existence and/or matching for this identifier	The find command continues.

4.2.2.3.2. (Real-World) Activity – MOVE as SCU

4.2.2.3.2.1. Description and Sequencing of Activities

When the matching images are displayed in a patient folder, the required images can be selected for copying to the Image Viewer using the copy tool in the data handling facility. For each copy request the Image Viewer AE initiates an association to the selected peer entity (Archive) and uses it to send Retrieve (C-MOVE) requests and receive subsequent responses; an examination may contain both images and presentation states. The association is released after the final Retrieve (C-MOVE) response for the related request has been received (no more pending).

Refer Figure 13: Sequencing of RWA Query/Retrieve Image.

4.2.2.3.2.2. Proposed Presentation Contexts

The presentation contexts are defined in the next table.

Table 53: Acceptable Presentation Contexts for (Real-World) Activity – MOVE as SCU

Presentation Context Table					
Abstract Syntax		Transfer Syntax		Role	Extended Negotiation
Name	UID	Name List	UID List		
Study Root QR information Model – MOVE SOP Class	1.2.840.10008.5.1.4.1.2.2.2	Explicit VR Little Endian	1.2.840.10008.1.2.1	SCU	None
		Implicit VR Little Endian	1.2.840.10008.1.2		
		Explicit VR Big Endian	1.2.840.10008.1.2.2		

Note: For performance reasons the ELE transfer is preferred.

4.2.2.3.2.3. SOP Specific Conformance for Study Root QR Information Model – MOVE SOP Class

This section and sub-section includes the manufacturer SOP and Dataset specific information as well the status codes and their corresponding behavior.

4.2.3.2.3.1. Dataset Specific Conformance for Study Root QR Information Model – MOVE SOP Class SCU

Details regarding the Dataset Specific response behavior will be reported in this section

Table 54: C-MOVE-RQ Dataset Specification.

Patient Root QR Information Model - MOVE SOP Class				
Attribute Name	Tag	VR	Comment	
Query/Retrieve Level	0008,0052	CS	STUDY	
Q/R Study level				
Study Instance UID	0020,000D	UI		
Q/R Series level				
Series Instance UID	0020,000E	UI		
Study Instance UID	0020,000D	UI		

This part of the section includes the dataset specific behavior, i.e. error codes, error and exception handling, time-outs, etc.

Table 55: Status Response

Service Status	Error Code	Further Meaning	Behavior
Success	0000	Sub-operations complete - No Failures	The move job is marked as completed. The association is released.
Failure	A701	Refused - Out of Resources - Unable to Calculate number of matches	The move job is marked as failed. The association is released. The reason is logged and reported to the user.
	A702	Refused - Out of Resources - Unable to perform Sub-operations	The move job is marked as failed. The association is released. The reason is logged and reported to the user.
	A801	Refused - Move Destination unknown	The move job is marked as failed. The association is released. The reason is logged and reported to the user.
	A900	Failed - Identifier does not match SOP class	The move job is marked as failed. The association is released. The reason is logged and reported to the user.
	Cxxx	Failed - Unable to process	The move job is marked as failed. The association is released. The reason is logged and reported to the user.
Cancel	FE00	Sub-operations terminated due to Cancel Indication	The move job is marked as failed. The association is released. The reason is logged and reported to the user.
Warning	B000	Sub-operations complete - One or more Failures	The move job is marked as completed. The association is released.
Pending	FF00	Sub-operations are continuing	The move job continues.

4.2.2.4. Association Acceptance Policy

The Application Entity may reject Association attempts as shown in the table below.

Table 56: Association Reject Reasons

Result	Source	Reason/Diagnosis	Behavior
1 - rejected permanent	1 - DICOM UL service-user	1 - no-Reason-given	Message is logged.
		2 - application-context-name-not-supported	Message is logged.
		3 - calling-AE-title-not-recognized	Message is logged.
		7 - called-AE-title-not-recognized	Message is logged.
	2 - DICOM UL service provider (ACSE related function)	1 - no-reason-given	Message is logged.
		2 - protocol-version-not-supported	Message is logged.

Result	Source	Reason/Diagnosis	Behavior
2 - Rejected-transient	3 - DICOM UL service provider (Presentation related function)	1 - temporary-congestion	Message is logged.
		2 - local-limit-exceeded	Message is logged.
	1 - DICOM UL service-user	1 - no-Reason-given	Message is logged.
		2 - application-context-name-not-supported	Message is logged.
		3 - calling-AE-title-not-recognized	Message is logged.
	2 - DICOM UL service provider (ACSE related function)	7 - called-AE-title-not-recognized	Message is logged.
		1 - no-reason-given	Message is logged.
	3 - DICOM UL service provider (Presentation related function)	2 - protocol-version-not-supported	Message is logged.
		1 - temporary-congestion	Message is logged.
2 - local-limit-exceeded		Message is logged.	

The behavior of the AE for sending an association abort is summarized in next table

Table 57: Association Abort Policies

Source	Reason/Diagnosis	Behavior
0 - DICOM UL service-user (initiated abort)	0 - reason-not-specified	Message is logged.
2 - DICOM UL service-provider (initiated abort)	0 - reason-not-specified	Message is logged.
	1 - unrecognized-PDU	Message is logged.
	2 - unexpected-PDU	Message is logged.
	4 - unrecognized-PDU parameter	Message is logged.
	5 - unexpected-PDU parameter	Message is logged.
	6 - invalid-PDU-parameter value	Message is logged.

4.2.2.4.1. (Real-World) Activity – Verification as SCP

4.2.2.4.1.1. Description and Sequencing of Activities

The Image Viewer AE accepts associations from configured systems that wish to verify application level communication using the C-ECHO command.

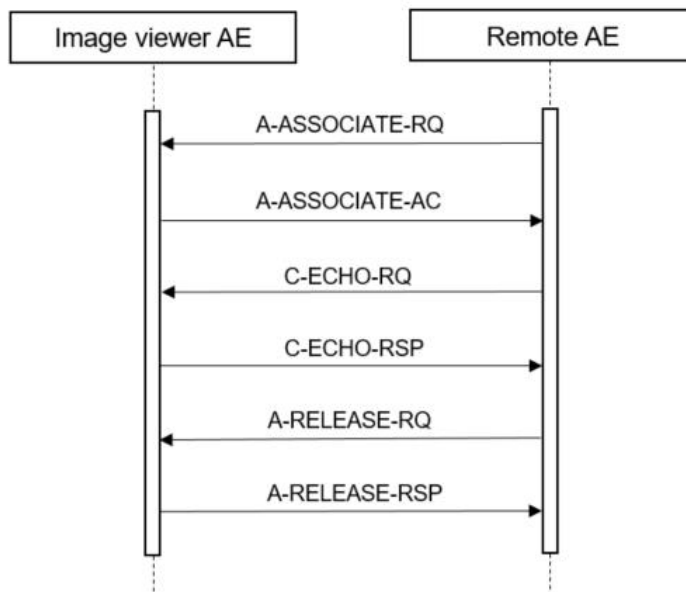

Figure 12: (Real World) Activity – Verification as SCP

4.2.2.4.1.2. Accepted Presentation Contexts

The presentation contexts are defined in the table below

Table 58: Acceptable Presentation Contexts for (Real-World) Activity – Verification as SCP

Presentation Context Table					
Abstract Syntax		Transfer Syntax		Role	Extended Negotiation
Name	UID	Name List	UID List		
Verification SOP Class	1.2.840.10008.1.1	Explicit VR Little Endian	1.2.840.10008.1.2.1	SCP	None
		Implicit VR Little Endian	1.2.840.10008.1.2		
		Explicit VR Big Endian	1.2.840.10008.1.2.2		

4.2.2.4.1.3. SOP Specific Conformance for Verification SOP Class

This section and sub-section include the manufacturer SOP and Dataset specific information as well the status codes and their corresponding behavior.

4.2.1.3.1.3.1. Dataset Specific Conformance for Verification C-ECHO SCP

Details regarding the Dataset Specific response behavior will be reported in this section.

This part of the section includes the dataset specific behavior, i.e. error codes, error and exception handling, time-outs, etc.

Table 59: Status Response

Service Status	Error Code	Further Meaning	Behavior
Success	0000	Confirmation	Standard verification response.

4.2.2.4.2. (Real-World) Activity – Image Import

4.2.2.4.2.1. Description and Sequencing of Activities

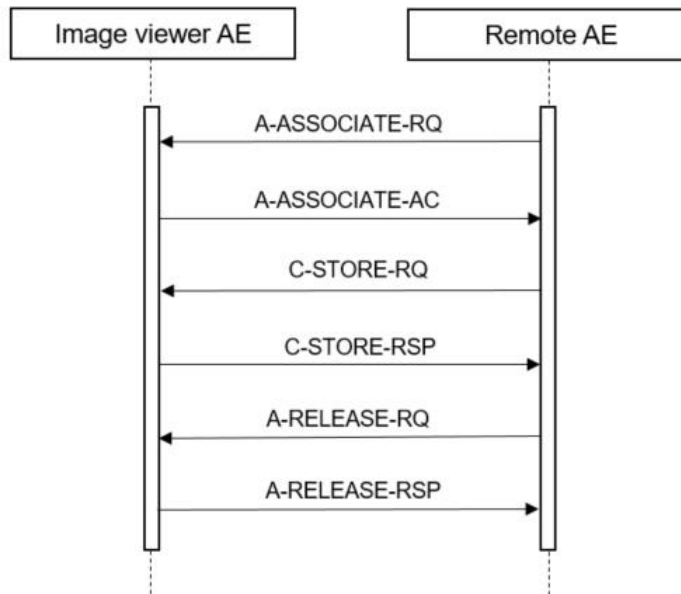

Figure 13: (Real World) Activity - Image Import

For each import request the Image Viewer AE accepts an association from the selected peer entity (Archive) and uses it to receive image Storage (C-STORE) requests and send subsequent responses. On request of the Storage SCU (Archive) the association is released.

4.2.2.4.2.2. Accepted Presentation Contexts

The presentation contexts are defined in the next table.

Table 60: Acceptable Presentation Contexts for (Real-World) Activity – Image Import

Presentation Context Table					
Abstract Syntax		Transfer Syntax		Role	Extended Negotiation
Name	UID	Name List	UID List		
Computed Radiography Image Storage SOP Class	1.2.840.10008.5.1.4.1.1.1	Explicit VR Big Endian	1.2.840.10008.1.2.2	SCP	None
		Explicit VR Little Endian	1.2.840.10008.1.2.1		
		Implicit VR Little Endian	1.2.840.10008.1.2		
CT Image Storage SOP Class	1.2.840.10008.5.1.4.1.1.2	Explicit VR Big Endian	1.2.840.10008.1.2.2	SCP	None
		Explicit VR Little Endian	1.2.840.10008.1.2.1		
		Implicit VR Little Endian	1.2.840.10008.1.2		
Digital X-Ray Image Storage - For Pres. SOP	1.2.840.10008.5.1.4.1.1.1.1	Explicit VR Big Endian	1.2.840.10008.1.2.2	SCP	None
		Explicit VR Little Endian	1.2.840.10008.1.2.1		
		Implicit VR Little Endian	1.2.840.10008.1.2		
Basic Text SR Storage SOP Class	1.2.840.10008.5.1.4.1.1.88.11	Explicit VR Big Endian	1.2.840.10008.1.2.2	SCP	None
		Explicit VR Little Endian	1.2.840.10008.1.2.1		
		Implicit VR Little Endian	1.2.840.10008.1.2		
	1.2.840.10008.5.1.4.1.1.88.22	Explicit VR Big Endian	1.2.840.10008.1.2.2	SCP	None

Presentation Context Table					
Abstract Syntax		Transfer Syntax		Role	Extended Negotiation
Name	UID	Name List	UID List		
Enhanced SR Storage SOP Class		Explicit VR Little Endian	1.2.840.10008.1.2.1		
		Implicit VR Little Endian	1.2.840.10008.1.2		
Comprehensive SR Storage SOP Class	1.2.840.10008.5.1.4.1.1.88.33	Explicit VR Big Endian	1.2.840.10008.1.2.2	SCP	None
		Explicit VR Little Endian	1.2.840.10008.1.2.1		
		Implicit VR Little Endian	1.2.840.10008.1.2		
Key Object Selection Document Storage SOP Class	1.2.840.10008.5.1.4.1.1.88.59	Explicit VR Big Endian	1.2.840.10008.1.2.2	SCP	None
		Explicit VR Little Endian	1.2.840.10008.1.2.1		
		Implicit VR Little Endian	1.2.840.10008.1.2		
Digital X-Ray Image Storage - For Processing	1.2.840.10008.5.1.4.1.1.1.1.1	Explicit VR Big Endian	1.2.840.10008.1.2.2	SCP	None
		Explicit VR Little Endian	1.2.840.10008.1.2.1		
		Implicit VR Little Endian	1.2.840.10008.1.2		
PET Image Storage SOP Class	1.2.840.10008.5.1.4.1.1.128	Explicit VR Big Endian	1.2.840.10008.1.2.2	SCP	None
		Explicit VR Little Endian	1.2.840.10008.1.2.1		
		Implicit VR Little Endian	1.2.840.10008.1.2		
Digital Mammography X-Ray Image Storage - Pres. SOP	1.2.840.10008.5.1.4.1.1.1.2	Explicit VR Big Endian	1.2.840.10008.1.2.2	SCP	None
		Explicit VR Little Endian	1.2.840.10008.1.2.1		
		Implicit VR Little Endian	1.2.840.10008.1.2		
Digital Mammography X-Ray Image Storage - Proc. SOP	1.2.840.10008.5.1.4.1.1.1.2.1	Explicit VR Big Endian	1.2.840.10008.1.2.2	SCP	None
		Explicit VR Little Endian	1.2.840.10008.1.2.1		
		Implicit VR Little Endian	1.2.840.10008.1.2		
NM Image Storage SOP Class	1.2.840.10008.5.1.4.1.1.20	Explicit VR Big Endian	1.2.840.10008.1.2.2	SCP	None
		Explicit VR Little Endian	1.2.840.10008.1.2.1		
		Implicit VR Little Endian	1.2.840.10008.1.2		
12-lead ECG Waveform Storage SOP Class	1.2.840.10008.5.1.4.1.1.9.1.1	Explicit VR Big Endian	1.2.840.10008.1.2.2	SCP	None
		Explicit VR Little Endian	1.2.840.10008.1.2.1		
		Implicit VR Little Endian	1.2.840.10008.1.2		
General ECG Waveform Storage SOP Class	1.2.840.10008.5.1.4.1.1.9.1.2	Explicit VR Big Endian	1.2.840.10008.1.2.2	SCP	None
		Explicit VR Little Endian	1.2.840.10008.1.2.1		
		Implicit VR Little Endian	1.2.840.10008.1.2		
Ambulatory ECG Waveform Storage SOP Class	1.2.840.10008.5.1.4.1.1.9.1.3	Explicit VR Big Endian	1.2.840.10008.1.2.2	SCP	None
		Explicit VR Little Endian	1.2.840.10008.1.2.1		
		Implicit VR Little Endian	1.2.840.10008.1.2		
Hemodynamic Waveform Storage SOP Class	1.2.840.10008.5.1.4.1.1.9.2.1	Explicit VR Big Endian	1.2.840.10008.1.2.2	SCP	None
		Explicit VR Little Endian	1.2.840.10008.1.2.1		
		Implicit VR Little Endian	1.2.840.10008.1.2		
Enhanced MR Image Storage SOP Class	1.2.840.10008.5.1.4.1.1.4.1	Explicit VR Big Endian	1.2.840.10008.1.2.2	SCP	None
		Explicit VR Little Endian	1.2.840.10008.1.2.1		
		Implicit VR Little Endian	1.2.840.10008.1.2		
RAW Data Image Storage SOP Class SOP Class	1.2.840.10008.5.1.4.1.1.166	Explicit VR Big Endian	1.2.840.10008.1.2.2	SCP	None
		Explicit VR Little Endian	1.2.840.10008.1.2.1		
		Implicit VR Little Endian	1.2.840.10008.1.2		
Brachy Treatment Record Storage SOP Class	1.2.840.10008.5.1.4.1.1.481.6	Explicit VR Big Endian	1.2.840.10008.1.2.2	SCP	None
		Explicit VR Little Endian	1.2.840.10008.1.2.1		
		Implicit VR Little Endian	1.2.840.10008.1.2		

Presentation Context Table					
Abstract Syntax		Transfer Syntax		Role	Extended Negotiation
Name	UID	Name List	UID List		
RT Treatment Summary Record Storage SOP Class	1.2.840.10008.5.1.4.1.1.481.7	Explicit VR Big Endian	1.2.840.10008.1.2.2	SCP	None
		Explicit VR Little Endian	1.2.840.10008.1.2.1		
		Implicit VR Little Endian	1.2.840.10008.1.2		
MRSpectroscopy Storage SOP Class	1.2.840.10008.5.1.4.1.1.4.2	Explicit VR Big Endian	1.2.840.10008.1.2.2	SCP	None
		Explicit VR Little Endian	1.2.840.10008.1.2.1		
		Implicit VR Little Endian	1.2.840.10008.1.2		
Multi-frame Single Bit Secondary Capture Image Storage	1.2.840.10008.5.1.4.1.1.7.1	Explicit VR Big Endian	1.2.840.10008.1.2.2	SCP	None
		Explicit VR Little Endian	1.2.840.10008.1.2.1		
		Implicit VR Little Endian	1.2.840.10008.1.2		
Multi-frame Grayscale Byte Secondary Capture Image Storage	1.2.840.10008.5.1.4.1.1.7.2	Explicit VR Big Endian	1.2.840.10008.1.2.2	SCP	None
		Explicit VR Little Endian	1.2.840.10008.1.2.1		
		Implicit VR Little Endian	1.2.840.10008.1.2		
Multi-frame Grayscale Word Secondary Capture Image Storage SOP Class	1.2.840.10008.5.1.4.1.1.7.3	Explicit VR Big Endian	1.2.840.10008.1.2.2	SCP	None
		Explicit VR Little Endian	1.2.840.10008.1.2.1		
		Implicit VR Little Endian	1.2.840.10008.1.2		
Multi-frame True Color Secondary Capture Image Storage SOP Class	1.2.840.10008.5.1.4.1.1.7.4	Explicit VR Big Endian	1.2.840.10008.1.2.2	SCP	None
		Explicit VR Little Endian	1.2.840.10008.1.2.1		
		Implicit VR Little Endian	1.2.840.10008.1.2		
RT Image Storage SOP Class Storage SOP Class	1.2.840.10008.5.1.4.1.1.481.1	Explicit VR Big Endian	1.2.840.10008.1.2.2	SCP	None
		Explicit VR Little Endian	1.2.840.10008.1.2.1		
		Implicit VR Little Endian	1.2.840.10008.1.2		
RT Dose Storage SOP Class Storage SOP Class	1.2.840.10008.5.1.4.1.1.481.2	Explicit VR Big Endian	1.2.840.10008.1.2.2	SCP	None
		Explicit VR Little Endian	1.2.840.10008.1.2.1		
		Implicit VR Little Endian	1.2.840.10008.1.2		
RT Structure Set Storage SOP Class	1.2.840.10008.5.1.4.1.1.481.3	Explicit VR Big Endian	1.2.840.10008.1.2.2	SCP	None
		Explicit VR Little Endian	1.2.840.10008.1.2.1		
		Implicit VR Little Endian	1.2.840.10008.1.2		
RT Beams Treatment	1.2.840.10008.5.1.4.1.1.481.4	Explicit VR Big Endian	1.2.840.10008.1.2.2	SCP	None
		Explicit VR Little Endian	1.2.840.10008.1.2.1		
		Implicit VR Little Endian	1.2.840.10008.1.2		
RT Plan Storage Transfer	1.2.840.10008.5.1.4.1.1.481.5	Explicit VR Big Endian	1.2.840.10008.1.2.2	SCP	None
		Explicit VR Little Endian	1.2.840.10008.1.2.1		
		Implicit VR Little Endian	1.2.840.10008.1.2		
Workflow (private)	1.3.46.670589.2.9.1.1	Explicit VR Big Endian	1.2.840.10008.1.2.2	SCP	None
		Explicit VR Little Endian	1.2.840.10008.1.2.1		
		Implicit VR Little Endian	1.2.840.10008.1.2		
Specimen	Supplement 122 + CP800	Explicit VR Big Endian	1.2.840.10008.1.2.2	SCP	None
		Explicit VR Little Endian	1.2.840.10008.1.2.1		
		Implicit VR Little Endian	1.2.840.10008.1.2		
Surface Segmentation Storage SOP Class	1.2.840.10008.5.1.4.1.1.66.5	Explicit VR Big Endian	1.2.840.10008.1.2.2	SCP	None
		Explicit VR Little Endian	1.2.840.10008.1.2.1		
		Implicit VR Little Endian	1.2.840.10008.1.2		

Presentation Context Table					
Abstract Syntax		Transfer Syntax		Role	Extended Negotiation
Name	UID	Name List	UID List		
X-Ray 3D Craniofacial Image Storage SOP Class	1.2.840.10008.5.1.4.1.1.13.1.2	Explicit VR Big Endian Explicit VR Little Endian Implicit VR Little Endian	1.2.840.10008.1.2.2 1.2.840.10008.1.2.1 1.2.840.10008.1.2	SCP	None
Enhanced PET Storage SOP Class	1.2.840.10008.5.1.4.1.1.130	Explicit VR Big Endian Explicit VR Little Endian Implicit VR Little Endian	1.2.840.10008.1.2.2 1.2.840.10008.1.2.1 1.2.840.10008.1.2	SCP	None
Grayscale Softcopy Presentation State Storage SOP Class	1.2.840.10008.5.1.4.1.1.11.1	Explicit VR Big Endian Explicit VR Little Endian Implicit VR Little Endian	1.2.840.10008.1.2.2 1.2.840.10008.1.2.1 1.2.840.10008.1.2	SCP	None
X-Ray Angiographic Image Storage SOP Class	1.2.840.10008.5.1.4.1.1.12.1	Explicit VR Big Endian Explicit VR Little Endian Implicit VR Little Endian	1.2.840.10008.1.2.2 1.2.840.10008.1.2.1 1.2.840.10008.1.2	SCP	None
X-Ray Radiofluoroscopic Image Storage SOP Class	1.2.840.10008.5.1.4.1.1.12.2	Explicit VR Big Endian Explicit VR Little Endian Implicit VR Little Endian	1.2.840.10008.1.2.2 1.2.840.10008.1.2.1 1.2.840.10008.1.2	SCP	None
Ultrasound Multi-frame Image Storage SOP Class	1.2.840.10008.5.1.4.1.1.3.1	Explicit VR Big Endian Explicit VR Little Endian Implicit VR Little Endian	1.2.840.10008.1.2.2 1.2.840.10008.1.2.1 1.2.840.10008.1.2	SCP	None
MR Image Storage SOP Class	1.2.840.10008.5.1.4.1.1.4	Explicit VR Big Endian Explicit VR Little Endian Implicit VR Little Endian	1.2.840.10008.1.2.2 1.2.840.10008.1.2.1 1.2.840.10008.1.2	SCP	None
Ultrasound Image Storage SOP Class	1.2.840.10008.5.1.4.1.1.6.1	Explicit VR Big Endian Explicit VR Little Endian Implicit VR Little Endian	1.2.840.10008.1.2.2 1.2.840.10008.1.2.1 1.2.840.10008.1.2	SCP	None
Secondary Capture Image Storage SOP Class	1.2.840.10008.5.1.4.1.1.7	Explicit VR Big Endian Explicit VR Little Endian Implicit VR Little Endian	1.2.840.10008.1.2.2 1.2.840.10008.1.2.1 1.2.840.10008.1.2	SCP	None
PIIM specialized Presentation State	1.3.46.670589.2.2.1.1	Explicit VR Big Endian Explicit VR Little Endian Implicit VR Little Endian	1.2.840.10008.1.2.2 1.2.840.10008.1.2.1 1.2.840.10008.1.2	SCP	None
XRAY Specialized	1.3.46.670589.2.3.1.1	Explicit VR Big Endian Explicit VR Little Endian Implicit VR Little Endian	1.2.840.10008.1.2.2 1.2.840.10008.1.2.1 1.2.840.10008.1.2	SCP	None

Note: For performance reasons the ELE transfer syntax is preferred and shall be chosen in case multiple transfer syntaxes are proposed in the association negotiation.

The Image Viewer AE shall accept all contexts in the intersection of the proposed and acceptable presentation contexts. This means that the Image Viewer AE accepts multiple proposed presentation contexts with the same SOP class but different transfer syntaxes. There is no check for duplicate contexts, and these will therefore be accepted.

4.2.4.2.3. SOP Specific Conformance for Storage SOP Classes

This section and sub-section include the manufacturer SOP and Dataset specific information as well the status codes and their corresponding behavior.

The Image Viewer AE provides standard level 1 (Base) conformance to the Storage service class.

If the Image Viewer AE imports an image and during the association negotiation the presentation state SOP class was not negotiated, then the Image Viewer AE creates a presentation state instance for the imported image.

The Image Viewer AE standard supports the photometric interpretations MONOCHROME1, MONOCHROME2, and RGB.

4.2.2.4.2.3.1 Dataset Specific Conformance for C-STORE-RSP

Details regarding the Dataset Specific response behavior will be reported in this section.

Table 61: Status Response

Service Status	Error Code	Further Meaning	Behavior
Success	0000	Successful stored	The images are stored in the Image Viewer AE database.
Failure	A7xx	Refused: Out of Resources	The Image Viewer AE database is full - recovery from this condition is left to the SCU. The Image Viewer AE sends a notification, log the condition, and abort the association.
	A9xx	Error: Data Set does not match SOP Class	The SOP class of the image(s) does not match the negotiated abstract syntax. The Image Viewer AE sends a notification, log the condition, and abort the association.
	C000	Error: cannot understand	The image(s) cannot be parsed. The Image Viewer AE sends a notification, log the condition, and abort the association.
Warning	B000	Coercion of Data Elements	N/A
	B007	Data Set does not match SOP Class	N/A
	B006	Elements Discarded	N/A

4.3. Network Interfaces

4.3.1. Physical Network Interfaces

The Mobile C-Arm provides DICOM 3.0 TCP/IP Network Communication Support as defined in [DICOM] PS 3.8.

For the Mobile C-Arm AE the TCP/IP stack is inherited from the Windows 7 operating system.

For the Image Viewer the TCP/IP stack is inherited from the Windows 7 operating system.

The Mobile C-Arm supports Ethernet (ISO 8802-3) and IEEE 802.3 (10 / 100 /1000BASE-T) for the printer and image interfaces.

The Mobile C-Arm supports radio communication according to IEEE 802.11a/b/g/n/ac from 2.4GHz to 5GHz MHz according to FCC regulations.

4.3.2. Additional Protocols

Not applicable

4.4. Configuration

Any implementation's DICOM conformance may be dependent upon configuration, which takes place at the time of installation. Issues concerning configuration are addressed in this section.

4.4.1. AE Title/Presentation Address Mapping

Notes:

- The configuration of a Mobile C-Arm AE is done by means of PSC tools.
- The configuration of a Image Viewer AE is done by means of a configuration program, which is accessible at start-up (password protected, intended to be used by Philips Customer Support Engineers only).

An important installation issue is the translation from AE title to presentation address. How this is to be performed is describe here.

4.4.1.1. Local AE Titles

Per default the Mobile C-Arm AE Application Entity Title is "No Name". At installation the Customer Support Engineer can change the host name. The Mobile C-Arm AE can be changed independently.

Table 62: AE Title configuration table

Application Entity	Default AE Title	Default TCP/IP Port
Mobile C-Arm AE	"No Name"	8104 (Storage Commitment, fixed)
Image Viewer AE	"MySCU"	104

4.4.1.2. Remote AE Title/Presentation Address Mapping

Specified is here the configuration of the remote application.

Remote Association Initiators

The following information must be provided for all relevant remote applications that are able to initiate DICOM associations to the Zenition 70:

- The Application Entity Title.
- The host name/IP address on which the remote application resides
- The port number at which the remote application has to send association requests
- The SOP classes and transfer syntaxes for which the Image Viewer AE accepts associations.

Remote Association Acceptors

The following information must be provided for all relevant remote applications that are able to accept DICOM associations from Mobile C-Arm AE:

- The Application Entity Title.
- The host name/IP address on which the remote application resides.
- The port number at which the remote application accepts association requests.

4.4.2. Parameters

The specification of important operational parameters, and if configurable, their default value and range, are specified here.

The configuration parameters of the Mobile C-Arm AE are given in the following table, categorized in the following sections:

- Local System Parameters
- Export Target(s) (Store) Parameters
- Export Target(s) (RDSR) Parameters
- Export Target(s) (Print) Parameters
- Worklist Management Target Parameters
- MPPS Target Parameters
- Storage commit (N-EVENT-REPORT) Parameters

Table 63: Configuration Parameters Table for Mobile C-Arm AE

Parameter	Configurable	Default Value
AE Specific Parameters		
SOP Class support	Yes	MPPS, Storage Commitment, Printer,X-ray Angiographic Image SOP Class.
Local System Parameters		
AE Title	Yes	"No Name"
Host Name	Yes	"No Name"
IP Address	Yes	0.0.0.0
Subnet Mask	Yes	0.0.0.0
Default Gateway	Yes	0.0.0.0
Interpolation (on/off)	Yes	On
Max. PDU size	Yes	28672 (4..256 kb)
Receive Message Timeout	Yes	60 [s] (0..3600 s)
Association Close Timeout	Yes	1 [s] (0..3600 s)
Association Reply Timeout	Yes	60 [s] (0..3600 s)
Association Release Timeout	Yes	60 [s] (0..3600 s)
Network Write Timeout	Yes	60 [s] (0..3600 s)
Network Connect Timeout	Yes	60 [s] (0..3600 s)
Network Inactivity Timeout	Yes	60 [s] (0..3600 s)
Export Target(s) (Store) Parameters		
AE Title	Yes	"No Name"
Name	Yes	Max. 25 char. Unique
IP Address	Yes	0.0.0.0
Port number	Yes	104
Type	Yes	STORE
Storage Commit - AE Title	Yes	"No Name"
Storage Commit - IP Address	Yes	0.0.0.0
Storage Commit - Port number	Yes	104
Export Triggers MPPS	Yes	"No"
Storage Commit - Enable/Disable	Yes	Disable
Export Target(s) (Print) Parameters		
AE Title	Yes	"No Name"
Name	Yes	Max. 25 char. Unique
IP Address	Yes	0.0.0.0
Port number	Yes	104
Type	Yes	PRINT
Printer type	Yes	Predefined List
Printer Priority	Yes	LOW
Film Destination	Yes	CURRENT
Film Orientation	Yes	PORTRAIT
Film Size	Yes	CURRENT
Border Density	Yes	BLACK
Border Density Value	Yes	1
Number of Copies	Yes	1
Magnification Type	No	Depending on Printer Type
Smoothing Type	No	Depending on Printer Type
Minimum Density	No	Depending on Printer Type
Maximum Density	No	Depending on Printer Type

Parameter	Configurable	Default Value
Empty Image Density	No	Depending on Printer Type
Polarity	No	Depending on Printer Type
Trim	No	Depending on Printer Type
Configuration Information	No	Depending on Printer Type
Export Target(s) (X-Ray Radiation Dose) Parameters		
Enable DICOM Structured Dose Report	Yes	No
Target 1 configuration		
Name	Yes	"No name"
AE Title	Yes	"No name"
IP address	Yes	0.0.0.0
Port number	Yes	104
Storage Commit	Yes	Enable
SC AE Title	Yes	"No name"
SC IP address	Yes	0.0.0.0
SC Port Number	Yes	104
Target 2 configuration		
Name	Yes	"No name"
Enable	Yes	No
AE Title	Yes	"No name"
IP address	Yes	0.0.0.0
Port number	Yes	104
Target 3 configuration		
Name	Yes	"No name"
Enable	Yes	No
AE Title	Yes	"No name"
IP address	Yes	0.0.0.0
Port number	Yes	104
Worklist Management Target Parameters		
AE Title	Yes	"No Name"
Name	Yes	Max. 25 char. Unique
IP Address	Yes	0.0.0.0
Port Number	Yes	104
Type	Yes	MWL
Select Query	Yes	Predefined Query List, maximum 4 items in the list
Define Query	Yes	Defines the queries that can be selected
MPPS Target Parameters		
AE Title	Yes	"No Name"
Name	Yes	Max. 25 char. Unique
IP Address	Yes	0.0.0.0
Port Number	Yes	104
Type	Yes	MPPS
Protocol Names	Yes	List of Protocol Names that can be selected in the MPPS panel
Enable Append Case	Yes	"Yes"
MPPS also for unscheduled cases	Yes	"Yes"
Storage commit (N-EVENT-REPORT) Parameters		
AE Title	Yes	Local System AE Title
IP Address	Yes	Local System IP address

Parameter	Configurable	Default Value
Port Number	No	Fixed: 8104

Note: Parameters that are part of a specific DICOM IOD are specified in section 4 and 8.

Table 64: Configuration Parameters table for Image Viewer AE

Parameter	Configurable	Default Value
General Parameter		
Time-out waiting for acceptance or rejection Response to an Association Open Request (Application Level timeout)	Yes	30 [s]
General Dimse level time-out values (Verification, Storage, Storage Commitment)	No	-
AE Specific Parameters		
Size constraint in maximum object size	No	-
Maximum PDU size the AE can send and receive	Yes	0 (maximum value is 65535 bytes)
Number of simultaneous associations by service and/or SOP class	Yes	50
SOP Class support	Yes	All supported SOP classes
Storage commitment – Synchronous/ Asynchronous	Yes	-
Asynchronous Storage Commitment timeout value	Yes	- (Value in hours)
Transfer Syntax support*	Yes	ELE - 1.2.840.10008.1.2.1 EBE - 1.2.840.10008.1.2.2 ILE - 1.2.840.10008.1.2 JPEG Lossless (NH-FOP) - 1.2.840.10008.1.2.4.70 JPEG Baseline - 1.2.840.10008.1.2.4.50 JPEG 2000 (Lossless Only) - 1.2.840.10008.1.2.4.90 RLE - 1.2.840.10008.1.2.5
IsArchive	Yes	False

***Note:**
 Although it is possible to configure encapsulation transfer syntax for every SOP class, encapsulation transfer syntax is practically not applicable for SOP classes that contain no data to be encoded and such transfer syntax should therefore be omitted. Also note that the order of the specified transfer syntaxes for a SOP class or AE in the configuration determines the preference order of proposed transfer syntaxes. Per default all transfer syntaxes are enabled. Take care that certain presentation context are not practical. Some transfer syntaxes may only be used on certain datasets, and should not be proposed for other datasets. E.g. never propose lossy JPEG compression for 16 bits images as this is not applicable. Currently JPEG Extended is applicable to 12 bits images only (process 4).

5. Media Interchange

5.1. Implementation model

The implementation model identifies the DICOM Application Entities for Media in specific implementation and relates the Application Entities to Real-World Activities.

5.1.1. Application Data Flow Diagram

The DICOM media interchange implementation of the Mobile Surgery Systems is implemented in the Image Viewer AE and Mobile C-Arm AE. The following figure shows the Media Interchange Application Data Flow as a functional overview of the Image Viewer AE and Mobile C-Arm AE for CD, DVD and USB.

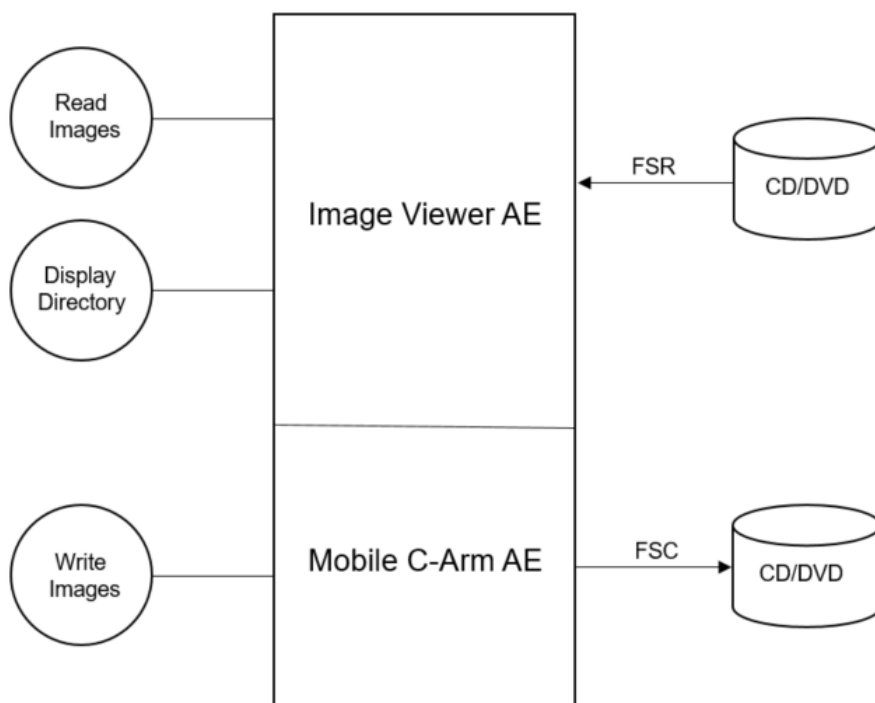

Figure 14: Application Data Flow Diagram (Image Viewer AE and Mobile C-Arm AE)

The Image Viewer AE will act as a FSR, for CD\DVD and USB media, when reading the directory of the medium. The Mobile C-Arm AE will act as a FSC for a CD\DVD and USB, when writing the selected images in a patient folder onto the medium.

The Mobile Surgery System supports the media profiles as shows in the table below.

Table 65: Media Profiles supported by Mobile C-Arm AE and Image Viewer AE

Application Profile	CD	DVD+RW / DVD+R	USB
General Purpose	STD-GEN-CD	STD-GEN-DVD	STD-GEN-USB

Supported Photometric Interpretations:

The Mobile Surgery Systems supports images with the following DICOM Photometric Interpretations as shows in the table below.

© 2020 Koninklijke Philips N.V.

Table 66: Photometric interpretations supported by Mobile Surgery Systems

Photometric Interpretation	Import	Export	Viewing
MONOCHROME1	YES	YES	YES
MONOCHROME2	YES	YES	YES
RGB	YES	YES	YES

5.1.2. Functional Definitions of AE's

This section contains the functional definition of each individual local Media Application Entity.

The Mobile surgery system implements the following functions for DICOM media.

DICOM Media Storage Service Class for CD, DVD and USB media:

The Mobile surgery system can perform the CD DICOM Media Storage service as SCP, with capabilities for:

- RWA Display Directory (as FSR),
- RWA Write Images (as FSC), and
- RWA Read Images (as FSR).

The Mobile surgery system can perform the DVD DICOM Media Storage service as SCP, with capabilities for:

- RWA Display Directory (as FSR),
- RWA Write Images (as FSC), and
- RWA Read Images (as FSR).

The Mobile surgery system can perform the USB DICOM Media Storage service as SCP, with capabilities for:

- RWA Display Directory (as FSR),
- RWA Write Images (as FSC), and
- RWA Read Images (as FSR).

5.1.3. Sequencing of Real World Activities

This section contains a description of sequencing of Real-World Activities that the Media Application Entities require.

Whenever DICOM Media (CD or DVD) is written, the DICOMDIR file along with DCM files are created. The Mobile C-Arm AE will compile the updated DICOMDIR and any required DICOM images into a CD or DVD session image; this session image will be written to the DICOM Media.

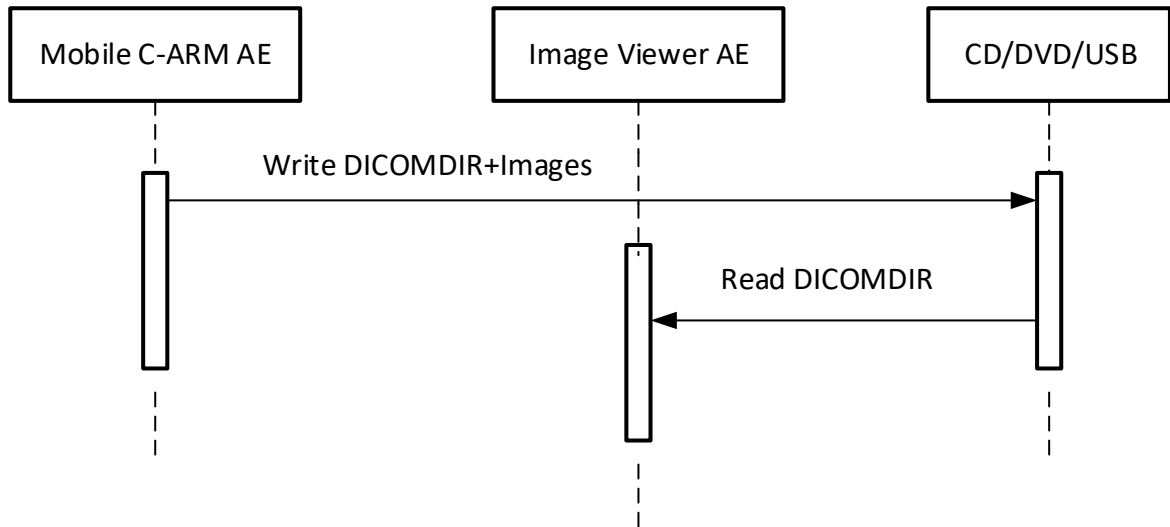

Figure 15: Sequencing of RWA Write and Read Image

Note that after the DVD Media is written the DVD will be finalized by Mobile C-Arm AE to guarantee the readability on the most DVD reader.

5.2. AE Specifications

This section in the DICOM Conformance Statement specifies a set of Media Application Entities.

5.2.1. Mobile Surgery System Media - Specification

This section contains general policies that apply to all of the Application Entities described in subsequent section.

The Image Viewer AE provides standard conformance to the DICOM interchange option of the Media Storage service class, and follows the specifications as defined in [DICOM] Media Storage and File Format for Data Interchange (PS 3.10) the Media Storage Application Profiles STD-GEN-CD, STD-GEN-USB-JPEG ([DICOM] PS 3.11) and the Media Storage Application Profiles STD-GEN-DVD-JPEG ([DICOM] PS 3.12) for Reading and writing to media is supported by Mobile C-Arm AE.

The Image Viewer AE supports multi-patient and multi-session for CD/DVD, for reading and Mobile C-Arm AE supports writing. Supported media by Image Viewer AE and Mobile C-Arm AE are:

- For CD: CDR / CD RW with the profile: STD-GEN-CD
- For DVD: DVD+R and DVD+RW with the profile STD-GEN-DVD-JPEG and the Transfer Syntax ELE uncompressed
- DVD-R and DVD-RW can be used for both read for writing.

The Application Profiles and roles are listed below:

Table 67: Image Viewer AE related Application Profiles, RWA activities and roles

Supported Application Profile	Identifier	Real-World Activities	Roles
General Purpose CD-R Interchange	STD-GEN-CD	Read File-set	FSR
General Purpose DVD Interchange with JPEG	STD-GEN-DVD-JPEG	Read File-set	FSR
General Purpose USB Media Interchange with JPEG	STD-GEN-USB-JPEG	Read File-set	FSR

Table 68: Mobile C-Arm AE related Application Profiles, RWA activities and roles

Supported Application Profile	Identifier	Real-World Activities	Roles
General Purpose CD-R Interchange	STD-GEN-CD	Create File-set	FSC
General Purpose DVD Interchange with JPEG	STD-GEN-DVD-JPEG	Create File-set	FSC
General Purpose USB Media Interchange with JPEG	STD-GEN-USB-JPEG	Create File-set	FSC

5.2.1.1. File Meta Information for the Image Viewer AE

This section shall contain the values of the file Meta information that pertain to the Application Entity (see PS 3.10).

Table 69: File Meta Information for the Image Viewer AE

Implementation Class UID	1.3.46.670589.54.2.17.4
Implementation Version Name	17.4.0.0

5.2.1.2. File Meta Information for the Mobile C-Arm AE

This section shall contain the values of the file Meta information that pertain to the Application Entity (see PS 3.10).

Table 70: File Meta Information for the Mobile C-Arm AE

Implementation Class UID	1.3.46.670589.7.70.5.1
Implementation Version Name	5.1.x where 'x' is the detailed application version, i.e. 5.1.7, 5.1.8 etc.

5.2.1.3. Real-World Activities

The AE specification contains a description of the Real-World Activities, which invoke the particular AE.

5.2.1.3.1. RWA - Read File-set

This Media Application Entity has a File-set Reader functionality which is describe here.

Display Directory:

When a database Open action is initiated on DICOM media then the Image Viewer AE acts as an FSR using the interchange option to read the DICOMDIR of the DICOM media. This will result in an overview of the patients, studies, series, and images on the GUI.

Read Image:

When an image transfer from DICOM media is initiated then the Image Viewer AE acts as an FSR using the interchange option to import SOP instances from the DICOM media.

5.2.1.3.1.1. Media Storage Application Profile

The application Profile that is used by this Media Application Entity is specified in this section.

Display Directory:

The Image Viewer AE supports the RWA Display Directory for STD-GEN-DVD-JPEG, STD-GEN-USB-JPEG and the STD-GEN-CD application profiles.

Read Image:

The Image Viewer AE supports the RWA Read Image for STD-GEN-DVD-JPEG, STD-GEN-USB-JPEG and the STD-GEN-CD application profiles.

5.2.1.3.1.1.1 Options

The options used in the Application Profile are specified in detail in this section.

Display Directory:

The mandatory DICOMDIR keys are required for the correct display of directory information. The display is structured according the DICOM Composite Information Model: Patient, Study, Series, and Image.

Read Image:

The mandatory attributes of the DICOM images are required for the correct storage of the images in the local database. Optional attributes and retired/private attributes are stored too - if present; this is equivalent with the level 2 (Full) conformance for the Storage service class in the Network support.

5.2.1.3.2. RWA - Create File-set

This Media Application Entity has a File-set Creator functionality which is describe here.

When an image transfer to DICOM media is initiated then the Mobile C-Arm AE acts as an FSC using the interchange option to write SOP instances on the DICOM media.

5.2.1.3.2.1. Media Storage Application Profile

The application Profile that is used by this Media Application Entity is specified in this section.

The Mobile C-Arm AE supports the RWA Write Image for STD-GEN-DVD-JPEG, STD-GEN-USB-JPEG and the STD-GEN-CD application profiles. However, the Mobile C-Arm AE supports writing on DVD+R (W) and DVD-R (W) media.

5.2.1.3.2.1.1 Options

The options used in the Application Profile are specified in detail in this section.

The DICOMDIR file will be extended when new images are written. In case some attributes are not present in an image but are specified as mandatory in the DICOMDIR definition of DICOM media, a generated value will be filled in.

Implementation remarks and restrictions:

When writing the DICOMDIR records, key values are generated when no value of the corresponding attribute is supplied, according to the following table.

Table 71: Generated Keys

Key	Tag	Generated Value
Patient Keys		
Patient ID	0010,0020	
Study Keys		
Study Date	0008,0020	Current date
Study Time	0008,0030	Current time
Study ID	0020,0010	"UNKNOWN"
Series Keys		
Series Number	0020,0011	1
Image Keys		
Instance Number	0020,0013	1

The default value for (0028, 1040) Pixel Intensity Relationship is set to DISP.

5.3. Augmented and Private Application Profiles

This section is used for the description of Augmented and Private Application Profiles.

5.3.1. Augmented Application Profiles

None

5.3.1.1. Augmented Application Profile AUG-GEN-DVD-JPEG SOP Class Augmentations

As augmentation to the STD-GEN-DVD-JPEG application profile, also the SOP classes as per following table are supported.

Table 72: Additional SOP Classes supported by AUG-GEN-DVD-JPEG

SOP Class Name	SOP Class UID
X-Ray Specialization	1.3.46.670589.2.3.1.1
Stack of X-Ray	1.3.46.670589.2.4.1.1
Volume	1.3.46.670589.5.0.1.1
3D Volume Object	1.3.46.670589.5.0.2.1
Surface	1.3.46.670589.5.0.3.1
Cardio	1.3.46.670589.5.0.8.1
CT Synthetic Image	1.3.46.670589.5.0.9
MR Synthetic Image	1.3.46.670589.5.0.10
MR Cardio Analysis	1.3.46.670589.5.0.11.1
CX Synthetic Image	1.3.46.670589.5.0.12
Perfusion	1.3.46.670589.5.0.13
Perfusion Analysis	1.3.46.670589.5.0.14

5.3.1.2. Directory Augmentations

Not applicable.

5.3.1.3. Other Augmentations

Not applicable.

5.3.2. Private Application Profiles

Not applicable.

5.4. Media Configuration

Not applicable

6. Support of Character Sets

Any support for character sets in Network and Media services is described here.

Table 73: Supported DICOM Character Sets

Character Set Description	Defined Term	ESC Sequence	ISO Registration Number	Code Element	Character Set
Latin alphabet No. 1	ISO 2022 IR 100	ESC 02/08 04/02	ISO-IR 6	G0	ISO 646
		ESC 02/13 04/01	ISO-IR 100	G1	Supplementary set of ISO 8859
Default repertoire	ISO 2022 IR 6	-	ISO-IR 6	G0	ISO 646
		-	-	-	-
Latin alphabet No. 1	ISO_IR 100	-	ISO-IR 6	G0	ISO 646
		-	ISO-IR 100	G1	Supplementary set of ISO 8859
Default repertoire	-	-	ISO-IR 6	G0	ISO 646

If a WLM query response includes a Person Name attribute containing character code 5C (i.e. BACKSLASH "\" in ISO-IR 6) then all characters behind the character code 5C will be omitted (at GUI and export, i.e. will still be present in MPPS).

Unsupported character sets will be accepted, though all characters will be displayed as per ISO_IR 100, not confirming the actual character set specification.

7. Security

7.1. Security Profiles

This version of the Console does not satisfy the security as describe in the DICOM Standard.

7.1.1. Security use Profiles

Not implemented.

7.1.2. Security Transport Connection Profiles

Not implemented.

7.1.3. Digital Signature Profiles

Not implemented.

7.1.4. Media Storage Security Profiles

Not implemented.

7.1.5. Attribute Confidentiality Profiles

The Mobile C-Arm AE conforms to the Basic Application Level Confidentiality Profile as de-identifier.

De-identified SOP Instances will be created on DICOM Media if specified by the user.

No instances of the Encrypted Attributes Data Set are created. No transfer syntaxes are supported for encoding/decoding of Encrypted Attributes Data Sets.

The terms used to describe the replacement value in the anonymized patient data can be read as follows:

- COPY: Same value as in source data
- EMPTY: The attribute will have a value of zero length.
- ANP: Attribute Not Present
- n.a.: Not applicable, the attribute is not contained in the standard IOD of the Mobile C-Arm AE

The next table lists the protected data attributes.

Table 74: Basic Application Level Confidentiality Profile Attributes

Name	Tag	VR	Replacement Value
Instance Creator UID	0008,0014	UI	n.a.
SOP Instance UID	0008,0018	UI	New value is generated
Accession Number	0008,0050	SH	EMPTY
Institution Name	0008,0080	LO	ANP
Institution Address	0008,0081	ST	n.a.
Referring Physician's Name	0008,0090	PN	EMPTY
Referring Physician's Address	0008,0092	ST	n.a.
Referring Physician's Telephone Numbers	0008,0094	SH	n.a.
Station Name	0008,1010	SH	EMPTY
Study Description	0008,1030	LO	EMPTY
Series Description	0008,103E	LO	EMPTY
Institutional Department Name	0008,1040	LO	n.a.

Name	Tag	VR	Replacement Value
Physician(s) of Record	0008,1048	PN	n.a.
Performing Physicians' Name	0008,1050	PN	ANP
Name of Physician(s) Reading Study	0008,1060	PN	n.a.
Operators' Name (Technologist)	0008,1070	PN	n.a.
Admitting Diagnoses Description	0008,1080	LO	n.a.
Referenced SOP Instance UID	0008,1155	UI	COPY
Derivation Description	0008,2111	ST	n.a.
Patient's Name	0010,0010	PN	Patient Name has new generated value.
Patient ID	0010,0020	LO	In Patient Module the Patient ID value is "EMPTY". In the DIRECTORY RECORD: 0 (PATIENT) the Patient ID value has a new generated value
Patient's Birth Date	0010,0030	DA	EMPTY
Patient's Birth Time	0010,0032	TM	COPY
Patient's Sex	0010,0040	CS	EMPTY
Other Patient Ids	0010,1000	LO	COPY
Other Patient Names	0010,1001	PN	COPY
Patient's Age	0010,1010	AS	n.a.
Patient's Size	0010,1020	DS	n.a.
Patient's Weight	0010,1030	DS	Empty
Medical Record Locator	0010,1090	LO	n.a.
Ethnic Group	0010,2160	SH	n.a.
Occupation	0010,2180	SH	n.a.
Additional Patient's History	0010,21B0	LT	n.a.
Patient Comments	0010,4000	LT	n.a.
Device Serial Number	0018,1000	LO	Empty
Protocol Name	0018,1030	LO	Empty
Study Instance UID	0020,000D	UI	New value is generated
Series Instance UID	0020,000E	UI	New value is generated
Study ID	0020,0010	SH	EMPTY
Frame of Reference UID	0020,0052	UI	n.a.
Synchronization Frame of Reference UID	0020,0200	UI	n.a.
Image Comments	0020,4000	LT	n.a.
Requested Attributes Sequence	0040,0275	SQ	n.a.
UID	0040,A124	UI	n.a.
Content Sequence	0040,A730	SQ	n.a.
Storage Media File-set UID	0088,0140	UI	n.a.
Referenced Frame of Reference UID	3006,0024	UI	n.a.
Related Frame of Reference UID	3006,00C2	UI	n.a.

SOP Class Augmentations

DICOM media that have been written with the de-identification feature switched on (anonymized data) will have DICOM-format data.

In case of writing to CD, DVD or USB media, de-identification is supported. However, when the de-identification feature is active, also Secondary Capture images are written to the DICOM media; it is possible that they contain burned-in patient information.

7.1.6. Network Address Management Profiles

Not applicable

7.1.7. Time Synchronization Profiles

Consistent Time is supported & IHE profile is supported. It is possible to synchronize time with the NTP Timeserver using serviceability.

7.1.8. Application Configuration Management Profiles

Not applicable

7.1.9. Audit Trail Profiles

The Audit Trail Component is a component that can create messages according to the ATNA, IHE defined standard. Actors are information systems or components of information systems that produce, manage, or act on categories of information required by operational activities in the enterprise. The Audit Trail Component allows security officers in an institution to audit activities, to detect non-compliant behavior in the enterprise, and to facilitate detection of improper creation, access, modification and deletion of Protected Health Information (PHI), where PHI data is considered as information records (Registration, Order, Study/Procedure, Reports and to a lesser degree Images/Presentation States), and not the flow of information between the systems. . The following messages will be created and sent to a central Audit Record Repository

Trigger Event	Description
ActorStart-Stop	This audit message describes the event of an Application Entity starting or stopping.
User Authentication	This message describes the event of a user log on or log off, whether successful or not. No Participant Objects are needed for this message
Node-Authentication-failure	This message describes any event for which a node needs to report a security alert, e.g., a node Authentication failure when establishing a secure communications channel.
Security Alert	This message describes any security related event caused by configuration changes.
BeginStoring Instances	Begin storing SOP Instances for a study. This may be a mix of instances.
Instances-Stored	Instances for a particular study have been stored on this system. One event covers all instances stored for the particular study.
Study-Object-Event	Study is created, modified, accessed, or deleted. This reports on addition of new instances to existing studies as well as creation of new studies.
Study-used	SOP Instances from a specific study are created, modified or accessed. One event covers all instances used for the particular study.
PHI-export	Any export of PHI on media, either removable physical media such as CD-ROM or electronic transfer of files such as email. Any printing activity, paper or film, local or remote that prints PHI.
Instances-deleted	SOP Instances are deleted from a specific study. One event covers all instances deleted for the particular study.
Audit-Log-Used	The audit trail repository has been accessed or modified by something other than the arrival of audit trail messages.
Query Information	A query has been received, either as part of an IHE transaction, or as part of other product's functions.
Mobile-machine-event	This message describes the event of a system, such as a mobile device, intentionally joins or leaves the secure domain.

7.2. Association Level Security

Not supported. Any calling AE title and/or IP address may open an association.

© 2020 Koninklijke Philips N.V.

7.3. Application Level Security

Not applicable

8. Annexes of application “Mobile C-Arm AE”

8.1. IOD Contents

8.1.1. Created SOP Instance

This section specifies each IOD created by this application.

This section specifies each IOD created (including private IOD's). It should specify the attribute name, tag, VR, and value. The value should specify the range and source (e.g. user input, Modality Worklist, automatically generated, etc.). For content items in templates, the range and source of the concept name and concept values should be specified. Whether the value is always present or not shall be specified.

Abbreviations used in the IOD tables for the column "Presence of Module" are:

ALWAYS The module is always present
 CONDITIONAL The module is used under specified condition

Abbreviations used in the Module table for the column "Presence of Value" are:

ALWAYS The attribute is always present with a value
 EMPTY The attribute is always present without any value (attribute sent zero length)
 VNAP The attribute is always present and its Value is Not Always Present
 (attribute sent zero length if no value is present)
 ANAP The attribute is present under specified condition – if present then it will always have a value
 ANAPCV The attribute is present under specified condition – if present then its Value is Not Always Present
 (attribute sent zero length if condition applies and no value is present)
 ANAPEV The attribute is present under specified condition – if present then it will not have any value

The abbreviations used in the Module table for the column "Source" are:

AUTO The attribute value is generated automatically
 CONFIG The attribute value source is a configurable parameter
 COPY The attribute value source is another SOP instance
 FIXED The attribute value is hard-coded in the application
 IMPLICIT The attribute value source is a user-implicit setting
 USER The attribute value source is explicit user input
 MPPS The attribute value is the same as that use for Modality Performed Procedure Step
 MWL The attribute value source is a Modality Worklist

8.1.1.1. List of created SOP Classes

Table 75: List of created SOP Classes

SOP Class Name	SOP Class UID
Secondary Capture Image Storage SOP Class	1.2.840.10008.5.1.4.1.1.7
X-Ray Angiographic Image Storage SOP Class	1.2.840.10008.5.1.4.1.1.12.1
X-Ray Radiation Dose SR	1.2.840.10008.5.1.4.1.1.88.67

8.1.1.2. Secondary Capture Image Storage SOP Class

Table 76: IOD of Created Secondary Capture Image Storage SOP Class Instances

Information Entity	Module	Presence Of Module	Comment
Patient	Patient Module	ALWAYS	
Study	General Study Module	ALWAYS	

Study	Patient Study Module	ALWAYS	
Series	General Series Module	ALWAYS	
Equipment	General Equipment Module	ALWAYS	
Equipment	SC Equipment Module	ALWAYS	
Image	General Image Module	ALWAYS	
Image	Image Pixel Module	ALWAYS	
Image	SC Image Module	ALWAYS	
Image	SOP Common Module	ALWAYS	

Table 77: Patient Module

Attribute Name	Tag	VR	Value	Presence of Value	Source	Comment
Patient's Name	0010,0010	PN		ALWAYS	MWL, USER, AUTO	
Patient ID	0010,0020	LO		ALWAYS	MWL, USER, AUTO	
Patient's Birth Date	0010,0030	DA		VNAP	MWL, USER	
Patient's Birth Time	0010,0032	TM		VNAP	MWL	
Patient's Sex	0010,0040	CS	F, M, O	ALWAYS	MWL, USER	
Other Patient IDs	0010,1000	LO		VNAP	MWL	
Other Patient Names	0010,1001	PN		VNAP	MWL	

Table 78: General Study Module

Attribute Name	Tag	VR	Value	Presence of Value	Source	Comment
Study Date	0008,0020	DA		ALWAYS	AUTO	
Study Time	0008,0030	TM		ALWAYS	AUTO	
Accession Number	0008,0050	SH		VNAP	MWL, USER	
Referring Physician's Name	0008,0090	PN		VNAP	MWL	
Study Description	0008,1030	LO		ALWAYS	AUTO, MWL	Copied from either Requested Procedure description' (0032,1060) or the 'Scheduled Procedure Step description' (0040,0007). If the MWL attribute is empty the Examination Type is used instead.
Study Instance UID	0020,000D	UI		ALWAYS	AUTO, MWL	
Study ID	0020,0010	SH		ALWAYS	MWL, AUTO	From Requested Procedure ID (0040,1001) of MWL

Table 79: Patient Study Module

Attribute Name	Tag	VR	Value	Presence of Value	Source	Comment
Patient's Weight	0010,1030	DS		VNAP	MWL, USER	

Table 80: General Series Module

Attribute Name	Tag	VR	Value	Presence of Value	Source	Comment
Series Date	0008,0021	DA		ALWAYS	AUTO	For Dose Reports Export Date will be used.
Series Time	0008,0031	TM		ALWAYS	AUTO	For Dose Reports Export Time will be used.
Modality	0008.0060	CS	XA ,RF,OT	ALWAYS	CONFIG	
Series Description	0008,103E	LO		ALWAYS	AUTO	examName-Detailed procedure name
Performing Physician's Name	0008,1050	PN		VNAP	MWL, USER	Copied from scheduled performing physician's name if this provided by MWL or can be entered by Operator.
Referenced Performed Procedure Step Sequence	0008,1111	SQ		ANAP	AUTO	
>Referenced SOP Class UID	0008,1150	UI	1.2.840.10008.3.1.2.3.3	ALWAYS	AUTO	
>Referenced SOP Instance UID	0008,1155	UI		ALWAYS	AUTO	
Protocol Name	0018,1030	LO		VNAP	USER	Entered by the user in the MPPS panel is used in MPPS N-SET. Same will be copied to Image Storage.
Series Instance UID	0020,000E	UI		ALWAYS	AUTO	
Series Number	0020,0011	IS		ALWAYS	AUTO	
Laterality	0020,0060	CS		EMPTY	FIXED	
Performed Procedure Step Start Date	0040,0244	DA		ALWAYS	AUTO	Examination Date
Performed Procedure Step Start Time	0040,0245	TM		ALWAYS	AUTO	Examination Time
Performed Procedure Step Description	0040,0254	LO		ALWAYS	AUTO	Same as Study Description (0008,1030)
Request Attributes Sequence	0040,0275	SQ		ANAP	AUTO	From worklist
>Reason For Requested Procedure Code Sequence	0040,100A	SQ		ANAP	AUTO	From worklist
>Reason For Requested Procedure	0040,1002	LO		ANAP	AUTO	From worklist

Table 81: General Equipment Module

Attribute Name	Tag	VR	Value	Presence of Value	Source	Comment
Manufacturer	0008,0070	LO	Philips	ALWAYS	AUTO	Philips.
Device Serial Number	0018,1000	LO		ALWAYS	AUTO	Serial number of the system.Value comes from service setting.
Institution Name	0008,0080	LO		ALWAYS	CONFIG	
Station Name	0008,1010	SH		ALWAYS	CONFIG	
Manufacturer's Model Name	0008,1090	LO	Zenition 70	ALWAYS	AUTO	
Software Version(s)	0018,1020	LO	5.1.x, where x is the detailed application version	ALWAYS	AUTO	Software version of the build e.g. 5.1.7

Table 82: SC Equipment Module

Attribute Name	Tag	VR	Value	Presence of Value	Source	Comment
Modality	0008,0060	CS	XA, RF or OT	ALWAYS	CONFIG	
Conversion Type	0008,0064	CS	DI	ALWAYS	AUTO	

Secondary Capture Device ID	0018,1010	LO		ALWAYS	CONFIG	Mobile C-Arm System ID
Secondary Capture Device Manufacturer	0018,1016	LO	Philips	ALWAYS	AUTO	Philips.
Secondary Capture Device Manufacturer's Model Name	0018,1018	LO		ALWAYS	AUTO	
Secondary Capture Device Software Version(s)	0018,1019	LO		ALWAYS	AUTO	Software version of the build e.g. 5.1.7

Table 83: General Image Module

Attribute Name	Tag	VR	Value	Presence of Value	Source	Comment
Image Type	0008,0008	CS	Value 1: DERIVED, Value 2: SECONDARY Value 3: SINGLE PLANE	ALWAYS	AUTO	
Content Date	0008,0023	DA		ALWAYS	AUTO	
Content Time	0008,0033	TM		ALWAYS	AUTO	
Irradiation Event UID	0008,3010	UI		ANAP	AUTO	When RDSR is enabled for SC images based on X-ray image
Instance Number	0020,0013	IS		ALWAYS	AUTO	Generated running number
Patient Orientation	0020,0020	CS		EMPTY	FIXED	
Lossy Image Compression	0028,2110	CS	00	ALWAYS	FIXED	
Acquisition Date	0008,0022			ANAP	AUTO	In case of Dose report, the attribute is not present
Acquisition Time	0008,0032			ANAP	AUTO	In case of Dose report, the attribute is not present

Table 84: Image Pixel Module

Attribute Name	Tag	VR	Value	Presence of Value	Source	Comment
Samples per Pixel	0028,0002	US	1	ALWAYS	AUTO	
Photometric Interpretation	0028,0004	CS	MONOCHROME2	ALWAYS	AUTO	
Rows	0028,0010	US	1024	ALWAYS	AUTO	
Columns	0028,0011	US	1024	ALWAYS	AUTO	
Bits Allocated	0028,0100	US	16	ALWAYS	AUTO	With text: 8
Bits Stored	0028,0101	US	16	ALWAYS	AUTO	With text: 8
High Bit	0028,0102	US	15	ALWAYS	AUTO	With text: 7
Pixel Representation	0028,0103	US	0	ALWAYS	AUTO	
Pixel Data	7FE0,0010	O W/ OB		ALWAYS	AUTO	

Table 85: SC Image Module

Attribute Name	Tag	VR	Value	Presence of Value	Source	Comment
Date of Secondary Capture	0018,1012	DA		ALWAYS	AUTO	
Time of Secondary Capture	0018,1014	TM		ALWAYS	AUTO	

Table 86: SOP Common Module

Attribute Name	Tag	VR	Value	Presence of Value	Source	Comment
Specific Character Set	0008,0005	CS	ISO_IR 100	ALWAYS	AUTO	Required if expanded/replacement character set used.

SOP Class UID	0008,0016	UI	1.2.840.10008.5.1.4.1.1.7	ALWAYS	AUTO	
SOP Instance UID	0008,0018	UI		ALWAYS	AUTO	
Instance Number	0020,0013	IS		ALWAYS	AUTO	

8.1.1.3. X-Ray Angiographic Image Storage SOP Class

Table 87: IOD of Created X-Ray Angiographic Image Storage SOP Class Instances

Information Entity	Module	Presence Of Module	Comment
Patient	Patient Module	ALWAYS	
Study	General Study Module	ALWAYS	
Study	Patient Study Module	ALWAYS	
Series	General Series Module	ALWAYS	
Equipment	General Equipment Module	ALWAYS	
Image	General Image Module	ALWAYS	
Image	Image Pixel Module	ALWAYS	
Image	Cine Module	ALWAYS	
Image	Multi-Frame Module	ALWAYS	
Image	X-Ray Image Module	ALWAYS	
Image	X-Ray Acquisition Module	ALWAYS	
Image	XA Positioner Module	ALWAYS	
Image	DX Detector Module	ALWAYS	
Image	SOP Common Module	ALWAYS	

Table 88: Patient Module

Attribute Name	Tag	VR	Value	Presence of Value	Source	Comment
Patient's Name	0010,0010	PN		ALWAYS	MWL, USER, AUTO	
Patient ID	0010,0020	LO		ALWAYS	MWL, USER, AUTO	
Patient's Birth Date	0010,0030	DA		VNAP	MWL, USER	
Patient's Birth Time	0010,0032	TM		VNAP	MWL	
Patient's Sex	0010,0040	CS	F, M, O	ALWAYS	MWL, USER	
Other Patient IDs	0010,1000	LO		VNAP	MWL	
Other Patient Names	0010,1001	PN		VNAP	MWL	

Table 89: General Study Module

Attribute Name	Tag	VR	Value	Presence of Value	Source	Comment
Study Date	0008,0020	DA		ALWAYS	AUTO	
Study Time	0008,0030	TM		ALWAYS	AUTO	
Accession Number	0008,0050	SH		VNAP	MWL, USER	
Referring Physician's Name	0008,0090	PN		VNAP	MWL	

Study Description	0008,1030	LO		ALWAYS	AUTO, MWL	Copied from either Requested Procedure description' (0032,1060) or the 'Scheduled Procedure Step description' (0040,0007). If the MWL attribute is empty the Examination Type is used instead.
Study Instance UID	0020,000D	UI		ALWAYS	AUTO	
Study ID	0020,0010	SH		ALWAYS	MWL, AUTO	From Requested Procedure ID (0040,1001) of MWL

Table 90: Patient Study Module

Attribute Name	Tag	VR	Value	Presence of Value	Source	Comment
Patient's Weight	0010,1030	DS		VNAP	MWL, USER	

Table 91: General Series Module

Attribute Name	Tag	VR	Value	Presence of Value	Source	Comment
Series Date	0008,0021	DA		ALWAYS	AUTO	
Series Time	0008,0031	TM		ALWAYS	AUTO	
Acquisition Date	0008,0022	DA		ALWAYS	AUTO	
Acquisition Time	0008,0032	TM	Time when acquisition performed	ALWAYS	AUTO	
Modality	0008,0060	CS		ALWAYS	CONFIG	XA,RF,OT
Series Description	0008,103E	LO		ALWAYS	AUTO	examName-Detailed procedure name
Performing Physician's Name	0008,1050	PN		VNAP	MWL, USER	Copied from scheduled performing physician's name if this provided by MWL or can be entered by Operator.
Referenced Performed Procedure Step Sequence	0008,1111	SQ		ANAP	AUTO	
>Referenced SOP Class UID	0008,1150	UI	1.2.840.10008.3.1.2.3.3	ALWAYS	AUTO	
>Referenced SOP Instance UID	0008,1155	UI		ALWAYS	AUTO	
Protocol Name	0018,1030	LO		VNAP	USER	Entered by the user in the MPPS panel is used in the MPPS N-SET. Same will be copied to image storage
Series Instance UID	0020,000E	UI		ALWAYS	AUTO	
Series Number	0020,0011	IS		ALWAYS	AUTO	Increasing number that identifies series (run)
Laterality	0020,0060	CS		EMPTY	FIXED	
Performed Procedure Step Start Date	0040,0244	DA		ALWAYS	AUTO	
Performed Procedure Step Start Time	0040,0245	TM		ALWAYS	AUTO	
Performed Procedure Step Description	0040,0254	LO		ALWAYS	MPPS	Copied from either Requested Procedure description' (0032,1060) or the 'Scheduled Procedure Step description' (0040,0007). If the MWL attribute is empty the Examination Type is used instead.
Request Attributes Sequence	0040,0275	SQ		ANAP	AUTO	From worklist
>Reason For Requested Procedure Code Sequence	0040,100A	SQ		ANAP	AUTO	From worklist

>Reason For Requested Procedure	0040,1002	LO		ANAP	AUTO	From worklist
---------------------------------	-----------	----	--	------	------	---------------

Table 92: General Equipment Module

Attribute Name	Tag	VR	Value	Presence of Value	Source	Comment
Manufacturer	0008,0070	LO	Philips	ALWAYS	AUTO	Philips
Device Serial Number	0018,1000	LO		ALWAYS	AUTO	Serial number of the system.Value comes from service setting.
Station Name	0008,1010	SH		ALWAYS	CONFIG	
Manufacturer's Model Name	0008,1090	LO	Zenition 70	ALWAYS	AUTO	
Software Version(s)	0018,1020	LO		ALWAYS	AUTO	Software version of the build e.g. 5.1.7

Table 93: General Image Module

Attribute Name	Tag	VR	Value	Presence of Value	Source	Comment
Image Type	0008,0008	CS	ORIGINAL \ PRIMARY\SINGLE PLANE	ALWAYS	AUTO	
Content Date	0008,0023	DA		ALWAYS	AUTO	<yyyymmdd>
Content Time	0008,0033	TM		ALWAYS	AUTO	<hhmmss>
Irradiation Event UID	0008,3010	UI		ANAP	AUTO	When RDSR is enabled.
Instance Number	0020,0013	IS		ALWAYS	AUTO	
Patient Orientation	0020,0020	CS		EMPTY	FIXED	
Lossy Image Compression	0028,2110	CS	00	ALWAYS	FIXED	

Table 94: Image Pixel Module

Attribute Name	Tag	VR	Value	Presence of Value	Source	Comment
Samples per Pixel	0028,0002	US		ALWAYS	AUTO	
Photometric Interpretation	0028,0004	CS		ALWAYS	AUTO	
Rows	0028,0010	US	1024	ALWAYS	AUTO	
Columns	0028,0011	US	1024	ALWAYS	AUTO	
Bits Allocated	0028,0100	US	16	ALWAYS	AUTO	
Bits Stored	0028,0101	US	16	ALWAYS	AUTO	
High Bit	0028,0102	US	15	ALWAYS	AUTO	
Pixel Representation	0028,0103	US		ALWAYS	AUTO	
Pixel Data	7FE0,0010	O W/ OB		ALWAYS	AUTO	

Table 95: Cine Module

Attribute Name	Tag	VR	Value	Presence of Value	Source	Comment
Start Trim	0008,2142	IS	1	ALWAYS	AUTO	
Stop Trim	0008,2143	IS		ALWAYS	AUTO	Number of images in the run.
Frame Time	0018,1063	DS		ALWAYS	AUTO	Calculated from acquisition speed [ms].

Table 96: Multi-Frame Module

Attribute Name	Tag	VR	Value	Presence of Value	Source	Comment
Number of Frames	0028,0008	IS		ALWAYS	AUTO	Number of exported images in the run.

Frame Increment Pointer	0028,0009	AT		ALWAYS	AUTO	
-------------------------	-----------	----	--	--------	------	--

Table 97: X-Ray Image Module

Attribute Name	Tag	VR	Value	Presence of Value	Source	Comment
Image Type	0008,0008	CS	Value 1: ORIGINAL, Value 2: PRIMARY Value3: SINGLE PLANE	ALWAYS	AUTO	
Contrast / Bolus Agent	0018,0010	LO		VNAP	USER	IODINE – for iodine contrast agent procedure CARBON DIOXIDE – for CO2 contrast agent procedure Empty tag for other procedures
Scan option	0018,0022	CS		ANAP	USER	Acquisition technique used for image acquisition. CHASE for bolus chase procedure. This tag will not be filled for other procedures.
Samples per Pixel	0028,0002	US	1	ALWAYS	AUTO	
Photometric Interpretation	0028,0004	CS	MONOCHROME2	ALWAYS	AUTO	
Frame Increment Pointer	0028,0009	AT	0x00181063	ALWAYS	AUTO	
Bits Allocated	0028,0100	US	16	ALWAYS	AUTO	
Bits Stored	0028,0101	US	16	ALWAYS	AUTO	
High Bit	0028,0102	US	15	ALWAYS	AUTO	
Pixel Representation	0028,0103	US	0	ALWAYS	AUTO	
Pixel Intensity Relationship	0028,1040	CS	LIN	ALWAYS	AUTO	
Window Center	0028,1050	DS		ALWAYS	AUTO	
Window Width	0028,1051	DS		ALWAYS	FIXED	

Table 98: X-Ray Acquisition Module

Attribute Name	Tag	VR	Value	Presence of Value	Source	Comment
KVP	0018,0060	DS		EMPTY	FIXED	-
Field of View Shape	0018,1147	CS		ALWAYS	AUTO	ROUND / RECTANGLE
Exposure	0018,1152	IS		EMPTY	FIXED	-
Radiation Setting	0018,1155	CS	GR, SC	ALWAYS	AUTO	-
Type of Filters	0018,1161	LO	MULTIPLE	ALWAYS	AUTO	
Intensifier Size	0018,1162	DS		ALWAYS	AUTO	-
Imager Pixel Spacing	0018,1164	DS		ANAP	AUTO	Absent during detector format switch
Grid	0018,1166	CS		ANAP	AUTO	EMPTY

Table 99: XA Positioner Module

Attribute Name	Tag	VR	Value	Presence of Value	Source	Comment
Distance Source to Detector	0018,1110	DS		ALWAYS	FIXED	-
Positioner Primary Angle	0018,1510	DS		ALWAYS	AUTO	-
Positioner Secondary Angle	0018,1511	DS		ALWAYS	FIXED	-

Table 100: DX Detector Module

Attribute Name	Tag	VR	Value	Presence of Value	Source	Comment
Field of View Shape	0018,1147	CS		ALWAYS	FIXED	ROUND / RECTANGLE

Imager Pixel Spacing	0018,1164	DS		ALWAYS	AUTO	-
Pixel Spacing	0028,0030	DS		ALWAYS	FIXED	-

Table 101: SOP Common Module

Attribute Name	Tag	VR	Value	Presence of Value	Source	Comment
Specific Character Set	0008,0005	CS	ISO_IR 100	ALWAYS	AUTO	Required if expanded/replacement character set used.
SOP Class UID	0008,0016	UI	1.2.840.10008.5.1.4.1.1.12.1	ALWAYS	AUTO	
SOP Instance UID	0008,0018	UI		ALWAYS	AUTO	
Instance Number	0020,0013	IS		ALWAYS	AUTO	

8.1.1.4. X-Ray Radiation Dose SR

Table 102: IOD of Created X-Ray Radiation Dose SR Instances

Information Entity	Module	Presence Of Module
Patient	Patient Module	ALWAYS
Study	General Study Module	ALWAYS
Study	Patient Study Module	ALWAYS
Series	SR Document Series Module	ALWAYS
Equipment	General Equipment Module	ALWAYS
Document	SR Document General Module	ALWAYS
Document	SR Document Content Module	ALWAYS
Document	SOP Common Module	ALWAYS

Table 103: Patient Module

Attribute Name	Tag	VR	Value	Presence of Value	Source	Comment
Referenced Patient Sequence	0008,1120	SQ		VNAP	MWL	
> Referenced SOP Class UID	0008,1150	UI		ALWAYS	MWL	
> Referenced SOP Instance UID	0008,1155	UI		ALWAYS	MWL	
Patient's Name	0010,0010	PN		ALWAYS	AUTO	
Patient ID	0010,0020	LO		VNAP	MWL, USER, AUTO	
Patient's Birth Date	0010,0030	DA		ALWAYS	MWL, USER	
Patient's Birth Time	0010,0032	TM		VNAP	MWL	
Patient's Sex	0010,0040	CS	F, M, O	ALWAYS	MWL, USER	
Other Patient IDs	0010,1000	LO		VNAP	MWL	
Other Patient Names	0010,1001	PN		VNAP	MWL	

Table 104: General Study Module

Attribute Name	Tag	VR	Value	Presence of Value	Source	Comment
Study Date	0008,0020	DA		ALWAYS	AUTO	
Study Time	0008,0030	TM		ALWAYS	AUTO	

Accession Number	0008,0050	SH		VNAP	MWL, USER	
Referring Physician's Name	0008,0090	PN		VNAP	MWL	
Study Description	0008,1030	LO		ALWAYS	AUTO, MWL	Copied from either Requested Procedure description' (0032,1060) or the 'Scheduled Procedure Step description' (0040,0007). If the MWL attribute is empty the examination Type is used instead.
Study Instance UID	0020,000D	UI		ALWAYS	AUTO	
Study ID	0020,0010	SH		ALWAYS	MWL, AUTO	From Requested Procedure ID (0040,1001) of MWL.

Table 105: Patient Study Module

Attribute Name	Tag	VR	Value	Presence of Value	Source	Comment
Patient's Weight	0010,1030	DS		VNAP	MWL, USER	

Table 106: SR Document Series Module

Attribute Name	Tag	VR	Value	Presence of Value	Source	Comment
Series Date	0008,0021	DA		ALWAYS	AUTO	
Series Time	0008,0031	TM		ALWAYS	AUTO	
Modality	0008,0060	CS	SR	ALWAYS	FIXED	
Series Description	0008,103E	LO	Radiation Dose Information	ALWAYS	FIXED	
Referenced Performed Procedure Step Sequence	0008,1111	SQ		ANAP	COPY	If no associated Performed Procedure Step exists then the attribute remains empty.
>Referenced SOP Class UID	0008,1150	UI	1.2.840.10008.3.1.2.3.3	ALWAYS	AUTO	
>Referenced SOP Instance UID	0008,1155	UI		ALWAYS	AUTO	
Series Instance UID	0020,000E	UI		ALWAYS	AUTO	
Series Number	0020,0011	IS		ALWAYS	FIXED	Unique

Table 107: General Equipment Module

Attribute Name	Tag	VR	Value	Presence of Value	Source	Comment
Manufacturer	0008,0070	LO	Philips	ALWAYS	AUTO	"Philips ".
Institution Name	0008,0080	LO		ANAP	CONFIG	Hospital Name (as configured in service setting)
Station Name	0008,1010	SH		ALWAYS	CONFIG	
Manufacturer's Model Name	0008,1090	LO		ALWAYS	AUTO	
Device Serial Number	0018,1000	LO		ALWAYS	AUTO	Value comes from service setting.
Software Version(s)	0018,1020	LO		ALWAYS	AUTO	Software version of the build e.g. 5.1.7

Table 108: SR Document General Module

Attribute Name	Tag	VR	Value	Presence of Value	Source	Comment
Content Time	0008,0033	TM		ALWAYS	AUTO	-

Instance Number	0020,0013	IS	0	ALWAYS	AUTO	0
Content Date	0008,0023	DA		ALWAYS	AUTO	-
Completion Flag	0040,A491	CS	COMPLETE	ALWAYS	FIXED	-
Verification Flag	0040,A493	CS	UNVERIFIED	ALWAYS	FIXED	-
Referenced Request Sequence	0040,A370	SQ		ANAP	MWL	-
>Requested Procedure Description	0032,1060	LO		VNAP	MWL	-
>Reason for the Requested Procedure	0040,1002	LO		ANAP	MWL	-
>Accession Number	0008,0050	SH		VNAP	MWL	-
>Study Instance UID	0020,000D	UI		ALWAYS	MWL AUTO	-
>Requested Procedure ID	0040,1001	SH		VNAP	MWL	-
>Placer Order Number / Imaging Service Request	0040,2016	LO		VNAP	MWL	-
>Filler Order Number / Imaging Service Request	0040,2017	LO		VNAP	MWL	-
>Reason for Requested Procedure Code Sequence	0040,100A	SQ		ANAP	MWL	-
>>Code Value	0008,0100	SH		ALWAYS	MWL	-
>>Coding Scheme Designator	0008,0102	SH		ALWAYS	MWL	-
>>Code Meaning	0008,0104	LO		ALWAYS	MWL	-
>>Coding Scheme Version	0008,0103	SH		ANAP	MWL	-
>Requested Procedure Code Sequence	0032,1064	SQ		VNAP	MWL	-
>>Code Value	0008,0100	SH		ALWAYS	MWL	-
>>Coding Scheme Designator	0008,0102	SH		ALWAYS	MWL	-
>>Code Meaning	0008,0104	LO		ALWAYS	MWL	-
>>Coding Scheme Version	0008,0103	SH		ANAP	MWL	-
>Referenced Study Sequence	0008,1110	SQ		VNAP	MWL	-
>>Referenced SOP Class UID	0008,1150	UI		ALWAYS	MWL	-
>>Referenced SOP Instance UID	0008,1155	UI		ALWAYS	MWL	-
Performed Procedure Code Sequence	0040,A372	SQ		EMPTY	AUTO	No Value and zero Value Length.

Table 109: SR Document Content Module

Attribute Name	Tag	VR	Value	Presence of Value	Source	Comment
Value Type	0040,A040	CS	CONTAINER	ALWAYS	FIXED	
Concept Name Code Sequence	0040,A043	SQ		ANAP	AUTO	
>Code Value	0008,0100	SH	113701	ALWAYS	FIXED	
>Coding Scheme Designator	0008,0102	SH	DCM	ALWAYS	FIXED	
>Code Meaning	0008,0104	LO	X-ray radiation Dose Report	ALWAYS	FIXED	
Continuity Of Content	0040,A050	CS	SEPARATE	ALWAYS	FIXED	
Content Template Sequence	0040,A504	SQ		ALWAYS	AUTO	
>Mapping Resource	0008,0105	CS	DCMR	ALWAYS	FIXED	
>Template Identifier	0040,DB00	CS	TID 10001	ALWAYS	FIXED	
Content Sequence	0040,A730	SQ		ANAP	AUTO	
>Relationship Type	0040,A010	CS	HAS CONCEPT MOD	ALWAYS	FIXED	

Table 110: SOP Common Module

Attribute Name	Tag	VR	Value	Presence of Value	Source	Comment
Specific Character Set	0008,0005	CS	ISO_IR 100	ALWAYS	COPY	
Instance Creation Date	0008,0012	DA		ALWAYS	AUTO	
Instance Creation Time	0008,0013	TM		ALWAYS	AUTO	
SOP Class UID	0008,0016	UI	1.2.840.10008.5.1.4.1.1.88.67	ALWAYS	FIXED	
SOP Instance UID	0008,0018	UI		ALWAYS	AUTO	
Instance number	0020,0012	IS		ALWAYS	AUTO	

8.1.1.5. Radiation Dose Structured Report

8.1.1.5.1. TID 10001 Projection X-Ray Radiation Dose

Table 111: Projection X-Ray Radiation Dose

NL	Relation with Parent	Concept Name	VM	Presence of Value	Value
		X-Ray Radiation Dose Report	1	ALWAYS	
>	HAS CONCEPT MOD	Procedure reported	1	ALWAYS	Projection X-Ray
>>	HAS CONCEPT MOD	Has Intent	1	ALWAYS	Diagnostic Intent
>		DTID (1002) Observer Context	1	ALWAYS	
>	HAS OBS CONTEXT	Scope of Accumulation	1	ALWAYS	Performed Procedure Step
>>	HAS PROPERTIES	DCID (10001) UID Types	1	ALWAYS	Performed Procedure Step SOP Instance UID When the system does not use MPPS, a UID will be used based on the examination timestamp.
>	CONTAINS	DTID (10002) Accumulated X-Ray Dose	1	ALWAYS	
>	CONTAINS	DTID (10003) Irradiation Event X-Ray Data	1-n	ALWAYS	
>	CONTAINS	Source of Dose Information	1	ALWAYS	Automated Data Collection

8.1.1.5.2. TID 10002 Accumulated X-Ray Dose

Table 112: Accumulated X-Ray Dose

NL	Relation with Parent	Concept Name	VM	Presence of Value	Value
		Accumulated X-Ray Dose Data	1	ALWAYS	
>	HAS CONCEPT MOD	Acquisition Plane	1	ALWAYS	Single Plane
>	CONTAINS	Calibration	1	ALWAYS	Values from service calibration

>>	HAS CONCEPT MOD	Dose Measurement Device	1	ALWAYS	Dosimeter
>>	CONTAINS	Calibration Date	1	ALWAYS	System date of last calibration
>>	CONTAINS	"Calibration Factor	1	ALWAYS	1
>>	CONTAINS	Calibration Uncertainty	1	ALWAYS	35%
>>	CONTAINS	Calibration Responsible Party	1	ALWAYS	Party responsible for servicing the device
>	CONTAINS	DTID (10004) Accumulated Projection X-Ray Dose	1	ALWAYS	

8.1.1.5.3. TID 10003 Irradiation Event X-Ray Data

Table 113: Irradiation Event X-Ray Data

NL	Relation with Parent	Concept Name	VM	Presence of Value	Value
		Irradiation Event X-Ray Data	1	ALWAYS	
>	HAS CONCEPT MOD	Acquisition Plane	1	ALWAYS	Single Plane
>	CONTAINS	DateTime Started	1	ALWAYS	
>	CONTAINS	Irradiation Event Type	1	ALWAYS	Stationary Acquisition (for digital exposure and Radiography) Fluoroscopy (for all other runs)
>	CONTAINS	Acquisition Protocol	1	CONDITIONAL	Copy from series module when available.
>	CONTAINS	Reference Point Definition	1	ALWAYS	30cm in Front of Image Input Surface
>	CONTAINS	Irradiation Event UID	1	ALWAYS	
>	CONTAINS	Dose Area Product	1	ALWAYS	Dose area product.
>	CONTAINS	Dose (RP)	1	ALWAYS	Dose at the dose reference point.
>	CONTAINS	Positioner Primary Angle	1	CONDITIONAL	
>	CONTAINS	Positioner Secondary Angle	1	CONDITIONAL	
>	CONTAINS	Positioner Primary End Angle	1	CONDITIONAL	
>	CONTAINS	Positioner Secondary End Angle	1	CONDITIONAL	
>	CONTAINS	Collimated Field Area	1	ALWAYS	Collimator area at detector plane
>	CONTAINS	X-Ray Filters	2	ALWAYS	List of all fixed pre-filters in the system
>	CONTAINS	Irradiation Duration	1	ALWAYS	Time in seconds
>	CONTAINS	DCID (10008) Dose Related Distance Measurements	2	ALWAYS	Fill in fixed values for: - Distance source to reference point - Distance source to detector
>	CONTAINS	Target Region	1	ALWAYS	One of the list below can be selected by the user. - Abdomen - Chest - Chest, Abdomen and Pelvis - Entire body - Extremity - Head - Hip joint - Spine
>	CONTAINS	Anode Target Material	1	ALWAYS	Tungsten or Tungsten compound
>	CONTAINS	X-Ray Grid	1	ALWAYS	Focused grid
>	CONTAINS	DTID (1020) Person Participant	1	ALWAYS	
>	CONTAINS	DTID (1021) Device Participant	1	ALWAYS	Irradiating Device

Note that the number of irradiation events in an exported dose structured report message is limited to 1000.

8.1.1.5.4. TID 10004 Accumulated Projection X-Ray Dose

Table 114: Accumulated Projection X-Ray Dose

NL	Relation with Parent	Concept Name	VM	Presence of Value	Value
		Dose Area Product Total	1	ALWAYS	Gym2 (unit)
		Dose (RP) Total	1	ALWAYS	Gy (unit)
		Fluoro Dose Area Product Total	1	CONDITIONAL	Gym2 (unit)
		Fluoro Dose (RP) Total	1	CONDITIONAL	Gy (unit)
		Total Fluoro Time	1	CONDITIONAL	Time in seconds
		Acquisition Dose Area Product Total	1	ALWAYS	The Dose Area Product for Digital Exposures and Radiography
		Acquisition Dose (RP) Total	1	ALWAYS	The dose administered for Digital Exposures & Radiography.
		Total Acquisition Time	1	ALWAYS	Time in seconds
		Total Number of Radiographic Frames	1	CONDITIONAL	no units
		Reference Point Definition	1	ALWAYS	30cm in Front of Image Input Surface

8.1.1.5.5. TID 1002 Observer Context

Table 115: Observer Context

NL	Relation with Parent	Concept Name	VM	Presence of Value	Value
	HAS OBS CONTEXT	Observer Type	1	CONDITIONAL	Device
	HAS OBS CONTEXT	DTID (1004) Device observer identifying attributes	1	ALWAYS	

8.1.1.5.6. TID 1004 Device Observer Identifying Attributes

Table 116: Device Observer Identifying Attributes

NL	Relation with Parent	Concept Name	VM	Presence of Value	Value
		Device Observer UID	1	ALWAYS	Based on the Device Serial Number (0018, 1000)
		Device Observer Name	1	CONDITIONAL	Station Name (0008,1010)
		Device Observer Manufacturer	1	CONDITIONAL	Manufacturer (0008,0070)
		Device Observer Model Name	1	CONDITIONAL	Manufacturer's Model Name (0008,1090)

		Device Observer Serial Number	1	CONDITIONAL	Device Serial Number (0018,1000)
--	--	-------------------------------	---	-------------	----------------------------------

8.1.1.5.7. TID 1020 Person Participant

Table 117: Person Participant

NL	Relation with Parent	Concept Name	VM	Presence of Value	Value
		Person Name	1	ALWAYS	<ul style="list-style-type: none"> - First available value from the list is used. - Performing Physician's Name (0008,1050) - Physician's name as entered in the system for the examination. - Operator's Name (0008,1070) - Operator's Name as entered in the system for the examination.
>	HAS PROPERTIES	Person Role in Procedure	1	ALWAYS	Irradiation Administering.

8.1.1.5.8. TID 1021 Device Participant

Table 118: Device Participant

NL	Relation with Parent	Concept Name	VM	Presence of Value	Value
		Device Role in Procedure	1	ALWAYS	Irradiation Device
>	HAS PROPERTIES	Device Name	1	CONDITIONAL	Use the Station name (0008,1010)
>	HAS PROPERTIES	Device Manufacturer	1	ALWAYS	Manufacturer (0008,0070)
>	HAS PROPERTIES	Device Model Name	1	ALWAYS	
>	HAS PROPERTIES	Device Serial Number	1	ALWAYS	Device Serial Number (0018,1000)

8.1.2. Usage of Attributes from Received IOD

Not applicable

8.1.3. Attribute Mapping

In this section the mapping between the Modality Worklist, Storage and Modality Performed Procedure Step is specified.

Table 119: Attribute mapping of the Mobile C-Arm AE

Attribute Name	MWL Tag	MPPS Create Tag	MPPS Set Tag	SC Tag	XA Tag	SR Tag
Specific Character Set (if present)	0008,0005	0008,0005	-	0008,0005	0008,0005	0040,A370 >0008,0005
Accession Number	0008,0050	(0040,0270) >(0008,0050)	-	0008,0050	0008,0050	0040,A370 >0008,0050
Referring Physician's Name	0008,0090	-	-	0008,0090	0008,0090	0008,0090
Referenced Study Sequence	0008,1110	(0040,0270) >(0008,1110)	-	0008,1110	0008,1110	0040,A370 >0008,1110
> Referenced SOP Class UID	>(0008,1150)	>(0008,1150)	-	>(0008,1150)	>(0008,1150)	>(0008,1150)
> Referenced SOP Instance UID	>(0008,1155)	>(0008,1155)	-	>(0008,1155)	>(0008,1155)	>(0008,1155)
Referenced Patient Sequence	(0008,1120)	(0008,1120)	-	-	-	0008,1120
> Referenced SOP Class UID	>(0008,1150)	>(0008,1150)	-	-	-	>0008,1150
> Referenced SOP Instance UID	>(0008,1155)	>(0008,1155)	-	-	-	>0008,1155
Patient's Name	0010,0010	0010,0010	-	0010,0010	0010,0010	0010,0010
Patient ID	0010,0020	0010,0020	-	0010,0020	0010,0020	0010,0020
Patient's Birth Date	0010,0030	0010,0030	-	0010,0030	0010,0030	0010,0030
Patient's Birth Time	0010,0032	-	-	0010,0032	0010,0032	0010,0032
Patient's Sex	0010,0040	0010,0040	-	0010,0040	0010,0040	0010,0040
Other Patient IDs	0010,1000	-	-	0010,1000	0010,1000	0010,1000
Other Patient Names	0010,1001	-	-	0010,1001	0010,1001	0010,1001
Patient's Weight	0010,1030	-	-	0010,1030	0010,1030	0010,1030
Study Instance UID	0020,000D	(0040,0270) >(0020,000D)	-	0020,000D	0020,000D	0040,A370 >0020,000D
Requested Procedure Description	0032,1060	(0040,0270) >(0032,1060)	-	(0040,0275) >(0032,1060)	(0040,0275) >(0032,1060)	0040,A370 >0032,1060
Reason for Requested Procedure	0040,1002	-	-	-	-	0040,A370 >0040,1002
Reason for Requested Procedure Code Sequence	0040,100A	-	-	-	-	0040,A370 >0040,100A
>Code Value	>0008,0100	-	-	-	-	>>0008,0100
>Coding Scheme Designator	>0008,0102	-	-	-	-	>>0008,0102
>Code Meaning	>0008,0104	-	-	-	-	>>0008,0104
>Coding Scheme Version	>0008,0103	-	-	-	-	>>0008,0103
>Scheduled Performing Physician's Name (Physician who makes the Examination)	(0040,0100) >(0040,0006)	-	(0040,0340) >(0008,1050)	(0008,1050)	(0008,1050)	-
>Scheduled Procedure Step Description	(0040,0100) >(0040,0007)	(0040,0270) >(0040,0007)	-	(0040,0275)	(0040,0275)	0008,1030
>Scheduled Procedure Step ID	(0040,0100) >(0040,0009)	(0040,0270)	-	(0040,0275)	(0040,0275)	-
	-	>(0040,0009)	-	>(0040,0009)	>(0040,0009)	-
> Scheduled Protocol Code Sequence	(0040,0100) >(0040,0008)	(0040,0270)	-	(0040,0275)	(0040,0275)	-
	-	>(0040,0008)	-	>(0040,0008)	>(0040,0008)	-
>> Code Value	>>(0008,0100)	>>(0008,0100)	-	>>(0008,0100)	>>(0008,0100)	-
>> Coding Scheme Designator	>>(0008,0102)	>>(0008,0102)	-	>>(0008,0102)	>>(0008,0102)	-
>> Coding Scheme Version	>>(0008,0103)	>>(0008,0103)	-	>>(0008,0103)	>>(0008,0103)	-
>> Code Meaning	>>(0008,0104)	>>(0008,0104)	-	>>(0008,0104)	>>(0008,0104)	-

Attribute Name	MWL Tag	MPPS Create Tag	MPPS Set Tag	SC Tag	XA Tag	SR Tag
Requested Procedure ID	0040,1001	(0040,0270)	-	(0040,0275)	(0040,0275)	0040,A370 >0040,1001
	-	>(0040,1001), (0020,0010)	-	>(0040,1001), (0020,0010)	>(0040,1001), (0020,0010)	-
Performed Procedure Step ID	-	0040,0253	-	0040,0253	0040,0253	-
MPPS SOP Class UID	-	0000,0002	0000,0003	0008,1111 >0008,1150	0008,1111 >0008,1150	0008,1111 >0008,1150
MPPS SOP Instance UID	-	0000,1000	0000,1001	0008,1111 >0008,1155	0008,1111 >0008,1155	0008,1111 >0008,1155
Admitting Diagnoses Description	0008,1080	-	-	-	-	0008,1080
Admitting Diagnoses Code Sequence	0008,1084	-	-	0008,1084	0008,1084	0008,1084
>Code Value	>0008,0100	-	-	>0008,0100	>0008,0100	>0008,0100
>Coding Scheme Designator	>0008,0102	-	-	>0008,0102	>0008,0102	>0008,0102
>Code Meaning	>0008,0104	-	-	>0008,0104	>0008,0104	>0008,0104
>Coding Scheme Version	>0008,0103	-	-	>0008,0103	>0008,0103	>0008,0103
Scheduled Procedure Step Sequence	0040,0100	-	-	-	-	-
>Modality	>(0008,0060)	0008,0060	-	-	-	-
>Scheduled Station AE Title	>(0040,0001)	(0040,0242)	-	-	-	-
>Scheduled Procedure Step Start Date	>(0040,0002)	(0040,0244)	(0040,0250)	-	-	-
>Scheduled Procedure Step Start Time	>(0040,0003)	(0040,0245)	(0040,0251)	-	-	-
>Scheduled Station Name	>(0040,0010)	>(0040,0242)	-	0040,0010	0040,0010	-
Requested Procedure Code Sequence	(0032,1064)	(0008,1032)	-	(0008,1032)	(0008,1032)	(0040,A370) >(0032,1064)
>Code Value	>(0008,0100)	>(0008,0100)	-	>(0008,0100)	>(0008,0100)	>>(0008,0100)
>Coding Scheme Designator	>(0008,0102)	>(0008,0102)	-	>(0008,0102)	>(0008,0102)	>>(0008,0102)
>Coding Scheme Version	>(0008,0103)	>(0008,0103)	-	>(0008,0103)	>(0008,0103)	>>(0008,0103)
>Code Meaning	>(0008,0104)	>(0008,0104)	-	>(0008,0104)	>(0008,0104)	>>(0008,0104)
Placer Order Number/Imaging Service Request	(0040,2016)	-	-	-	-	(0040,A370) >(0040,2016)
Filler Order Number/Imaging Service Request	(0040,2017)	-	-	-	-	(0040,A370) >(0040,2017)

8.1.4. Coerced/Modified fields

When exporting an image the following behavior applies.

A Secondary Capture image shall be exported as reflected in the GUI.

To enable reconstruction, an X-ray image shall be exported without annotations and using the original grayscale values as per acquisition and a 3D image shall be exported without supplementary rotation.

8.2. Data Dictionary of Private Attributes

Not applicable

8.3. Coded Terminology and Templates

Not applicable.

8.3.1. Context Groups

Not applicable.