

DICOM Conformance Statement

CombiDiagnost R90 Rel 1.1



Issued by:

Philips Medical Systems Nederland BV, a Philips Healthcare company,

P.O. Box 10.000
5680 DA Best
The Netherlands

Internet: <https://www.philips.com/healthcare/about/customer-support>

Doc Id: ICAP-PF.0043521

Date: 2020-01-09

1. DICOM Conformance Statement Overview

This document is the DICOM Conformance Statement for the Philips Medical Systems CombiDiagnost R90 Rel 1.1 system.

A table of Supported Networking DICOM Services, (SOP) Classes is provided with roles (User/Provider) and can be found on the next page.

The figure below shows the position of the CombiDiagnost R90 Rel 1.1 in a radiology environment.

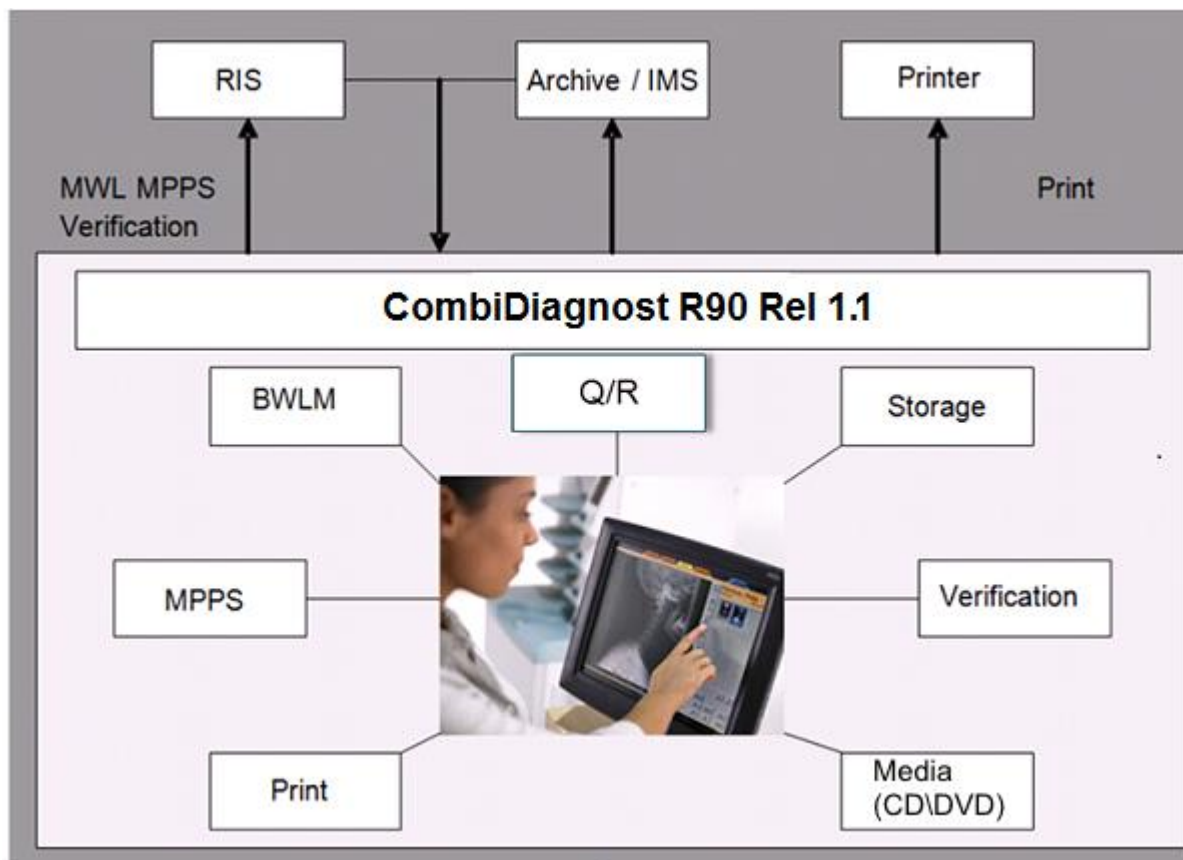

Figure 1: CombiDiagnost R90 Rel1.1 in a DICOM network

CombiDiagnost R90 Rel 1.1 is an embedded modality system for acquiring DICOM images. It provides, among other things, the following features:

- Verification of application level communication.
- Basic Worklist Management (BWLM)
- Storage of images on a remote DICOM System.
- Commitment request for stored images on a remote DICOM system (Push Model)
- Study Management per Modality Performed Procedure Step (MPPS).
- Printing of hardcopies on a remote DICOM Printer.
- Storage of images per DICOM Media only on Compact Disc (CD/DVD).
- Query and Retrieve of instances from an external DICOM system (Q/R)

Note: CombiDiagnost R90 Rel 1.1 provides printing and query retrieve services only for RAD images, Fluoro images does not support these services.

Table 1: Network Services

SOP Class		User of Service (SCU)	Provider of Service (SCP)	Display
Name	UID			
Other				
Verification SOP Class	1.2.840.10008.1.1	Yes	Yes	N/A
Print Management				
Basic Grayscale Print Management Meta SOP Class	1.2.840.10008.5.1.1.9	Yes	No	N/A
>Basic Film Box SOP Class	1.2.840.10008.5.1.1.2	Yes	No	N/A
>Basic Film Session SOP Class	1.2.840.10008.5.1.1.1	Yes	No	N/A
>Basic Grayscale Image Box SOP Class	1.2.840.10008.5.1.1.4	Yes	No	N/A
>Printer SOP Class	1.2.840.10008.5.1.1.16	Yes	No	N/A
Transfer				
Computed Radiography Image Storage SOP Class	1.2.840.10008.5.1.4.1.1.1	Yes	Yes	N/A
X-Ray Radiofluoroscopic Image Storage	1.2.840.10008.5.1.4.1.1.12.2	Yes	No	N/A
Digital X-Ray Image Storage - For Pres. SOP	1.2.840.10008.5.1.4.1.1.1.1	Yes	Yes	N/A
Digital X-Ray Image Storage - For Proc. SOP	1.2.840.10008.5.1.4.1.1.1.1.1	Yes	Yes	N/A
Secondary Capture Image Storage SOP Class	1.2.840.10008.5.1.4.1.1.7	Yes	Yes	N/A
X-Ray Radiation Dose SR	1.2.840.10008.5.1.4.1.1.88.67	Yes	No	N/A
Query/Retrieve				
Patient Root QR Information Model - FIND SOP Class	1.2.840.10008.5.1.4.1.2.1.1	Yes	No	N/A
Patient Root QR Information Model - MOVE SOP Class	1.2.840.10008.5.1.4.1.2.1.2	Yes	No	N/A
Study Root QR Information Model - FIND SOP Class	1.2.840.10008.5.1.4.1.2.2.1	Yes	No	N/A
Study Root QR Information Model - MOVE SOP Class	1.2.840.10008.5.1.4.1.2.2.2	Yes	No	N/A
Workflow Management				
Modality Performed Procedure Step SOP Class	1.2.840.10008.3.1.2.3.3	Yes	No	N/A
Modality Worklist Information Model - FIND SOP Class	1.2.840.10008.5.1.4.31	Yes	No	N/A
Storage Commitment Push Model SOP Class	1.2.840.10008.1.20.1	Yes	No	N/A

A table of Supported Media Storage Application Profiles (with roles) is provided.

Table 2: Media Services

Media Storage Application Profile	File-set Creator (FSC)	File-set Updater (FSU)	File-set Reader (FSR)
Compact Disk-Recordable			
General Purpose CD-R Interchange	Yes	No	No
DVD			
General Purpose DVD Interchange with JPEG	Yes	No	No

Note: CombiDiagnost R90 Rel 1.1 does not support writing of X-Ray Radiofluoroscopic images to media.

2. Table of Contents

1.	DICOM CONFORMANCE STATEMENT OVERVIEW	3
2.	TABLE OF CONTENTS	5
3.	INTRODUCTION	7
3.1.	REVISION HISTORY	7
3.2.	AUDIENCE	7
3.3.	REMARKS	7
3.4.	DEFINITIONS, TERMS AND ABBREVIATIONS.....	8
3.5.	REFERENCES.....	9
4.	NETWORKING	10
4.1.	IMPLEMENTATION MODEL	10
4.1.1.	Application Data Flow.....	10
4.1.2.	Functional Definition of AE's	11
4.1.2.1	Functional Definition of Eleva AE.....	11
4.1.3.	Sequencing of Real World Activities	12
4.1.3.1.	Sequence of Query/Retrieve	13
4.2.	AE SPECIFICATIONS	14
4.2.1.	Eleva AE	14
4.2.1.1.	SOP Classes	14
4.2.1.2.	Association Policies.....	14
4.2.1.2.1.	General.....	14
4.2.1.2.2.	Number of Associations.....	14
4.2.1.2.3.	Asynchronous Nature	15
4.2.1.2.4.	Implementation Identifying Information	15
4.2.1.2.5.	Communication Failure Handling.....	15
4.2.1.3.	Association Initiation Policy	15
4.2.1.3.1.	(Real-World) Activity – Verification as SCU.....	16
4.2.1.3.2.	(Real-World) Activity – Modality worklist As SCU.....	17
4.2.1.3.3.	(Real-World) Activity – Modality Performed Procedure Step as SCU.....	27
4.2.1.3.4.	(Real-World) Activity – Image Export.....	32
4.2.1.3.5.	(Real-World) Activity – Structured Dose Report Export	33
4.2.1.3.6.	(Real-World) Activity – Storage Commitment Push Model AS SCU	35
4.2.1.3.7.	(Real-World) Activity – Print Management as SCU.....	38
4.2.1.4.	Association Acceptance Policy	42
4.2.1.4.1.	(Real-World) Activity –Find as SCU.....	45
4.2.1.4.2.	(Real-World) Activity - Move as SCU.....	48
4.2.1.4.3.	(Real-World) Activity – Verification as SCP	49
4.2.1.4.4.	(Real-World) Activity – Image Import.....	50
4.3.	NETWORK INTERFACES.....	51
4.3.1.	Physical Network Interfaces.....	51
4.3.2.	Additional Protocols	51
4.3.3.	IPv4 and IPv6 Support	51
4.4.	CONFIGURATION	51
4.4.1.	AE Title/Presentation Address Mapping.....	51
4.4.1.1.	Local AE Titles.....	51
4.4.1.2.	Remote AE Title/Presentation Address Mapping.....	52
4.4.2.	Parameters.....	52
5.	MEDIA INTERCHANGE	54
5.1.	IMPLEMENTATION MODEL	54
5.1.1.	Application Data Flow Diagram	54
5.1.2.	Functional Definitions of AE's.....	54
5.1.3.	Sequencing of Real World Activities	54

5.2.	AE SPECIFICATIONS	54
5.2.1.	Media Storage Media – Specification	54
5.2.1.1.	File Meta Information for the Media Storage	55
5.2.1.2.	Real World Activities	55
5.2.1.2.1.	RWA - Create File-set	55
5.3.	AUGMENTED AND PRIVATE APPLICATION PROFILES	56
6.	SUPPORT OF CHARACTER SETS	57
7.	SECURITY	58
7.1.	SECURITY PROFILES	58
7.1.1.	Security use Profiles	58
7.1.2.	Security Transport Connection Profiles	58
7.1.3.	Digital Signature Profiles	59
7.1.4.	Media Storage Security Profiles	59
7.1.5.	Attribute Confidentiality Profiles	59
7.1.6.	Network Address Management Profiles	60
7.1.7.	Time Synchronization Profiles	60
7.1.8.	Application Configuration Management Profiles	60
7.1.9.	Audit Trail Profiles	60
7.2.	ASSOCIATION LEVEL SECURITY	61
7.3.	APPLICATION LEVEL SECURITY	61
8.	ELEVA	62
8.1.	IOD CONTENTS	62
8.1.1.	Created SOP Instance	62
	List of Created SOP Classes	62
8.1.1.1.	Computed Radiography Image Storage SOP Class	62
8.1.1.2.	Digital X-Ray Image Storage - For Presentation SOP	68
8.1.1.3.	Digital X-Ray Image Storage - For Processing SOP	76
8.1.1.4.	X-Ray Radiofluoroscopic Image Storage SOP Class	84
8.1.1.5.	Secondary Capture Image Storage SOP class	90
8.1.1.6.	X-Ray Radiation Dose SR SOP Class	94
8.1.1.7.	X-RAY RADIATION DOSE SR IOD TEMPLATES	98
8.1.1.7.1.	TID 10001 Projection X-Ray Radiation Dose	99
8.1.1.7.2.	TID 10002 Accumulated X-Ray Dose	100
8.1.1.7.3.	TID 10003 Irradiation Event X-Ray Data	100
8.1.1.7.1.	TID 10003a Irradiation Event X-Ray Detector Data	101
8.1.1.7.2.	TID 10003b Irradiation Event X-Ray Source Data (for Fluoroscopy Irradiation Event type)	101
8.1.1.7.3.	TID 10003b Irradiation Event X-Ray Source Data (for Stationary Acquisition Irradiation Event type)	101
8.1.1.7.4.	TID 10003c Irradiation Event X-Ray Mechanical Data	102
8.1.1.7.5.	TID 10004 Accumulated Projection X-Ray Dose (for Fluoroscopy Irradiation Event type)	102
8.1.1.7.6.	TID 10004 Accumulated Projection X-Ray Dose (for Stationary Acquisition Irradiation Event type)	102
8.1.1.7.7.	TID 1002 Observer Context	103
8.1.1.7.8.	TID 1004 Device Observer Identifying Attributes	103
8.1.1.7.9.	TID 10007. Accumulated Total Projection Radiography Dose	103
8.1.2.	Usage of Attributes from Received IODs	104
8.1.3.	Attribute Mapping	104
9.	VERSION HISTORY	105

3. Introduction

The introduction specifies product and relevant disclaimers as well as any general information that the vendor feels is appropriate.

3.1. Revision History

The revision history provides dates and differences of the different releases.

Table 3: Revision History

Document Version	Date of Issue	Description of change
00	20-October-2019	Initial version
01	23-December-2019	Final version
02	09-January-2020	Approved

3.2. Audience

This Conformance Statement is intended for:

- (Potential) customers
- System integrators of medical equipment
- Marketing staff interested in system functionality
- Software designers implementing DICOM interfaces

It is assumed that the reader is familiar with the DICOM standard.

3.3. Remarks

The DICOM Conformance Statement is contained in chapter 4 through 8 and follows the contents and structuring requirements of DICOM PS 3.2.

This DICOM Conformance Statement by itself does not guarantee successful interoperability of Philips equipment with non-Philips equipment. The user (or user's agent) should be aware of the following issues:

- **Interoperability**
Interoperability refers to the ability of application functions, distributed over two or more systems, to work successfully together. The integration of medical devices into an IT environment may require application functions that are not specified within the scope of DICOM. Consequently, using only the information provided by this Conformance Statement does not guarantee interoperability of Philips equipment with non-Philips equipment.
It is the user's responsibility to analyze thoroughly the application requirements and to specify a solution that integrates Philips equipment with non-Philips equipment.
- **Validation**
Philips equipment has been carefully tested to ensure that the actual implementation of the DICOM interface corresponds with this Conformance Statement.
Where Philips equipment is linked to non-Philips equipment, the first step is to compare the relevant Conformance Statements. If the Conformance Statements indicate that successful information exchange should be possible, additional validation tests will be necessary to ensure the functionality, performance, accuracy and stability of image and image related data. It is the responsibility of the user (or user's agent) to specify the appropriate test suite and to carry out the additional validation tests.
- **New versions of the DICOM Standard**
The DICOM Standard will evolve in future to meet the user's growing requirements and to incorporate new features and technologies. Philips is actively involved in this evolution and plans to adapt its equipment to future versions of the DICOM Standard. In order to do so, Philips reserves the right to make changes to its products or to discontinue its delivery. The user should ensure that any non-Philips provider linking to Philips equipment also adapts to future versions of the DICOM Standard. If not, the incorporation of DICOM enhancements into Philips equipment may lead to loss of connectivity (in case of networking) and incompatibility (in case of media).

3.4. Definitions, Terms and Abbreviations

Table 4: Definitions, Terms and Abbreviations

Abbreviation/Term	Explanation
AE	Application Entity
ANSI	American National Standard Institute
AP	Application Profile
BOT	Basic Offset Table
BWLM	Basic Worklist Management
CD	Compact Disc
CD-R	CD-Recordable
CD-M	CD-Medical
CR	Computed Radiography
CT	Computed Tomography
DCR	Dynamic Cardio Review
DICOM	Digital Imaging and Communications in Medicine
DIMSE	DICOM Message Service Element
DIMSE-C	DIMSE-Composite
DIMSE-N	DIMSE-Normalized
DX	Digital X-Ray
EBE	DICOM Explicit VR Big Endian
ELE	DICOM Explicit VR Little Endian
FSC	File-set Creator
FSR	File-set Reader
FSU	File-set Updater
GUI	Graphic User Interface
HIS	Hospital Information System
HL7	Health Level Seven
ILE	DICOM Implicit VR Little Endian
IOD	Information Object Definition
ISIS	Information System - Imaging System
MOD	Magneto-Optical Disk
MPPS	Modality Performed Procedure Step
MR	Magnetic Resonance
MWL	Modality Worklist
NEMA	National Electrical Manufacturers Association
NM	Nuclear Medicine
PDU	Protocol Data Unit
Q/R	Query Retrieve
RF	X-Ray Radiofluoroscopic
RIS	Radiology Information System
RT	Radiotherapy
RWA	Real-World Activity
SC	Secondary Capture
SCM	Study Component Management
SCP	Service Class Provider

Abbreviation/Term	Explanation
SCU	Service Class User
SOP	Service Object Pair
TCP/IP	Transmission Control Protocol/Internet Protocol
UID	Unique Identifier
US	Ultrasound
USMF	Ultrasound Multi-frame
WLM	Worklist Management
XA	X-Ray Angiographic

3.5. References

[DICOM] Digital Imaging and Communications in Medicine, Parts 1 - 21 (NEMA PS 3.1- PS 3.21),
National Electrical Manufacturers Association (NEMA)
1300 North 17th Street
Suite 900
Arlington, Virginia 22209
Internet: <https://www.dicomstandard.org/current>

Note that at any point in time the official standard consists of the most recent yearly edition of the base standard (currently 2019) plus all the supplements and correction items that have been approved as Final Text.

4. Networking

This section contains the networking related services (vs. the media related ones).

4.1. Implementation model

The implementation model consists of three sections:

- The application data flow diagram, specifying the relationship between the Application Entities and the "external world" or Real-World Activities,
- A functional description of each Application Entity, and
- The sequencing constraints among them.

4.1.1. Application Data Flow

The CombiDiagnost R90 Rel 1.1 system consists of one single application entity, the CombiDiagnost R90 Rel 1.1 Application Entity (Eleva AE).

The figure below shows the networking application data flow as a functional overview of the Eleva AE.

It incorporates the following functionality:

- The Eleva AE can be verified by provided SCP and can verify by SCU.
- The Eleva AE can request a worklist by using the Basic Worklist Management service as SCU.
- The Eleva AE can store images by using the Storage service as SCU and use the Storage-Commit SOP-Class perform storage-commit as SCU.
- The Eleva AE can store Dose SR instances by using the Storage service as SCU.
- The Eleva AE can compose the modality performed procedure step by using the Study Management service as SCU.
- The Eleva AE can print images by using the Print Management service as SCU.
- The Eleva AE can Query and retrieve images from a remote DICOM node. In this way Eleva AE can also support importing of RAD images from Remote node.

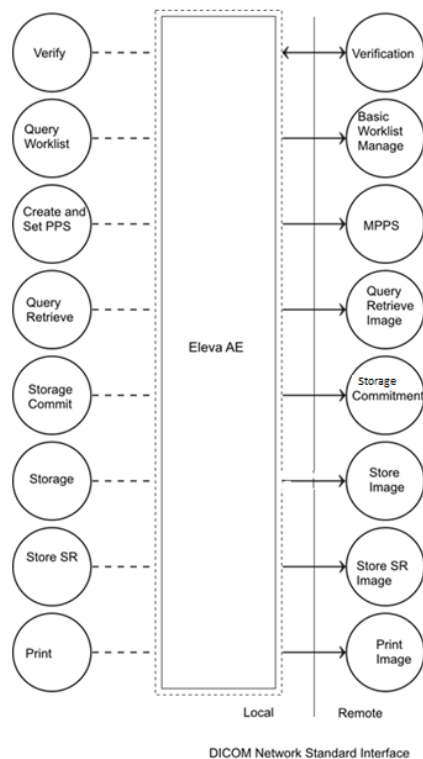

Figure 2: Application Data Flow Diagram

4.1.2. Functional Definition of AE's

This section contains a functional definition for each individual local Application Entity.

4.1.2.1 Functional Definition of Eleva AE

The Eleva AE is the one and only application entity within CombiDiagnost R90 Rel 1.1. It includes the following service classes.

Verification Service Class

The Eleva AE provides the Verification service as SCP.

A remote SCU sends an association request with the Eleva AE for Verification SOP class. After accepting the association the Eleva AE receives and responds to the Verification request and releases the association when requested.

Basic Worklist Management Service Class

The Eleva AE provides the Basic Worklist Management service as SCU.

Eleva AE requests an association with the configured remote Basic Worklist Management SCP. After accepting the association the Eleva AE sends worklist query, wait for response, and then release the association. The user interface will be updated with the query results.

Storage Service Class

The Eleva AE provides the Storage service as SCU.

After a performed procedure step the Eleva AE stores the related images and the created X-Ray DOSE Report to the configured Storage SCP. It requests an association with the remote Storage SCP for the applicable Storage SOP classes. After accepting the association the Eleva AE will send the store request, wait for response, and then releases the association.

After successful storage the user interface will be updated accordingly.

After successful storage, if selected, the Eleva AE requests storage commitment per Storage Commitment service (ref. Storage Commitment Service Class)

Remark: There is no X-RAY DOSE Report created for the following patient types:

- Emergency Patient
- Generator only mode
- Service Mode

Note: The Eleva AE can also provide Storage as SCP only as part of Query Retrieve service for the SOP classes described in image import section.

Storage Commitment Service Class

The Eleva AE provides the Storage Commitment service as SCU.

The Eleva AE requests an association with the selected remote SCP for the Storage Commitment Push Model SOP class. When the association is accepted, the Eleva AE will send the Storage Commitment requests receive the Storage Commitment responses and act accordingly, and release the association. When the remote commitment actions have been finished, the remote SCP will request an association with the Eleva AE (still SCU). After accepting the association, the Eleva AE receives the Storage Commitment reports, and releases the association when requested.

The Storage Commitment Service can be done synchronously and asynchronously.

A detailed specification of the Storage Commitment is described in section 4.2.1.3.6 (Real-World Activity: Storage Commitment Push Model as SCU).

Remark: Storage Commitment is not requested for the exported DOSE SR Report.

Query images

The Eleva AE as QR SCU implements the RWA Query images to find patients on a remote system.

Retrieve Images

The Eleva AE as QR SCU implements the RWA Retrieve images to initiate move of selected images from a remote system.

Modality Performed Procedure Step Service Class

The Eleva AE provides the Modality Performed Procedure Step as SCU.

Before performing a procedure step the Eleva AE will request an association with the configured remote MPPS SCP. After accepting the association the Eleva AE sends a create request, wait for response, and then releases the association.

After performing a procedure step the Eleva AE will request a new association to send a set request, and after response, release the association. Depending on the status of creates and set and the configuration the Eleva AE performs a retry. The user interface will be updated with the performed procedure step status.

Basic Grayscale Print Management Meta Class

The Eleva AE provides the Basic Grayscale Print Management service as SCU.

After a performed procedure step the Eleva AE will print the related images on the configured Printer. It requests an association with the remote Basic Grayscale Print Management SCP for the applicable Basic Grayscale Print Management SOP class. After accepting the association the Eleva AE sends the print request, waits for response, and then releases the association.

After successful printing the user interface shall be updated accordingly.

4.1.3. Sequencing of Real World Activities

The figure below shows a typical sequence of an examination using a worklist. The user updates the worklist (query Worklist) and then selects and opens an examination. When the user starts the examination (acquiring the first image), the RIS is notified (Create Performed Procedure Step). After the user confirmed each acquisition (image 1-N) per default the image is printed (Print Image) and Image is sent to archive (Store Image). Finally, when closing the examination, the RIS is notified to update the data of the examination (Set Performed Procedure Step). Note that Print Image will send images to the printer only when enough images were received to fulfill the configured printer format or when the print job is flushed manually. When the last image of an examination is received the print job will be flushed automatically. Storage Commitment will be requested directly after export. The Storage Commit N-EVENT-REPORT can be sent by PACS at any time (also after "Close Exam")

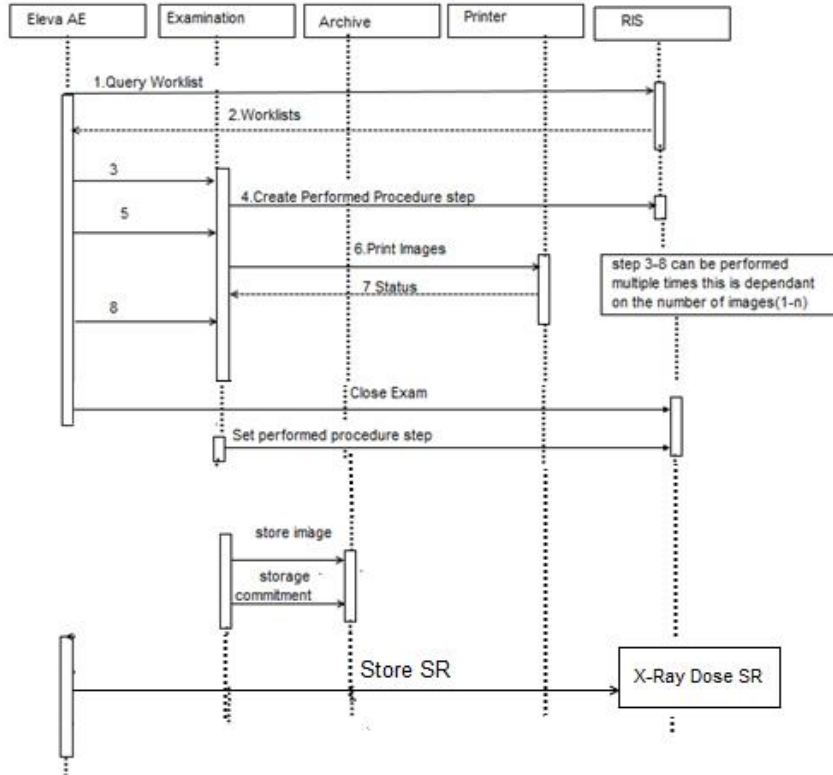

Figure 3: Sequence of an examination

4.1.3.1. Sequence of Query/Retrieve

The CombiDiagnost R90 Rel 1.1 can Query DICOM archives and Receive images locally. An association is established when the user initiates a query from the graphical user interface. The CombiDiagnost R90's Query/Retrieve SCU will establish an association to query a remote AE to obtain a list of relevant objects based on the user's inputs. When the user retrieves the needed objects, the remote AE establishes a connection with the CombiDiagnost R90 Rel 1.1's Storage SCP to store the images locally.

CombiDiagnost does not support Query Retrieve for X-Ray Radiofluoroscopic Image.

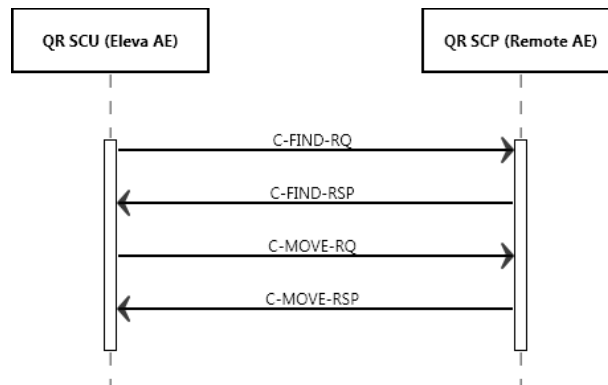

Figure 4: Sequence of Query/Retrieve

4.2. AE Specifications

This section in the DICOM Conformance Statement is a set of Application Entity specifications. There are as many of these subsections as there are different AE's in the implementation.

4.2.1. Eleva AE

Detail of this specific Application Entity is specified in this section.

4.2.1.1. SOP Classes

This Application Entity provides Standard Conformance to the following SOP Classes.

Table 5: SOP Classes for Eleva AE

SOP Class Name	SOP Class UID	SCU	SCP
Verification SOP Class	1.2.840.10008.1.1	Yes	Yes
Storage Commitment Push Model SOP Class	1.2.840.10008.1.20.1	Yes	No
Modality Performed Procedure Step SOP Class	1.2.840.10008.3.1.2.3.3	Yes	No
Computed Radiography Image Storage SOP Class	1.2.840.10008.5.1.4.1.1.1	Yes	Yes
Digital X-Ray Image Storage - For Pres. SOP	1.2.840.10008.5.1.4.1.1.1.1	Yes	Yes
Digital X-Ray Image Storage - For Proc. SOP	1.2.840.10008.5.1.4.1.1.1.1.1	Yes	Yes
Secondary Capture Image Storage SOP Class	1.2.840.10008.5.1.4.1.1.7	Yes	Yes
X-Ray Radiofluoroscopic Image Storage	1.2.840.10008.5.1.4.1.1.12.2	Yes	No
X-Ray Radiation Dose SR	1.2.840.10008.5.1.4.1.1.88.67	Yes	No
Modality Worklist Information Model - FIND SOP Class	1.2.840.10008.5.1.4.31	Yes	No
Basic Grayscale Print Management Meta SOP Class	1.2.840.10008.5.1.1.9	Yes	No
>Basic Film Box SOP Class	1.2.840.10008.5.1.1.2	Yes	No
>Basic Film Session SOP Class	1.2.840.10008.5.1.1.1	Yes	No
>Basic Grayscale Image Box SOP Class	1.2.840.10008.5.1.1.4	Yes	No
>Printer SOP Class	1.2.840.10008.5.1.1.16	Yes	No

Note: Any SOP specific behavior is documented later in the conformance statement in the applicable SOP specific conformance section.

4.2.1.2. Association Policies

Each AE specification contains a description of the general association establishment and acceptance policies of the AE.

4.2.1.2.1. General

The DICOM standard application context is specified below.

Table 6: DICOM Application Context

Description	Value
Application Context Name	1.2.840.10008.3.1.1.1

4.2.1.2.2. Number of Associations

The number of simultaneous associations that an Application Entity may support as an Initiator or Acceptor is specified here.

Table 7: Number of associations as an Association Initiator for this AE

Description	Value
Maximum number of simultaneous associations	3

Table 8: Number of associations as an Association Acceptor for this AE

Description	Value
Maximum number of simultaneous associations	1

4.2.1.2.3. Asynchronous Nature

The implementation supports negotiation of multiple outstanding transactions, along with the maximum number of outstanding transactions supported.

Table 9: Asynchronous nature as an Association Initiator for this AE

Description	Value
Maximum number of outstanding asynchronous transactions	No enforced limit

4.2.1.2.4. Implementation Identifying Information

The value supplied for Implementation Class UID and version name are documented here.

Table 10: DICOM Implementation Class and Version for Eleva AE

Implementation Class UID	1.3.46.670589.30.42.0
Implementation Version Name	PMS_ELEVA_42.0

4.2.1.2.5. Communication Failure Handling

The behavior of the AE during communication failure is summarized in the next table.

Table 11: Communication Failure Behavior

Exception	Behavior
Timeout	The Association is aborted using A-ABORT and command marked as failed. The reason is logged and reported to the user.
Association aborted	The command is marked as failed. The reason is logged and reported to the user.

4.2.1.3. Association Initiation Policy

The Application Entity will respond to a received Association rejection as shown in the table 12.

Table 12: Association Rejection response

Result	Source	Reason/Diagnosis	Behavior
1 - rejected-permanent	1 - DICOM UL service-user	1 - no-reason-given	
		2 - application-context-name-not supported	
		3 - calling-AE-title-not-recognized	
		7 - called-AE-title-not-recognized	
	2 - DICOM UL service-provider (ACSE related function)	1 - no-reason-given	
		2 - protocol-version-not-supported	
3 - DICOM UL service-provider (Presentation related function)	1 - temporary-congestion		
	2 - local-limit-exceeded		
2 - rejected-transient	1 - DICOM UL service-user	1 - no-reason-given	
		2 - application-context-name-not-supported	
		3 - calling-AE-title-not-recognized	
		7 - called-AE-title-not-recognized	
	2 - DICOM UL service-provider (ACSE related function)	1 - no-reason-given	
		2 - protocol-version-not-supported	
	3 - DICOM UL service-provider (Presentation related function)	1 - temporary-congestion	
		2 - local-limit-exceeded	

The behavior of the AE on receiving an Association abort is summarized in the next table.

Table 13: Association Abort Handling

Source	Reason/Diagnosis	Behavior
0 - DICOM UL service-user (initiated abort)	0 - reason-not-specified	
2 - DICOM UL service-provider (initiated abort)	0 - reason-not-specified	
	1 - unrecognized-PDU	
	2 - unexpected-PDU	
	4 - unrecognized-PDU-parameter	
	5 - unexpected-PDU-parameter	
	6 - invalid-PDU-parameter-value	

4.2.1.3.1. (Real-World) Activity – Verification as SCU

4.2.1.3.1.1. Description and Sequencing of Activities

The Eleva AE proposes the following presentation contexts to the remote AE during the association request before sending the C-ECHO

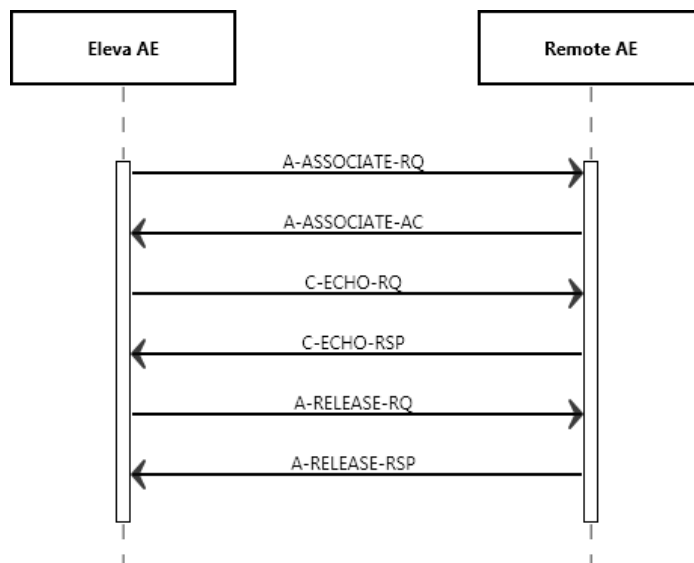

Figure 5: (Real World) Activity - Verification as SCU

Table 14: Proposed Presentation Contexts for (Real-World) Activity – Verification as SCU

Presentation Context Table					
Abstract Syntax		Transfer Syntax		Role	Extended Negotiation
Name	UID	Name List	UID List		
Verification SOP Class	1.2.840.10008.1.1	Explicit VR Big Endian	1.2.840.10008.1.2.2	SCU	None
		Explicit VR Little Endian	1.2.840.10008.1.2.1		
		Implicit VR Little Endian	1.2.840.10008.1.2		

4.2.1.3.1.2. SOP Specific Conformance for Verification SOP Class

This section and sub-section include the manufacturer SOP and Dataset specific information as well the status codes and their corresponding behavior.

4.2.1.3.1.2.1. Dataset Specific Conformance for Verification C-ECHO SCU

Detail regarding the Dataset Specific response behavior will be reported in this section.

This part of the section includes the dataset specific behavior, i.e. error codes, error and exception handling, time-outs, etc.

Table 15: Status Response

Service Status	Error Code	Further Meaning	Behavior
Success	0000	Confirmation	the SCU has successfully send C-ECHO
Other than success	<>0000	Problems with sending the C-ECHO	Reason is logged

4.2.1.3.2. (Real-World) Activity – Modality worklist As SCU

4.2.1.3.2.1. Description and Sequencing of Activities

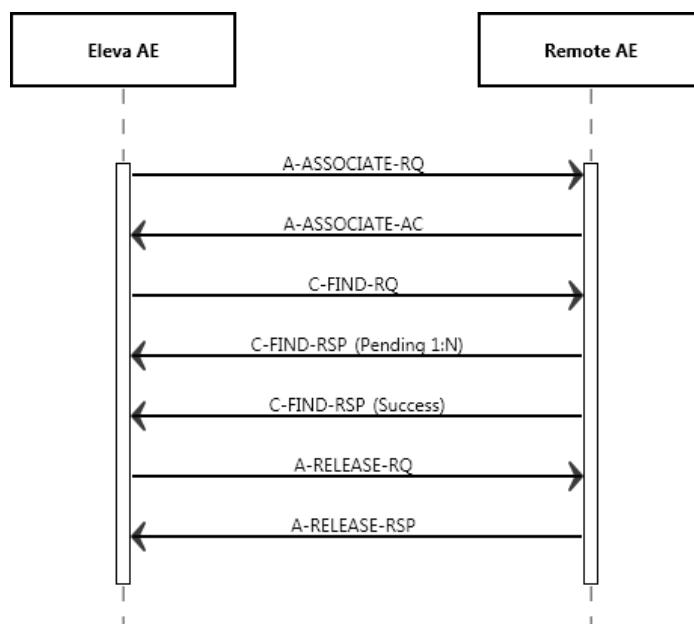

Figure 6: (Real World) Activity - Modality worklist As SCU

For each Broad or specific Worklist request, an association towards the Basic Worklist Management SCP is established and a C-FIND request is transmitted. The Broad query can be configured with a combination of the Matching Keys:

- Scheduled Station AE Title
- Scheduled Procedure Step Start Date
- Modality

Each of the matching keys is optional. The association will be closed on reception of the last C-FIND response. The Worklist Query result is displayed in the Patient List. The query is interruptible if it was triggered by the user.

After clicking the Query Worklist button the Eleva AE shall request an association with the configured remote Basic Worklist Management SCP. When the association is accepted the Eleva AE shall send the broad query find request, wait for response, and then release the association.

This RWA may be initiated in two ways:

After clicking the Patient button at the patient list screen the Eleva AE shall request an association with the configured remote Basic Worklist Management SCP. When the association is accepted the Eleva AE shall send the patient query find request, wait for response, and then release the association. Worklist request identifiers for Patient Query are shown in Table 17.

After clicking button for updating patient list the Eleva AE shall request an association with the configured remote Basic Worklist Management SCP. When the association is accepted the Eleva AE shall send the Broad Query find request, wait for response, and then release the association. Worklist request identifiers for Broad Query are shown in Table 18.

Optionally the Broad Query may also be performed automatically in the system background. The time interval between subsequent background queries is configurable.

Manual and automatic background queries are serialized and do not interfere with another.

4.2.1.3.2.2. Proposed Presentation Contexts

The presentation contexts are defined in table 16.

Table 16: Proposed Presentation Contexts for (Real-World) Activity – Modality worklist As SCU

Presentation Context Table					
Abstract Syntax		Transfer Syntax		Role	Extended Negotiation
Name	UID	Name List	UID List		
Modality Worklist Information Model - FIND SOP Class	1.2.840.10008.5.1.4.31	Explicit VR Big Endian	1.2.840.10008.1.2.2	SCU	None
		Explicit VR Little Endian	1.2.840.10008.1.2.1		
		Implicit VR Little Endian	1.2.840.10008.1.2		

4.2.1.3.2.3. SOP Specific Conformance for Modality Worklist Information Model - FIND SOP Class

This section and sub-section include the manufacturer SOP and Dataset specific information as well the status codes and their corresponding behavior.

4.2.1.3.2.3.1. Dataset Specific Conformance for Modality Worklist Information Model - FIND SOP Class C-FIND-SCU

Detail regarding the Dataset Specific response behavior will be reported in this section.

This part of the section includes the dataset specific behavior, i.e. error codes, error and exception handling, time-outs, etc.

The table below should be read as follows:

Attribute Name:	Attributes supported to build a Modality Worklist Request Identifier.
Tag:	DICOM tag for this attribute.
VR:	DICOM VR for this attribute.
M:	Matching Keys for (automatic) Worklist Update.
R:	Return Keys. An "X" will indicate that Modality will supply this attribute as Return Key with zero length for Universal Matching.
Q:	Interactive Query Key. An "X" will indicate that this attribute as matching key can be used.
D:	Displayed Keys. An "X" indicates that this Worklist attribute is displayed to the user during a patient registration dialog.
IOD:	An "X" indicates that the value of this Worklist attribute will be used in the created Instances of this Performed Procedure Step.
Type of matching:	The following types of matching exists: Single Value Matching List of UID Matching Wild Card Matching Range Matching Sequence Matching Universal Matching

Table 17: Worklist Request Identifier (Patient Query).

Attribute Name	Tag	VR	M	R	Q	D	IOD	Type of Matching	Comment
Patient Identification Module									
Medical Record Locator	0010,1090	LO							
Other Patient IDs	0010,1000	LO		X					
Other Patient Names	0010,1001	PN							
Patient ID	0010,0020	LO		X	X	X	X	Single Value, Universal	
Patient's Birth Name	0010,1005	PN							

Patient's Mother's Birth Name	0010,1060	PN								
Patient's Name	0010,0010	PN	X	X	X	X	X		Single Value, Wildcard	
Issuer of Patient ID	0010,0021	LO								
Patient Demographic Module										
Branch of Service	0010,1081	LO								
Confidentiality Constraint on Patient Data Description	0040,3001	LO								
Country of Residence	0010,2150	LO								
Ethnic Group	0010,2160	SH								
Military Rank	0010,1080	LO								
Occupation	0010,2180	SH								
Patient Comments	0010,4000	LT								
Patient's Address	0010,1040	LO								
Patient's Age	0010,1010	AS								
Patient's Birth Date	0010,0030	DA		X			X			
Patient's Birth Time	0010,0032	TM								
Patient's Religious Preference	0010,21F0	LO								
Patient's Sex	0010,0040	CS		X			X			
Patient's Size	0010,1020	DS		X						
Patient's Telephone Numbers	0010,2154	SH								
Patient's Weight	0010,1030	DS		X						
Region of Residence	0010,2152	LO								
Patient's Insurance Plan Code Sequence	0010,0050	SQ								
>Code Meaning	0008,0104	LO								
>Code Value	0008,0100	SH								
>Coding Scheme Designator	0008,0102	SH								
>Coding Scheme Version	0008,0103	SH								
>Context Group Extension Creator UID	0008,010D	UI								
>Context Group Local Version	0008,0107	DT								
>Context Group Version	0008,0106	DT								
>Mapping Resource	0008,0105	CS								
Patient Medical Module										
Additional Patient History	0010,21B0	LT								
Allergies	0010,2110	LO								
Last Menstrual Date	0010,21D0	DA								
Medical Alerts	0010,2000	LO		X						
Patient State	0038,0500	LO		X						
Pregnancy Status	0010,21C0	US								
Smoking Status	0010,21A0	CS								
Special Needs	0038,0050	LO								
Visit Identification Module										
Admission ID	0038,0010	LO		X						
Institution Address	0008,0081	ST								
Institution Name	0008,0080	LO								
Issuer of Admission ID Sequence	0038,0014	SQ								
>Local Namespace Entity ID	0040,0031	UT								

>Universal Entity ID	0040,0032	UT							
>Universal Entity ID Type	0040,0033	CS							
Issuer of Service Episode ID Sequence	0038,0064	SQ							
>Local Namespace Entity ID	0040,0031	UT							
>Universal Entity ID	0040,0032	UT							
>Universal Entity ID Type	0040,0033	CS							
Visit Status Module									
Current Patient Location	0038,0300	LO	X						
Patient's Institution Residence	0038,0400	LO							
Visit Comments	0038,4000	LT							
Visit Status ID	0038,0008	CS							
Visit Admission Module									
Admitting Date	0038,0020	DA							
Admitting Time	0038,0021	TM							
Referring Physician's Address	0008,0092	ST							
Referring Physician's Name	0008,0090	PN	X						
Referring Physician's Telephone Numbers	0008,0094	SH							
Route of Admissions	0038,0016	LO							
Admitting Diagnoses Code Sequence	0008,1084	SQ							
>Code Meaning	0008,0104	LO							
>Code Value	0008,0100	SH							
>Coding Scheme Designator	0008,0102	SH							
>Coding Scheme Version	0008,0103	SH							
Scheduled Procedure Step Module									
Scheduled Procedure Step Sequence	0040,0100	SQ	X						
>Comments on the Scheduled Procedure Step	0040,0400	LT							
>Modality	0008,0060	CS	X	X	X	X	Single Value, Universal	SOP Classes: CR, DX, OT, US, MG, RF, XA, PX, NM	
>Pre-Medication	0040,0012	LO							
>Requested Contrast Agent	0032,1070	LO							
>Scheduled Performing Physician's Name	0040,0006	PN	X						
>Scheduled Procedure Step Description	0040,0007	LO	X		X	X			
>Scheduled Procedure Step End Date	0040,0004	DA							
>Scheduled Procedure Step End Time	0040,0005	TM							
>Scheduled Procedure Step ID	0040,0009	SH	X			X			
>Scheduled Procedure Step Location	0040,0011	SH							
>Scheduled Procedure Step Start Date	0040,0002	DA	X		X	X	Single Value, Universal	Value: All, Today, Tomorrow, Yesterday	
>Scheduled Procedure Step Start Time	0040,0003	TM	X						
>Scheduled Procedure Step Status	0040,0020	CS	X						

>Scheduled Station AE Title	0040,0001	AE	X	X	X				Single Value, Universal
>Scheduled Station Name	0040,0010	SH		X		X			
>Scheduled Protocol Code Sequence	0040,0008	SQ		X					
>>Code Meaning	0008,0104	LO		X					
>>Code Value	0008,0100	SH		X					
>>Coding Scheme Designator	0008,0102	SH		X					
>>Coding Scheme Version	0008,0103	SH		X					
Requested Procedure Module									
Requested Procedure Description	0032,1060	LO		X		X			
Requested Procedure ID	0040,1001	SH	X	X	X	X	X		Single Value, Universal
Study Date	0008,0020	DA							
Study Instance UID	0020,000D	UI		X			X		
Referenced Study Sequence	0008,1110	SQ		X					
>Referenced SOP Class UID	0008,1150	UI		X			X		
>Referenced SOP Instance UID	0008,1155	UI		X			X		
Requested Procedure Code Sequence	0032,1064	SQ		X					
>Code Meaning	0008,0104	LO		X					
>Code Value	0008,0100	SH		X					
>Coding Scheme Designator	0008,0102	SH		X					
>Coding Scheme Version	0008,0103	SH		X					
>Context Group Extension Creator UID	0008,010D	UI							
>Context Group Local Version	0008,0107	DT							
>Context Group Version	0008,0106	DT							
>Mapping Resource	0008,0105	CS							
Imaging Service Request Module									
Accession Number	0008,0050	SH	X	X	X	X	X		Single Value, Universal
Imaging Service Request Comments	0040,2400	LT							
Issue Date of Imaging Service Request	0040,2004	DA							
Reason for the Imaging Service Request (retired)	0040,2001	LO		X					
Referring Physician's Name	0008,0090	PN		X					
Requesting Physician	0032,1032	PN		X					
Requesting Service	0032,1033	LO		X					

Table 18: C-FIND-RQ Status Response

Service Status	Code	Further Meaning	Behavior
Success	0000	Matching is complete	The Worklist is updated.
Failure	A700	Refused – Out of resources	The association is released. The reason is logged.
	A900	Failed – Identifier does not match SOP class	The association is released. The reason is logged.

Service Status	Code	Further Meaning	Behavior
	Cxxx	Failed – Unable to process	The association is released. The reason is logged.
Cancel	FE00	Matching terminated due to Cancel request	The association is released. The reason is logged.
Pending	FF00	Matches are continuing – Current match is supplied and any optional keys were supported in the same manner as required keys	The Query Worklist job continues.
	FF01	Matches are continuing – Warning that one or more optional keys were not supported for existence and/or matching for this identifier	The Query Worklist job continues.

Table 19: DICOM Command Communication Failure Behavior

Exception	Behavior
RIS query timeout (default 240 seconds)	The Association is aborted using A-ABORT and command marked as failed. The reason is logged and reported to the user.
Association aborted	The command is marked as failed. The reason is logged and reported to the user.

4.2.1.3.2.4. Patient and Study Merge

The Eleva AE looks in its internal database for a Study with the same Study Instance UID (0020, 000D) as given in the Scheduled Procedure Step.

The Patient identifying attributes are DICOM 'Patient ID' (0010, 0020) together with DICOM 'Issuer of Patient ID' (0010, 0021). If a Patient with matching identifying attributes was found, attributes are updated for the internal Patient based on the attributes as given in the Scheduled Procedure Step. The update for the Patient attributes can be disabled in PSC tool (Configuration->Network->External nodes-> Worklist management (WLM) ->Patient information reconciliation).

A Patient is secured from changes if it is

- 1) Selected for acquisition or
- 2) At least one image was already acquired.

A new Study with a Study Instance UID as given in the Scheduled Procedure Step is created.

If a Study Instance UID match was found, all Patient attributes as given in the Scheduled Procedure Step are updated in the internal database for the parent patient of this study. Study attributes are updated for the internal study based on the attributes as given in the Scheduled Procedure Step.

4.2.1.3.2.5. Scheduled Procedure Step (= Examination) Merge

If the Eleva AE's internal database contains no SPS with Scheduled Procedure Step ID (0040, 0009) identifying an incoming Scheduled Procedure Step, it creates a new one and creates a corresponding Examination referencing this Scheduled Procedure Step ID.

If the Eleva AE's internal database contains already an SPS with the Scheduled Procedure Step ID (0040, 0009) identifying an incoming Scheduled Procedure Step, the behavior depends on the corresponding Examination state.

If the Examination is still "scheduled", the SPS attributes are compared to the attributes sent with the most recent WLM query. If at least one attribute differs, the scheduled Examination is deleted and re-scheduled. Manual changes the user might have performed on this Examination are lost.

If the Examination has already started, no changes are performed, and the potential changes of the incoming Scheduled Procedure Step are disregarded.

4.2.1.3.2.5.1. Dataset Specific Conformance for Modality Worklist (Broad Query) C-FIND SCU

The table below should be read as follows:

Attribute Name:	Attributes supported to build a Modality Worklist Request Identifier.
Tag:	DICOM tag for this attribute.
VR:	DICOM VR for this attribute.
M:	Matching Keys for (automatic) Worklist Update.
R:	Return Keys. An "X" will indicate that this attribute can be used as Matching Key for Universal Matching.
Q:	Interactive Query Key. An "X" will indicate that this attribute as matching key can be used.
D:	Displayed Keys. An "X" indicates that this Worklist attribute is displayed to the user during a patient registration dialog.
IOD:	An "X" indicates that the value of this Worklist attribute will be used in the created Instances of this Performed Procedure Step.
Type of matching:	The following types of matching exists: Single Value Matching List of UID Matching Wild Card Matching Range Matching Sequence Matching Universal Matching

Table 20: Worklist Request Identifier (Broad Query)

Attribute Name	Tag	VR	M	R	Q	D	IOD	Type of Matching	Comment
Patient Identification Module									
Patient's Name	0010,0010	PN	X	X	X	X	X		Last name, First name, Prefix, Middle name, Suffix
Patient ID	0010,0020	LO		X	X	X	X		
Issuer of Patient ID	0010,0021	LO							
Other Patient IDs	0010,1000	LO		X					
Patient Demographic Module									
Patient's Birth Date	0010,0030	DA		X			X		
Patient's Sex	0010,0040	CS		X			X		
Patient's Age	0010,1010	AS							
Patient's Size	0010,1020	DS		X					
Patient's Weight	0010,1030	DS		X					
Ethnic Group	0010,2160	SH							
Occupation	0010,2180	SH							
Patient Comments	0010,4000	LT							
Confidentiality Constraint on Patient Data Description	0040,3001	LO							
Patient Medical Module									
Medical Alerts	0010,2000	LO		X					
Allergies	0010,2110	LO							
Additional Patient History	0010,21B0	LT							

Attribute Name	Tag	VR	M	R	Q	D	IOD	Type of Matching	Comment
Pregnancy Status	0010,21C0	US							
Special Needs	0038,0050	LO							
Patient State	0038,0500	LO		X					
Visit Status Module									
Current Patient Location	0038,0300	LO		X					
Scheduled Procedure Step Module									
Scheduled Procedure Step Sequence	0040,0100	SQ		X					
>Modality	0008,0060	CS	X					Single Value, Universal	
>Requested Contrast Agent	0032,1070	LO		X					
>Scheduled Station AE Title	0040,0001	AE						Single Value, Universal	
>Scheduled Procedure Step Start Date	0040,0002	DA		X	X	X	X	Single Value, Universal	
>Scheduled Procedure Step Start Time	0040,0003	TM							
>Scheduled Procedure Step End Date	0040,0004	DA							
>Scheduled Procedure Step End Time	0040,0005	TM		X					
>Scheduled Performing Physician's Name	0040,0006	PN		X		X	X		
>Scheduled Procedure Step Description	0040,0007	LO							
>Scheduled Procedure Step ID	0040,0009	SH							
>Scheduled Station Name	0040,0010	SH		X			X		
>Scheduled Procedure Step Location	0040,0011	SH							
>Pre-Medication	0040,0012	LO	X		X	X			
>Scheduled Procedure Step Status	0040,0020	CS		X					
>Comments on the Scheduled Procedure Step	0040,0400	LT		X					
>Scheduled Protocol Code Sequence	0040,0008	SQ	X	X	X				
>>Code Value	0008,0100	SH		X		X			
>>Coding Scheme Designator	0008,0102	SH		X					
>>Coding Scheme Version	0008,0103	SH		X					
>>Code Meaning	0008,0104	LO		X					
Requested Procedure Module									
Study Instance UID	0020,000D	UI		X			X		
Requested Procedure Description	0032,1060	LO		X		X			
Requested Procedure ID	0040,1001	SH	X	X	X	X	X		
Reason for the Requested Procedure	0040,1002	LO							
Requested Procedure Priority	0040,1003	SH							
Patient Transport Arrangements	0040,1004	LO							

Attribute Name	Tag	VR	M	R	Q	D	IOD	Type of Matching	Comment
Names of Intended Recipients of Results	0040,1010	PN							
Requested Procedure Comments	0040,1400	LT							
Referenced Study Sequence	0008,1110	SQ		X					
>Referenced SOP Class UID	0008,1150	UI		X			X		
>Referenced SOP Instance UID	0008,1155	UI		X			X		
Requested Procedure Code Sequence	0032,1064	SQ		X					
>Code Value	0008,0100	SH		X					
>Coding Scheme Designator	0008,0102	SH		X					
>Coding Scheme Version	0008,0103	SH		X					
>Code Meaning	0008,0104	LO		X					
Imaging Service Request Module									
Accession Number	0008,0050	SH	X	X	X	X	X		
Referring Physician's Name	0008,0090	PN		X					
Requesting Physician	0032,1032	PN		X					
Requesting Service	0032,1033	LO		X					
Reason for the Imaging Service Request (RETIRED)	0040,2001	LO		X					
Issue Date of Imaging Service Request	0040,2004	DA							
Imaging Service Request Comments	0040,2400	LT							

Table 21: Status Response

Service Status	Error Code	Further Meaning	Behavior
Success	0000	Matching is complete	The SCU has successfully returned all matching information

4.2.1.3.3. (Real-World) Activity – Modality Performed Procedure Step as SCU

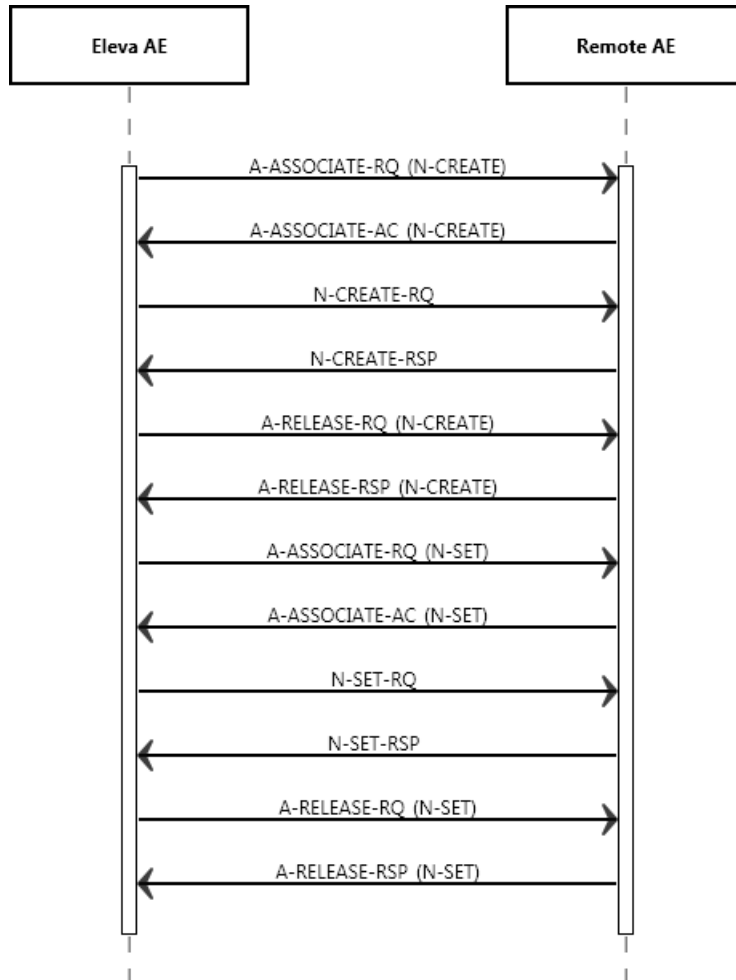

Figure 7: Modality Performed Procedure Step as SCU

4.2.1.3.3.1. Description and Sequencing of Activities

A CombiDiagnost R90 Rel 1.1 “Examination” is regarded equivalent to a DICOM Procedure Step. It is scheduled or manually entered before an acquisition is taken, and performed by taking acquisitions. If scheduled by the RIS, one Examination is the result of one Scheduled Procedure Step. Since an examination may not be re-opened after having been closed, and each examination workflow context is enclosed in one MPPS, one examination may result in more than one N-SET instances that happens in case of appending an image for existing examination which is already closed.

After the image for a Scheduled Procedure Step has been acquired, the system sets the MPPS status of the related examination to “IN PROGRESS” and generates an initial MPPS IN PROGRESS message. The system does not generate intermediate MPPS IN PROGRESS messages for subsequent acquisitions of this Scheduled Procedure Step instance.

After finishing the appropriate acquisition(s), the system will change the MPPS status of the related examination to “COMPLETED” and generate an MPPS N-SET-COMPLETED message.

CombiDiagnost R90 Rel 1.1 also generates MPPS messages for unscheduled examinations.

The MPPS COMPLETED message will list the UID’s of all related DICOM archived images and the format of (optionally) generated direct prints.

After abandoning or discontinuing a procedure step, the operator may set the MPPS status of the related examination to “DISCONTINUED” and the system generates a MPPS DISCONTINUED message. The reason for abandoning or discontinuing a procedure step is unspecified.

The operator may interchange the performed sequence order of scheduled procedure steps.

MPPS messages may interleave. Depending on the application workflow optimization by the user, an MPPS sequence like this may come up:

MPPS / SOP Instance UID 1: N-CREATE (IN PROGRESS)
 MPPS / SOP Instance UID 2: N-CREATE (IN PROGRESS)
 MPPS / SOP Instance UID 3: N-CREATE (IN PROGRESS)
 ...
 MPPS / SOP Instance UID 2: N-SET (COMPLETED)
 MPPS / SOP Instance UID 1: N-SET (COMPLETED)
 MPPS / SOP Instance UID 3: N-SET (COMPLETED)

(i.e.: running multiple procedure steps ‘in parallel’).

Sequencing of Activities

After storing a performed procedure step the Eleva AE shall request an association with the configured remote Study Management SCP. After accepting the association the Eleva AE shall send a Create request, wait for response, and then release the association.

4.2.1.3.3.2. Proposed Presentation Contexts

The presentation contexts are defined in the next table.

Table 22: Proposed Presentation Contexts for (Real-World) Activity – Modality Performed Procedure Step As SCU

Presentation Context Table					
Abstract Syntax		Transfer Syntax		Role	Extended Negotiation
Name	UID	Name List	UID List		
Modality Performed Procedure Step SOP Class	1.2.840.10008.3.1.2.3.3	Explicit VR Big Endian	1.2.840.10008.1.2.2	SCU	None
		Explicit VR Little Endian	1.2.840.10008.1.2.1		
		Implicit VR Little Endian	1.2.840.10008.1.2		

4.2.1.3.3.3. SOP Specific Conformance for Modality Performed Procedure Step SOP Class

When acquiring the first image of a Scheduled or Unscheduled Procedure Step, CombiDiagnost R90 Rel 1.1 generates a MPPS IN PROGRESS message.

CombiDiagnost R90 Rel 1.1 does not generate intermediate IN PROGRESS (N-SET) messages and does not support the Performed Procedure Step Exception Management Option. CombiDiagnost R90 Rel 1.1 has no Billing Code Tables and does not support the Performed Procedure Step Billing and Material Management Option, except default values for Medium Type (2000,0030) and Film Size ID (2010,0050), if optional Local Print is configured.

Assisted Acquisition Protocol Setting Option

Eleva AE by default derives the specific acquisition protocol from the Scheduled Protocol Code Sequence Items. Any single Item results in an Examination.

Eleva AE supports 3 more (configurable) mapping relations, as shown below:

- Examination is selected from Scheduled Protocol Code Items->Code Value (0040, 0008) (default)

- Examination is selected from Scheduled Procedure Step Description (0040, 0007)
- Examination is selected from Requested Procedure Code Items->Code Value (0032, 1064)
- Examination is selected from Requested Procedure Description (0032, 1060)

Eleva AE does not evaluate the attributes Coding Scheme Version (0008, 0103), Coding Scheme Designator (0008, 0102), Code Meaning (0008, 0104), but only the Code Value (0008, 0100), for mapping the examination settings. I.e. Eleva AE expects that any used Code Value is unique (unambiguous) within a given RIS domain.

Restrictions Depending on Number of Scheduled Protocol Code Items

It is highly recommended that the Scheduled Procedure Step contains only 1 Item in the Scheduled Protocol Code Sequence.

If the Scheduled Procedure Step contains <n> items in the Scheduled Protocol Code Sequence, the Scheduled Procedure Step is split into <n> examinations, where any single examination shows only 1 of the Scheduled Protocol Code Items, but all the other attributes are the same.

When such an examination is returned back via MPPS, also the Performed Protocol Code Sequence will show only 1 item. If all <n> Scheduled Procedure Step Code Items are performed, <n> MPPS instances will be sent back to the RIS, and the sum of all Performed Protocol Code Items will be <n>.

4.2.1.3.3.3.1. Dataset Specific Conformance for Modality Performed Procedure Step SOP Class N-CREATE-SCU

Table 23: MPPS Request Identifiers for N-CREATE-RQ

Attribute Name	Tag	VR	Value	Comment
Performed Procedure Step Information Module				
Performed Station AE Title	0040,0241	AE	Eleva	Value can be configured
Performed Procedure Step Start Date	0040,0244	DA		Start of the examination
Performed Procedure Step Start Time	0040,0245	TM		Start of the examination
Performed Procedure Step Status	0040,0252	CS		
Performed Procedure Step ID	0040,0253	SH		
Performed Station Name	0040,0242	SH		EMPTY
Performed Location	0040,0243	SH		EMPTY
Performed Procedure Step End Date	0040,0250	DA		Finish of the examination
Performed Procedure Step End Time	0040,0251	TM		Finish of the examination
Performed Procedure Step Description	0040,0254	LO		
Performed Procedure Type Description	0040,0255	LO		
Procedure Code Sequence	0008,1032	SQ		
>Code Value	0008,0100	SH		
>Coding Scheme Designator	0008,0102	SH		
>Coding Scheme Version	0008,0103	SH		
>Code Meaning	0008,0104	LO		
Radiation Dose Module				
Image and Fluoroscopy Area Dose Product	0018,115E	DS		Not sent in case of appended MPPS Instances
Total Number of Exposures	0040,0301	US		
Entrance Dose	0040,0302	US		Note 1

.Attribute Name	Tag	VR	Value	Comment
Exposure Dose Sequence	0040,030E	SQ		
Entrance Dose in mGy	0040,8302	DS		Note 1
Performed Procedure Step Relationship Module				
Patient's Name	0010,0010	PN		
Patient ID	0010,0020	LO		
Issuer of Patient ID	0010,0021	LO		
Patient's Birth Date	0010,0030	DA		
Patient's Sex	0010,0040	CS		
Scheduled Step Attributes Sequence	0040,0270	SQ		
>Study Instance UID	0020,000D	UI		
>Accession Number	0008,0050	SH		
>Requested Procedure Description	0032,1060	LO		
>Scheduled Procedure Step Description	0040,0007	LO		
>Scheduled Procedure Step ID	0040,0009	SH		
>Requested Procedure ID	0040,1001	SH		
>Referenced Study Sequence	0008,1110	SQ		
>>Referenced SOP Class UID	0008,1150	UI		
>>Referenced SOP Instance UID	0008,1155	UI		
>Scheduled Protocol Code Sequence	0040,0008	SQ		
>>Code Value	0008,0100	SH		
>>Coding Scheme Designator	0008,0102	SH		
>>Code Meaning	0008,0104	LO		
Referenced Patient Sequence	0008,1120	SQ		
Image Acquisition Results Module				
Modality	0008,0060	CS	DX	
Study ID	0020,0010	SH		
Performed Protocol Code Sequence	0040,0260	SQ		
>Code Value	0008,0100	SH		
>Coding Scheme Designator	0008,0102	SH		
>Code Meaning	0008,0104	LO		
Performed Series Sequence	0040,0340	SQ		
Billing And Material Management Code Module				
Film Consumption Sequence	0040,0321	SQ		

Note 1: Attribute only present in case MPPS extended mode is enabled.

Table 24: N-CREATE-RQ Status Response

Service Status	Code	Further Meaning	Behavior
Success	0000	Successful operation	The SCP has successfully received the modality performed procedure step create request. Log entry.

4.2.1.3.3.3.2. Dataset Specific Conformance for Modality Performed Procedure Step SOP Class N-SET-SCU

Table 25: MPPS Request Identifiers for N-SET-RQ

Attribute Name	Tag	VR	Value	Comment
Performed Procedure Step Information Module				
Performed Procedure Step End Date	0040,0250	DA		
Performed Procedure Step End Time	0040,0251	TM		
Performed Procedure Step Status	0040,0252	CS	COMPLETED or DISCONTINUED	
Performed Procedure Step Description	0040,0254	LO		
Procedure Code Sequence	0008,1032	SQ		
>Code Value	0008,0100	SH		
>Coding Scheme Designator	0008,0102	SH		
>Code Meaning	0008,0104	LO		
Radiation Dose Module				
Image and Fluoroscopy Area Dose Product	0018,115E	DS		Not accumulating: re-processed images, non-digital images. Not sent in case of appended MPPS instances.
Total Time of Fluoroscopy	0040,0300	US		
Total Number of Exposures	0040,0301	US		Not accumulating: re-processed images, non-digital images. Not sent in case of appended MPPS instances.
Entrance Dose	0040,0302	US		Note 1
Exposure Dose Sequence	0040,030E	SQ		
>KVP	0018,0060	DS		
>Exposure Time	0018,1150	IS		
>Radiation Mode	0018,115A	CS		
>X-Ray Tube Current in uA	0018,8151	DS		
>Comments on Radiation Dose	0040,0310	ST		Note 1
Entrance Dose in mGy	0040,8302	DS		
Image Acquisition Results Module				
Performed Protocol Code Sequence	0040,0260	SQ		
>Code Value	0008,0100	SH		
>Coding Scheme Designator	0008,0102	SH		
>Code Meaning	0008,0104	LO		
Performed Series Sequence	0040,0340	SQ		
>Protocol Name	0018,1030	LO		Copied from Performed Protocol Code Sequence - Item code Value.
>Series Instance UID	0020,000E	UI		
>Retrieve AE Title	0008,0054	AE		
>Series Description	0008,103E	LO		
>Performing Physician's Name	0008,1050	PN		
>Operators' Name	0008,1070	PN		
>Referenced Image Sequence	0008,1140	SQ		
>>Referenced SOP Class UID	0008,1150	UI		
>>Referenced SOP Instance UID	0008,1155	UI		
>Referenced Non-Image Composite SOP Instance Sequence	0040,0220	SQ		

Attribute Name	Tag	VR	Value	Comment
Billing And Material Management Code Module				
Film Consumption Sequence	0040,0321	SQ		
>Medium Type	2000,0030	CS		
>Film Size ID	2010,0050	CS		
>Number of Films	2100,0170	IS		

Note 1: Attribute only present in case MPPS extended mode is enabled.

Table 26: N-SET-RQ Status Response

Service Status	Code	Further Meaning	Behavior
Success	0000	Successful operation	The SCP has successfully received the modality performed procedure step create request. Log entry.

4.2.1.3.4. (Real-World) Activity – Image Export

4.2.1.3.4.1. Description and Sequencing of Activities

Image import is supported as part of Query Retrieve for the RAD images mentioned in Table 43.

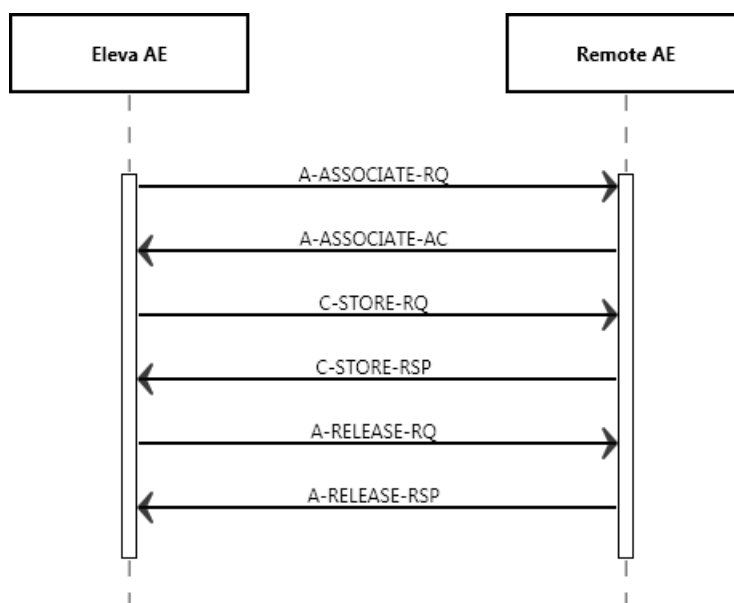

Figure 8: (Real World) Activity - Image Export

4.2.1.3.4.2. Proposed Presentation Contexts

The presentation contexts are defined in the next table.

Table 27: Proposed Presentation Contexts for (Real-World) Activity – Image Export

Presentation Context Table					
Abstract Syntax		Transfer Syntax		Role	Extended Negotiation
Name	UID	Name List	UID List		
	1.2.840.10008.5.1.4.1.1.1	Explicit VR Big Endian	1.2.840.10008.1.2.2	SCU	None

Presentation Context Table					
Abstract Syntax		Transfer Syntax		Role	Extended Negotiation
Name	UID	Name List	UID List		
Computed Radiography Image Storage SOP Class		Explicit VR Little Endian	1.2.840.10008.1.2.1		
		Implicit VR Little Endian	1.2.840.10008.1.2		
Digital X-Ray Image Storage - For Pres. SOP	1.2.840.10008.5.1.4.1.1.1.1	Explicit VR Big Endian	1.2.840.10008.1.2.2	SCU	None
		Explicit VR Little Endian	1.2.840.10008.1.2.1		
		Implicit VR Little Endian	1.2.840.10008.1.2		
Digital X-Ray Image Storage - For Proc. SOP	1.2.840.10008.5.1.4.1.1.1.1.1	Explicit VR Big Endian	1.2.840.10008.1.2.2	SCU	None
		Explicit VR Little Endian	1.2.840.10008.1.2.1		
		Implicit VR Little Endian	1.2.840.10008.1.2		
Secondary Capture Image Storage SOP Class	1.2.840.10008.5.1.4.1.1.7	Explicit VR Big Endian	1.2.840.10008.1.2.2	SCU	None
		Explicit VR Little Endian	1.2.840.10008.1.2.1		
		Implicit VR Little Endian	1.2.840.10008.1.2		
X-Ray Radiation Dose SR	1.2.840.10008.5.1.4.1.1.88.67	Explicit VR Big Endian	1.2.840.10008.1.2.2	SCU	None
		Explicit VR Little Endian	1.2.840.10008.1.2.1		
		Implicit VR Little Endian	1.2.840.10008.1.2		
X-Ray Radiofluoroscopic Image Storage SOP Class	1.2.840.10008.5.1.4.1.1.12.2	Explicit VR Big Endian	1.2.840.10008.1.2.2	SCU	None
		Explicit VR Little Endian	1.2.840.10008.1.2.1		
		Implicit VR Little Endian	1.2.840.10008.1.2		

4.2.1.3.5. (Real-World) Activity – Structured Dose Report Export

4.2.1.3.5.1. Description and Sequencing of Activities

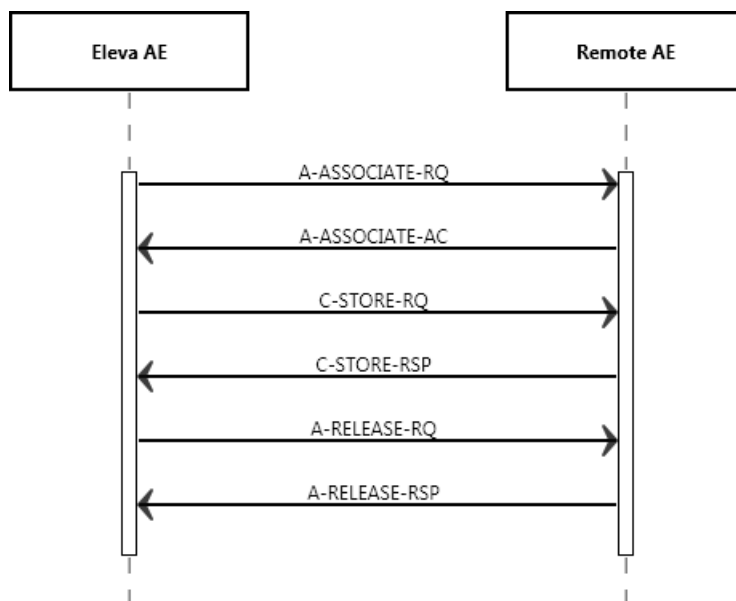

Figure 9: (Real World) Activity – Structured Dose Report Export

The Eleva AE will request an association with the remote Storage SCP for the applicable Storage SOP classes. After accepting the association, the Eleva AE will send the store request, wait for response, and then release the association. The store response status may be inspected on the UI.

4.2.1.3.5.2. Proposed Presentation Contexts

The presentation contexts are defined in the table 28.

Table 28: Proposed Presentation Contexts for (Real-World) Activity – Image Export

Presentation Context Table					
Abstract Syntax		Transfer Syntax		Role	Extended Negotiation
Name	UID	Name List	UID List		
X-Ray Radiation Dose SR	1.2.840.10008.5.1.4.1.1.88.67	Explicit VR Big Endian	1.2.840.10008.1.2.2	SCU	None
		Explicit VR Little Endian	1.2.840.10008.1.2.1		
		Implicit VR Little Endian	1.2.840.10008.1.2		

4.2.1.3.5.3. SOP Specific Conformance for Storage SOP Classes

This section and sub-section include the manufacturer SOP and Dataset specific information as well the status codes and their corresponding behavior.

4.2.1.3.5.3.1. Dataset Specific Conformance for C-STORE-RQ

Detail regarding the Dataset Specific response behavior will be reported in this section.

This includes the dataset specific behavior, i.e. error codes, error and exception handling, time-outs, etc.

Table 29: Status Response

Service Status	Code	Further Meaning	Behavior
Success	0000	Storage is complete	UI status is updated
Refused	A700	Out of resources	The association is released. On receiving error in C-STORE RSP messages store operation is unsuccessful
Error	A900	Data set does not match SOP class	The association is released. On receiving error in C-STORE RSP messages store operation is unsuccessful.
	C000	Cannot understand	The association is released. On receiving error in C-STORE RSP messages store operation is unsuccessful.
Warning	B000	Coercion of data elements	The association is released. On receiving error in C-STORE RSP messages store operation is unsuccessful.
	B006	Elements discarded	The association is released. On receiving error in C-STORE RSP messages store operation is unsuccessful
	B007	Data set does not match SOP class	The association is released. On receiving error in C-STORE RSP messages store operation is unsuccessful.

4.2.1.3.6. (Real-World) Activity – Storage Commitment Push Model AS SCU

4.2.1.3.6.1. Description and Sequencing of Activities

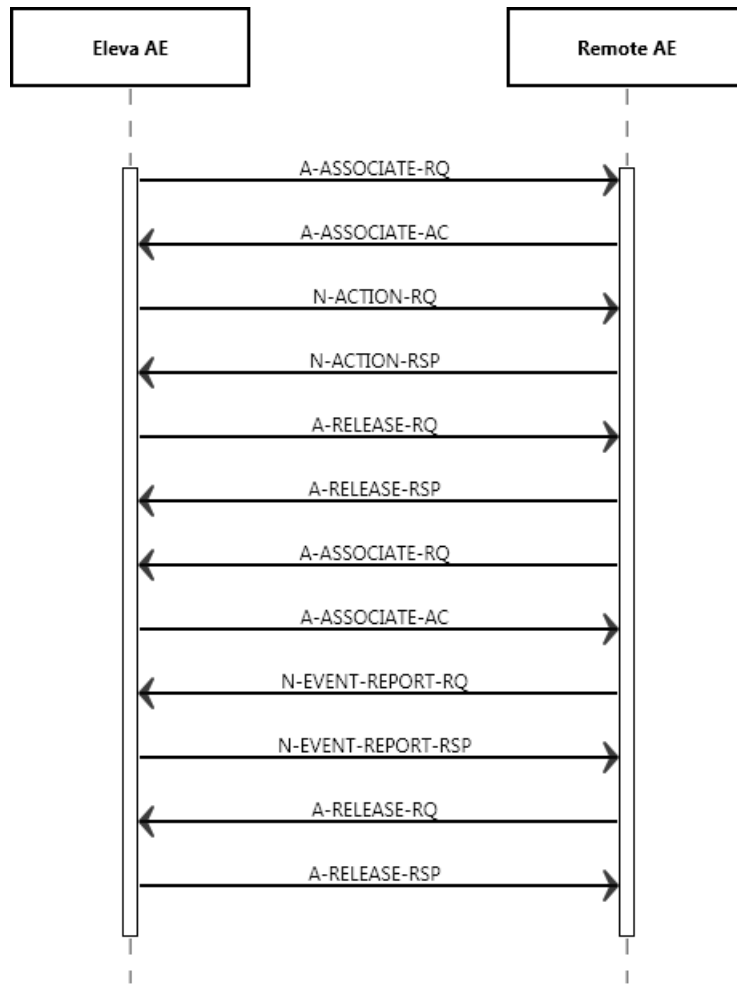

Figure 10: (Real World) Activity – Storage Commitment Push Model as SCU (asynchronous)

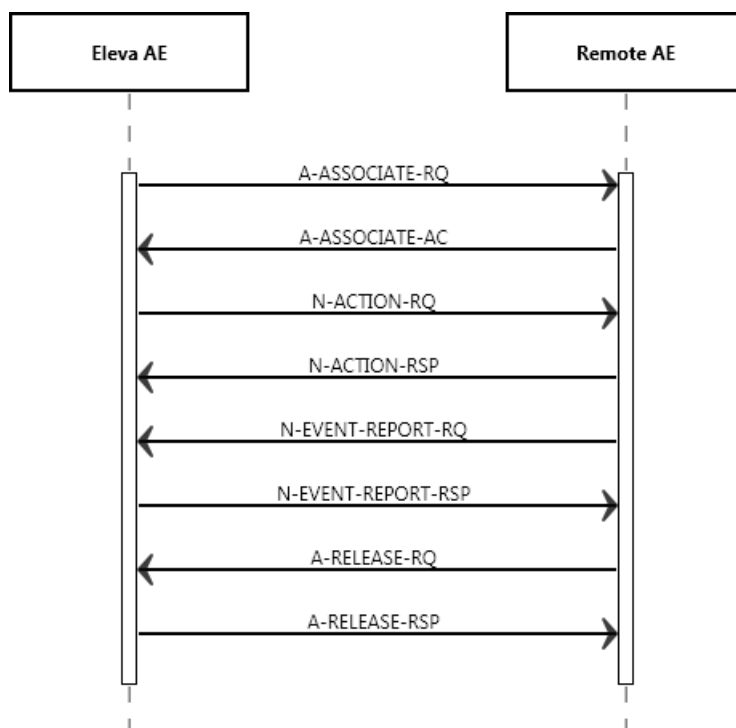

Figure 11: (Real World) Activity – Synchronous Storage Commitment Push Model as SCU (synchronous)

Eleva AE will attempt to initiate a new association when requested to commit the images that were stored on a remote device, which supports the storage Commitment Service. This can be as Synchronous storage commitment or as Asynchronous storage commitment.

This RWA may be initiated in two ways.

- Manually in the viewer, after clicking the Store button the Eleva AE will store the selected images at the selected Storage SCP.
- Automatically during an examination, images are sent automatically when exam was close successfully.

The associated real world activity for the N-ACTION is a storage commitment request to the remote storage device.

The associated real world activity for the N-EVENT-REPORT operation is the completion of the storage commitment by the remote device. Depending on the status of the store the Eleva AE may queue store requests for retries. The queued store requests can be cancelled from the UI.

A remote node supporting Storage Commitment can be configured on Eleva as Archive. After exporting images to this archive node, Eleva request for storage commitment of each of the stored images. Until a successful Storage commitment response is received for archive, the images cannot be deleted on Eleva. The status of commitment is available on image info panel.

4.2.1.3.6.2. Proposed Presentation Contexts

The presentation contexts are defined in table 30.

Table 30: Proposed Presentation Contexts for (Real-World) Activity – Storage Commitment Push Model As SCU

Presentation Context Table					
Abstract Syntax		Transfer Syntax		Role	Extended Negotiation
Name	UID	Name List	UID List		
Storage Commitment Push Model SOP Class	1.2.840.10008.1.20.1	Explicit VR Big Endian	1.2.840.10008.1.2.2	SCU	None
		Explicit VR Little Endian	1.2.840.10008.1.2.1		

Presentation Context Table

Abstract Syntax		Transfer Syntax		Role	Extended Negotiation
Name	UID	Name List	UID List		
		Implicit VR Little Endian	1.2.840.10008.1.2		

4.2.1.3.6.3. SOP Specific Conformance for Storage Commitment Push Model SOP Class

This section and sub-section include the manufacturer SOP and Dataset specific information as well the status codes and their corresponding behavior.

4.2.1.3.6.3.1. Dataset Specific Conformance for Storage Commitment Push Model SOP Class N-EVENT-REPORT-SCP

Detail regarding the Dataset Specific response behavior will be reported in this section.

This part of the section includes the dataset specific behavior, i.e. error codes, error and exception handling, time-outs, etc.

Table 31: Status Response

Service Status	Error Code	Further Meaning	Behavior
Success	0000	Operation complete	Continues with waiting for storage commitment.
Failure	0110	Processing failure	Retry storage commitment request.
	0112	No such object instance	Retry store and storage commitment request.
	0119	Class / Instance conflict	Inform user and abort.
	0122	Referenced SOP class not supported	Inform user and abort.
	0131	Duplicate transaction	UID Inform user and abort.
	xxxx	(any other failure)	The reason is logged.

4.2.1.3.6.3.2. Dataset Specific Conformance for Storage Commitment Push Model SOP Class N-ACTION-SCU

Detail regarding the Dataset Specific response behavior will be reported in this section.

This part of the section includes the dataset specific behavior, i.e. error codes, error and exception handling, time-outs, etc.

Table 32: Storage Commitment Attribute for N-ACTION-RQ

Attribute Name	Tag	Comment
Storage Commitment Module		
Transaction UID	0008,1195	
Referenced SOP Sequence	0008,1199	
>Referenced SOP Class UID	0008,1150	
>Referenced SOP Instance UID	0008,1155	

4.2.1.3.7. (Real-World) Activity – Print Management as SCU

4.2.1.3.7.1. Description and Sequencing of Activities

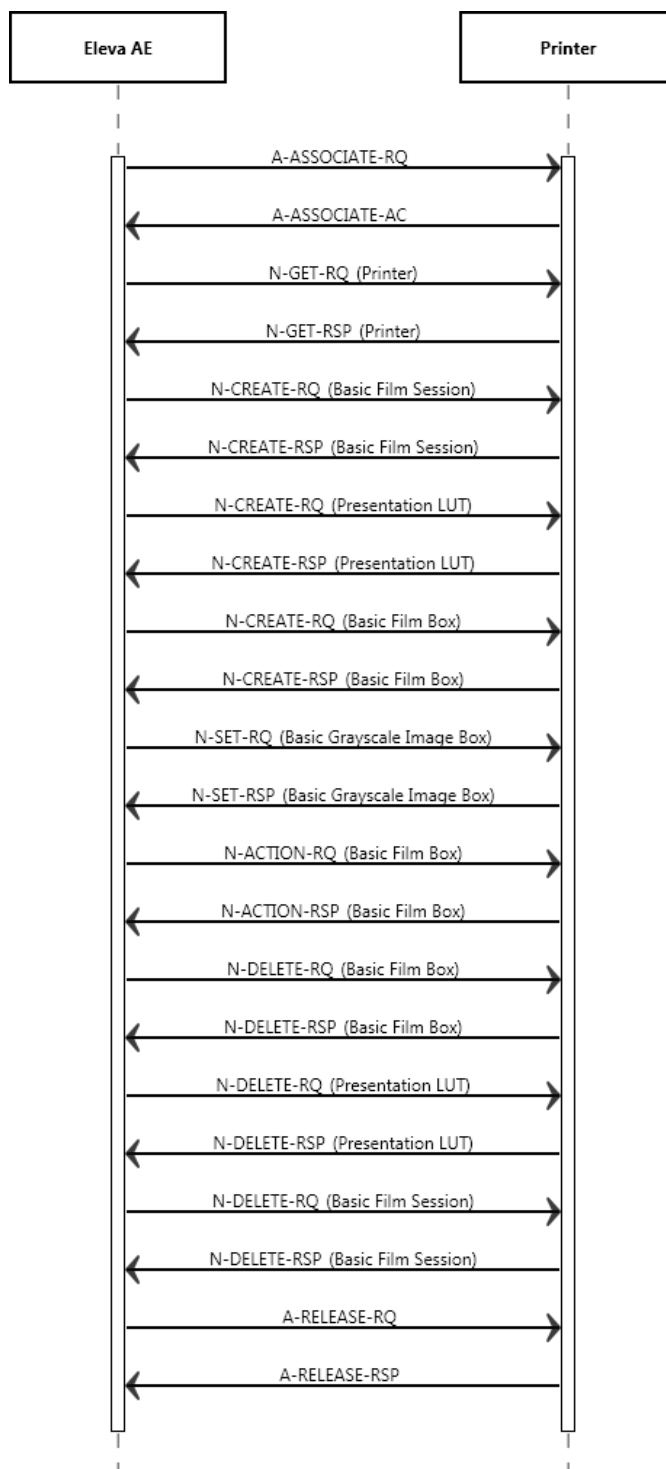

Figure 12: (Real World) Activity - Print Management as SCU

The Eleva AE cannot handle any N-EVENT-REPORT messages.
 A print job (film session) comprises one single film box with one single image (that is composed of 1...N modality images).

The print component in CombiDiagnost R90 Rel 1.1 supports a highly automated print from acquisition operation mode, which does not interrupt the clinical acquisition workflow.

Supplementary to that is the manual print operation mode that is to be used as advanced interactive print preview and as reprint facility.

There shall be two modes of configuration for automatic printing: auto and auto print with user check.

In auto print mode conflicting and incomplete print jobs are either printed “as is” or must be manually corrected and confirmed.

In Auto print with user check mode all automatically started print jobs have to be confirmed manually.

The behavior of the print GUI on entry is dependent on the configuration not on the workflow context.

The three different print modes are:

No auto print jobs active: Screen is empty.

- Auto print configured: All incomplete pages and conflict jobs are seen for that patient.
- Auto print with user check configured: All current print jobs are seen for that patient.

By Manual Printing the basic composition of films is possible with click and point functions.

By Auto Print the operation mode the handling of conflicts between configuration and operation is configurable. This means:

If the collimation and thus the image is larger as originally configured it can be configured if the image shall be cut, scaled or the print job with the conflict shall be manually corrected and confirmed.

If the operator omits one of the routine views configured and a page is thus left half-filled it can be configured if the page is going to be printed half-filled, if a layout suitable for the number of available images is chosen instead or if the page must be manually changed and confirmed.

In case of a manual check configured conflict jobs are sent to the print GUI and handled like the Auto print with user check.

Outstanding jobs are shown to the user by:

- An icon in the patient list at every affected patient / study
- User guidance giving patient name of unprinted film at the time the film ready to be printed

By Auto print with user check all print jobs are sent to the Print UI for checking first.

The user is not forced to go there, but outstanding jobs are shown to the user by:

- An icon in the patient list at every affected patient / study
- User guidance giving patient name of unprinted film at the time the film ready to be printed

Depending on the response status of set and the configuration the Eleva AE may perform a retry.

Note: CombiDiagnost R90 Rel 1.1 support print service only for RAD images. It does not support X-Ray Radiofluoroscopic image.

4.2.1.3.7.2. Proposed Presentation Contexts

The presentation contexts are defined in the next table.

Table 33: Proposed Presentation Contexts for (Real-World) Activity – Print Management As SCU

Presentation Context Table					
Abstract Syntax		Transfer Syntax		Role	Extended Negotiation
Name	UID	Name List	UID List		
Basic Grayscale Print Management Meta SOP Class	1.2.840.10008.5.1.1.9	Explicit VR Big Endian	1.2.840.10008.1.2.2	SCU	None
		Explicit VR Little Endian	1.2.840.10008.1.2.1		
		Implicit VR Little Endian	1.2.840.10008.1.2		
>Basic Film Box SOP Class	1.2.840.10008.5.1.1.2	Explicit VR Big Endian	1.2.840.10008.1.2.2	SCU	None
		Explicit VR Little Endian	1.2.840.10008.1.2.1		
		Implicit VR Little Endian	1.2.840.10008.1.2		

Presentation Context Table

Abstract Syntax		Transfer Syntax		Role	Extended Negotiation
Name	UID	Name List	UID List		
>Basic Film Session SOP Class	1.2.840.10008.5.1.1.1	Explicit VR Big Endian	1.2.840.10008.1.2.2	SCU	None
		Explicit VR Little Endian	1.2.840.10008.1.2.1		
		Implicit VR Little Endian	1.2.840.10008.1.2		
>Basic Grayscale Image Box SOP Class	1.2.840.10008.5.1.1.4	Explicit VR Big Endian	1.2.840.10008.1.2.2	SCU	None
		Explicit VR Little Endian	1.2.840.10008.1.2.1		
		Implicit VR Little Endian	1.2.840.10008.1.2		
>Printer SOP Class	1.2.840.10008.5.1.1.16	Explicit VR Big Endian	1.2.840.10008.1.2.2	SCU	None
		Explicit VR Little Endian	1.2.840.10008.1.2.1		
		Implicit VR Little Endian	1.2.840.10008.1.2		
> Presentation LUT SOP Class	1.2.840.10008.5.1.1.23	Explicit VR Big Endian	1.2.840.10008.1.2.2		
		Explicit VR Little Endian	1.2.840.10008.1.2.1		
		Implicit VR Little Endian	1.2.840.10008.1.2		

4.2.1.3.7.3. SOP Specific Conformance for Basic Film Box SOP Class of the Basic Grayscale Print Management Meta SOP Class

This section and sub-section include the manufacturer SOP and Dataset specific information as well the status codes and their corresponding behavior.

4.2.1.3.7.3.1. Dataset Specific Conformance for Basic Film Box SOP Class N-ACTION-SCU

Detail regarding the Dataset Specific response behavior will be reported in this section.

This part of the section includes the dataset specific behavior, i.e. error codes, error and exception handling, time-outs, etc.

Table 34: N-CREATE-RQ Dataset Specification

Attribute Name	Tag	VR	Value	Presence of Value	Source	Comment
SOP Class UID	0008,0016	UI		ALWAYS		
SOP Instance UID	0008,0018	UI		ALWAYS		
Image Display Format	2010,0010	ST		ALWAYS		
Film Orientation	2010,0040	CS		ALWAYS		
Film Size ID	2010,0050	CS		ALWAYS		
Magnification Type	2010,0060	CS		ALWAYS		
Max Density	2010,0130	US		ALWAYS		
Trim	2010,0140	CS		ANAP		
Configuration Information	2010,0150	ST		ALWAYS		
Referenced Film Session Sequence	2010,0500	SQ		ALWAYS		
>Referenced SOP Class UID	0008,1150	UI		ALWAYS		
>Referenced SOP Instance UID	0008,1155	UI		ALWAYS		

4.2.1.3.7.4. SOP Specific Conformance for Basic Film Session SOP Class of the Basic Grayscale Print Management Meta SOP Class

This section and sub-section include the manufacturer SOP and Dataset specific information as well the status codes and their corresponding behavior.

4.2.1.3.7.4.1. Dataset Specific Conformance for Basic Film Session SOP Class N-CREATE-SCU

Detail regarding the Dataset Specific response behavior will be reported in this section.

This part of the section includes the dataset specific behavior, i.e. error codes, error and exception handling, time-outs, etc.

Table 35: N-CREATE-RQ Dataset Specification

Attribute Name	Tag	VR	Value	Presence of Value	Source	Comment
SOP Class UID	0008,0016	UI		ALWAYS		
SOP Instance UID	0008,0018	UI		ALWAYS		
Number of Copies	2000,0010	IS		ALWAYS		
Print Priority	2000,0020	CS		ALWAYS		
Medium Type	2000,0030	CS		ALWAYS		
Film Destination	2000,0040	CS		ALWAYS		
Film Session Label	2000,0050	LO		ANAP		

4.2.1.3.7.5. SOP Specific Conformance for Presentation LUT SOP Class SOP Class

This section and sub-section include the manufacturer SOP and Dataset specific information as well the status codes and their corresponding behavior.

4.2.1.3.7.5.1. Dataset Specific Conformance for Presentation LUT SOP Class N-CREATE-SCU

Detail regarding the Dataset Specific response behavior will be reported in this section.

This part of the section includes the dataset specific behavior, i.e. error codes, error and exception handling, time-outs, etc.

Table 36: N-CREATE-RQ Dataset Specification

Attribute Name	Tag	VR	Value	Presence of Value	Source	Comment
Presentation LUT Shape	2050,0020	CS	IDENTITY	ALWAYS		

4.2.1.3.7.6. SOP Specific Conformance for Basic Grayscale Image Box SOP Class of the Basic Grayscale Print Management Meta SOP Class

This section and sub-section include the manufacturer SOP and Dataset specific information as well the status codes and their corresponding behavior.

4.2.1.3.7.6.1. Dataset Specific Conformance for Basic Grayscale Image Box SOP Class N-SET-SCU

Detail regarding the Dataset Specific response behavior will be reported in this section.

This part of the section includes the dataset specific behavior, i.e. error codes, error and exception handling, time-outs, etc.

Table 37: N-SET-RQ Dataset Specification

Attribute Name	Tag	VR	Value	Presence of Value	Source	Comment
----------------	-----	----	-------	-------------------	--------	---------

SOP Class UID	0008,0016	UI		ALWAYS		
SOP Instance UID	0008,0018	UI		ALWAYS		
Image Box Position	2020,0010	US		ALWAYS		
Polarity	2020,0020	CS		ALWAYS		
Basic Grayscale Image Sequence	2020,0110	SQ		ALWAYS		
>Samples Per Pixel	0028,0002	US		ALWAYS		
>Photometric Interpretation	0028,0004	CS		ALWAYS		
>Rows	0028,0010	US		ALWAYS		
>Columns	0028,0011	US		ALWAYS		
>Bits Allocated	0028,0100	US		ALWAYS		
>Bits Stored	0028,0101	US		ALWAYS		
>High Bit	0028,0102	US		ALWAYS		
>Pixel Representation	0028,0103	US		ALWAYS		
>Pixel Data	7FE0,0010	OW/OB		ALWAYS		

SOP Specific Conformance for Printer SOP Class of the Basic Grayscale Print Management Meta SOP Class

This section and sub-section include the manufacturer SOP and Dataset specific information as well the status codes and their corresponding behavior.

Table 38: Status Response

Service Status	Code	Further Meaning	Behavior
Success	0000	Successful operation	The print job continues.
Failure	xxxx	Any failure	In the AutoPrint mode a GUI is invoked. The status panel of this GUI displays a message based on the 'Further Meaning'. The warning or failure response of a print request that is invoked by the Manual Print Composer GUI will be displayed by a pop-up window (if the user has not closed the GUI before the printer status was delivered).
Warning	xxxx	Any warning	In the AutoPrint mode a GUI is invoked. The status panel of this GUI displays a message based on the 'Further Meaning'. The warning or failure response of a print request that is invoked by the Manual Print Composer GUI will be displayed by a pop-up window (if the user has not closed the GUI before the printer status was delivered).

4.2.1.4. Association Acceptance Policy

The Application Entity may reject Association attempts as shown in the table below.

Table 39: Association Reject Reasons

Result	Source	Reason/Diagnosis	Behavior
1 - rejected permanent	1 - DICOM UL service-user	1 - no-reason-given	Association is not established. The following error is logged. Association rejected by peer (1: REJECT_RESULT _permanent, 1: REJECT_SOURCE_dul_user, 1: REJECT_REASON _no_reason_given)

Result	Source	Reason/Diagnosis	Behavior
		2 - application-context-name-not-supported	Association is not established. The following error is logged. Association rejected by peer (1: REJECT_RESULT_permanent, 1: REJECT_SOURCE_dul_user, 2: REJECT_REASON_application_context_not_support)
		3 - calling-AE-title-not-recognized	Association is not established. The following error is logged. Association rejected by peer (1: REJECT_RESULT_permanent, 1: REJECT_SOURCE_dul_user, 3: REJECT_REASON_calling_aetitle_not_recognized)
		7 - called-AE-title-not-recognized	Association is not established. The following error is logged. Association rejected by peer (1: REJECT_RESULT_permanent, 1: REJECT_SOURCE_dul_user, 7: REJECT_REASON_called_aetitle_not_recognized)
	2 - DICOM UL service provider(ACSE related function)	1 - no-reason-given	Association is not established. The following error is logged. Error: UserRecoverable: impl.dicom.access.PEER: Association rejected by peer (1: REJECT_RESULT_permanent, 2: REJECT_SOURCE_dul_provider(acse), 1: REJECT_REASON_no_reason_given)
		2 - protocol-version-not-supported	Association is not established. The following error is logged. Association rejected by peer (1: REJECT_RESULT_permanent, 2: REJECT_SOURCE_dul_provider(acse), 2: REJECT_REASON_protocol-version-not-supported)
	3 - DICOM UL service provider (Presentation related function)	1 - temporary-congestion	Association is not established. The following error is logged. Association rejected by peer (1: REJECT_RESULT_permanent, 3: REJECT_SOURCE_dul_provider(presentation), 1: REJECT_REASON_temporary-congestion)
		2 - local-limit-exceeded	Association is not established. The following error is logged. Association rejected by peer (1: REJECT_RESULT_permanent, 3: REJECT_SOURCE_dul_provider(presentation), 2: REJECT_REASON_local-limit-exceeded)
2 - rejected-transient	1 - DICOM UL service-user	1 - no-reason-given	Association is not established. The following error is logged. Association rejected by peer (2: REJECT_RESULT_transient, 1: REJECT_SOURCE_dul_user, 1: REJECT_REASON_no_reason_given)
		2 - application-context-name-not-supported	Association is not established. The following error is logged. Association rejected by peer (2: REJECT_RESULT_transient, 1: REJECT_SOURCE_dul_user, 2: REJECT_REASON_application_context_not_support)
		3 - calling-AE-title-not-recognized	Association is not established. The following error is logged. Association rejected by peer (2: REJECT_RESULT_transient, 1: REJECT_SOURCE_dul_user, 3: REJECT_REASON_calling_aetitle_not_recognized)

Result	Source	Reason/Diagnosis	Behavior
		7 - called-AE-title-not-recognized	Association is not established. The following error is logged. Association rejected by peer (2: REJECT_RESULT_transient, 1: REJECT_SOURCE_dul_user, 7: REJECT_REASON_called_aetitle_not_recognized)
	2 - DICOM UL service provider (ACSE related function)	1 - no-reason-given	Association is not established. The following error is logged. Association rejected by peer (2: REJECT_RESULT_transient, 2: REJECT_SOURCE_dul_provider (acse), 1: REJECT_REASON_no_reason_given)
		2 - protocol-version-not-supported	Association is not established. The following error is logged. Association rejected by peer (2: REJECT_RESULT_transient, 2: REJECT_SOURCE_dul_provider (acse), 2: REJECT_REASON_protocol-version-not-supported)
	3 - DICOM UL service provider (Presentation related function)	1 - temporary-congestion	Association is not established. The following error is logged. Association rejected by peer (2: REJECT_RESULT_transient, 3: REJECT_SOURCE_dul_provider (presentation), 1: REJECT_REASON_temporary-congestion)
		2 - local-limit-exceeded	Association is not established. The following error is logged. Association rejected by peer (2: REJECT_RESULT_transient, 3: REJECT_SOURCE_dul_provider (presentation), 2: REJECT_REASON_application_context_not_support)

The behavior of the AE for sending an Association abort is summarized in next table.

Table 40: Association Abort Policies

Source	Reason/Diagnosis	Behavior
0 - DICOM UL service-user (initiated abort)	0 - reason-not-specified	When received, the Eleva Workspot terminates the connection with the following log: Association ABORTED by peer (0: ABORT_SOURCE_dul_user, 0: ABORT_REASON_not_specified).
2 - DICOM UL service-provider (initiated abort)	0 - reason-not-specified	When received, the Eleva Workspot terminates the connection with the following log: Association ABORTED by peer (2: ABORT_SOURCE_dul_provider, 0: ABORT_REASON_not_specified).
	1 - unrecognized-PDU	When received, the Eleva Workspot terminates the connection with the following log: Association ABORTED by peer (2: ABORT_SOURCE_dul_provider, 1: ABORT_REASON_unrecognized_pdu).
	2 - unexpected-PDU	When received, the Eleva Workspot terminates the connection with the following log: Association ABORTED by peer (2: ABORT_SOURCE_dul_provider, 2: ABORT_REASON_unexpected_pdu).

Source	Reason/Diagnosis	Behavior
	4 - unrecognized-PDU parameter	When received, the Eleva Workspot terminates the connection with the following log: Association ABORTED by peer (2: ABORT_SOURCE_dul_provider, 4: ABORT_REASON_unrecognized_pdu_parameter).
	5 - unexpected-PDU parameter	When received, the Eleva Workspot terminates the connection with the following log: Association ABORTED by peer (2: ABORT_SOURCE_dul_provider, 5: ABORT_REASON_unexpected_pdu_parameter).
	6 - invalid-PDU-parameter value	When received, the Eleva Workspot terminates the connection with the following log: Association ABORTED by peer (2: ABORT_SOURCE_dul_provider, 6: ABORT_REASON_invalid_pdu_parameter).

4.2.1.4.1. (Real-World) Activity –Find as SCU

4.2.1.4.1.1. Description and Sequencing of Activities

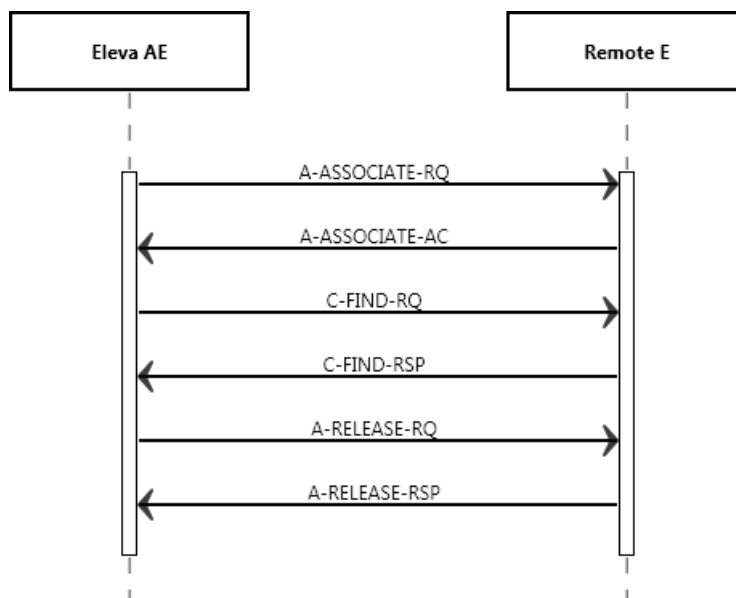

Figure 13: Data Flow Diagram – FIND as SCU

4.2.1.4.1.2. Proposed Presentation Contexts

The presentation contexts proposed by the system are defined in the table 41.

Table 41: Proposed Presentation Contexts for (Real-World) Activity – FIND As SCU

Presentation Context Table					
Abstract Syntax		Transfer Syntax		Role	Extended Negotiation
Name	UID	Name List	UID List		
Patient Root QR Information Model – FIND SOP Class	1.2.840.10008.5.1.4.1.2.1.1	Explicit VR Big Endian	1.2.840.10008.1.2.2	SCU	None
		Explicit VR Little Endian	1.2.840.10008.1.2.1		
		Implicit VR Little Endian	1.2.840.10008.1.2		

Presentation Context Table

Abstract Syntax		Transfer Syntax		Role	Extended Negotiation
Name	UID	Name List	UID List		
Study Root QR Information Model – FIND SOP Class	1.2.840.10008.5.1.4.1.2.2.1	Explicit VR Big Endian	1.2.840.10008.1.2.2	SCU	None
		Explicit VR Little Endian	1.2.840.10008.1.2.1		
		Implicit VR Little Endian	1.2.840.10008.1.2		

4.2.1.4.1.3. SOP Specific Conformance for Patient Root QR Information Model – FIND SOP Class

The Eleva AE provides standard conformance to the DICOM Query Retrieve service class. The system issues a C-FIND-RQ to a configured remote DIOCM node for matching studies. The received responses are displayed to the user. The user may retrieve the images from the remote node.

4.2.1.4.1.4. Dataset Specific Conformance for Patient Root QR Information Model – FIND SOP Class C-FIND-SCU

Table 42: C-FIND-RQ Dataset Specification

Patient Root QR Information Model - FIND SOP Class				
Attribute Name	Tag	VR	Type of Matching	Comment
Query/Retrieve Level	0008,0052	CS	Single Value	Patient, Study, Series
Patient Level Attributes For The Patient Root Query/Retrieve Information Model				
Patient's Name	0010,0010	PN	Single Value, Universal, Wildcard	
Patient ID	0010,0020	LO	Single Value, Universal, WildCard	
Patient's Birth Date	0010,0030	DA	Single Value, Universal	
Other Patient Ids	0010,1000	LO	Single Value, Universal, WildCard	
Study Level Keys For The Patient Root Query/Retrieve Information Model				
Study Date	0008,0020	DA	Universal, Range	
Study Time	0008,0030	TM	Universal	
Accession Number	0008,0050	SH	Universal	
Study Instance UID	0020,000D	UI	Universal	
Study ID	0020,0010	SH	Universal	
Series Level Attributes For The Patient Root Query/Retrieve Information Model				
Modality	0008,0060	CS	Universal	
Series Instance UID	0020,000E	UI	Universal	
Series Number	0020,0011	IS	Universal	
Body Part Examined	0018,0015	CS	Universal	

4.2.1.4.1.4.1. SOP Specific Conformance for Study Root QR Information Model - FIND SOP Class

4.2.1.4.1.4.1.1. Dataset Specific Conformance for Study Root QR Information Model - FIND SOP Class C-FIND-SCU

The Eleva AE provides standard conformance to the DICOM Query Retrieve service class. The system issues a C-FIND-RQ to a configured remote DIOCM node for matching studies. The received responses are displayed to the user. The user may retrieve the images from the remote node.

Table 43 C-FIND-RQ Dataset Specification.

Study Root QR Information Model - FIND SOP Class				
Attribute Name	Tag	V R	Type of Matching	Comment
Query/Retrieve Level	0008,0052	CS	Single Value	Study, Series
Study Level Keys For The Study Root Query/Retrieve Information Model				
Study Date	0008,0020	DA	Range, Universal	
Study Time	0008,0030	TM	Universal	
Accession Number	0008,0050	SH	Universal	
Study Description	0008,1030	LO	Universal	
Patient's Name	0010,0010	PN	Single Value, Universal, Wildcard	
Patient ID	0010,0020	LO	Single Value, Universal, Wildcard	
Patient's Birth Date	0010,0030	DA	Single Value, Universal	
Other Patient Ids	0010,1000	LO	Universal	
Study Instance UID	0020,000D	UI	Universal	
Study ID	0020,0010	SH	Universal	
Series Level Attributes For The Study Root Query/Retrieve Information Model				
Modality	0008,0060	CS	Universal	
Series Instance UID	0020,000E	UI	Universal	
Series Number	0020,0011	IS	Universal	
Body Part Examined	0018,0015	CS	Universal	

Table 44: Status Response

Service Status	Error Code	Further Meaning	Behavior
Success	0000	Matching is complete – No final identifier is supplied	Successful completion of the query.

4.2.1.4.2. (Real-World) Activity - Move as SCU

4.2.1.4.2.1. Description and Sequencing of Activities

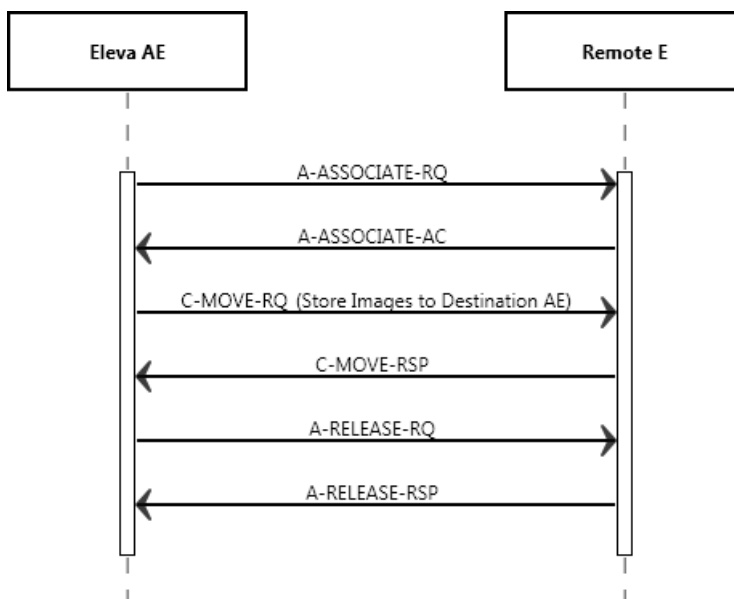

Figure 14: (Real World) Activity – Move as SCU

4.2.1.4.2.2. Proposed Presentation Contexts

Table 45: Proposed Presentation Contexts for (Real-World) Activity Move as SCU

Presentation Context Table					
Abstract Syntax		Transfer Syntax		Role	Extended Negotiation
Name	UID	Name List	UID List		
Patient Root QR Information Model – FIND SOP Class	1.2.840.10008.5.1.4.1.2.1.1	Explicit VR Big Endian	1.2.840.10008.1.2.2	SCU	None
		Explicit VR Little Endian	1.2.840.10008.1.2.1		
		Implicit VR Little Endian	1.2.840.10008.1.2		
Study Root QR Information Model – FIND SOP Class	1.2.840.10008.5.1.4.1.2.2.1	Explicit VR Big Endian	1.2.840.10008.1.2.2	SCU	None
		Explicit VR Little Endian	1.2.840.10008.1.2.1		
		Implicit VR Little Endian	1.2.840.10008.1.2		

4.2.1.4.2.2.1. SOP Specific Conformance for Patient Root QR Information Model - MOVE SOP Class

4.2.1.4.2.2.1.1. Dataset Specific Conformance for Patient Root QR Information Model - MOVE SOP Class C-MOVE-SCU

Details regarding the Dataset Specific response behavior will be reported in this section.

Table 46 C-MOVE-RQ Dataset Specification.

Patient Root QR Information Model - MOVE SOP Class				
Attribute Name	Tag	VR	Comment	
Query/Retrieve Level	0008,0052	CS	Series	

4.2.1.4.2.2.2. SOP Specific Conformance for Study Root QR Information Model - MOVE SOP Class

4.2.1.4.2.2.2.1. Dataset Specific Conformance for Study Root QR Information Model - MOVE SOP Class C-MOVE-SCU

Table 47 C-MOVE-RQ Dataset Specification.

Study Root QR Information Model - MOVE SOP Class			
Attribute Name	Tag	VR	Comment
Query/Retrieve Level	0008,0052	CS	Series

Table 48 Status Response

Service Status	Error Code	Further Meaning	Behavior
Success	0000	Sub-operations complete – No failures	Successful completion of the retrieve; also storage warnings may have occurred.
Failure	A900	Identifier does not match SOP Class	Retrieval is terminated
Cancel	FE00	Sub-operations terminated due to Cancel indication	Retrieval is terminated
Warning	B000	Sub-operations complete – One or more failures	Retrieval is terminated

4.2.1.4.3. (Real-World) Activity – Verification as SCP

4.2.1.4.3.1. Description and Sequencing of Activities

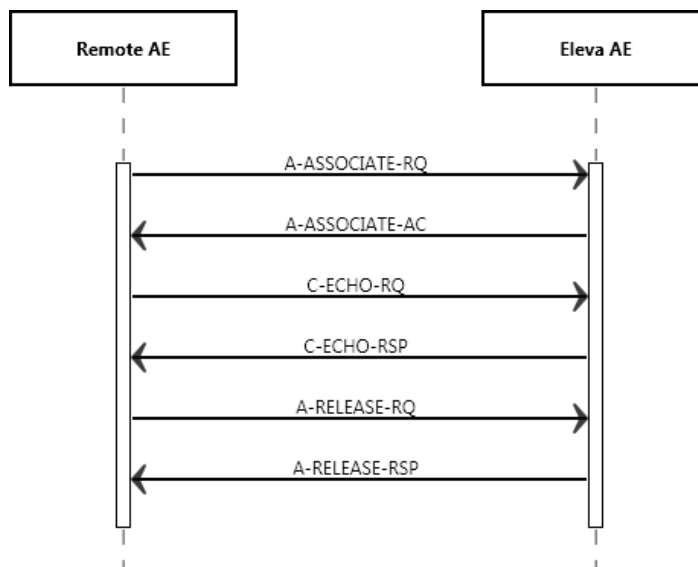

Figure 15: (Real World) Activity - Verification as SCP

4.2.1.4.3.2. Accepted Presentation Contexts

The presentation contexts are defined in the next table.

Table 49: Acceptable Presentation Contexts for (Real-World) Activity – Verification as SCP

Presentation Context Table					
Abstract Syntax		Transfer Syntax		Role	Extended Negotiation
Name	UID	Name List	UID List		
Verification SOP Class	1.2.840.10008.1.1	Explicit VR Big Endian	1.2.840.10008.1.2.2	SCP	None
		Explicit VR Little Endian	1.2.840.10008.1.2.1		
		Implicit VR Little Endian	1.2.840.10008.1.2		

4.2.1.4.3.3. SOP Specific Conformance for Verification SOP Class

This section and sub-section include the manufacturer SOP and Dataset specific information as well the status codes and their corresponding behavior.

4.2.1.4.3.3.1. Dataset Specific Conformance for Verification C-ECHO SCP

Detail regarding the Dataset Specific response behavior will be reported in this section.

This part of the section includes the dataset specific behavior, i.e. error codes, error and exception handling, time-outs, etc.

Table 50: Status Response

Service Status	Error Code	Further Meaning	Behavior
Success	0000	Verification is complete	The CombiDiagnost R90 Rel 1.1 has successfully received the verification request

4.2.1.4.4. (Real-World) Activity – Image Import

4.2.1.4.4.1. Description and Sequencing of Activities

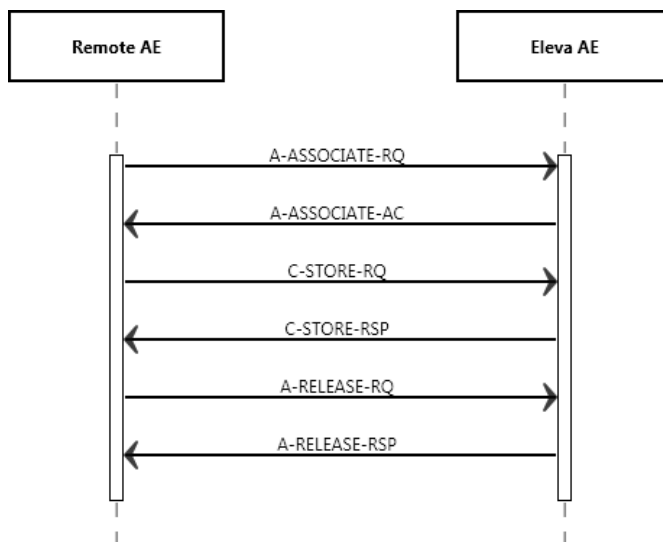

Figure 16: (Real World) Activity - Image Import

4.2.1.4.4.2. Accepted Presentation Contexts

The presentation contexts are defined in the next table.

Table 51: Acceptable Presentation Contexts for (Real-World) Activity – Image Import

Presentation Context Table					
Abstract Syntax		Transfer Syntax		Role	Ext. Neg.
Name	UID	Name	UID		
Computed Radiography Image Storage SOP Class	1.2.840.10008.5.1.4.1.1.1	Implicit VR Little Endian: Default Transfer Syntax for DICOM	1.2.840.10008.1.2	SCP	None
		Explicit VR Little Endian	1.2.840.10008.1.2.1		
		Explicit VR Big Endian	1.2.840.10008.1.2.2		
Digital X-Ray Image Storage - For Pres. SOP	1.2.840.10008.5.1.4.1.1.1.1	Implicit VR Little Endian: Default Transfer Syntax for DICOM	1.2.840.10008.1.2	SCP	None
		Explicit VR Little Endian	1.2.840.10008.1.2.1		
		Explicit VR Big Endian	1.2.840.10008.1.2.2		
Digital X-Ray Image Storage - For Proc. SOP	1.2.840.10008.5.1.4.1.1.1.1.1	Implicit VR Little Endian: Default Transfer Syntax for DICOM	1.2.840.10008.1.2	SCP	None
		Explicit VR Little Endian	1.2.840.10008.1.2.1		
		Explicit VR Big Endian	1.2.840.10008.1.2.2		
Secondary Capture Image Storage SOP Class	1.2.840.10008.5.1.4.1.1.7	Implicit VR Little Endian: Default Transfer Syntax for DICOM	1.2.840.10008.1.2	SCP	None

4.3. Network Interfaces

4.3.1. Physical Network Interfaces

The CombiDiagnost R90 Rel 1.1 provides DICOM 3.0 TCP/IP Network Communication Support as defined in Part 8 of the DICOM 3.0 Standard.

The CombiDiagnost R90 Rel 1.1 system supports:

- IEEE 802.3-1995, 10BASE-T
- IEEE 802.3-1995, 100BASE-TX (Fast Ethernet)
- IEEE 802.3, 1000BASE-X (Gigabit Ethernet).

4.3.2. Additional Protocols

Not applicable

4.3.3. IPv4 and IPv6 Support

The CombiDiagnost R90 Rel 1.1 supports both IPv4 and IPv6 networks communication

4.4. Configuration

Any implementation's DICOM conformance may be dependent upon configuration, which takes place at the time of installation. Issues concerning configuration are addressed in this section.

4.4.1. AE Title/Presentation Address Mapping

An important installation issue is the translation from AE title to presentation address. How this is to be performed is described here.

4.4.1.1. Local AE Titles

The local AE title mapping and configuration are specified as:

Table 52: AE Title configuration table

Application Entity	Default AE Title	Default TCP/IP Port
Eleva AE	Eleva	3010

4.4.1.2. Remote AE Title/Presentation Address Mapping

All remote applications to be selected as destination (SCP) are configurable for the following items:
 The Application Entity Title of the remote application.
 The Presentation Address of where the remote application should accept association requests.

4.4.2. Parameters

The specification of important operational parameters, their default value and range (if configurable) are specified here.

Table 53: Configuration Parameters Table

Parameter	Configurable	Default Value
General Parameter		
Maximum PDU size the AE can receive	No	65536
Maximum PDU size the AE can send	Yes	65536
Maximum number of simultaneous associations	Yes	3
ARTIM Timeout Specifies the time in seconds of the ARTIM (Association Request/Reject/Release Timer). Allowed values: 0: unlimited waiting time 0 < n: real time in seconds	Yes	20 [seconds]
Automatic Association Timeout Specifies the association inactivity timeout in seconds after which the association is closed automatically. Allowed values: -1: immediate timeout 0: unlimited waiting time 0 < n: real time in seconds	Yes	0 [unlimited]
Transfer Syntax support: ILE, ELE, EBE	Yes	ILE, ELE, EBE
Storage Specific Parameters		
Automatic export to a configurable destination	Yes	-
Storage Commitment Specific Parameters		
Storage Commit Max Reply Waiting Time Specifies the time in seconds that is waited for a storage commitment event report message. After this time the association will be terminated Allowed values: -1: immediate timeout 0: unlimited waiting time 0 < n: real time in seconds	Yes, only for synchronous connection	No default (value is configurable)
Basic Worklist Management Specific Parameters		
RIS query timeout Specifies the time after which the query is automatically aborted Allowed values: 1- 300 minutes	Yes	240 seconds
Background broad query time interval Specifies the time until the background query will be repeated. Allowed values: 0: no broad query 0 < n: real time in minutes	Yes	0 [no broad query]
Print Management Specific Parameters		

Parameter	Configurable	Default Value
Automatic print to a configurable destination	Yes	-
Automatic Export of X-Ray Radiation Dose SR to a configurable destination	Yes	

5. Media Interchange

5.1. Implementation model

The implementation model identifies the DICOM Application Entities for Media in specific implementation and relates the Application Entities to Real-World Activities.

5.1.1. Application Data Flow Diagram

The CombiDiagnost R90 Rel 1.1 system consists of one single application entity only: the CombiDiagnost R90 Rel 1.1 Application Entity.

Next figure shows the Media Interchange application data flow as a functional overview of the Eleva AE. The Eleva AE will act as a FSC when writing the selected images in a patient folder onto the CD-R/DVD medium.

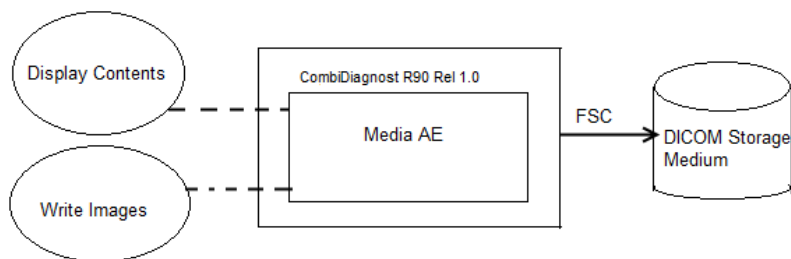

Figure 17: Media Interchange Application Data Flow Diagram

5.1.2. Functional Definitions of AE's

This section shall describe in general terms the functions to be performed by the AE, and the DICOM services used to accomplish these functions.

The Eleva AE is the one and only application entity within the CombiDiagnost R90 Rel 1.1. It includes the following service class.

Media Storage Service Class

The Eleva AE can perform the Media Storage service as SCU, with capabilities for RWA Create File-Set (as FSC).

5.1.3. Sequencing of Real World Activities

Write images can be initiated by selecting a proper export destination, selecting requested images and clicking the export button. Whenever a CD-R/DVD has to be written the Eleva AE first tries to read the DICOMDIR. The Eleva AE will compile the updated DICOMDIR and any required DICOM images into a CD/DVD session image; this CD/DVD session image will be written to CD-R/DVD.

5.2. AE Specifications

This section in the DICOM Conformance Statement specifies a set of Media Application Entities.

5.2.1. Media Storage Media – Specification

The Eleva AE provides Standard Conformance to the DICOM Media Storage Service and File Format ([DICOM] PS 3.10) and the Media Storage Application Profiles STD-GEN-CD ([DICOM] PS 3.11), STD-GEN-DVD-JPEG for creation.

The supported Application Profiles, their Roles and the Service Class (SC) options, all defined in DICOM terminology, are listed in next table.

Table 54: AE Media Storage related Application Profiles, Real-World Activities and Roles

Supported Application Profile	Identifier	Real-World Activities	Roles
General Purpose CD-R Interchange	STD-GEN-CD	Create File-set	FSC

General Purpose Interchange on DVD-RAM Media	STD-GEN-DVD-RAM	Create File-set	FSC
--	-----------------	-----------------	-----

5.2.1.1. File Meta Information for the Media Storage

In the file Meta information that pertains to the Application Entity the Source Application Entity Title is set to "PMS_ELEVA_42.0".

Table 55: Implementation Identifying Information

Property	Value
Implementation Class UID:	1.3.46.670589.30.42.0
Implementation Version Name:	PMS_ELEVA_42.0

5.2.1.2. Real World Activities

The AE specification contains a description of the Real-World Activities, which invoke the particular AE.

5.2.1.2.1. RWA - Create File-set

When an image transfer to CD-R is initiated then the Eleva AE acts as an FSC using the interchange option to export SOP Instances from the local database to a CD-R/DVD medium.

5.2.1.2.1.1. Media Storage Application Profile

The Eleva AE supports the RWA - Create File-SET for the STD-GEN-CD and STD-GEN-DVD-JPEG Application Profiles.

5.2.1.2.1.1.1. Options

The DICOMDIR file will be created on the CD-R/DVD medium when new images are written. In case some attributes are not present in an image but are specified as mandatory in the DICOMDIR definition in DICOM Media, a generated value will filled in.

The Eleva AE can write created image to media of the following listed SOP Classes

Table 56: AE related storage SOP Classes for Media

SOP Class Name	SOP Class UID
Computed Radiography Image Storage SOP Class	1.2.840.10008.5.1.4.1.1.1
Digital X-Ray Image Storage - Presentation SOP Class	1.2.840.10008.5.1.4.1.1.1.1
Digital X-Ray Image Storage - Processing SOP Class	1.2.840.10008.5.1.4.1.1.1.1.1
Secondary Capture Image Storage SOP Class	1.2.840.10008.5.1.4.1.1.7

The Eleva AE can write created image to media with the following listed Transfer Syntax.

Table 57: AE related storage SOP Classes for Media

Transfer Syntax	UID List
Explicit VR Little Endian	1.2.840.10008.1.2.1

The Eleva AE can write created image to media with the following listed Media Storage SOP Class.

Table 58: AE Media Store SOP Class

Media Storage SOP Class Name	Media Storage SOP Class UID
Media Storage Directory Storage	1.2.840.10008.1.3.10

It is possible to Store one single image first as a DICOM CR object and secondly as a DICOM DX object, therefore the "SOP Instance UIDs" and "Referenced SOP Instance UIDs" of both DICOM image instances have to be different.

The Numbering Scheme shall support 'Hanging Protocols' of PACS systems & Viewing Stations, in case of the CR as well as the DX model:

The Series Number starts with 1 for the first Series of every Study Instance, identified by Study Instance UID.

The "Series Number" increases by 1 for every new Series Instance within the same Study Instance, by the timely order, the Series Instances are created.

Every Stored image gets also a unique "Series Instance UID" and "Media Storage SOP Instance UID".

The Image Number starts with 1 for every new Series Instance.

The Image Number increases by 1 for every new Image Instance within the same Series Instance, by the timely order, the Images are created.

5.3. Augmented and Private Application Profiles

Eleva does not support any augmented or private application profiles.

6. Support of Character Sets

Any support for character sets in Network and Media services is described here.

Table 59: Supported DICOM Character Sets

Character Set Description	Defined Term	ESC Sequence	ISO Registration Number	Code Element	Character Set
Latin alphabet No. 1	ISO_IR 100	-	ISO-IR 6	G0	ISO 646
		-	ISO-IR 100	G1	Supplementary set of ISO 8859
Latin alphabet No. 2	ISO_IR 101	-	ISO-IR 6	G0	ISO 646
		-	ISO-IR 101	G1	Supplementary set of ISO 8859
Chinese	GB18030	-	GB18030	-	-

7. Security

7.1. Security Profiles

CombiDiagnost R90 Rel 1.1 conforms to the IHE ATNA Integration Profile.

CombiDiagnost R90 Rel 1.1 allows the use of either a conventional (non-secure) DICOM communication or a secure DICOM communication based on the Transport Layer Security (TLS) protocol. If configured CombiDiagnost R90 Rel 1.1 supports the following security measures:

- Secure authentication of a node
- Integrity and confidentiality of transmitted data
- Confidentiality of data on DICOM Media
- Generation of audit trail records access control and user authentication

7.1.1. Security use Profiles

Not applicable

7.1.2. Security Transport Connection Profiles

CombiDiagnost R90 Rel 1.1 conforms to the TLS protocol v1.2 of Secure Transport Connection Profile.

CombiDiagnost R90 Rel 1.1 initiates TLS Connections and accepts TLS Connections with Storage Commitment. TLS ports are configurable.

CombiDiagnost R90 Rel 1.1 provides a service accessible tool to configure private keys and certificates of the local and remote DICOM nodes.

Secure communication is a "mode of operation" of CombiDiagnost R90 Rel 1.1 supported by the implementation of the DICOM TLS 1.2 Secure Transport Connection Profile. This functionality will be used by the nodes that can authenticate each other before they exchange DICOM information. For secure communication the TLS protocol v1.2 is used which provides message authentication, integrity, and confidentiality. Confidentiality is optional and can be controlled by the encryption settings.

CombiDiagnost R90 Rel 1.1 may communicate using the following Cipher Suites:

- TLS_RSA_WITH_NULL_SHA (Node authentication without encryption)
- TLS_RSA_WITH_AES_128_CBC_SHA (Node authentication with encryption)
- TLS_RSA_WITH_3DES_EDE_CBC_SHA

CombiDiagnost R90 Rel 1.1 supports X.509 certificates. The following TLS Certification checks will be done (TLS Handshake). The machine (either server or client) that will send its certificate will:

Choose the certificate according to Common Name (CN) value in the Subject-field. This name is case-sensitive. All present certificates should have unique CN names.

The server verifies that

- The client certificate is a X.509 certificate which is valid.
- The Client Authentication (CA) of the client certificate is in the list of trusted certificates.
- The client certificate is not expired (present time is between "Valid From" and "Valid To" fields of the X.509 certificate)
- The client certificate has the correct purpose (at least the Client Authentication purpose),If the purpose is specified.

The client verifies that

- The server certificate is a X.509 certificate which valid.
- The Client Authentication (CA) of the client certificate is in the list of trusted certificates.
- The server certificate is not expired (present time is between "Valid From" and "Valid To" fields of the X.509 certificate)
- The server certificate has the correct purpose (at least Server Authentication purpose),If the purpose is specified.

No verification is done on:

- Revocation of certificates
- Limiting the connection to a limited set of IP-addresses

Node authentication with or without encryption is only possible when both nodes have:

- An access to their own private keys
- An access to a copy of the certificate of the other node containing its public key

Figure below presents the message flow of TLS handshake supported by CombiDiagnost R90 Rel 1.1.

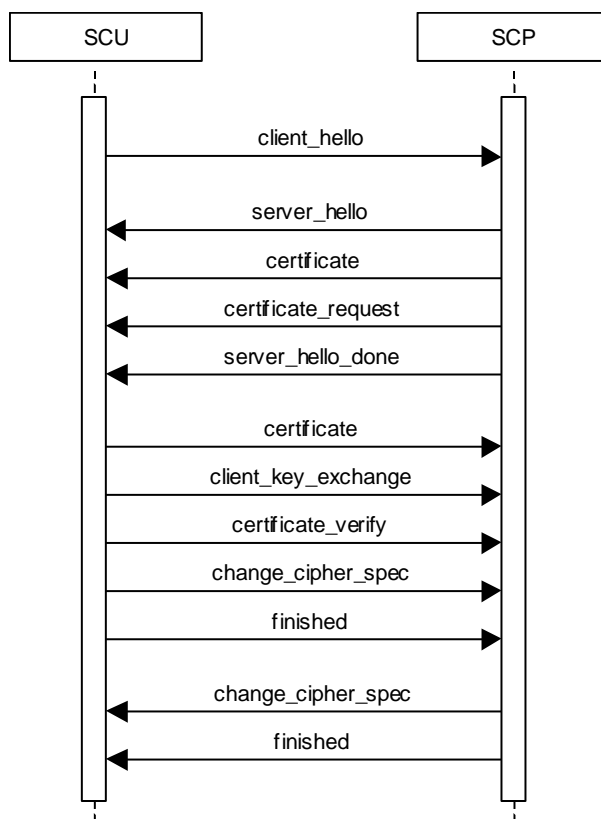

7.1.3. Digital Signature Profiles

Not applicable

7.1.4. Media Storage Security Profiles

CombiDiagnost R90 Rel 1.1 conforms to the Basic DICOM Media Security Profile for CD/DVD DIOM media export

7.1.5. Attribute Confidentiality Profiles

CombiDiagnost R90 Rel 1.1 conforms to the Basic Application Level Confidentiality Profile as de-identifier. De-identified SOP Instances will be created on DICOM Media if specified by the user.

No instances of the Encrypted Attributes Data Set are created. No Transfer Syntaxes are supported for encoding/decoding of Encrypted Attributes Data Sets.

empty The attribute will have a value of zero length.

n. a. Not applicable, the attribute is not contained in the standard IOD of CombiDiagnost R90 Rel 1.1

When creating a media with anonymous patient data, the following attributes are changed.

© 2019 Koninklijke Philips N.V.

Table 60: Anonymous attributes supported by CombiDiagnost

Attribute	Tag	Change to
Media Storage SOP Instance UID	0002,0003	New UID
Referenced SOP Instance UID in File	0004,1511	New UID
SOP Instance UID	0008,0016	New UID
Accession Number	0008,0050	anon string
Institution Name	0008,0080	[empty]
Institution Address	0008,0081	[empty]
Referring Physician's Name	0008,0090	[empty]
Station Name	0008,1010	[empty]
Study Description	0008,1030	[empty]
Series Description	0008,103E	[empty]
Institutional Department Name	0008,1040	[empty]
Performing Physician's Name	0008,1050	[empty]
Operators' Name	0008,1070	[empty]
Patient Name	0010,0010	anon string
Patient ID	0010,0020	anon string
Patient's Birth Date	0010,0030	[empty]
Patient's Sex	0010,0040	[empty]
Other Patient IDs	0010,1000	[empty]
Patient's Size	0010,1020	always 0
Patient's Weight	0010,1030	always 0
Device Serial Number	0018,1000	New ID
Study Instance UID	0020,000D	New UID
Series Instance UID	0020,000E	New UID
Study ID	0020,0010	empty
Requesting Physician	0032,1032	anon string
Request Attributes Sequence	0040,0270	[empty sequence]
Requested Procedure ID	0040,1001	New ID

7.1.6. Network Address Management Profiles

Not applicable

7.1.7. Time Synchronization Profiles

CombiDiagnost R90 Rel 1.1 conforms to the Basic Time Synchronization Profile as NTP Client.
 CombiDiagnost R90 Rel 1.1 does support secure transactions.

7.1.8. Application Configuration Management Profiles

Not applicable

7.1.9. Audit Trail Profiles

CombiDiagnost R90 Rel 1.1 creates audit messages according to the IHE ATNA Integration Profile. The messages comply with the syslog RFC5425 standard and RFC3881 as specified the IHE ATNA profile. These messages may contain information that identifies the patient. The following messages will be created and sent to a central Audit Record Repository:

Trigger Event	Description
ActorStart-Stop	This audit message describes the event of an Application Entity starting or stopping.
User Authentication	This message describes the event that a user has attempted to log on or log off. This report can be made regardless of whether the attempt was successful or not.
Node-Authentication-failure	This message describes any event for which a node needs to report a security alert, e.g., a node Authentication failure when establishing a secure communications channel.
Security Alert	This message describes any security related event caused by configuration changes.
BeginStoring Instances	This message describes the event of a system beginning to transfer a set of DICOM instances from one node to another node. This message may only include information about a single patient.
Instances-Stored	This separate Instances Transferred message is defined for transfer completion, allowing comparison of what was intended to be sent and what was actually sent.
Study-Object-Event, Study-used	Study is created, modified, or accessed. This reports on addition of new instances to existing studies as well as creation of new studies. One event covers all instances used for the particular study.
PHI-export	Any export of PHI on media, either removable physical media such as CD/DVD or electronic transfer of files.
Instances-deleted	This audit record is generated if SOP Instances are deleted from a specific study. One event covers all instances deleted for the particular study.
Actor-Config	This message describes any security related event caused by database changes.

7.2. Association Level Security

Not applicable

7.3. Application Level Security

CombiDiagnost R90 Rel 1.1 does not support any specific application level security measures.

The Application which gives access to Patient records and DICOM communication requires Login with Username and Password.

The system is used within a secured environment. It is assumed that a secured environment includes at a minimum:

- Firewall or router protections to ensure that only approved external hosts have network access to CombiDiagnost R90 Rel 1.1
- Firewall or router protections to ensure that CombiDiagnost R90 Rel 1.1 only has network access to approved external hosts and services.
- Any communication with external hosts outside the locally secured environment can be configured to use secure network channels.
- Other network security procedures such as automated intrusion detection may be appropriate in some environments.

Additional security features may be established by the local security policy and are beyond the scope of this conformance statement.

The OS is solidified by white-listing applications and files. Not white-listed executable files, libraries, drivers, Java apps, ActiveX controls, scripts, and other code are blocked

8. Eleva

8.1. IOD Contents

8.1.1. Created SOP Instance

This section specifies each IOD created by this application and specifies the content for each IOD created (including private IODs). For each attribute in the IOD the following information is supplied:

- Attribute name
- Tag
- VR – Value representation
- Value - specifies possible values

Presence of value - specifies if attribute is always present or only under specific conditions

- Source of value - specifies the source of the value
- Comment - gives additional information on the attribute

Abbreviations used in the IOD tables for the column "Presence of Module" are:

- ALWAYS The module is always present.
- CONDITIONAL The module is used under specified condition.

Abbreviations used in the Module table for the column "Presence of Value" are:

- ALWAYS The attribute is always present with a value.
- EMPTY The attribute is always present without any value. (attribute sent zero length)
- VNAP The attribute is always present and its Value is Not Always Present. (attribute sent zero length if no value is present)
- ANAP The attribute is present under specified condition – if present then it will always have a value.

The abbreviations used in the Module table for the column "Source" are:

- AUTO The attribute value is generated automatically.
- CONFIG The attribute value source is a configurable parameter.
- COPY The attribute value source is another SOP instance.
- FIXED The attribute value is hard-coded in the application.
- IMPLICIT The attribute value source is a user-implicit setting.
- MPPS The attribute value is the same as that use for Modality Performed Procedure Step.
- MWL The attribute value source is a Modality Worklist.
- USER The attribute value source is explicit user input.

List of Created SOP Classes

Table 61: List of Created SOP Classes

SOP Class Name	SOP Class UID
Computed Radiography Image Storage SOP Class	1.2.840.10008.5.1.4.1.1.1
Digital X-Ray Image Storage - For Presentation. SOP	1.2.840.10008.5.1.4.1.1.1.1
Digital X-Ray Image Storage - For Processing. SOP	1.2.840.10008.5.1.4.1.1.1.1.1
X-Ray Radiofluoroscopic Image Storage	1.2.840.10008.5.1.4.1.1.12.2
X-Ray Radiation Dose SR	1.2.840.10008.5.1.4.1.1.88.67
Secondary Capture Image Storage SOP Class	1.2.840.10008.5.1.4.1.1.7

8.1.1.1. Computed Radiography Image Storage SOP Class

Table 62:SOP Class Modules

Information Entity	Module	Presence Of Module
Patient	Patient Module	ALWAYS
Study	General Study Module	ALWAYS
	Patient Study Module	USER OPTION
Series	General Series Module	ALWAYS
	CR Series Module	ALWAYS
Equipment	General Equipment Module	ALWAYS
Image	General Image Module	ALWAYS
	Image Pixel Module	ALWAYS
	Display Shutter Module	USER OPTION
	CR Image Module	ALWAYS
	Modality LUT Module	USER OPTION
	VOI LUT Module	USER OPTION
	SOP Common Module	ALWAYS
	Extended DICOM attributes	CONDITIONAL

Table 63:Patient Module

Attribute Name	Tag	VR	Value	Presence of Value	Source	Comment
Patient's Name	0010,0010	PN		VNAP		
Patient ID	0010,0020	LO		VNAP		
Issuer of Patient ID	0010,0021	LO		ANAP		
Patient's Birth Date	0010,0030	DA		VNAP		
Patient's Sex	0010,0040	CS		VNAP		
Other Patient IDs	0010,1000	LO		ANAP		
Ethnic Group	0010,2160	SH		ANAP		
Patient Comments	0010,4000	LT		ANAP		

Table 64:General Study Module

Attribute Name	Tag	VR	Value	Presence of Value	Source	Comment
Study Date	0008,0020	DA		VNAP		
Study Time	0008,0030	TM		VNAP		
Accession Number	0008,0050	SH		VNAP		
Referring Physician's Name	0008,0090	PN		VNAP		
Study Description	0008,1030	LO		ANAP		
Study Instance UID	0020,000D	UI		ALWAYS		
Study ID	0020,0010	SH		VNAP		
Requesting Service	0032,1033	LO		ANAP		

Table 65: Patient Study Module

Attribute Name	Tag	VR	Value	Presence of Value	Source	Comment
Patient's Age	0010,1010	AS		ANAP		

Patient's Size	0010,1020	DS		ANAP	MWL, USER	
Patient's Weight	0010,1030	DS		ANAP	MWL, USER	
Medical Alerts	0010,2000	LO		ANAP	MWL, USER	
Allergies	0010,2110	LO		ANAP	MWL, USER	
Additional Patient History	0010,21B0	LT		ANAP	MWL, USER	
Pregnancy Status	0010,21C0	US		ANAP	MWL, USER	
Patient State	0038,0500	LO		ANAP	MWL, USER	

Table 66:General Series Module

Attribute Name	Tag	VR	Value	Presence of Value	Source	Comment
Series Date	0008,0021	DA		ANAP		
Series Time	0008,0031	TM		ANAP		
Modality	0008,0060	CS	RF	ALWAYS		
Series Description	0008,103E	LO		ANAP		
Performing Physicians' Name	0008,1050	PN		ANAP		
Operators' Name	0008,1070	PN		ANAP		
Referenced Performed Procedure Step Sequence	0008,1111	SQ		ANAP		
>Referenced SOP Class UID	0008,1150	UI		ALWAYS		
>Referenced SOP Instance UID	0008,1155	UI		ALWAYS		
Body Part Examined	0018,0015	CS		ANAP		
Protocol Name	0018,1030	LO		ANAP		
Series Instance UID	0020,000E	UI		ALWAYS		
Series Number	0020,0011	IS		VNAP		
Laterality	0020,0060	CS		ANAP		
Performed Procedure Step Start Date	0040,0244	DA		ANAP		
Performed Procedure Step Start Time	0040,0245	TM		ANAP		
Performed Procedure Step ID	0040,0253	SH		ANAP		
Performed Procedure Step Description	0040,0254	LO		ANAP		

Table 67:CR Series Module

Attribute Name	Tag	VR	Value	Presence of Value	Source	Comment
Body Part Examined	0018,0015	CS		VNAP		
View Position	0018,5101	CS		VNAP		

Table 68:General Equipment Module

Attribute Name	Tag	VR	Value	Presence of Value	Source	Comment
Manufacturer	0008,0070	LO	Philips	VNAP		
Institution Name	0008,0080	LO		ANAP		
Institution Address	0008,0081	ST		ANAP		
Station Name	0008,1010	SH		ANAP		
Institutional Department Name	0008,1040	LO		ANAP		
Manufacturer's Model Name	0008,1090	LO	CombiDiagnost R90	ANAP		
Device Serial Number	0018,1000	LO		ANAP		
Software Version(s)	0018,1020	LO	1.1.0	ANAP	FIXED	
Spatial Resolution	0018,1050	DS		ANAP		

Table 69:General Image Module

Attribute Name	Tag	VR	Value	Presence of Value	Source	Comment
Image Type	0008,0008	CS	ORIGINAL\PRIMARY\	ANAP	AUTO	
Acquisition Date	0008,0022	DA		ANAP	AUTO	
Content Date	0008,0023	DA		ANAP	AUTO	
Acquisition DateTime	0008,002A	DT		ANAP	AUTO	
Acquisition Time	0008,0032	TM		ANAP	AUTO	
Content Time	0008,0033	TM		ANAP	AUTO	
Irradiation Event UID	0008,3010	UI		ANAP	AUTO	
Acquisition Number	0020,0012	IS		VNAP	AUTO	
Instance Number	0020,0013	IS		VNAP	AUTO	
Patient Orientation	0020,0020	CS		ANAP	USER	
Images in Acquisition	0020,1002	IS		VNAP	AUTO	
Quality Control Image	0028,0300	CS		ANAP	AUTO	
Burned In Annotation	0028,0301	CS		ANAP	AUTO	
Lossy Image Compression	0028,2110	CS	00	ANAP	FIXED	
Presentation LUT Shape	2050,0020	CS		ANAP	AUTO	

Table 70:Image Pixel Module

Attribute Name	Tag	VR	Value	Presence of Value	Source	Comment
Samples per Pixel	0028,0002	US		ALWAYS		
Photometric Interpretation	0028,0004	CS	MONOCHROME2	ALWAYS		
Rows	0028,0010	US		ALWAYS		
Columns	0028,0011	US		ALWAYS		
Bits Allocated	0028,0100	US		ALWAYS		
Bits Stored	0028,0101	US		ALWAYS		
High Bit	0028,0102	US		ALWAYS		
Pixel Representation	0028,0103	US		ALWAYS		
Pixel Data	7FE0,0010	OW/OB		ANAP		

Table 71: Display Shutter Module

Attribute Name	Tag	VR	Value	Presence of Value	Source	Comment
Shutter Shape	0018,1600	CS	POLYGONAL	ALWAYS		
Vertices of the Polygonal Shutter	0018,1620	IS		ANAP		

Table 72: CR Image Module

Attribute Name	Tag	VR	Value	Presence of Value	Source	Comment
KVP	0018,0060	DS		ANAP	AUTO	
Distance Source to Detector	0018,1110	DS		ANAP	AUTO	
Distance Source to Patient	0018,1111	DS		ANAP	AUTO	
Exposure Time	0018,1150	IS		ANAP	AUTO	
X-Ray Tube Current	0018,1151	IS		ANAP	AUTO	
Exposure	0018,1152	IS		ANAP	AUTO	
Exposure in μ As	0018,1153	IS		ANAP	AUTO	
Imager Pixel Spacing	0018,1164	DS		ANAP	AUTO	
Acquisition Device Processing Description	0018,1400	LO		ANAP	AUTO	
Relative X-Ray Exposure	0018,1405	IS		ANAP	AUTO	
Target Exposure Index	0018,1412	DS		ANAP	AUTO	
Deviation Index	0018,1413	DS		ANAP	AUTO	
Exposure Index	0018,1411	DS		ANAP	AUTO	
Photometric Interpretation	0028,0004	CS	MONOCHROME2	ALWAYS	AUTO	
Pixel Spacing	0028,0030	DS		ANAP	AUTO	

Table 73: Modality LUT Module

Attribute Name	Tag	VR	Value	Presence of Value	Source	Comment
Rescale Intercept	0028,1052	DS		ANAP		
Rescale Slope	0028,1053	DS		ANAP		
Rescale Type	0028,1054	LO		ANAP		

Table 74: VOI LUT Module

Attribute Name	Tag	VR	Value	Presence of Value	Source	Comment
Window Center	0028,1050	DS		ANAP	AUTO	
Window Width	0028,1051	DS		ANAP	AUTO	
VOI LUT Function	0028,1056	CS		ANAP	AUTO	

Table 75:SOP Common Module

Attribute Name	Tag	VR	Value	Presence of Value	Source	Comment
Specific Character Set	0008,0005	CS		ANAP	AUTO	
Instance Creation Date	0008,0012	DA		ANAP	AUTO	
Instance Creation Time	0008,0013	TM		ANAP	AUTO	
SOP Class UID	0008,0016	UI	1.2.840.10008.5.1.4.1.1.1	ALWAYS	AUTO	
SOP Instance UID	0008,0018	UI		ALWAYS	AUTO	
Instance Number	0020,0013	IS		ANAP	AUTO	

Table 76: Extended DICOM attributes for Computed Radiography Image Storage SOP Class

Attribute Name	Tag	VR	Value	Presence of Value	Source	Comment
Medical Alerts	0010,2000	LO		ANAP	COPY	
Allergies	0010,2110	LO		ANAP	COPY	
Pregnancy Status	0010,21C0	US		ANAP	COPY	
Image And Fluoroscopy Area Dose Product	0018,115E	DS		ANAP	COPY	
Grid	0018,1166	CS		ANAP	COPY	only if source image was a DX image (exported as CR)
Filter Material	0018,7050	CS		ANAP	COPY	only if source image was a DX image (exported as CR)
Requesting Physician	0032,1032	PN		ANAP	AUTO	
Requesting Service	0032,1033	LO		ANAP	COPY	
Requested Procedure Description	0032,1060	LO		ANAP	COPY	
Special Needs	0038,0050	LO		ANAP	COPY	
Patient State	0038,0500	LO		ANAP	COPY	
Performed Station AE Title	0040,0241	AE		ANAP	COPY	
Performed Procedure Step Status	0040,0252	CS		ANAP	COPY	
Total Number Of Exposures	0040,0301	US		ANAP	COPY	
Billing Procedure Step Sequence	0040,0320	SQ		ANAP	COPY	
Film Consumption Sequence	0040,0321	SQ		ANAP	COPY	
Requested Procedure ID	0040,1001	SH		ANAP	COPY	
Reason for The Requested Procedure	0040,1002	LO		ANAP	COPY	
Requested Procedure Priority	0040,1003	SH		ANAP	COPY	
Patient Transport Arrangements	0040,1004	LO		ANAP	COPY	
Names Of Intended Recipients Of Results	0040,1010	PN		ANAP	COPY	
Requested Procedure Comments	0040,1400	LT		ANAP	COPY	
Issue Date Of Imaging Service Request	0040,2004	DA		ANAP	COPY	
Imaging Service Request Comments	0040,2400	LT		ANAP	COPY	

8.1.1.2. Digital X-Ray Image Storage - For Presentation SOP

Table 77: SOP Class Modules

Information Entity	Module	Presence Of Module
Patient	Patient Module	ALWAYS
Study	General Study Module	ALWAYS
	Patient Study Module	USER OPTION
Series	General Series Module	ALWAYS
	DX Series Module	ALWAYS
Equipment	General Equipment Module	ALWAYS
Image	General Image Module	ALWAYS
	Image Pixel Module	ALWAYS
	Display Shutter Module	USER OPTION
	DX Anatomy Imaged Module	ALWAYS
	DX Image Module	ALWAYS
	DX Detector Module	ALWAYS
	X-Ray Collimator	USER OPTION
	DX Positioning Module	USER OPTION
	X-Ray Acquisition Dose Module	USER OPTION
	X-Ray Generation Module	USER OPTION
	X-Ray Filtration Module	USER OPTION
	X-Ray Grid Module	USER OPTION
	VOI LUT Module	USER OPTION
	Acquisition Context Module	ALWAYS
	SOP Common Module	ALWAYS
		Extended DICOM Attributes

Table 78: Patient Module

Attribute Name	Tag	VR	Value	Presence of Value	Source	Comment
Patient's Name	0010,0010	PN		VNAP		
Patient ID	0010,0020	LO		VNAP		
Issuer of Patient ID	0010,0021	LO		ANAP		
Patient's Birth Date	0010,0030	DA		VNAP		
Patient's Sex	0010,0040	CS		VNAP		
Other Patient IDs	0010,1000	LO		ANAP	MWL, USER	Not Present (This Attribute have been retired. See PS3.3 2017a.
Ethnic Group	0010,2160	SH		ANAP		
Patient Comments	0010,4000	LT		ANAP		

Table 79: General Study Module

Attribute Name	Tag	VR	Value	Presence of Value	Source	Comment
Study Date	0008,0020	DA		VNAP	AUTO	
Study Time	0008,0030	TM		VNAP	AUTO	

Accession Number	0008,0050	SH		VNAP	MWL, USER	
Referring Physician's Name	0008,0090	PN		VNAP	MWL, USER	
Study Description	0008,1030	LO		ANAP	MWL, USER	
Procedure Code Sequence	0008,1032	SQ		ANAP	MWL, USER	
>Code Value	0008,0100	SH		ANAP	MWL, USER	
>Coding Scheme Designator	0008,0102	SH		ANAP	MWL, USER	
>Coding Scheme Version	0008,0103	SH		ANAP	MWL, USER	
>Code Meaning	0008,0104	LO		ANAP	MWL, USER	
Study Instance UID	0020,000D	UI		ALWAYS	AUTO	
Study ID	0020,0010	SH		VNAP	AUTO	
Requesting Service	0032,1033	LO		ANAP	MWL, USER	

Table 80: Patient Study Module

Attribute Name	Tag	VR	Value	Presence of Value	Source	Comment
Patient's Age	0010,1010	AS		ANAP	MWL, USER	
Patient's Size	0010,1020	DS		ANAP	MWL, USER	
Patient's Weight	0010,1030	DS		ANAP	MWL, USER	
Additional Patient History	0010,21B0	LT		ANAP	MWL, USER	
Medical Alerts	0010,2000	LO		ANAP	MWL, USER	
Allergies	0010,2110	LO		ANAP	MWL, USER	
Occupation	0010,2180	SH		ANAP	MWL, USER	
Pregnancy Status	0010,21C0)	US		ANAP	MWL, USER	
Patient State	0038,0500	LO		ANAP	MWL, USER	

Table 81: General Series Module

Attribute Name	Tag	VR	Value	Presence of Value	Source	Comment
Series Date	0008,0021	DA		ANAP	AUTO	
Series Time	0008,0031	TM		ANAP	AUTO	
Modality	0008,0060	CS	RF	ALWAYS	CONFIG	
Series Description	0008,103E	LO		ANAP	MWL, USER	

Performing Physicians' Name	0008,1050	PN		ANAP	MWL, USER	
Operators' Name	0008,1070	PN		ANAP	MWL, USER	
Referenced Performed Procedure Step Sequence	0008,1111	SQ		ANAP	AUTO	
>Referenced SOP Class UID	0008,1150	UI		ALWAYS	AUTO	
>Referenced SOP Instance UID	0008,1155	UI		ALWAYS	AUTO	
Body Part Examined	0018,0015	CS		ANAP	MWL, USER	
Protocol Name	0018,1030	LO		ANAP	AUTO	
Series Instance UID	0020,000E	UI		ALWAYS	AUTO	
Series Number	0020,0011	IS		VNAP	AUTO	
Performed Procedure Step Start Date	0040,0244	DA		ANAP	AUTO	
Performed Procedure Step Start Time	0040,0245	TM		ANAP	AUTO	
Performed Procedure Step ID	0040,0253	SH		ANAP	AUTO	
Performed Procedure Step Description	0040,0254	LO		ANAP	AUTO	
Performed Protocol Code Sequence	0040,0260	SQ		ANAP	AUTO	
> Code Value	0008,0100	SH		ALWAYS	AUTO	
> Coding Scheme Designator	0008,0102	SH		ALWAYS	AUTO	
> Coding Scheme Version	0008,0103	SH		ALWAYS	AUTO	
> Code Meaning	0008,0104	LO		ALWAYS	AUTO	
Request Attributes Sequence	0040,0275	SQ		ANAP	AUTO	
> Requested Procedure Description	0032,1060	LO		ALWAYS	AUTO	
> Scheduled Procedure Step Description	0040,0007	LO		ALWAYS	AUTO	
>Scheduled Protocol Code Sequence	0040,0008	SQ		ALWAYS	AUTO	
>> Code Value	0008,0100	SH		ALWAYS	AUTO	
>> Coding Scheme Designator	0008,0102	SH		ALWAYS	AUTO	
>> Coding Scheme Version	0008,0103	SH		ALWAYS	AUTO	
>> Code Meaning	0008,0104	LO		ALWAYS	AUTO	
> Scheduled Procedure Step ID	0040,0009	SH		ALWAYS	AUTO	
> Requested Procedure ID	0040,1001	SH		ALWAYS	AUTO	

Table 82:DX Series Module

Attribute Name	Tag	VR	Value	Presence of Value	Source	Comment
Modality	0008,0060	CS		ALWAYS		
Presentation Intent Type	0008,0068	CS	FOR PRESENTATION	ALWAYS	FIXED	
Referenced Performed Procedure Step Sequence	0008,1111	SQ		ANAP		
>Referenced SOP Class UID	0008,1150	UI		ALWAYS		
>Referenced SOP Instance UID	0008,1155	UI		ALWAYS		

Table 23: General Equipment Module

Attribute Name	Tag	VR	Value	Presence of Value	Source	Comment
Manufacturer	0008,0070	LO	Philips	VNAP		
Institution Name	0008,0080	LO		ANAP		
Institution Address	0008,0081	ST		ANAP		
Station Name	0008,1010	SH		ANAP		
Institutional Department Name	0008,1040	LO		ANAP		
Manufacturer's Model Name	0008,1090	LO	CombiDiagnost R90	ANAP		
Device Serial Number	0018,1000	LO		ANAP		
Software Version(s)	0018,1020	LO	1.1.0	ANAP	FIXED	
Spatial Resolution	0018,1050	DS		ANAP		

Table 24: General Image Module

Attribute Name	Tag	VR	Value	Presence of Value	Source	Comment
Image Type	0008,0008	CS	ORIGINAL\PRIMARY\	ANAP	AUTO	
Acquisition Date	0008,0022	DA		ANAP	AUTO	
Content Date	0008,0023	DA		ANAP	AUTO	
Acquisition DateTime	0008,002A	DT		ANAP	AUTO	
Acquisition Time	0008,0032	TM		ANAP	AUTO	
Content Time	0008,0033	TM		ANAP	AUTO	
Anatomic Region Sequence	0008,2218	SQ		ANAP	AUTO	
Irradiation Event UID	0008,3010	UI		ANAP	AUTO	
Acquisition Number	0020,0012	IS		ANAP	AUTO	
Instance Number	0020,0013	IS		VNAP	AUTO	
Patient Orientation	0020,0020	CS		ANAP	AUTO	
Image Laterality	0020,0062	CS		ANAP	AUTO	
Images in Acquisition	0020,1002	IS		ANAP	AUTO	
Quality Control Image	0028,0300	CS		ANAP		
Burned In Annotation	0028,0301	CS		ANAP		
Lossy Image Compression	0028,2110	CS	00	ANAP	FIXED	
Presentation LUT Shape	2050,0020	CS		ANAP		

Table 83:Image Pixel Module

Attribute Name	Tag	VR	Value	Presence of Value	Source	Comment
Samples per Pixel	0028,0002	US		ALWAYS		
Photometric Interpretation	0028,0004	CS	MONOCHROME2	ALWAYS		
Rows	0028,0010	US		ALWAYS		
Columns	0028,0011	US		ALWAYS		
Bits Allocated	0028,0100	US		ALWAYS		
Bits Stored	0028,0101	US		ALWAYS		
High Bit	0028,0102	US		ALWAYS		
Pixel Representation	0028,0103	US		ALWAYS		
Pixel Data	7FE0,0010	OW/OB		ANAP		

Table 84:Display Shutter Module

Attribute Name	Tag	VR	Value	Presence of Value	Source	Comment
Shutter Shape	0018,1600	CS	POLYGONAL	ALWAYS		
Vertices of the Polygonal Shutter	0018,1620	IS		ANAP		

Table 85:DX Anatomy Imaged Module

Attribute Name	Tag	VR	Value	Presence of Value	Source	Comment
Anatomic Region Sequence	0008,2218	SQ		VNAP		
Image Laterality*	0020,0062	CS		ALWAYS		

Table 86:DX Image Module

Attribute Name	Tag	VR	Value	Presence of Value	Source	Comment
Image Type	0008,0008	CS	ORIGINAL\PRIMARY\	ALWAYS		
Acquisition Device Processing Description	0018,1400	LO		ANAP		
Patient Orientation	0020,0020	CS		ANAP		
Samples per Pixel	0028,0002	US		ALWAYS		
Photometric Interpretation	0028,0004	CS	MONOCHROME2	ALWAYS		
Bits Allocated	0028,0100	US		ALWAYS		
Bits Stored	0028,0101	US		ALWAYS		
High Bit	0028,0102	US		ALWAYS		
Pixel Representation	0028,0103	US		ALWAYS		
Burned In Annotation	0028,0301	CS		ALWAYS		
Pixel Intensity Relationship	0028,1040	CS		ALWAYS		
Pixel Intensity Relationship Sign	0028,1041	SS		ALWAYS		
Window Center	0028,1050	DS		ANAP		
Window Width	0028,1051	DS		ANAP		
Rescale Intercept	0028,1052	DS		ALWAYS		

Rescale Slope	0028,1053	DS		ALWAYS		
Rescale Type	0028,1054	LO		ALWAYS		
Lossy Image Compression	0028,2110	CS		ALWAYS		
Presentation LUT Shape	2050,0020	CS		ALWAYS		

*Note: To make sure that the DICOM Attribute Image Laterality (0020, 0062) is correctly filled one need to execute on of the following:

1. Preset per view in EPX.
2. Setting the Attribute manually via the Eleva-UI (Info TAB)

Table 87:DX Detector Module

Attribute Name	Tag	VR	Value	Presence of Value	Source	Comment
Imager Pixel Spacing	0018,1164	DS		ALWAYS	AUTO	
Exposure Index	0018,1411	DS		ANAP		
Target Exposure Index	0018,1412	DS		ANAP	AUTO	
Deviation Index	0018,1413	DS		ANAP	AUTO	
Detector Temperature	0018,7001	DS		ANAP	AUTO	
Detector Type	0018,7004	CS	SCINTILLATOR	VNAP	AUTO	
Detector Mode	0018,7008	LT		ANAP		
Detector ID	0018,700A	SH		ANAP		
Date of Last Detector Calibration	0018,700C	DA		ANAP	AUTO	
Time of Last Detector Calibration	0018,700E	TM		ANAP	AUTO	
Detector Manufacturer Name	0018,701A	LO				
Detector Manufacturer's Model Name	0018,7024	LO		ANAP		
Field of View Origin	0018,7030	DS		ANAP		
Field of View Rotation	0018,7032	DS		ANAP		
Field of View Horizontal Flip	0018,7034	CS		ANAP		
Pixel Spacing	0028,0030	DS		ANAP		

Table 88:X-Ray Collimator Module

Attribute Name	Tag	VR	Value	Presence of Value	Source	Comment
Collimator Shape	0018,1700	CS	RECTANGULAR	ALWAYS	FIXED	
Collimator Left Vertical Edge	0018,1702	IS		ANAP		
Collimator Right Vertical Edge	0018,1704	IS		ANAP		
Collimator Upper Horizontal Edge	0018,1706	IS		ANAP		
Collimator Lower Horizontal Edge	0018,1708	IS		ANAP		

Table 89: DX Positioning Module

Attribute Name	Tag	VR	Value	Presence of Value	Source	Comment
Distance Source to Detector	0018,1110	DS		ANAP		
Distance Source to Patient	0018,1111	DS		ANAP		

Estimated Radiographic Magnification Factor	0018,1114	DS		ANAP		
Positioner Type	0018,1508	CS		VNAP		
View Position	0018,5101	CS		ANAP		

Table 90:X-Ray Acquisition Dose Module

Attribute Name	Tag	VR	Value	Presence of Value	Source	Comment
KVP	0018,0060	DS		ANAP		
Distance Source to Detector	0018,1110	DS		ANAP		
Distance Source to Patient	0018,1111	DS		ANAP		
Exposure Time	0018,1150	IS		ANAP		
X-Ray Tube Current	0018,1151	IS		ANAP	AUTO	
Exposure	0018,1152	IS		ANAP		
Exposure in μ As	0018,1153	IS		ANAP		
Image and Fluoroscopy Area Dose Product	0018,115E	DS		ANAP		
Relative X-Ray Exposure	0018,1405	IS		ANAP		
Exposure Index	0018,1411	DS		ANAP		
Filter Material	0018,7050	CS		ANAP		
Target Exposure Index	0018,1412	DS		ANAP	AUTO	
Deviation Index	0018,1413	DS		ANAP	AUTO	
Exposure Time in μ S	0018,8150	DS		ANAP		
X-Ray Tube Current in μ A	0018,8151	DS				
Entrance Dose	0040,0302	US				
Entrance Dose in mGy	0040,8302	DS		ANAP		

Table 91:X-Ray Generation Module

Attribute Name	Tag	VR	Value	Presence of Value	Source	Comment
KVP	0018,0060	DS		ANAP		
Exposure Time	0018,1150	IS		ANAP		
X-Ray Tube Current	0018,1151	IS		ANAP	AUTO	
Exposure	0018,1152	IS		ANAP		
Exposure in μ As	0018,1153	IS		ANAP		
Exposure Control Mode	0018,7060	CS		ANAP		
Exposure Control Mode Description	0018,7062	LT		ANAP		The amplimat fields are coded bitwise bit 0 = upper left field bit 1 = upper right field bit 2 = middle field bit 3 = lower left field bit 4 = lower right field
Exposure Time in μ S	0018,8150	DS		ANAP		
X-Ray Tube Current in μ A	0018,8151	CS		ANAP	AUTO	

Table 92:X-Ray Filtration Module

Attribute Name	Tag	VR	Value	Presence of Value	Source	Comment
Filter Material	0018,7050	CS		ANAP		

Table 93:X-Ray Grid Module

Attribute Name	Tag	VR	Value	Presence of Value	Source	Comment
Grid	0018,1166	CS		ANAP		

Table 94: VOI LUT Module

Attribute Name	Tag	VR	Value	Presence of Value	Source	Comment
Window Center	0028,1050	DS		ANAP		
Window Width	0028,1051	DS		ANAP		
VOI LUT Function	0028,1056	CS		ANAP	AUTO	

Table 95: Acquisition Context Module

Attribute Name	Tag	VR	Value	Presence of Value	Source	Comment
Acquisition Context Sequence	0040,0555	SQ		VNAP		

Table 96:: SOP Common Module

Attribute Name	Tag	VR	Value	Presence of Value	Source	Comment
Specific Character Set	0008,0005	CS		ANAP		
Instance Creation Date	0008,0012	DA		ANAP	AUTO	
Instance Creation Time	0008,0013	TM		ANAP	AUTO	
SOP Class UID	0008,0016	UI	1.2.840.10008.5.1.4.1.1.1.1	ALWAYS		
SOP Instance UID	0008,0018	UI		ALWAYS		
Instance Number	0020,0013	IS		ANAP		

Table 97: Extended DICOM attributes for Digital X-Ray Image Storage - For Presentation SOP

Attribute Name	Tag	VR	Value	Presence of Value	Source	Comment
Medical Alerts	0010,2000	LO		ANAP	COPY	
Allergies	0010,2110	LO		ANAP	COPY	
Pregnancy Status	0010,21C0	US		ANAP	COPY	
Requesting Physician	0032,1032	PN		ANAP	AUTO	
Requesting Service	0032,1033	LO		ANAP	COPY	
Requested Procedure Description	0032,1060	LO		ANAP	COPY	
Special Needs	0038,0050	LO		ANAP	COPY	
Patient State	0038,0500	LO		ANAP	COPY	

Performed Station AE Title	0040,0241	AE		ANAP	COPY	
Performed Procedure Step Status	0040,0252	CS		ANAP	COPY	
Total Number Of Exposures	0040,0301	US		ANAP	COPY	
Billing Procedure Step Sequence	0040,0320	SQ		ANAP	COPY	
Film Consumption Sequence	0040,0321	SQ		ANAP	COPY	
Requested Procedure ID	0040,1001	SH		ANAP	COPY	
Reason for The Requested Procedure	0040,1002	LO		ANAP	COPY	
Requested Procedure Priority	0040,1003	SH		ANAP	COPY	
Patient Transport Arrangements	0040,1004	LO		ANAP	COPY	
Names Of Intended Recipients Of Results	0040,1010	PN		ANAP	COPY	
Requested Procedure Comments	0040,1400	LT		ANAP	COPY	
Issue Date Of Imaging Service Request	0040,2004	DA		ANAP	COPY	
Imaging Service Request Comments	0040,2400	LT		ANAP	COPY	

8.1.1.3. Digital X-Ray Image Storage - For Processing SOP

Table 98: SOP Class Modules

Information Entity	Module	Presence Of Module
Patient	Patient Module	ALWAYS
Study	General Study Module	ALWAYS
	Patient Study Module	USER OPTION
Series	General Series Module	ALWAYS
	DX Series Module	ALWAYS
Equipment	General Equipment Module	ALWAYS
Image	General Image Module	ALWAYS
	Image Pixel Module	ALWAYS
	DX Anatomy Imaged Module	ALWAYS
	DX Image Module	ALWAYS
	DX Detector Module	ALWAYS
	X-Ray Collimator	USER OPTION
	DX Positioning Module	USER OPTION
	X-Ray Acquisition Dose Module	USER OPTION
	X-Ray Generation Module	USER OPTION
	X-Ray Filtration Module	USER OPTION
	X-Ray Grid Module	USER OPTION
	VOI LUT Module	USER OPTION
	Acquisition Context Module	ALWAYS
	SOP Common Module	ALWAYS
	Extended DICOM attributes	CONDITIONAL

Table 99: Patient Module

Attribute Name	Tag	VR	Value	Presence of Value	Source	Comment
Patient's Name	0010,0010	PN		VNAP		
Patient ID	0010,0020	LO		VNAP		
Issuer of Patient ID	0010,0021	LO		ANAP		
Patient's Birth Date	0010,0030	DA		VNAP		

Patient's Sex	0010,0040	CS		VNAP		
Other Patient IDs	0010,1000	LO		ANAP	MWL, USER	Not present
Ethnic Group	0010,2160	SH		ANAP		
Patient Comments	0010,4000	LT		ANAP		

Table 100: General Study Module

Attribute Name	Tag	VR	Value	Presence of Value	Source	Comment
Study Date	0008,0020	DA		VNAP	MPPS	
Study Time	0008,0030	TM		VNAP	MPPS	
Accession Number	0008,0050	SH		VNAP	MWL, USER	
Referring Physician's Name	0008,0090	PN		VNAP	MWL, USER	
Study Description	0008,1030	LO		ANAP	MWL, USER	
Procedure Code Sequence	0008,1032	SQ		ANAP	MWL, USER	
>Code Value	0008,0100	SH		ANAP	MWL, USER	
>Coding Scheme Designator	0008,0102	SH		ANAP	MWL, USER	
>Coding Scheme Version	0008,0103	SH		ANAP	MWL, USER	
>Code Meaning	0008,0104	LO		ANAP	MWL, USER	
Study Instance UID	0020,000D	UI		ALWAYS	MPPS, AUTO	
Study ID	0020,0010	SH		VNAP	MPPS, AUTO	
Requesting Service	0032,1033	LO		ANAP	MWL, USER	

Table 101: Patient Study Module

Attribute Name	Tag	VR	Value	Presence of Value	Source	Comment
Patient's Age	0010,1010	AS		ANAP	MWL, USER	
Patient's Size	0010,1020	DS		ANAP	MWL, USER	
Patient's Weight	0010,1030	DS		ANAP	MWL, USER	
Medical Alerts	0010,2000	LO		ANAP	MWL, USER	
Allergies	0010,2110	LO		ANAP	MWL, USER	
Occupation	0010,2180	SH		ANAP	MWL, USER	

Additional Patient History	0010,21B0	LT		ANAP	MWL, USER	
Pregnancy Status	0010,21C0	US		ANAP	MWL, USER	
Patient State	0038,0500	LO		ANAP	MWL, USER	

Table 102:General Series Module

Attribute Name	Tag	VR	Value	Presence of Value	Source	Comment
Series Date	0008,0021	DA		ANAP	AUTO	
Series Time	0008,0031	TM		ANAP	AUTO	
Modality	0008,0060	CS	RF	ALWAYS	CONFIG	
Series Description	0008,103E	LO		ANAP	MWL, USER	
Performing Physicians' Name	0008,1050	PN		ANAP	MWL, USER	
Operators' Name	0008,1070	PN		ANAP	MWL, USER	
Referenced Performed Procedure Step Sequence	0008,1111	SQ		ANAP	AUTO	
>Referenced SOP Class UID	0008,1150	UI		ALWAYS	AUTO	
>Referenced SOP Instance UID	0008,1155	UI		ALWAYS	AUTO	
Body Part Examined	0018,0015	CS		ANAP	MWL, USER	
Protocol Name	0018,1030	LO		ANAP	AUTO	
Series Instance UID	0020,000E	UI		ALWAYS	AUTO	
Series Number	0020,0011	IS		VNAP	AUTO	
Performed Procedure Step Start Date	0040,0244	DA		ANAP	AUTO	
Performed Procedure Step Start Time	0040,0245	TM		ANAP	AUTO	
Performed Procedure Step ID	0040,0253	SH		ANAP	AUTO	
Performed Procedure Step Description	0040,0254	LO		ANAP	AUTO	
Performed Protocol Code Sequence	0040,0260	SQ		ANAP	AUTO	
> Code Value	0008,0100	SH		ALWAYS	AUTO	
> Coding Scheme Designator	0008,0102	SH		ALWAYS	AUTO	
> Coding Scheme Version	0008,0103	SH		ALWAYS	AUTO	
> Code Meaning	0008,0104	LO		ALWAYS	AUTO	
Request Attributes Sequence	0040,0275	SQ		ANAP	AUTO	
> Requested Procedure Description	0032,1060	LO		ALWAYS	AUTO	

> Scheduled Procedure Step Description	0040,0007	LO		ALWAYS	AUTO	
>Scheduled Protocol Code Sequence	0040,0008	SQ		ALWAYS	AUTO	
>> Code Value	0008,0100	SH		ALWAYS	AUTO	
>> Coding Scheme Designator	0008,0102	SH		ALWAYS	AUTO	
>> Coding Scheme Version	0008,0103	SH		ALWAYS	AUTO	
>> Code Meaning	0008,0104	LO		ALWAYS	AUTO	
> Scheduled Procedure Step ID	0040,0009	SH		ALWAYS	AUTO	
> Requested Procedure ID	0040,1001	SH		ALWAYS	AUTO	

Table 103:DX Series Module

Attribute Name	Tag	VR	Value	Presence of Value	Source	Comment
Modality	0008,0060	CS		ALWAYS		
Presentation Intent Type	0008,0068	CS	FOR PROCESSING	ALWAYS	FIXED	
Referenced Performed Procedure Step Sequence	0008,1111	SQ		ANAP		
>Referenced SOP Class UID	0008,1150	UI		ALWAYS		
>Referenced SOP Instance UID	0008,1155	UI		ALWAYS		

Table 104:General Equipment Module

Attribute Name	Tag	VR	Value	Presence of Value	Source	Comment
Manufacturer	0008,0070	LO	Philips	VNAP		
Institution Name	0008,0080	LO		ANAP		
Institution Address	0008,0081	ST		ANAP		
Station Name	0008,1010	SH		ANAP		
Institutional Department Name	0008,1040	LO		ANAP		
Manufacturer's Model Name	0008,1090	LO	CombiDiagnost R90	ANAP		
Device Serial Number	0018,1000	LO		ANAP		
Software Version(s)	0018,1020	LO	1.1.0	ANAP	FIXED	
Spatial Resolution	0018,1050	DS		ANAP		

Table 105:General Image Module

Attribute Name	Tag	VR	Value	Presence of Value	Source	Comment
Image Type	0008,0008	CS	ORIGINAL\PRIMARY\	ANAP	AUTO	
Acquisition Date	0008,0022	DA		ANAP	AUTO	
Content Date	0008,0023	DA		ANAP	AUTO	
Acquisition Date Time	0008,002A	DT		ANAP	AUTO	
Acquisition Time	0008,0032	TM		ANAP	AUTO	

Content Time	0008,0033	TM		ANAP	AUTO	
Anatomic Region Sequence	0008,2218	SQ		ANAP	AUTO	
Irradiation Event UID	0008,3010	UI		ANAP	AUTO	
Acquisition Number	0020,0012	IS		ANAP	AUTO	
Instance Number	0020,0013	IS		VNAP	AUTO	
Patient Orientation	0020,0020	CS		ANAP	AUTO	
Image Laterality	0020,0062	CS		ANAP	AUTO	
Images in Acquisition	0020,1002	IS		ANAP	AUTO	
Quality Control Image	0028,0300	CS		ANAP		
Burned In Annotation	0028,0301	CS		ANAP		
Lossy Image Compression	0028,2110	CS	00	ANAP	FIXED	
Presentation LUT Shape	2050,0020	CS		ANAP		

Table 106:Image Pixel Module

Attribute Name	Tag	VR	Value	Presence of Value	Source	Comment
Samples per Pixel	0028,0002	US		ALWAYS		
Photometric Interpretation	0028,0004	CS	MONOCHROME2	ALWAYS		
Rows	0028,0010	US		ALWAYS		
Columns	0028,0011	US		ALWAYS		
Bits Allocated	0028,0100	US		ALWAYS		
Bits Stored	0028,0101	US		ALWAYS		
High Bit	0028,0102	US		ALWAYS		
Pixel Representation	0028,0103	US		ALWAYS		
Pixel Data	7FE0,0010	OW/OB		ANAP		

Table 107:DX Anatomy Imaged Module

Attribute Name	Tag	VR	Value	Presence of Value	Source	Comment
Anatomic Region Sequence	0008,2218	SQ		VNAP		
Image Laterality*	0020,0062	CS		ALWAYS		

*Note: To make sure that the DICOM Attribute Image Laterality (0020, 0062) is correctly filled one need to execute on of the following:

1. Preset per view in EPX.
2. Setting the Attribute manually via the Eleva-UI (Info TAB)

Table 108:DX Image Module

Attribute Name	Tag	VR	Value	Presence of Value	Source	Comment
Image Type	0008,0008	CS	ORIGINAL\PRIMARY\	ALWAYS		
Acquisition Device Processing Description	0018,1400	LO		ANAP		
Patient Orientation	0020,0020	CS		ANAP		
Samples per Pixel	0028,0002	US		ALWAYS		
Photometric Interpretation	0028,0004	CS	MONOCHROME2	ALWAYS		
Bits Allocated	0028,0100	US		ALWAYS		

Bits Stored	0028,0101	US		ALWAYS		
High Bit	0028,0102	US		ALWAYS		
Pixel Representation	0028,0103	US		ALWAYS		
Burned In Annotation	0028,0301	CS		ALWAYS		
Pixel Intensity Relationship	0028,1040	CS		ALWAYS		
Pixel Intensity Relationship Sign	0028,1041	SS		ALWAYS		
Window Center	0028,1050	DS		ANAP		
Window Width	0028,1051	DS		ANAP		
Rescale Intercept	0028,1052	DS		ALWAYS		
Rescale Slope	0028,1053	DS		ALWAYS		
Rescale Type	0028,1054	LO		ALWAYS		
Lossy Image Compression	0028,2110	CS		ALWAYS		
Presentation LUT Shape	2050,0020	CS		ALWAYS		

Table 109:DX Detector Module

Attribute Name	Tag	VR	Value	Presence of Value	Source	Comment
Imager Pixel Spacing	0018,1164	DS		ALWAYS	AUTO	
Exposure Index	0018,1411	DS		ANAP		
Target Exposure Index	0018,1412	DS		ANAP	AUTO	
Deviation Index	0018,1413	DS		ANAP	AUTO	
Detector Temperature	0018,7001	DS		ANAP	AUTO	
Detector Type	0018,7004	CS	SCINTILLATOR	VNAP	AUTO	
Detector Mode	0018,7008	LT		ANAP		
Detector ID	0018,700A	SH		ANAP		
Date of Last Detector Calibration	0018,700C	DA		ANAP	AUTO	
Time of Last Detector Calibration	0018,700E	TM		ANAP	AUTO	
Detector Manufacturer Name	0018,701A	LO				
Detector Manufacturer's Model Name	0018,7024	LO		ANAP		
Field of View Origin	0018,7030	DS		ANAP		
Field of View Rotation	0018,7032	DS		ANAP		
Field of View Horizontal Flip	0018,7034	CS		ANAP		
Pixel Spacing	0028,0030	DS		ANAP		

Table 110:X-Ray Collimator Module

Attribute Name	Tag	VR	Value	Presence of Value	Source	Comment
Collimator Shape	0018,1700	CS	RECTANGULAR	ALWAYS	FIXED	
Collimator Left Vertical Edge	0018,1702	IS		ANAP		
Collimator Right Vertical Edge	0018,1704	IS		ANAP		
Collimator Upper Horizontal Edge	0018,1706	IS		ANAP		
Collimator Lower Horizontal Edge	0018,1708	IS		ANAP		

Table 111: DX Positioning Module

Attribute Name	Tag	VR	Value	Presence of Value	Source	Comment
Distance Source to Detector	0018,1110	DS		ANAP		
Distance Source to Patient	0018,1111	DS		ANAP		
Estimated Radiographic Magnification Factor	0018,1114	DS		ANAP		
Positioner Type	0018,1508	CS		VNAP		
View Position	0018,5101	CS		ANAP		

Table 112:X-Ray Acquisition Dose Module

Attribute Name	Tag	VR	Value	Presence of Value	Source	Comment
KVP	0018,0060	DS		ANAP		
Distance Source to Detector	0018,1110	DS		ANAP		
Distance Source to Patient	0018,1111	DS		ANAP		
Exposure Time	0018,1150	IS		ANAP		
Exposure	0018,1152	IS		ANAP		
Exposure in μ As	0018,1153	IS		ANAP		
Image and Fluoroscopy Area Dose Product	0018,115E	DS		ANAP		
Relative X-Ray Exposure	0018,1405	IS		ANAP		
Exposure Index	0018,1411	DS		ANAP		
Target Exposure Index	0018,1412	DS		ANAP	AUTO	
Deviation Index	0018,1413	DS		ANAP	AUTO	
Filter Material	0018,7050	CS		ANAP		
Exposure Time in μ S	0018,8150	DS		ANAP		
X-Ray Tube Current in μ	0018,8151	DS		ANAP	AUTO	
Entrance Dose	0040,0302	US				
Entrance Dose in mGy	0040,8302	DS		ANAP		

Table 113:X-Ray Generation Module

Attribute Name	Tag	VR	Value	Presence of Value	Source	Comment
KVP	0018,0060	DS		ANAP		
Exposure Time	0018,1150	IS		ANAP		
X-Ray Tube Current	0018,1151	IS		ANAP	AUTO	
Exposure	0018,1152	IS		ANAP		
Exposure in μ As	0018,1153	IS		ANAP		
Exposure Control Mode	0018,7060	CS		ANAP		
Exposure Control Mode Description	0018,7062	LT		ANAP		The amplimat fields are coded bitwise bit 0 = upper left field bit 1 = upper right field bit 2 = middle field bit 3 = lower left field bit 4 = lower right field

Exposure Time in μ S	0018,8150	DS		ANAP		
X-Ray Tube Current in μ A	0018,8151	DS		ANAP	AUTO	

Table 114:X-Ray Filtration Module

Attribute Name	Tag	VR	Value	Presence of Value	Source	Comment
Filter Material	0018,7050	CS		ANAP		

Table 115:X-Ray Grid Module

Attribute Name	Tag	VR	Value	Presence of Value	Source	Comment
Grid	0018,1166	CS		ANAP		

Table 116: VOI LUT Module

Attribute Name	Tag	VR	Value	Presence of Value	Source	Comment
Window Center	0028,1050	DS		ANAP		
Window Width	0028,1051	DS		ANAP		
VOI LUT Function	0028,1056	CS		ANAP	AUTO	

Table 117: Acquisition Context Module

Attribute Name	Tag	VR	Value	Presence of Value	Source	Comment
Acquisition Context Sequence	0040,0555	SQ		VNAP		

Table 118:SOP Common Module

Attribute Name	Tag	VR	Value	Presence of Value	Source	Comment
Specific Character Set	0008,0005	CS		ANAP		
Instance Creation Date	0008,0012	DA		ANAP	AUTO	
Instance Creation Time	0008,0013	TM		ANAP	AUTO	
SOP Class UID	0008,0016	UI	1.2.840.10008.5.1.4.1.1.1.1.1	ALWAYS		
SOP Instance UID	0008,0018	UI		ALWAYS		
Instance Number	0020,0013	IS		ANAP		

Table 119: Extended DICOM attributes for Digital X-Ray Image Storage - For Presentation SOP

Attribute Name	Tag	VR	Value	Presence of Value	Source	Comment
Medical Alerts	0010,2000	LO		ANAP	COPY	
Allergies	0010,2110	LO		ANAP	COPY	
Pregnancy Status	0010,21C0	US		ANAP	COPY	
Requesting Physician	0032,1032	PN		ANAP	AUTO	
Requesting Service	0032,1033	LO		ANAP	COPY	
Requested Procedure Description	0032,1060	LO		ANAP	COPY	

Special Needs	0038,0050	LO		ANAP	COPY	
Patient State	0038,0500	LO		ANAP	COPY	
Performed Station AE Title	0040,0241	AE		ANAP	COPY	
Performed Procedure Step Status	0040,0252	CS		ANAP	COPY	
Total Number Of Exposures	0040,0301	US		ANAP	COPY	
Billing Procedure Step Sequence	0040,0320	SQ		ANAP	COPY	
Film Consumption Sequence	0040,0321	SQ		ANAP	COPY	
Requested Procedure ID	0040,1001	SH		ANAP	COPY	
Reason for The Requested Procedure	0040,1002	LO		ANAP	COPY	
Requested Procedure Priority	0040,1003	SH		ANAP	COPY	
Patient Transport Arrangements	0040,1004	LO		ANAP	COPY	
Names Of Intended Recipients Of Results	0040,1010	PN		ANAP	COPY	
Requested Procedure Comments	0040,1400	LT		ANAP	COPY	
Issue Date Of Imaging Service Request	0040,2004	DA		ANAP	COPY	
Imaging Service Request Comments	0040,2400	LT		ANAP	COPY	

8.1.1.4. X-Ray Radiofluoroscopic Image Storage SOP Class

Table 120:IOD of Created X-Ray Radiofluoroscopic Image Storage SOP Class

Information Entity	Module	Presence Of Module
Patient	Patient Module	ALWAYS
Study	General Study Module	ALWAYS
	Patient Study Module	USER OPTION
Series	General Series Module	ALWAYS
Equipment	General Equipment Module	ALWAYS
Image	General Image Module	ALWAYS
	Image Pixel Module	ALWAYS
	Cine Module	CONDITIONAL (Required if pixel data is Multi-frame CineData)
	Multi-Frame Module	CONDITIONAL (Required if pixel data is Multi-frame CineData)
	Frame Pointers	USER OPTION
	Display Shutter Module	USER OPTION
	X-Ray Image Module	ALWAYS
	X-Ray Acquisition Module	ALWAYS
	X-Ray Collimator Module	USER OPTION
	X-Ray Table Module	USER OPTION
	XRF Positioner Module	USER OPTION
	DX Detector Module	USER OPTION
	VOI LUT Module	USER OPTION
	SOP Common Module	ALWAYS
Extended DICOM and attributes		CONDITIONAL

Table 121:Patient Module

Attribute Name	Tag	VR	Value	Presence of Value	Source	Comment
Patient's Name	0010,0010	PN		VNAP		
Patient ID	0010,0020	LO		VNAP		

Issuer of Patient ID	0010,0021	LO		ANAP		
Patient's Birth Date	0010,0030	DA		VNAP		
Patient's Sex	0010,0040	CS		VNAP		
Other Patient IDs	0010,1000	LO		ANAP	MWL, USER	Present in DCM
Ethnic Group	0010,2160	SH		ANAP		
Patient Comments	0010,4000	LT		ANAP		

Table 122: General Study Module

Attribute Name	Tag	VR	Value	Presence of Value	Source	Comment
Study Date	0008,0020	DA		VNAP		
Study Time	0008,0030	TM		VNAP		
Accession Number	0008,0050	SH		VNAP		
Referring Physician's Name	0008,0090	PN		VNAP		
Study Description	0008,1030	LO		ANAP		
Study Instance UID	0020,000D	UI		ALWAYS		
Study ID	0020,0010	SH		VNAP		
Requesting Service	0032,1033	LO		ANAP	MWL, USER	

Table 123: Patient Study Module

Attribute Name	Tag	VR	Value	Presence of Value	Source	Comment
Patient's Age	0010,1010	AS		ANAP		
Patient's Size	0010,1020	DS		ANAP		
Patient's Weight	0010,1030	DS		ANAP		
Medical Alerts	0010,2000	LO		ANAP	MWL, USER	
Allergies	0010,2110	LO		ANAP	MWL, USER	
Additional Patient History	0010,21B0	LT		ANAP		
Pregnancy Status	0010,21C0	US		ANAP	MWL, USER	
Patient State	0038,0500	LO		ANAP	MWL, USER	

Table 124: General Series Module

Attribute Name	Tag	VR	Value	Presence of Value	Source	Comment
Series Date	0008,0021	DA		ANAP		
Series Time	0008,0031	TM		ANAP		
Modality	0008,0060	CS	RF	ALWAYS		
Operators' Name	0008,1070	PN		ANAP		
Referenced Performed Procedure Step Sequence	0008,1111	SQ		ANAP		
>Referenced SOP Class UID	0008,1150	UI		ALWAYS		
>Referenced SOP Instance UID	0008,1155	UI		ALWAYS		

Body Part Examined	0018,0015	CS		ANAP		
Series Instance UID	0020,000E	UI		ALWAYS		
Series Number	0020,0011	IS		VNAP		
Laterality	0020,0060	CS		ANAP		
Performed Procedure Step Start Date	0040,0244	DA		ANAP		
Performed Procedure Step Start Time	0040,0245	TM		ANAP		
Performed Procedure Step ID	0040,0253	SH		ANAP		
Performed Procedure Step Description	0040,0254	LO		ANAP		

Table 125: General Equipment Module

Attribute Name	Tag	VR	Value	Presence of Value	Source	Comment
Manufacturer	0008,0070	LO	Philips	VNAP		
Institution Name	0008,0080	LO		ANAP		
Institution Address	0008,0081	ST		ANAP		
Station Name	0008,1010	SH		ANAP		
Institutional Department Name	0008,1040	LO		ANAP		
Manufacturer's Model Name	0008,1090	LO	CombiDiagnost R90	ANAP		
Device Serial Number	0018,1000	LO		ANAP		
Software Version(s)	0018,1020	LO	1.1.0	ANAP		

Table 126: General Image Module

Attribute Name	Tag	VR	Value	Presence of Value	Source	Comment
Image Type	0008,0008	CS	ORIGINAL\PRIMARY\ SINGLE PLANE	ANAP		
Acquisition Date	0008,0022	DA		ANAP		
Content Date	0008,0023	DA		ANAP		
Acquisition DateTime	0008,002A	DT		ANAP		
Acquisition Time	0008,0032	TM		ANAP		
Content Time	0008,0033	TM		ANAP		
Irradiation Event UID	0008,3010	UI		ANAP		
Acquisition Number	0020,0012	IS		ANAP	AUTO	Not present in DCM
Instance Number	0020,0013	IS		VNAP		
Patient Orientation	0020,0020	CS		ANAP		
Images in Acquisition	0020,1002	IS				
Lossy Image Compression	0028,2110	CS	00	ANAP		

Table 127: Image Pixel Module

Attribute Name	Tag	VR	Value	Presence of Value	Source	Comment
Samples per Pixel	0028,0002	US		ALWAYS		
Photometric Interpretation	0028,0004	CS	MONOCHROME2	ALWAYS		System has a way to generate both values MONOCHROME1 and MONOCHROME2

Rows	0028,0010	US		ALWAYS		
Columns	0028,0011	US		ALWAYS		
Pixel Aspect Ratio	0028,0034	IS		ANAP		
Bits Allocated	0028,0100	US		ALWAYS		
Bits Stored	0028,0101	US		ALWAYS		
High Bit	0028,0102	US		ALWAYS		
Pixel Representation	0028,0103	US		ALWAYS		
Pixel Data	7FE0,0010	OW/OB		ANAP		

Table 128: Cine Module

Attribute Name	Tag	VR	Value	Presence of Value	Source	Comment
Recommended Display Frame Rate	0008,2144	IS		ANAP		
Cine Rate	0018,0040	IS		ANAP		
Frame Time Vector	0018,1065	DS		ANAP		

Table 129: Multi-Frame Module

Attribute Name	Tag	VR	Value	Presence of Value	Source	Comment
Number of Frames	0028,0008	IS		ALWAYS	AUTO	
Frame Increment Pointer	0028,0009	AT	00181065	ALWAYS	FIXED	

Table 130: Frame Pointers Module

Attribute Name	Tag	VR	Value	Presence of Value	Source	Comment
Representative Frame Number	0028,6010	US		ANAP	AUTO	

Table 131: Display Shutter Module

Attribute Name	Tag	VR	Value	Presence of Value	Source	Comment
Shutter Shape	0018,1600	CS	RECTANGULAR	ALWAYS		
Shutter Left Vertical Edge	0018,1602	IS		ANAP		
Shutter Right Vertical Edge	0018,1604	IS		ANAP		
Shutter Upper Horizontal Edge	0018,1606	IS		ANAP		
Shutter Lower Horizontal Edge	0018,1608	IS		ANAP		

Table 132: X-Ray Image Module

Attribute Name	Tag	VR	Value	Presence of Value	Source	Comment
Image Type	0008,0008	CS	ORIGINAL\PRIMARY\ SINGLE PLANE	ALWAYS		
Samples per Pixel	0028,0002	US		ALWAYS		
Photometric Interpretation	0028,0004	CS	MONOCHROME2	ALWAYS		System has a way to generate both values MONOCHROME1 and MONOCHROME2
Frame Increment Pointer	0028,0009	AT		ANAP	AUTO	Not present in DCM
Bits Allocated	0028,0100	US		ALWAYS		

Bits Stored	0028,0101	US		ALWAYS		System has Export bit (10/12/15) depth setting
High Bit	0028,0102	US		ALWAYS		
Pixel Representation	0028,0103	US		ALWAYS		
Pixel Intensity Relationship	0028,1040	CS		ALWAYS		
Lossy Image Compression	0028,2110	CS	00	ANAP		

Table 133:X-Ray Acquisition Module

Attribute Name	Tag	VR	Value	Presence of Value	Source	Comment
KVP	0018,0060	DS		VNAP		
Field of View Shape	0018,1147	CS	RECTANGLE	ANAP		
Exposure Time	0018,1150	IS		ANAP		
Exposure	0018,1152	IS		ANAP		
Exposure in μ As	0018,1153	IS		ANAP	AUTO	
Average Pulse Width	0018,1154	DC		ANAP	AUTO	
Radiation Setting	0018,1155	CS		ALWAYS		
Radiation Mode	0018,115A	CS		ANAP		
Image and Fluoroscopy Area Dose Product	0018,115E	DS		ANAP		
Imager Pixel Spacing	0018,1164	DS		ANAP		
Grid	0018,1166	CS	IN	ANAP		
Exposure Time in μ S	0018,8150	DS				
Pixel Spacing	0028,0030	DS				
Pixel Spacing Calibration Type	0028,0A02	CS	GEOMETRY	ANAP		
Pixel Spacing Calibration Description	0028,0A04	LO				

Table 134:X-Ray Collimator Module

Attribute Name	Tag	VR	Value	Presence of Value	Source	Comment
Collimator Shape	0018,1700	CS	RECTANGULAR	ALWAYS	FIXED	
Collimator Left Vertical Edge	0018,1702	IS		ANAP		
Collimator Right Vertical Edge	0018,1704	IS		ANAP		
Collimator Upper Horizontal Edge	0018,1706	IS		ANAP		
Collimator Lower Horizontal Edge	0018,1708	IS		ANAP		

Table 135:X-Ray Table Module

Attribute Name	Tag	VR	Value	Presence of Value	Source	Comment
Table Motion	0018,1134	CS		VNAP		
Table Angle	0018,1138	DS		ANAP		

Table 136: XRF Positioner Module

Attribute Name	Tag	VR	Value	Presence of Value	Source	Comment
Distance Source to Detector	0018,1110	DS		ANAP		
Distance Source to Patient	0018,1111	DS		ANAP		
Estimated Radiographic Magnification Factor	0018,1114	DS		ANAP		
Column Angulation	0018,1450	DS		ANAP		

Table 137: DX Detector Module

Attribute Name	Tag	VR	Value	Presence of Value	Source	Comment
Field of View Shape	0018,1147	CS	RECTANGLE	ANAP		
Imager Pixel Spacing	0018,1164	DS		ALWAYS	AUTO	
Exposure Index	0018,1411	DS		ANAP		
Sensitivity	0018,6000	DS		ANAP		
Detector Temperature	0018,7001	DS		ANAP	AUTO	
Detector Type	0018,7004	CS	SCINTILLATOR	VNAP	AUTO	
Detector Configuration	0018,7005	CS	AREA	ANAP		
Detector Mode	0018,7008	LT		ANAP		
Detector ID	0018,700A	SH		ANAP		
Date of Last Detector Calibration	0018,700C	DA		ANAP	AUTO	
Time of Last Detector Calibration	0018,700E	TM		ANAP	AUTO	
Detector Binning	0018,701A	DS				
Detector Active Shape	0018,7024	CS	RECTANGLE	ANAP		
Detector Active Dimension(s)	0018,7026	DS		ANAP		
Field of View Origin	0018,7030	DS		VNAP		
Field of View Rotation	0018,7032	DS		VNAP		
Field of View Horizontal Flip	0018,7034	DS		VNAP		
Pixel Spacing	0028,0030	DS		VNAP		
Pixel Spacing Calibration Type	0028,0A02	CS	GEOMETRY	ANAP		
Pixel Spacing Calibration Description	0028,0A04	LO		ANAP		

Table 138: VOI LUT Module

Attribute Name	Tag	VR	Value	Presence of Value	Source	Comment
Window Center	0028,1050	DS		ANAP		
Window Width	0028,1051	DS		ANAP		

Table 139: SOP Common Module

Attribute Name	Tag	VR	Value	Presence of Value	Source	Comment
Specific Character Set	0008,0005	CS		ANAP	AUTO	
Instance Creation Date	0008,0012	DA		ANAP	AUTO	

Instance Creation Time	0008,0013	TM		ANAP	AUTO	
SOP Class UID	0008,0016	UI	1.2.840.10008.5.1.4.1.1.12.2	ALWAYS		
SOP Instance UID	0008,0018	UI		ALWAYS		
Instance Number	0020,0013	IS		ANAP		

Table 135: Extended DICOM attributes for X-Ray Radiofluoroscopic Image Storage SOP Class

Attribute Name	Tag	VR	Value	Presence of Value	Source	Comment
Medical Alerts	0010,2000	LO		ANAP	COPY	
Allergies	0010,2110	LO		ANAP	COPY	
Pregnancy Status	0010,21C0	US		ANAP	COPY	
View Position	0018,5101	CS		ANAP	COPY	
Requesting Physician	0032,1032	PN		ANAP	AUTO	
Requesting Service	0032,1033	LO		ANAP	COPY	
Requested Procedure Description	0032,1060	LO		ANAP	COPY	
Special Needs	0038,0050	LO		ANAP	COPY	
Patient State	0038,0500	LO		ANAP	COPY	
Performed Station AE Title	0040,0241	AE		ANAP	COPY	
Performed Procedure Step Status	0040,0252	CS		ANAP	COPY	
Total Number Of Exposures	0040,0301	US		ANAP	COPY	
Entrance Dose	0040,0302	US		ANAP	COPY	
Billing Procedure Step Sequence	0040,0320	SQ		ANAP	COPY	
Film Consumption Sequence	0040,0321	SQ		ANAP	COPY	
Requested Procedure ID	0040,1001	SH		ANAP	COPY	
Reason for The Requested Procedure	0040,1002	LO		ANAP	COPY	
Requested Procedure Priority	0040,1003	SH		ANAP	COPY	
Patient Transport Arrangements	0040,1004	LO		ANAP	COPY	
Names Of Intended Recipients Of Results	0040,1010	PN		ANAP	COPY	
Requested Procedure Comments	0040,1400	LT		ANAP	COPY	
Issue Date Of Imaging Service Request	0040,2004	DA		ANAP	COPY	
Imaging Service Request Comments	0040,2400	LT		ANAP	COPY	
Entrance Dose In mGy	0040,8302	DS		ANAP	COPY	

8.1.1.5. Secondary Capture Image Storage SOP class**Table 140: IOD of Created SC Image Storage SOP Class**

Information Entity	Module	Presence Of Module
Patient	Patient Module	ALWAYS
Study	General Study Module	ALWAYS
	Patient Study Module	ALWAYS
Series	General Series Module	ALWAYS
	SC Equipment Module	ALWAYS
Equipment	General Equipment Module	ALWAYS
	SC Equipment Module	ALWAYS
Image	General Image Module	ALWAYS
	Image Pixel Module	ALWAYS
	SC Image Module	CONDITIONAL (not present in session objects)
	VOI LUT Module	CONDITIONAL (not present in session objects)
	SOP Common Module	ALWAYS
	Extended DICOM attributes	CONDITIONAL

Table 141: Patient Module

Attribute Name	Tag	VR	Value	Presence of Value	Source	Comment
Patient's Name	0010,0010	PN		VNAP		
Patient ID	0010,0020	LO		VNAP		
Issuer of Patient ID	0010,0021	LO		ANAP		
Patient's Birth Date	0010,0030	DA		VNAP		
Patient's Sex	0010,0040	CS		VNAP		
Other Patient IDs	0010,1000	LO		ANAP	MWL, USER	Not Present in DCM
Ethnic Group	0010,2160	SH		ANAP		
Patient Comments	0010,4000	LT		ANAP		

Table 142: General Study Module

Attribute Name	Tag	VR	Value	Presence of Value	Source	Comment
Study Date	0008,0020	DA		VNAP	COPY	
Study Time	0008,0030	TM		VNAP	COPY	
Accession Number	0008,0050	SH		VNAP	COPY	
Referring Physician's Name	0008,0090	PN		VNAP	COPY	
Study Description	0008,1030	LO		VNAP	COPY	
Study Instance UID	0020,000D	UI		ALWAYS	COPY	
Study ID	0020,0010	SH		VNAP	COPY	
Requesting Service	0032,1033	LO		VNAP	MWL, USER	

Table 143: Patient Study Module

Attribute Name	Tag	VR	Value	Presence of Value	Source	Comment
Patient's Age	0010,1010	AS		ANAP	COPY	
Patient's Size	0010,1020	DS		ANAP	COPY	
Patient's Weight	0010,1030	DA		ANAP	COPY	
Medical Alerts	0010,2000	LO		ANAP	MWL, USER	
Allergies	0010,2110	LO		ANAP	MWL, USER	
Additional Patient History	0010,21B0	LT		ANAP	COPY	
Pregnancy Status	0010,21C0	US		ANAP	MWL, USER	
Patient State	0038,0500	LO		ANAP	MWL, USER	

Table 144: General Series Module

Attribute Name	Tag	VR	Value	Presence of Value	Source	Comment
Series Date	0008,0021	DA		ANAP		
Series Time	0008,0031	TM		ANAP		
Modality	0008,0060	CS	RF	ALWAYS		
Series Description	0008,103E	LO		ANAP		

Performing Physicians' Name	0008,1050	PN		ANAP		
Operators' Name	0008,1070	PN		ANAP		
Referenced Performed Procedure Step Sequence	0008,1111	SQ		ANAP		
>Referenced SOP Class UID	0008,1150	UI		ALWAYS		
>Referenced SOP Instance UID	0008,1155	UI		ALWAYS		
Body Part Examined	0018,0015	CS		ANAP		
Protocol Name	0018,1030	LO		ANAP		
Series Instance UID	0020,000E	UI		ALWAYS		
Series Number	0020,0011	IS		VNAP		
Laterality	0020,0060	CS		ANAP	AUTO	Not present in DCM
Performed Procedure Step Start Date	0040,0244	DA		ANAP		
Performed Procedure Step Start Time	0040,0245	TM		ANAP		
Performed Procedure Step ID	0040,0253	SH		ANAP		
Performed Procedure Step Description	0040,0254	LO		ANAP		

Table 145: General Equipment Module

Attribute Name	Tag	VR	Value	Presence of Value	Source	Comment
Manufacturer	0008,0070	LO	Philips	VNAP	FIXED	
Institution Name	0008,0080	LO		ANAP		
Institution Address	0008,0081	ST		ANAP		
Station Name	0008,1010	SH		ANAP		
Institutional Department Name	0008,1040	LO		ANAP		
Manufacturer's Model Name	0008,1090	LO	CombiDiagnost R90	ANAP	FIXED	
Device Serial Number	0018,1000	LO		ANAP	CONFIG	
Software Version(s)	0018,1020	LO	1.1.0	ANAP	FIXED	
Spatial Resolution	0018,1050	DS		ANAP		

Table 146: SC Equipment Module

Attribute Name	Tag	VR	Value	Presence of Value	Source	Comment
Modality	0008,0060	CS	RF	ANAP	FIXED	
Conversion Type	0008,0064	CS	WSD	ALWAYS	FIXED	

Table 147: General Image Module

Attribute Name	Tag	VR	Value	Presence of Value	Source	Comment
Image Type	0008,0008	CS	ORIGINAL\PRIMARY\ SINGLE PLANE	ANAP		
Acquisition Date	0008,0022	DA		ANAP		
Content Date	0008,0023	DA		ANAP		
Acquisition DateTime	0008,002A	DT		ANAP		
Acquisition Time	0008,0032	TM		ANAP		
Content Time	0008,0033	TM		ANAP		
Irradiation Event UID	0008,3010	UI		ANAP		

Acquisition Number	0020,0012	IS		VNAP	AUTO	
Instance Number	0020,0013	IS		VNAP		
Patient Orientation	0020,0020	CS		ANAP		
Images in Acquisition	0020,1002	IS		VNAP	AUTO	
Quality Control Image	0028,0300	CS		ANAP		
Burned In Annotation	0028,0301	CS		ANAP		
Lossy Image Compression	0028,2110	CS	00	ANAP		

Table 148: Image Pixel Module

Attribute Name	Tag	VR	Value	Presence of Value	Source	Comment
Samples per Pixel	0028,0002	US		ALWAYS	FIXED	
Photometric Interpretation	0028,0004	CS	MONOCHROME1	ALWAYS	FIXED	
Rows	0028,0010	US		ALWAYS	AUTO	
Columns	0028,0011	US		ALWAYS	AUTO	
Bits Allocated	0028,0100	US		ALWAYS	FIXED	
Bits Stored	0028,0101	US		ALWAYS	FIXED	
High Bit	0028,0102	US		ALWAYS	FIXED	
Pixel Representation	0028,0103	US		ALWAYS	FIXED	
Pixel Data	7FE0,0010	OW/OB		ANAP	AUTO	

Table 149: SC Image Module

Attribute Name	Tag	VR	Value	Presence of Value	Source	Comment
Date of Secondary Capture	0018,1012	DA		ALWAYS	AUTO	
Time of Secondary Capture	0018,1014	TM		ALWAYS	AUTO	
Pixel Spacing	0028,0030	DS		ANAP		
Pixel Spacing Calibration Type	0028,0A02	CS		ANAP		
Pixel Spacing Calibration Description	0028,0A04	LO		ANAP		

Table 150: VOI LUT Module

Attribute Name	Tag	VR	Value	Presence of Value	Source	Comment
Window Center	0028,1050	DS		ANAP	AUTO	
Window Width	0028,1051	DS		ANAP	AUTO	

Table 151: SOP Common Module

Attribute Name	Tag	VR	Value	Presence of Value	Source	Comment
Specific Character Set	0008,0005	CS		ANAP	AUTO	
Instance Creation Date	0008,0012	DA		ANAP	AUTO	
Instance Creation Time	0008,0013	TM		ANAP	AUTO	
SOP Class UID	0008,0016	UI	1.2.840.10008.5.1.4.1.1.7	ALWAYS	FIXED	
SOP Instance UID	0008,0018	UI		ALWAYS	AUTO	
Instance Number	0020,0013	IS		ANAP	AUTO	

8.1.1.6. X-Ray Radiation Dose SR SOP Class

Table 152: IOD of Created SR SOP Class

Information Entity	Module	Presence
Patient	Patient Module	Always
Study	General Study Module	Always
Study	Patient Study Module	User Option
Series	SR Document Series Module	Always
Equipment	General Equipment Module	Always
	Enhanced General Equipment Module	Always
Image	SR Document General Module	Always
	SR Document Content Module	Always
	SOP Common Module	Always

Table 153: Patient Module

Attribute Name	Tag	VR	Value	Presence of Value	Source	Comment
Patient's Name	0010,0010	PN		VNAP	MWL/USER	
Patient ID	0010,0020	LO		VNAP	MWL/AUTO	
Issuer of Patient ID	0010,0021	LO		ANAP	MWL/USER	
Patient's Birth Date	0010,0030	DA		VNAP	MWL/USER	
Patient's Sex	0010,0040	CS		VNAP	MWL/USER	
Other Patient IDs	0010,1000	LO		ANAP	MWL/USER	
Patient Comments	0010,4000	LT		ANAP	AUTO	
Ethnic Group	0010,2160	SH		ANAP	MWL/USER	

Table 154: General Study Module

Attribute Name	Tag	VR	Value	Presence of Value	Source	Comment
Study Date	0008,0020	DA		VNAP	AUTO	
Study Time	0008,0030	TM		VNAP	AUTO	
Accession Number	0008,0050	SH		VNAP	MWL, USER	
Referring Physician's Name	0008,0090	PN		VNAP	MWL, USER	
Study Description	0008,1030	LO		ANAP	MWL, USER	
Procedure Code Sequence	0008,1032	SQ		ANAP	MWL, USER	
>Code Value	0008,0100	SH		ANAP	MWL, USER	
>Coding Scheme Designator	0008,0102	SH		ANAP	MWL, USER	
>Coding Scheme Version	0008,0103	SH		ANAP	MWL, USER	
>Code Meaning	0008,0104	LO		ANAP	MWL, USER	
Study Instance UID	0020,000D	UI		ALWAYS	AUTO	
Study ID	0020,0010	SH		VNAP	MWL	

Requesting Service	0032,1033	LO		ANAP	MWL, USER	
--------------------	-----------	----	--	------	--------------	--

Table 155: Patient Study Module

Attribute Name	Tag	VR	Value	Presence of Value	Source	Comment
Patient's Age	0010,1010	AS		ANAP	MWL, USER	
Patient's Size	0010,1020	DS		ANAP	MWL, USER	
Patient's Weight	0010,1030	DS		ANAP	MWL, USER	
Additional Patient History	0010,21B0	LT		ANAP	MWL, USER	
Medical Alerts	0010,2000	LO		ANAP	MWL, USER	
Allergies	0010,2110	LO		ANAP	MWL, USER	
Occupation	0010,2180	SH		ANAP	MWL, USER	
Pregnancy Status	0010,21C0)	US		ANAP	MWL, USER	
Patient State	0038,0500	LO		ANAP	MWL, USER	

Table 156:SR Document Series Module

Attribute Name	Tag	VR	Value	Presence of Value	Source	Comment
Referenced Performed Procedure Step Sequence	0008,1111	SQ		VNAP		
> Referenced SOP Class UID	0008,1150	UI		ALWAYS		
> Referenced SOP Instance UID	0008,1155	UI		ALWAYS		
Series Instance UID	0020,000E	UI		ALWAYS		
Series Number	0020,0011	IS		ALWAYS		
Series Date	0008,0021	DA		ANAP		
Series Time	0008,0031	TM		ANAP		
Modality	0008,0060	CS		ALWAYS		
Series Description	0008,103E	LO		ANAP		

Table 157: General Equipment Module

Attribute Name	Tag	VR	Value	Presence of Value	Source	Comment
Manufacturer	0008,0070	LO	Philips	VNAP		
Institution Name	0008,0080	LO		ANAP		
Station Name	0008,1010	SH		ANAP		
Manufacturer's Model Name	0008,1090	LO	CombiDiagnost R90	ANAP		
Device Serial Number	0018,1000	LO		ANAP		
Software Versions	0018,1020	LO	1.1.0	ANAP		

Table 158: Enhanced General Equipment Module

Attribute Name	Tag	VR	Value	Presence of Value	Source	Comment
Manufacturer	0008,0070	LO	Philips	VNAP		
Manufacturer's Model Name	0008,1090	LO		ANAP		
Device Serial Number	0018,1000	LO		ANAP		
Software Versions	0018,1020	LO	1.1.0	ANAP		

Table 159: SR Document General Module

Attribute Name	Tag	VR	Value	Presence of Value	Source	Comment
Performed Procedure Code Sequence	0040,A372	SQ		VNAP		
Content Date	0008,0023	DA		ALWAYS		
Content Time	0008,0033	TM		ALWAYS		
Instance Number	0020,0013	IS		ALWAYS		
Referenced Request Sequence	0040,A370	SQ		ANAP		
>Accession Number	0008,0050	SH		VNAP		
>Referenced Study Sequence	0008,1110	SQ		VNAP		
>Study Instance UID	0020,000D	UI		ALWAYS		
>Requested Procedure Description	0032,1060	LO		VNAP		
>Requested Procedure Code Sequence	0032,1064	SQ		VNAP		
>>Code value	0008,0100	SH		ANAP	MWL, USER	
>>Coding Scheme Designator	0008,0102	SH		ANAP	MWL, USER	
>>Coding Scheme Version	0008,0103	SH		ANAP	MWL, USER	
>>Code Meaning	0008,0104	LO		ANAP	MWL, USER	
>Requested Procedure ID	0040,1001	SH		VNAP		
>Placer Order Number/Imaging Service Request	0040,2016	LO		VNAP		
>Filler Order Number/Imaging Service Request	0040,2017	LO		VNAP		
Completion Flag	0040,A491	CS		ALWAYS		
Completion Flag Description	0040,A492	LO		ANAP		
Verification Flag	0040,A493	CS		ALWAYS		

Table 160: SR Document Content Module

Attribute Name	Tag	VR	Value	Presence of Value	Source	Comment
Value Type	0040,A040	CS		VNAP	AUTO	
Concept Name Code Sequence	0040,A043	SQ		ANAP	AUTO	
> Code Value	0008,0100	SH		ANAP	AUTO	
> Coding Scheme Designator	0008,0016	SH		ANAP	AUTO	
> Code Meaning	0008,0104	LO		ANAP	AUTO	
Continuity Of Content	0040,A050	CS		VNAP	AUTO	
Content Template Sequence	0040,A504	SQ		VANP	AUTO	
> Mapping Resource	0008,0105	CS		ANAP	AUTO	
> Template Identifier	0040,DB00	CS		ANAP	AUTO	

> Content Sequence	0040,A730	SQ		ANAP	AUTO	
> Relationship Type	0040,A010	CS		ANAP	AUTO	

Table 161: SOP Common Module

Attribute Name	Tag	VR	Value	Presence of Value	Source	Comment
Specific Character Set	0008,0005	CS	ISO_IR 100	ANAP	COPY	
Instance Creation Date	0008,0012	DA		ANAP	AUTO	
Instance Creation Time	0008,0013	TM		ANAP	AUTO	
SOP Class UID	0008,0016	UI	1.2.840.10008.5.1.4.1.1.88.67	ALWAYS	FIXED	
SOP Instance UID	0008,0018	UI		ALWAYS	AUTO	
Instance Number	0020,0013	IS		ANAP	AUTO	

Table 161: Extended DICOM and private attributes for Secondary Capture Image Storage SOP Class Instances

Attribute Name	Tag	VR	Value	Presence of Value	Source	Comment
Medical Alerts	0010,2000	LO		ANAP	COPY	
Allergies	0010,2110	LO		ANAP	COPY	
Pregnancy Status	0010,21C0	US		ANAP	COPY	
KVP	0018,0060	DS		ANAP		
Distance Source to Detector	0018,1110	DS		ANAP		
Distance Source to Patient	0018,1111	DS		ANAP		
Exposure Time	0018,1150	IS		ANAP		
Exposure	0018,1152	IS		ANAP		
Exposure In B5As	0018,1153	IS		ANAP		
Imager Pixel Spacing	0018,1164	DS		ANAP		
Grid	0018,1166	DS		ANAP		
Acquisition Device Processing Description	0018,1400	LO		ANAP		
Relative X-ray Exposure				ANAP		
View Position	0018,5101	CS		ANAP	COPY	
Filter Material						
Requesting Physician	0032,1032	PN		ANAP	AUTO	
Requesting Service	0032,1033	LO		ANAP	COPY	
Requested Procedure Description	0032,1060	LO		ANAP	COPY	
Special Needs	0038,0050	LO		ANAP	COPY	
Patient State	0038,0500	LO		ANAP	COPY	
Performed Station AE Title	0040,0241	AE		ANAP	COPY	
Performed Procedure Step Status	0040,0252	CS		ANAP	COPY	
Total Number Of Exposures	0040,0301	US		ANAP	COPY	
Billing Procedure Step Sequence	0040,0320	SQ		ANAP	COPY	
Film Consumption Sequence	0040,0321	SQ		ANAP	COPY	
Requested Procedure ID	0040,1001	SH		ANAP	COPY	
Reason for The Requested Procedure	0040,1002	LO		ANAP	COPY	
Requested Procedure Priority	0040,1003	SH		ANAP	COPY	
Patient Transport Arrangements	0040,1004	LO		ANAP	COPY	
Names Of Intended Recipients Of Results	0040,1010	PN		ANAP	COPY	
Requested Procedure Comments	0040,1400	LT		ANAP	COPY	

Issue Date Of Imaging Service Request	0040,2004	DA		ANAP	COPY	
Imaging Service Request Comments	0040,2400	LT		ANAP	COPY	
Frame Time Vector	0018,1065					only if source image was a XRF image (exported as SC)
Recommended Display Frame Rate	0008,2144					only if source image was a XRF image (exported as SC)
Cine Rate	0018,0040					only if source image was a XRF image (exported as SC)

CombiDiagnost R90 Rel 1.1 can optionally create and stores, upon completion of the study, a DICOM X-Ray Radiation DOSE SR object.

8.1.1.7. X-RAY RADIATION DOSE SR IOD TEMPLATES

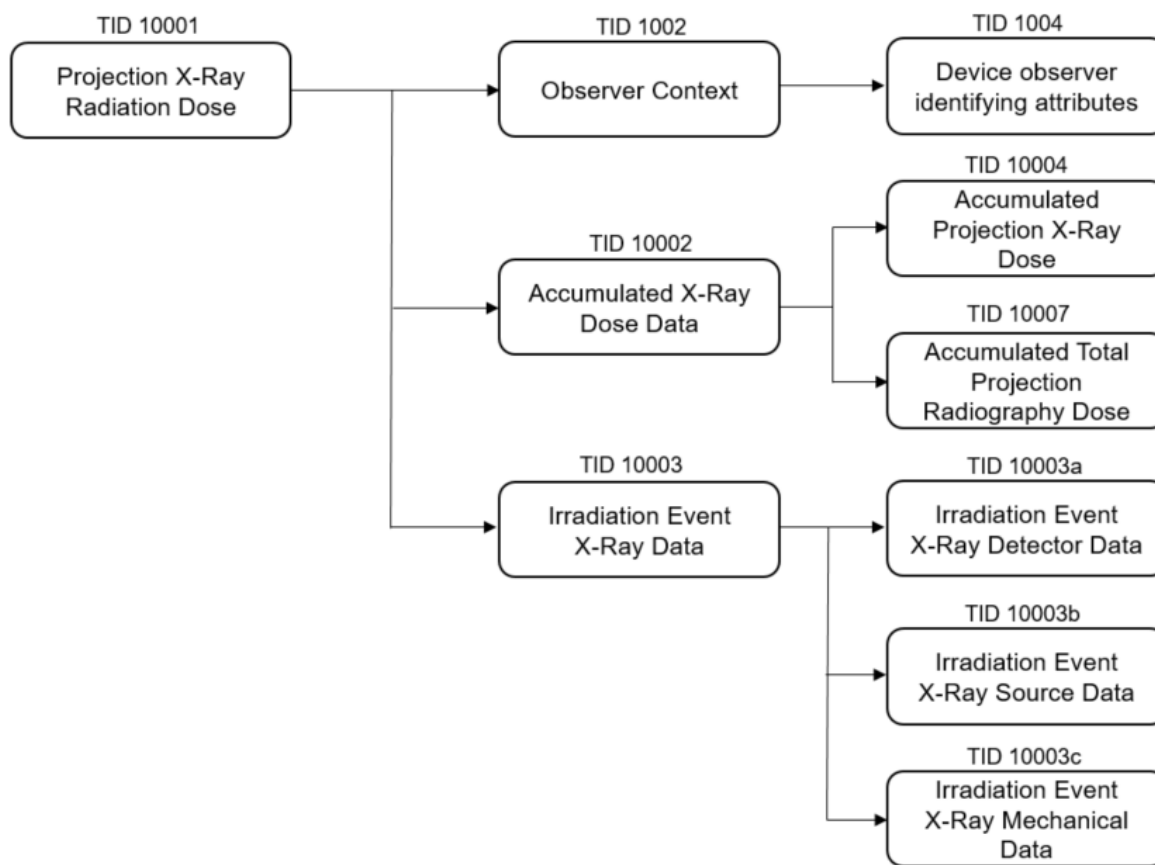

Figure 18: X-Ray Radiation Dose SR IOD Template Structure

This section describes the content of all the templates used in the X-Ray Radiation Dose Reporting SR.

Table 162: Used Templates for X-Ray Radiation Dose Reporting

Template Name	Template ID
Projection X-Ray Radiation Dose	TID 10001
Accumulated X-Ray Dose	TID 10002
Irradiation Event X-Ray Data	TID 10003
Irradiation Event X-Ray Detector Data	TID 10003a
Irradiation Event X-Ray Source Data(for Fluoroscopy irradiation event type)	TID 10003b
Irradiation Event X-Ray Source Data(for Stationary Acquisition irradiation event type)	TID 10003b
Irradiation Event X-Ray Mechanical Data	TID 10003c
Accumulated Projection X-Ray Dose Data(for Fluoroscopy irradiation event type)	TID 10004
Accumulated Projection X-Ray Dose Data(for Stationary Acquisition irradiation event type)	TID 10004
Observer Context	TID 1002
Device Observer Identifying Attributes	TID 1004
Accumulated Total Projection Radiography Dose	TID 10007

8.1.1.7.1. TID 10001 Projection X-Ray Radiation Dose

Table 163: Projection X-Ray Radiation Dose

NL	Relation with Parent	Concept Name	VT	VM	Presence of Value	Value
		EV (113701, DCM, "X-Ray Radiation Dose Report")		1	ALWAYS	
>	HAS CONCEPT MOD	EV (121058, DCM, "Procedure reported")	CODE	1	ALWAYS	DT (113704, DCM, "Projection X-Ray")
>>	HAS CONCEPT MOD	EV (363703001, SCT, "Has Intent")	CODE	1	ALWAYS	Diagnostic Intent
>		DTID 1002 "Observer Context"	INCLUDE	1	ALWAYS	
>	HAS OBS CONTEXT	EV (113705, DCM, "Scope of Accumulation")	CODE	1	ALWAYS	113016, DCM, "Performed Procedure Step"
>>	HAS PROPERTIES	DCID 10001 "UID Types"	UIDREF	1	ALWAYS	Performed Procedure Step SOP Instance UID
>	CONTAINS	EV (113945, DCM, "X-Ray Detector Data Available")	CODE	1	ALWAYS	Yes
>	CONTAINS	EV (113943, DCM, "X-Ray Source Data Available")	CODE	1	ALWAYS	Yes
>	CONTAINS	EV (113944, DCM, "X-Ray Mechanical Data Available")	CODE	1	ALWAYS	Yes
>	CONTAINS	DTID 10002 "Accumulated X-Ray Dose"	INCLUDE	1	ALWAYS	
>	CONTAINS	DTID 10003 "Irradiation Event X-Ray Data"	INCLUDE	1-n	ALWAYS	
>	CONTAINS	EV (121106, DCM, "Comment")	TEXT	1	CONDITIONAL	X-Ray Radiation Dose Structured Report related to the Performed Procedure Step

>	CONTAINS	EV (113854, DCM, "Source of Dose Information")	CODE	1	ALWAYS	Automated Data Collection
---	----------	--	------	---	--------	---------------------------

8.1.1.7.2. TID 10002 Accumulated X-Ray Dose

Table 164: Accumulated X-Ray Dose

NL	Relation with Parent	Concept Name	VT	VM	Presence of Value	Value
>	CONTAINS, CONTINUOUS	EV (113702, DCM, "Accumulated X-Ray Dose Data")	CONTAINER	1	ALWAYS	
>>	HAS CONCEPT MOD	EV (113764, DCM, "Acquisition Plane")	CODE	1	ALWAYS	Single Plane
>>	CONTAINS	DTID (10004) "Accumulated Projection X-Ray Dose"	INCLUDE	1	ALWAYS	
>	CONTAINS	DTID (10007) "Accumulated Total Projection Radiography Dose"	INCLUDE	1	CONDITIONAL	IFF TID (10001) Row 2 = (113704, DCM, "Projection X-Ray") and TID (10001) Row 4 is absent)

8.1.1.7.3. TID 10003 Irradiation Event X-Ray Data

Table 165: Irradiation Event X-Ray Data

NL	Relation with Parent	Concept Name	VT	VM	Presence of Value	Value
>	CONTAINS, CONTINUOUS	EV (113706, DCM, "Irradiation Event X-Ray Data")	CONTAINER	1	ALWAYS	
>>	HAS CONCEPT MOD	EV (113764, DCM, "Acquisition Plane")	CODE	1	ALWAYS	Single Plane
>>	CONTAINS	EV (113769, DCM, "Irradiation Event UID")	UIDREF	1	ALWAYS	
>>	CONTAINS	DT (111526, DCM, "DateTime Started")	DATETIME	1	ALWAYS	
>>	CONTAINS	EV (113721, DCM, "Irradiation Event Type")	CODE	1	ALWAYS	Stationary Acquisition or Fluoroscopy
>>	CONTAINS	EV (125203, DCM, "Acquisition Protocol")	TEXT	1	CONDITIONAL	
>>	CONTAINS	EV (123014, DCM, "Target Region")	CODE	1	ALWAYS	Value from CID 4031 Common Anatomic Regions
>>	CONTAINS	EV (122130, DCM, "Dose Area Product")	NUM	1	ALWAYS	Units = Gy.m2
>>	CONTAINS	EV (113780, DCM, "Reference Point Definition")	CODE	1	ALWAYS	30cm above Tabletop and 30cm in Front of Image Input Surface
>	CONTAINS	DTID 10003A "Irradiation Event X-Ray Detector Data"	INCLUDE	1	CONDITIONAL	IFF TID (10001) Row 8 is absent or has a value of (R-0038D, SRT, "Yes")
>	CONTAINS	DTID 10003B "Irradiation Event X-Ray Source Data"	INCLUDE	1	CONDITIONAL	IFF TID (10001) Row 9 is absent or has a value of (R-0038D, SRT, "Yes")

>	CONTAINS	DTID 10003C "Irradiation Event X-Ray Mechanical Data"	INCLUDE	1	CONDITIONAL	IFF TID (10001) Row 10 is absent or has a value of (R-0038D, SRT, "Yes")
---	----------	---	---------	---	-------------	--

8.1.1.7.1. TID 10003a Irradiation Event X-Ray Detector Data

Table 166: Irradiation Event X-Ray Detector Data

NL	Relation with Parent	Concept Name	VT	VM	Presence of Value	Value
>>	CONTAINS	DTID 1021 "Device Participant"	INCLUDE	1	USER DEFINED	113942, DCM, "X-Ray Reading Device"
>>	CONTAINS	EV (113795, DCM, "Acquired Image")	IMAGE	1-n	CONDITIONAL	

8.1.1.7.2. TID 10003b Irradiation Event X-Ray Source Data (for Fluoroscopy Irradiation Event type)

Table 167: Irradiation Event X-Ray Source Data

NL	Relation with Parent	Concept Name	VT	VM	Presence of Value	Value
>>	CONTAINS	EV (113738, DCM, "Dose (RP)")	NUM	1	CONDITIONAL	Units=Gy
>>	CONTAINS	EV (113780, DCM, "Reference Point Definition")	CODE	1	CONDITIONAL	113863, DCM, "30cm above Tabletop"
>>		Fluoro Mode	CODE	1	CONDITIONAL	IFF TID (10003) Row 7 value = (P5-06000, SRT, "Fluoroscopy")
>>	CONTAINS	EV (113768, DCM, "Number of Pulses")	NUM	1	CONDITIONAL	
>>	CONTAINS	EV (113793, DCM, "Pulse Width")	NUM	1	USER DEFINED	Units=ms
>>	CONTAINS	EV (113742, DCM, "Irradiation Duration")	NUM	1	USER DEFINED	Units=s
>>	CONTAINS	EV (113733, DCM, "KVP")	NUM	1-n	ALWAYS	Units=kV
>>	CONTAINS	EV (113734, DCM, "X-Ray Tube Current")	NUM	1	ALWAYS	Units=mA
>>	CONTAINS	EV (113736, DCM, "Exposure")	NUM	1-n	CONDITIONAL	Units= uAs
>>	CONTAINS	EV (111632, DCM, "Anode Target Material")	CODE	1	USER DEFINED	Tungsten or Tungsten compound

8.1.1.7.3. TID 10003b Irradiation Event X-Ray Source Data (for Stationary Acquisition Irradiation Event type)

Table 168: Irradiation Event X-Ray Source Data

NL	Relation with Parent	Concept Name	VT	VM	Presence of Value	Value
>>	CONTAINS	EV (113738, DCM, "Dose (RP)")	NUM	1	CONDITIONAL	Units=Gy
>>	CONTAINS	EV (113780, DCM, "Reference Point Definition")	CODE	1	CONDITIONAL	113863, DCM, "30cm above Tabletop"
>>	CONTAINS	EV (113768, DCM, "Number of Pulses")	NUM	1	CONDITIONAL	

>>	CONTAINS	EV (113793, DCM, "Pulse Width")	NUM	1	USER DEFINED	Units=ms
>>	CONTAINS	EV (113742, DCM, "Irradiation Duration")	NUM	1	USER DEFINED	Units=s
>>	CONTAINS	EV (113733, DCM, "KVP")	NUM	1-n	ALWAYS	Units=kV
>>	CONTAINS	EV (113734, DCM, "X-Ray Tube Current")	NUM	1	ALWAYS	Units=mA
>>	CONTAINS	EV (113736, DCM, "Exposure")	NUM	1-n	CONDITIONAL	Units= uAs
>>	CONTAINS	EV (111632, DCM, "Anode Target Material")	CODE	1	USER DEFINED	Tungsten or Tungsten compound

8.1.1.7.4. TID 10003c Irradiation Event X-Ray Mechanical Data

Table 169: Irradiation Event X-Ray Source Data

NL	Relation with Parent	Concept Name	VT	VM	Presence of Value	Value
>>		EV (113754, DCM, "Table Head Tilt Angle")	NUM	1	USER DEFINED	deg, UCUM, "deg
>>		Dose Related Distance Measurements	NUM	1-n	USER DEFINED	Units=mm 113750, DCM, Distance Source to Detector 113737, DCM, Distance Source to Reference Point

8.1.1.7.5. TID 10004 Accumulated Projection X-Ray Dose (for Fluoroscopy Irradiation Event type)

Table 170: Accumulated Projection X-Ray Dose

NL	Relation with Parent	Concept Name	VT	VM	Presence of Value	Value
>>	CONTAINS	EV (113726, DCM, "Fluoro Dose Area Product Total")	NUM	1	ALWAYS	Units = Gy.m2
>>	CONTAINS	EV (113728, DCM, "Fluoro Dose (RP) Total")	NUM	1	ALWAYS	Units = Gy
>>	CONTAINS	EV (113730, DCM, "Total Fluoro Time")	NUM	1	ALWAYS	Units = s
>>	CONTAINS	EV (113727, DCM, "Acquisition Dose Area Product Total")	NUM	1	ALWAYS	Units = Gy.m2
>>	CONTAINS	EV (113729, DCM, "Acquisition Dose (RP) Total")	NUM	1	ALWAYS	Units = Gy
>>	CONTAINS	EV (113855, DCM, "Total Acquisition Time")	NUM	1	ALWAYS	Units = seconds

8.1.1.7.6. TID 10004 Accumulated Projection X-Ray Dose (for Stationary Acquisition Irradiation Event type)

Table 17174: Accumulated Projection X-Ray Dose

NL	Relation with Parent	Concept Name	VT	VM	Presence of Value	Value
>>	CONTAINS	EV (113727, DCM, "Acquisition Dose Area Product Total")	NUM	1	ALWAYS	Units = Gy.m2
>>	CONTAINS	EV (113729, DCM, "Acquisition Dose (RP) Total")	NUM	1	CONDITIONAL	Units = Gy
>>	CONTAINS	EV (113855, DCM, "Total Acquisition Time")	NUM	1	ALWAYS	Units = seconds

8.1.1.7.7. TID 1002 Observer Context

Table 172: Observer Context

NL	Relation with Parent	Concept Name	VT	VM	Presence of Value	Value
>	HAS OBS CONTEXT	EV (121005, DCM, "Observer Type")	CODE	1	CONDITIONAL	Device
	HAS OBS CONTEXT	DTID (1004) "Device observer identifying attributes"	INCLUDE	1	CONDITIONAL	

8.1.1.7.8. TID 1004 Device Observer Identifying Attributes

Table 173: Device Observer Identifying Attributes

NL	Relation with Parent	Concept Name	VT	VM	Presence of Value	Value
>	HAS OBS CONTEXT	EV (121012, DCM, "Device Observer UID")	UIDREF	1	ALWAYS	
>	HAS OBS CONTEXT	EV (121013, DCM, "Device Observer Name")	TEXT	1	ALWAYS	Station Name (0008,1010)
>	HAS OBS CONTEXT	EV (121014, DCM, "Device Observer Manufacturer")	TEXT	1	ALWAYS	Manufacturer (0008,0070): Philips
>	HAS OBS CONTEXT	EV (121015, DCM, "Device Observer Model Name")	TEXT	1	ALWAYS	Manufacturer's Model Name (0008,1090): CombiDiagnost R90
>	HAS OBS CONTEXT	EV (121016, DCM, "Device Observer Serial Number")	TEXT	1	ALWAYS	Device Serial Number (0018,1000)
>	HAS OBS CONTEXT	Scope of Accumulation	CODE	1	ALWAYS	
>>	HAS PROPERTIES	Performed Procedure Step SOP Instance UID	UIDREF	1	ALWAYS	

8.1.1.7.9. TID 10007. Accumulated Total Projection Radiography Dose

Table 174: Accumulated Total Projection Radiography Dose

NL	Relation with Parent	Concept Name	VT	VM	Presence of Value	Value
	CONTAINS	EV (113722, DCM, "Dose Area Product Total")	NUM	1	ALWAYS	1.011E-5 Units: (Gy.m2, UCUM, Gy.m2)

	CONTAINS	EV (113725, DCM, "Dose (RP Total)")	NUM	1	CONDITIONAL	1.23E-4 Units: (Gy, UCUM, Gy)
	CONTAINS	EV (113731, DCM, "Total Number of Radiographic Frames")	NUM	1		
	CONTAINS	EV (113780, DCM, "Reference Point Definition")	NUM	1	CONDITIONAL	

Note: TID 10003a and 10003c will always be empty whenever a fluoroscopy irradiation event is involved.

8.1.2. Usage of Attributes from Received IODs

The CombiDiagnost R90 Rel 1.1 has only an export side. The modality cannot read/view images from a CD.

8.1.3. Attribute Mapping

Table 175: Attribute Mapping during Modality Workflow

Name	BWL M Tag	MPPS		Image IOD Tag
		Create Tag	Set Tag	
Accession Number	0008,0050	0008,0050	-	0008,0050
Modality	-	0008,0060	-	0008,0060
Referring Physician's Name	0008,0090	-	-	0008,0090
Operators' Name	-	-	0008,1070	0008,1070
Referenced Study Sequence	0008,1110	0008,1110	-	0008,1110
Referenced Image Sequence	-	-	(0008,1140)	-
> Referenced SOP Class UID	-	-	0008,1150	0008,0016
SOP Class UID	-	-		
> Referenced SOP Instance UID	-	-	0008,1155	0008,0018
SOP Instance UID	-	-		
Patient's Name	0010,0010	0010,0010	-	0010,0010
Patient ID	0010,0020	0010,0020	-	0010,0020
Issuer of Patient ID	0010,0021	0010,0021	-	0010,0021
Patient's Birth Date	0010,0030	0010,0030	-	0010,0030
Patient's Sex	0010,0040	0010,0040	-	0010,0040
Other Patient IDs	0010,1000	0010,1000	-	0010,1000
Medical Alerts	0010,2000	-	-	0010,2000
Allergies	0010,2110	-	-	0010,2110
Ethnic group	0010,2160	-	-	0010,2160
Additional Patient History	0010,21B0	-	-	0010,21B0
Pregnancy Status	0010,21C0	-	-	0010,21C0
Patient Comments	0010,4000	-	-	0010,4000
Protocol Name	-	-	0018,1030	0018,1030
Study Instance UID	0020,000D	0020,000D	-	0020,000D
Series Instance UID			0020,000E	0020,000E
Study ID	-	0020,0010	-	0020,0010
Requesting Service	0032,1033	-	-	0032,1033
Requested Procedure Description	0032,1060	0032,1060	-	-
Requested Procedure Code Sequence3	0032,1064	0008,1032	0008,1032	0008,1032
Performed Procedure Code Sequence				
Special Needs	0038,0050	-	-	0038,0050
Patient State	0038,0500	-	-	0038,0500
Scheduled Procedure Step Description4	0040,0007	0040,0007	-	0040,0007



Name	BWL Tag	MPPS		Image IOD Tag
		Create Tag	Set Tag	
Performed Procedure Step Description		0040,0254	-	0040,0254
Scheduled Protocol Code Sequence4	0040,0008	0040,0260	0040,0260	0040,0008
Performed Protocol Code Sequence				0040,0260
Scheduled Procedure Step ID	0040,0009	0040,0009	-	0040,0009
Performed Procedure Step Start Date	-	0040,0244	-	0040,0244
Performed Procedure Step Start Time	-	0040,0245	-	0040,0245
Performed Procedure Step ID	-	0040,0253	-	0040,0253
Requested Procedure ID	0040,1001	0040,1001	-	0040,1001

9. Version History

Create, Review and Approval

Role	Function	Name	Signature/ Date
Author	IO Service Engineer	Salim K Doddamani	Not required
Reviewer(s)	IO Service Engineer IO Architect Q&R Representative Customer Representative	Preethi V S Saurav Baidya Bert van Hoften Vinayachandra Aithala	Not required
Approver(s)	IO Architect	Saurav Baidya	See LiveLink
	Q&R Representative	Bert van Hoften	See LiveLink
	Customer Representative	Sebastian Wulfgramm	Signature and Date:  Sebastian approval.pdf

Revision History

Revision	Date	Status	Changed by:	Reason / description of change
Available in Livelink	23-October-2019	See LiveLink and header of printed docs	Salim Doddamani	Initial version for review
	23-December-2019			Processed review comments along with updates after issue clarification and is ready for re-review  TRR_DICOM_Conformance_Statement_C
	09-January-2020			Processed re-review comments and is Ready for Authorization  TRR_DICOM_Conformance_Statement_C