

---

# DICOM

## Conformance Statement

### ELEVA EDI Systems

MultiDiagnost R2.3.2

OmniDiagnost R2.3.2

UroDiagnost R2.3.2

EasyDiagnost R1.3.2



***Issued by:***

Koninklijke Philips Electronics N.V.  
Medical IT, Interoperability

Building QV  
P.O. Box 10.000  
5680 DA Best  
The Netherlands

email: <mailto:dicom@philips.com>  
Internet: <http://www.medical.philips.com/>

Document Number: XPS 080-050071  
Date: 3 November 2005

---

## 1 DICOM CONFORMANCE STATEMENT OVERVIEW

The ELEVA EDI (Ditto) System in a DICOM Network environment exists of 3 components a

- ELEVA Digital Imaging DI or Ditto an
- ELEVA Examination Control with Auto-Push function and a
- ViewForum R 4.1 System.

The ELEVA EDI (Ditto) System is an Digital Fluorography modality and is part of an X-Ray System.

Depending on the purchased options and chosen configuration, the ELEVA EDI (Ditto) System provides the following DICOM data exchange features:

- Request Worklist
- Issue Procedure information to RIS / HIS system
- Image acquisition and display
- Image review and processing
- Image handling, storage and networking,
- Administration of patient, physician and examination data.
- Read and Write DICOM CD-RW disks.
- Read and write DICOM DVD-RW disks.
- It allows the operator to print images stored in the database on a DICOM printer.
- Copy images from the local database to remote databases and vice versa.
- Import images for viewing.
- Storage Commitment function
- It allows a remote system to Query the ELEVA EDI System database and to Retrieve images from it.

The main application areas are:

- R/F examinations
- Vascular and non-vascular examinations
- Angiography and tomography examinations
- interventional procedures

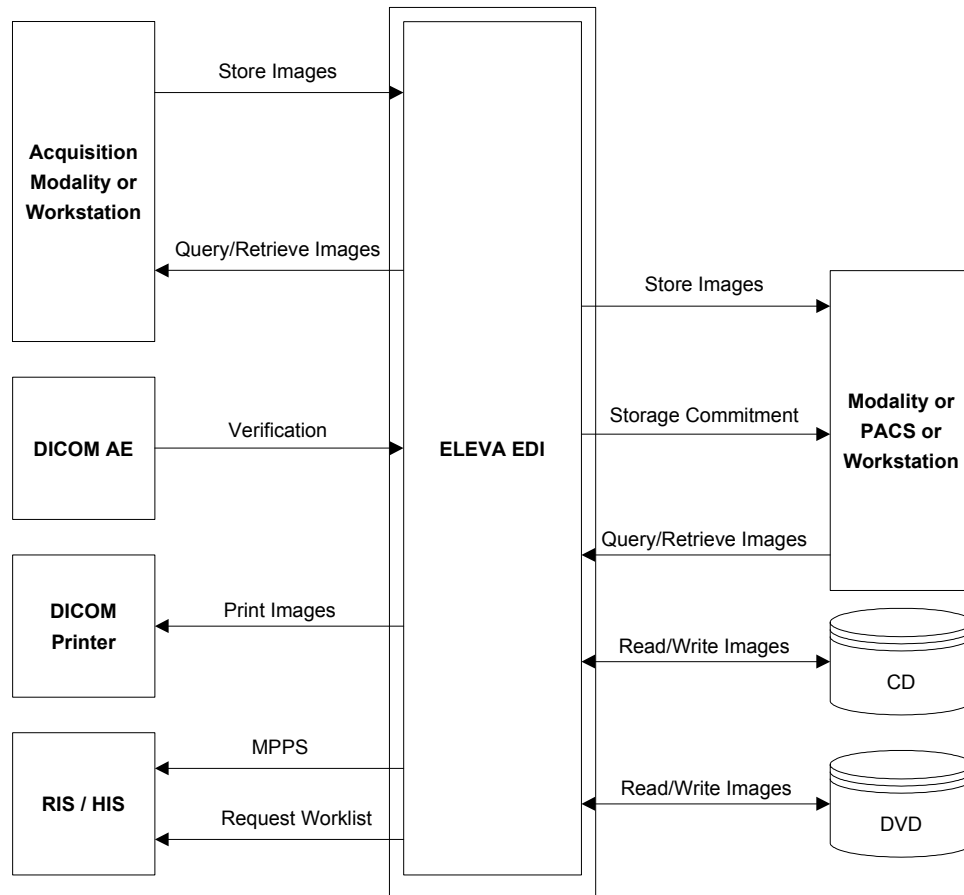

**Figure 1: ELEVA EDI (Ditto) System in a DICOM Network environment**

ELEVA EDI (Ditto) allows the operator also to view, analyze and process the images stored in the database. Some advanced analysis and processing applications are primarily designed for images generated by Philips equipment when sent to the ELEVA EDI (Ditto).

This DICOM Conformance Statement describes the DICOM conformance of the ELEVA EDI (Ditto) platform. Application package specific DICOM conformance is described in separate Conformance Statements.

Table 1 presents an overview of all network services and the applicable SOP classes as provided by ELEVA EDI (Ditto).

Table 1: Network Services

SOP Class		User of Service (SCU)	Provider of Service (SCP)
Name	UID		
<b>Storage</b>			
Computed Radiography Image Storage	1.2.840.10008.5.1.4.1.1.1	Yes	Yes
Digital X-Ray Image Storage – for Presentation	1.2.840.10008.5.1.4.1.1.1.1	Yes	Yes
CT Image Storage	1.2.840.10008.5.1.4.1.1.2	Yes	Yes
Ultrasound Multi-frame Image Storage	1.2.840.10008.5.1.4.1.1.3.1	Yes	Yes
MR Image Storage	1.2.840.10008.5.1.4.1.1.4	Yes	Yes
Ultrasound Image Storage	1.2.840.10008.5.1.4.1.1.6.1	Yes	Yes
Secondary Capture Image Storage	1.2.840.10008.5.1.4.1.1.7	Yes	Yes
Grayscale Softcopy Presentation State Storage	1.2.840.10008.5.1.4.1.1.11.1	Yes	Yes
X-Ray Angiographic Image Storage	1.2.840.10008.5.1.4.1.1.12.1	Yes	Yes
X-Ray Radiofluoroscopic Image Storage	1.2.840.10008.5.1.4.1.1.12.2	Yes	Yes
<b>Private Storage</b>			
Specialized X-Ray	1.3.46.670589.2.3.1.1	Yes	Yes
CX Image	1.3.46.670589.2.4.1.1	Yes	Yes
3D Volume Storage	1.3.46.670589.5.0.1.1	Yes	Yes
3D Volume Object Storage	1.3.46.670589.5.0.2.1	Yes	Yes
Surface Storage	1.3.46.670589.5.0.3.1	Yes	Yes
MR Cardio Storage	1.3.46.670589.5.0.8.1	Yes	Yes
CT Synthetic Image	1.3.46.670589.5.0.9	Yes	Yes
MR Synthetic Image	1.3.46.670589.5.0.10	Yes	Yes
MR Cardio Analysis Storage	1.3.46.670589.5.0.11.1	Yes	Yes
CX Synthetic Image	1.3.46.670589.5.0.12	Yes	Yes
Perfusion	1.3.46.670589.5.0.13	Yes	Yes
Perfusion Analysis	1.3.46.670589.5.0.14	Yes	Yes
<b>Query/Retrieve</b>			
Patient Root Query/Retrieve Information Model – FIND	1.2.840.10008.5.1.4.1.2.1.1	Yes	Yes
Patient Root Query/Retrieve Information Model – MOVE	1.2.840.10008.5.1.4.1.2.1.2	Yes	Yes
Study Root Query/Retrieve Information Model – FIND	1.2.840.10008.5.1.4.1.2.2.1	Yes	Yes
Study Root Query/Retrieve Information Model – MOVE	1.2.840.10008.5.1.4.1.2.2.2	Yes	Yes
Patient/Study Only Query/Retrieve Information Model – FIND	1.2.840.10008.5.1.4.1.2.3.1	Yes	Yes
Patient/Study Only Query/Retrieve Information Model – MOVE	1.2.840.10008.5.1.4.1.2.3.2	Yes	Yes
<b>Workflow Management</b>			
Storage Commitment Push Model	1.2.840.10008.1.20.1	Yes	No
Verification	1.2.840.10008.1.1	No	Yes
Modality Worklist Information Model - FIND	1.2.840.10008.5.1.4.31	Yes	No
Modality Performed Procedure Step	1.2.840.10008.3.1.2.3.3	Yes	No
<b>Print Management</b>			
Basic Grayscale Print Management (Meta)	1.2.840.10008.5.1.1.9	Yes	No
> Basic Film Session	1.2.840.10008.5.1.1.1	Yes	No
> Basic Film Box	1.2.840.10008.5.1.1.2	Yes	No
> Basic Grayscale Image Box	1.2.840.10008.5.1.1.4	Yes	No
> Printer	1.2.840.10008.5.1.1.16	Yes	No
Basic Color Print Management (Meta)	1.2.840.10008.5.1.1.18	Yes	No
> Basic Film Session	1.2.840.10008.5.1.1.1	Yes	No
> Basic Film Box	1.2.840.10008.5.1.1.2	Yes	No

SOP Class		User of Service (SCU)	Provider of Service (SCP)
Name	UID		
> Basic Color Image Box	1.2.840.10008.5.1.1.4.1	Yes	No
> Printer	1.2.840.10008.5.1.1.16	Yes	No
Presentation LUT	1.2.840.10008.5.1.1.23	Yes	No

The following table lists the Supported Media Storage Application Profiles (with roles).

**Table 2: Media Services**

Media Storage Application Profile	Write Files (FSC / FSU)	Read Files (FSR)	Supported Media
<b>CD – R Disk</b>			
General Purpose CD-R	YES / YES	YES	CD
<b>DVD Disk</b>			
General Purpose DVD-JPEG	YES / NO	YES	DVD+R / DVD+RW

*Note: Not supported are the Media DVD -R / -RW.*

## 2 TABLE OF CONTENTS

<b>1</b>	<b>DICOM CONFORMANCE STATEMENT OVERVIEW .....</b>	<b>3</b>
<b>2</b>	<b>TABLE OF CONTENTS .....</b>	<b>7</b>
<b>3</b>	<b>INTRODUCTION .....</b>	<b>10</b>
3.1	Revision History .....	10
3.2	Audience .....	10
3.3	Remarks .....	10
3.4	Definitions, Terms and Abbreviations .....	11
3.5	References .....	12
<b>4</b>	<b>NETWORKING .....</b>	<b>13</b>
4.1	IMPLEMENTATION MODEL .....	13
4.1.1	Application Data Flow .....	13
4.1.2	Functional Definition of AE's .....	16
4.1.2.1	Functional Definition of ELEVA EDI System .....	16
4.1.3	Sequencing of Real World Activities .....	17
4.2	AE SPECIFICATIONS .....	19
4.2.1	ELEVA EDI ViewForum Network AE .....	19
4.2.1.1	Supported SOP Classes by the ELEVA EDI ViewForum Network AE as SCP/SCU .....	19
4.2.1.2	Association Policies .....	21
4.2.1.2.1	General .....	21
4.2.1.2.2	Number of Associations .....	21
4.2.1.2.3	Asynchronous Nature .....	22
4.2.1.2.4	Implementation Identifying Information .....	22
4.2.1.3	Association Initiation Policy .....	22
4.2.1.3.1	Export Images .....	23
4.2.1.3.1.1	Description and Sequencing of Activities .....	23
4.2.1.3.1.2	Proposed Presentation Contexts .....	24
4.2.1.3.1.3	SOP Specific Conformance for SOP Classes .....	26
4.2.1.3.2	Find Remote Images .....	28
4.2.1.3.2.1	Description and Sequencing of Activities .....	28
4.2.1.3.2.2	Proposed Presentation Contexts .....	29
4.2.1.3.2.3	SOP Specific Conformance for SOP Classes .....	30
4.2.1.3.3	Move Remote Images .....	32
4.2.1.3.3.1	Description and Sequencing of Activities .....	32
4.2.1.3.3.2	Proposed Presentation Contexts .....	32
4.2.1.3.3.3	SOP Specific Conformance for SOP Classes .....	33
4.2.1.3.4	Request Storage Commitment .....	34
4.2.1.3.4.1	Description and Sequencing of Activities .....	34
4.2.1.3.4.2	Proposed Presentation Contexts .....	35
4.2.1.3.4.3	SOP Specific Conformance for SOP Class .....	36
4.2.1.3.5	Print Images .....	37
4.2.1.3.5.1	Description and Sequencing of Activities .....	37
4.2.1.3.5.2	Proposed Presentation Contexts .....	38
4.2.1.3.5.3	SOP Specific Conformance Printer SOP Class .....	39
4.2.1.3.5.4	SOP Specific Conformance Basic Film Session SOP Class .....	39
4.2.1.3.5.5	SOP Specific Conformance Basic Film Box SOP Class .....	40
4.2.1.3.5.6	SOP Specific Conformance Basic Grayscale Image Box SOP Class .....	41
4.2.1.3.5.7	SOP Specific Conformance Basic Color Image Box SOP Class .....	42
4.2.1.3.5.8	SOP Specific Conformance Presentation LUT SOP Class .....	43
4.2.1.3.6	Request Printer Status .....	44
4.2.1.3.6.1	Description and Sequencing of Activities .....	44
4.2.1.3.6.2	Proposed Presentation Contexts .....	45
4.2.1.3.6.3	SOP Specific Conformance for the Printer SOP Class .....	45
4.2.1.4	Association Acceptance Policy .....	46

4.2.1.4.1	Request Verification.....	46
4.2.1.4.1.1	Description and Sequencing of Activities .....	46
4.2.1.4.1.2	Accepted Presentation Contexts .....	47
4.2.1.4.1.3	SOP Specific Conformance for C-ECHO SOP Class.....	48
4.2.1.4.2	Import Images .....	48
4.2.1.4.2.1	Description and Sequencing of Activities .....	48
4.2.1.4.2.2	Accepted Presentation Contexts .....	49
4.2.1.4.2.3	SOP Specific Conformance for SOP Classes .....	50
4.2.1.4.3	Query Local Images.....	53
4.2.1.4.3.1	Description and Sequencing of Activities .....	53
4.2.1.4.3.2	Accepted Presentation Contexts .....	54
4.2.1.4.3.3	SOP Specific Conformance for SOP Classes .....	54
4.2.1.4.4	Retrieve Local Images .....	56
4.2.1.4.4.1	Description and Sequencing of Activities .....	56
4.2.1.4.4.2	Accepted Presentation Contexts .....	56
4.2.1.4.4.3	SOP Specific Conformance for SOP Classes .....	57
4.2.2	ELEVA EXAMINATION CONTROL AE .....	58
4.2.2.1	Supported SOP Classes by the ELEVA EDI AE as SCU.....	58
4.2.2.2	Association Policies .....	58
4.2.2.2.1	General .....	58
4.2.2.2.2	Number of Associations.....	58
4.2.2.2.3	Asynchronous Nature .....	58
4.2.2.2.4	Implementation Identifying Information.....	59
4.2.2.2.5	Association Acceptance Policy.....	59
4.2.2.2.6	Association Initiation Policy .....	59
4.2.2.3	Real – World Activity – Management Worklist (MWL) – FIND .....	59
4.2.2.3.1	Association Real – World Activity .....	59
4.2.2.3.2	Description and Sequencing of Activities .....	59
4.2.2.3.3	SOP Specific Conformance – MWL-FIND.....	60
4.2.2.3.3.1	Patient and Study Merge .....	61
4.2.2.3.3.2	Scheduled Procedure Step (= Examination) Merge.....	62
4.2.2.4	Modality Worklist Information Model – FIND SOP Class.....	62
4.2.2.4.1.1	Proposed Presentation Contexts .....	65
4.2.2.5	Real-World Activity –Modality Performed Procedure Step (MPPS).....	65
4.2.2.5.1	Association Real – World Activity .....	65
4.2.2.5.1.1	Sequencing of Performed Procedure Steps.....	67
4.2.2.5.1.2	Interleave of Performed Procedure Steps .....	67
4.2.2.5.2	Presentation Context Table .....	67
4.2.2.5.3	SOP Specific Conformance .....	68
4.3	NETWORK INTERFACES .....	73
4.3.1	Physical Network Interface .....	73
4.4	CONFIGURATION .....	73
4.4.1	AE Title/Presentation Address Mapping .....	73
4.4.1.1	Local AE Titles .....	73
4.4.1.2	Remote AE Title/Presentation Address Mapping .....	74
4.4.1.2.1	Remote Association Initiators .....	74
4.4.1.2.2	Remote Association Acceptors.....	74
4.4.2	Parameters.....	74
<b>5</b>	<b>MEDIA INTERCHANGE.....</b>	<b>77</b>
5.1	Implementation Model.....	77
5.1.1	Application Data Flow .....	77
5.1.2	Functional Definitions of AE's .....	79
5.1.2.1	Functional Definition of ELEVA EDI ViewForum .....	79
5.1.3	Sequencing of Real World Activities .....	79
5.1.4	File Meta Information for Implementation Class and Version.....	80
5.2	AE Specifications .....	80



---

5.2.1	ELEVA EDI ViewForum .....	80
5.2.1.1	File Meta Information for the .....	81
5.2.1.2	Real-World Activities .....	81
5.2.1.2.1	Display Directory .....	81
5.2.1.2.1.1	Media Storage Application Profile .....	81
5.2.1.2.1.1.1	Options .....	81
5.2.1.2.2	Write Images .....	82
5.2.1.2.2.1	Media Storage Application Profile .....	82
5.2.1.2.2.1.1	Options .....	82
5.2.1.2.3	Read Images .....	82
5.2.1.2.3.1	Media Storage Application Profile .....	83
5.2.1.2.3.1.1	Options .....	83
5.3	Augmented and Private Application Profiles .....	83
5.3.1	Augmented Application Profiles .....	83
5.3.2	Private Application Profiles .....	83
5.4	Media Configuration .....	83
<b>6</b>	<b>SUPPORT OF CHARACTER SETS .....</b>	<b>84</b>
<b>7</b>	<b>SECURITY .....</b>	<b>85</b>
7.1	Security Profiles .....	85
7.2	Association level security .....	85
7.3	Application level security .....	85
<b>8</b>	<b>ANNEXES .....</b>	<b>86</b>
8.1	IOD Contents .....	86
8.1.1	SOP Instances ELEVA EDI ViewForum Network .....	86
8.1.1.1	Secondary Capture Image Storage SOP Class .....	87
8.1.1.2	Grayscale Softcopy Presentation State (AS LAST SEEN) for the Processed Mode .....	93
8.1.1.3	Grayscale Softcopy Presentation State (AS ACQUIRED) for the Processed Mode .....	101
8.1.1.4	X-Ray RadioFluoroscopic SOP Class for the ELEVA EDI for the Processed Mode .....	106
8.1.2	Attribute Mapping .....	110
8.1.3	Coerced / Modified fields .....	111
8.2	Data Dictionary of Private Attributes .....	115
8.3	Coded Terminology and Templates .....	115
8.4	Grayscale Image consistency .....	115
8.5	Standard Extended/Specialized/Private SOPs .....	115
8.6	Private Transfer Syntaxes .....	116

## 3 INTRODUCTION

### 3.1 Revision History

**Table 3: Revision History**

Document Version	Date of Issue	Author	Description
00	04-01-2005	PMS MIT-IO	Preliminary version of the DICOM Conformance Statement for ELEVA Release 2
01	05-07-2005	PMS MIT-IO	Update Document, Commit Collect
02	03-11-2005	PMS MIT-IO	Final version of the DICOM Conformance Statement for ELEVA Release 2

### 3.2 Audience

This DICOM Conformance Statement is intended for:

- (potential) customers
- system integrators of medical equipment
- marketing staff interested in system functionality
- software designers implementing DICOM interfaces

It is assumed that the reader is familiar with the DICOM standard.

### 3.3 Remarks

The DICOM Conformance Statement is contained in chapter 1 through 8 and follows the contents and structuring requirements of the DICOM Standard PS 3.2- XXXX.

This DICOM Conformance Statement by itself does not guarantee successful interoperability of Philips equipment with non-Philips equipment. The user (or user's agent) should be aware of the following issues:

- **Interoperability**  
Interoperability refers to the ability of application functions, distributed over two or more systems, to work successfully together. The integration of medical devices into an IT environment may require application functions that are not specified within the scope of DICOM. Consequently, using only the information provided by this Conformance Statement does not guarantee interoperability of Philips equipment with non-Philips equipment. It is the user's responsibility to analyze thoroughly the application requirements and to specify a solution that integrates Philips equipment with non-Philips equipment.
- **Validation**  
Philips equipment has been carefully tested to assure that the actual implementation of the DICOM interface corresponds with this DICOM Conformance Statement.  
Where Philips equipment is linked to non-Philips equipment, the first step is to compare the relevant DICOM Conformance Statements. If the DICOM Conformance Statements indicate that successful information exchange should be possible, additional validation tests will be necessary to ensure the functionality, performance, accuracy and stability of image and image related

data. It is the responsibility of the user (or user's agent) to specify the appropriate test suite and to carry out the additional validation tests.

- **New versions of the DICOM Standard**

The DICOM Standard will evolve in future to meet the user's growing requirements and to incorporate new features and technologies. Philips is actively involved in this evolution and plans to adapt its equipment to future versions of the DICOM Standard. In order to do so, Philips reserves the right to make changes to its products or to discontinue its delivery.

The user should ensure that any non-Philips provider linking to Philips equipment also adapts to future versions of the DICOM Standard. If not, the incorporation of DICOM enhancements into Philips equipment may lead to loss of connectivity (in case of networking) and incompatibility (in case of media).

### 3.4 Definitions, Terms and Abbreviations

DICOM definitions, terms and abbreviations are used throughout this Conformance Statement. For a description of these, see NEMA PS 3.3-XXXX and PS 3.4-XXXX. The word Philips in this document refers to Philips Medical Systems. The following acronyms and abbreviations may be used in this document.

AE	Application Entity
ACR	American College of Radiology
CD	Compact Disc
CD-R	CD-Recordable
CT	Computed Tomography
DICOM	Digital Imaging and Communications in Medicine
DIMSE	DICOM Message Service Element
DVD-JPEG	Digital Video Disc – JPEG
EBE	DICOM Explicit VR Big Endian
EEC AE	ELEVA Examination Control Application Entity
ELE	DICOM Explicit VR Little Endian
FSC	File-set Creator
FSR	File-set Reader
FSU	File-set Updater
GUI	Graphical User Interface
HIPAA	Health Insurance Portability and Accountability Act
ILE	DICOM Implicit VR Little Endian
IHE	Integrating the Healthcare Enterprise
IOD	Information Object Definition
JPEG	Joint Photographic Experts Group
MR	Magnetic Resonance
N/A	Not Applicable
NEMA	National Electrical Manufacturers Association
PDU	Protocol Data Unit
PMS(N)	Philips Medical Systems (Nederland B.V.)
Q/R	Query/Retrieve (Service Class)
RWA	Real-World Activity
SC	Secondary Capture
SCP	Service Class Provider
SCU	Service Class User
SOP	Service Object Pair
TCP/IP	Transmission Control Protocol/Internet Protocol

UID Unique Identifier

**The following terms are used in this document:**

**ELEVA EDI System**

This ELEVA EDI System can exist of a EDI R1.2.2 or a EDI (Ditto) R2.1.2 System with the same properties.

**Image Archive (PACS)**

A system that provides long term storage of images, Presentation States, Key Image Notes and Evidence Documents [IHE].

**Image Display (ViewForum)**

A system that offers browsing of patients' studies. In addition, it may support the retrieval and display of selected sets of images, Presentation States, Key Image Notes, and Evidence Documents [IHE].

**Department System Scheduler**

A department-based information system that provides functions related to the management of orders received from external systems or through the department system's user interface. Upon a defined workflow action, makes procedures available for charge posting. The actor defines the action/event that actually causes charges to post [IHE].

**Performed Procedure Step Manager**

A system that re-distribute the Modality Performed Procedure Step Information from the Acquisition Modality or image Creator to the Department System Scheduler/Order Filler and Image Manager [IHE].

**Printer**

A system that accepts and processes DICOM print requests as a DICOM Print SCP and performs image rendering on hardcopy media. The system must support pixel rendering according to the DICOM Grayscale Standard Display Function [IHE].

### 3.5 References

- [DICOM] Digital Imaging and Communications in Medicine (DICOM), Part 1 – 16 (NEMA PS 3.1 – PS 3.16),  
National Electrical Manufacturers Association (NEMA)  
Publication Sales 1300 N. 17<sup>th</sup> Street, Suite 1847  
Rosslyn, Virginia. 22209, United States of America
- [IHE] Integrating the Healthcare Enterprise  
(IHE) Technical Framework Revision 5.4:  
Radiological Society of North America (RSNA), Inc.  
820 Jorie Boulevard, Oak Brook, IL, United States of America
- [NTP] RFC 1305: Network Time Protocol Version 3.
- [SYSLOG] RFC 3164: The BSD Syslog Protocol.
- [TLS] RFC 2246: Transport Layer Security protocol (TLS) v1.0.

---

## 4 NETWORKING

This section contains the networking related services (vs. the media related ones).

### 4.1 IMPLEMENTATION MODEL

The implementation model consists of three sections:

- The Application Data Flow Diagram, specifying the relationship between the ELEVA EDI (Ditto) Application Entity and the “external world” or Real-World Activities,
- A functional description of the ELEVA EDI (Ditto) Application Entity, and
- the sequencing constraints among them.

#### 4.1.1 Application Data Flow

The **ELEVA EDI System** consists of two Application Entities: the **ELEVA EDI ViewForum Network Application Entity ( ELEVA EDI AE )** and the **ELEVA Examination Control AE ( EEC AE )**

Figure 2 shows the Networking application data flow as a functional overview of the ELEVA EDI System. As depicted the ELEVA EDI System incorporates the following functionality.

- After RWA Request Verification, the ELEVA EDI System as SCP provides standard Verification Service Class functionality to the requesting SCU.
- After RWA Import Images, the ELEVA EDI System as SCP provides standard Storage Service Class functionality to the requesting SCU.
- After RWA Query Local Images/Retrieve Local Images, the ELEVA EDI System as SCP provides standard Query/Retrieve Service Class functionality to the requesting SCU.
- After RWA Export Images (triggered by either the operator or RWA Retrieve Local Images), the ELEVA EDI System as SCU uses the remote SCP Storage Service Class functionality to store local images on a remote database.
- After operator RWA Find Remote Images, the ELEVA EDI System as SCU uses the remote SCP Query/Retrieve Service Class functionality to query remote images.
- After operator RWA Move Remote Images, the ELEVA EDI System as SCU uses the remote SCP Query/Retrieve Service Class functionality to retrieve remote images.
- After operator RWA Request Storage Commitment, the ELEVA EDI System as SCU uses the remote SCP Storage Commitment Service Class functionality to commit remote images.
- After operator RWA Print Images, the ELEVA EDI System as SCU uses the remote Print Management Service Class to print local images.
- After operator RWA Request Printer Status, the ELEVA EDI System as SCU uses the remote Print Management Service Class to request the printer status.
- The ELEVA EDI System can request a Worklist from a remote system such as a RIS / HIS system. The ELEVA EDI System can issue the request information using the Modality Performed Procedure Step service to update the RIS.
- The ELEVA EDI System can request to query a selected remote system, request to copy images from ELEVA EDI System to a selected remote system, request storage commitment on exported images, request to retrieve

selected images from remote systems and can request to print images. This results in Associations initiated by ELEVA EDI System.

- The ELEVA EDI System is able to reply on verification requests, to execute a requested query, to store received images into ELEVA EDI System and retrieve requested images from ELEVA EDI System. These requests from remote systems are done via Associations initiated by the remote systems.
- The ELEVA EDI System is also able to display the contents (i.e. directory listing) of DICOM CD-Recordable disk to Write, Read and Update images on / from a DICOM CD-Recordable disk.
- The ELEVA EDI System is also able to display the contents (i.e. directory listing) of DICOM DVD disk to Write and Read images on / from a DICOM DVD disk.

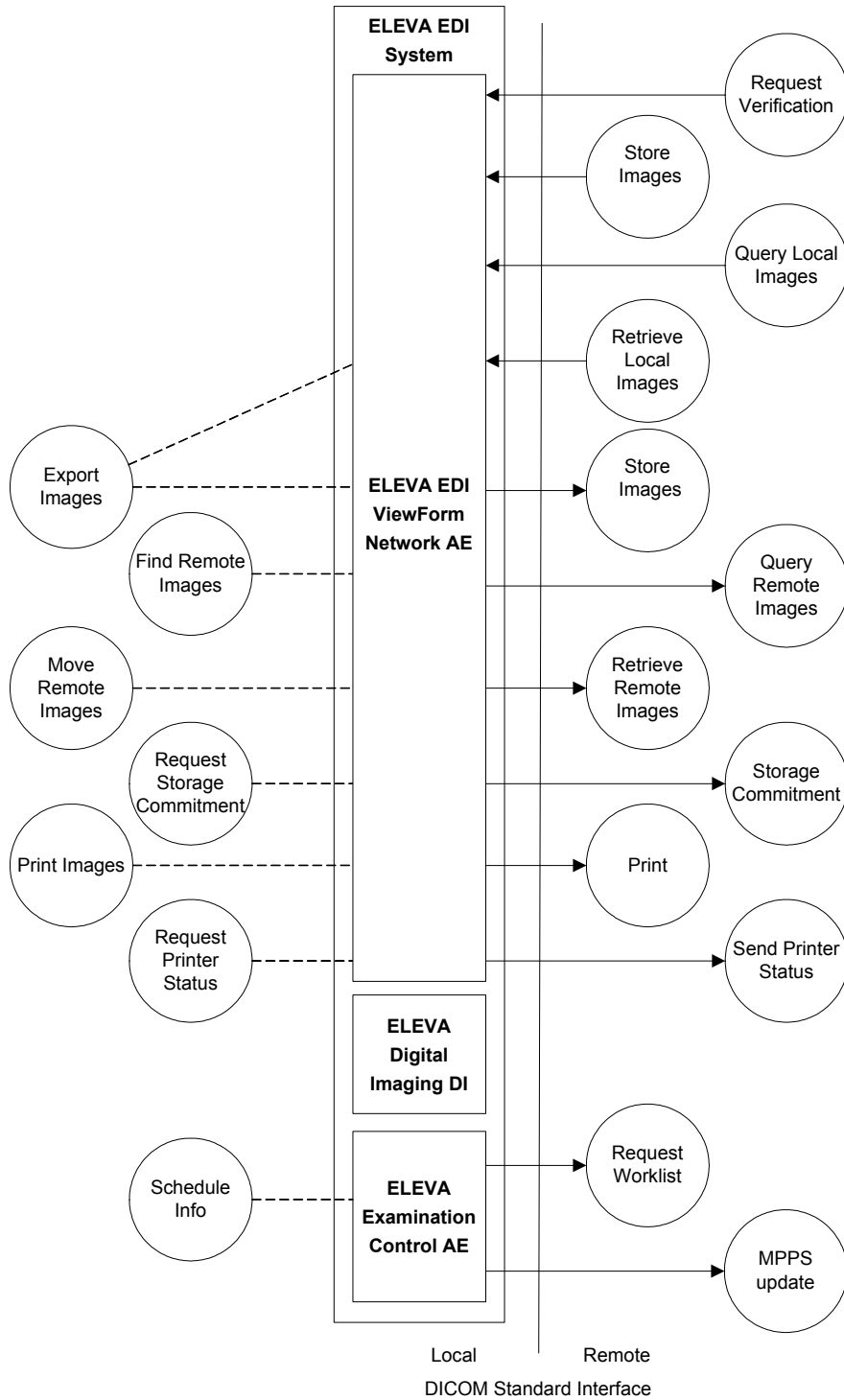

Figure 2: Networking Application Data Flow Diagram of the ELEVA EDI System

---

#### 4.1.2 Functional Definition of AE's

This section shall describe in general terms the functions to be performed by the AE, and the DICOM services used to accomplish these functions.

##### 4.1.2.1 Functional Definition of ELEVA EDI System

The ELEVA EDI System includes the following service classes.

###### **Verification Service Class**

The ELEVA EDI AE can perform the Verification service as SCP (RWA Request Verification).

A remote SCU shall request an association with the ELEVA EDI AE for Verification SOP class. After accepting the association, the ELEVA EDI AE shall receive and respond to the Verification request, and release the association when requested.

###### **Storage Service Class**

The ELEVA EDI AE can perform the Storage service as SCP (RWA Import Images).

A remote SCU shall request an association with the ELEVA EDI AE for Storage SOP classes. After accepting the association, the ELEVA EDI AE shall receive the Storage requests, store the data in the local database, send the applicable Storage responses, and release the association when requested.

The ELEVA EDI AE can perform the Storage service as SCU (RWA Export Images, triggered by operator or retrieve request).

The ELEVA EDI AE shall request an association with the selected remote SCP for all applicable Storage SOP classes. When the association is accepted, the ELEVA EDI AE shall send the Storage requests (including data from local database), receive the Storage responses and act accordingly, and release the association. Finally, if configured, the ELEVA EDI AE shall request storage commitment per Storage Commitment service (ref. Storage Commitment service class).

###### **Query/Retrieve Service Class**

The ELEVA EDI AE can perform the Query/Retrieve service as SCP (RWA Query Local Images and RWA Retrieve Local Images).

A remote SCU shall request an association with the ELEVA EDI AE for Query/Retrieve SOP classes. After accepting the association, the ELEVA EDI AE shall receive the Query/Retrieve requests. In case of a Retrieve request, the ELEVA EDI AE shall request storage per Storage service as SCU (ref. Storage Service Class). Next, the ELEVA EDI AE shall send the applicable Query/Retrieve responses, and release the association when requested.

The ELEVA EDI AE can perform the Query/Retrieve service as SCU (RWA Find Remote Images and RWA Move Remote Images).

The ELEVA EDI AE shall request an association with the selected remote SCP for the applicable (configured) Query/Retrieve SOP class. When the association is accepted, the ELEVA EDI AE shall send the Query/Retrieve requests, receive the Query/Retrieve responses and act accordingly, and finally release the association.



---

The ELEVA EDI AE fully supports the Cancel functionality, both as SCU and as SCP.

**Storage Commitment Service Class**

The ELEVA EDI AE can perform the Storage Commitment service as SCU (RWA Request Storage Commitment).

The ELEVA EDI AE shall request an association with the selected remote SCP for the Storage Commitment Push Model SOP class. When the association is accepted, the ELEVA EDI AE shall send the Storage Commitment requests, receive the Storage Commitment responses and act accordingly, and release the association.

When the remote commitment actions have been finished, the remote SCP should request an association with the ELEVA EDI AE (still SCU). After accepting the association, the ELEVA EDI AE shall receive the Storage Commitment reports, and release the association when requested.

The Storage Commitment Service can be done Synchronous and Asynchronous. A detailed specification of the Storage Commitment is described in section 4.2.1.3.4 (RWA Request Storage Commitment).

**Print Management Service Class**

The ELEVA EDI AE Print service acts as a Service Class User SCU (RWA Print Images).

The ELEVA EDI AE shall request an association with the selected remote SCP (printer) for all applicable SOP classes of the applicable Print Management Meta SOP class. When the association is accepted, the ELEVA EDI AE shall send the Print requests (including data from local database), receive the Print responses and act accordingly, and finally release the association.

The ELEVA EDI AE can perform the Printer service as SCU (RWA Request Printer Status)

The ELEVA EDI AE shall request an association with the selected remote SCP (printer) for the Printer SOP class. When the association is accepted, the ELEVA EDI AE shall send the Get / Event Report request, receive the Printer responses and act accordingly, and finally release the association.

**Worklist Service Class**

The ELEVA Examination Control Application Entity (EEC AE) acts as a Service Class User (SCU) for Worklist and MPPS.

**Media Service Class.**

The ELEVA EDI AE acts also as a File Set Creator (FSC), File Set Reader (FSR) and File Set Updater (FSU) for supported CD + R medium and File Set Creator (FSC) and File Set Reader (FSR) for supported DVD + RW medium.

**4.1.3 Sequencing of Real World Activities**

This section shall contain a description of specific sequencing as well as potential constraints of Real-World Activities, including any applicable user interactions, as performed by the ELEVA EDI System.

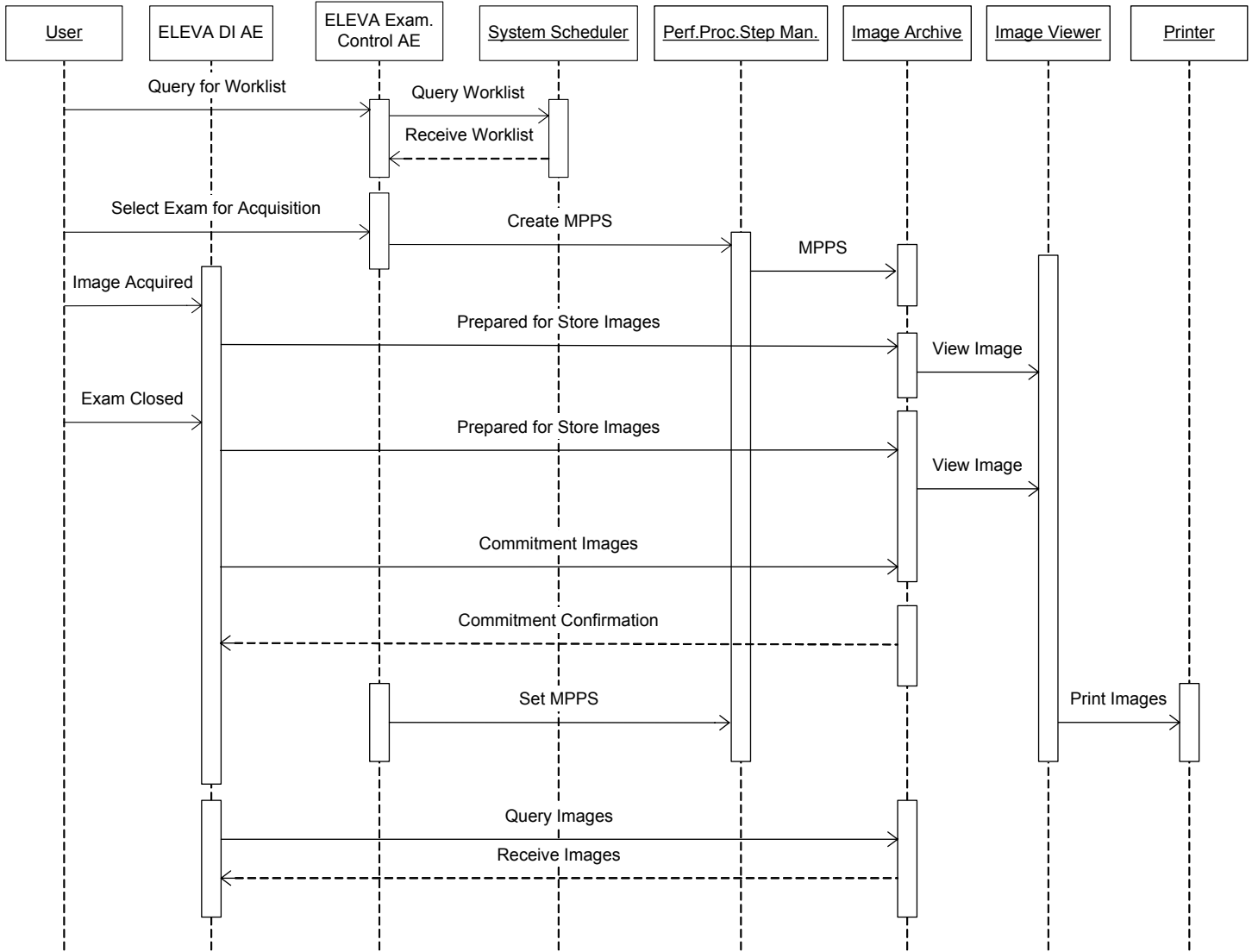

Figure 3: Sequencing of the Real World Activities of ELEVA EDI System

Examinations, identified with a new UID, are created inside the **ELEVA Examination Control AE** (EEC AE) as result of Worklist management or on manual

scheduling by the clinical user.

Once an examination (an equivalent to the DICOM Procedure Step) is created, the user can select it at the EEC for acquisition. The administration parameters will be sent from EEC to the DI, where also a new Examination is created, having the same UID and parameters.

Examination selection for acquisition is synchronized between EEC and DI. Once acquisition has started, the MPPS CREATED messages are sent from the EEC. Acquired images from the DI and related data from DI and EEC, are added to the examination selected for acquisition in DI and EEC.

The composite images acquired are forwarded to the **ELEVA EDI ViewForum Network AE**, to be viewed, printed and exported from here. When the clinical user has explicitly indicated on the EEC that the examination is finished and /or can be deleted, this will be communicated to the DI, and the Examination instance is deleted here also, as soon as automatic export to the ViewForum Network AE has taken place.

MPPS **COMPLETED** or **DISCONTINUED** message is sent from the EEC.

## 4.2 AE SPECIFICATIONS

The next section in the DICOM Conformance Statement contains the specification of the Network capabilities of the **ELEVA EDI System** consists of two DICOM Application Entities:

- **ELEVA EDI ViewForum Network AE (ELEVA EDI AE)**
- **ELEVA Examination Control AE (EEC AE)**

The functions supported by these AE are specified in the sections 4.2.1 and 4.2.2. The Media functionality is described in section 5.

### 4.2.1 ELEVA EDI ViewForum Network AE

The ELEVA EDI ViewForum Network Application Entity provides Standard Extended Conformance to the DICOM V3.0 SOP classes as SCU/SCP as specified in Table 4. The following remarks are important:

- In case the remote system does not support the import of a specific Image Storage SOP Class, the ELEVA EDI ViewForum Network AE will convert (if configured to do so) these images and sends them via the SC Image SOP Class.
- The Imported Images should only be used for viewing purposes.
- The ELEVA EDI ViewForum Network AE requests for a Storage Commitment.

#### 4.2.1.1 Supported SOP Classes by the ELEVA EDI ViewForum Network AE as SCP/SCU.

This Application Entity provides extended Standard Conformance to the following SOP classes.

**Table 4: SOP Classes for ELEVA EDI ViewForum Network AE**

SOP Class Name	SOP Class UID	SCU	SCP
Verification	1.2.840.10008.1.1	No	Yes
Storage Commitment Push Model	1.2.840.10008.1.20.1	Yes	No
Basic Grayscale Print Management (Meta)	1.2.840.10008.5.1.1.9	Yes	No
> Basic Film Session	1.2.840.10008.5.1.1.1	Yes	No
> Basic Film Box	1.2.840.10008.5.1.1.2	Yes	No
> Basic Grayscale Image Box	1.2.840.10008.5.1.1.4	Yes	No
> Printer	1.2.840.10008.5.1.1.16	Yes	No
Basic Color Print Management (Meta)	1.2.840.10008.5.1.1.18	Yes	No
> Basic Film Session	1.2.840.10008.5.1.1.1	Yes	No
> Basic Film Box	1.2.840.10008.5.1.1.2	Yes	No
> Basic Color Image Box	1.2.840.10008.5.1.1.4.1	Yes	No
> Printer	1.2.840.10008.5.1.1.16	Yes	No
Presentation LUT	1.2.840.10008.5.1.1.23	Yes	No
Computed Radiography Image Storage	1.2.840.10008.5.1.4.1.1.1	Yes	Yes
Digital X-Ray Image Storage – for Presentation	1.2.840.10008.5.1.4.1.1.1.1	Yes	Yes
CT Image Storage	1.2.840.10008.5.1.4.1.1.2	Yes	Yes
Ultrasound Multi-frame Image Storage	1.2.840.10008.5.1.4.1.1.3.1	Yes	Yes
MR Image Storage	1.2.840.10008.5.1.4.1.1.4	Yes	Yes
Ultrasound Image Storage	1.2.840.10008.5.1.4.1.1.6.1	Yes	Yes
Secondary Capture Image Storage	1.2.840.10008.5.1.4.1.1.7	Yes	Yes
Grayscale Softcopy Presentation State Storage	1.2.840.10008.5.1.4.1.1.11.1	Yes	Yes
X-Ray Angiographic Image Storage	1.2.840.10008.5.1.4.1.1.12.1	Yes	Yes
X-Ray Radiofluoroscopic Image Storage	1.2.840.10008.5.1.4.1.1.12.2	Yes	Yes
Patient Root Query/Retrieve Information Model – FIND	1.2.840.10008.5.1.4.1.2.1.1	Yes	Yes
Patient Root Query/Retrieve Information Model – MOVE	1.2.840.10008.5.1.4.1.2.1.2	Yes	Yes
Study Root Query/Retrieve Information Model – FIND	1.2.840.10008.5.1.4.1.2.2.1	Yes	Yes
Study Root Query/Retrieve Information Model – MOVE	1.2.840.10008.5.1.4.1.2.2.2	Yes	Yes
Patient/Study Only Query/Retrieve Information Model – FIND	1.2.840.10008.5.1.4.1.2.3.1	Yes	Yes
Patient/Study Only Query/Retrieve Information Model – MOVE	1.2.840.10008.5.1.4.1.2.3.2	Yes	Yes
Specialized X-Ray	1.3.46.670589.2.3.1.1	Yes	Yes
CX Image	1.3.46.670589.2.4.1.1	Yes	Yes
3D Volume Storage	1.3.46.670589.5.0.1.1	Yes	Yes
3D Volume Object Storage	1.3.46.670589.5.0.2.1	Yes	Yes
Surface Storage	1.3.46.670589.5.0.3.1	Yes	Yes
MR Cardio Storage	1.3.46.670589.5.0.8.1	Yes	Yes
CT Synthetic Image	1.3.46.670589.5.0.9	Yes	Yes
MR Synthetic Image	1.3.46.670589.5.0.10	Yes	Yes
MR Cardio Analysis Storage	1.3.46.670589.5.0.11.1	Yes	Yes
CX Synthetic Image	1.3.46.670589.5.0.12	Yes	Yes
Perfusion	1.3.46.670589.5.0.13	Yes	Yes
Perfusion Analysis	1.3.46.670589.5.0.14	Yes	Yes

Note: Any SOP specific behavior is documented later in the Conformance Statement in the applicable SOP specific conformance section.

Remarks:

- During installation the list of available SOP classes can be configured per ELEVA EDI (Ditto) ViewForum Network AE system. The SOP classes to be supported can be configured per remote station.
- The Private SOP classes may be stored in image archives, but are to be used by ELEVA EDI (Ditto) ViewForum Network AE systems only!
- In case the remote SCP system does not support the import of a specific image storage SOP class, the ELEVA EDI (Ditto) ViewForum Network AE System will convert and send such images as Secondary Capture images (if configured to do so).
- After storing images as SCU the ELEVA EDI (Ditto) ViewForum Network AE System shall request Storage Commitment (only if configured to do so).

**4.2.1.2 Association Policies**

This section shall contain a description of the General Association Establishment and Acceptance policies of the AE.

**4.2.1.2.1 General**

The ELEVA EDI (Ditto) ViewForum Network AE System as SCU will offer unrestricted maximum PDU size on Associations initiated by ELEVA EDI ViewForum Network AE System itself. This is also configurable per remote station. When the ELEVA EDI ViewForum Network AE System acts as SCP the maximum number of simultaneous associations is unlimited by default, but the maximum can be limited via the configuration.

The DICOM standard application context shall be specified.

**Table 5: DICOM Application Context**

Application Context Name	1.2.840.10008.3.1.1.1
--------------------------	-----------------------

**4.2.1.2.2 Number of Associations**

The number of simultaneous Associations supported by ELEVA EDI ViewForum Network AE System as a Service Class Provider (SCP) is in principle not limited.

**Table 6: Number of Associations as an Association Initiator for ELEVA EDI ViewForum Network AE System**

Maximum number of simultaneous associations	3 *
---	-----

\* As a result of local activities, ELEVA EDI ViewForum Network AE System will initiate at most 3 simultaneous associations.

One association may be used to issue **query** requests, the other association may be used to issue **store or retrieve** requests, and another association may be used for **print** requests.

Furthermore, ELEVA EDI ViewForum Network AE System may initiate an association for each remote retrieve request, executed by ELEVA EDI ViewForum Network AE System as a C-MOVE operation. These associations are used to issue the C-STORE sub-operations implied by the retrieve requests. The number of simultaneous store associations for this retrieve purpose is principally not limited. The number of simultaneous associations for Storage Commitment is configurable.

**Table 7: Number of Associations as an Association Acceptor for ELEVA EDI ViewForum Network AE System**

Maximum number of simultaneous associations	Configurable
---	--------------

Nevertheless, the number of simultaneous supported associations shall be determined by the available resources (CPU, memory, disk space).

#### 4.2.1.2.3 Asynchronous Nature

ELEVA EDI System does not support asynchronous operations, and will not perform asynchronous window negotiation.

**Table 8: Asynchronous Nature as an Association Initiator for ELEVA EDI ViewForum Network AE System**

Maximum number of outstanding asynchronous transactions	N/A
---	-----

#### 4.2.1.2.4 Implementation Identifying Information

Following Implementation Class UID and Version Name are defined.

**Table 9: DICOM Implementation Class and Version for ELEVA EDI ViewForum Network AE System**

THE IMPLEMENTATION CLASS UID:	1.3.46.670589.5.2.20
Implementation Version Name	ELEVA EDI ViewForum Network AE

#### 4.2.1.3 Association Initiation Policy

ELEVA EDI ViewForum AE System shall initiate associations as a result of the following events.

- The ELEVA EDI ViewForum AE System operator or a remote (Query/Retrieve) application copies selected images from the ELEVA EDI ViewForum AE database to another database; ref. section 4.2.1.3.1 Export Images.
- The ELEVA EDI ViewForum AE System operator queries a remote database; ref. section 4.2.1.3.2 Find Remote Images.
- The ELEVA EDI ViewForum AE System operator copies selected images from a remote database to another database; ref. section 4.2.1.3.3 Move Remote Images.
- The operator requests storage commitment of images on a remote database; ref. section 4.2.1.3.4 Request Storage Commitment.
- The ELEVA EDI ViewForum AE System operator requests to print selected images of the ELEVA EDI ViewForum AE database; ref. section 4.2.1.3.5 Print Images.
- The ELEVA EDI ViewForum AE System operator requests the status of the selected printer; ref. section 0
- Request Printer Status.

---

#### 4.2.1.3.1 Export Images

##### 4.2.1.3.1.1 Description and Sequencing of Activities

The RWA Export Images involves the storage of images from the local ELEVA EDI ViewForum AE System database to a remote system.

There are two ways for the ELEVA EDI ViewForum AE System to initiate Export Images.

1. The operator is able to copy the images selected in a patient folder from the local ELEVA EDI ViewForum AE System database to another database by means of the copy tool in the ELEVA EDI ViewForum AE System data-handling tool. For each selected patient ELEVA EDI ViewForum AE System initiates an association to the selected peer entity, and uses it to send C-STORE requests and receive the associated C-STORE responses. The association is released when all selected images in the selected folder have been transmitted.  
ELEVA EDI ViewForum AE System handles operator copy requests one after another.
2. A remote application copies images from the local ELEVA EDI ViewForum AE System database to another database by sending a C-MOVE request to ELEVA EDI ViewForum AE System. For each received retrieve request ELEVA EDI ViewForum AE System initiates an association to the requested retrieve/move destination, and uses it to send C-STORE requests and receive associated C-STORE responses. The association is released when all instances, i.e. images and presentation states as selected by the retrieve request identifier, have been stored.  
ELEVA EDI ViewForum AE System is able to simultaneously handle C-MOVE requests.

Along with the image data the ELEVA EDI ViewForum AE System shall also export presentation state data. If the SCP supports the Grayscale Softcopy Presentation State storage SOP class then the applicable presentation state data will be transferred as such, otherwise the presentation state data will be merged with the image data before export.

Please refer to section 8.1.3, Coerced / Modified fields, for more information on Presentation State storage.

If configured, the ELEVA EDI ViewForum AE System shall also try and initiate a storage commitment of the stored image (after releasing the storage association). See section 4.2.1.3.4 (RWA Request Storage Commitment) for a detailed specification of the storage commitment.

Figure 4 shows the sequence of events after the operator or remote application initiates the RWA Export Images.

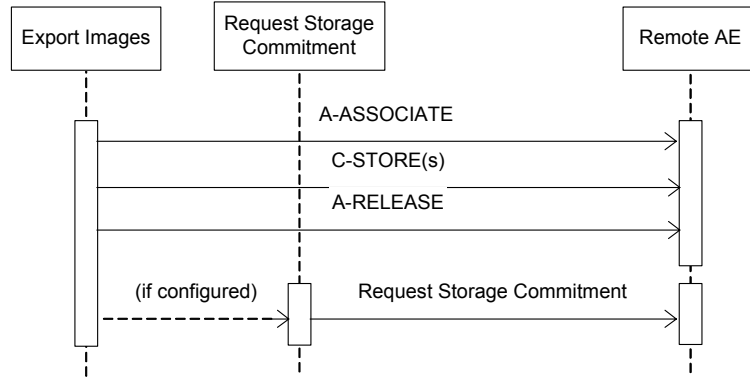

Figure 4: Sequencing of RWA Export Images

4.2.1.3.1.2 Proposed Presentation Contexts

Each time an association is initiated, the association initiator proposes a number of Presentation Contexts to be used on that association. The Presentation Contexts proposed by the ELEVA EDI ViewForum AE for Export Images are defined in Table 10.

Table 10: Proposed Presentation Contexts for Export Images

Presentation Context Table					
Abstract Syntax		Transfer Syntax		Role	Extended Negotiation
Name	UID	Name List (note)	UID List		
Computed Radiography Image Storage	1.2.840.10008.5.1.4.1.1.1	ILE ELE EBE	1.2.840.10008.1.2 1.2.840.10008.1.2.1 1.2.840.10008.1.2.2	SCU	None
Digital X-Ray Image Storage – for Presentation	1.2.840.10008.5.1.4.1.1.1.1	ILE ELE EBE	1.2.840.10008.1.2 1.2.840.10008.1.2.1 1.2.840.10008.1.2.2	SCU	None
CT Image Storage	1.2.840.10008.5.1.4.1.1.2	ILE ELE EBE	1.2.840.10008.1.2 1.2.840.10008.1.2.1 1.2.840.10008.1.2.2	SCU	None
MR Image Storage	1.2.840.10008.5.1.4.1.1.4	ILE ELE EBE	1.2.840.10008.1.2 1.2.840.10008.1.2.1 1.2.840.10008.1.2.2	SCU	None
Secondary Capture Image Storage	1.2.840.10008.5.1.4.1.1.7	ILE ELE EBE	1.2.840.10008.1.2 1.2.840.10008.1.2.1 1.2.840.10008.1.2.2	SCU	None
Grayscale Softcopy Presentation State Storage	1.2.840.10008.5.1.4.1.1.11.1	ILE ELE EBE	1.2.840.10008.1.2 1.2.840.10008.1.2.1 1.2.840.10008.1.2.2	SCU	None
X-Ray Angiographic Image Storage	1.2.840.10008.5.1.4.1.1.12.1	ILE ELE EBE	1.2.840.10008.1.2 1.2.840.10008.1.2.1 1.2.840.10008.1.2.2	SCU	None



Presentation Context Table					
Abstract Syntax		Transfer Syntax		Role	Extended Negotiation
Name	UID	Name List (note)	UID List		
X-Ray Radiofluoroscopic Image Storage	1.2.840.10008.5.1.4.1.1.12.2	ILE ELE EBE	1.2.840.10008.1.2 1.2.840.10008.1.2.1 1.2.840.10008.1.2.2	SCU	None
Specialized X-Ray	1.3.46.670589.2.3.1.1	ILE ELE EBE	1.2.840.10008.1.2 1.2.840.10008.1.2.1 1.2.840.10008.1.2.2	SCU	None
CX Image	1.3.46.670589.2.4.1.1	ILE ELE EBE	1.2.840.10008.1.2 1.2.840.10008.1.2.1 1.2.840.10008.1.2.2	SCU	None
3D Volume Storage	1.3.46.670589.5.0.1.1	ILE ELE EBE	1.2.840.10008.1.2 1.2.840.10008.1.2.1 1.2.840.10008.1.2.2	SCU	None
3D Volume Object Storage	1.3.46.670589.5.0.2.1	ILE ELE EBE	1.2.840.10008.1.2 1.2.840.10008.1.2.1 1.2.840.10008.1.2.2	SCU	None
Surface Storage	1.3.46.670589.5.0.3.1	ILE ELE EBE	1.2.840.10008.1.2 1.2.840.10008.1.2.1 1.2.840.10008.1.2.2	SCU	None
MR cardio Storage	1.3.46.670589.5.0.8.1	ILE ELE EBE	1.2.840.10008.1.2 1.2.840.10008.1.2.1 1.2.840.10008.1.2.2	SCU	None
CT Synthetic Image	1.3.46.670589.5.0.9	ILE ELE EBE	1.2.840.10008.1.2 1.2.840.10008.1.2.1 1.2.840.10008.1.2.2	SCU	None
MR Synthetic Image	1.3.46.670589.5.0.10	ILE ELE EBE	1.2.840.10008.1.2 1.2.840.10008.1.2.1 1.2.840.10008.1.2.2	SCU	None
MR Cardio Analysis Storage	1.3.46.670589.5.0.11.1	ILE ELE EBE	1.2.840.10008.1.2 1.2.840.10008.1.2.1 1.2.840.10008.1.2.2	SCU	None
CX Synthetic Image	1.3.46.670589.5.0.12	ILE ELE EBE	1.2.840.10008.1.2 1.2.840.10008.1.2.1 1.2.840.10008.1.2.2	SCU	None
Perfusion	1.3.46.670589.5.0.13	ILE ELE EBE	1.2.840.10008.1.2 1.2.840.10008.1.2.1 1.2.840.10008.1.2.2	SCU	None
Perfusion Analysis	1.3.46.670589.5.0.14	ILE ELE EBE	1.2.840.10008.1.2 1.2.840.10008.1.2.1 1.2.840.10008.1.2.2	SCU	None
Ultra sound Multi-frame Image Storage	1.2.840.10008.5.1.4.1.1.3.1	ILE ELE EBE JPEG Baseline (Note 1)	1.2.840.10008.1.2 1.2.840.10008.1.2.1 1.2.840.10008.1.2.2 1.2.840.10008.1.2.4.50	SCU	None
Ultra sound Image Storage	1.2.840.10008.5.1.4.1.1.6.1	ILE ELE EBE JPEG Baseline (Note 1)	1.2.840.10008.1.2 1.2.840.10008.1.2.1 1.2.840.10008.1.2.2 1.2.840.10008.1.2.4.50	SCU	None

Note : For performance reasons the ELE transfer syntax is preferred. Extended negotiation is not supported.

Note1: Only for Photometric Interpretation of RGB and YBR\_FULL\_422. Therefore JPEG Baseline transfer syntax may NOT be configured for SCU systems that are capable of handling storage of monochrome images too.

---

#### 4.2.1.3.1.3 SOP Specific Conformance for SOP Classes

Important remarks about the exported images:

- In case the remote system does not support modality specific image storage SOP class, the ELEVA EDI ViewForum AE will convert the images (if configured to do so) and send them via the Secondary Capture image storage SOP class. These Secondary Capture images and additional information (like graphics, text and important attribute information) are burnt-in (if configured). The original bit depth of the Secondary Capture image is kept.  
Note: only standard DICOM images can be converted, private SOP classes cannot be converted.
- In case of color images, all color-coding schemes are sent as they were received.
- Attributes e.g. Study Date and Study Time will be added to images to be exported (if not yet present). This is done because there are imaging systems relying on the existence of these attributes.
- The ELEVA EDI ViewForum AE allows the operator to modify attributes of the stored images. ELEVA EDI ViewForum AE does not modify the pixel values of the stored images.  
Modified images retain their original Study, Series and Image UID.
- On the export of an imported image the ELEVA EDI ViewForum AE adds private attributes to the image.
- The exported ELEVA EDI ViewForum AE images do not contain Instance Number if the original images received from modalities do not contain this attribute or provide information in other attributes for ELEVA EDI ViewForum AE to generate it.
- Exported CT/MR images relate Scanogram and Slice images in the following way: Attribute 'Referenced Image Sequence' is present in the slice images and points to the related Scanogram image.  
Note that Attribute 'Frame of Reference UID' in the Scanogram (Localiser image) and related image slices are not guaranteed to be equal; this depends on the source of the images.
- For Secondary Capture images only one Window Width and Window Centre value is exported.
- Please refer to section 8.1.3, Coerced / Modified fields, for more information on stored images.
- When the location of a graphic or text annotation is specified relatively with regards to the displayed area. (i.e. DICOM attribute: Bounding Box Annotation Units, Anchor Point Annotation Units or Graphic Annotation Units equals "DISPLAY"), the annotation is not displayed.
- Areas occluded by Shutter are always black in ELEVA EDI ViewForum AE, whereas it is possible to want it to be white in DICOM.
- On the export of such an image the ELEVA EDI ViewForum AE system first sets up an association to determine if the SCP supports the Grayscale Softcopy Presentation State SOP Class.  
If the SCP doesn't supports the Grayscale Softcopy Presentation State service the Graphical information is added to the image object additional a new instance UID is generated for this image.
- All kind of Images sending out, are included with Performed Procedure Step Tags like: (Start Date, Start Time, ID ).

### Use of optional, private and retired attributes

The transmitted Storage SOP instances may include all optional elements specified in the DICOM standard, depending on the source of the images.

The transmitted Storage SOP instances may contain Retired and Private data elements, depending on the source of the images and of the ELEVA EDI ViewForum AE configuration.

The ELEVA EDI ViewForum AE can convert the transfer syntax when exporting images. The ELEVA EDI ViewForum AE can perform a transfer syntax according to the following table.

**Table 11: Transfer Syntax Conversion**

Syntax	Source	ILE	ELE	EBE	JPEG Baseline
Destination	/				
ILE		+	+	+	-
ELE		+	+	+	-
EBE		+	+	+	-
JPEG Baseline	*	+	+	+	-

- *JPEG Baseline is only supported for images with Photometric Interpretation of YBR\_FULL\_422.*
- *As ELEVA EDI ViewForum AE internally stores the images in uncompressed format, the image data shall be compressed to JPEG (RGB to YBR\_FULL\_422) before export.*
- *Note that JPEG Baseline transfer syntax may NOT be configured for SCU systems that are capable of handling storage of monochrome images too.*

The Store Response Status is saved in the log file; a user error will be displayed in the GUI.

The ELEVA EDI ViewForum AE will stop the transfer of the images and release the association as soon as it receives an unsuccessful Store Response Status.

In case that a remote application requested the transfer (by means of a C-MOVE request), a move response with status unsuccessful is sent to the retrieve requestor.

Following are the details regarding the specific conformance, including response behavior to all status codes, both from an application level and communication errors.

**Table 12: DICOM Command Response Status Handling Behavior**

Service Status	Further Meaning	Error Code	Behavior
Success	Storage is complete	0000	Continues with next store until completed thereafter the store job is marked as completed and the association is released.
Refused	Out of Resources	A7xx	The store job fails and the association is released. The reason is logged and reported to the user.
Error	Data set does not match SOP Class	A9xx	The store job fails and the association is released. The reason is logged and reported to the user.
	Cannot understand	Cxxx	The store job fails and the association is released. The reason is logged and reported to the user.
Warning	Coercion of Data Elements	B000	Continues with next store until completed thereafter the store job is marked as completed and the association is released.
	Elements discarded	B006	Continues with next store until completed thereafter the store job is marked as completed and the association is released.
	Data set does not match SOP class	B007	Continues with next store until completed thereafter the store job is marked as completed and the association is released.

**Table 13: DICOM Command Communication Failure Behavior**

Exception	Behavior
ARTIM Time-out	The store job fails in case of association setup. The reason is logged and reported to the user.
Reply Time-out	The store job fails and the association is aborted. The reason is logged and reported to the user.
Association Time-out SCU	The association is released.
Association aborted	The store job fails. The reason is logged and reported to the user.

#### 4.2.1.3.2 Find Remote Images

##### 4.2.1.3.2.1 Description and Sequencing of Activities

The RWA Find Remote Images involves the query of a remote system to find matching images in the remote database.

The operator queries a remote database by means of the query tool in the ELEVA EDI ViewForum AE data handling facility. The ELEVA EDI ViewForum AE initiates an association to the selected peer entity and uses it to send Query (C-FIND) requests (and receive the associated responses). The association is released when the execution of the query completes (the Query/Retrieve dialog on the GUI is closed).

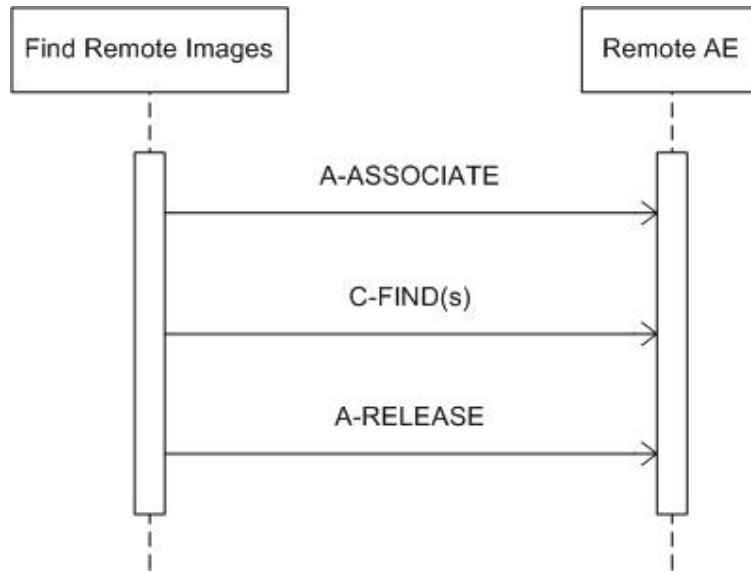

Figure 5: Sequencing of RWA Find Remote Images

4.2.1.3.2.2 Proposed Presentation Contexts

Each time an association is initiated, the association initiator proposes a number of Presentation Contexts to be used on that association. In this subsection, the Presentation Contexts proposed by the ELEVA EDI ViewForum AE for Find Remote Images are defined in Table 14.

Table 14: Proposed Presentation Contexts for Find Remote Images

Presentation Context Table					
Abstract Syntax		Transfer Syntax		Role	Extended Negotiation
Name	UID	Name List (note)	UID List		
Patient Root Query /Retrieve Information Model - FIND	1.2.840.10008.5.1.4.1.2.1.1	ILE ELE EBE	1.2.840.10008.1.2 1.2.840.10008.1.2.1 1.2.840.10008.1.2.2	SCU	None
Study Root Query /Retrieve Information Model - FIND	1.2.840.10008.5.1.4.1.2.2.1	ILE ELE EBE	1.2.840.10008.1.2 1.2.840.10008.1.2.1 1.2.840.10008.1.2.2	SCU	None
Patient/Study Only Query/Retrieve Information Model - FIND	1.2.840.10008.5.1.4.1.2.3.1	ILE ELE EBE	1.2.840.10008.1.2 1.2.840.10008.1.2.1 1.2.840.10008.1.2.2	SCU	None

Note: For performance reasons the ELE transfer syntax is preferred.

#### 4.2.1.3.2.3 SOP Specific Conformance for SOP Classes

The ELEVA EDI ViewForum AE will not generate queries containing optional keys.  
The ELEVA EDI ViewForum AE will not generate relational queries.

In the following table the supported Query Keys for each query level are described.  
Universal matching shall be supported as default.

**Table 15: Supported Query Keys of the ELEVA EDI ViewForum AE**

Query Level	Query Key				
	Name	Tag	Query Key	Matching Key	
Patient	Patient's Name	0010,0010	X	X	
	Patient ID	0010,0020	X	X	
	Patient's Birth Date	0010,0030	X		
	Patient's Sex	0010,0040	X		
Study	Study Date	0008,0020	X	X	
	Study Time	0008,0030	X		
	Accession Number	0008,0050	X	X	
	Modalities in Study	0008,0061			
	Referring Physician's Name	0008,0090	X		
	Study Description	0008,1030	X		
	Study Instance UID	0020,000D			
	Study ID	0020,0010	X	X	
	Requesting Physician	0032,1032			
Series	Modality	0008,0060	X		
	Station Name	0008,1010	X		
	Performing Physician's Name	0008,1050	X		
	Body Part Examined	0018,0015	X		
	Protocol Name	0018,1030	X		
	Series Instance UID	0020,000E			
	Series Number	0020,0011			
	Performed Station Name	0040,0242	X		
	Performed Procedure Step Start Date	0040,0244	X		
	Performed Procedure Step ID	0040,0253	X		
	Performed Procedure Type Description	0040,0255	X		
	Image	SOP Class UID	0008,0016	X	
		SOP Instance UID	0008,0018	X	
Content Date		0008,0023	X		
Content Time		0008,0033	X		
Instance Number		0020,0013	X		

Do note that the query results screen will display all patients that have an empty Patient ID as one patient entry.

Following are the details regarding the specific conformance, including response behavior to all status codes, both from an application level and communication errors.

**Table 16: DICOM Command Response Status Handling Behavior**

Service Status	Further Meaning	Error Code	Behavior
Success	Matching is complete	0000	The find results are displayed.
Refused	Out of Resources	A700	No find results are displayed. The reason is logged.
Failed	Identifier does not match SOP class	A900	No find results are displayed. The reason is logged.
	Unable to process	Cxxx	No find results are displayed. The reason is logged.
Cancel	Matching terminated due to Cancel Request	FE00	No find results are displayed. The reason is logged.
Pending	Matches are continuing – Current match is supplied and any optional keys were supported in the same manner as required keys	FF00	The find command continues.
	Matches are continuing – Warning that one or more optional keys were not supported for existence and/or matching for this identifier	FF01	The find command continues.

**Table 17: DICOM Command Communication Failure Behavior**

Exception	Behavior
ARTIM Time-out	N/A
Reply Time-out	The query fails and the association is aborted. The reason is logged and reported to the user.
Association Time-out SCU	The association is released.
Association aborted	The query fails. The reason is logged and reported to the user.

### 4.2.1.3.3 Move Remote Images

#### 4.2.1.3.3.1 Description and Sequencing of Activities

The RWA Move Remote Images involves the retrieve of images on a remote system by moving matching images from the remote database to another database.

The operator is able to copy the selected images in a patient folder from a remote database to another, local or remote, database by means of the copy tool in the ELEVA EDI ViewForum AE data handling facility. The ELEVA EDI ViewForum AE initiates for each copy request an association to the selected peer entity (Remote AE) and uses it to send the Retrieve (C-MOVE) request (and receive the associated responses). An examination may contain both images and presentation states. The association is released after the final Retrieve (C-MOVE) response for the related request has been received (no more pending).

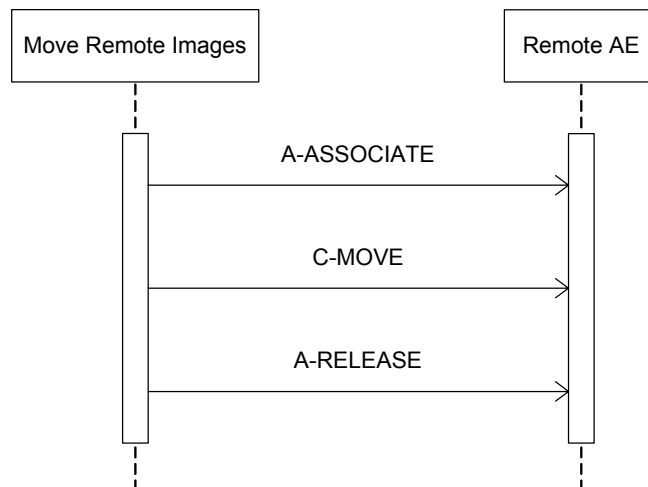

Figure 6: Sequencing of RWA Move Remote Images

#### 4.2.1.3.3.2 Proposed Presentation Contexts

Each time an association is initiated, the association initiator proposes a number of Presentation Contexts to be used on that association. In this subsection, the Presentation Contexts proposed by the ELEVA EDI ViewForum AE for Move Remote Images are defined in Table 18.



**Table 18: Proposed Presentation Contexts for Move Remote Images**

Presentation Context Table					
Abstract Syntax		Transfer Syntax		Role	Extended Negotiation
Name	UID	Name List (note)	UID List		
Patient Root Query /Retrieve Information Model - MOVE	1.2.840.10008.5.1.4.1.2.1.2	ILE ELE EBE	1.2.840.10008.1.2 1.2.840.10008.1.2.1 1.2.840.10008.1.2.2	SCU	None
Study Root Query /Retrieve Information Model - MOVE	1.2.840.10008.5.1.4.1.2.2.2	ILE ELE EBE	1.2.840.10008.1.2 1.2.840.10008.1.2.1 1.2.840.10008.1.2.2	SCU	None
Patient/Study Only Query/Retrieve Information Model - MOVE	1.2.840.10008.5.1.4.1.2.3.2	ILE ELE EBE	1.2.840.10008.1.2 1.2.840.10008.1.2.1 1.2.840.10008.1.2.2	SCU	None

Note: For performance reasons the ELE transfer syntax is preferred.

#### 4.2.1.3.3.3 SOP Specific Conformance for SOP Classes

The ELEVA EDI ViewForum AE provides standard conformance.

Following are the details regarding the specific conformance, including response behavior to all status codes, both from an application level and communication errors.

**Table 19: DICOM Command Response Status Handling Behavior**

Service Status	Further Meaning	Error Code	Behavior
Success	Sub-operations complete – No Failures	0000	The move job is marked as completed. The association is released.
Refused	Out of Resources – Unable to calculate number of matches	A701	The move job is marked as failed. The association is released. The reason is logged and reported to the user.
	Out of Resources – Unable to perform Sub-operations	A702	The move job is marked as failed. The association is released. The reason is logged and reported to the user.
	Move Destination unknown	A801	The move job is marked as failed. The association is released. The reason is logged and reported to the user.
Failed	Identifier does not match SOP class	A900	The move job is marked as failed. The association is released. The reason is logged and reported to the user.
	Unable to process	Cxxx	The move job is marked as failed. The association is released. The reason is logged and reported to the user.
Cancel	Sub-operations terminated due to Cancel Indication	FE00	The move job is marked as failed. The association is released. The reason is logged and reported to the user.
Warning	Sub-operations complete – One or more Failures	B000	The move job is marked as completed. The association is released.
Pending	Sub-operations are continuing	FF00	The move job continues.

**Table 20: DICOM Command Communication Failure Behavior**

Exception	Behavior
ARTIM Time-out	The move job fails in case of association setup. The reason is logged and reported to the user.
Reply Time-out	The move job fails and the association is aborted. The reason is logged and reported to the user.
Association Time-out SCU	N/A
Association aborted	The move job fails. The reason is logged and reported to the user.

**4.2.1.3.4 Request Storage Commitment**

**4.2.1.3.4.1 Description and Sequencing of Activities**

The RWA Request Storage Commitment involves the storage commitment of images on a remote system.

If configured, Storage Commitment will be initiated in a new association after closing the association of the related image storage (C-STORE). This new association will be open until the remote archive sends a storage commitment report (**synchronous**) or when the configured maximum time is passed. When this maximum configured period is passed, it is the responsibility of the remote archive to setup a new association with ELEVA EDI ViewForum AE and send the storage commitment report (**asynchronous**).

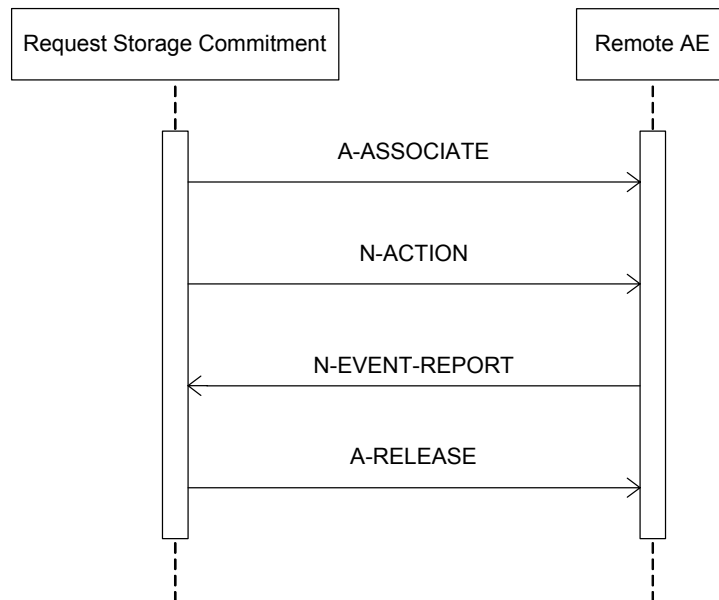

**Figure 7: Sequencing of Synchronous RWA Request Storage Commitment**

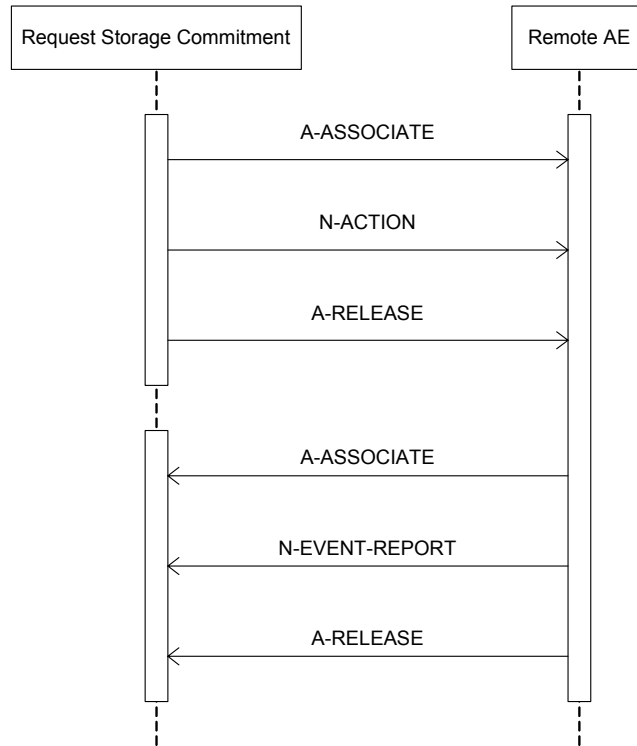

Figure 8: Sequencing of Asynchronous RWA Request Storage Commitment

4.2.1.3.4.2 Proposed Presentation Contexts

Each time an association is initiated, the association initiator proposes a number of Presentation Contexts to be used on that association. In this subsection, the Presentation Contexts proposed by the ELEVA EDI ViewForum AE for Request Storage Commitment are defined in Table 21.

Table 21: Proposed Presentation Contexts for Request Storage Commitment

Presentation Context Table					
Abstract Syntax		Transfer Syntax		Role	Extended Negotiation
Name	UID	Name List (note)	UID List		
Storage Commitment Push Model	1.2.840.10008.1.20.1	ILE	1.2.840.10008.1.2	SCU	None
		ELE	1.2.840.10008.1.2.1	SCU	None
		EBE	1.2.840.10008.1.2.2	SCU	None

Note: For performance reasons the ELE transfer syntax is preferred.

#### 4.2.1.3.4.3 SOP Specific Conformance for SOP Class

The ELEVA EDI ViewForum AE provides standard conformance. In ELEVA EDI ViewForum AE many remote nodes can be configured for storage Images. Per remote node one node can be configured to deliver the Storage Commitment service. Following are the details regarding the specific conformance, including response behavior to all status codes, both from an application level and communication errors.

**Table 22: DICOM Command Response Status Handling Behavior**

Service Status	Further Meaning	Error Code	Behavior
Success	Operation complete	0000	Continues with waiting for storage commitment.
Failure	(any failure)	xxxx	The reason is logged.

The ELEVA EDI ViewForum AE does not take any more actions on receiving the N-EVENT-REPORT, even when failures exist (Event Type ID 2).

**Table 23: DICOM Command Communication Failure Behavior**

Exception	Behavior
ARTIM Time-out	The reason is logged.
Reply Time-out	The association is released. Continues with waiting for storage commitment.
Association Time-out SCU	The association is released. Continues with waiting for storage commitment.
Association aborted	Continues with waiting for storage commitment.

#### 4.2.1.3.5 Print Images

##### 4.2.1.3.5.1 Description and Sequencing of Activities

The RWA Print Images involves the printing of images by sending the selected images to a Print Management SCP (i.e. printer). After selecting the print destination (out of choice list of configured printers) and some print parameters (depending on the configuration and the selected printer; these values can be configured too), the ELEVA EDI ViewForum AE shall initiate an association to the selected printer and use it to send the print job. ELEVA EDI ViewForum AE also has an option for print preview.

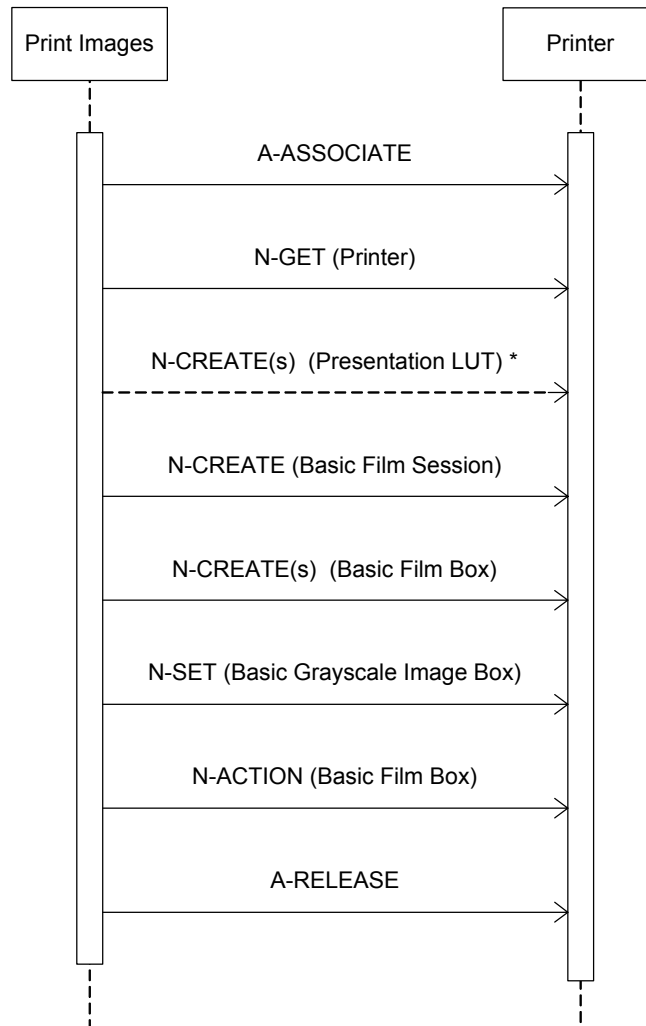

Figure 9: Sequencing of RWA Print Images

- Note that the Presentation LUT SOP class is only supported for Grayscale image printing.

#### 4.2.1.3.5.2 Proposed Presentation Contexts

Each time an association is initiated, the association initiator proposes a number of Presentation Contexts to be used on that association. In this subsection, the Presentation Contexts proposed by the ELEVA EDI ViewForum AE for Print Images are defined in Table 24.

**Table 24: Proposed Presentation Contexts for Print Images**

Presentation Context Table					
Abstract Syntax		Transfer Syntax		Role	Extended Negotiation
Name	UID	Name List (note)	UID List		
Basic Grayscale Print Management (Meta)	1.2.840.10008.5.1.1.9	ILE ELE EBE	1.2.840.10008.1.2 1.2.840.10008.1.2.1 1.2.840.10008.1.2.2	SCU	None
Basic Color Print Management (Meta)	1.2.840.10008.5.1.1.14	ILE ELE EBE	1.2.840.10008.1.2 1.2.840.10008.1.2.1 1.2.840.10008.1.2.2	SCU	None
Presentation LUT	1.2.840.10008.5.1.1.23	ILE ELE EBE	1.2.840.10008.1.2 1.2.840.10008.1.2.1 1.2.840.10008.1.2.2	SCU	None

*Note: For performance reasons the ELE transfer syntax is preferred.*

**Overlay, Annotation** (showing the values of some major identifying attributes) and **Shutter information** is processed in the images sent to the printer (i.e. burnt-in in the image).

The next abbreviations are used in the following tables:

#### Used Presentation Values:

ALWAYS the module or attribute shall always be present with value  
 ANAP Attribute Not Always Present  
 VNAP Value Not Always Present (attribute sent zero length if no value is present)  
 EMPTY Attribute is sent without a value  
 MAYBE the module may be present under specified condition  
 OPTIONAL the module may be available, depending on source object

#### Used Source Items:

AUTO the attribute value is generated automatically  
 CONF the attribute value source is a configurable parameter  
 IMPL the attribute value source is a user-implicit configuration setting  
 MPPS the attribute value source is a modality performed procedure step  
 MWL the attribute value source is a modality Worklist  
 SPEC the attribute value source is a specific DICOM object  
 USER the attribute value source is explicit user input

#### 4.2.1.3.5.3 SOP Specific Conformance Printer SOP Class

The Printer process conforms to the Printer Sop Class.  
The following DIMSE service element is supported:

##### N-GET

N-GET DIMSE does not create any Data Set Attributes.  
The behavior on successful and unsuccessful transfer is given in the table below.

**Table 25: DICOM Command Response Status Handling Behavior for Printer N-GET**

Service Status	Further Meaning	Error Code	Behavior
Success	Successful operation	0000	The print job continues.
Warning	(any warning)	xxxx	The print job continues and the warning is logged.
Failure	(any failure)	xxxx	The print job is marked as failed, the reason is logged and reported to the user.

#### 4.2.1.3.5.4 SOP Specific Conformance Basic Film Session SOP Class

The Printer process conforms to the Basic Film Session Sop Class.  
The following DIMSE service element is supported:

##### N-CREATE

The following table lists the supported attributes for the N-CREATE DIMSE.

**Table 26: Basic Film Session Presentation Module**

Attribute Name	Tag	VR	Value	Presence of Value	Source
Number of Copies	2000,0010	IS	1 to 99	ALWAYS	USER/IMPL
Print Priority	2000,0020	CS	HIGH	ALWAYS	USER/IMPL
Medium Type	2000,0030	CS	BLUE FILM, CLEAR FILM, PAPER	ALWAYS	IMPL
Film Destination	2000,0040	CS	MAGAZINE, PROCESSOR	ALWAYS	IMPL
Film Session Label	2000,0050	LO	Philips Medical Systems	ALWAYS	AUTO

The behavior on successful and unsuccessful transfer is given in the table below.

**Table 27: DICOM Command Response Status Handling Behavior for Basic Film Session N-CREATE**

Service Status	Further Meaning	Error Code	Behavior
Success	Film Session successfully created	0000	The print job continues.
Warning	Memory Allocation not supported	B600	The print job continues and the warning is logged.

#### 4.2.1.3.5.5 SOP Specific Conformance Basic Film Box SOP Class

The Printer process conforms to the Basic Film Box Sop Class.  
The following DIMSE service elements are supported:

#### N-CREATE N-ACTION

The following table lists the supported attributes for the N-CREATE DIMSE

**Table 28: Basic Film Box Presentation Module**

Attribute Name	Tag	VR	Value	Presence of Value	Source
Image Display Format	2010,0010	ST	STANDARD\1,1 CUSTOM\1	ALWAYS	CONF
Film Orientation	2010,0040	CS	PORTRAIT; LANDSCAPE	ALWAYS	CONF
Film Size ID	2010,0050	CS	8INX10IN, 8_5INX11IN, A, 10INX12IN, 10INX14IN, A3, 11INX14IN, 11INX17IN, A4, 14INX14IN, 14INX17IN, 24CMX24CM, 24CMX30CM	ALWAYS	CONF
Magnification Type	2010,0060	CS		ALWAYS	USER
Max Density	2010,0130	US		VNAP	CONF
Trim	2010,0140	CS	NO, YES	VNAP	CONF
Configuration Information	2010,0150	ST	L=1, L=V	ALWAYS	CONF

**Table 29: Basic Film Box Relationship Module**

Attribute Name	Tag	VR	Value	Presence of Value	Source
Referenced Film Session Sequence	2010,0500	SQ		ALWAYS	AUTO
>Referenced SOP Class UID	0008,1150	UI	UID of Parent Film Session	ALWAYS	AUTO
>Referenced SOP Instance UID	0008,1155	UI		ALWAYS	AUTO
Referenced Presentation LUT Sequence	2050,0500	SQ		ANAP	AUTO
> Referenced SOP Class UID	0008,1150	UI	UID of Parent LUT Presentation	ALWAYS	AUTO
> Referenced SOP Instance UID	0008,1155	UI		ALWAYS	AUTO

The behavior on successful and unsuccessful transfer is given in the table below.

**Table 30: DICOM Command Response Status Handling Behavior for Basic Film Box N-CREATE**

Service Status	Further Meaning	Error Code	Behavior
Success	Film Box successfully created	0000	The print job continues.
Warning	Requested Min Density or Max Density outside of Printer's operating Range	B605	The print job continues and the warning is logged.
Failure	There is an existing Film Box that has not been printed	C616	The print job is marked as failed and the reason is logged.



N-ACTION DIMSE does not create any Data Set Attributes.  
The behavior on successful and unsuccessful transfer is given in the table below.

**Table 31: DICOM Command Response Status Handling Behavior for Basic Film Box N-ACTION**

Service Status	Further Meaning	Error Code	Behavior
Success	Film accepted for printing	0000	The print job continues.
Warning	Film Box SOP Instance Hierarchy does not contain Image Box SOP Instances	B603	The print job continues and the warning is logged and reported to the user.
	Image Size is larger than Image Box Size – The Image has been de-magnified	B604	The print job continues and the warning is logged and reported to the user.
	Image Size is larger than Image Box Size – The Image has been cropped to fit	B609	The print job continues and the warning is logged and reported to the user.
	Image Size or combined Print Image Size is larger than Image Box Size – The Image or combined Print Image has been decimated to fit	B60A	The print job continues and the warning is logged and reported to the user.
Failure	Unable to create Print Job SOP Instance – Print Queue is full	C602	The print job is marked as failed and the reason is logged and reported to the user.
	Image Size is larger than Image Box Size	C603	The print job is marked as failed and the reason is logged and reported to the user.
	Combined Print Image Size is larger than Image Box Size	C613	The print job is marked as failed and the reason is logged and reported to the user.

#### 4.2.1.3.5.6 SOP Specific Conformance Basic Grayscale Image Box SOP Class

The Printer process conforms to the Basic Grayscale Image Box Sop Class.  
The following DIMSE service element is supported:

#### N-SET

The following table lists the supported attributes for the N-SET DIMSE

**Table 32: Basic Grayscale Image Box SOP Class - N-SET-RQ - Pixel Presentation Module**

Attribute Name	Tag	VR	Value	Presence of Value	Source
Image Position	2020,0010	US	1	ALWAYS	AUTO
Polarity	2020,0020	CS	NORMAL	ALWAYS	AUTO
Basic Grayscale Image Sequence	2020,0110	SQ		ALWAYS	AUTO
>Samples per Pixel	0028,0002	US	1	ALWAYS	AUTO
>Photometric Interpretation	0028,0004	CS	MONOCHROME2	ALWAYS	AUTO
>Rows	0028,0010	US		ALWAYS	IMPL
>Columns	0028,0011	US		ALWAYS	IMPL
>Bits Allocated	0028,0100	US	8, 16	ALWAYS	AUTO
>Bits Stored	0028,0101	US	8,12	ALWAYS	IMPL
>High Bit	0028,0102	US	7,11	ALWAYS	AUTO
>Pixel Representation	0028,0103	US	0	ALWAYS	AUTO
>Pixel Data	7FE0,0010	OB/OW		ALWAYS	AUTO

The behavior on successful and unsuccessful transfer is given in the table below.

**Table 33: DICOM Command Response Status Handling Behavior for Basic Grayscale Image Box N-SET**

Service Status	Further Meaning	Error Code	Behavior
Success	Image successfully stored in Image Box	0000	The print job continues.
Warning	Image Size is larger than Image Box Size – The Image has been de-magnified	B604	The print job continues and the warning is logged and reported to the user.
	Requested Min Density or Max Density outside of Printer's operating Range	B605	The print job continues and the warning is logged and reported to the user.
	Image Size is larger than Image Box Size – The Image has been cropped to fit	B609	The print job continues and the warning is logged and reported to the user.
	Image Size or combined Print Image Size is larger than Image Box Size – The Image or combined Print Image has been decimated to fit	B60A	The print job continues and the warning is logged and reported to the user.
Error	Image Size is larger than Image Box Size	C603	The print job is marked as failed and the reason is logged and reported to the user
	Insufficient Memory in Printer to store the Image	C605	The print job is marked as failed and the reason is logged and reported to the user
	Combined Print Image Size is larger than Image Box Size	C613	The print job is marked as failed and the reason is logged and reported to the user

#### 4.2.1.3.5.7 SOP Specific Conformance Basic Color Image Box SOP Class

The Printer process conforms to the Basic Color Image Box Sop Class.  
The following DIMSE service element is supported:

#### N-SET

The following table lists the supported attributes for the N-SET DIMSE

**Table 34: Basic Color Image Box SOP Class - N-SET-RQ - Pixel Presentation Module**

Attribute Name	Tag	VR	Value	Presence of Value	Source
Image Position	2020,0010	US	1	ALWAYS	AUTO
Polarity	2020,0020	CS	NORMAL	ALWAYS	AUTO
Basic Color Image Sequence	2020,0111	SQ		ALWAYS	AUTO
>Samples per Pixel	0028,0002	US	3	ALWAYS	AUTO
>Photometric Interpretation	0028,0004	CS	RGB	ALWAYS	AUTO
>Planar Configuration	0028,0006	US	0,1	ALWAYS	IMPL
>Rows	0028,0010	US		ALWAYS	IMPL
>Columns	0028,0011	US		ALWAYS	IMPL
>Bits Allocated	0028,0100	US	8	ALWAYS	AUTO
>Bits Stored	0028,0101	US	8	ALWAYS	IMPL
>High Bit	0028,0102	US	7	ALWAYS	AUTO
>Pixel Representation	0028,0103	US	0	ALWAYS	AUTO
>Pixel Data	7FE0,0010	OW		ALWAYS	AUTO

The behavior on successful and unsuccessful transfer is given in the table below.

**Table 35: DICOM Command Response Status Handling Behavior for Basic Color Image Box N-SET**

Service Status	Further Meaning	Error Code	Behavior
Success	Image successfully stored in Image Box	0000	The print job continues.
Warning	Image Size is larger than Image Box Size – The Image has been de-magnified	B604	The print job continues and the warning is logged and reported to the user.
	Requested Min Density or Max Density outside of Printer's operating Range	B605	The print job continues and the warning is logged and reported to the user.
	Image Size is larger than Image Box Size – The Image has been cropped to fit	B609	The print job continues and the warning is logged and reported to the user.
	Image Size or combined Print Image Size is larger than Image Box Size – The Image or combined Print Image has been decimated to fit	B60A	The print job continues and the warning is logged and reported to the user.
Error	Image Size is larger than Image Box Size	C603	The print job is marked as failed and the reason is logged and reported to the user.
	Insufficient Memory in Printer to store the Image	C605	The print job is marked as failed and the reason is logged and reported to the user.
	Combined Print Image Size is larger than Image Box Size	C613	The print job is marked as failed and the reason is logged and reported to the user.

**4.2.1.3.5.8 SOP Specific Conformance Presentation LUT SOP Class**

The Printer process conforms to the Presentation LUT SOP Class.

The following DIMSE service element is supported:

**N-CREATE**

The following table lists the supported attributes for the N-CREATE DIMSE

**Table 36: Presentation LUT Module**

Attribute Name	Tag	VR	Value	Presence of Value	Source
Presentation LUT Shape	2050,0020	CS	IDENTITY	ALWAYS	AUTO

The behavior on successful and unsuccessful transfer is given in the table below.

**Table 37: DICOM Command Response Status Handling Behavior for Presentation LUT N-CREATE**

Service Status	Further Meaning	Error Code	Behavior
Success	Presentation LUT successfully created	0000	The print job continues.
Warning	Requested Min Density or Max Density outside of printer's operating range. The printer will use its respective minimum or maximum density value instead.	B605	The print job continues and the warning is logged.

The N-EVENT-REPORT of the Printer SOP Class is summarized in Table below.

**Table 38: DICOM Command Response Status Handling Behavior for Printer N-EVENT-REPORT**

Service Status	Further Meaning	Error Code	Behavior
Normal	Successful operation	0000	The print job is marked as completed.
Warning	(any warning)	xxxx	The print job is marked as completed and the warning is logged and reported to the user.
Failure	(any failure)	xxxx	The print job is marked as failed and the reason is logged and reported to the user

*Note: ELEVA EDI will ignore the contents of these events. However, the printer status is polled via a separate association.*

The behavior of the AE during communication failure is summarized in Table 39.

**Table 39: DICOM Command Communication Failure Behavior**

Exception	Behavior
ARTIM Time-out	Print job fails.
Reply Time-out	The association is released.
Association Time-out SCU	The association is released.
Association aborted	The Print job is marked as failed. The reason is logged and reported to the user.

#### 4.2.1.3.6 Request Printer Status

##### 4.2.1.3.6.1 Description and Sequencing of Activities

The RWA

Request Printer Status involves the request for the printer status of the configured Print Management SCP's (i.e. printers).

The ELEVA EDI ViewForum AE will periodically request the printer status. If an association already exists for a print job (RWA Print Images) then the ELEVA EDI ViewForum AE shall use this association, otherwise a new association shall be initiated.

The status codes as returned by the printer shall be logged for service purposes and shall not be shown on the GUI.

The Printer Status Tool may be used to reveal the received printer status.

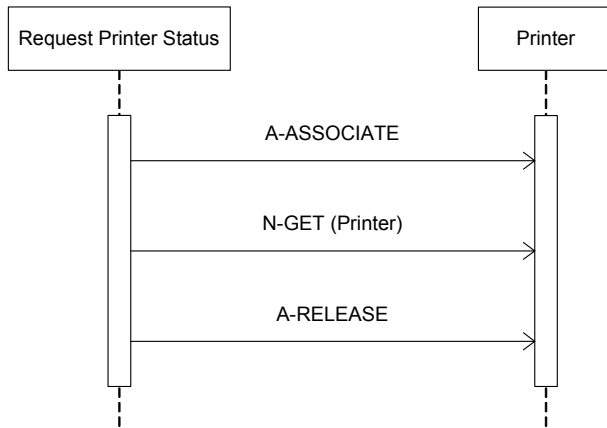

**Figure 10: Sequencing of RWA Request Printer Status**

**4.2.1.3.6.2 Proposed Presentation Contexts**

Each time an association is initiated, the association initiator proposes a number of Presentation Contexts to be used on that association. In this subsection, the Presentation Contexts proposed by the ELEVA EDI ViewForum AE for Request Printer Status are defined in Table 40.

**Table 40: Proposed Presentation Contexts for Request Printer Status**

Presentation Context Table					
Abstract Syntax		Transfer Syntax		Role	Extended Negotiation
Name	UID	Name List (note)	UID List		
Printer	1.2.840.10008.5.1.1.16	ILE ELE EBE	1.2.840.10008.1.2 1.2.840.10008.1.2.1 1.2.840.10008.1.2.2	SCU	None

*Note: For performance reasons the ELE transfer syntax is preferred and shall be chosen in case multiple Transfer Syntaxes are accepted in the Association Acceptance*

**4.2.1.3.6.3 SOP Specific Conformance for the Printer SOP Class**

The ELEVA EDI ViewForum AE provides standard conformance to the Printer SOP class.

All details regarding the specific conformance, including response behavior to all status codes, both from an application level and communication errors are provided in Table 41.

**Table 41: DICOM Command Response Status Handling Behavior**

Service Status	Further Meaning	Error Code	Behavior
Success	Matching is complete	0000	The print job continues.
Warning	(any warning)	xxxx	The print job continues and the warning is logged and reported to the user.
Error	(any failure)	xxxx	The print job is marked as failed. The reason is logged and reported to the user.

The behavior of the AE during communication failure is summarized in Table 42.

**Table 42: DICOM Command Communication Failure Behavior**

Exception	Behavior
ARTIM Timeout	Print job fails.
Reply Time-out	The association is released.
Association Time-out SCU	The association is released.
Association aborted	The print job is marked as failed. The reason is logged and reported to the user.

#### 4.2.1.4 Association Acceptance Policy

ELEVA EDI ViewForum AE shall accept Associations for the following purposes:

- To allow remote applications to verify application level communication with ELEVA EDI ViewForum AE; ref. section 4.2.1.4.1 Request Verification.
- To allow remote applications to store images in the ELEVA EDI ViewForum AE database (i.e. image import); ref. section 4.2.1.4.2 Import Images.
- To allow remote applications to query the ELEVA EDI (Ditto) database; ref. section 4.2.1.4.3 Query Local Images.
- To allow remote applications to retrieve images from the ELEVA EDI ViewForum AE ELEVA EDI (Ditto) database; ref. section 4.2.1.4.4 Retrieve Local Images.

The ELEVA EDI ViewForum AE shall reject association requests from unknown applications, i.e. applications that offer an unknown **“calling AE title”**. An application is known if – and only if – it is defined during configuration of the ELEVA EDI ViewForum AE system.

The ELEVA EDI ViewForum AE shall reject association requests from applications that do not address the ELEVA EDI ViewForum AE, i.e. applications that offer a wrong **“called AE title”**.

The ELEVA EDI ViewForum AE title is defined during configuration of the ELEVA EDI ViewForum AE system.

##### 4.2.1.4.1 Request Verification

###### 4.2.1.4.1.1 Description and Sequencing of Activities

The ELEVA EDI ViewForum AE shall accept associations from systems that wish to verify application level communication using the C-ECHO command.

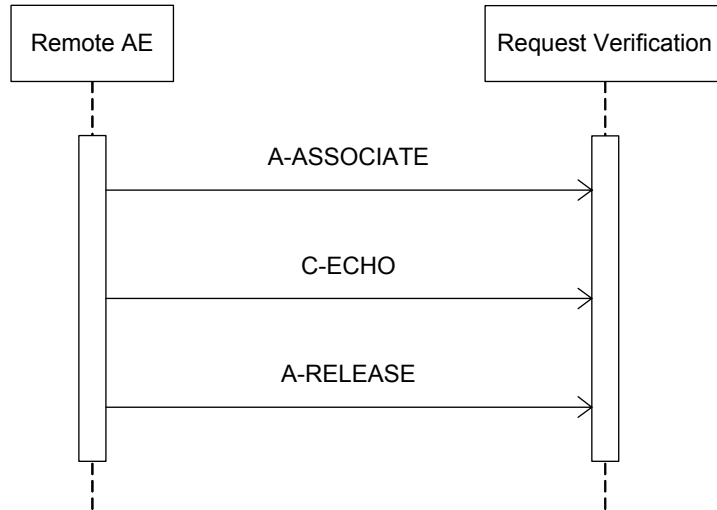

**Figure 11: Sequencing of RWA Request Verification**

**4.2.1.4.1.2 Accepted Presentation Contexts**

The ELEVA EDI ViewForum AE shall be able to accept the presentation contexts as specified in the next table.

**Table 43: Acceptable Presentation Contexts for Request Verification**

Presentation Context Table					
Abstract Syntax		Transfer Syntax		Role	Extended Negotiation
Name	UID	Name List	UID List		
Verification	1.2.840.10008.1.1	ILE ELE EBE	1.2.840.10008.1.2 1.2.840.10008.1.2.1 1.2.840.10008.1.2.2	SCP	None

For performance reasons the ELE transfer syntax is preferred and shall be chosen in case multiple Transfer Syntaxes are proposed in the Association Negotiation.

The ELEVA EDI ViewForum AE shall accept all contexts in the intersection of the proposed and acceptable Presentation Contexts. This means that the ELEVA EDI ViewForum AE accepts multiple proposed Presentation Contexts with the same SOP class but different Transfer Syntaxes.

There is no check for duplicate contexts, and these will therefore be accepted.

**4.2.1.4.1.3 SOP Specific Conformance for C-ECHO SOP Class**

The ELEVA EDI ViewForum AE provides standard conformance to the Verification service class.

The behavior of an Application Entity shall be summarized as shown in Table 44. The standard as well as the manufacturer specific status codes and their corresponding behavior shall be specified.

**Table 44: Verification C-ECHO Response Status Handling Behavior**

Service Status	Further Meaning	Error Code	Behavior
N/A			

**4.2.1.4.2 Import Images**

**4.2.1.4.2.1 Description and Sequencing of Activities**

The ELEVA EDI ViewForum AE shall accept associations from systems that wish to store images in the ELEVA EDI ViewForum AE database using the C-STORE command.

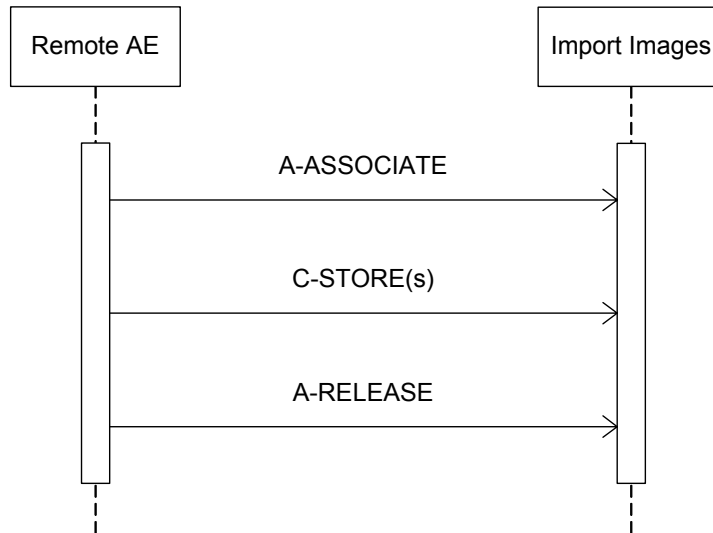

**Figure 12: Sequencing of RWA Import Images**



#### 4.2.1.4.2.2 Accepted Presentation Contexts

The ELEVA EDI ViewForum AE shall be able to accept the presentation contexts as specified in the next table.

**Table 45: Acceptable Presentation Contexts for Import Images**

Presentation Context Table					
Abstract Syntax		Transfer Syntax		Role	Extended Negotiation
Name	UID	Name List (note)	UID List		
Computed Radiography Image Storage	1.2.840.10008.5.1.4.1.1.1	ILE ELE EBE	1.2.840.10008.1.2 1.2.840.10008.1.2.1 1.2.840.10008.1.2.2	SCP	None
Digital X-Ray Image Storage – for Presentation	1.2.840.10008.5.1.4.1.1.1.1	ILE ELE EBE	1.2.840.10008.1.2 1.2.840.10008.1.2.1 1.2.840.10008.1.2.2	SCP	None
CT Image Storage	1.2.840.10008.5.1.4.1.1.2	ILE ELE EBE	1.2.840.10008.1.2 1.2.840.10008.1.2.1 1.2.840.10008.1.2.2	SCP	None
MR Image Storage	1.2.840.10008.5.1.4.1.1.4	ILE ELE EBE	1.2.840.10008.1.2 1.2.840.10008.1.2.1 1.2.840.10008.1.2.2	SCP	None
Secondary Capture Image Storage	1.2.840.10008.5.1.4.1.1.7	ILE ELE EBE	1.2.840.10008.1.2 1.2.840.10008.1.2.1 1.2.840.10008.1.2.2	SCP	None
Grayscale Softcopy Presentation State Storage	1.2.840.10008.5.1.4.1.1.11.1	ILE ELE EBE	1.2.840.10008.1.2 1.2.840.10008.1.2.1 1.2.840.10008.1.2.2	SCP	None
X-Ray Angiographic Image Storage	1.2.840.10008.5.1.4.1.1.12.1	ILE ELE EBE	1.2.840.10008.1.2 1.2.840.10008.1.2.1 1.2.840.10008.1.2.2	SCP	None
X-Ray Radiofluoroscopic Image Storage	1.2.840.10008.5.1.4.1.1.12.2	ILE ELE EBE	1.2.840.10008.1.2 1.2.840.10008.1.2.1 1.2.840.10008.1.2.2	SCP	None
Specialized X-Ray	1.3.46.670589.2.3.1.1	ILE ELE EBE	1.2.840.10008.1.2 1.2.840.10008.1.2.1 1.2.840.10008.1.2.2	SCP	None
CX Image	1.3.46.670589.2.4.1.1	ILE ELE EBE	1.2.840.10008.1.2 1.2.840.10008.1.2.1 1.2.840.10008.1.2.2	SCP	None
3D Volume Storage	1.3.46.670589.5.0.1.1	ILE ELE EBE	1.2.840.10008.1.2 1.2.840.10008.1.2.1 1.2.840.10008.1.2.2	SCP	None
3D Volume Object Storage	1.3.46.670589.5.0.2.1	ILE ELE EBE	1.2.840.10008.1.2 1.2.840.10008.1.2.1 1.2.840.10008.1.2.2	SCP	None
Surface Storage	1.3.46.670589.5.0.3.1	ILE ELE EBE	1.2.840.10008.1.2 1.2.840.10008.1.2.1 1.2.840.10008.1.2.2	SCP	None
MR cardio Storage	1.3.46.670589.5.0.8.1	ILE ELE EBE	1.2.840.10008.1.2 1.2.840.10008.1.2.1 1.2.840.10008.1.2.2	SCP	None
CT Synthetic Image	1.3.46.670589.5.0.9	ILE ELE EBE	1.2.840.10008.1.2 1.2.840.10008.1.2.1 1.2.840.10008.1.2.2	SCP	None
MR Synthetic Image	1.3.46.670589.5.0.10	ILE ELE EBE	1.2.840.10008.1.2 1.2.840.10008.1.2.1 1.2.840.10008.1.2.2	SCP	None

Presentation Context Table					
Abstract Syntax		Transfer Syntax		Role	Extended Negotiation
Name	UID	Name List (note)	UID List		
MR Cardio Analysis Storage	1.3.46.670589.5.0.11.1	ILE ELE EBE	1.2.840.10008.1.2 1.2.840.10008.1.2.1 1.2.840.10008.1.2.2	SCP	None
CX Synthetic Image	1.3.46.670589.5.0.12	ILE ELE EBE	1.2.840.10008.1.2 1.2.840.10008.1.2.1 1.2.840.10008.1.2.2	SCP	None
Perfusion	1.3.46.670589.5.0.13	ILE ELE EBE	1.2.840.10008.1.2 1.2.840.10008.1.2.1 1.2.840.10008.1.2.2	SCP	None
Perfusion Analysis	1.3.46.670589.5.0.14	ILE ELE EBE	1.2.840.10008.1.2 1.2.840.10008.1.2.1 1.2.840.10008.1.2.2	SCP	None
Ultra sound Multi-frame Image Storage	1.2.840.10008.5.1.4.1.1.3.1	ILE ELE EBE JPEG Baseline (Note 1)	1.2.840.10008.1.2 1.2.840.10008.1.2.1 1.2.840.10008.1.2.2 1.2.840.10008.1.2.4 .50	SCP	None
Ultra sound Image Storage	1.2.840.10008.5.1.4.1.1.6.1	ILE ELE EBE JPEG Baseline (Note 1)	1.2.840.10008.1.2 1.2.840.10008.1.2.1 1.2.840.10008.1.2.2 1.2.840.10008.1.2.4 .50	SCP	None

*For performance reasons the ELE transfer syntax is preferred and shall be chosen in case multiple Transfer Syntaxes are proposed in the Association Negotiation*

*Note 1 : Only for Photometric Interpretation of RGB and YBR\_FULL\_422. Therefore JPEG Baseline transfer syntax may NOT be configured for SCU systems that are capable of handling storage of monochrome images too.*

The ELEVA EDI ViewForum AE shall accept all contexts in the intersection of the proposed and acceptable Presentation Contexts. This means that the ELEVA EDI ViewForum AE accepts multiple proposed Presentation Contexts with the same SOP class but different Transfer Syntaxes.

There is no check for duplicate contexts, and these will therefore be accepted.

#### 4.2.1.4.2.3 SOP Specific Conformance for SOP Classes

The ELEVA EDI ViewForum AE provides standard level 1 (Base) conformance to the Storage service class.

If the ELEVA EDI ViewForum AE imports an image and during the association negotiation the Presentation State SOP class was not negotiated, then the ELEVA EDI ViewForum AE creates a Presentation State instance for the imported image.

The following table gives an overview of the image formats that can be viewed or stored.

**Table 46: Support for Photometric Interpretation**

Photometric Interpretation	Storage	Viewing
MONOCHROME1	Yes	Yes
MONOCHROME2	Yes	Yes
RGB	Yes	Yes
YBR_FULL	Yes	No
YBR_FULL_422	Yes *	Yes *
YBR_PARTIAL_422	Yes	No
PALETTE COLOR	Yes	No
Other	Yes	No

Note: \* is an Compressed YBR\_FULL\_422 images received per JPEG Baseline transfer shall be stored (and consequently viewed) as RGB images.

If the ELEVA EDI ViewForum AE receives improper DICOM, ELEVA EDI ViewForum AE tries as much as possible to make it proper DICOM (if configured to do so). But ELEVA EDI ViewForum AE also tries to remain as transparent as possible on images; on export the images must be changed only to such extent as really necessary. Therefore it is not guaranteed that all DICOM violations of incoming images are repaired (e.g. enumerated values are not changed). Thus improper DICOM import may result in improper DICOM export from the ELEVA EDI ViewForum AE (no checks are available for incorrect UID's, Date/Time formats, etc.).

ELEVA EDI ViewForum AE stores all additional standard, private and retired attributes in received images. Retrieval of these attributes VR's is only possible (by means of a C-STORE) if the following conditions are satisfied:

- The image was encoded (when ELEVA EDI ViewForum AE was C-STORE SCP) using one of the explicit value representations; or
- The image was encoded (when ELEVA EDI ViewForum AE was C-STORE SCP) using implicit value representation and the destination (i.e. a remote C-STORE SCP) has accepted implicit value representation as the only transfer syntax applicable to the storage SOP class of the image (with ELEVA EDI ViewForum AE as C-STORE SCU).

Otherwise the VR shall be set to Unknown (UN).

**Important implementation remarks and restrictions:**

- The DICOM standard does not guarantee that the advanced ELEVA EDI ViewForum AE applications can process the received images. This depends on the presence and consistency of a set of attributes in these images. The conditions for running the ELEVA EDI ViewForum AE applications shall be specified in separate Annexes.
- See section 8.1.3, Coerced / Modified fields, for details on Coerced and Modified Attributes.
- When the location of a Graphic or Text Annotation is specified relatively with regards to the displayed area.  
(i.e. DICOM attribute: Bounding Box Annotation Units (0070,0003), Anchor Point Annotation Units (0070,0004) or Graphic Annotation Units (0070,0005) equals "DISPLAY"), the annotation is not displayed.

- Areas occluded by shutter are always black in ELEVA EDI ViewForum AE, whereas it is possible to want it to be white in DICOM.
- On the export of imported images the ELEVA EDI ViewForum AE adds private attributes to the image.
- ELEVA EDI ViewForum AE does NOT support IVUS (IntraVascular UltraSound) Ultrasound images.
- If during the image transfer the Presentation States instances are transferred before the images the ELEVA EDI ViewForum AE changes the content of the Images:

Following attributes present in the original images and are **removed by ELEVA EDI ViewForum AE:**

- (0008,1120) Referenced Patient Sequence.
- (0008,1032) Procedure Code Sequence.
- (0040,0260) Performed Protocol Code Sequence.
- (0040,0275) Requested Attributes Sequence.
- (0040,0280) Comments on the Performed Procedure Step.

Following attributes with a value in the original images, are **set to a zero length** value in the exported images:

- (0010,0032) Patient's Birth Date
- (0010,1000) Other Patient's ID's
- (0010,1001) Other Patient's Names
- (0010,2160) Ethnic Group
- (0010,4000) Patient Comments
- (0010,1010) Patient's Age
- (0010,1020) Patient's Size
- (0010,1030) Patient's Weight
- (0010,2180) Occupation
- (0010,21B0) Additional Patient's History

Support for Additional Standard, Private and Retired attributes:

ELEVA EDI ViewForum AE stores all Additional Standard, Private and Retired attributes in received images.

Retrieval of these attributes is only possible (by means of a C-MOVE request) if the following conditions are satisfied:

- The image was encoded (when ELEVA EDI ViewForum AE was C-STORE SCP) using one of the explicit value representations or
- The image was encoded (when ELEVA EDI ViewForum AE was C-STORE SCP) using implicit value representation and the move destination (i.e. a C-STORE Service Class Provider) has accepted implicit value representation as the only transfer syntax applicable to the storage SOP class of the image (when ELEVA EDI ViewForum AE is C-STORE SCU).

The response status behavior of the ELEVA EDI ViewForum AE is as described in Table 47.

The standard as well as the manufacturer specific status codes and their corresponding behavior shall be specified.

**Table 47: Storage C-STORE Response Status Handling Behavior**

Service Status	Further Meaning	Error Code	Behavior
Success	Storage is complete	0000	The image(s) shall be stored in the ELEVA EDI ViewForum AE database.
Refused	Out of Resources	A700	The ELEVA EDI ViewForum AE database is full – recovery from this condition is left to the SCU. ELEVA EDI ViewForum AE shall send a notification, log the condition, and abort the association.
Error	Data set does not match SOP class	A900	The SOP class of the image(s) does not match the negotiated abstract syntax. ELEVA EDI ViewForum AE shall send a notification, log the condition, and abort the association.
	Cannot understand	C000	The image(s) cannot be parsed. ELEVA EDI ViewForum AE shall send a notification, log the condition, and abort the association.
Warning	Coercion of Data Elements	B000	N/A
	Elements discarded	B006	N/A
	Data set does not match SOP class	B007	N/A

**4.2.1.4.3 Query Local Images**

**4.2.1.4.3.1 Description and Sequencing of Activities**

The ELEVA EDI ViewForum AE shall accept associations from systems that wish to query the ELEVA EDI ViewForum AE database using the C-FIND command.

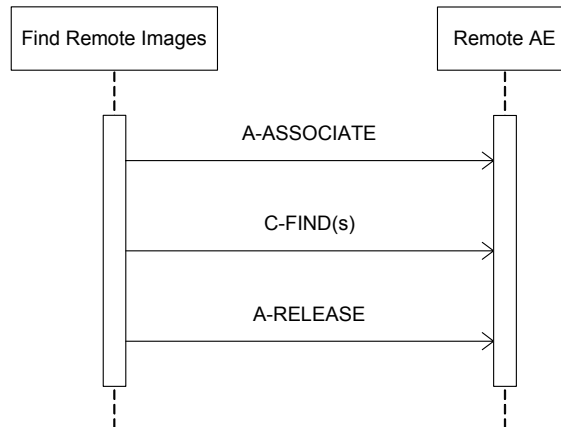

**Figure 13: Sequencing of RWA Query Local Images**

#### 4.2.1.4.3.2 Accepted Presentation Contexts

The ELEVA EDI ViewForum AE shall be able to accept the presentation contexts as SCP, as specified in the next table.

**Table 48: Acceptable Presentation Contexts for Query Local Images**

Presentation Context Table					
Abstract Syntax		Transfer Syntax		Role	Extended Negotiation
Name	UID	Name List (note)	UID List		
Patient Root Query /Retrieve Information Model - FIND	1.2.840.10008.5.1.4.1.2.1.1	ILE ELE EBE	1.2.840.10008.1.2 1.2.840.10008.1.2.1 1.2.840.10008.1.2.2	SCP	None
Study Root Query /Retrieve Information Model - FIND	1.2.840.10008.5.1.4.1.2.2.1	ILE ELE EBE	1.2.840.10008.1.2 1.2.840.10008.1.2.1 1.2.840.10008.1.2.2	SCP	None
Patient/Study Only Query/Retrieve Information Model - FIND	1.2.840.10008.5.1.4.1.2.3.1	ILE ELE EBE	1.2.840.10008.1.2 1.2.840.10008.1.2.1 1.2.840.10008.1.2.2	SCP	None

*Note :* For performance reasons the ELE transfer syntax is preferred and shall be chosen in case multiple Transfer Syntaxes are proposed in the Association Negotiation

The ELEVA EDI ViewForum AE shall accept all contexts in the intersection of the proposed and acceptable Presentation Contexts. This means that the ELEVA EDI ViewForum AE accepts multiple proposed Presentation Contexts with the same SOP class but different Transfer Syntaxes.

There is no check for duplicate contexts, and these will therefore be accepted.

#### 4.2.1.4.3.3 SOP Specific Conformance for SOP Classes

The ELEVA EDI ViewForum AE provides standard conformance to the Query/Retrieve service class. Relational queries are not supported. The ELEVA EDI ViewForum AE shall handle simultaneous C-FIND requests simultaneously.

The ELEVA EDI (Ditto) database distinguishes two patients with the same Patient ID but different Patient's Name or Patient's Birth Date. However, the DICOM Query/Retrieve service class has Patient ID as a unique key at Patient level, and thus two patients with the same Patient ID cannot be distinguished via a standard DICOM Query.

The following Query Keys shall be supported:

**Table 49: Supported Query Keys**

Query Level	Query Key		Standard Matching
	Name	Tag	
Patient	Patient's Name	(0010,0010)	Yes
	Patient ID	(0010,0020)	Yes
Study	Study Date	(0008,0020)	Yes
	Study Time	(0008,0030)	Yes
	Accession Number	(0008,0050)	Yes
	Study Instance UID	(0020,000D)	Yes
	Study ID	(0020,0010)	Yes
Series	Modality	(0008,0060)	Yes
	Series Instance UID	(0020,000E)	Yes
	Series Number	(0020,0011)	Yes
Image	SOP Instance UID	(0008,0018)	Yes
	Instance Number	(0020,0013)	Yes

When querying optional keys the ELEVA EDI ViewForum AE will respond successfully for available keys if queried per **universal matching**; otherwise it will respond with warning.

Note that when querying optional keys with **non-universal matching** the ELEVA EDI ViewForum AE will return information using universal matching for those keys.

Note that when a query is performed per Patient/Study Only Query/Retrieve Information Model SOP class on Patient Level, the ELEVA EDI ViewForum AE always sends back the attribute "Patient's Name" (0010,0010), also when it was not requested.

The response status behavior of the ELEVA EDI ViewForum AE is as described in Table 50. The standard as well as the manufacturer specific status codes and their corresponding behavior shall be specified.

**Table 50: Query/Retrieve C-FIND Response Status Handling Behavior**

Service Status	Further Meaning	Error Code	Behavior
Success	Matching is complete	0000	The C-FIND request handling is completed, no more C-FIND responses are sent.
Refused	Out of Resources	A700	N/A
Failed	Identifier does not match SOP class	A900	N/A
	Unable to process	C000	The C-FIND request cannot be parsed. ELEVA EDI (Ditto) ViewForum AE logs the reason.
Cancel	Matching terminated due to Cancel Request	FE00	The C-FIND request is cancel, no more C-FIND responses are sent.
Pending	Matches are continuing – Current match is supplied and any optional keys were supported in the same manner as required keys	FF00	The C-FIND responses are continuing.
	Matches are continuing – Warning that one or more optional keys were not supported for existence and/or matching for this identifier	FF01	The C-FIND responses are continuing.

**4.2.1.4.4 Retrieve Local Images**

**4.2.1.4.4.1 Description and Sequencing of Activities**

The ELEVA EDI ViewForum AE shall accept associations from systems that wish to retrieve images from the ELEVA EDI ViewForum AE database using the C-MOVE command.

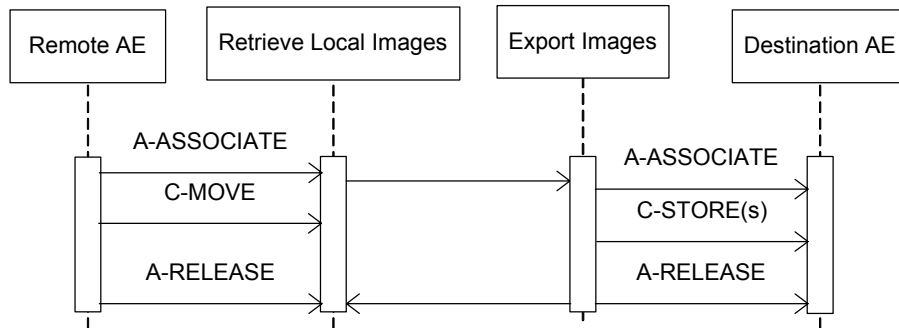

**Figure 14: Sequencing of RWA Retrieve Local Images**

After RWA Retrieve Local Images the RWA Export Images is started; the RWA Export Images is described in section 4.2.1.3.1.

**4.2.1.4.4.2 Accepted Presentation Contexts**

The ELEVA EDI ViewForum AE shall be able to accept the presentation contexts as specified in the next table.

**Table 51: Acceptable Presentation Contexts for Retrieve Local Images**

Presentation Context Table					
Abstract Syntax		Transfer Syntax		Role	Extended Negotiation
Name	UID	Name List (note)	UID List		
Patient Root Query /Retrieve Information Model - MOVE	1.2.840.10008.5.1.4.1.2.1.2	ILE ELE EBE	1.2.840.10008.1.2 1.2.840.10008.1.2.1 1.2.840.10008.1.2.2	SCU	None
Study Root Query /Retrieve Information Model - MOVE	1.2.840.10008.5.1.4.1.2.2.2	ILE ELE EBE	1.2.840.10008.1.2 1.2.840.10008.1.2.1 1.2.840.10008.1.2.2	SCU	None
Patient/Study Only Query/Retrieve Information Model - MOVE	1.2.840.10008.5.1.4.1.2.3.2	ILE ELE EBE	1.2.840.10008.1.2 1.2.840.10008.1.2.1 1.2.840.10008.1.2.2	SCU	None

Note : For performance reasons the ELE transfer syntax is preferred and shall be chosen in case multiple Transfer Syntaxes are proposed in the Association Negotiation



The ELEVA EDI ViewForum AE shall accept all contexts in the intersection of the proposed and acceptable Presentation Contexts. This means that the ELEVA EDI ViewForum AE accepts multiple proposed Presentation Contexts with the same SOP class but different Transfer Syntaxes.

There is no check for duplicate contexts, and these will therefore be accepted.

#### 4.2.1.4.4.3 SOP Specific Conformance for SOP Classes

The response status behavior of the ELEVA EDI ViewForum AE is as described in Table 52. The standard as well as the manufacturer specific status codes and their corresponding behavior shall be specified.

**Table 52: Query/Retrieve C-MOVE Response Status Handling Behavior**

Service Status	Further Meaning	Error Code	Behavior
Success	Sub-operations complete – No Failures	0000	The C-MOVE command has been completed.
Refused	Out of Resources – Unable to calculate number of matches	A701	N/A
	Out of Resources – Unable to perform Sub-operations	A702	N/A
	Move Destination unknown	A801	No C-STORE command will be sent. ELEVA EDI (Ditto) ViewForum AE logs the reason.
Failed	Identifier does not match SOP class	A900	N/A
	Unable to process	C000	The C-MOVE request cannot be parsed. No Store Command will be sent. ELEVA EDI (Ditto) ViewForum AE logs the reason.
Cancel	Sub-operations terminated due to Cancel Indication	FE00	The C-MOVE request is cancelled, no more C-MOVE responses are sent.
Warning	Sub-operations complete – One or more Failures	B000	N/A
Pending	Sub-operations are continuing	FF00	Approximately every 30 seconds to indicate progress.

## 4.2.2 ELEVA EXAMINATION CONTROL AE

The ELEVA Examination Control Application Entity (ELEVA EEC AE) provides Standard Conformance to the following DICOM 3.0 SOP classes as an SCU specified in the Table below.

### 4.2.2.1 Supported SOP Classes by the ELEVA EDI AE as SCU.

This Application Entity provides extended Standard Conformance to the SOP classes Specified in the next Table.

**Table 53: Query Supported SCU SOP Classes by the ELEVA Examination Control AE**

SOP Class Name	UID
Modality Worklist Information Model - FIND	1.2.840.10008.5.1.4.31
Modality Performed Procedure Step	1.2.840.10008.3.1.2.3.3

The ELEVA Examination Control Application Entity does not support DICOM 3.0 SOP classes as a SCP.

### 4.2.2.2 Association Policies

This section shall contain a description of the General Association Establishment and Acceptance policies of the AE.

#### 4.2.2.2.1 General

The ELEVA Examination Control offers unrestricted max. PDU size on associations initiated by ELEVA Examination Control. The PDU size is also configurable per remote station.

The DICOM standard application context shall be specified.

**Table 54: DICOM Application Context**

Application Context Name	1.2.840.10008.3.1.1.1
--------------------------	-----------------------

#### 4.2.2.2.2 Number of Associations

The maximum number of simultaneous associations is by default unlimited, but the maximum can be limited via the configuration repository.

#### 4.2.2.2.3 Asynchronous Nature

The ELEVA Examination Control does not support asynchronous operations and will not perform asynchronous window negotiation.

#### 4.2.2.2.4 Implementation Identifying Information

Following Implementation Class UID and Version Name are defined for the ELEVA Examination Control.

THE IMPLEMENTATION CLASS UID:	1.3.46.670589.30.1.1
THE IMPLEMENTATION VERSION NAME:	PMS_PA_1.0

#### 4.2.2.2.5 Association Acceptance Policy

The ELEVA Examination Control Application Entity does not handle incoming associations.

#### 4.2.2.2.6 Association Initiation Policy

For each request an association to the peer entity is established.

#### 4.2.2.3 Real – World Activity – Management Worklist (MWL) – FIND

##### 4.2.2.3.1 Association Real – World Activity

For each Broad or specific Worklist request, an association towards the Basic Worklist Management SCP is established and a C-FIND request is transmitted. The Broad query can be configured with a combination of the Matching Keys:

- Scheduled Station AE Title
- Scheduled Procedure Step Start Date
- Modality

Each of the matching keys is optional. The association will be closed on reception of the last C-FIND response. The Worklist Query result is displayed in the Patient List. The query is interruptible if it was triggered by the user.

##### 4.2.2.3.2 Description and Sequencing of Activities

This RWA may be initiated in two ways.

1. After clicking the Query Worklist button the ELEVA Examination Control AE shall request an association with the configured remote Basic Worklist Management SCP. When the association is accepted the ELEVA Examination Control AE shall send the Broad Query find request, wait for response, and then release the association.
2. After clicking the Patient Query button - entering and confirming the matching key values - the ELEVA Examination Control AE shall request an association with the configured remote Basic Worklist Management SCP. When the association is accepted the ELEVA Examination Control AE shall send the patient query find request, wait for response, and then release the association.

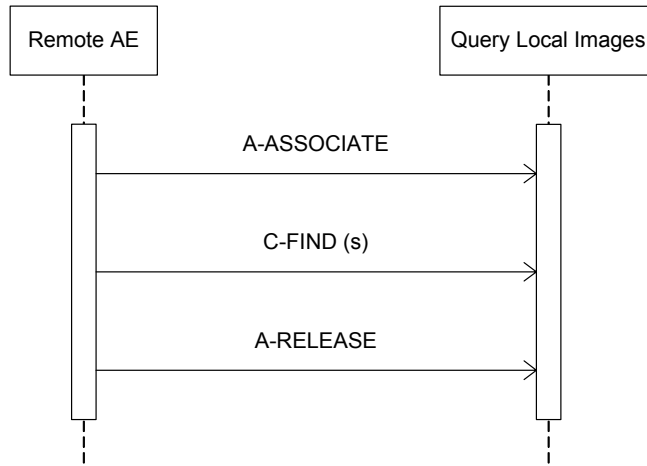

**Figure 15: Sequencing of RWA Query Worklist**

**4.2.2.3.3 SOP Specific Conformance – MWL-FIND**

By default, the patient/examination list update is performed by a “Broad” Query with pre-configured matching keys. This MWL query may be performed in the system background and may be disabled. The time interval between subsequent background queries is configurable. The Broad Query may also be issued by the operator and will be performed from the Patient List User interface.

The table below gives an overview of the Matching Keys for a Broad Query.

**Table 55: Matching Keys for Broad Query**

Attribute Name	Tag	Note
Scheduled Station AE Title	0040,0001	Configurable of: “ALL” or comma separated list of Application Entity names
Scheduled Procedure Step Start Date	0040,0002	Configurable of: “ALL”, “<Today”, “<Today + Tomorrow”, “<Today + Yesterday”
Modality (type)	0008,0060	“CR”, “OT”, “XA”, “RF”, “DX”, “US”

When Date matching is configured, the Date value is continuously generated from local system time, including a configurable nightshift tolerance in the morning hours taking the steps from “<Yesterday”. The modality type query may be used for environments that do not schedule per individual modality’s AE Title, but for a modality pool.

The optional Patient Based Worklist Query is typically triggered by operator action when a patient arrives at the system for examination. ELEVA Examination Control expects the operator to enter the value(s) of the search key(s).

The Table below gives an overview of the Matching Keys for a Patient Query

**Table 56: Matching Keys for Patient Query**

Matching Keys for Patient Query			
Attribute Name	Tag	Note	Wildcard Search ( using " * " only
Patient's Name	0010,0010	Identified from admission form.	Yes
Patient ID	0010,0020	Identified from admission form.	Yes
Accession Number	0008,0040	Identified from admission form.	Yes
Requested Procedure ID	0040,1001	Identified from admission form.	Yes
Scheduled Station AE Title	0040,0001		Yes
Scheduled Procedure Step Start Date	0040,0002	This key may be optionally (default: no) added by the system. Its value is (Configurable) one of: date of <today>, date of <today> and subsequent dates, date of prior to and incl. <today>	No

**Wildcard search (using " \* " only) is supported for:**

- "Patient's Name",
- "Patient ID",
- "Accession Number",
- "Requested Procedure ID", and
- "Scheduled Station AE Title".

The Patient Query can be cancelled after the user has pressed a "Cancel" Button on the User Interface. In this case the DICOM association will be aborted immediately. As the query is performed asynchronously, intermediate results are displayed in the meantime.

**4.2.2.3.3.1 Patient and Study Merge**

The ELEVA EDI looks in its internal database, of the ELEVA Examination Control, for a Study with the same Study Instance UID (0020,000D) as given in the Scheduled Procedure Step (SPS).

If a Study Instance UID match was not found, it looks for a Patient with the same Patient ID (0010,0020) as given in the Scheduled Procedure Step.

If no Patient match is found, a new Patient is created, using attributes from Scheduled Procedure Step.

If Patient with a matching Patient ID was found, attributes are updated for the internal Patient, based on the attributes as given in the Scheduled Procedure Step. A new Study with a Study Instance UID as given in the Scheduled Procedure Step is created.

If a Study Instance UID match was found, all Patient attributes as given in the Scheduled Procedure Step are updated in the internal database for the parent patient of this study. Study attributes are updated for the internal study based on the attributes as given in the Scheduled Procedure Step.

**4.2.2.3.3.2 Scheduled Procedure Step (= Examination) Merge**

If the internal database of the ELEVA EDI Examination Control contains no SPS with Scheduled Procedure Step ID (0040,0009) identifying an incoming Scheduled Procedure Step, it creates a new one and creates an corresponding Examination referencing this Scheduled Procedure Step ID.

If the internal database of the ELEVA EDI Examination Control contains already an SPS with the Scheduled Procedure Step ID (0040,0009) identifying an incoming Scheduled Procedure Step, the behaviour depends on the corresponding Examination state.

If the Examination is still “scheduled”, the SPS attributes are compared to the attributes sent with the most recent WLM query. If at least one attribute differs, the scheduled Examination is deleted and re-scheduled. Manual changes the user might have performed on this Examination are lost.

If the Examination has already started, no changes are performed, and the potential changes of the incoming Scheduled Procedure Step are disregarded.

**4.2.2.4 Modality Worklist Information Model – FIND SOP Class**

**Table 57: Modules of the Modality Worklist Information Model – FIND SOP Class**

Information Entity	Module Name	Usage
General	SOP Common Module	ALWAYS
Study	Scheduled Procedure Step Module	ALWAYS
	Requested Procedure Module	ALWAYS
	Imaging Service Request Module	ALWAYS
Visit	Visit Identification Module	ALWAYS
	Visit Status Module	ALWAYS
	Visit Relationship Module	EMPTY
	Visit Admission Module	NEVER
Patient	Patient Relationship Module	NEVER
	Patient Identification Module	ALWAYS
	Patient Demographic Module	ALWAYS
	Patient Medical Module	ALWAYS

**Table 58: MWL Inform. Model - FIND SOP Class - C-FIND-RQ – Sop Common Module**

Attribute Name	Tag	VR	Note
Specific Character Set	0008, 0005	CS	Configurable: Not queried, or queried as “ISO-IR 100”

**Table 59: MWL Inform. Model - FIND SOP Class - C-FIND-RQ – Patient Identifier Module**

Attribute Name	Tag	VR	Note
Patient's Name	0010,0010	PN	Displayed. Optional matching key in Patient Query
Patient ID	0010,0020	LO	Displayed. Optional matching key in Patient Query
Patient Other ID's	0010,1000	LO	Displayed.

**Table 60: MWL Inform. Model - FIND SOP Class - C-FIND-RQ – Patient Demographic Module**

Attribute Name	Tag	VR	Note
Patient's Birth Date	0010,0030	DA	Displayed. Used for calculation of Patient Type.
Patient's Sex	0010,0040	CS	Applied Value(s): F, M, O
Patient's Size	0010,1020	DS	Stored. Used for calculation of Patient Type.
Patient's Weight	0010,1030	DS	Stored. Used for calculation of Patient Type.
Ethnic Group	0010,2160	SH	Displayed.
Patient Data Confidentiality Constraint Description	0040,3001	LO	
Patient Comments	0010,4000	LT	Displayed.

**Table 61: MWL Inform. Model - FIND SOP Class - C-FIND-RQ – Patient Medical Module**

Attribute Name	Tag	VR	Note
Medical Alerts	0010,2000	LO	Displayed.
Contrast Allergies	0010,2110	LO	Displayed.
Additional Patient History	0010,21B0	LT	Displayed.
Pregnancy Status	0010,21C0	US	Displayed. Applied Value(s): 0001, 0002, 0003, 0004
Special Needs	0038,0050	LO	Stored
Patient State	0038,0500	LO	Stored

**Table 62: MWL Inform. Model - FIND SOP Class - C-FIND-RQ – Visit Status Module**

Attribute Name	Tag	VR	Note
Current Patient Location	0038,0300	LO	Stored.

**Table 63: MWL Inform. Model - FIND SOP Class - C-FIND-RQ – Schedule Procedure Step Module**

Attribute Name	Tag	VR	Note
Scheduled Procedure Step Sequence	0040,0100	SQ	
>Modality	0008,0060	CS	Stored. Optional matching key for Broad and Patient Query
> Requested Contrast Agent	0032,1070	LO	Stored.
>Scheduled AE Title	0040,0001	AE	Stored. Optional matching key for Broad and Patient Query
>Scheduled Procedure Step Start Date	0040,0002	DT	Stored. Displayed until Examination becomes in progress. Optional matching key for Broad and Patient Query
>Scheduled Procedure Step Start Time	0040,0003	TM	Stored. Displayed until Examination becomes in progress.
>Scheduled Procedure Step End Date	0040,0004	DT	
>Scheduled Procedure Step End Time	0040,0005	TM	
>Scheduled Performing Physician's Name	0040,0006	PN	Stored.
>Scheduled Procedure Step Description	0040,0007	LO	Stored. Displayed if configured as source item for code mapping.
>Scheduled Action Item Code Sequence	0040,0008	SQ	Stored. Displayed if configured as source item for code mapping.
>>Code Value	0008,0100	SH	Displayed.
>>Coding Scheme Designator	0008,0102	SH	Stored.
>>Coding Scheme Version	0008,0103	SH	Stored.
>>Code Meaning	0008,0104	LO	Stored.
>Scheduled Procedure Step ID	0040,0009	SH	Stored.
>Scheduled Station Name	0040,0010	SH	Stored.
>Scheduled Procedure Step Location	0040,0011	SH	Stored.
>Pre-Medication	0040,0012	LO	Stored.
>Scheduled Procedure Step Status	0040,0020	CS	Stored.
>Comments on the Scheduled Procedure Step	0040,0400	LT	Stored.

**Table 64: MWL Inform. Model - FIND SOP Class - C-FIND-RQ – Requested Procedure Module**

Attribute Name	Tag	VR	Note
Referenced Study Sequence	0008,1110	SQ	Stored.
>Referenced SOP Class UID	0008,1150	UI	Stored.
>Referenced SOP Instance UID	0008,1155	UI	Stored.
Study Instance UID	0020,000D	UI	Stored.
Requested Procedure Description	0032,1060	LO	Stored.
Requested Procedure Code Sequence	0032,1064	SQ	Stored.
>Code Value	0008,0100	SH	Stored. Displayed if configured as source item for code mapping.
>Coding Scheme Designator	0008,0102	SH	Stored.
>Coding Scheme Version	0008,0103	SH	Stored.
>Code Meaning	0008,0104	LO	Stored.
Requested Procedure ID	0040,1001	SH	Stored. Displayed if configured as source item for code mapping. Optional matching key for Patient Query
Patient Transport Arrangements	0040,1004	LO	Stored.
Names of Intended Recipients of Results	0040,1010	PN	Displayed.
Requested Procedure Comments	0040,1400	LT	Stored.



**Table 65: MWL Inform. Model - FIND SOP Class - C-FIND-RQ – Imaging Service Request Module**

Attribute Name	Tag	VR	Note
Accession Number	0008,0050	SH	Displayed. Optional matching key for Patient Query
Referring Physician's Name	0008,0090	PN	Displayed.
Requesting Physician	0032,1032	PN	Displayed.
Requesting Service	0032,1033	LO	Displayed.
Imaging Service Request Comments	0040,2400	LT	Stored.

**4.2.2.4.1.1 Proposed Presentation Contexts**

ELEVA Examination Control Application Entity (EEC AE) will propose the presentation contexts as given in the next table.

**Table 66: Proposed Presentation Contexts for DI ELEVA Examination Control MWL SCU**

Abstract Syntax	UID	Transfer Syntax	UID List	Role	Ext. Neg.
MWL-FIND	1.2.840.10008.5.1.4.31	ILE ELE EBE	1.2.840.10008.1.2 1.2.840.10008.1.2.1 1.2.840.10008.1.2.2	SCU	None

*Note: ELE is preferred*

**4.2.2.5 Real-World Activity –Modality Performed Procedure Step (MPPS)****4.2.2.5.1 Association Real – World Activity**

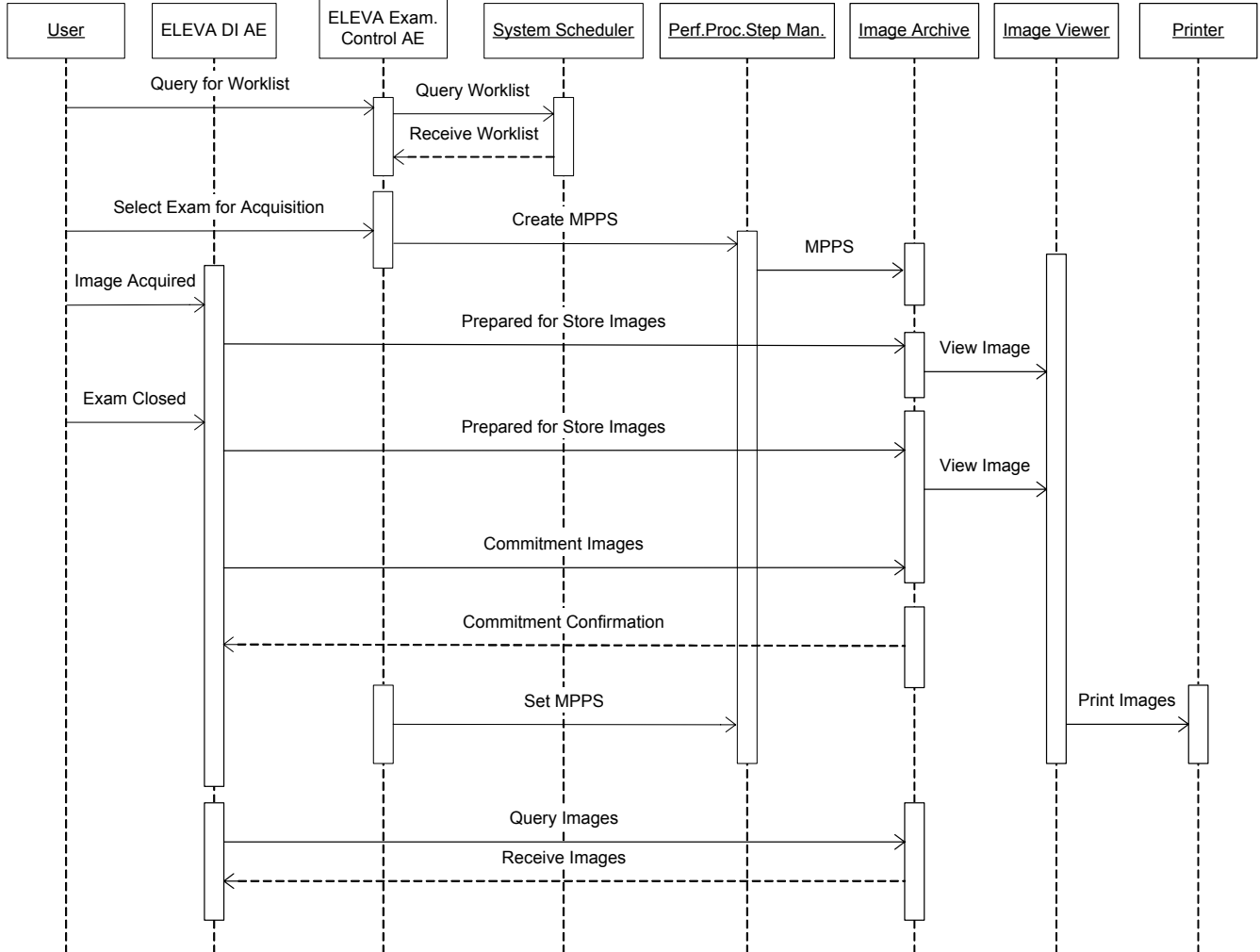

An ELEVA EDI “Examination” is regarded equivalent to a DICOM Procedure Step. It is scheduled or manually entered before an acquisition is taken, and performed by taking acquisitions.

If scheduled by the RIS, one Examination is the result of one Scheduled Procedure Step. Since an examination may not be re-opened after having been closed, and each examination workflow context is enclosed in one **MPPS**, one examination may result in 0:1 MPPS instances.

However, image archiving after the examination’s closure leads to 1:n MPPS instances per examination (append case).

An initial MPPS **IN PROGRESS** message with N-CREATE is sent once the first X-ray Radiation has been released. The system does not generate intermediate MPPS IN PROGRESS messages for subsequent acquisitions of this Scheduled Procedure Step / Examination instance.

After the Examination has been closed by the user, the system will change the MPPS status of the related examination to “COMPLETED” and generate a MPPS **COMPLETED** message by N-SET. The examination cannot be reopened. ELEVA EDI also generates MPPS messages for unscheduled examinations.

The MPPS COMPLETED message will list the UID's of all related DICOM exported images and format of (optionally) generated direct prints.

The user might cancel an unclosed examination at any time. Depending on state of examination and MPPS related system configuration, an MPPS IN PROGRESS message might be already sent (discontinued case) or not (abandoned case). If not, (abandoned case) the system generates an MPPS IN PROGRESS message. In both cases it sends then a MPPS **DICONTINUED** message. The reason for abandoning or discontinuing a procedure step is unspecified.

#### 4.2.2.5.1.1 Sequencing of Performed Procedure Steps

The performed sequence order of scheduled procedure steps may be interchanged by the user.

#### 4.2.2.5.1.2 Interleave of Performed Procedure Steps

MPPS messages may interleave. Depending on the application workflow optimization by the user, an MPPS sequence like this may come up:

```
MPPS / Inst UID 1: N_CREATE / IN PROGRESS
MPPS / Inst UID 2: N_CREATE / IN PROGRESS
MPPS / Inst UID 3: N_CREATE / IN PROGRESS
...
MPPS / Inst UID 2: N_SET / COMPLETED
MPPS / Inst UID 1: N_SET / COMPLETED
MPPS / Inst UID 3: N_SET / COMPLETED
```

(i.e.: running multiple procedure steps ‘in parallel’).

#### 4.2.2.5.2 Presentation Context Table

ELEVA Examination Control will propose the presentation contexts as given in the next table.

**Table 67: Proposed Presentation Context for the Verification by the RIS AE**

Abstract Syntax	UID	Transfer Syntax	UID List	Role	Ext. Neg.
MPPS	1.2.840.10008.3.1.2.3.3	ILE ELE EBE	1.2.840.10008.1.2 1.2.840.10008.1.2.1 1.2.840.10008.1.2.2	SCU	None

*Note: For Modality Performed Procedure Step, ELE is preferred.*

#### 4.2.2.5.3 SOP Specific Conformance

ELEVA Examination Control by default derives the specific acquisition protocol from the Scheduled Protocol Code Sequence Items.

If this Sequence contains more than one Protocol Code, these codes will be displayed as separate examinations on the UI, but will be handled by one common MPPS instance.

ELEVA Examination Control supports 3 more (configurable) mapping relations, as shown below:

- Examination is selected from Scheduled Protocol Code Items -> Code Value 0040,0008 (default)
- Examination is selected from Scheduled Procedure Step Description 0040,0007
- Examination is selected from Requested Procedure Code Items -> Code Value 0032,1064
- Examination is selected from Requested Procedure Description 0032,1060

The Evaluated Attributes of the ELEVA Examination Control are:

Evaluated Attributes of the ELEVA Examination Control			
Attribute Name	Tag	Evaluated	Note
Coding Scheme Version	0008,0103	No	
Coding Scheme Designator	0008,0102	No	
Code Meaning	0008,0104	No	
Code Value	0008,0100	Yes	for mapping the examination settings

That is, ELEVA Examination Control expects, that any used Code Value is unique (unambiguous) within a given RIS domain.

The number of items in the Scheduled Protocol Code Sequence accepted by the ELEVA Examination Control is not limited.

#### All Supported N-CREATE-RQ Models:

**Table 68: MPPS SOP Class - N-CREATE-RQ - SOP Common Module**

Attribute Name	Tag	VR	Note
Specific Character Set	0008,0005	CS	ISO_IR 100
SOP Class UID	0008,0016	UI	1.2.840.10008.3.1.2.3.3
SOP Instance UID	0008,0018	UI	

**Table 69: MPPS SOP Class - N-CREATE-RQ - Image Acquisition Results Module**

Attribute Name	Tag	VR	Note
Modality	0008,0060	CS	Applied Value: RF
Study ID	0020,0010	SH	If scheduled: Req. Procedure ID, else: equipment generated Study identifier
Performed Action Item Code Sequence	0040,0260	SQ	0 length
>Code Value	0008,0100	SH	
>Coding Scheme Designator	0008,0102	SH	
>Coding Scheme Version	0008,0103	SH	
>Code Meaning	0008,0104	LO	
Performed Series Sequence	0040,0340	SQ	
>Retrieve AE Title	0008,0054	AE	
>Series Description	0008,103E	LO	
>Performing Physician's Name	0008,1050	PN	
>Operators' Name	0008,1070	PN	
>Referenced Image Sequence	0008,1140	SQ	
>>Referenced SOP Class UID	0008,1150	UI	Uniquely identifies the referenced SOP Class. This attribute is only used only if Images may be retrieved as Single Image SOP Classes.
>>Referenced SOP Instance UID	0008,1155	UI	Uniquely identifies the referenced SOP Instance. This attribute is only used only if Images may be retrieved as Single Image SOP Classes.
>Protocol Name	0018,1030	LO	
>Series Instance UID	0020,000E	UI	
>Referenced Non-Image Composite SOP Instance Sequence	0040,0220	SQ	
>>Referenced SOP Class UID	0008,1150	UI	
>>Referenced SOP Instance UID	0008,1155	UI	

**Table 70: MPPS SOP Class - N-CREATE-RQ – Performed Procedure Step Information Module**

Attribute Name	Tag	VR	Note
Procedure Code Sequence	0008,1032	SQ	
>Code Value	0008,0100	SH	
>Coding Scheme Designator	0008,0102	SH	
>Coding Scheme Version	0008,0103	SH	
>Code Meaning	0008,0104	LO	
>Mapping Resource	0008,0105	CS	
>Context Group Version	0008,0106	DT	
>Context Group Local Version	0008,0107	DT	
>Code Set Extension Flag	0008,010B	CS	Applied Value(s): N, Y
>Context Group Extension Creator UID	0008,010D	UI	
>Context Identifier	0008,010F	CS	
Performed Station AE Title	0040,0241	AE	
Performed Station Name	0040,0242	SH	0 length
Performed Location	0040,0243	SH	0 length
Performed Procedure Step Start Date	0040,0244	DA	
Performed Procedure Step Start Time	0040,0245	TM	
Performed Procedure Step End Date	0040,0250	DA	0 length
Performed Procedure Step End Time	0040,0251	TM	0 length

Attribute Name	Tag	VR	Note
Performed Procedure Step Status	0040,0252	CS	Applied Value(s): COMPLETED, DISCONTINUED, IN PROGRESS
Performed Procedure Step ID	0040,0253	SH	
Performed Procedure Step Description	0040,0254	LO	0 length
Performed Procedure Type Description	0040,0255	LO	0 length

**Table 71: Proposed MPPS SOP Class - N-CREATE-RQ – Performed Procedure Step Relationship Module**

Attribute Name	Tag	VR	Note
Referenced Patient Sequence	0008,1120	SQ	
>Referenced SOP Class UID	0008,1150	UI	Uniquely identifies the referenced SOP Class. Required if Referenced Patient Sequence (0008:1200) is sent. Applied Value(s): 1.2.840.10008.3.1.2.1.1
>Referenced SOP Instance UID	0008,1155	UI	Uniquely identifies the referenced SOP Instance. Required if Referenced Patient Sequence (0008:1120) is sent.
Patient's Name	0010,0010	PN	
Patient ID	0010,0020	LO	
Patient's Birth Date	0010,0030	DA	
Patient's Sex	0010,0040	CS	
Scheduled Step Attribute Sequence	0040,0270	SQ	
>Accession Number	0008,0050	SH	
>Referenced Study Sequence	0008,1110	SQ	0 length if unscheduled
>>Referenced SOP Class UID	0008,1150	UI	
>>Referenced SOP Instance UID	0008,1155	UI	
>Study Instance UID	0020,000D	UI	
>Requested Procedure Description	0032,1060	LO	
>Scheduled Procedure Step Description	0040,0007	LO	
>Scheduled Protocol Code Sequence	0040,0008	SQ	
>>Code Value	0008,0100	SH	
>>Coding Scheme Designator	0008,0102	SH	
>>Coding Scheme Version	0008,0103	SH	
>>Code Meaning	0008,0104	LO	
>>Mapping Resource	0008,0105	CS	
>>Context Group Version	0008,0106	DT	
>>Context Group Local Version	0008,0107	DT	
>>Code Set Extension Flag	0008,010B	CS	Applied Value(s): N, Y
>>Context Group Extension Creator UID	0008,010D	UI	
>>Context Identifier	0008,010F	CS	
>Scheduled Procedure Step ID	0040,0009	SH	
>Requested Procedure ID	0040,1001	SH	

**Table 72: MPPS SOP Class - N-CREATE-RQ - Radiation Dose Module**

Attribute Name	Tag	VR	Note
Image Area Dose Product	0018,115E	DS	See Note
Total Number of Exposures	0040,0301	US	See Note
Total Time Of Fluoroscopy	0040,0300	US	See Note
Entrance Dose	0040,0302	US	See Note

*Note: Not sent in case of appended MPPS instances*

### Supported N-SET-RQ Models:

**Table 73: MPPS SOP Class - N-SET-RQ - SOP Common Module**

Attribute Name	Tag	VR	Note
SOP Class UID	0008,0016	UI	
SOP Instance UID	0008,0018	UI	

**Table 74: MPPS SOP Class - N-SET-RQ - Image Acquisition Results Module**

Attribute Name	Tag	VR	Note
Performed Protocol Code Sequence	0040,0260	SQ	1 item only
>Code Value	0008,0100	SH	
>Coding Scheme Designator	0008,0102	SH	
>Code Meaning	0008,0104	SH	
Performed Series Sequence	0040,0340	SQ	One or more items
>Retrieve AE Title	0008,0054	AE	Zero length
>Series Description	0008,103E	LO	Zero length
>Performing Physician's Name	0008,1050	PN	Zero length
>Operator's Name	0008,1070	PN	Name(s) of the operator(s)
>Referenced Image Sequence	0008,1140	SQ	In Non-Tomo Examinations 1 item only. In Tomo-Examinations N items. Missing after conventional acquisition.
>>Referenced SOP Class UID	0008,1150	UI	Presently only RF class
>>Referenced SOP Instance UID	0008,1155	UI	
>Protocol Name	0018,1030	LO	Copy of Performed Protocol Code Sequence -> Code Value
>Series Instance UID	0020,000E	UI	
>Referenced Standalone SOP Instance Sequence	0040,0220	SQ	Zero length

**Table 75: MPPS SOP Class - N-SET-RQ - Performed Procedure Step Information Module**

Attribute Name	Tag	VR	Note
Procedure Code Sequence	0008,1032	SQ	
>Code Value	0008,0100	SH	
>Coding Scheme Designator	0008,0102	SH	
>Coding Scheme Version	0008,0103	SH	
>Code Meaning	0008,0104	LO	
Performed Procedure Step End Date	0040,0250	DA	
Performed Procedure Step End Time	0040,0251	TM	
Performed Procedure Step Status	0040,0252	CS	Applied Value(s): COMPLETED, DISCONTINUED
Performed Procedure Step Description	0040,0254	LO	Zero length
Performed Procedure Type Description	0040,0255	LO	

**Table 76: MPPS SOP Class - N-SET-RQ - Radiation Dose Module**

Attribute Name	Tag	VR	Note
Image Area Dose Product	0018,115E	DS	Not accumulating: re-processed images, non-digital images. See Note
Total Number of Exposures	0040,0301	US	Not counting: re-processed images. See Note
Total Time Of Fluoroscopy	0040,0300	US	See Note
Entrance Dose	0040,0302	US	See Note

*Note: Not sent in case of appended MPPS instances*



## 4.3 NETWORK INTERFACES

### 4.3.1 Physical Network Interface

The ELEVA EDI System (ELEVA EDI ViewForum AE and the ELEVA Examination Control AE) application provides DICOM V3.0 TCP/IP Network Communication Support as defined in Part 8 of [DICOM].

ELEVA EDI System inherits its TCP/IP stack from Windows XP (i.e. the operating system platform).

ELEVA EDI System supports a single network interface: Ethernet ISO.8802-3. With standard supported physical medium include:

- IEEE 802.3 10BASE-TX
- IEEE 802.3 100BASE-TX (Fast Ethernet)
- IEEE 802.3 1000BASE-X (Fiber Optic Gigabit Ethernet).

## 4.4 CONFIGURATION

The ELEVA EDI (Ditto) system is configured by means of a configuration program. This program is accessible at start-up of the ELEVA EDI (Ditto) system. It is password protected and intended to be used by Philips Customer Support Engineers only.

The configuration program shall prompt the Customer Support Engineer to enter configuration information as required by the ELEVA EDI (Ditto) application.

### 4.4.1 AE Title/Presentation Address Mapping

An important installation issue is the translation from AE title to Presentation Address. How this is to be performed shall be described in this section.

#### 4.4.1.1 Local AE Titles

The ELEVA EDI System exits of two Application Entity titles and two IP addresses. One for the ELEVA Examination Control AE and one for the ELEVA EDI ViewForum Network AE.

At installation the Customer Support Engineer can change the ELEVA Examination Control AE host name.

The ELEVA EDI ViewForum AE can be changed independently.

**ELEVA EDI (Ditto) ViewForum AE listens on port 3010 (default).**

**Table 77: AE Title Configuration Table**

Application Entity	Default AE Title	Default TCP/IP Port
ELEVA EDI ViewForum AE	<IP host name VF>	3010 *
ELEVA Examination Control AE	<IP host name EEC>	Configurable

Note: \* Not configurable.

---

#### 4.4.1.2 Remote AE Title/Presentation Address Mapping

##### 4.4.1.2.1 Remote Association Initiators

All relevant remote applications able to setup a DICOM association towards ELEVA EDI (Ditto) ViewForum AE and ELEVA Examination Control must be configured at ELEVA EDI (Ditto) System configuration time.

The Customer Support Engineer (CSE) must provide the following information for each remote application:

- The **Application Entity Title**.
- The **SOP Classes** and **Transfer Syntaxes** for which ELEVA EDI (Ditto) ViewForum AE accepts associations.

##### 4.4.1.2.2 Remote Association Acceptors

The following information must be provided for all relevant remote applications that are able to accept DICOM associations from ELEVA EDI (Ditto) System:

- The **Application Entity Title**.
- The **Host name / IP address** on which the remote application resides.
- The **Port number** at which the remote application accepts association requests.

#### 4.4.2 Parameters

The specification of important operational parameters, and if configurable, their default value and range, shall be specified here.

The configuration parameters like SOP Classes and Transfer Syntaxes to be used are given in Table 4.

The configuration parameters are given in Table 78, categorized in the following sections:

- General Parameters of ELEVA EDI (Ditto) System.
- Local Configurable Parameters of the ELEVA EDI System.
- Remote Configurable Parameters of the ELEVA EDI System.
- General Print Parameters.
- Printer Specific Print Parameters.

Table 78: Configuration Parameters table

Parameter	Configurable	Default Value
<b>General Parameters of ELEVA EDI (Ditto) System</b>		
Time-out waiting for acceptance or rejection Response to an Association Open Request. (Application Level timeout)	No	-
General DIMSE level time-out values	No	-
Time-out waiting for response to TCP/IP connect request. (Low-level timeout)	No	-
Time-out waiting for acceptance of a TCP/IP message over the network. (Low-level timeout)	No	-
Time-out for waiting for data between TCP/IP packets. (Low-level timeout)	No	-
Any changes to default TCP/IP settings, such as configurable stack parameters.	No	-
<b>Local Configurable Parameters of the ELEVA EDI (Ditto) System</b>		
Size constraint in maximum object size (see note)	No	-
Maximum PDU size the AE can receive	Yes	0 (unlimited)
Maximum PDU size the AE can send	No	-
AE specific DIMSE level time-out values	No	-
Number of simultaneous associations by Service and/or SOP class	No	-
SOP class support	Yes	none
Transfer Syntax support <sup>1</sup>	Yes	ELE
<b>Remote Configurable Parameters of the ELEVA EDI (Ditto) System</b>		
Size constraint in maximum object size (see note)	No	-
Maximum PDU size the AE can receive	Yes	0 (unlimited)
Maximum PDU size the AE can send	No	-
AE specific DIMSE level time-out values	No	-
Number of simultaneous associations by Service and/or SOP class	No	-
SOP class support	Yes	none
Transfer Syntax support	Yes	ELE
Storage Commitment request must be sent after Storage request	Yes	not
Storage Commitment time-out (synchronous to asynchronous)	Yes	none
Automatic conversion of images of SOP classes not supported by remote systems into Secondary Capture Image Storage SOP instances	Yes	convert to SC
Export of pure DICOM images (i.e. only the standard DICOM attributes as defined in the related IOD) or extended DICOM images (with additional Standard DICOM, Private and Retired attributes)	Yes	allow all attributes
Support of overlays for DICOM node not supporting Presentation State objects <sup>2</sup>	Yes	enabled
Support of overlays for DICOM node supporting Presentation State objects <sup>2</sup>	Yes	disabled
Support of overlays for CD <sup>2</sup>	Yes	disabled
<b>General Print Parameters</b>		
The DICOM printers that may be selected by the operator	Yes	none
<b>Printer Specific Print Parameters <sup>3</sup></b>		
Medium type	Yes	all available
Film size ID (i.e. Media size)	Yes	all available
Resolution (300 / 600 dpi)	Yes	300
Color model (8 / 16 bits color)	Yes	8
Min Density	Yes	0
Max Density	Yes	0

*Note 1: The JPEG Baseline transfer syntax is only supported for RGB and YBR\_FULL\_422 images; therefore JPEG Baseline may NOT be configured for systems that are capable of handling storage of monochrome images too.*

*Note 2: The ELEVA EDI (Ditto) System Copy-tool can override the configured setting of overlay support.*

*Note 3: These print parameters can be selected from choice lists. These choice lists are defined via so-called prototypes for each type of printer and print medium. These prototypes are also configurable.*

## 5 MEDIA INTERCHANGE

### 5.1 Implementation Model

The Implementation Model identifies the DICOM Application Entities in a specific implementation, and relates the Application Entities to Real-World Activities.

#### 5.1.1 Application Data Flow

The ELEVA EDI System consists of one single application entity only: the ELEVA EDI ViewForum Application Entity.

Figure 16 shows the Media Interchange Application Data Flow as a functional overview of the ELEVA ViewForum AE for CD-R and DVD.

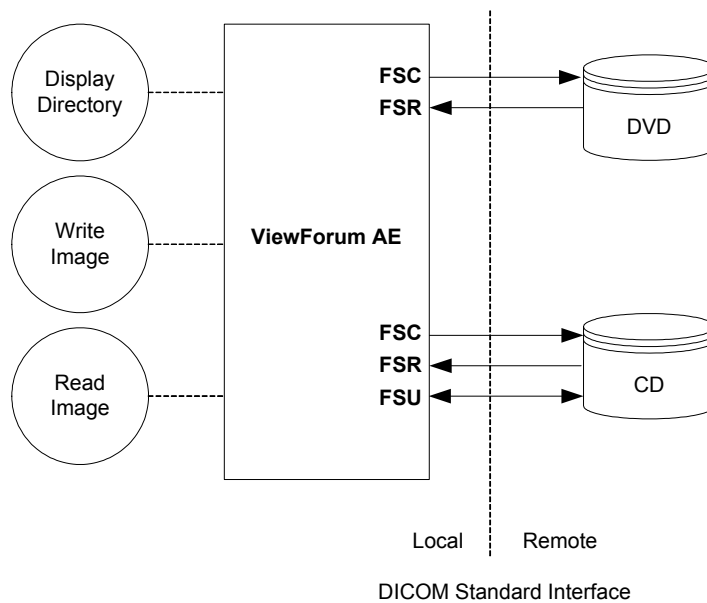

**Figure 16: Media Interchange Application Data Flow Diagram**

Table 85 shows the Media Interchange overview of the ELEVA ViewForum and the supporting roles for CD-R and DVD.

**Table 79: Media Services table**

Media Storage Application	Write Files (FSC / FSU)	Read Files (FSR)
General Purpose CD-R	YES / YES	YES
General Purpose DVD-JPEG	YES / NO	YES

The ELEVA ViewForum will act as a FSR, for CD-R and DVD, when reading the directory of the medium.  
 The ELEVA ViewForum will act as a FSC / FSU for a CD-R and as FSC for DVD, when writing the selected images in a patient folder onto the medium.  
 ELEVA AE supports the media profiles as shows in the Table below:

**Table 80: Media Profiles supported by ELEVA EDI ViewForum**

Application Profile	CD	DVD+RW / DVD+R
General Purpose	STD-GEN-CD	STD-GEN-DVD

*Note: DVD-R and DVD-RW can be read but are not supported for writing.*

### Supported Photometric Interpretations

The ELEVA EDI System supports images with the following DICOM Photometric Interpretations as shows in the Table below:

**Table 81: Photometric interpretations supported by ELEVA EDI ViewForum**

Photometric Interpretation	Import	Export	Viewing
MONOCHROME1	YES	YES	YES
MONOCHROME2	YES	YES	YES
PALETTE COLOR	YES	YES	NO
RGB	YES	YES	YES
YBR_FULL	YES	YES	NO
YBR_FULL_422 (see note)	YES	YES	NO
YBR_PARTIAL_422	YES	YES	NO
YBR_RCT	YES	YES	NO
YBR_ICT	YES	YES	NO

*Note: if the photometric interpretation YBR\_FULL\_422 is used in combination with transfer syntax JPEG-lossy then the pixel data is converted to RGB on import.*

The system proposes the transfer syntaxes mentioned in Table below.

**Table 82: Transfer Syntaxes of DVD / CD supported by ELEVA EDI System**

Abstract Syntax		Transfer Syntax		Role	Extended Negotiation
Name	UID	Name List (note)	UID List		
See Note	See Note	ILE ELE EBE	1.2.840.10008.1.2 1.2.840.10008.1.2.1 1.2.840.10008.1.2.2	SCU	None

*Note: any of the standard image storage and private SOP classes mentioned before. The preferred transfer syntax is ELE.*

ELEVA EDI System supports images with Lossy image compression via JPEG as described as shows in the Table below.

**Table 83: JPEG coding supported by ELEVA ViewForum**

DICOM Transfer Syntax UID	JPEG coding process	JPEG description
1.2.840.10008.1.2.4.50	1	Lossy, Baseline (JPEG 8 Bit Image Compression)

*Note: Lossy Compression is only supported for images with photometric interpretation RGB and YBR\_FULL\_422 and therefore ELEVA AE supports this only for Ultrasound Images.*

## 5.1.2 Functional Definitions of AE's

This section shall describe in general terms the functions to be performed by the AE, and the DICOM services used to accomplish these functions.

### 5.1.2.1 Functional Definition of ELEVA EDI ViewForum

The ELEVA EDI ViewForum is the one and only application entity within ELEVA EDI ViewForum System. It includes the following service class.

#### Media Storage Service Class for CD and DVD

The ELEVA EDI ViewForum can perform the CD-R Media Storage service as SCU, with capabilities for:

RWA Display Directory (as FSR),  
RWA Write Images (as FSC / FSU), and  
RWA Read Images (as FSR).

For DVD the ELEVA EDI ViewForum can perform the Media Storage service as SCU, with capabilities for:

RWA Display Directory (as FSR),  
RWA Write Images (as FSC), and  
RWA Read Images (as FSR).

## 5.1.3 Sequencing of Real World Activities

Whenever a CD or DVD has to be written the ELEVA EDI ViewForum first tries to read the DICOMDIR. The ELEVA EDI ViewForum will compile the updated DICOMDIR and any required DICOM images into a CD or DVD session image; this CD or DVD session image will be written to CD or DVD disk.

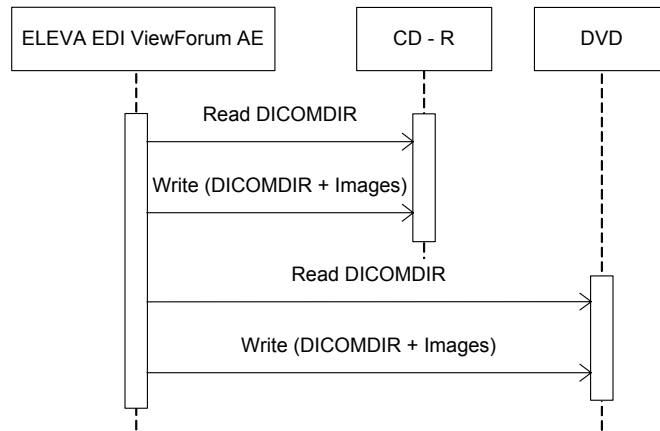

**Figure 17: Sequencing of RWA Write Images**

**5.1.4 File Meta Information for Implementation Class and Version**

This section shall be used to list the values assigned to the File Meta Information attributes (ref. [DICOM] PS 3.10) that pertain to the Implementation Class and Version.

The Implementation Class UID and the Implementation Version Name in the File Meta Header are as specified for Networking (ref. Table 9 in section 4.2.1.2.4).

**Table 84: DICOM Implementation Class and Version for ELEVA EDI ViewForum**

Implementation Class and Version	
File Meta Information Version	00, 01
Implementation Class UID	1.3.46.670589.5.2.23
Implementation Version Name	ELEVA EDI ViewForum

**5.2 AE Specifications**

The next section in the DICOM Conformance Statement contains the specification of the one and only ELEVA EDI ViewForum Application Entity.

**5.2.1 ELEVA EDI ViewForum**

The ELEVA EDI ViewForum provides Standard Conformance to the DICOM Media Storage Service and File Format ([DICOM] PS 3.10), the Media Storage Application Profiles STD-GEN-CD ([DICOM] PS 3.11) and the Media Storage Application Profiles STD-GEN-DVD-JPEG ([DICOM] PS 3.12) for Reading and Writing.

ELEVA EDI ViewForum AE supports multi-patient and multi-session CD-R / DVD disks, both for Reading and Writing.



Supported media by ELEVA EDI ViewForum are:

- **CD:** CD R / CD RW with the profile: STD-GEN-CD and
- **DVD:** DVD+R and DVD+RW with the profile: STD-GEN-DVD-JPEG and the Transfer Syntax ELE uncompressed.

The DVD - R and DVD - RW media can be Read but are NOT supported for Writing.

The supported Application Profiles, their Roles and the Service Class (SC) options, all defined in DICOM terminology, are listed in Table 85.

**Table 85: AE Related Application Profiles, Real-World Activities, and Roles for CD-R and DVD**

Supported Application Profile	Real-World Activity	Roles	SC Option
STD-GEN-CD	Display Directory	FSR	Interchange
	Write Images	FSC, FSU	Interchange
	Read Images	FSR	Interchange
STD-GEN-DVD-JPEG	Display Directory	FSR	Interchange
	Write Images	FSC	Interchange
	Read Images	FSR	Interchange

Only adding on instances is supported for the FSU, deleting is not supported.

#### 5.2.1.1 File Meta Information for the

The Source Application Entity Title is configurable (see ref. section 5.4 Media Configuration).

#### 5.2.1.2 Real-World Activities

##### 5.2.1.2.1 Display Directory

When a database open action is initiated on the CD-R or DVD then ELEVA EDI ViewForum acts as an FSR using the interchange option to read the DICOMDIR of the CD-R or DVD medium.

This will result in an overview of the patients, studies, series and images on the ELEVA EDI ViewForum screen.

##### 5.2.1.2.1.1 Media Storage Application Profile

As depicted in Table 85, the ELEVA EDI ViewForum supports the RWA Display Directory for the STD-GEN-CD and the STD-GEN-DVD-JPEG Application Profile.

##### 5.2.1.2.1.1.1 Options

The mandatory DICOMDIR keys are required for the correct display of directory information. The display is structured according the DICOM Composite Information Model: Patient, Study, Series and Image.

### 5.2.1.2.2 Write Images

When an image transfer to CD-R or DVD is initiated then the ELEVA EDI ViewForum acts as an FSC or FSU ( CD-R only ) using the interchange option to export SOP Instances from the local database to a CD-R or DVD medium.

#### 5.2.1.2.2.1 Media Storage Application Profile

As depicted in Table 85, the ELEVA EDI ViewForum supports the RWA Write Images for the STD-GEN-CD and the STD-GEN-DVD-JPEG Application Profile.

#### 5.2.1.2.2.1.1 Options

The same remarks as in section 4.2.1.3.1.3 about the existence of Optional, Retired and Private Attributes are applicable.

The DICOMDIR file will be extended when new images are written. In case some attributes are not present in an image but are specified as mandatory in the DICOMDIR definition in DICOM Media, a generated value will be filled in.

#### Implementation remarks and restrictions

When writing the DICOMDIR records, key values are generated when no value of the corresponding attribute is supplied, according to the following table.

**Table 86: Generated Keys**

Key	Tag	Generated Value
Patient Keys		
Patient ID	(0010,0020)	At import ELEVA EDI ViewForum each time creates a new value based on the Study Instance UID for each new study written to the CD-R / DVD (even if this study belongs to a patient recorded earlier). Otherwise the default-generated value shall be a succession of "UNKNOWN", the Patient's Name, the Patient's Birth Date, and the Patient's Sex, concatenated by using underscore characters.
Study Keys		
Study Date	(0008,0020)	Current date
Study Time	(0008,0030)	Current time
Study ID	(0020,0010)	"UNKNOWN"
Series Keys		
Series Number	(0020,0011)	1
Image Keys		
Instance Number	(0020,0013)	1

The default value for the Pixel Intensity Relationship (0028,1040) is set to DISP.

ELEVA EDI ViewForum can write Volumes of the media to that media.

ELEVA EDI ViewForum asks for a new media if media is spanning over more CD-R / DVD disks.

### 5.2.1.2.3 Read Images

When an image transfer from CD-R or DVD is initiated then the ELEVA EDI ViewForum acts as an FSR using the interchange option to import SOP Instances from the CD-R / DVD medium.

---

#### **5.2.1.2.3.1 Media Storage Application Profile**

As depicted in Table 85, the ELEVA EDI ViewForum supports the RWA Read Images for the STD-GEN-CD and STD-GEN-DVD-JPEG Application Profile.

##### **5.2.1.2.3.1.1 Options**

The mandatory attributes of the DICOM images are required for the correct storage of the images in the ELEVA EDI ViewForum internal image database.

Optional attributes and Retired / Private attributes are stored too – if present; this is equivalent with the level 2 (Full) conformance for the Storage service class in the Network support; ref. section 4.2.1.4.2.

The same remarks as in section 4.2.1.4.2.3 about the storage of images and about requirements to process read images via the dedicated ELEVA EDI ViewForum application functions are applicable.

### **5.3 Augmented and Private Application Profiles**

This section shall be used for the description of Augmented and Private Application Profiles.

#### **5.3.1 Augmented Application Profiles**

None.

#### **5.3.2 Private Application Profiles**

None.

### **5.4 Media Configuration**

Any configuration issues may be found in the Networking section 4.4 CONFIGURATION.

## 6 SUPPORT OF CHARACTER SETS

When the ELEVA EDI System receives images with undefined character set then the import will be terminated with error status code.

The ELEVA EDI System supports the extended character set ISO IR 100, which is the Latin alphabet No 1, supplementary set.

The following non-printable characters (Hexa-decimal coded) are not supported for the DI Image Export function in the received Worklist data:

00H through 1FH,  
7FH  
80H through 9FH,  
A0H, A6H, A8H, A9H, AAH, AEH  
B1H, B4H, B8H, B9H, BEH  
C0H, C1H, C2H, C3H, C8H, CAH, CBH, CCH, CDH, CEH, CFH  
D0H, D2H, D3H, D4H, D5H, D9H, DAH, DBH, DDH, DEH  
E3H  
F0H, F5H, FDH, FEH

When these characters are used in information that is shown on the DI Monitor of the ELEVA DI System or local hardcopy, they will be displayed as DI proprietary graphical symbols.

If one or more of these non-printable characters are present in the strings of received Worklist data, the string is not accepted.

If non-printable characters are present in the Patient's Name or if this attribute is empty, the worklist entry is not accepted.

In case the Patient's Name only contains spaces, this Worklist entry and all succeeding Worklist entries will be skipped.

The Default Factory Settings for the WLM query request attribute "Specific Character set (0008,0005)" is "NO" and should be configured to support the 27H Character.

---

## **7 SECURITY**

### **7.1 Security Profiles**

None supported.

### **7.2 Association level security**

Any calling AE title and/or IP address may open an association.

### **7.3 Application level security**

The ELEVA EDI System does not supports the HIPAA Audit trail profile.

## 8 ANNEXES

### 8.1 IOD Contents

This section specifies each **IOD created by the ELEVA EDI ViewForum Network AE for the Processed Mode.**

Each IOD **be converted to a Secondary Capture Image Storage SOP Class:**

- Secondary Capture Image Storage SOP Class, section 8.1.1.1
- Grayscale Softcopy Presentation State (**AS LAST SEEN / NEW AT IMPORT**), section 8.1.1.2
- Grayscale Softcopy Presentation State Object by the ELEVA DI AE, (**AS AQUIRED**) section 8.1.1.3
- X-Ray Radiofluoroscopic Image Storage SOP Class, section 8.1.1.4

#### 8.1.1 SOP Instances ELEVA EDI ViewForum Network

This section specifies each IOD of the **ELEVA EDI ViewForum Network AE**

**Used abbreviations are:**

**Used Presentation Values:**

ALWAYS	the module or attribute shall always be present with value
ANAP	Attribute Not Always Present
VNAP	Value Not Always Present (attribute sent zero length if no value is present)
EMPTY	Attribute is sent without a value
MAYBE	the module may be present under specified condition
OPTIONAL	the module may be available, depending on source object

**Used Source Items:**

AUTO	the attribute value is generated automatically
CONF	the attribute value source is a configurable parameter
IMPL	the attribute value source is a user-implicit configuration setting
MPPS	the attribute value source is a Modality Performed Procedure Step
MWL	the attribute value source is a Modality Worklist
SPEC	the attribute value source is a specific DICOM object
USER	the attribute value source is explicit user input

### 8.1.1.1 Secondary Capture Image Storage SOP Class

**Table 87: Modules of the Secondary Capture Image Storage SOP Class**

Information Entity	Module Name	Reference	Presence of Module
Patient	Patient Module	Table 88	ALWAYS
Study	General Study Module	Table 89	ALWAYS
	Patient Study Module	Table 90	OPTIONAL
Series	General Series Module	Table 95	ALWAYS
Equipment	General Equipment Module	Table 91	OPTIONAL
	SC Equipment Module	Table 92	ALWAYS
Image	General Image Module	Table 97	ALWAYS
	Image Pixel Module	Table 99	ALWAYS
	SC Image Module	Table 94	ALWAYS
	Overlay Plane Module	Table 100	OPTIONAL
	Modality LUT Module	Table 93	OPTIONAL
	VOI LUT Module	Table 96	OPTIONAL
	SOP Common Module	Table 98	ALWAYS
Private	Private Module	Table 102	ANAP

**Table 88: Secondary Capture Image Storage SOP Class - Patient Module**

Attribute Name	Tag	VR	Value	Presence of Value	Source
Patient's Name	0010,0010	PN		VNAP	AUTO
Patient's ID	0010,0020	LO		VNAP	AUTO
Patient's Birth Date	0010,0030	DA		VNAP	AUTO
Patient's Sex	0010,0040	CS	Applied Value(s): F, M, O	VNAP	AUTO
Referenced Patient Sequence	0008,1120	SQ		ANAP	AUTO
>Referenced SOP Class UID	0008,1150	UI		MAYBE	AUTO
>Referenced SOP Instance UID	0008,1155	UI		MAYBE	AUTO
Patient's Birth Time	0010,0032	TM		ANAP	AUTO
Other Patient's ID's	0010,1000	LO		ANAP	AUTO
Other Patient's Names	0010,1001	PN		ANAP	AUTO
Ethnic Group	0010,2160	SH		ANAP	AUTO
Patient Comments	0010,4000	LT		ANAP	AUTO

**Table 89: Secondary Capture Image Storage SOP Class - General Study Module**

Attribute Name	Tag	VR	Value	Presence of Value	Source
Study Instance UID	0020,000D	UI		ALWAYS	AUTO
Study Date	0008,0020	DA		VNAP	AUTO
Study Time	0008,0030	TM		VNAP	AUTO
Referring Physician's Name	0008,0090	PN		VNAP	AUTO
Study ID	0020,0010	SH		VNAP	AUTO
Accession Number	0008,0050	SH		VNAP	AUTO
Study Description	0008,1030	LO		ANAP	AUTO
Physician(s) of Record	0008,1048	PN		ANAP	AUTO
Name of Physician(s) Reading Study	0008,1060	PN		ANAP	AUTO

Referenced Study Sequence	0008,1110	SQ		ANAP	AUTO
>Referenced SOP Class UID	0008,1150	UI		MAYBE	AUTO
>Referenced SOP Instance UID	0008,1155	UI		MAYBE	AUTO
Procedure Code Sequence	0008,1032	SQ		ANAP	AUTO
>Code Sequence Macro			See Reference Table 101		

**Table 90: Secondary Capture Image Storage SOP Class - Patient Study Module**

Attribute Name	Tag	VR	Value	Presence of Value	Source
Admitting Diagnoses Description	0008,1080	UI		ANAP	AUTO
Admitting Diagnoses Code Sequence	0008,1084	SQ		ANAP	AUTO
>Code Sequence Macro			See Reference Table 101		
Patient's Age	0010,1010	AS		ANAP	AUTO
Patient's Size	0010,1020	DS		ANAP	AUTO
Patient's Weight	0010,1030	DS		ANAP	AUTO
Occupation	0010,2180	SH		ANAP	AUTO
Additional Patient's History	0010,21B0	LT		ANAP	AUTO

**Table 91: Secondary Capture Image Storage SOP Class - General Equipment Module**

Attribute Name	Tag	VR	Value	Presence of Value	Source
Manufacturer	0008,0070	LO	Philips Medical Systems	VNAP	AUTO
Institution Name	0008,0080	LO		ANAP	AUTO
Institution Address	0008,0081	ST		ANAP	AUTO
Station Name	0008,1010	SH		ANAP	AUTO
Institutional Department Name	0008,1040	LO		ANAP	AUTO
Manufacturer's Module Name	0008,1090	LO	ViewForum	ANAP	AUTO
Device Serial Number	0018,1000	LO		ANAP	AUTO
Software Versions	0018,1020	LO	ViewForum 4.1 PMS1.1 MIMIT EVIIMDictionary	ANAP	AUTO
Spatial Resolution	0018,1050	DS		ANAP	AUTO
Date of Last Calibration	0018,1200	DA		ANAP	AUTO
Time of Last Calibration	0018,1201	TM		ANAP	AUTO
Pixel Padding Value	0028,0120	US/SS		ANAP	AUTO

**Table 92: Secondary Capture Image Storage SOP Class - SC Equipment Module**

Attribute Name	Tag	VR	Value	Presence of Value	Source
Modality	0008,0060	CS	OT	ALWAYS	AUTO
Conversion Type	0008,0064	CS	WSD	ALWAYS	AUTO



**Table 93: Secondary Capture Image Storage SOP Class - Modality LUT Module**

Attribute Name	Tag	VR	Value	Presence of Value	Source
Modality LUT Sequence	0028,3000	SQ		MAYBE	AUTO
>LUT Descriptor	0028,3002	US/SS		MAYBE	AUTO
>LUT Explanation	0028,3003	LO		ANAP	AUTO
>Modality LUT Type	0028,3004	LO		MAYBE	AUTO
>LUT Data	0028,3006	US/SS/ OW		MAYBE	AUTO
Rescale Intercept	0028,1052	DS		MAYBE	AUTO
Rescale Slope	0028,1053	DS		MAYBE	AUTO

**Table 94: Secondary Capture Image Storage SOP Class - SC Image Module**

Attribute Name	Tag	VR	Value	Presence of Value	Source
Date of Secondary Capture	0018,1012	DA		ANAP	AUTO
Time of Secondary Capture	0018,1014	TM		ANAP	AUTO

**Table 95: Secondary Capture Image Storage SOP Class - General Series Module**

Attribute Name	Tag	VR	Value	Presence of Value	Source
Series Instance UID	0020,000E	UI		ALWAYS	CONF
Series Number	0020,0011	IS		VNAP	AUTO
Laterality	0020,0060	CS	Applied Value(s): L, R	MAYBE	AUTO
Series Date	0008,0021	DA		ANAP	AUTO
Series Time	0008,0031	TM		ANAP	AUTO
Performing Physicians' Name	0008,1050	PN		ANAP	AUTO
Protocol Name	0018,1030	LO		ANAP	AUTO
Series Description	0008,103E	LO		ANAP	AUTO
Operators' Name	0008,1070	PN		ANAP	AUTO
Referenced Performed Procedure Step Sequence	0008,1111	SQ		ANAP	AUTO
>Referenced SOP Class UID	0008,1150	UI	Required if Referenced Study Component Sequence (0008:1111) is sent.	MAYBE	AUTO
>Referenced SOP Instance UID	0008,1155	UI	Required if referenced Study Component Sequence (0008:1111) is sent.	MAYBE	AUTO
Body Part Examined	0018,0015	CS		ANAP	AUTO
Patient Position	0018,5100	CS		MAYBE	AUTO
Smallest Pixel Value in Series	0028,0108	US/SS		ANAP	AUTO
Largest Pixel Value in Series	0028,0109	US/SS		ANAP	AUTO
Request Attributes Sequence	0040,0275	SQ		ANAP	AUTO
>Requested Procedure ID	0040,1001	SH		MAYBE	AUTO
>Scheduled Procedure Step ID	0040,0009	SH		MAYBE	AUTO
>Scheduled Procedure Step Description	0040,0007	LO		ANAP	AUTO
>Scheduled Protocol Code Sequence	0040,0008	SQ		ANAP	AUTO
>>Code Sequence Code Sequence			See Reference Table 101		
Performed Procedure Step Start Date	0040,0244	DA		ANAP	AUTO

Performed Procedure Step Start Time	0040,0245	TM		ANAP	AUTO
Performed Procedure Step ID	0040,0253	SH		ANAP	AUTO
Performed Procedure Step Description	0040,0254	LO		ANAP	AUTO
Performed Protocol Code Sequence	0040,0260	SQ		ANAP	AUTO
>Code Sequence Macro			See Reference Table 101		
Comments on the Performed Procedure Step	0040,0280	ST		ANAP	AUTO

**Table 96: Secondary Capture Image Storage SOP Class - VOI LUT Module**

Attribute Name	Tag	VR	Value	Presence of Value	Source
VOI LUT Sequence	0028,3010	SQ		ANAP	AUTO
>LUT Descriptor	0028,3002	US/SS		MAYBE	AUTO
>LUT Explanation	0028,3003	LO		ANAP	AUTO
>LUT Data	0028,3006	US/SS/OW		MAYBE	AUTO
Window Center	0028,1050	DS		ANAP	AUTO
Window Width	0028,1051	DS		MAYBE	AUTO
Window Center & Width Explanation	0028,1055	LO		ANAP	AUTO

**Table 97: Secondary Capture Image Storage SOP Class - General Image Module**

Attribute Name	Tag	VR	Value	Presence of Value	Source
Image Type	0008,0008	CS	DERIVED SECONDARY	ANAP	AUTO
Content Date	0008,0023	DA		MAYBE	AUTO
Content Time	0008,0033	TM		MAYBE	AUTO
Acquisition Date	0008,0022	DA		ANAP	AUTO
Acquisition Time	0008,0032	TM		ANAP	AUTO
Acquisition Date Time	0008,002A	DT		ANAP	AUTO
Referenced Image Sequence	0008,1140	SQ		ANAP	AUTO
>Referenced SOP Class UID	0008,1150	UI		MAYBE	AUTO
>Referenced SOP Instance UID	0008,1155	UI		MAYBE	AUTO
>Referenced Frame Number	0008,1160	IS		ANAP	AUTO
>Purpose of Reference Code Sequence	0040,A170	SQ		ANAP	AUTO
>>Code Sequence Macro			See Reference Table 101		
Derivation Description	0008,2111	ST		ANAP	AUTO
Derivation Code Sequence	0008,9215	SQ		ANAP	AUTO
>>Code Sequence Macro			See Reference Table 101		
Source Image Sequence	0008,2112	SQ		ANAP	AUTO
>Referenced SOP Class UID	0008,1150	UI		MAYBE	AUTO
>Referenced SOP Instance UID	0008,1155	UI		MAYBE	AUTO
>Referenced Frame Number	0008,1160	IS		ANAP	AUTO
>Purpose of Reference Code Sequence	0040,A170	SQ		ANAP	AUTO
>>Code Sequence Macro			See Reference Table 101		
>Purpose of Reference Code Sequence	0040,A170	SQ		ALWAYS	AUTO
>>Code Sequence Marco			See Reference Table 101		
Acquisition Number	0020,0012	IS		ANAP	AUTO
Instance Number	0020,0013	IS		VNAP	AUTO
Patient Orientation	0020,0020	CS	Always zero length value	ALWAYS	AUTO

Images in Acquisition	0020,1002	IS		ANAP	AUTO
Image Comments	0020,4000	LT		ANAP	AUTO
Quality Control Image	0028,0300	CS		ANAP	AUTO
Burned in Annotation	0028,0301	CS		ANAP	AUTO
Lossy Image Compression	0028,2110	CS		ANAP	AUTO
Lossy Image Compression Ratio	0028,2112	DS		ANAP	AUTO
Icon Image Sequence	0088,0200	SQ		ANAP	AUTO
> Pixel Spacing	0028,0030	DS		ALWAYS	AUTO
> Slice Thickness	0018,0050	DS		ALWAYS	AUTO
> Slice Location	0020,1041	DS		ALWAYS	AUTO
Presentation LUT Shape	2050,0020	CS		ANAP	AUTO

**Table 98: Secondary Capture Image Storage SOP Class - SOP Common Module**

Attribute Name	Tag	VR	Value	Presence of Value	Source
Specific Character Set	0008,0005	CS	ISO_IR 100	ANAP	
SOP Class UID	0008,0016	UI	1.2.840.10008.5.1.1.7	ANAP	AUTO
SOP Instance UID	0008,0018	UI		ANAP	AUTO

**Table 99: Secondary Capture Image Storage SOP Class - Image Pixel Module**

Attribute Name	Tag	VR	Value	Presence of Value	Source
Samples per Pixel	0028,0002	US		ALWAYS	AUTO
Photometric Interpretation	0028,0004	CS	RGB	ALWAYS	AUTO
Row	0028,0010	US	512, 1024	ALWAYS	AUTO
Columns	0028,0011	US	512, 1024	ALWAYS	AUTO
Bits Allocated	0028,0100	US	8	ALWAYS	AUTO
Bits Stored	0028,0101	US	8	ALWAYS	AUTO
High Bit	0028,0102	US	7	ALWAYS	AUTO
Pixel Representation	0028,0103	US	0	ALWAYS	AUTO
Pixel Data	7FE0,0010	OW		ALWAYS	AUTO
Planar Configuration	0028,0006	US		MAYBE	AUTO
Pixel Aspect Ratio	0028,0034	IS		MAYBE	AUTO
Smallest Image Pixel Value	0028,0106	US/SS		ANAP	AUTO
Largest Image Pixel Value	0028,0107	US/SS		ANAP	AUTO

**Table 100: Secondary Capture Image Storage SOP Class - Overlay Plane Module**

Attribute Name	Tag	VR	Value	Presence of Value	Source
Overlay Rows	60xx,0010	US		ALWAYS	AUTO
Overlay Columns	60xx,0011	US		ALWAYS	AUTO
Overlay Type	60xx,0040	CS		ALWAYS	AUTO
Overlay Origin	60xx,0050	SS		ALWAYS	AUTO
Overlay Bits Allocated	60xx,0100	US		ALWAYS	AUTO
Overlay Bits Position	60xx,0102	US		ALWAYS	AUTO
Overlay Data	60xx,3000	OW/OB		MAYBE	AUTO
Overlay Description	60xx,0022	LO		ANAP	AUTO

Overlay Subtype	60xx,0045	LO		ANAP	AUTO
Overlay Label	60xx,1500	LO		ANAP	AUTO
ROI Area	60xx,1301	IS		ANAP	AUTO
ROI Mean	60xx,1302	DS		ANAP	AUTO
ROI Standard Deviation	60xx,1303	DS		ANAP	AUTO

**Table 101: Secondary Capture Image Storage SOP Class - Code Sequence Macro**

Attribute Name	Tag	VR	Value	Presence of Value	Source
<b>Basic Coded Entry Attributes</b>					
Code Value	0008,0100	SH		MAYBE	AUTO
Coding Scheme Designator	0008,0102	SH		MAYBE	AUTO
Coding Scheme Version	0008,0103	SH		MAYBE	AUTO
Code Meaning	0008,0104	LO		MAYBE	AUTO
<b>Enhanced Encoding Mode</b>					
Context Identifier	0008,010F	CS		ANAP	AUTO
Mapping Resource	0008,0105	CS		MAYBE	AUTO
Context Group Version	0008,0106	DT		MAYBE	AUTO
Context Group Extension Flag	0008,010B	CS		ANAP	AUTO
Context Group Local Version	0008,0107	DT		MAYBE	AUTO
Context Group Extension Creator UID	0008,010D	UI		MAYBE	AUTO

**Table 102: Secondary Capture Image Storage SOP Class - Private Module**

Attribute Name	Tag	VR	Value	Presence of Value	Source
Private Creator Group 2001	2001,0010	LO	PHILIPS IMAGING DD 001	ANAP	AUTO
Series Type	2001,106E	SH	SCSERIES	ANAP	AUTO
Private Creator Group 2007	2007,0025	LO	Philips EV Imaging DD 022	ANAP	AUTO
Series Type	2007,2512	LO	volumeSequenceCapture	ANAP	AUTO

### 8.1.1.2 Grayscale Softcopy Presentation State (AS LAST SEEN) for the Processed Mode

When the ELEVA EDI System imports a storage object without Presentation State object then it will create a presentation object for this storage object, which it then can use for export with the Presentation Label **"NEW AT IMPORT"** (if negotiated).

If private Presentation State information exists, then this will be used to create the Presentation State object. Depending on the setup, the ELEVA EDI System may or may not add this Private Presentation State information on export with the Presentation Label **"AS LAST SEEN"**.

**Table 103: Modules of the Grayscale Softcopy Presentation State Storage SOP Class**

Information Entity	Module Name	Reference	Presence of Module
Patient	Patient Module	Table 104	ALWAYS
Study	General Study Module	Table 105	ALWAYS
Series	General Series Module	Table 106	ALWAYS
	Presentation Series Module	Table 114	ALWAYS
Equipment	General Equipment Module	Table 107	ALWAYS
Presentation State	Modality LUT Module	Table 116	MAYBE
	Mask module	Table 120	MAYBE
	Display shutter module	Table 108	MAYBE
	Overlay Plane Module	Table 117	MAYBE
	Displayed Area Module	Table 112	ALWAYS
	Graphic Layer Module	Table 115	MAYBE
	Graphic Annotation	Table 119	MAYBE
	Softcopy Presentation LUT Module	Table 111	ALWAYS
	Overlay/Curve Activation Module	Table 118	MAYBE
	Softcopy VOI LUT Module	Table 110	MAYBE
	Presentation State Module	Table 113	ALWAYS
	SOP Common Module	Table 109	ALWAYS
	Private Application		MAYBE

**Table 104: Grayscale Softcopy Presentation State Storage SOP Class - Patient Module (M)**

Attribute Name	Tag	VR	Value	Presence of Value	Source
Patient's Name	0010,0010	PN		VNAP	SPEC
Patient ID	0010,0020	LO		VNAP	SPEC
Patient's Birth Date	0010,0030	DA		VNAP	SPEC
Patient's Sex	0010,0040	CS	Applied Value(s): F, M, O	VNAP	SPEC

**Table 105: Grayscale Softcopy Presentation State Storage SOP Class - General Study Module (M)**

Attribute Name	Tag	VR	Value	Presence of Value	Source
Study Date	0008,0020	DA		VNAP	SPEC
Study Time	0008,0030	TM		VNAP	SPEC
Accession Number	0008,0050	SH	RIS generated number which identifies the order of the Study	VNAP	SPEC
Referring Physician's Name	0008,0090	PN		VNAP	SPEC
Study Description	0008,1030	LO		ANAP	SPEC
Study Instance UID	0020,000D	UI		ALWAYS	SPEC
Study ID	0020,0010	SH		VNAP	SPEC

**Table 106: Grayscale Softcopy Presentation State Storage SOP Class - General Series Module (M)**

Attribute Name	Tag	VR	Value	Presence of Value	Source
Series Date	0008,0021	DA	Time the Series started.	ANAP	SPEC
Series Time	0008,0031	TM	Name of the Physicians administering the Series.	ANAP	SPEC
Performing Physician's Name	0008,1050	PN	Uniquely identifies the Study Component SOP Instance to which the series is related.	ANAP	SPEC
Referenced Performed Procedure Step Sequence	0008,1111	SQ	Uniquely identifies the referenced SOP Class. Required if Referenced Study Component Sequence (0008:1111) is sent.	VNAP	AUTO
> Referenced SOP Class UID	0008,1150	UI	1.2.840.10008.3.1.2.3.3	ALWAYS	AUTO
> Referenced SOP Instance UID	0008,1155	UI	Date the Series started.	ALWAYS	AUTO
Protocol Name	0018,1030	LO		ANAP	SPEC
Patient Position	0018,5100	CS		MAYBE	AUTO
Series Number	0020,0011	IS		VNAP	SPEC
Series Instance UID	0020,000E	UI	Date the Series started.	ALWAYS	AUTO
Laterally	0020,0060	CS	Applied Value(s): L, R	MAYBE	SPEC
Performed Procedure Step Start Date	0040,0244	DT		ANAP	SPEC
Performed Procedure Step Start Time	0040,0245	TM		ANAP	SPEC
Performed Procedure Step Description	0040,0254	LO		ANAP	SPEC

**Table 107: Grayscale Softcopy Presentation State Storage SOP Class - General Equipment Module (M)**

Attribute Name	Tag	VR	Value	Presence of Value	Source
Manufacturer	0008,0070	LO		VNAP	AUTO
Institution Name	0008,0080	LO		VNAP	AUTO
Station Name	0008,1010	SH		VNAP	AUTO
Manufacturer's Model Name	0008,1090	LO		VNAP	AUTO
Device Serial Number	0018,1000	LO		VNAP	AUTO

Software Versions	0018,1020	LO	ViewForum 4.1 PMS1.1 MIMIT EVIIMDictionary	VNAP	AUTO
-------------------	-----------	----	--	------	------

**Table 108: Grayscale Softcopy Presentation State Storage SOP Class - DISPLAY Shutter Module ( C )**

Attribute Name	Tag	VR	Value	Presence of Value	Source
Shutter Shape	0018,1600	CS	CIRCULAR, POLYGONAL, RECTANGULAR	ALWAYS	SPEC
Shutter Left Vertical Edge	0018,1602	IS		ANAP	SPEC
Shutter Right Vertical Edge	0018,1604	IS		ANAP	SPEC
Shutter Upper Horizontal Edge	0018,1606	IS		ANAP	SPEC
Shutter Lower Horizontal Edge	0018,1608	IS		ANAP	SPEC
Center of Circular Shutter	0018,1610	IS		ANAP	SPEC
Radius of Circular Shutter	0018,1612	IS		ANAP	SPEC
Vertices of the Polygonal Shutter	0018,1620	IS		ANAP	SPEC

**Table 109: Grayscale Softcopy Presentation State Storage SOP Class - SOP Common Module (M)**

Attribute Name	Tag	VR	Value	Presence of Value	Source
Specific Character Set	0008,0005	CS	ISO_IR 100	ANAP	AUTO
SOP Class UID	0008,0016	UI	1.2.840.10008.5.1.4.1.1.11.1	ANAP	AUTO
SOP Instance UID	0008,0018	UI		ANAP	AUTO

**Table 110: Grayscale Softcopy Presentation State Storage SOP Class - Softcopy VOI LUT Module ( C )**

Attribute Name	Tag	VR	Value	Presence of Value	Source
Softcopy VOI LUT Sequence	0028,3110	SQ		ALWAYS	SPEC
> Window Center	0028,1050	DS		ANAP	SPEC
> Window Width	0028,1051	DS		ANAP	SPEC
> Window Center & Width Explanation	0028,1055	LO		ANAP	SPEC
> Referenced Image Sequence	0008,1140	SQ		ANAP	SPEC
>> Referenced SOP Class UID	0008,1150	UI		ANAP	SPEC
>> Referenced SOP Instance UID	0008,1155	UI		ANAP	SPEC
>> Referenced Frame Number	0008,1160	IS		ANAP	SPEC
> VOI LUT Sequence	0028,3010	SQ		ANAP	SPEC
>> LUT Descriptor	0028,3002	SS/US		ANAP	SPEC
>> LUT Explanation	0028,3003	LO		ANAP	SPEC
>> LUT Data	0028,3006	OW/SS/US		ANAP	SPEC
> Private Creator Group 2001	2001,0010	LO	Philips Imaging DD 001	ANAP	AUTO
> Window Smoothing Taste	2001,104E	CS		VNAP	AUTO

> GL TrafoType	2001,1077	CS		ANAP	AUTO
> Nested Object Type Name	2001,10C1	LO	LinearVOIGLTrafo	ANAP	AUTO

**Table 111: Grayscale Softcopy Presentation State Storage SOP Class - Softcopy Presentation LUT Module (M)**

Attribute Name	Tag	VR	Value	Presence of Value	Source
Presentation LUT Shape	2050,0020	CS	IDENTITY	ANAP	AUTO
Presentation LUT Sequence	2050,0010	SQ		ANAP	AUTO
> LUT Descriptor	0028,3002	SS		ANAP	AUTO
> LUT Data	0028,3006	OW		ANAP	AUTO

**Table 112: Grayscale Softcopy Presentation State Storage SOP Class - Displayed Area Module (M)**

Attribute Name	Tag	VR	Value	Presence of Value	Source
Displayed Area Selection Sequence	0070,005A	SQ		ALWAYS	AUTO
>isplayed Area Top Left Hand orner	0070,0052	SL	1, 1	ALWAYS	AUTO
>isplayed Area Bottom Right Hand orner	0070,0053	SL	1024,1024	ALWAYS	AUTO
> Presentation Size Mode	0070,0100	CS	SCALE TO FIT	ALWAYS	AUTO
> Presentation Pixel Spacing	0070,0101	DS	Required if Presentation Size Mode (0070,0100) is TRUE SIZE, in which case the values will correspond to the physical distance between the center of each pixel on the display device. May be present if Presentation Size Mode (0070,0100) is SCALE TO FIT or MAGNIFY, in which case the values are used to compute the aspect ratio of the image pixels.	ANAP	AUTO
Presentation Pixel Aspect Ratio	0070,0102	IS	5400, 5400	ANAP	AUTO
Private Creator Group 2001	2001,0010	LO	Philips Imaging DD 001	VNAP	AUTO
Interpolation Method	2001,103F	CS		ALWAYS	AUTO

**Table 113: Grayscale Softcopy Presentation State Storage SOP Class - Presentation State Module (M)**

Attribute Name	Tag	VR	Value	Presence of Value	Source
Referenced Series Sequence	0008,1115	SQ		ALWAYS	AUTO
> Series Instance UID	0020,000E	UI		ALWAYS	AUTO
> Referenced Image Sequence	0008,1140	SQ		ANAP	AUTO
>> Referenced SOP Class UID	0008,1150	UI	1.2.840.10008.5.1.4.1.1.12.2	ALWAYS	AUTO



>> Referenced SOP Instance UID	0008,1155	UI		ALWAYS	AUTO
Shutter Presentation Value	0018,1622	US	0	MAYBE	AUTO
Instance Number	0020,0013	IS	1	ALWAYS	AUTO
Presentation Label	0070,0080	CS	"NEW AT IMPORT", "AS LAST SEEN"	ALWAYS	AUTO
Presentation Description	0070,0081	LO		VNAP	AUTO
Presentation Creation Date	0070,0082	DA	Current Date	ALWAYS	AUTO
Presentation Creation Time	0070,0083	TM	Current Time	ALWAYS	AUTO
Presentation Creator's Name	0070,0084	PN		VNAP	AUTO

**Table 114: Grayscale Softcopy Presentation State Storage SOP Class - Presentation Series Module (M)**

Attribute Name	Tag	VR	Value	Presence of Value	Source
Modality	0008,0060	CS	PR = Presentation State	ALWAYS	AUTO

**Table 115: Grayscale Softcopy Presentation State Storage SOP Class - Graphic Layer Module ( C )**

Attribute Name	Tag	VR	Value	Presence of Value	Source
Graphic Layer Sequence	0070,0060	SQ		ALWAYS	AUTO
> Graphic Layer	0070,0002	CS	Layer created on import	ALWAYS	AUTO
> Graphic Layer Order	0070,0062	IS	1	ALWAYS	AUTO
> Graphic Layer Recommended Display RGB Value	0070,0067	US	FFFF, FFFF, FFFF	ANAP	AUTO
> Graphic Layer Description	0070,0068	LO	ViewForum Graphics	ANAP	AUTO

**Table 116: Grayscale Softcopy Presentation State Storage SOP Class - Modality LUT Module ( C )**

Attribute Name	Tag	VR	Value	Presence of Value	Source
Modality LUT Sequence	0028,3000	SQ		MAYBE	SPEC
>LUT Descriptor	0028,3002	US/SS		MAYBE	SPEC
>LUT Explanation	0028,3003	LO		ANAP	SPEC
>Modality LUT Type	0028,3004	LO		MAYBE	SPEC
>LUT Data	0028,3006	US/SS/ OW		MAYBE	SPEC
Rescale Intercept	0028,1052	DS		MAYBE	SPEC
Rescale Slope	0028,1053	DS		MAYBE	SPEC
Rescale Type	0028,1054	LO		MAYBE	SPEC

**Table 117: Grayscale Softcopy Presentation State Storage SOP Class - Overlay Plane Module (C)**

Attribute Name	Tag	VR	Value	Presence of Value	Source
Overlay Rows	60xx,0010	US		ALWAYS	SPEC
Overlay Columns	60xx,0011	US		ALWAYS	SPEC
Overlay Description	60xx,0022	LO		ALWAYS	SPEC
Overlay Type	60xx,0040	CS	G, R	ALWAYS	SPEC
Overlay Subtype	60xx,0045	LO		ANAP	SPEC
Overlay Origin	60xx,0050	SS	1/1	ALWAYS	SPEC
Overlay Bits Allocated	60xx,0100	US	1	ALWAYS	SPEC
Overlay Bit Position	60xx,0102	US	0	ALWAYS	SPEC
ROI Area	60xx,1301	IS		ANAP	SPEC
ROI Mean	60xx,1302	DS		ANAP	SPEC
ROI Standard Deviation	60xx,1303	DS		ANAP	SPEC
Overlay Label	60xx,1500	LO		ANAP	SPEC
Overlay Data	60xx,3000	OB/OW		MAYBE	SPEC

**Table 118: Grayscale Softcopy Presentation State Storage SOP Class - Overlays/Curve Activation Module (C)**

Attribute Name	Tag	VR	Value	Presence of Value	Source
Curve Activation Layer	50xx,1001	CS	Layer created on import	MAYBE	AUTO
Overlay Activation Layer	60xx,1001	CS	Layer created on import	MAYBE	AUTO

**Table 119: Grayscale Softcopy Presentation State Storage SOP Class - Graphic Annotation Module (C)**

Attribute Name	Tag	VR	Value	Presence of Value	Source
Graphic Annotation Sequence	0070,0001	SQ		ALWAYS	AUTO
> Graphic Layer	0070,0002	CS	Layer created on import VFGFX	ALWAYS	USER
>Text Object Sequence	0070,0008	SQ		ANAP	USER
>> Bounding Box Annotation Units	0070,0003	CS	PIXEL	ANAP	USER
>> Anchor Point Annotation Units	0070,0004	CS	PIXEL	ANAP	USER
>> Unformatted Text Value	0070,0006	ST		ALWAYS	USER
>> Bounding Box Top Left Hand Corner	0070,0010	FL		ANAP	USER
>> Bounding Box Bottom Right Hand Corner	0070,0011	FL		ANAP	USER
>> Bounding Box Text Horizontal Justification	0070,0012	CS	CENTER, LEFT, RIGHT	ANAP	USER
>> Anchor Point	0070,0014	FL		ANAP	USER
>> Anchor Point Visibility	0070,0015	CS	N, Y	ANAP	USER
>> Private Creator Group 2001	2001,0010	LO	PHILIPS IMAGING DD 001	VNAP	AUTO
>> Measurement Text Units	2001,105D	ST		VNAP	USER
>> Measurement Text Type	2001,105E	ST	CONTOURAREASIZE,	VNAP	USER

			POLYLINELENGTH		
>> Type (PIIM)	2001,1064	SH	TEXT, MEASUREMENT	VNAP	USER
>> Text Anchor Point Alignment	2001,1080	LO	CENTER, BOTTOMCENTER, BOTTOMRIGHT	VNAP	USER
>> Text Color Foreground	2001,10A3	UL	0xFFFFFFFF = -1	VNAP	USER
>> Text Color Background	2001,10A4	UL	0xFF000000 = -167777216	VNAP	USER
>> Text Font	2001,106D	LO	Helvetica	ANAP	USER
>> Text Style	2001,1093	LO	Defined Terms: BOLD, ITALIC, UNDERLINE BOLDITALIC BOLDUNDERLINE ITALICUNDERLINE	ANAP	USER
>> Text Color Shadow	2001,10A5	UL	ARGB color of the shadow, 0xFF000000.	ANAP	USER
>> Nested Object Type Name	2001,10C1	LO	Text, MeasurementText	ANAP	USER
<b>&gt; Graphic Object Sequence</b>	<b>0070,0009</b>	<b>SQ</b>		<b>ANAP</b>	<b>USER</b>
>> Graphic Annotation Units	0070,0005	CS	PIXEL	ALWAYS	USER
>> Graphic Dimensions	0070,0020	US		ALWAYS	USER
>> Number of Graphics Points	0070,0021	US		ALWAYS	USER
>> Graphic Data	0070,0022	FL	2-n	ALWAYS	USER
>> Graphic Type	0070,0023	CS	CIRCLE, ELLIPSE, INTERPOLATED, POINT, POLYLINE	ALWAYS	USER
>> Graphic Filled	0070,0024	CS	N, Y	ANAP	USER
>> Private Creator Group 2001	2001,0010	LO	PHILIPS IMAGING DD 001	VNAP	USER
>> Graphic Line Style	2001,1046	CS	SOLID	VNAP	USER
>> Poly Line Interpolation Method	2001,104B	CS	LINEAR	VNAP	USER
>> Poly Line Begin Point Style	2001,104C	CS	NONE	VNAP	USER
>> Poly Line End Point Style	2001,104D	CS	NONE	VNAP	USER
>> Graphic Line Color	2001,1055	CS	0xFFFFFFFF= -1	VNAP	USER
>> Graphic Type (Private)	2001,1056	CS	ELLIPSE, POLYLINE, POLYGON	VNAP	USER
>> Graphic Annotation Model	2001,105A	ST		VNAP	USER
>> Graphic Number	2001,109B	UL		VNAP	USER
>> Graphic Line Width	2001,1047	FL		ANAP	AUTO
>> Nested Object Type Name	2001,10C1	LO	Text, PolyLine, Polygon	ANAP	AUTO
>> Private Creator Group	2007,00FF	LO	Philips EV Imaging DD 022	ANAP	AUTO
>>	2007,FF34	CS	NO		
> Private Creator Group 2001	2001,0010	LO	PHILIPS IMAGING DD 001	VNAP	AUTO
> Graphic Annotation Model	2001,105A	ST	GfxEllipse, GfxPointedText, GfxDistance, GfxRectangle, GfxPolyLine	ANAP	USER
> Graphic Annotation ID	2001,1048	SS		ANAP	AUTO
> Private Creator Group	2007,00FF	LO	Philips EV Imaging DD 022	ANAP	AUTO
>	2007,FF00	ST	annotate, measurement,	ANAP	AUTO
>	2007,FF33	LO		ANAP	AUTO

**Table 120: Grayscale Softcopy Presentation State Storage SOP Class - Mask Module**

Attribute Name	Tag	VR	Value	Presence of Value	Source
Recommended Viewing Mode	0028,1090	CS	NAT, SUB	VNAP	SPEC
Mask Subtraction Sequence	0028,6100	SQ		ALWAYS	SPEC
>Mask Operation	0028,6101	CS	AVG_SUB, NONE, TID	ALWAYS	SPEC
>Applicable Frame Range	0028,6102	US		ANAP	SPEC
>Mask Frame Numbers	0028,6110	US		MAYBE	SPEC
>Contrast Frame Averaging	0028,6112	US		ANAP	SPEC
>Mask Sub-pixel Shift	0028,6114	FL		ANAP	SPEC
>TID Offset	0028,6120	SS		MAYBE	SPEC
>Mask Operation Explanation	0028,6190	ST		ANAP	SPEC

**Table 121: Grayscale Softcopy Presentation State Storage SOP Class - Private Group**

Attribute Name	Tag	VR	Value	Presence of Value	Source
Private Creator Group 2001	2001,0010	LO	Philips Imaging DD 001	ANAP	AUTO
Window Invert	2001,1053	CS		ANAP	AUTO
Examination Source	2001,1063	CS		ANAP	AUTO
Series Type	2001,106E	SH		ANAP	AUTO
Window Smoothing Taste	2001,104E	CS		ANAP	AUTO
GL TrafoType	2001,1077	CS		ANAP	AUTO
Processing Order Specialization	2001,1094	LO		ANAP	AUTO

### 8.1.1.3 Grayscale Softcopy Presentation State (AS ACQUIRED) for the Processed Mode

This section specifies each IOD created by the **ELEVA EDI** for the **Processed Mode**.

If private Presentation State information exists, in RAW mode, then the ELEVA EDI DICOM AE will be send the Presentation State object with the Presentation Label " **AS ACQUIRED**".

**Table 122: Modules of the Grayscale Softcopy Presentation State Storage SOP Class**

Information Entity	Module Name	Reference	Presence of Module
Patient	Patient Module	Table 123	ALWAYS
Study	General Study Module	Table 124	ALWAYS
Series	General Series Module	Table 125	ALWAYS
	Presentation Series Module	Table 133	ALWAYS
Equipment	General Equipment Module	Table 126	ALWAYS
Presentation State	Display shutter module	Table 127	MAYBE
	Displayed Area Module	Table 131	ALWAYS
	Softcopy Presentation LUT Module	Table 130	ALWAYS
	Softcopy VOI LUT Module	Table 129	MAYBE
	Presentation State Module	Table 132	ALWAYS
	SOP Common Module	Table 128	ALWAYS
	Additional Attributes	Table 135	MAYBE

**Table 123: Softcopy PS Storage SOP Class – C-STORE-RQ - Patient Module (M)**

Attribute Name	Tag	VR	Value	Presence of Value	Source
Patient's Name	0010,0010	PN		VNAP	SPEC
Patient ID	0010,0020	LO	Primary hospital identification number or code for the patient.	VNAP	SPEC
Patient's Birth Date	0010,0030	DA		VNAP	SPEC
Patient's Sex	0010,0040	CS	Applied Value(s): F, M, O	VNAP	SPEC

**Table 124: Softcopy PS Storage SOP Class – C-STORE-RQ - General Study Module (M)**

Attribute Name	Tag	VR	Value	Presence of Value	Source
Study Date	0008,0020	DA	Time the study started.	VNAP	SPEC
Study Time	0008,0030	TM	RIS generated number which identifies the order of the study.	VNAP	SPEC
Accession Number	0008,0050	SH		VNAP	SPEC
Referring Physician's Name	0008,0090	PN		VNAP	SPEC
Study Description	0008,1030	LO		ANAP	SPEC
Study ID	0020,0010	SH		VNAP	SPEC
Study Instance UID	0020,000D	UI	Date the study started.	ALWAYS	SPEC

**Table 125: Softcopy PS Storage SOP Class – C-STORE-RQ - General Series Module (M)**

Attribute Name	Tag	VR	Value	Presence of Value	Source
Series Date	0008,0021	DA	Name of the Physicians administering the Series.	VNAP	SPEC
Series Time	0008,0031	TM	Unique identifier of the Series.	VNAP	SPEC
Protocol Name	0008,1030	LO		ANAP	AUTO
Performing Physician's Name	0008,1050	PN		VNAP	USER
Series Instance UID	0020,000E	UI	Date the Series started.	ALWAYS	AUTO
Series Number	0020,0011	IS	Time the Series started.	VNAP	SPEC
Laterally	0020,0060	CS	A number that identifies the Series.	MAYBE	SPEC
Performed Procedure Step Start Date	0040,0244	DT		ANAP	AUTO
Performed Procedure Step Start Time	0040,0245	TM		ANAP	AUTO
Performed Procedure Step Description	0040,0254	LO		ANAP	AUTO

**Table 126: Softcopy PS Storage SOP Class – C-STORE-RQ - General Equipment Module**

Attribute Name	Tag	VR	Value	Presence of Value	Source
Manufacturer	0008,0070	LO	Philips Medical Systems	VNAP	AUTO
Institution Name	0008,0080	LO		VNAP	AUTO
Station Name	0008,1010	SH	Eleva	VNAP	AUTO
Manufacturer's Model Name	0008,1090	LO		VNAP	AUTO
Device Serial Number	0018,1000	LO		VNAP	AUTO
Software Versions	0018,1020	LO	DSI R2.1.2 LUT 04-01-02 R6.1.3.0119 PMS1.1 MIMIT EVIIMDictionary	VNAP	AUTO

**Table 127: Grayscale Softcopy Presentation State Storage SOP Class - Shutter Module( C )**

Attribute Name	Tag	VR	Value	Presence of Value	Source
Display Shutter Sequence	2001,1069	SQ	Display Shutter Presentation can vary per image.	ANAP	USER
> Shutter Shape	0018,1600	CS	CIRCULAR, RECTANGULAR	ALWAYS	USER
> Shutter Left Vertical Edge	0018,1602	IS		ANAP	USER
> Shutter Right Vertical Edge	0018,1604	IS		ANAP	USER
> Shutter Upper Horizontal Edge	0018,1606	IS		ANAP	USER
> Shutter Lower Horizontal Edge	0018,1608	IS		ANAP	USER
> Center of Circular Shutter	0018,1610	IS		ANAP	USER
> Radius of Circular Shutter	0018,1612	IS		ANAP	USER

**Table 128: Softcopy PS Storage SOP Class – C-STORE-RQ - SOP Common Module (M)**

Attribute Name	Tag	VR	Value	Presence of Value	Source
Specific Character Set	0008,0005	CS	ISO_IR 100	ANAP	AUTO
SOP Class UID	0008,0016	UI	1.2.840.10008.5.1.4.1.1.11.1	ANAP	AUTO
SOP Instance UID	0008,0018	UI		ANAP	AUTO

**Table 129: Softcopy PS Storage SOP Class – C-STORE-RQ - VOI LUT Module ( C )**

Attribute Name	Tag	VR	Value	Presence of Value	Source
Softcopy VOI LUT Sequence	0028,3110	SQ		ALWAYS	AUTO
> Window Center	0028,1050	DS		ANAP	AUTO
> Window Width	0028,1051	DS		ANAP	AUTO
> Private Creator Group 2001	2001,0010	LO	Philips Imaging DD 001	ANAP	AUTO
> Window Smoothing Taste	2001,104E	CS	CONVENTIONAL	ANAP	AUTO
> GL Trafo Type	2001,1077	CS	LINEARVOI	ANAP	AUTO
> Referenced Image Sequence	0008,1140	SQ		ANAP	AUTO
>> References SOP Class UID	0008,1150	UI	1.3.46.670589.2.3.1.1	ANAP	AUTO
>> References SOP Instance UID	0008,1155	UI		ANAP	AUTO

**Table 130: Softcopy PS Storage SOP Class – C-STORE-RQ - Softcopy Presentation LUT Module (M)**

Attribute Name	Tag	VR	Value	Presence of Value	Source
Presentation LUT Sequence	2050,0010	SQ	Required if Presentation LUT Shape (2050,0020) is absent.	ANAP	AUTO
> LUT Descriptor	0028,3002	US		ALWAYS	AUTO
> LUT Data	0028,3006	US		ALWAYS	AUTO

**Table 131: Softcopy PS Storage SOP Class – C-STORE-RQ - Displayed Area Module (M)**

Attribute Name	Tag	VR	Value	Presence of Value	Source
Displayed Area Selection Sequence	0070,005A	SQ		ALWAYS	AUTO
> Displayed Area Top Left Hand Corner	0070,0052	SL		ALWAYS	AUTO
> Displayed Area Bottom Right Hand Corner	0070,0053	SL		ALWAYS	AUTO
> Presentation Size Mode	0070,0100	CS	Applied Value(s): MAGNIFY, SCALE TO FIT, TRUE SIZE	ALWAYS	AUTO
> Presentation Pixel Aspect Ratio	0070,0102	IS	1, 1	ANAP	AUTO

**Table 132: Softcopy PS Storage SOP Class – C-STORE-RQ - Presentation State Module (M)**

Attribute Name	Tag	VR	Value	Presence of Value	Source
Referenced Series Sequence	0008,1115	SQ		ALWAYS	AUTO
> Referenced Image Sequence	0008,1140	SQ		ALWAYS	AUTO
>> Referenced SOP Class UID	0008,1150	UI	1.3.46.670589.2.3.1.1	ALWAYS	AUTO
>> Referenced SOP Instance UID	0008,1155	UI		ALWAYS	AUTO
> Series Instance UID	0020,000E	UI		ALWAYS	AUTO
Instance Number	0020,0013	IS		ALWAYS	AUTO
Content Label	0070,0080	CS	"AS ACQUIRED"	ALWAYS	USER
Content Description	0070,0081	LO		VNAP	AUTO
Presentation Creation Date	0070,0082	DT	Current Date	ALWAYS	AUTO
Presentation Creation Time	0070,0083	TM	Current Time	ALWAYS	AUTO
Content Creator's Name	0070,0084	PN		VNAP	AUTO

**Table 133: Softcopy PS Storage SOP Class – C-STORE-RQ - Presentation Series Module (M)**

Attribute Name	Tag	VR	Value	Presence of Value	Source
Modality	0008,0060	CS	PR	ALWAYS	AUTO

**Table 134: Softcopy PS Storage SOP Class – C-STORE-RQ - Private Group (M)**

Attribute Name	Tag	VR	Value	Presence of Value	Source
Private Creator Group 2001	2001,0010	CS	Philips Imaging DD 001	ALWAYS	AUTO
Processing Order Specialization	2001,1094	LO	DSI_PROCESSING_ORDER	ANAP	AUTO

**Table 135: Grayscale Softcopy Presentation State Storage SOP Class - Additional Attribute Module (O)**

Attribute Name	Tag	VR	Value	Presence of Value	Source
Examination Source	2001,1063	CS	ELSEWHERE	ANAP	AUTO
Has Edge Enhancement Sequence	2001,106B	SQ		ANAP	USER
> Edge Enhancement Gain Factor Non Sub	2001,1029	FL		ANAP	USER
> Edge Enhancement Taste Non Sub	2001,102B	CS	CONTRASTADAPTIVE	ANAP	USER
> Edge Enhancement Gain Taste	2001,107E	US		ANAP	USER
> Pixel Processing Kernel Size	2001,109F	US		ANAP	USER
Series Type	2001,106E	SH	Series,	ANAP	USER
Mixing Sequence	2001,106F	SQ		ANAP	USER
> Referenced Image Sequence	0008,1140	SQ		ANAP	USER
>> Referenced SOP Class UID	0008,1150	UI	1.3.46.670589.2.3.1.1	ANAP	AUTO
>> Referenced SOP Instance UID	0008,1155	UI		ANAP	USER
> Private Creator Group 2001	2001,0010	LO	Philips Imaging DD 001	ANAP	AUTO



> Presentation State Subtraction Active	2001,1026	CS	NO,	ANAP	USER
> Edge Enhancement Gain Factor Sub	2001,1028	FL		ANAP	USER
> Log Subtraction Gain Step	2001,1030	UL		ANAP	USER
> Mixing NR of Mask Image Numbers	2001,1031	US	If the mask image is not computed out of two or more input mask images (Mixing Mask Operation Type = NONE), then this number is 1 (one).	ANAP	USER
> Mixing Mask Operation	2001,1034	CS	NONE, AVG	ANAP	USER
> Mixing Operation Type	2001,1037	CS	Defined Terms: OVERLAY = Apply overlay operation LIN = Apply linear subtraction LOG = Apply logarithmic subtraction.	ANAP	USER
> Pixel Shift	2001,103A	CS	YES = Apply pixelshift NO = Do not apply pixelshift	ANAP	USER
> Subtraction Land Marking Active	2001,1042	CS	YES = Apply landmarking. NO = Do not apply landmarking.	ANAP	USER
> Referenced Mask Image Sequence	2001,1073	SQ		ANAP	USER
>> Referenced SOP Class UID	0008,1150	UI	1.3.46.670589.2.3.1.1	ANAP	USER
>> Referenced SOP Instance UID	0008,1155	UI		ANAP	USER
>> Referenced Frame Number	0008,1160	IS	1	ANAP	USER
> PIIM Subtraction Type	2001,109D	LO	NORMALSUBTRACTION	ANAP	USER
> LOG Subtraction Curve Taste	2001,10A2	US	DSI: uses taste values in range 0..99 EVNG: uses taste values in range 300..399	ANAP	USER
Harmonisation Sequence	2001,1079	SQ		ALWAYS	USER
> Private Creator Group 2001	2001,0010	LO	Philips Imaging DD 001	ANAP	USER
> Edge Enhancement Taste Adapt Sub	2001,102A	CS	CONTRASTADAPTIVE	ANAP	USER
> Harmonization Factor	2001,102C	FL		ANAP	USER
> Harmonization Gain	2001,102F	FL		ANAP	USER
> Harmonization Offset	2001,104F	FD		ANAP	USER
> Edge Enhancement Gain Taste Sub	2001,107F	US		ANAP	USER
> Pixel Processing Kernel Size	2001,109F	US	row, column	ANAP	USER

#### 8.1.1.4 X-Ray RadioFluoroscopic SOP Class for the ELEVA EDI for the Processed Mode

The following tables give a detailed overview of all supported attributes of the XRF Storage SOP Class. The list of possible values are given. The situation that an attribute is present conditionally / optionally or that an attribute may contain a zero length value, is indicated too. Conditions and Defined / Enumerated Values of DICOM 3.0 are applicable but are not shown in the tables.

**Table 136: Modules of the X-Ray RadioFluoroscopic Image Storage SOP Class**

Information Entity	Module Name	Reference	Presence of Module
Patient	Patient Module	Table 137	ALWAYS
Study	General Study Module	Table 138	ALWAYS
Series	General Series Module	Table 139	ALWAYS
Equipment	General Equipment Module	Table 140	ALWAYS
Image	Image Pixel Module	Table 142	ALWAYS
	General Image Module	Table 141	ALWAYS
	Multi-Frame	Table 143	CONDITIONAL
	Overlay Plane	Table 149	CONDITIONAL
	XRF Positioner	Table 144	ALWAYS
	X-ray Image Module	Table 147	ALWAYS
	X-Ray Acquisition Module	Table 148	ALWAYS
	SOP Common Module	Table 146	ALWAYS
	VOI LUT Module	Table 145	CONDITIONAL
Private	Additional Attributes	Table 150	CONDITIONAL

**Table 137: XRF Image Storage SOP Class - Patient Module (M)**

Attribute Name	Tag	VR	Value	Presence of Value	Source
Patient's Name	0010,0010	PN	Received from RIS or Entered by Operator	VNAP	AUTO
Patient ID	0010,0020	LO	Received from RIS or Entered by Operator	VNAP	AUTO
Patient's Birth Date	0010,0030	DA	Received from RIS or Entered by Operator	VNAP	AUTO
Patient's Sex	0010,0040	CS	Received From RIS or Entered by Operator. F,M,O	VNAP	AUTO

**Table 138: XRF Image Storage SOP Class - General Study Module (M)**

Attribute Name	Tag	VR	Value	Presence of Value	Source
Study Instance UID	0020,000D	UI	Generated at the creation of the study or received from RIS.	ALWAYS	AUTO
Study Date	0008,0020	DA	Current Date	VNAP	AUTO
Study Time	0008,0030	TM	Current Time	VNAP	AUTO
Accession Number	0008,0050	SH	Zero length if not received from RIS	VNAP	AUTO

Referring Physician's Name	0008,0090	PN	Zero length if not received from RIS	VNAP	AUTO
Study Description	0008,1030	LO		ANAP	AUTO
Study ID	0020,0010	SH	Undefined	VNAP	AUTO

**Table 139: XRF Image Storage SOP Class - General Series Module (M)**

Attribute Name	Tag	VR	Value	Presence of Value	Source
Series Date	0008,0021	DA		VNAP	AUTO
Series Time	0008,0031	TM		VNAP	AUTO
Modality	0008,0060	CS	RF	ALWAYS	AUTO
Performing Physicians' Name	0008,1050	PN	Received from RIS, entered by user or is empty if not known.	VNAP	AUTO
Referenced Performed Procedure Step Sequence	0008,1111	SQ		ANAP	AUTO
> Referenced SOP Class UID	0008,1150	UI	1.2.840.10008.3.1.2.3.3	ALWAYS	AUTO
> Referenced SOP Instance UID	0008,1155	UI		ALWAYS	AUTO
Protocol Name	0018,1030	LO		VNAP	AUTO
Series Instance UID	0020,000E	UI		ALWAYS	CONF
Series Number	0020,0011	IS		VNAP	AUTO
Laterality	0020,0060	CS	Always zero length value.	MAYBE	AUTO
Performed Procedure Step Start Date	0040,0244	DA		VNAP	AUTO
Performed Procedure Step Start Time	0040,0245	TM		VNAP	AUTO
Performed Procedure Step ID	0040,0253	SH		ANAP	AUTO
Performed Procedure Step Description	0040,0254	LO		VNAP	AUTO
Request Procedure Sequence	0040,0275	SQ		ANAP	AUTO
> Scheduled Procedure Step ID	0040,0009	SH		ALWAYS	AUTO
> Requested Procedure ID	0040,1001	SH		ALWAYS	AUTO
> Scheduled Procedure Step Description	0040,0007	LO		ANAP	AUTO
> Scheduled Protocol Code Sequence	0040,0008	SQ		ANAP	AUTO
>> Code Value	0008,0100	SH		ANAP	AUTO
>> Coding Scheme Designator	0008,0102	SH		ANAP	AUTO
>> Code Meaning	0008,0104	LO		ANAP	AUTO

**Table 140: XRF Image Storage SOP Class – General Equipment Module (M)**

Attribute Name	Tag	VR	Value	Presence of Value	Source
Manufacturer	0008,0070	LO	Philips Medical Systems	VNAP	AUTO
Institution Name	0008,0080	LO	Hospital	VNAP	AUTO
Station Name	0008,1010	SH	Eleva	ANAP	AUTO
Manufacturer's Model Name	0008,1090	LO	Extended Digital Imaging	VNAP	AUTO
Device Serial Number	0018,1000	LO		VNAP	AUTO
Software Versions	0018,1020	LO	DSI R2.1.2 LUTPROM 04-01-02 R6.1.3.O119 PMS1.1 MIMIT EVIIMDictionary	VNAP	AUTO

**Table 141: XRF Image Storage SOP Class - General Image Module (M)**

Attribute Name	Tag	VR	Value	Presence of Value	Source
Acquisition Date	0008,0022	DA		VNAP	AUTO
Content Date	0008,0023	DA		MAYBE	AUTO
Acquisition Time	0008,0032	TM		ANAP	AUTO
Content Time	0008,0033	TM		MAYBE	AUTO
Acquisition Number	0020,0012	IS		VNAP	AUTO
Instance Number	0020,0013	IS		VNAP	AUTO
Patient Orientation	0020,0020	CS		MAYBE	AUTO

**Table 142: XRF Image Storage SOP Class - Image Pixel Module (M)**

Attribute Name	Tag	VR	Value	Presence of Value	Source
Row	0028,0010	US	1024, 512	ALWAYS	AUTO
Columns	0028,0011	US	1024, 512	ALWAYS	AUTO
Pixel Data	7FE0,0010	OW		ALWAYS	AUTO

**Table 143: XRF Image Storage SOP Class – Multi-Frame Module ( C )**

Attribute Name	Tag	VR	Value	Presence of Value	Source
Frame Increment Pointer	0028,0009	AT		ALWAYS	AUTO

**Table 144: XRF Image Storage SOP Class – XRF Positioner Module ( O )**

Attribute Name	Tag	VR	Value	Presence of Value	Source
Distance Source to Detector	0018,1110	DS		ANAP	AUTO

**Table 145: XRF Image Storage SOP Class – VOI LUT Module (O)**

Attribute Name	Tag	VR	Value	Presence of Value	Source
Window Center	0028,1050	DS	is related to the DI Contrast /Brightness.	ANAP	AUTO
Window Width	0028,1051	DS	is related to the DI Contrast /Brightness.	ANAP	AUTO

**Table 146: XRF Image Storage SOP Class – SOP Common Module(M)**

Attribute Name	Tag	VR	Value	Presence of Value	Source
Specific Character Set	0008,0005	CS	ISO_IR 100	ANAP	AUTO
SOP Class UID	0008,0016	UI	1.2.840.10008.5.1.4.1.1.12.2	ANAP	AUTO
SOP Instance UID	0008,0018	UI		ANAP	AUTO

**Table 147: XRF Image Storage SOP Class – X-Ray Image Module (M)**

Attribute Name	Tag	VR	Value	Presence of Value	Source
Image Type	0008,0008	CS	ORIGINAL, PRIMARY, SINGLE PLANE	ALWAYS	AUTO
Samples per Pixel	0028,0002	US	1	ALWAYS	AUTO
Photometric Interpretation	0028,0004	CS	MONOCHROME2	ALWAYS	AUTO
Bits Allocated	0028,0100	US	8	ALWAYS	AUTO
Bits Stored	0028,0101	US	8	ALWAYS	AUTO
High Bit	0028,0102	US	7	ALWAYS	AUTO
Pixel Representation	0028,0103	US	0	ALWAYS	AUTO
Pixel Intensity Relationship	0028,1040	CS	DISP	ALWAYS	AUTO

**Table 148: XRF Image Storage SOP Class – X-Ray Acquisition Module (M)**

Attribute Name	Tag	VR	Value	Presence of Value	Source
KVP	0018,0060	DS	Always zero length value.	VNAP	AUTO
Exposure	0018,1152	IS		MAYBE	AUTO
Radiation Setting	0018,1155	CS	GR, SC	ALWAYS	AUTO
Exposure Time	0018,1150	IS	Required if Exposure (0018,1152) is not present.	ANAP	AUTO
X-Ray Tube Current	0018,1151	IS	Required if Exposure (0018,1152) is not present.	ANAP	AUTO
Exposure	0018,1152	IS	Required if either Exposure Time (0018,1150) or X-Ray Tube Current (0018,1151) are not present.	MAYBE	AUTO

**Table 149: XRF Image Storage SOP Class - Overlay Plane Module (O)**

Attribute Name	Tag	VR	Value	Presence of Value	Source
Overlay Rows	6000,0010	US	512, 1024	ANAP	AUTO
Overlay Columns	6000,0011	US	512, 1024	ANAP	AUTO
Overlay Time	6000,0040	CS	G	ANAP	AUTO
Overlay Origin	6000,0050	SS	1, 1	ANAP	AUTO
Overlay Bits Allocated	6000,0100	US	1	ANAP	AUTO
Overlay Bits Position	6000,0102	US	0	ANAP	AUTO
Overlay Data	6000,3000	OW		ANAP	AUTO
Overlay Description	60xx,0022	LO		ANAP	AUTO
Overlay Subtype	60xx,0045	LO		ANAP	AUTO
Overlay Label	60xx,1500	LO		ANAP	AUTO
ROI Area	60xx,1301	IS		ANAP	AUTO
ROI Mean	60xx,1302	DS		ANAP	AUTO
ROI Standard Deviation	60xx,1303	DS		ANAP	AUTO

**Table 150: XRF Image Storage SOP Class – Additional Attributes Module ( O )**

Attribute Name	Tag	VR	Value	Presence of Value	Source
Private Creator Group 2001	2001,0010	LO	Philips Imaging DD 001	ANAP	AUTO
Examination Source	2001,1063	CS	ELSEWHERE	ANAP	AUTO
Series Type	2001,106E	SH	Series	ANAP	AUTO
Is Raw Image	2001,10A1	CS	YES, NO	ANAP	AUTO
Nested Object Type Name	2001,10C1	LO	GraphicOverlayPlane	ANAP	AUTO

### 8.1.2 Attribute Mapping

The following table shows the relation between BWLM and MPPS and image Storage attributes.

**Table 151: Attribute Mapping during Modality Workflow**

Name	BWLM Tag	MPPS		Image IOD Tag
		Create Tag	Set Tag	
Specific Character Set	0008,0005	-	-	0008,0005
Accession Number	0008,0050	0008,0050	-	0008,0050
Modality	0008,0060	0008,0060	-	0008,0060
Referring Physician's Name	0008,0090	-	-	0008,0090
Operators' Name	-	-	0008,1070	0008,1070
Referenced Study Sequence	0008,1110	0008,1110	-	0008,1110
Referenced Image Sequence	0008,1150	0008,1140	0008,1140	0008,1140
> Referenced SOP Class UID	-	0008,1150	0008,1150	0008,1150
SOP Class UID	-	0008,1150	0008,1150	0008,1150
> Referenced SOP Instance UID	-	0008,1155	0008,1155	0008,1155
SOP Instance UID	-	0008,1155	0008,1155	0008,1155

Name	BWL M Tag	MPPS		Image IOD Tag
		Create Tag	Set Tag	
Patient's Name	0010,0010	0010,0010	-	0010,0010
Patient ID	0010,0020	0010,0020	-	0010,0020
Patient's Birth Date	0010,0030	0010,0030	-	0010,0030
Patient's Sex	0010,0040	0010,0040	-	0010,0040
Other Patient IDs	0010,1000	-	-	0010,1000
Patient's Size	0010,1020	-	-	0010,1020
Patient's Weight	0010,1030	-	-	0010,1030
Patient's Telephone Numbers	0010,2154	-	-	0010,2154
Medical Alerts	0010,2000	-	-	0010,2000
Contrast Allergies	0010,2110	-	-	0010,2110
Ethnic group	0010,2160	-	-	0010,2160
Additional Patient History	0010,21B0	-	-	0010,21B0
Patient Comments	0010,4000	-	-	0010,4000
KVP	-	-	0018,0060	0018,0060
Protocol Name	-	-	0018,1030	0018,1030
Image Area Dose Product	-	-	0018,115E	0018,115E
Study Instance UID	0020,000D	0020,000D	-	0020,000D
Series Instance UID	-	-	0020,000E	0020,000E
Study ID	-	0020,0010	-	0020,0010
Requested Procedure Description	0032,1060	0032,1060	-	-
Scheduled Procedure Step Description	0040,0007	0040,0007	-	0040,0007
Performed Procedure Step Description	-	0040,0254	0040,0254	0040,0254
Scheduled Protocol Code Sequence	0040,0008	0040,0008	-	0040,0008
Performed Protocol Code Sequence	-	0040,0260	0040,0260	0040,0260
Scheduled Procedure Step ID	0040,0009	0040,0009	-	0040,0009
Performed Procedure Step Start Date	-	0040,0244	-	0040,0244
Performed Procedure Step Start Time	-	0040,0245	-	0040,0245
Performed Procedure Step ID	-	0040,0253	-	0040,0253
Requested Procedure ID	0040,1001	0040,1001	-	0040,1001

### 8.1.3 Coerced / Modified fields

In general, ELEVA EDI (Ditto) ViewForum will try and optimize the imported image data. This may involve the removal of redundant data, either or not due to the creation of a Grayscale Softcopy Presentation State object for the image data. This may also involve the creation of extra attributes. As it is not the intention of ELEVA EDI (Ditto) ViewForum to export this data as such, the SOP Instance UID shall not be changed.

If not available at import then ELEVA EDI (Ditto) ViewForum will create the additional attributes as listed in the Table below.

**Table 152: Additional Attributes for Import Images**

Name	Tag	Generated Value
Performed Procedure Step Start Date	0040,0244	Copied from (0008,0020) Study Date.
Performed Procedure Step Start Time	0040,0245	Copied from (0008,0030) Study Time.
Performed Procedure Step ID	0040,0253	Copied from (0020,0010) Study ID.
Performed Procedure Step Description	0040,0254	Copied from (0008,1030) Study Description.

If the SCU does not propose a Presentation Context for the Grayscale Softcopy Presentation State storage SOP class, then ELEVA EDI (Ditto) ViewForum will derive Grayscale Softcopy Presentation State data from the imported image data and store this data in a new series within the examination of the imported image.

However, if during import the image is accompanied by Grayscale Softcopy Presentation State data, the ELEVA EDI (Ditto) ViewForum database shall avoid data overlap by only storing the relevant data from the first object received; either the first image or its Presentation State!

Thus it will omit data received by succeeding objects concerning the optional attributes (VT=3) listed in Table 153, and clear all mandatory attributes (VT=2) listed in Table 154.

**Table 153: Omitted Attributes for Import Images**

Attribute Name	Tag	VR	Comment
<b>Patient Module</b>			
Referenced Patient Sequence	0008,1120	SQ	
Patient's Birth Time	0010,0032	TM	
Other Patient's Id's	0010,1000	LO	
Other Patient's Names	0010,1001	PN	
Ethnic Group	0010,2160	SH	
Patient Comments	0010,4000	LT	
<b>General Study Module</b>			
Referring Physician Identification Sequence	0008,0096	SQ	
Study Description	0008,1030	LO	
Procedure Code Sequence	0008,1032	SQ	
Physician(s) of Record	0008,1048	PN	
Physician(s) of Record Identification Sequence	0008,1049	SQ	
Name of Physician(s) Reading Study	0008,1060	PN	
Physician(s) Reading Study Identification Sequence	0008,1062	SQ	
Referenced Study Sequence	0008,1110	SQ	
<b>Patient Study Module</b>			
Admitting Diagnoses Description	0008,1080	LO	
Admitting Diagnoses Code Sequence	0008,1084	SQ	
Patient's Age	0010,1010	AS	
Patient's Size	0010,1020	DS	
Patient's Weight	0010,1030	DS	
Occupation	0010,2180	SH	
Additional Patient's History	0010,21B0	LT	
<b>Clinical Trial Study Module</b>			
Clinical Trial Time Point Description	0012,0051	ST	
<b>General Series Module</b>			
Series Date	0008,0021	DA	
Series Time	0008,0031	TM	
Series Description	0008,103E	LO	
Performing Physicians' Name	0008,1050	PN	
Performing Physician Identification Sequence	0008,1052	SQ	
Operators' Name	0008,1070	PN	
Operators Identification Sequence	0008,1072	SQ	
Referenced Performed Procedure Step Sequence	0008,1111	SQ	
Body Part Examined	0018,0015	CS	
Protocol Name	0018,1030	LO	



Attribute Name	Tag	VR	Comment
Smallest Pixel Value in Series	0028,0108	US/SS	
Largest Pixel Value in Series	0028,0109	US/SS	
Performed Procedure Step Start Date	0040,0244	DA	
Performed Procedure Step Start Time	0040,0245	TM	
Performed Procedure Step ID	0040,0253	SH	
Performed Procedure Step Description	0040,0254	LO	
Performed Protocol Code Sequence	0040,0260	SQ	
Request Attributes Sequence	0040,0275	SQ	
Comments on the Performed Procedure Step	0040,0280	ST	
<b>General Equipment Module</b>			
Institution Name	0008,0080	LO	
Institution Address	0008,0081	SH	
Station Name	0008,1010	SH	
Institutional Department Name	0008,1040	LO	
Manufacturer's Model Name	0008,1090	LO	
Device Serial Number	0018,1000	LO	
Software Versions	0018,1020	LO	
Spatial Resolution	0018,1050	DS	
Date of Last Calibration	0018,1200	DA	
Time of Last Calibration	0018,1201	TM	
Pixel Padding Value	0028,0120	US/SS	
<b>Display Shutter Module</b>			
Shutter Presentation Value	0018,1622	US	
<b>Overlay Plane Module</b>			
Overlay Description	60xx,0022	LO	
Overlay Subtype	60xx,0045	LO	
ROI Area	60xx,1301	IS	
ROI Mean	60xx,1302	DS	
ROI Standard Deviation	60xx,1303	DS	
Overlay Label	60xx,1500	LO	
<b>SOP Common Module</b>			
Instance Creation Date	0008,0012	DA	
Instance Creation Time	0008,0013	TM	
Instance Creator UID	0008,0014	UI	
Coding Scheme Identification Sequence	0008,0110	SQ	
Timezone Offset From UTC	0008,0201	SH	
Contributing Equipment Sequence	0018,A001	SQ	
Instance Number	0020,0013	IS	
SOP Instance Status	0100,0410	CS	
SOP Authorization Date and Time	0100,0420	DT	
SOP Authorization Comment	0100,0424	LT	
Authorization Equipment Certification Number	0100,0426	LO	
MAC Parameters Sequence	4FFE,0001	SQ	
Digital Signatures Sequence	FFFA,FFFA	SQ	

Table 154: Cleared Attributes for Import Images

Attribute Name	Tag	VR	Comment
<b>Patient Module</b>			
Patient's Name	0010,0010	PN	

Attribute Name	Tag	VR	Comment
Patient ID	0010,0020	LO	
Patient's Birth Date	0010,0030	DA	
Patient's Sex	0010,0040	CS	
Clinical Trial Subject Module			
Clinical Trial Protocol Name	0012,0021	LO	
Clinical Trial Site ID	0012,0030	LO	
Clinical Trial Site Name	0012,0031	LO	
General Study Module			
Study Date	0008,0020	DA	
Study Time	0008,0030	TM	
Accession Number	0008,0050	SH	
Referring Physician's Name	0008,0090	PN	
Study ID	0020,0010	SH	
Clinical Trial Study Module			
Clinical Trial Time Point ID	0012,0050	LO	
General Series Module			
Patient Position	0018,5100	CS	
Series Number	0020,0011	IS	
Laterality	0020,0060	CS	
Clinical Trial Series Module			
Clinical Trial Coordinating Center Name	0012,0060	LO	
General Equipment Module			
Manufacturer	0008,0070	LO	
Mask Module			
Recommended Viewing Mode	0028,1090	CS	
Overlay/Curve Activation Module			
Curve Activation Layer	50xx,1001	CS	
Overlay Activation Layer	60xx,1001	CS	

ELEVA EDI (Ditto) ViewForum allows the operator to modify attributes of the stored images; see Table 155.

ELEVA EDI (Ditto) ViewForum does not modify the pixel values of the stored images. Modified images retain their original Study, Series and Image UID.

**Table 155: Modifiable Attributes**

Attribute Name	Tag	VR	Comment
Patient			
Patient's Name	0010,0010	PN	
Patient ID	0010,0020	LO	
Patient's Birth Date	0010,0030	DA	
Patient's Sex	0010,0040	CS	
Medical Alerts	0010,2000	LO	
Contrast Allergies	0010,2110	LO	
Patient Comments	0010,4000	LT	
Study			
Accession Number	0008,0050	SH	
Referring Physician's Name	0008,0090	PN	
Study Description	0008,1030	LO	
Physician(s) of Record	0008,1048	PN	
Name of Physician(s) Reading Study	0008,1060	PN	
Admitting Diagnoses Description	0008,1080	LO	

Attribute Name	Tag	VR	Comment
Patient's Age	0010,1010	AS	
Occupation	0010,2180	SH	
Additional Patient History	0010,21B0	LT	
<b>Examination</b>			
Performed Station Name	0040,0242	SH	
Performed Location	0040,0243	SH	
Performed Procedure Step Description	0040,0254	LO	
Performed Procedure Type Description	0040,0255	LO	
Comments on the Performed Procedure Step	0040,0280	ST	
<b>Series</b>			
-	-		

## 8.2 Data Dictionary of Private Attributes

Not applicable.

## 8.3 Coded Terminology and Templates

Not applicable.

## 8.4 Grayscale Image consistency

The high-resolution display monitor attached to the product can be calibrated by using the service tool together with a light probe. See the [VFRB] for details on the calibration procedure.

## 8.5 Standard Extended/Specialized/Private SOPs

The Standard DICOM SOP Classes may be Extended with additional attributes:

Standard attributes of other SOP Classes; the presence of these attributes in exported images can be configured, see section 4.2.1.3.1.3

Retired (from ACR NEMA 1.0 or 2.0) attributes; the presence of these attributes in exported images can be configured, see section 4.2.1.3.1.3

Private attributes; the presence of these attributes in exported images can be configured, see section 4.2.1.3.1.3

The Table 156 list the supported Private SOP Classes. The usage of these SOP Classes are in the ELEVA EDI Systems ViewForum domain only. However instances of these Private SOP Classes may be exported towards a PACS environment and stored in a (central) DICOM archive and should be configured in order to make this possible.

**Table 156: Private SOP classes of ELEVA EDI ViewForum System**

<b>SOP Class</b>	<b>Description</b>
3D Volume Storage (Private class)	1.3.46.670589.5.0.1.1
3D Volume Object Storage (Private class)	1.3.46.670589.5.0.2.1
Surface Storage (Private class)	1.3.46.670589.5.0.3.1
CT Synthetic Image (Private class)	1.3.46.670589.5.0.9
MR Synthetic Image (Private class)	1.3.46.670589.5.0.10
MR Cardio Storage (Private class)	1.3.46.670589.5.0.8.1
MR Cardio Analysis Storage (Private class)	1.3.46.670589.5.0.11.1
Specialized X-ray (Private class)	1.3.46.670589.2.3.1.1
CX Image (Private class)	1.3.46.670589.2.4.1.1
CX Synthetic Image (Private class)	1.3.46.670589.5.0.12
Perfusion (Private class)	1.3.46.670589.5.0.13
Perfusion Analysis (Private class)	1.3.46.670589.5.0.14

## 8.6 Private Transfer Syntaxes

None.