

DICOM Conformance Statement

IQon scanner Powered by iPatient



Issued by:

Philips Medical Systems Nederland BV, a Philips Healthcare company,

P.O. Box 10.000
5680 DA Best
The Netherlands

Email: dicom@philips.com

Internet: http://www.healthcare.philips.com/main/about/Connectivity/dicom_conformance_main.wpd

Document Number: ICAP-PF.0018219

Date: 22-10-2015

1. DICOM Conformance Statement Overview

This version of the DICOM Conformance Statement applies to the CT IQon scanners running on the iPatient (4.x) platform. The iPatient (4.x) platform is available across the iCT Elite, iCT TVI, iCT, iCT SP, Ingenuity Elite, Ingenuity CT, Ingenuity Core¹²⁸, Ingenuity Core and IQon CT scanners

The IQon CT scanner provides the following DICOM data exchange features:

- Store DICOM Images sent from a Workstation or PACS
- Transfer DICOM Images to a Workstation or PACS
- Query/Retrieve a Workstation or PACS for a list of entries representing Series of DICOM Images
- Query/Retrieve support to let a remote system query for a list of entries representing Series of DICOM Images
- Query a HIS/RIS for a MWL
- Update a remote system with information about Performed Procedure Steps (MPPS)
- Store DICOM Images on portable media (CD, CD-RW, DVD+/-R and DVD+/-RW disks)
- Read DICOM Images from a portable media
- Print Images (Grayscale and Color) on a DICOM Printer

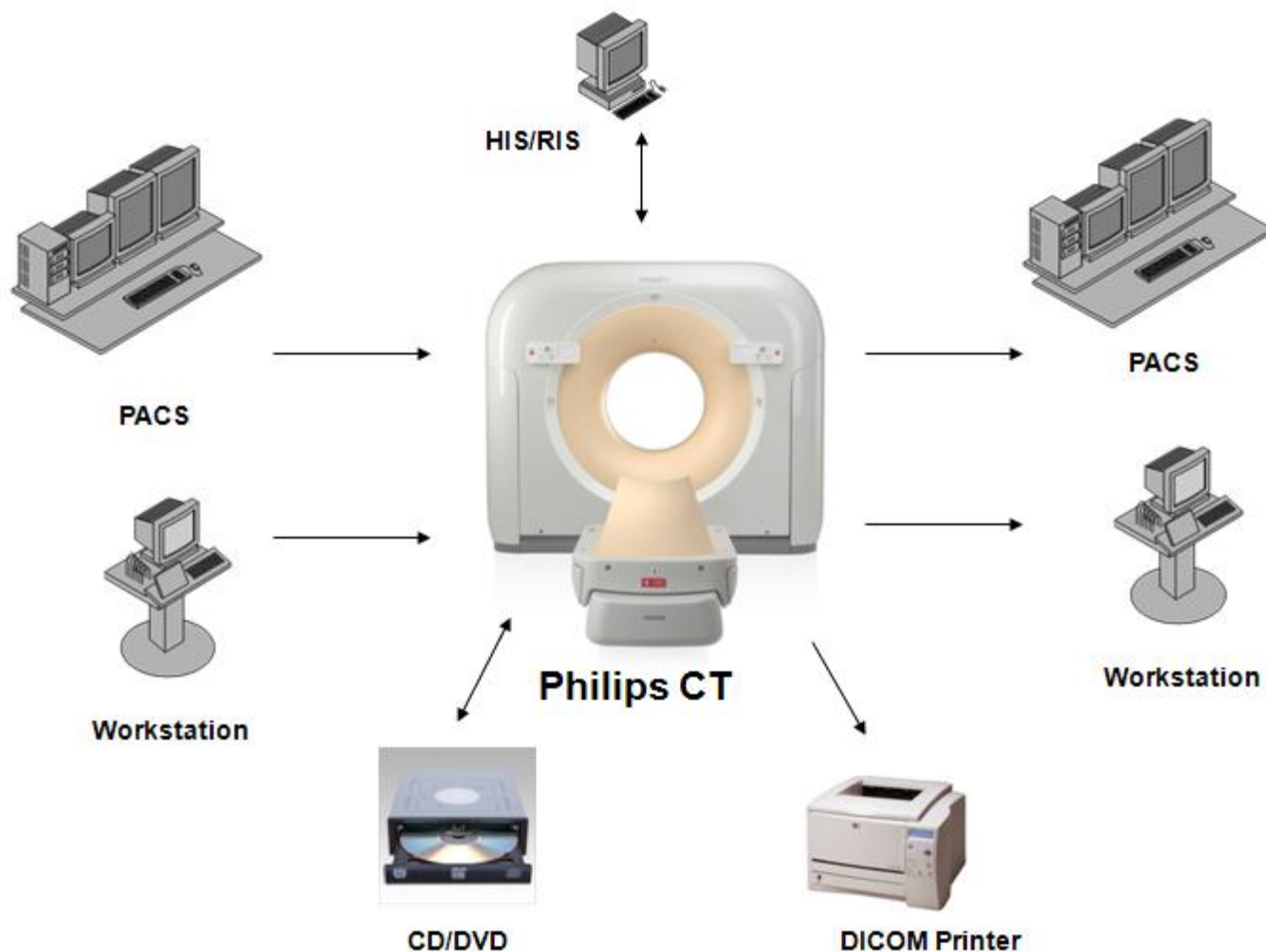

Figure 1: IQon CT in a workflow

The following Table presents an overview of all network services and the applicable SOP Classes as provided by the IQon CT scanner, where the first column specifies the used SOP Classes as named in PS 3.6 (Ref PS 3.2 Annex A) of the current DICOM Standard.

Table 1: Network Services

SOP Class		User of Service (SCU)	Provider of Service (SCP)
Name	UID		
Other			
Verification SOP Class	1.2.840.10008.1.1	Yes	Yes
Print Management			
Basic Color Print Management Meta SOP Class	1.2.840.10008.5.1.1.18	Yes	No
>Basic Film Session SOP Class	1.2.840.10008.5.1.1.1	Yes	No
Basic Grayscale Print Management Meta SOP Class	1.2.840.10008.5.1.1.9	Yes	No
>Basic Film Session SOP Class	1.2.840.10008.5.1.1.1	Yes	No
Query/Retrieve			
Study Root QR Information Model - FIND SOP Class	1.2.840.10008.5.1.4.1.2.2.1	Yes	Yes
Study Root QR Information Model - MOVE SOP Class	1.2.840.10008.5.1.4.1.2.2.2	Yes	Yes
Transfer			
Computed Radiography Image Storage SOP Class	1.2.840.10008.5.1.4.1.1.1	Yes	Yes
Digital X-Ray Image Storage - For Pres. SOP	1.2.840.10008.5.1.4.1.1.1.1	Yes	Yes
Digital X-Ray Image Storage - For Proc. SOP	1.2.840.10008.5.1.4.1.1.1.1.1	Yes	Yes
X-Ray Angiographic Image Storage SOP Class	1.2.840.10008.5.1.4.1.1.12.1	Yes	Yes
X-Ray Radiofluoroscopic Image Storage SOP Class	1.2.840.10008.5.1.4.1.1.12.2	Yes	Yes
CT Image Storage SOP Class	1.2.840.10008.5.1.4.1.1.2	Yes	Yes
Secondary Capture Image Storage SOP Class	1.2.840.10008.5.1.4.1.1.7	Yes	Yes
X-Ray Radiation Dose SR	1.2.840.10008.5.1.4.1.1.88.67	Yes	Yes
General ECG Waveform Storage SOP Class	1.2.840.10008.5.1.4.1.1.9.1.2	Yes	Yes
Workflow Management			
Modality Worklist Information Model - FIND SOP Class	1.2.840.10008.5.1.4.31	Yes	No
Modality Performed Procedure Step SOP Class	1.2.840.10008.3.1.2.3.3	Yes	No
Storage Commitment Push Model SOP Class	1.2.840.10008.1.20.1	Yes	No

Notes: Normally the system (SCU) requests only supported DICOM objects. All SOP Classes support the default ILE Transfer Syntax. All transfer Syntaxes are configurable in LAN Config.

Not supported is JPEG transfer syntax for all SOP classes if the IODs have no pixel data and for all non-storage SOP classes.

For media the IQon CT supports:

- FSC service for CD-R, CD-RW, DVD + R, DVD - R, DVD + RW, DVD - RW media
- FSR service for CD-R, CD-RW, DVD + R, DVD - R, DVD + RW, DVD - RW media

After data is written to DVD, the DVD is finalized; the finalized DVD can now be read on mostly every DVD reader.

All the Media Services supported by IQon CT are shown in the next table.

Table 2: Media Services

Media Storage Application Profile	File-set Creator (FSC)	File-set Updater (FSU)	File-set Reader (FSR)
Compact Disk-Recordable			
CT/MR Studies on CD-R	Yes	No	Yes
General Purpose CD-R Interchange	Yes	No	Yes
DVD			
CT/MR Studies on DVD Media	Yes	No	Yes
General Purpose DVD Interchange with JPEG	Yes	No	Yes

2. Table of Contents

1.	DICOM Conformance Statement Overview	3
2.	Table of Contents	7
3.	Introduction	10
3.1.	REVISION HISTORY	10
3.2.	AUDIENCE	10
3.3.	REMARKS	10
3.4.	DEFINITIONS, TERMS AND ABBREVIATIONS	11
3.5.	REFERENCES	12
4.	Networking	13
4.1.	IMPLEMENTATION MODEL	13
4.1.1.	Application Data Flow	13
4.1.2.	Functional Definition of AE's	15
4.1.2.1.	Functional Definition of DICOM Manager	15
4.1.2.2.	Functional Definition of Print Manager	16
4.1.3.	Sequencing of Real World Activities	16
4.2.	AE SPECIFICATIONS	16
4.2.1.	DICOM Manager	16
4.2.1.1.	SOP Classes	17
4.2.1.2.	Association Policies	17
4.2.1.2.1.	General	17
4.2.1.2.2.	Number of Associations	17
4.2.1.2.3.	Asynchronous Nature	18
4.2.1.2.4.	Implementation Identifying Information	18
4.2.1.2.5.	Communication Failure Handling	18
4.2.1.3.	Association Initiation Policy	18
4.2.1.3.1.	(Real-World) Activity – Verification as SCU	19
4.2.1.3.2.	(Real-World) Activity – Modality worklist as SCU	21
4.2.1.3.3.	(Real-World) Activity – Modality Performed Procedure Step as SCU	24
4.2.1.3.4.	(Real-World) Activity – FIND as SCU	29
4.2.1.3.5.	(Real-World) Activity – MOVE as SCU	32
4.2.1.3.6.	(Real-World) Activity – Image Export	34
4.2.1.3.7.	(Real-World) Activity – Storage Commitment Push Model AS SCU	38
4.2.1.4.	Association Acceptance Policy	41
4.2.1.4.1.	(Real-World) Activity – Verification as SCP	41
4.2.1.4.2.	(Real-World) Activity – FIND as SCP	43
4.2.1.4.3.	(Real-World) Activity – MOVE as SCP	45
4.2.1.4.4.	(Real-World) Activity – Image Import	47
4.2.2.	Print Manager	50
4.2.2.1.	SOP Classes	50
4.2.2.2.	Association Policies	50
4.2.2.2.1.	General	50
4.2.2.2.2.	Number of Associations	50
4.2.2.2.3.	Asynchronous Nature	50
4.2.2.2.4.	Implementation Identifying Information	51
4.2.2.2.5.	Communication Failure Handling	51
4.2.2.3.	Association Initiation Policy	51
4.2.2.3.1.	(Real-World) Activity – Print Management as SCU	52
4.2.2.4.	Association Acceptance Policy	64
4.3.	NETWORK INTERFACES	64
4.3.1.	Physical Network Interfaces	64
4.3.2.	Additional Protocols	64
4.4.	CONFIGURATION	64
4.4.1.	AE Title/Presentation Address Mapping	64

4.4.1.1.	Local AE Titles.....	64
4.4.1.2.	Remote AE Title/Presentation Address Mapping.....	64
4.4.2.	Parameters.....	64
5.	Media Interchange	67
5.1.	IMPLEMENTATION MODEL	67
5.1.1.	Application Data Flow Diagram	67
5.1.2.	Functional Definitions of AE's.....	67
5.1.3.	Sequencing of Real World Activities	67
5.2.	AE SPECIFICATIONS	68
5.2.1.	Media AE Media - Specification	68
5.2.1.1.	File Meta Information for the Media AE	69
5.2.1.2.	Real-World Activities.....	69
5.2.1.2.1.	RWA - Read File-set.....	69
5.2.1.2.2.	RWA - Create File-set.....	70
5.2.1.2.3.	RWA - Display Directory	72
5.3.	AUGMENTED AND PRIVATE APPLICATION PROFILES.....	73
5.4.	MEDIA CONFIGURATION	73
6.	Support of Character Sets.....	74
7.	Security.....	75
7.1.	SECURITY PROFILES	75
7.1.1.	Security use Profiles	75
7.1.2.	Security Transport Connection Profiles	75
7.1.3.	Digital Signature Profiles	75
7.1.4.	Media Storage Security Profiles	75
7.1.5.	Attribute Confidentiality Profiles	75
7.1.6.	Network Address Management Profiles	77
7.1.7.	Time Synchronization Profiles	77
7.1.8.	Application Configuration Management Profiles.....	77
7.1.9.	Audit Trail Profiles	77
7.2.	ASSOCIATION LEVEL SECURITY.....	77
7.3.	APPLICATION LEVEL SECURITY	77
8.	Annexes of applications.....	78
8.1.	IQON CT ACQUISITION APPLICATION.....	78
8.1.1.	IOD contents (For conventional images).....	78
8.1.1.1.	Created SOP Instances	78
8.1.1.2.	List of created SOP Classes	80
8.1.1.2.1.	CT Image Storage SOP Class	80
8.1.1.2.2.	Secondary Capture Image Storage SOP Class	85
8.1.1.2.3.	General ECG Waveform Storage SOP Class	89
8.1.1.2.4.	X-Ray Radiation Dose SR	91
8.1.2.	IOD contents (For spectral images)	95
8.1.2.1.	Created SOP Instances	95
8.1.2.2.	List of created SOP Classes	97
8.1.2.2.1.	Monochromatic Image (MONO-E)	97
8.1.2.2.2.	Spectral HU-Modified Images	100
8.1.2.2.3.	Spectral non-HU Images	103
8.1.2.2.4.	Spectral Color Images	107
8.1.2.2.5.	Spectral Base Images (SBI)	110
8.1.2.2.6.	Spectral High/Low Images	113
8.1.3.	Usage of Attributes from Received IOD	115
8.1.4.	Attribute Mapping	115
8.1.5.	Coerced/Modified fields.....	115
8.1.6.	Data Dictionary of Private Attributes	116
8.1.7.	Coded Terminology and Templates	116
8.1.7.1.	Context Groups.....	116

8.1.7.2.	Template Specifications.....	116
8.1.7.2.1.	TID 10011 CT Radiation Dose.....	117
8.1.7.2.2.	TID 10012 CT Accumulated Dose	117
8.1.7.2.3.	TID 10013 CT Irradiation Event Data.....	118
8.1.7.2.4.	TID 1002 Observer Context.....	119
8.1.7.2.5.	TID 1004 Device Observer Identifying Attributes	119
8.1.7.2.6.	TID 1020 Person Participant.....	120
8.1.7.2.7.	TID 10014 Scanning Length	120
8.1.7.2.8.	TID 10015 CT Dose Check Details.....	120
8.1.7.3.	Private code definitions.....	121
8.1.8.	Grayscale Image consistency	122
8.1.9.	Standard Extended/Specialized/Private SOPs.....	122
8.1.9.1.	CT Image Storage SOP Class.....	122
8.1.9.2.	Secondary Capture Image Storage SOP Class.....	122
8.1.9.3.	General ECG Waveform Storage SOP Class.....	123
8.1.10.	Private Transfer Syntaxes	123

3. Introduction

3.1. Revision History

The revision history provides dates and differences of the different releases.

Table 3: Revision History

Document Version	Date of Issue	Description
00	09-Jun-2015	Initial version
01	02-Sep-2015	Document updated with DICOM verification test results.

3.2. Audience

This Conformance Statement is intended for:

- (Potential) customers
- System integrators of medical equipment
- Marketing staff interested in system functionality
- Software designers implementing DICOM interfaces

It is assumed that the reader is familiar with the DICOM standard.

3.3. Remarks

The DICOM Conformance Statement is contained in chapter 4 through 8 and follows the contents and structuring requirements of DICOM PS 3.2.

This DICOM Conformance Statement by itself does not guarantee successful interoperability of Philips equipment with non-Philips equipment. The user (or user's agent) should be aware of the following issues:

- **Interoperability**
Interoperability refers to the ability of application functions, distributed over two or more systems, to work successfully together. The integration of medical devices into an IT environment may require application functions that are not specified within the scope of DICOM. Consequently, using only the information provided by this Conformance Statement does not guarantee interoperability of Philips equipment with non-Philips equipment. It is the user's responsibility to analyze thoroughly the application requirements and to specify a solution that integrates Philips equipment with non-Philips equipment.
- **Validation**
Philips equipment has been carefully tested to assure that the actual implementation of the DICOM interface corresponds with this Conformance Statement. Where Philips equipment is linked to non-Philips equipment, the first step is to compare the relevant Conformance Statements. If the Conformance Statements indicate that successful information exchange should be possible, additional validation tests will be necessary to ensure the functionality, performance, accuracy and stability of image and image related data. It is the responsibility of the user (or user's agent) to specify the appropriate test suite and to carry out the additional validation tests.
- **New versions of the DICOM Standard**
The DICOM Standard will evolve in future to meet the user's growing requirements and to incorporate new features and technologies. Philips is actively involved in this evolution and plans to adapt its equipment to future versions of the DICOM Standard. In order to do so, Philips reserves the right to make changes to its products or to discontinue its delivery. The user should ensure that any non-Philips provider linking to Philips equipment also adapts to future versions of the DICOM Standard. If not, the incorporation of DICOM enhancements into Philips equipment may lead to loss of connectivity (in case of networking) and incompatibility (in case of media).

3.4. Definitions, Terms and Abbreviations

Table 4: Definitions, Terms and Abbreviations

Abbreviation/Term	Explanation
AE	Application Entity
ANSI	American National Standard Institute
AP	Application Profile
BOT	Basic Offset Table
CD	Compact Disc
CD-R	CD-Recordable
CD-M	CD-Medical
CR	Computed Radiography
CT	Computed Tomography
DCR	Dynamic Cardio Review
DICOM	Digital Imaging and Communications in Medicine
DIMSE	DICOM Message Service Element
DIMSE-C	DIMSE-Composite
DIMSE-N	DIMSE-Normalized
DVD	Digital Versatile Disc
DX	Digital X-Ray
EBE	DICOM Explicit VR Big Endian
ELE	DICOM Explicit VR Little Endian
FSC	File-set Creator
FSR	File-set Reader
FSU	File-set Updater
GUI	Graphic User Interface
HIS	Hospital Information System
HL7	Health Level Seven
ILE	DICOM Implicit VR Little Endian
IOD	Information Object Definition
ISIS	Information System - Imaging System
LanConfig	Service utility available on IQon
MOD	Magneto-Optical Disk
MPPS	Modality Performed Procedure Step
MR	Magnetic Resonance
NEMA	National Electrical Manufacturers Association
NM	Nuclear Medicine
PDU	Protocol Data Unit
P-ELE	Private CT Transfer Syntax - Explicit Little Endian
PET	Positron Emission Tomography
RF	X-Ray Radiofluoroscopic
RIS	Radiology Information System
RT	Radiotherapy
RWA	Real-World Activity
SC	Secondary Capture
SCM	Study Component Management
SCP	Service Class Provider
SCU	Service Class User

Abbreviation/Term	Explanation
SOP	Service Object Pair
TCP/IP	Transmission Control Protocol/Internet Protocol
UID	Unique Identifier
US	Ultrasound
USMF	Ultrasound Multi-frame
WLM	Worklist Management
XA	X-Ray Angiographic

3.5. References

[DICOM] Digital Imaging and Communications in Medicine, Parts 1 - 18 (NEMA PS 3.1- PS 3.18), National Electrical Manufacturers Association (NEMA)
Publication Sales 1300 N. 17th Street, Suite 1752 Rosslyn, Virginia. 22209, United States Of America
Internet: <http://medical.nema.org/>
Note that at any point in time the official standard consists of the most recent yearly edition of the base standard (currently 2015) plus all the supplements and correction items that have been approved as Final Text.

4. Networking

This section contains the networking related services (vs. the media related ones).

4.1. Implementation model

The implementation model consists of three sections:

- The application data flow diagram, specifying the relationship between the Application Entities and the "external world" or Real-World Activities,
- A functional description of each Application Entity, and
- The sequencing constraints among them.

4.1.1. Application Data Flow

The IQon CT system implements and provides DICOM services using the following Application Entities:

- DICOM-Manager
- Print-Manager

The IQon CT scanner system consists of two Application Entities. The following figure shows the Networking application data flow as a functional overview of the IQon CT scanner. As depicted in the Figure, the IQon CT scanner incorporates the following functionality.

- After RWA Create and Set Modality Performed Procedure Step, the IQon CT scanner as SCU uses the MPPS Service Class to report the modality performed procedure step.
- After operator RWA Request Modality Worklist, the IQon CT scanner as SCU uses the Basic Worklist Management Service Class to request the worklist from a DICOM Radiology information system (RIS).
- After RWA Request Verification, the IQon CT scanner as SCP provides standard Verification Service Class functionality to the requesting SCU.
- After RWA Import Images, the IQon CT scanner as SCP provides standard Storage Service Class functionality to the requesting SCU.
- After RWA Query Local Images/Retrieve Local Images, the IQon CT scanner as SCP provides standard Query/Retrieve Service Class functionality to the requesting SCU.
- After RWA Export Images (triggered by either the operator or RWA Retrieve Local Images), the IQon CT scanner as SCU uses the Remote SCP Storage Service Class functionality to store Local Images on a Remote Database.
- After operator RWA Find Remote Images, the IQon CT scanner as SCU uses the remote SCP Query/Retrieve Service Class functionality to query remote images.
- After operator RWA Move Remote Images, the IQon CT scanner as SCU uses the remote SCP Query/Retrieve Service Class functionality to retrieve remote images.
- After operator RWA Request Storage Commitment, the IQon CT scanner as SCU uses the remote SCP Storage Commitment Service Class functionality to commit remote images.
- After operator RWA Print Images, the IQon CT scanner as SCU uses the remote Print Management Service Class to print local images.

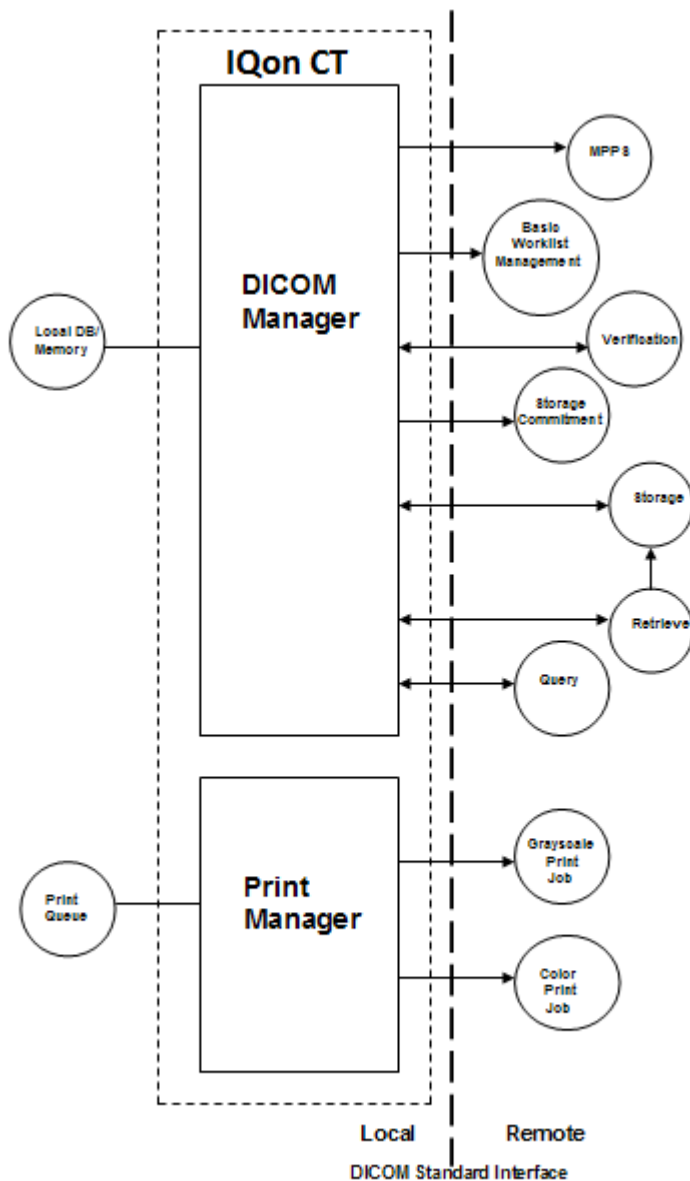

Figure 2: Network Data Flow Diagram

4.1.2. Functional Definition of AE's

This section contains a functional definition for each individual local Application Entity.

4.1.2.1. Functional Definition of DICOM Manager

The DICOM Manager includes the following service classes:

Storage Service

When performing a Storage Service Class (SCP), the DICOM Manager will receive images and store them into the system's local database. The same AE may be used (with a configurable different AE title) to access the local CD/DVD or different local hard disk folders.

Storage Commitment Service

The DICOM Manager is responsible to issue and support the storage commitment service as SCU.

The DICOM Manager establishes association with the specified AE title and sends storage commitment (N-ACTION) request using the push model. After that, it may accept storage commitment (N-EVENT-REPORT) requests on the same association or by establishing another association.

Query-Retrieve Service

The DICOM Manager waits for another application to connect at the presentation address configured for its AE title. The DICOM Manager will accept associations with Presentation Contexts for Service Object Pair (SOP) classes for

- Storage Service Classes (C-STORE)
- Query-Retrieve Service Class (C-MOVE and C-FIND only)
- Verification Service Classes.

When performing Query-Retrieve Service Class (C-FIND SCP), the DICOM Manager will query its local database according to the request's parameters, and will send the results to the issuer.

When performing Query-Retrieve Service Class (C-MOVE SCP), the DICOM Manager will issue a C-STORE (SCU) to the target AE for every image found according to the request.

Import Service

Imported data object received from an external system will be inserted into the local data base with all the original attributes (including private), except those that jeopardize database integrity or further processing by applications.

Export Service

When an object is exported from the local database to an external device, the attributes will be preserved unless an Export Converter is applied.

MPPS / MWL

The DICOM Manager allows the IQon CT scanner software to communicate with a remote HIS/RIS system (as SCU) for the scheduled study information. The DICOM Manager gets requests from the Study program responsible for carrying out the whole scanning procedure, and reports the study start/finish conditions back to HIS/RIS.

The server translates these internal requests into DICOM Modality Worklist Management and MPPS Services Class commands.

The DICOM Manager can perform the following activities:

- Establish an association with a remote AE.
- Release an association with a remote AE.
- Issue a C-FIND request to get Modality Worklist Management scheduling information.
- Issue N-CREATE and N-SET requests to notify HIS/RIS by means of MPPS Service Class.

4.1.2.2. Functional Definition of Print Manager

The Print-Manager is a Graphical User Interface (GUI) based application. It enables the user to print predefined images using the DICOM protocol. The user can specify as a printing destination one of several predefined printers. The user can also modify some of the printing parameters such as the film size and format.

4.1.3. Sequencing of Real World Activities

This section contains description of specific sequencing as well as potential constraints of Real-World Activities, including any applicable user interactions, as performed by the DICOM Manager.

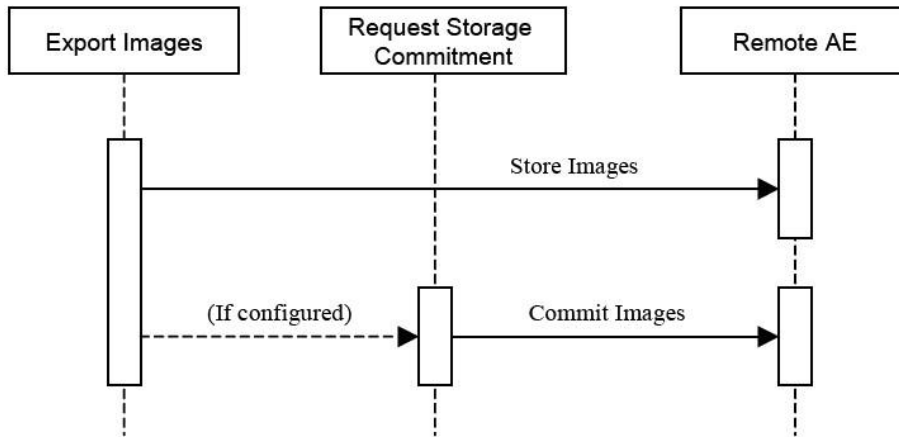

Figure 3: RWA Sequencing for Export Images

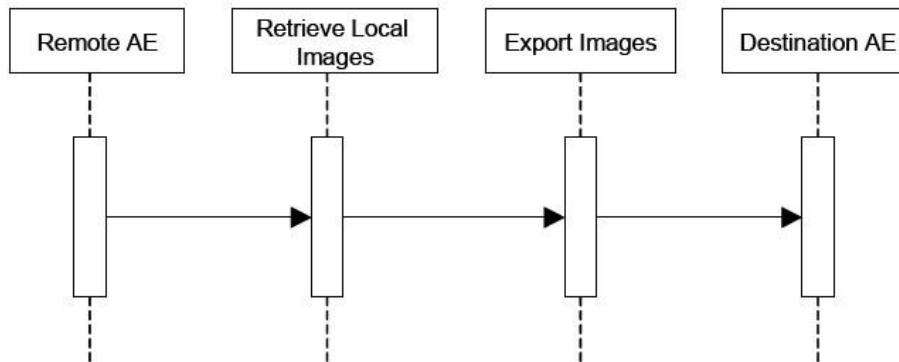

Figure 4: RWA Sequencing for Retrieve Local Images

4.2. AE Specifications

This section in the DICOM Conformance Statement is a set of Application Entity specifications. There are as many of these subsections as there are different AE's in the implementation.

4.2.1. DICOM Manager

Detail of this specific Application Entity is specified in this section.

4.2.1.1. SOP Classes

This Application Entity provides Standard Conformance to the following SOP Classes.

Table 5: SOP Classes for DICOM Manager

SOP Class Name	SOP Class UID	SCU	SCP
Verification SOP Class	1.2.840.10008.1.1	Yes	Yes
Storage Commitment Push Model SOP Class	1.2.840.10008.1.20.1	Yes	No
Modality Performed Procedure Step SOP Class	1.2.840.10008.3.1.2.3.3	Yes	No
Computed Radiography Image Storage SOP Class	1.2.840.10008.5.1.4.1.1.1	Yes	Yes
Digital X-Ray Image Storage - For Pres. SOP	1.2.840.10008.5.1.4.1.1.1.1	Yes	Yes
Digital X-Ray Image Storage - For Proc. SOP	1.2.840.10008.5.1.4.1.1.1.1.1	Yes	Yes
X-Ray Angiographic Image Storage SOP Class	1.2.840.10008.5.1.4.1.1.12.1	Yes	Yes
X-Ray Radiofluoroscopic Image Storage SOP Class	1.2.840.10008.5.1.4.1.1.12.2	Yes	Yes
CT Image Storage SOP Class	1.2.840.10008.5.1.4.1.1.2	Yes	Yes
Secondary Capture Image Storage SOP Class	1.2.840.10008.5.1.4.1.1.7	Yes	Yes
X-Ray Radiation Dose SR	1.2.840.10008.5.1.4.1.1.88.67	Yes	Yes
General ECG Waveform Storage SOP Class	1.2.840.10008.5.1.4.1.1.9.1.2	Yes	Yes
Study Root QR Information Model - FIND SOP Class	1.2.840.10008.5.1.4.1.2.2.1	Yes	Yes
Study Root QR Information Model - MOVE SOP Class	1.2.840.10008.5.1.4.1.2.2.2	Yes	Yes
Modality Worklist Information Model - FIND SOP Class	1.2.840.10008.5.1.4.31	Yes	No

Note: Any SOP specific behavior is documented later in the conformance statement in the applicable SOP specific conformance section.

4.2.1.2. Association Policies

Each AE specification contains a description of the general association establishment and acceptance policies of the AE.

With incoming association requests the system allows acceptance of a range of defined IP addresses which is configurable in the LanConfig application.

4.2.1.2.1. General

The DICOM standard application context has specified.

Table 6: DICOM Application Context

Description	Value
Application Context Name	1.2.840.10008.3.1.1.1

4.2.1.2.2. Number of Associations

Table 7: Number of associations as an Association Initiator for this AE

Description	Value
Maximum number of simultaneous associations	Unlimited

Table 8: Number of associations as an Association Acceptor for this AE

Description	Value
Maximum number of simultaneous associations	Unlimited

4.2.1.2.3. Asynchronous Nature

The implementation supports negotiation of multiple outstanding transactions, along with the maximum number of outstanding transactions supported.

Table 9: Asynchronous nature as an Association Initiator for this AE

Description	Value
Maximum number of outstanding asynchronous transactions	1

4.2.1.2.4. Implementation Identifying Information

The value supplied for Implementation Class UID and version name are documented here.

Table 10: DICOM Implementation Class and Version for DICOM Manager

Implementation Class UID	1.3.46.670589.33.101.1
Implementation Version Name	IQon-Spectral CT

4.2.1.2.5. Communication Failure Handling

The behavior of the AE during communication failure is summarized in next table.

Table 11: Communication Failure Behavior

Exception	Behavior	Comment
ARTIM Timeout	The system stops the ARTIM timer and closes the transport connection.	Configurable, minimum value=1.
Association Timeout	A release request is sent in order to close the association.	Configurable, minimum value=1.

4.2.1.3. Association Initiation Policy

The Application Entity will respond to a received Association rejection as shown in the next table.

Table 12: Association Rejection response

Result	Source	Reason/Diagnosis	Explanation
1 - rejected-permanent	1 - DICOM UL service-user	1 - no-reason-given	The connection is closed.
		2 - application-context-name-not supported	The connection is closed.
		3 - calling-AE-title-not-recognized	The connection is closed.
		7 - called-AE-title-not-recognized	The connection is closed.
	2 - DICOM UL service-provider (ACSE related function)	1 - no-reason-given	The connection is closed.
		2 - protocol-version-not-supported	The connection is closed.
		3 - DICOM UL service-provider(Presentation related function)	1 - temporary-congestion
2 - local-limit-exceeded	The connection is closed.		
2 - rejected-transient	1 - DICOM UL service-user	1 - no-reason-given	The connection is closed.

Result	Source	Reason/Diagnosis	Explanation
		2 - application-context-name-not-supported	The connection is closed.
		3 - calling-AE-title-not-recognized	The connection is closed.
		7 - called-AE-title-not-recognized	The connection is closed.
	2 - DICOM UL service-provider (ACSE related function)	1 - no-reason-given	The connection is closed.
		2 - protocol-version-not-supported	The connection is closed.
	3 - DICOM UL service-provider (Presentation related function)	1 - temporary-congestion	The connection is closed.
		2 - local-limit-exceeded	The connection is closed.

The behavior of the AE on receiving an association abort is summarized in next table.

Table 13: Association Abort Handling

Source	Reason/Diagnosis	Behavior
0 - DICOM UL service-user (initiated abort)	0 - reason-not-specified	The connection is closed.
2 - DICOM UL service-provider (initiated abort)	0 - reason-not-specified	The connection is closed.
	1 - unrecognized-PDU	The connection is closed.
	2 - unexpected-PDU	The connection is closed.
	4 - unrecognized-PDU parameter	The connection is closed.
	5 - unexpected-PDU parameter	The connection is closed.
	6 - invalid-PDU-parameter value	The connection is closed.

The behavior of the AE for sending an association abort is summarized in next table.

Table 14: DICOM Association Abort Policies

Source	Reason/Diagnosis	Behavior
0 - DICOM UL service-user	0 - reason-not-specified	When the system tries to disconnect before receiving an association accept but after sending association request; When receiving association accept with no presentation context item; When receiving association accept where all items in the presentation context item list are not accepted by remote system; When an association timeout (configurable per remote device) expired (timeout which determines how long to keep an idle association); When receiving a PDU whose size is bigger than the agreed max PDU size.
2 - DICOM UL service-provider	1- unrecognized-PDU	Whenever the system receives unexpected or unrecognized PDU (according to the DICOM UPPER LAYER PROTOCOL STATE TRANSITION TABLE in chapter 8 of the DICOM standard).
Other	Other	Not applicable.

4.2.1.3.1. (Real-World) Activity – Verification as SCU

4.2.1.3.1.1. Description and Sequencing of Activities

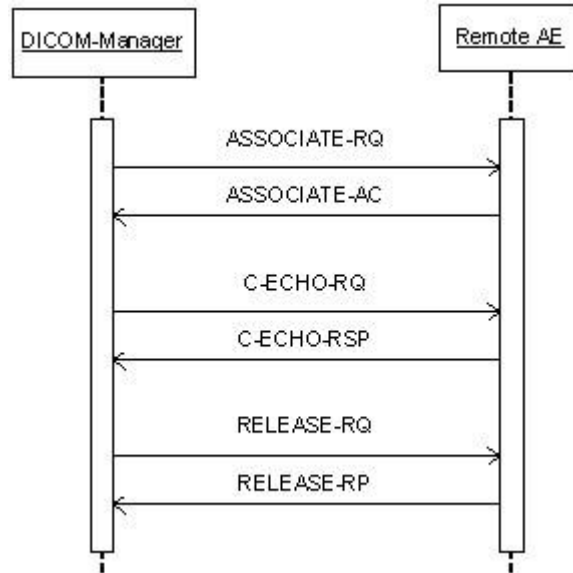

Figure 5: (Real World) Activity - Verification as SCU

DICOM Manager initiates an association when the user points to one of the icons in the devices tool-bar in the UI, clicks the right mouse button and selects "Verify Connection" operation.

4.2.1.3.1.2. Proposed Presentation Contexts

Each time an association is initiated, the association initiator proposes a number of presentation contexts to be used on that association. The association will be closed immediately upon receiving the response.

The presentation contexts proposed by DICOM Manager for (Real-World) Activity - Verification as SCU are defined in the following table.

Table 15: Proposed Presentation Contexts for (Real-World) Activity – Verification as SCU

Presentation Context Table					
Abstract Syntax		Transfer Syntax		Role	Extended Negotiation
Name	UID	Name List	UID List		
Verification SOP Class	1.2.840.10008.1.1	Explicit VR Little Endian	1.2.840.10008.1.2.1	SCU	None
		Implicit VR Little Endian	1.2.840.10008.1.2		

Note: The default supported Transfer Syntax is ILE. ELE has preference over ILE.

4.2.1.3.1.3. SOP Specific Conformance for Verification SOP Class

This section and sub-section includes the manufacturer SOP and Dataset specific information as well the status codes and their corresponding behavior.

DICOM Manager provides standard conformance to the DICOM V3.0.

4.2.1.3.1.3.1. Dataset Specific Conformance for Verification C-ECHO SCU

Detail regarding the Dataset Specific response behavior will be reported in this section.

This part of the section includes the dataset specific behavior, i.e. error codes, error and exception handling, time-outs, etc.

Table 16: Status Response

Service Status	Error Code	Further Meaning	Behavior
Success	0000	Success	The SCU has successfully send C-ECHO.
Other than Success	<>0000	Problems with sending the C-ECHO	The SCU failed to send the C-ECHO; user is notified.

4.2.1.3.2. (Real-World) Activity – Modality worklist as SCU

4.2.1.3.2.1. Description and Sequencing of Activities

4.2.1.3.2.2. Proposed Presentation Contexts

The presentation contexts are defined in the next table.

Table 17: Proposed Presentation Contexts for (Real-World) Activity – Modality worklist As SCU

Presentation Context Table					
Abstract Syntax		Transfer Syntax		Role	Extended Negotiation
Name	UID	Name List	UID List		
Modality Worklist Information Model - FIND SOP Class	1.2.840.10008.5.1.4.31	Explicit VR Little Endian	1.2.840.10008.1.2.1	SCU	None
		Implicit VR Little Endian	1.2.840.10008.1.2		

4.2.1.3.2.3. SOP Specific Conformance for Modality Worklist Information Model - FIND SOP Class

This section and sub-section include the manufacturer SOP and Dataset specific information as well the status codes and their corresponding behavior.

4.2.1.3.2.3.1. Dataset Specific Conformance for Modality Worklist Information Model - FIND SOP Class C-FIND-SCU

Detail regarding the Dataset Specific response behavior will be reported in this section.

The table below should be read as follows:

Attribute Name: Attributes supported to build a Modality Worklist Request Identifier.

Tag: DICOM tag for this attribute.

VR: DICOM VR for this attribute.

M: Matching Keys. An "X" indicates that this attribute is used for (automatic) Worklist Update.

R: Return Keys. An "X" will indicate that this attribute will be supplied as a Return Key with zero length for Universal Matching.

Q: Interactive Query Key. An "X" will indicate that Worklist attribute can be used as matching key.

D: Displayed Keys. An "X" indicates that this Worklist attribute is displayed to the user during a patient registration dialog.

IOD: An "X" indicates that this Worklist attribute is included into all object Instances created during performance of the related Procedure Step.

Type of matching: The following types of matching exists:

Single Value Matching
 List of UID Matching
 Wild Card Matching
 Range Matching
 Sequence Matching
 Universal Matching

Table 18: Worklist Request Identifier

Attribute Name	Tag	VR	M	R	Q	D	IOD	Type of Matching	Comment
Patient Identification Module									
Other Patient IDs	0010,1000	LO		X		X			
Patient ID	0010,0020	LO	X	X		X	X	Single Value, Wildcard	
Patient's Name	0010,0010	PN	X	X		X	X	Single Value, Wildcard	
Patient Demographic Module									
Confidentiality Constraint on Patient Data Description	0040,3001	LO		X					
Ethnic Group	0010,2160	SH		X					
Patient Comments	0010,4000	LT		X		X	X		
Patient's Birth Date	0010,0030	DA		X		X	X		
Patient's Sex	0010,0040	CS		X		X	X		
Patient's Size	0010,1020	DS		X		X			
Patient's Weight	0010,1030	DS		X		X	X		
Patient's Primary Language Code Sequence	0010,0101	SQ		X					
>Code Value	0008,0100	SH		X					
>Coding Scheme Designator	0008,0102	SH		X					
>Code Meaning	0008,0104	LO		X					
Patient Medical Module									
Additional Patient History	0010,21B0	LT		X		X	X		
Allergies	0010,2110	LO		X		X			
Medical Alerts	0010,2000	LO		X		X			
Patient State	0038,0500	LO		X		X			
Pregnancy Status	0010,21C0	US		X		X			
Smoking Status	0010,21A0	CS		X		X			
Special Needs	0038,0050	LO		X		X			
Visit Relationship Module									
Referenced Patient Sequence	0008,1120	SQ		X					
>Referenced SOP Class UID	0008,1150	UI		X					
>Referenced SOP Instance UID	0008,1155	UI		X					
Visit Identification Module									
Admission ID	0038,0010	LO		X					

Attribute Name	Tag	VR	M	R	Q	D	IOD	Type of Matching	Comment
Visit Status Module									
Current Patient Location	0038,0300	LO		X		X			
Visit Comments	0038,4000	LT		X		X			
Visit Admission Module									
Admitting Diagnoses Description	0008,1080	LO		X		X			
Referring Physician's Address	0008,0092	ST		X		X			
Referring Physician's Telephone Numbers	0008,0094	SH		X		X			
Route of Admissions	0038,0016	LO		X					
Admitting Diagnoses Code Sequence	0008,1084	SQ		X					
>Code Value	0008,0100	SH		X					
>Coding Scheme Designator	0008,0102	SH		X					
>Code Meaning	0008,0104	LO		X					
SOP Common Module									
Specific Character Set	0008,0005	CS		X					
Scheduled Procedure Step Module									
Scheduled Procedure Step Sequence	0040,0100	SQ		X					
>Modality	0008,0060	CS	X			X	X	Single Value	
>Pre-Medication	0040,0012	LO		X					
>Requested Contrast Agent	0032,1070	LO		X					
>Scheduled Performing Physician's Name	0040,0006	PN		X					
>Scheduled Procedure Step Description	0040,0007	LO		X		X	X		
>Scheduled Procedure Step ID	0040,0009	SH		X			X		
>Scheduled Procedure Step Start Date	0040,0002	DA	X	X		X		Range, Single Value	
>Scheduled Procedure Step Start Time	0040,0003	TM		X					
>Scheduled Procedure Step Status	0040,0020	CS		X					
>Scheduled Station AE Title	0040,0001	AE	X					Single Value	
>Scheduled Station Name	0040,0010	SH		X					
>Scheduled Protocol Code Sequence	0040,0008	SQ		X			X		
>>Code Meaning	0008,0104	LO		X		X	X		
>>Code Value	0008,0100	SH		X		X	X		
>>Coding Scheme Designator	0008,0102	SH		X		X	X		
Requested Procedure Module									
Names of Intended Recipients of Results	0040,1010	PN		X					
Patient Transport Arrangements	0040,1004	LO		X		X			
Requested Procedure Comments	0040,1400	LT		X		X			

Attribute Name	Tag	VR	M	R	Q	D	IOD	Type of Matching	Comment
Requested Procedure Description	0032,1060	LO		X		X			
Requested Procedure ID	0040,1001	SH	X	X			X		
Requested Procedure Priority	0040,1003	SH		X					
Study Instance UID	0020,000D	UI		X			X		
Referenced Study Sequence	0008,1110	SQ		X			X		
>Referenced SOP Class UID	0008,1150	UI		X			X		
>Referenced SOP Instance UID	0008,1155	UI		X			X		
Requested Procedure Code Sequence	0032,1064	SQ		X					
>Code Meaning	0008,0104	LO		X					
>Code Value	0008,0100	SH		X					
>Coding Scheme Designator	0008,0102	SH		X					
Imaging Service Request Module									
Accession Number	0008,0050	SH	X	X		X	X	Single Value	
Imaging Service Request Comments	0040,2400	LT		X					
Referring Physician's Name	0008,0090	PN		X		X	X		
Requesting Physician	0032,1032	PN		X		X			
Requesting Service	0032,1033	LO		X					

4.2.1.3.3. (Real-World) Activity – Modality Performed Procedure Step as SCU

4.2.1.3.3.1. Description and Sequencing of Activities

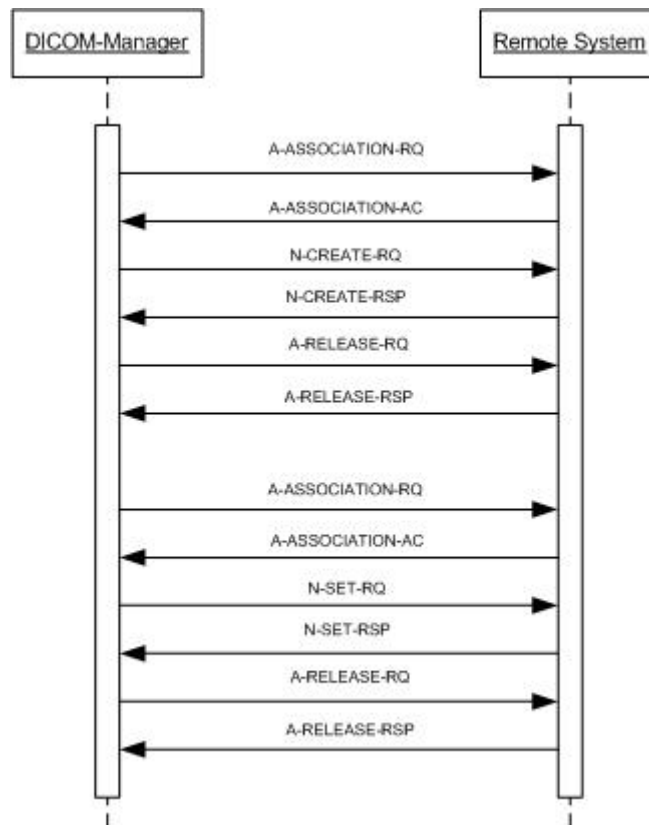

Figure 6: (Real World) Activity - MPPS as SCU

4.2.1.3.3.2. Proposed Presentation Contexts

The presentation contexts are defined in the next table.

Table 19: Proposed Presentation Contexts for (Real-World) Activity – Modality Performed Procedure Step As SCU

Presentation Context Table					
Abstract Syntax		Transfer Syntax		Role	Extended Negotiation
Name	UID	Name List	UID List		
Modality Performed Procedure Step SOP Class	1.2.840.10008.3.1.2.3.3	Explicit VR Little Endian	1.2.840.10008.1.2.1	SCU	None
		Implicit VR Little Endian	1.2.840.10008.1.2		

4.2.1.3.3.3. SOP Specific Conformance for Modality Performed Procedure Step SOP Class

This section and sub-section include the manufacturer SOP and Dataset specific information as well the status codes and their corresponding behavior.

4.2.1.3.3.3.1. Dataset Specific Conformance for Modality Performed Procedure Step SOP Class N-CREATE-SCU

Detail regarding the Dataset Specific response behavior will be reported in this section.

Table 20: MPPS Request Identifiers for N-CREATE-RQ

Attribute Name	Tag	VR	Value	Comment
SOP Common Module				
Specific Character Set	0008,0005	CS		
Performed Procedure Step Relationship Module				
Referenced Patient Sequence	0008,1120	SQ		
>Referenced SOP Class UID	0008,1150	UI		
>Referenced SOP Instance UID	0008,1155	UI		
Patient's Name	0010,0010	PN		
Patient ID	0010,0020	LO		
Patient's Birth Date	0010,0030	DA		
Patient's Sex	0010,0040	CS		
Scheduled Step Attributes Sequence	0040,0270	SQ		
>Accession Number	0008,0050	SH		
>Referenced Study Sequence	0008,1110	SQ		
>>Referenced SOP Class UID	0008,1150	UI		
>>Referenced SOP Instance UID	0008,1155	UI		
>Study Instance UID	0020,000D	UI		
>Requested Procedure description	0032,1060	LO		
>Scheduled Procedure Step description	0040,0007	LO		
>Scheduled Protocol Code Sequence	0040,0008	SQ		
>>Code Value	0008,0100	SH		
>>Coding Scheme Designator	0008,0102	SH		
>>Coding Scheme Version	0008,0103	SH		
>Scheduled Procedure Step ID	0040,0009	SH		
>Requested Procedure ID	0040,1001	SH		
Performed Procedure Step Information Module				
Procedure Code Sequence	0008,1032	SQ		
>Code Value	0008,0100	SH		
>Coding Scheme Designator	0008,0102	SH		
>Coding Meaning	0008,0104	LO		
Performed Station AE Title	0040,0241	AE		
Performed Station Name	0040,0242	SH		
Performed Location	0040,0243	SH		
Performed Procedure Step Start Date	0040,0244	DA		
Performed Procedure Step Start Time	0040,0245	TM		
Performed Procedure Step End Date	0040,0250	DA		
Performed Procedure Step End Time	0040,0251	TM		

Attribute Name	Tag	VR	Value	Comment
Performed Procedure Step Status	0040,0252	CS	IN PROGRESS	
Performed Procedure Step ID	0040,0253	SH		
Performed Procedure Step Description	0040,0254	LO		
Performed Procedure Type Description	0040,0255	LO		
Image Acquisition Results Module				
Modality	0008,0060	CS	CT	
Study ID	0020,0010	SH		
Performed Protocol Code Sequence	0040,0260	SQ		
>Code Meaning	0008,0104	LO		
>Code Value	0008,0100	SH		
>Coding Scheme Designator	0008,0102	SH		
>Coding Scheme Meaning	0008,0104	LO		
Performed Series Sequence	0040,0340	SQ		
Radiation Dose Module				
Total Number of Exposures	0040,0301	US		
Exposure Dose Sequence	0040,030E	SQ		
>Comments on Radiation Dose	0040,0310	ST		
Comments on Radiation Dose	0040,0310	ST		
Extended Dicom and Private attributes				
Specific Character Set	0008,0005	CS		
Implementor ID	00E1,0010	LO	Elscint	
Elscint1_DLP total	00E1,1021	DS		

This part of the section includes the dataset specific behavior, i.e. error codes, error and exception handling, time-outs, etc.

Table 21: Status Response

Service Status	Error Code	Further Meaning	Behavior
Success	0000	Message received successfully by SCP	Association will be released
Other than Success	<>0000	Problems with receiving the N-CREATE Request	Problem will be logged. Association with Problem will be logged. Association will be released.

4.2.1.3.3.3.2. Dataset Specific Conformance for Modality Performed Procedure Step SOP Class N-SET-SCU

Detail regarding the Dataset Specific response behavior will be reported in this section.

Table 22: MPPS Request Identifiers for N-SET-RQ

Attribute Name	Tag	VR	Value	Comment
Performed Procedure Step Information Module				
Procedure Code Sequence	0008,1032	SQ		
>Code Value	0008,0100	SH		
>Coding Scheme Designator	0008,0102	SH		
>Code Meaning	0008,0104	LO		
Performed Procedure Step End Date	0040,0250	DA		
Performed Procedure Step End Time	0040,0251	TM		
Performed Procedure Step Status	0040,0252	CS	COMPLETED or DISCONTINUED	
Performed Procedure Step Description	0040,0254	LO		
Performed Procedure Type Description	0040,0255	LO		
Image Acquisition Results Module				
Performed Protocol Code Sequence	0040,0260	SQ		
>Code Value	0008,0100	SH		
>Coding Scheme Designator	0008,0102	SH		
>Code Meaning	0008,0104	LO		
Performed Series Sequence	0040,0340	SQ		
>Retrieve AE Title	0008,0054	AE		
>Series Description	0008,103E	LO		
>Performing Physician's Name	0008,1050	PN		
>Operators' Name	0008,1070	PN		Value entered in the new study window for operator name or in case no value entered, the operator name that is logged in the application is used.
>Referenced Image Sequence	0008,1140	SQ		
>>Referenced SOP Class UID	0008,1150	UI		
>>Referenced SOP Instance UID	0008,1155	UI		

Attribute Name	Tag	VR	Value	Comment
>Protocol Name	0018,1030	LO		
>Series Instance UID	0020,000E	UI		
>Referenced Non-Image Composite SOP Instance Sequence	0040,0220	SQ		
Radiation Dose Module				
Total Number of Exposures	0040,0301	US		
Exposure Dose Sequence	0040,030E	SQ		
>KVP	0018,0060	DS		
>Exposure Time	0018,1150	IS		
>X-ray Tube Current	0018,1151	IS		
>Radiation Mode	0018,115A	CS		
>CTDIvol	0018,9345	FD		
>Comments on Radiation Dose	0040,0310	ST		
Comments on Radiation Dose	0040,0310	ST		
Extended Dicom and Private attributes				
Implementor ID	00E1,0010	LO	Elscint	
Elscint1_DLP total	00E1,1021	DS		

This part of the section includes the dataset specific behavior, i.e. error codes, error and exception handling, time-outs, etc.

Table 23: Status Response

Service Status	Error Code	Further Meaning	Behavior
Success	0000	Message received successfully by SCP	Association will be released
Other than Success	<>0000	Problems with receiving the N-SET Request by SCP	Problem will be logged. Association with problem will be logged. Association will be released.

4.2.1.3.4. (Real-World) Activity – FIND as SCU

4.2.1.3.4.1. Description and Sequencing of Activities

DICOM-Manager initiates an association when the user clicks on one of the icons in the devices tool-bar. The DICOM-Manager searches (C-FIND) by Study Level following by Series level and, optionally (configurable), by Image Level.

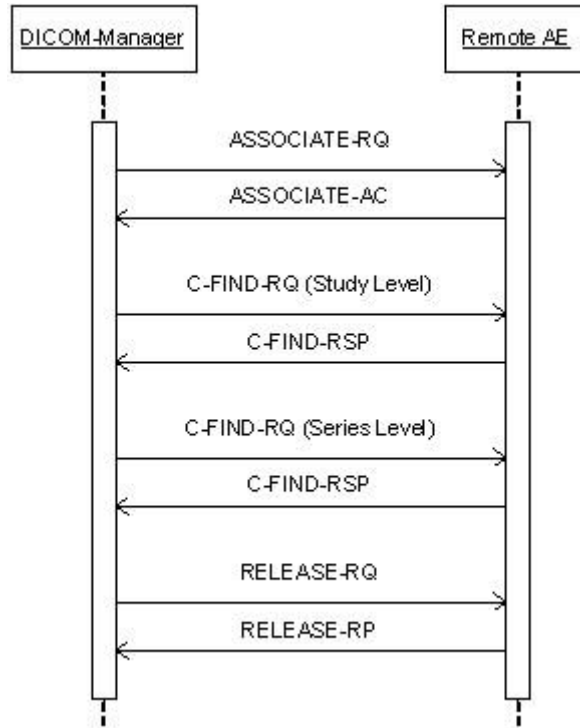

Figure 7: (Real World) Activity - Find as SCU

4.2.1.3.4.2. Proposed Presentation Contexts

Each time an association is initiated, the association initiator proposes a number of presentation contexts to be used on that association. In this subsection, the presentation contexts proposed by Archive-Manager for (Real-World) Activity - Find as SCU are defined in the Table below.

Table 24: Proposed Presentation Contexts for (Real-World) Activity – FIND As SCU

Presentation Context Table					
Abstract Syntax		Transfer Syntax		Role	Extended Negotiation
Name	UID	Name List	UID List		
Study Root QR Information Model - FIND SOP Class	1.2.840.10008.5.1.4.1.2.2.1	Explicit VR Little Endian	1.2.840.10008.1.2.1	SCU	None
		Implicit VR Little Endian	1.2.840.10008.1.2		

4.2.1.3.4.3. SOP Specific Conformance for Study Root QR Information Model - FIND SOP Class

This section and sub-section includes the manufacturer SOP and Dataset specific information as well the status codes and their corresponding behavior.

The DICOM-Manager provides standard conformance to the DICOM V3.0.

4.2.1.3.4.3.1. Dataset Specific Conformance for Study Root QR Information Model - FIND SOP Class C-FIND-SCU

Detail regarding the Dataset Specific response behavior will be reported in this section.

Table 25: Supported Query Keys for Study Root Information Model

Study Root Information Model				
Attribute Name	Tag	VR	Type Of Matching	Comment
Query/Retrieve Level	0008,0052	CS	Single Value	STUDY, SERIES, IMAGES

Specific Character Set	0008,0005	CS		
Q/R Study level				
Study Date	0008,0020	DA	Range, Universal	
Study Time	0008,0030	TM	Universal	
Accession Number	0008,0050	SH	Single Value, Universal	
Modalities in Study	0008,0061	CS	Single Value, Universal	
Referring Physician's Name	0008,0090	PN	Single Value, Universal, Wildcard	
Study Description	0008,1030	LO	Single Value, Universal	
Patient's Name	0010,0010	PN	Single Value, Universal, Wildcard	
Patient ID	0010,0020	LO	Single Value, Universal, Wildcard	
Patient's Birth Date	0010,0030	DA	Universal	
Patient's Birth Time	0010,0032	TM	Universal	
Patient's Sex	0010,0040	CS	Single Value, Universal	
Study Instance UID	0020,000D	UI	Universal	
Study ID	0020,0010	SH	Single Value, Universal, Wildcard	
Number of Study Related Series	0020,1206	IS	Universal	
Number of Study Related Instances	0020,1208	IS	Universal	
Performed Procedure Step Description	0040,0254	LO	Universal	
Q/R Series level				
Series Date	0008,0021	DA	Universal	
Series Time	0008,0031	TM	Universal	
Modality	0008,0060	CS	Universal	
Manufacturer	0008,0070	LO	Universal	
Series Description	0008,103E	LO	Universal	
Body Part Examined	0018,0015	CS	Universal	
Protocol Name	0018,1030	LO	Universal	
Study Instance UID	0020,000D	UI	Single Value	
Series Instance UID	0020,000E	UI	Universal	
Series Number	0020,0011	IS	Universal	
Number of Series Related Instances	0020,1209	IS	Universal	
Performed Procedure Step Start Date	0040,0244	DA	Universal	
Performed Procedure Step Start Time	0040,0245	TM	Universal	
Request Attributes Sequence	0040,0275	SQ	Universal	
>Scheduled Procedure Step ID	0040,0009	SH	Universal	
>Requested Procedure ID	0040,1001	SH	Universal	
Q/R Image level				
Image Type	0008,0008	CS	Universal	
Instance Creation Date	0008,0012	DA	Universal	

Instance Creation Time	0008,0013	TM	Universal	
SOP Class UID	0008,0016	UI	Universal	
SOP Instance UID	0008,0018	UI	Universal	
Contrast/Bolus Agent	0018,0010	LO	Universal	
Slice Thickness	0018,0050	DS	Universal	
KVP	0018,0060	DS	Universal	
Study Instance UID	0020,000D	UI	Single Value	
Series Instance UID	0020,000E	UI	Single Value	
Instance Number	0020,0013	IS	Universal	
Patient Orientation	0020,0020	CS	Universal	
Image Orientation (Patient)	0020,0037	DS	Universal	
Frame of Reference UID	0020,0052	UI	Universal	
Slice Location	0020,1041	DS	Universal	
Samples per Pixel	0028,0002	US	Universal	
Photometric Interpretation	0028,0004	CS	Universal	
Rows	0028,0010	US	Universal	
Columns	0028,0011	US	Universal	
Pixel Spacing	0028,0030	DS	Universal	

This part of the section includes the dataset specific behavior, i.e. error codes, error and exception handling, time-outs, etc.

Table 26: Status Response

Service Status	Error Code	Further Meaning	Behavior
Success	0000	Success	Matching is successful.
Failure	A700	Refused - Out of resources	
	A900	Failed - Doesn't match SOP class	
	Cxxx	Failed - Unknown reason	

4.2.1.3.5. (Real-World) Activity – MOVE as SCU

4.2.1.3.5.1. Description and Sequencing of Activities

The RWA Move Remote Images involves the retrieve of images on a remote system by moving (copying) the matching images from the remote database to another database.

The operator is able to copy the selected images in a patient folder from a remote database to another, local or remote, database by means of the copy tool in the DICOM Manager data handling facility. The DICOM Manager initiates for each copy request an association to the selected peer entity (Remote AE) and uses it to send the Retrieve (C-MOVE) request (and receive the associated responses). The association is released after the final Retrieve (C-MOVE) response for the related request has been received with the status success / failure.

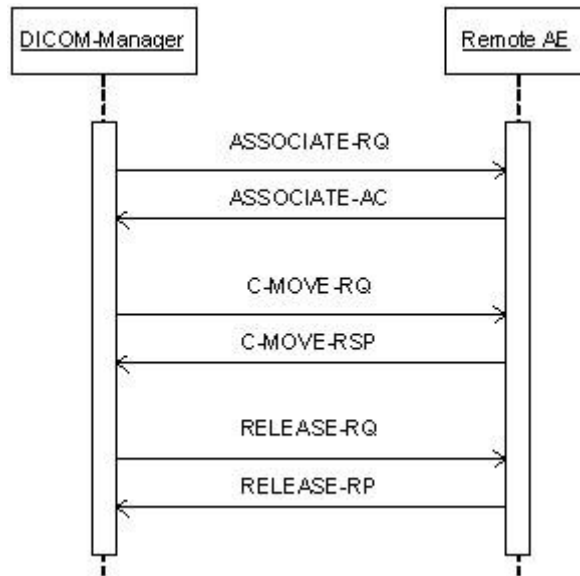

Figure 8: (Real World) Activity - Move as SCU

4.2.1.3.5.2. Proposed Presentation Contexts

Each time an association is initiated, the association initiator proposes a number of presentation contexts to be used on that association.

In this subsection, the presentation contexts proposed by DICOM-Manager for (Real-World) Activity - Move as SCU are defined in the following table.

Table 27: Proposed Presentation Contexts for (Real-World) Activity – MOVE As SCU

Presentation Context Table					
Abstract Syntax		Transfer Syntax		Role	Extended Negotiation
Name	UID	Name List	UID List		
Study Root QR Information Model - MOVE SOP Class	1.2.840.10008.5.1.4.1.2.2.2	Explicit VR Little Endian	1.2.840.10008.1.2.1	SCU	None
		Implicit VR Little Endian	1.2.840.10008.1.2		

4.2.1.3.5.3. SOP Specific Conformance for Study Root QR Information Model - MOVE SOP Class

This section and sub-section includes the manufacturer SOP and Dataset specific information as well the status codes and their corresponding behavior.

DICOM-Manager provides standard conformance to the DICOM V3.0 Query/Retrieve Service Class as an SCU for the SOP Class Study Root Query/Retrieve Information Model - Move.

4.2.1.3.5.3.1. Dataset Specific Conformance for Study Root QR Information Model - MOVE SOP Class C-MOVE-SCU

Detail regarding the Dataset Specific response behavior will be reported in this section.

Table 28: Identifiers for MOVE Study Root Information Model as SCU

Study Root Information Model			
Attribute Name	Tag	VR	Comment
Query/Retrieve Level	0008,0052	CS	STUDY, SERIES, IMAGES

Q/R Study level			
Study Instance UID	0020,000D	UI	
Q/R Series level			
Study Instance UID	0020,000D	UI	
Series Instance UID	0020,000E	UI	
Q/R Image level			
SOP Instance UID	0008,0018	UI	
Study Instance UID	0020,000D	UI	
Series Instance UID	0020,000E	UI	

This part of the section includes the dataset specific behavior, i.e. error codes, error and exception handling, time-outs, etc.

Table 29: Status Response

Service Status	Error Code	Further Meaning	Behavior
Success	0000	Success	Storage successful.
Failure	A701	Refused - Out of Resources	Message by transfer result - Unable to calculate number of matches.
	A702	Refused - Out of Resources	Message by transfer result - Unable to perform sub operations
	A801	Refused - Move Destination Unknown	Message by transfer result - Move Destination Unknown.
	A900	Error - Identifier Does Not Match SOP Class	Message by transfer result - Identifier does not match SOP Class.
	Cxxx	Error - Unable to Process	Message by transfer result - Unable to process.
Warning	B000	Sub-operations complete - One or more failures	Message by transfer result - Sub operations complete one or more failures.
Cancel	FE00	Cancel	Move operation cancelled.

4.2.1.3.6. (Real-World) Activity – Image Export

4.2.1.3.6.1. Description and Sequencing of Activities

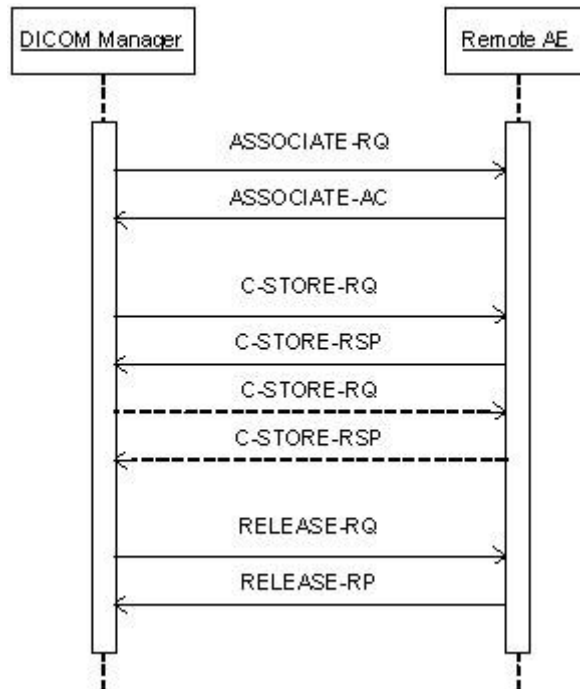

Figure 9: (Real World) Activity - Image Export

The associated Real-World Activity is a request for retrieval of images from the disk or save operation from IQon CT applications and storage of the images to a remote system using a C-STORE command.

4.2.1.3.6.2. Proposed Presentation Contexts

Each time an association is initiated, the association initiator proposes a number of presentation contexts to be used on that association.

The system configuration (by FSE in LanConfig) allows disabling individually each of the supported syntaxes per remote device when establishing and accepting associations. At least one of the syntaxes will be enabled.

When establishing association to a remote device, all the enabled (for that device) syntaxes will be proposed based on the SOP Class. If more than one Transfer Syntax is accepted by the SCP, the order of selecting the syntax to use is: P-ELE, JPEG, ELE and ILE. However if the proposed SOP class does not contain any pixel data then only ELE and ILE will be proposed.

When a device is newly added in LanConfig, by default the selected transfer syntaxes for the device are ELE & ILE. If the device is a Philips device which is more recent than IQon CT then P-ELE will also selected by default. The user will have the option of changing the selected transfer syntax per device using LanConfig.

IQon CT supports Level2 DICOM transparency and hence will preserve all the source image data.

The presentation contexts proposed by the DICOM Manager for (Real-World) Activity (C-STORE SCU) are defined in the following table.

Table 30: Proposed Presentation Contexts for (Real-World) Activity – Image Export

Presentation Context Table					
Abstract Syntax		Transfer Syntax		Role	Extended Negotiation
Name	UID	Name List	UID List		
Computed Radiography Image Storage SOP Class	1.2.840.10008.5.1.4.1.1.1	JPEG Lossless, Non-Hierarchical, FOP (Process 14)	1.2.840.10008.1.2.4.70	SCU	None
		CT-private-ELE	1.3.46.670589.33.1.4.1		
		Explicit VR Little Endian	1.2.840.10008.1.2.1		
		Implicit VR Little Endian	1.2.840.10008.1.2		
Digital X-Ray Image Storage - For Pres. SOP	1.2.840.10008.5.1.4.1.1.1.1	Explicit VR Little Endian	1.2.840.10008.1.2.1	SCU	None
		Implicit VR Little Endian	1.2.840.10008.1.2		
		CT-private-ELE	1.3.46.670589.33.1.4.1		
		JPEG Lossless, Non-Hierarchical, FOP (Process 14)	1.2.840.10008.1.2.4.70		
Digital X-Ray Image Storage - For Proc. SOP	1.2.840.10008.5.1.4.1.1.1.1.1	Explicit VR Little Endian	1.2.840.10008.1.2.1	SCU	None
		Implicit VR Little Endian	1.2.840.10008.1.2		
		CT-private-ELE	1.3.46.670589.33.1.4.1		
		JPEG Lossless, Non-Hierarchical, FOP (Process 14)	1.2.840.10008.1.2.4.70		
X-Ray Angiographic Image Storage SOP Class	1.2.840.10008.5.1.4.1.1.12.1	Explicit VR Little Endian	1.2.840.10008.1.2.1	SCU	None
		Implicit VR Little Endian	1.2.840.10008.1.2		
		CT-private-ELE	1.3.46.670589.33.1.4.1		
		JPEG Lossless, Non-Hierarchical, FOP (Process 14)	1.2.840.10008.1.2.4.70		
X-Ray Radiofluoroscopic Image Storage SOP Class	1.2.840.10008.5.1.4.1.1.12.2	Explicit VR Little Endian	1.2.840.10008.1.2.1	SCU	None
		Implicit VR Little Endian	1.2.840.10008.1.2		
		CT-private-ELE	1.3.46.670589.33.1.4.1		
		JPEG Lossless, Non-Hierarchical, FOP (Process 14)	1.2.840.10008.1.2.4.70		
CT Image Storage SOP Class	1.2.840.10008.5.1.4.1.1.2	Explicit VR Little Endian	1.2.840.10008.1.2.1	SCU	None
		Implicit VR Little Endian	1.2.840.10008.1.2		
		CT-private-ELE	1.3.46.670589.33.1.4.1		
		JPEG Lossless, Non-Hierarchical, FOP (Process 14)	1.2.840.10008.1.2.4.70		
Secondary Capture Image Storage SOP Class	1.2.840.10008.5.1.4.1.1.7	CT-private-ELE	1.3.46.670589.33.1.4.1	SCU	None
		Explicit VR Little Endian	1.2.840.10008.1.2.1		
		Implicit VR Little Endian	1.2.840.10008.1.2		
		JPEG Lossless, Non-Hierarchical, FOP (Process 14)	1.2.840.10008.1.2.4.70		
X-Ray Radiation Dose SR	1.2.840.10008.5.1.4.1.1.88.67	Explicit VR Little Endian	1.2.840.10008.1.2.1	SCU	None
		Implicit VR Little Endian	1.2.840.10008.1.2		

Presentation Context Table					
Abstract Syntax		Transfer Syntax		Role	Extended Negotiation
Name	UID	Name List	UID List		
General ECG Waveform Storage SOP Class	1.2.840.10008.5.1.4.1.1.9.1.2	Explicit VR Little Endian	1.2.840.10008.1.2.1	SCU	None
		Implicit VR Little Endian	1.2.840.10008.1.2		

"JPEG" here refers to JPEG Lossless, Non-Hierarchical, First-Order Prediction (Process 14 [Selection Value 1]): Default Transfer Syntax for Lossless JPEG Image Compression.

It will apply the following priorities to the choice of Transfer Syntax which can be configured in LAN Config Tool:

Table 31: Transfer Syntax Priorities

Transfer Syntax	UID	Comment
1. Private DICOM Explicit VR Little Endian (CT-private-ELE)	1.3.46.670589.33.1.4.1	LanConfig. Default for IQon
2. DICOM JPEG Lossless, Non-Hierarchical, FOP (Process 14)	1.2.840.10008.1.2.4.70	LanConfig, Transfer Syntax for Lossless JPEG Image Compression (JPEG).
3. DICOM Explicit VR Little Endian	1.2.840.10008.1.2.1	LanConfig.
4. DICOM Implicit VR Little Endian	1.2.840.10008.1.2	LanConfig, default.

Note: No support of JPEG & P-ELE transfer syntaxes for all SOP classes without pixel data.

4.2.1.3.6.3. SOP Specific Conformance for Storage SOP Classes

DICOM Manager AE provides standard conformance to the DICOM V3.0 Storage Service Class as an SCU for SOP Classes mentioned in the previous section.

Any unsuccessful status (error or warning), returned in the C-STORE Response, results in termination of sending further C-STORE requests (if any in the queue) and reporting of the error to the system log file and UI (Queue Manager)

There are two timeouts for the association. One timeout, "Association Timeout" is used to close an idle association. For C-STORE the default is 120 sec and can be configured per remote DICOM node. The other timeout is "Service Timeout" which detects that no data is transmitted over the association and closes it. The default "Service Timeout" for C-STORE is 5 minutes.

4.2.1.3.6.3.1. Dataset Specific Conformance for C-STORE-RQ

Detail regarding the Dataset Specific response behavior will be reported in this section.

This includes the dataset specific behavior, i.e. error codes, error and exception handling, time-outs, etc.

Table 32: Status Response

Service Status	Error Code	Further Meaning	Behavior
Success	0000	Success	Storage successful.
Failure	0122	Refused - SOP Class not supported	Message by transfer result - Unknown reason.
	A700	Refused - Out of Resources	Message by transfer result - Out of Resources.
	A900	Error - Data Set does not match SOP	Message by transfer result - Unknown reason.
	C000	Error - Cannot understand	Message by transfer result - Store failed.
Warning	B000	Coercion of Data Elements	Warning status is treated as success.
	B006	Elements Discarded	Warning status is treated as success.
	B007	Data Set does not match	Warning status is treated as success.

4.2.1.3.7. (Real-World) Activity – Storage Commitment Push Model AS SCU

4.2.1.3.7.1. Description and Sequencing of Activities

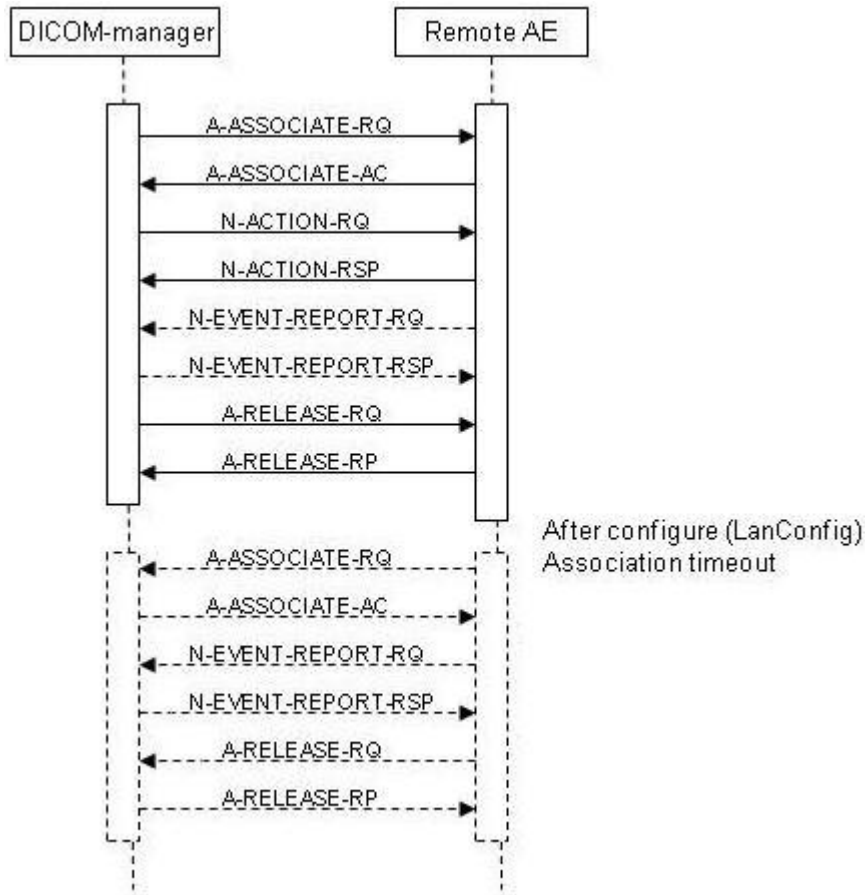

Figure 10: (Real World) Activity- DICOM Manager (Storage Commitment)

DICOM-Manager will attempt to initiate a new association when requested to commit the images that were stored on a remote device, which supports the storage Commitment Service.

The associated real world activity for the N-ACTION is a storage commitment request to the remote storage device.

The associated real world activity for the N-EVENT-REPORT operation is the completion of the storage commitment by the remote device.

This can be as Synchronous storage commitment as the N-EVENT-REPORT-RQ is received inside the configure timeout or as Asynchronous storage commitment after the Release-RQ by the timeout is already send to the remote system.

DICOM-Manager will issue a failure status if it is unable to properly handle the storage commitment report event.

4.2.1.3.7.2. Proposed Presentation Contexts

Each time an association is initiated, the association initiator proposes a number of presentation contexts to be used on that association.

The presentation contexts proposed by DICOM Manager for (Real-World) Activity - Storage Commitment as SCU are defined in the following table.

Table 33: Proposed Presentation Contexts for (Real-World) Activity – Storage Commitment Push Model AS SCU

Presentation Context Table					
Abstract Syntax		Transfer Syntax		Role	Extended Negotiation
Name	UID	Name List	UID List		
Storage Commitment Push Model SOP Class	1.2.840.10008.1.20.1	Explicit VR Little Endian	1.2.840.10008.1.2.1	SCU	None
		Implicit VR Little Endian	1.2.840.10008.1.2		

4.2.1.3.7.3. SOP Specific Conformance for Storage Commitment Push Model SOP Class

DICOM-Manager provides standard conformance to the DICOM V3.0 Storage Commitment Service Class using Push Model as an SCU.

Multiple N-ACTION-RQ can be performed over a single association. Multiple N-EVENT-REPORT-RQ can be accepted over a single association. After all N-ACTION-RQ that are waiting in the stack are issued, association will be closed with the timeout which is configurable using LanConfig.

A remote system reports about storage commitment completion using an N-EVENT-REPORT-RQ command. The system can also accept the N-EVENT-REPORT-RQ commands over a separate association initiated by the remote system, using reverse role negotiation.

Storage Commitment for individual images are grouped into large "chunks" and issued as a single Storage Commitment request.

Table 34: DICOM Command Communication Failure Behavior Storage Commitment

Exception	Behavior
ARTIM Time-out	The reason is logged
Reply Time-out	The association is released. Continues with waiting for storage commitment
Association Time-out SCU	The association is released. Continues with waiting for storage commitment
Association aborted	Continues with waiting for storage commitment

4.2.1.3.7.3.1. Dataset Specific Conformance for Storage Commitment Push Model SOP Class N-ACTION-SCU

All details regarding the specific conformance, including response behavior to all status codes, both from an application level and communication errors are provided in following tables for N-ACTION.

Table 35: Status Response

Service Status	Error Code	Further Meaning	Behavior
Success	0000	Success	The request for storage commitment is considered successfully stored.
Other than Success	<>0000	Problems with sending the N-ACTION Request	The request for storage commitment is marked as failed.

4.2.1.3.7.3.2. Dataset Specific Conformance for Storage Commitment Push Model SOP Class N-EVENT-REPORT-SCP

All details regarding the specific conformance, including response behavior to all status codes, both from an application level and communication errors are provided in following tables for N-EVENT-REPORT.

Table 36: Storage Commitment N-EVENT-REPORT Behavior

Event Type Name	Event Type	Behavior
Storage Commitment Request Successful	1	Awaiting Storage Commitment request will be moved to complete in Queue Manager.
Storage Commitment Request Complete - Failures Exist	2	Awaiting Storage Commitment request will be moved to fail in Queue Manager.

Table 37: Storage Commitment N-EVENT-REPORT Failure Handling Behavior

Service Status	Error Code	Further Meaning	Description
Success	0000	Success	The storage commitment result has been successfully received.

4.2.1.4. Association Acceptance Policy

The Application Entity may reject Association attempts as shown in the table below.

Table 38: DICOM Association Rejection Policies

Result	Source	Reason/Diagnosis	Explanation
1 - rejected permanent	1 - DICOM UL service-user	2 - application-context-name-not-supported	When receiving association request and the application context name is not supported.
		3 - calling-AE-title-not-recognized	When receiving association request and the calling AE title is not supported.
		7 - called-AE-title-not-recognized	When receiving association request and the called AE title is not supported.
	2 - DICOM UL service-provider (ACSE related function)	1 - no-reason-given	When receiving association request and all of the items in the presentation context item list are not supported by the system.
		2 - protocol-version-not-supported	When receiving an association request and the protocol version received is not supported.

The behavior of the AE on DICOM receiving Association Abort Handling is summarized in table below:

Table 39: DICOM receiving Association Abort Handling

Source	Reason/Diagnosis	Behavior
0 - DICOM UL service-user (initiated abort)	0 - reason-not-specified	The connection is closed.
2 - DICOM UL service-provider (initiated abort)	0 - reason-not-specified	The connection is closed.
	1 - unrecognized-PDU	The connection is closed.
	2 - unexpected-PDU	The connection is closed.
	4 - unrecognized-PDU parameter	The connection is closed.
	5 - unexpected-PDU parameter	The connection is closed.
	6 - invalid-PDU-parameter value	The connection is closed.

The behavior of the AE for sending an association abort is summarized in next table.

Table 40: Association Abort Policies

Source	Reason/Diagnosis	Behavior
0 - DICOM UL service-user (initiated abort)	0 - reason-not-specified	When an association timeout (configurable per remote device) expired (timeout which determines how long to keep an idle association).When receiving a PDU whose size is bigger than the agreed max PDU size.
2 - DICOM UL service-provider (initiated abort)	1 - unrecognized-PDU	Whenever the system receives unexpected or unrecognized PDU (according to the DICOM UPPER LAYER PROTOCOL STATE TRANSITION TABLE in chapter 8 of the DICOM standard).

4.2.1.4.1. (Real-World) Activity – Verification as SCP

4.2.1.4.1.1. Description and Sequencing of Activities

A remote system requests verification from DICOM Manager using the C-ECHO command.

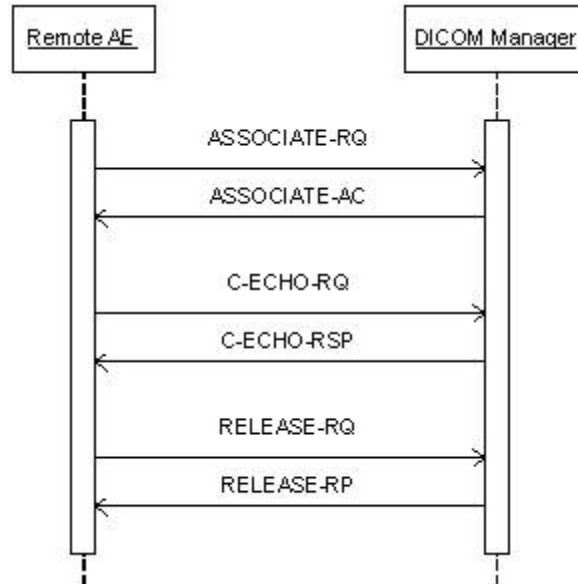

Figure 11: (Real World) Activity - Verification as SCP

4.2.1.4.1.2. Accepted Presentation Contexts

The presentation contexts are defined in next table.

Table 41: Acceptable Presentation Contexts for (Real-World) Activity – Verification as SCP

Presentation Context Table					
Abstract Syntax		Transfer Syntax		Role	Extended Negotiation
Name	UID	Name List	UID List		
Verification SOP Class	1.2.840.10008.1.1	Explicit VR Little Endian	1.2.840.10008.1.2.1	SCP	None
		Implicit VR Little Endian	1.2.840.10008.1.2		

4.2.1.4.1.3. SOP Specific Conformance for Verification SOP Class

This section and sub-section includes the manufacturer SOP and Dataset specific information as well the status codes and their corresponding behavior.

DICOM Manager (C-ECHO SCP) provides standard conformance to the DICOM V3.0 verification SOP Class.

4.2.1.4.1.3.1. Dataset Specific Conformance for Verification C-ECHO SCP

Detail regarding the Dataset Specific response behavior will be reported in this section.

This part of the section includes the dataset specific behavior, i.e. error codes, error and exception handling, time-outs, etc.

Table 42: Status Response

Service Status	Error Code	Further Meaning	Behavior
Success	0000	Success	C-ECHO command was successful received.

4.2.1.4.2. (Real-World) Activity – FIND as SCP

4.2.1.4.2.1. Description and Sequencing of Activities

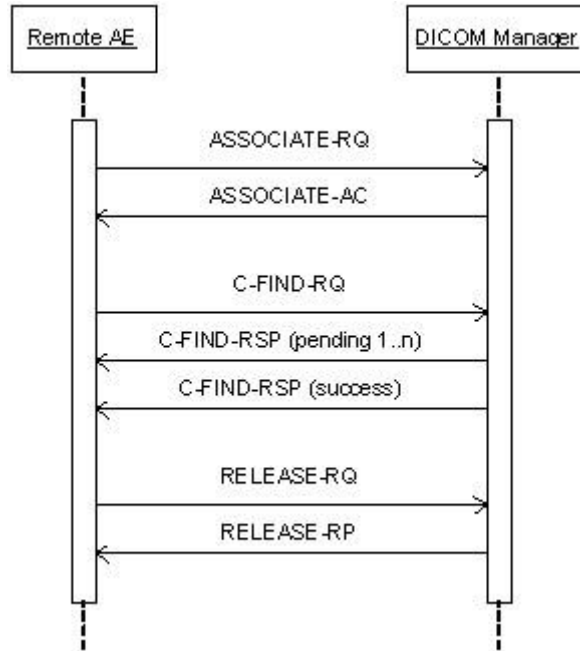

Figure 12: (Real World) Activity - Find as SCP

The Real World activity associated with the C-FIND-SCP is querying of the local data base based on C-FIND-RQ from the remote DICOM node. DICOM Manager will issue a failure status if it is unable to process the query request.

4.2.1.4.2.2. Accepted Presentation Contexts

The presentation contexts are defined in next table.

Table 43: Acceptable Presentation Contexts for (Real-World) Activity – FIND As SCP

Presentation Context Table					
Abstract Syntax		Transfer Syntax		Role	Extended Negotiation
Name	UID	Name List	UID List		
Study Root QR Information Model - FIND SOP Class	1.2.840.10008.5.1.4.1.2.2.1	Explicit VR Little Endian	1.2.840.10008.1.2.1	SCP	None
		Implicit VR Little Endian	1.2.840.10008.1.2		

4.2.1.4.2.3. SOP Specific Conformance for Study Root QR Information Model - FIND SOP Class

This section and sub-section includes the manufacturer SOP and Dataset specific information as well the status codes and their corresponding behavior.

DICOM Manager provides standard conformance to the DICOM V3.0 Query/Retrieve Service Class as an SCP for the following SOP Class: Study Root Query/Retrieve Information Model - FIND, UID=1.2.840.10008.5.1.4.1.2.2.1.

4.2.1.4.2.3.1. Dataset Specific Conformance for Study Root QR Information Model - FIND SOP Class C-FIND-SCP

Detail regarding the Dataset Specific response behavior will be reported in this section.

IQon CT does not support Relational Search, a query that may contain any combination of keys at any level in the hierarchy. Starting at the top level in the Query/Retrieve Information Model, continuing until the Query/Retrieve level specified in the C-FIND request is reached.

All Required (R) and Unique (U) Study, Series and Image level keys for the Study Root Query/Retrieve Information Model are supported.

Unsupported fields will not be returned in the C-FIND response.

Table 44: Requested Query Keys for Study Root Information Model

Study Root Information Model				
Attribute Name	Tag	VR	Type Of Matching	Comment
Query/Retrieve Level	0008,0052	CS	Universal	
Q/R Study level				
Study Date	0008,0020	DA	Range, Single Value, Universal	
Study Time	0008,0030	TM		
Accession Number	0008,0050	SH	Single Value	
Modalities in Study	0008,0061	CS	Single Value	
Referring Physician's Name	0008,0090	PN	Range, Single Value, Universal	
Study Description	0008,1030	LO	Universal	
Patient's Name	0010,0010	PN	Single Value	
Patient ID	0010,0020	LO	Single Value	
Patient's Birth Date	0010,0030	DA	Single Value	
Patient's Birth Time	0010,0032	TM	Single Value, Universal, Wildcard	
Patient's Sex	0010,0040	CS	Single Value, Universal, Wildcard	
Study Instance UID	0020,000D	UI	Single Value, Universal, Wildcard	
Study ID	0020,0010	SH	Single Value, Universal, Wildcard	
Number of Study Related Series	0020,1206	IS	Universal	
Number of Study Related Instances	0020,1208	IS	Universal	
Performed Procedure Step Description	0040,0254	LO	Single Value, Universal	
Q/R Series level				
Series Date	0008,0021	DA	Single Value, Universal	
Series Time	0008,0031	TM	Universal	
Modality	0008,0060	CS	Universal	
Manufacturer	0008,0070	LO	Universal	
Body Part Examined	0018,0015	CS	Universal	
Protocol Name	0018,1030	LO	Single Value	
Series Description	0008,103E	LO	Universal	

Series Number	0020,0011	IS	Universal	
Study Instance UID	0020,000D	UI	Single Value, Universal	
Series Instance UID	0020,000E	UI	Universal	
Number of Series Related Instances	0020,1209	IS	Universal	
Performed Procedure Step Start Date	0040,0244	DA	Universal	
Performed Procedure Step Start Time	0040,0245	TM	Single Value	
Request Attributes Sequence	0040,0275	SQ	Universal	
Q/R Image level				
Image Type	0008,0008	CS	Single Value	
Instance Creation Date	0008,0012	DA	Single Value	
Instance Creation Time	0008,0013	TM	Single Value	
SOP Class UID	0008,0016	UI	Single Value	
SOP Instance UID	0008,0018	UI	Universal	
Contrast/Bolus Agent	0018,0010	LO	Universal	
Slice Thickness	0018,0050	DS	Universal	
KVP	0018,0060	DS	Universal	
Study Instance UID	0020,000D	UI	Single Value	
Series Instance UID	0020,000E	UI	Universal	
Instance Number	0020,0013	IS	Single Value	
Patient Orientation	0020,0020	CS	Universal	
Image Orientation (Patient)	0020,0037	DS	Universal	
Frame of Reference UID	0020,0052	UI	Single Value	
Slice Location	0020,1041	DS	Universal	
Samples per Pixel	0028,0002	US	Single Value	
Photometric Interpretation	0028,0004	CS	Single Value	
Rows	0028,0010	US	Universal	
Columns	0028,0011	US	Universal	
Pixel Spacing	0028,0030	DS	Universal	

C-FIND-CANCEL is supported. However, some C-FIND responses may be forwarded before the C-FIND-CANCEL takes effect.

This part of the section includes the dataset specific behavior, i.e. error codes, error and exception handling, time-outs, etc.

Table 45: Status Response

Service Status	Error Code	Further Meaning	Behavior
Success	0000	Matching complete	Matching successful.
Failure	C000	General failure status	Whenever the find operation failed.
Cancel	FE00	Cancel	When receiving a cancel C-FIND request.
Pending	FF00	Pending	For every C-FIND response received.

4.2.1.4.3. (Real-World) Activity – MOVE as SCP

4.2.1.4.3.1. Description and Sequencing of Activities

The Real World activity associated with the C-MOVE command is retrieval of images from the disk and storage of the images to a remote system using a C-STORE command. DICOM Manager will issue a failure status if it is unable to process the transfer request.

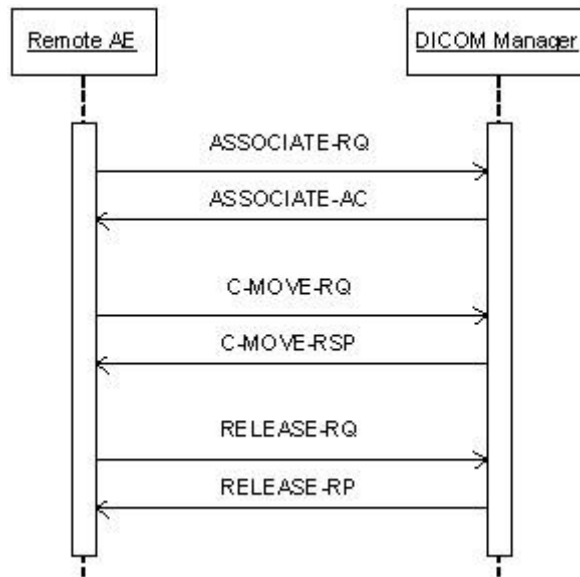

Figure 13: (Real World) Activity - Move as SCP

4.2.1.4.3.2. Accepted Presentation Contexts

The presentation contexts are defined in next table.

Table 46: Acceptable Presentation Contexts for (Real-World) Activity – MOVE As SCP

Presentation Context Table					
Abstract Syntax		Transfer Syntax		Role	Extended Negotiation
Name	UID	Name List	UID List		
Study Root QR Information Model - MOVE SOP Class	1.2.840.10008.5.1.4.1.2.2.2	Explicit VR Little Endian	1.2.840.10008.1.2.1	SCP	None
		Implicit VR Little Endian	1.2.840.10008.1.2		

4.2.1.4.3.3. SOP Specific Conformance for Study Root QR Information Model - MOVE SOP Class

This section and sub-section includes the manufacturer SOP and Dataset specific information as well the status codes and their corresponding behavior.

DICOM Manager provides standard conformance to the DICOM V3.0 Query/Retrieve Service Class as an SCP for the following SOP Class: Study Root Query/Retrieve Information Model - MOVE, UID=1.2.840.10008.5.1.4.1.2.2.2. Prioritization of C-MOVE requests is not supported. C-MOVE requests are supported on study, series and image level.

4.2.1.4.3.3.1. Dataset Specific Conformance for Study Root QR Information Model - MOVE SOP Class C-MOVE-SCP

Detail regarding the Dataset Specific response behavior will be reported in this section.

DICOM Manager does not support relational C-MOVE requests. All images requested in the C-MOVE will be sent over a single association.

This part of the section includes the dataset specific behavior, i.e. error codes, error and exception handling, time-outs, etc.

All details regarding the specific conformance, including response behavior of all status codes, both from an application level and communication errors are provided in the following table.

Table 47: Status Response

Service Status	Error Code	Further Meaning	Behavior
Success	0000	Matching complete	Whenever the move operation succeeded.
Failure	A801	Refused - Move Destination Unknown	Whenever the move destination is unknown to the system.
	C000	Error - Unable to Process	Whenever the move operation failed.
Warning	B000	Sub-operations Complete - One or more Failures	Whenever one of the store operations failed
Pending	FF00	Pending	For every store response received.
Cancel	FE00	Cancel	When receiving a cancel move request.

4.2.1.4.4. (Real-World) Activity – Image Import

4.2.1.4.4.1. Description and Sequencing of Activities

The real world activity associated with the C-STORE operation is the storage of the image in the memory of the system upon which DICOM Manager is running in order to make it available for immediate processing by applications. DICOM Manager will issue a failure status if it is unable to store the image in the memory.

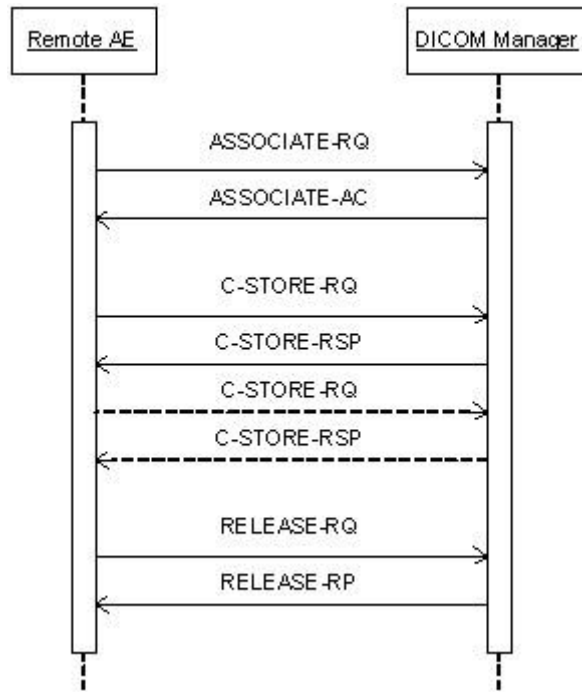

Figure 14: (Real World) Activity - Image Import

4.2.1.4.4.2. Accepted Presentation Contexts

The presentation contexts are defined in next table.

Table 48: Acceptable Presentation Contexts for (Real-World) Activity – Image Import

Presentation Context Table					
Abstract Syntax		Transfer Syntax		Role	Extended Negotiation
Name	UID	Name List	UID List		
Computed Radiography Image Storage SOP Class	1.2.840.10008.5.1.4.1.1.1	JPEG Lossless, Non-Hierarchical, FOP (Process 14)	1.2.840.10008.1.2.4.70	SCP	None
		Explicit VR Little Endian	1.2.840.10008.1.2.1		
		Implicit VR Little Endian	1.2.840.10008.1.2		
		CT-private-ELE	1.3.46.670589.33.1.4.1		
Digital X-Ray Image Storage - For Pres. SOP	1.2.840.10008.5.1.4.1.1.1.1	Explicit VR Little Endian	1.2.840.10008.1.2.1	SCP	None
		Implicit VR Little Endian	1.2.840.10008.1.2		
		CT-private-ELE	1.3.46.670589.33.1.4.1		
		JPEG Lossless, Non-Hierarchical, FOP (Process 14)	1.2.840.10008.1.2.4.70		
Digital X-Ray Image Storage - For Proc. SOP	1.2.840.10008.5.1.4.1.1.1.1.1	Explicit VR Little Endian	1.2.840.10008.1.2.1	SCP	None
		Implicit VR Little Endian	1.2.840.10008.1.2		
		CT-private-ELE	1.3.46.670589.33.1.4.1		
		JPEG Lossless, Non-Hierarchical, FOP (Process 14)	1.2.840.10008.1.2.4.70		
X-Ray Angiographic Image Storage SOP Class	1.2.840.10008.5.1.4.1.1.12.1	Explicit VR Little Endian	1.2.840.10008.1.2.1	SCP	None
		Implicit VR Little Endian	1.2.840.10008.1.2		
		CT-private-ELE	1.3.46.670589.33.1.4.1		
		JPEG Lossless, Non-Hierarchical, FOP (Process 14)	1.2.840.10008.1.2.4.70		
X-Ray Radiofluoroscopic Image Storage SOP Class	1.2.840.10008.5.1.4.1.1.12.2	Explicit VR Little Endian	1.2.840.10008.1.2.1	SCP	None
		Implicit VR Little Endian	1.2.840.10008.1.2		
		CT-private-ELE	1.3.46.670589.33.1.4.1		
		JPEG Lossless, Non-Hierarchical, FOP (Process 14)	1.2.840.10008.1.2.4.70		
CT Image Storage SOP Class	1.2.840.10008.5.1.4.1.1.2	Explicit VR Little Endian	1.2.840.10008.1.2.1	SCP	None
		Implicit VR Little Endian	1.2.840.10008.1.2		
		CT-private-ELE	1.3.46.670589.33.1.4.1		
		JPEG Lossless, Non-Hierarchical, FOP (Process 14)	1.2.840.10008.1.2.4.70		
Secondary Capture Image Storage SOP Class	1.2.840.10008.5.1.4.1.1.7	CT-private-ELE	1.3.46.670589.33.1.4.1	SCP	None
		Explicit VR Little Endian	1.2.840.10008.1.2.1		
		Implicit VR Little Endian	1.2.840.10008.1.2		
		JPEG Lossless, Non-Hierarchical, FOP (Process 14)	1.2.840.10008.1.2.4.70		
X-Ray Radiation Dose SR	1.2.840.10008.5.1.4.1.1.88.67	Explicit VR Little Endian	1.2.840.10008.1.2.1	SCP	None
		Implicit VR Little Endian	1.2.840.10008.1.2		

Presentation Context Table					
Abstract Syntax		Transfer Syntax		Role	Extended Negotiation
Name	UID	Name List	UID List		
General ECG Waveform Storage SOP Class	1.2.840.10008.5.1.4.1.1.9.1.2	Explicit VR Little Endian	1.2.840.10008.1.2.1	SCP	None
		Implicit VR Little Endian	1.2.840.10008.1.2		

Note: The default supported Transfer Syntax is ILE. All Transfer Syntaxes are configurable in LAN Config, in the order Private-ELE, JPEG, ELE, and ILE. JPEG has preference over ELE and ILE.

For all SOP classes without pixel data the JPEG transfer syntax will not supported.

4.2.1.4.4.3. SOP Specific Conformance for Storage SOP Classes

This section and sub-section includes the manufacturer SOP and Dataset specific information as well the status codes and their corresponding behavior.

DICOM Manager provides standard conformance to the DICOM V3.0 Storage Service Class as a SCP. DICOM Manager conforms to the SOPs of the Storage Service Class at Level 2 (Full). In case of a successful C-STORE, the stored image may be accessed by the processing applications.

4.2.1.4.4.3.1. Dataset Specific Conformance for C-STORE-RSP

Detail regarding the Dataset Specific response behavior will be reported in this section.

This includes the dataset specific behavior, i.e. error codes, error and exception handling, time-outs, etc.

Table 49: Status Response

Service Status	Error Code	Further Meaning	Behavior
Success	0000	Successfully stored	Whenever the store operation succeeded.
Failure	Cxxx	Failed	Whenever the store operation failed.

4.2.2. Print Manager

Detail of this specific Application Entity is specified in this section.

4.2.2.1. SOP Classes

This Application Entity provides Standard Conformance to the following SOP Classes.

Table 50: SOP Classes for Print Manager

SOP Class Name	SOP Class UID	SCU	SCP
Basic Color Print Management Meta SOP Class	1.2.840.10008.5.1.1.18	Yes	No
>Basic Film Session SOP Class	1.2.840.10008.5.1.1.1	Yes	No
Basic Grayscale Print Management Meta SOP Class	1.2.840.10008.5.1.1.9	Yes	No
>Basic Film Session SOP Class	1.2.840.10008.5.1.1.1	Yes	No

Note: Any SOP specific behavior is documented later in the conformance statement in the applicable SOP specific conformance section.

Note: The Printer SOP Class is not supported, even though it is included in the table above.

4.2.2.2. Association Policies

Each AE specification contains a description of the general association establishment and acceptance policies of the AE.

4.2.2.2.1. General

The maximum PDU Size that the Print-Manager will use is configurable, with a minimum of 2 Kbytes.

Table 51: DICOM Application Context

Description	Value
Application Context Name	1.2.840.10008.3.1.1.1

4.2.2.2.2. Number of Associations

The number of simultaneous associations that an Application Entity may support as an Initiator or Acceptor is specified.

Print-Manager can have only one open connection at a given time.

Table 52: Number of associations as an Association Initiator for this AE

Description	Value
Maximum number of simultaneous associations	1

4.2.2.2.3. Asynchronous Nature

The implementation supports negotiation of multiple outstanding transactions, along with the maximum number of outstanding transactions supported.

Print-Manager will only allow a single outstanding operation on an association.

Table 53: Asynchronous nature as an Association Initiator for this AE

Description	Value
Maximum number of outstanding asynchronous transactions	1

4.2.2.2.4. Implementation Identifying Information

The value supplied for Implementation Class UID and version name are documented here.

Table 54: DICOM Implementation Class and Version for Print Manager

Implementation Class UID	1.3.46.670589.33.101.1
Implementation Version Name	IQon-Spectral CT

4.2.2.2.5. Communication Failure Handling

Not applicable.

4.2.2.3. Association Initiation Policy

The Application Entity will respond to a received Association rejection as shown in the next table.

Table 55: Association Rejection Response

Service Status	Error Code	Further Meaning	Behavior
1 - rejected-permanent	1 - DICOM UL service-user	1 - no-reason-given	The connection is closed.
		2 - application-context-name-not-supported	The connection is closed.
		3 - calling-AE-title-not-recognized	The connection is closed.
		7 - called-AE-title-not-recognized	The connection is closed.
	2 - DICOM UL service-provider (ACSE related function)	1 - no-reason-given	The connection is closed.
		2 - protocol-version-not-supported	The connection is closed.
2 - rejected-transient	1 - DICOM UL service-user	1 - no-reason-given	The connection is closed.
		2 - application-context-name-not-supported	The connection is closed.
		3 - calling-AE-title-not-recognized	The connection is closed.
		7 - called-AE-title-not-recognized	The connection is closed.
	2 - DICOM UL service-provider (ACSE related function)	1 - no-reason-given	The connection is closed.
		2 - protocol-version-not-supported	The connection is closed.

Service Status	Error Code	Further Meaning	Behavior
	3 - DICOM UL service-provider (Presentation related function)	1 - temporary congestion	The connection is closed.
		2 - local-limit-exceeded	The connection is closed.

The behavior of the AE on receiving an association abort is summarized in next table.

Table 56: Association Abort Handling

Source	Reason/Diagnosis	Behavior
0 - DICOM UL service-user (initiated abort)	0 - reason-not-specified	The connection is closed.
2 - DICOM UL service-provider (initiated abort)	0 - reason-not-specified	The connection is closed.
	1 - unrecognized-PDU	The connection is closed.
	2 - unexpected-PDU	The connection is closed.
	4 - unrecognized-PDU parameter	The connection is closed.
	5 - unexpected-PDU parameter	The connection is closed.
	6 - invalid-PDU-parameter value	The connection is closed.

4.2.2.3.1. (Real-World) Activity – Print Management as SCU

4.2.2.3.1.1. Description and Sequencing of Activities

After selecting the print destination (out of choice list of configured printers) and some print parameters (depending on the configuration and the selected printer; these values can be configured too), Print-Manager initiates an association when a print job is submitted to a DICOM printer (when the user clicks on the print button in the film view). The association is left open after the job is completed for a configurable time-out (so that if there are other jobs to the same printer, they will be done on the same association). Jobs to different printers are performed simultaneously.

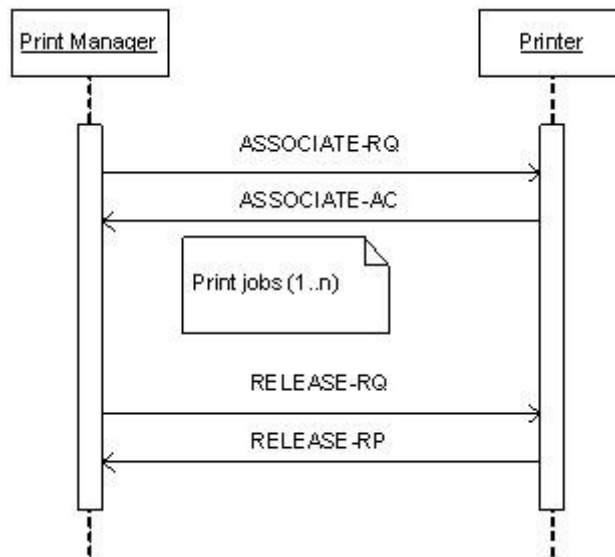

Figure 15: (Real World) Activity - Print Manager Initiates

Normally, when the job is completed and there are no other jobs to the same printer, the Print manager does close the association with an A-RELEASE request. If a TCP/IP connection timeout occurs, then the association is closed. In this case, a new association is set up when needed.

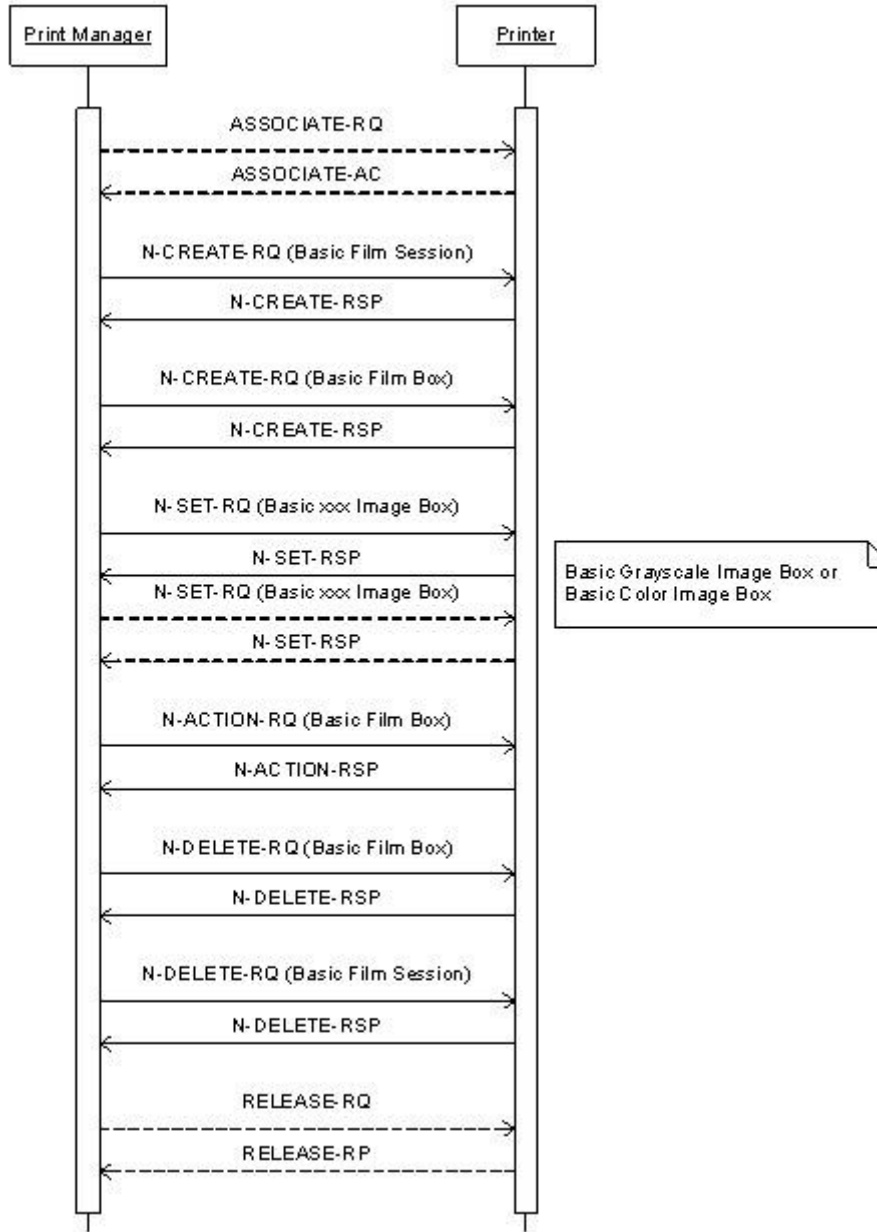

Figure 16: (Real World) Activity - Print Management as SCU

4.2.2.3.1.2. Proposed Presentation Contexts

The presentation contexts are defined in next table.

Table 57: Proposed Presentation Contexts for (Real-World) Activity – Print Management As SCU

Presentation Context Table					
Abstract Syntax		Transfer Syntax		Role	Extended Negotiation
Name	UID	Name List	UID List		
Basic Color Print Management Meta SOP Class	1.2.840.10008.5.1.1.18			SCU	None
>Basic Film Session SOP Class	1.2.840.10008.5.1.1.1	Explicit VR Little Endian	1.2.840.10008.1.2.1	SCU	None
		Implicit VR Little Endian	1.2.840.10008.1.2		
Basic Grayscale Print Management Meta SOP Class	1.2.840.10008.5.1.1.9			SCU	None
>Basic Film Session SOP Class	1.2.840.10008.5.1.1.1	Explicit VR Little Endian	1.2.840.10008.1.2.1	SCU	None
		Implicit VR Little Endian	1.2.840.10008.1.2		
Basic Color Print Management Meta SOP Class	1.2.840.10008.5.1.1.18			SCU	None
>Printer SOP Class	1.2.840.10008.5.1.1.16	Explicit VR Little Endian	1.2.840.10008.1.2.1	SCU	None
		Implicit VR Little Endian	1.2.840.10008.1.2		
Basic Grayscale Print Management Meta SOP Class	1.2.840.10008.5.1.1.9			SCU	None
>Printer SOP Class	1.2.840.10008.5.1.1.16	Explicit VR Little Endian	1.2.840.10008.1.2.1	SCU	None
		Implicit VR Little Endian	1.2.840.10008.1.2		
>Basic Film Box SOP Class	1.2.840.10008.5.1.1.2	Explicit VR Little Endian	1.2.840.10008.1.2.1	SCU	None
		Implicit VR Little Endian	1.2.840.10008.1.2		
Basic Color Print Management Meta SOP Class	1.2.840.10008.5.1.1.18			SCU	None
>Basic Film Box SOP Class	1.2.840.10008.5.1.1.2	Explicit VR Little Endian	1.2.840.10008.1.2.1	SCU	None
		Implicit VR Little Endian	1.2.840.10008.1.2		
Basic Grayscale Print Management Meta SOP Class	1.2.840.10008.5.1.1.9			SCU	None
>Basic Grayscale Image Box SOP Class	1.2.840.10008.5.1.1.4	Explicit VR Little Endian	1.2.840.10008.1.2.1	SCU	None
		Implicit VR Little Endian	1.2.840.10008.1.2		
Basic Color Print Management Meta SOP Class	1.2.840.10008.5.1.1.18			SCU	None
>Basic Color Image Box SOP Class	1.2.840.10008.5.1.1.4.1	Explicit VR Little Endian	1.2.840.10008.1.2.1	SCU	None
		Implicit VR Little Endian	1.2.840.10008.1.2		

Note: The only supported default Transfer Syntaxes for printing are ELE and ILE.

This section specifies each IOD created (including private IOD's).

Abbreviations used in the Module table for the column "Presence of Value" are:

ALWAYS	The attribute is always present with a value
EMPTY	The attribute is always present without any value (attribute sent zero length)
VNAP	The attribute is always present and its Value is Not Always Present (attribute sent zero length if no value is present)
ANAP	The attribute is present under specified condition – if present then it will always have a value
VNAPCV	The attribute is present under specified condition – if present then its Value is Not Always Present (attribute sent zero length if condition applies and no value is present)
ANAPEV	The attribute is present under specified condition – if present then it will not have any value

The abbreviations used in the Module table for the column "Source" are:

AUTO	The attribute value is generated automatically
CONFIG	The attribute value source is a configurable parameter
COPY	The attribute value source is another SOP instance
FIXED	The attribute value is hard-coded in the application
IMPLICIT	The attribute value source is a user-implicit setting
MPPS	The attribute value is the same as that use for Modality Performed Procedure Step
MWL	The attribute value source is a Modality Worklist
USER	The attribute value source is explicit user input

4.2.2.3.1.3. SOP Specific Conformance for Basic Film Session SOP Class of the Basic Color Print Management Meta SOP Class

This section and sub-section includes the manufacturer SOP and Dataset specific information as well the status codes and their corresponding behavior.

The Printer process conforms to the Basic Film Session SOP Class. The following DIMSE service elements are supported: N-CREATE, N-DELETE.

4.2.2.3.1.3.1. Dataset Specific Conformance for Basic Film Session SOP Class N-CREATE-SCU

Detail regarding the Dataset Specific response behavior will be reported in this section.

Table 58: Basic Film Session Presentation Module

Attribute Name	Tag	VR	Value	Presence of Value	Source	Comment
Number of Copies	2000,0010	IS		ALWAYS	USER	Value between 1-100
Print Priority	2000,0020	CS	AUTO, HIGH, LOW, MED	ANAP	USER	
Medium Type	2000,0030	CS	BLUE FILM, CLEAR FILM, PAPER	ALWAYS	CONFIG, USER	
Film Destination	2000,0040	CS	MAGAZINE, PROCESSOR	ALWAYS	CONFIG, USER	

This part of the section includes the dataset specific behavior, i.e. error codes, error and exception handling, time-outs, etc.

Table 59: Status Response

Service Status	Error Code	Further Meaning	Behavior
Success	0000	Film Session successfully created	The print job continues.
Warning	B600	Memory Allocation not supported	The print job continues and the warning is logged.

4.2.2.3.1.3.2. Dataset Specific Conformance for Basic Film Session SOP Class N-DELETE-SCU

Detail regarding the Dataset Specific response behavior will be reported in this section.

This part of the section includes the dataset specific behavior, i.e. error codes, error and exception handling, time-outs, etc.

Table 60: Status Response

Service Status	Error Code	Further Meaning	Behavior
Success	0000	Film Session successfully created	The SCP has completed the operation successfully.

Service Status	Error Code	Further Meaning	Behavior
Other than Success	<>0000	Other status	On any other status then success, the job remains in the queue manager, with status failed.

4.2.2.3.1.4. SOP Specific Conformance for Basic Film Session SOP Class of the Basic Grayscale Print Management Meta SOP Class

This section and sub-section includes the manufacturer SOP and Dataset specific information as well the status codes and their corresponding behavior.

The Printer process conforms to the Basic Film Session SOP Class. The following DIMSE service element is supported: N-CREATE, N-DELETE.

4.2.2.3.1.4.1. Dataset Specific Conformance for Basic Film Session SOP Class N-CREATE-SCU

Detail regarding the Dataset Specific response behavior will be reported in this section.

Table 61: Basic Film Session Presentation Module

Attribute Name	Tag	VR	Value	Presence of Value	Source	Comment
Number of Copies	2000,0010	IS		ALWAYS	CONFIG, USER	
Print Priority	2000,0020	CS	AUTO, HIGH, LOW, MED	ALWAYS	CONFIG, USER	
Medium Type	2000,0030	CS	BLUE FILM, CLEAR FILM, PAPER	ALWAYS	USER	Value between 1-100
Film Destination	2000,0040	CS	MAGAZINE, PROCESSOR	ANAP	USER	

This part of the section includes the dataset specific behavior, i.e. error codes, error and exception handling, time-outs, etc.

Table 62: Status Response

Service Status	Error Code	Further Meaning	Behavior
Success	0000	Film Session successfully created	The print job continues.
Warning	B600	Memory Allocation not supported	The print job continues and the warning is logged.

4.2.2.3.1.4.2. Dataset Specific Conformance for Basic Film Session SOP Class N-DELETE-SCU

Detail regarding the Dataset Specific response behavior will be reported in this section.

This part of the section includes the dataset specific behavior, i.e. error codes, error and exception handling, time-outs, etc.

Table 63: Status Response

Service Status	Error Code	Further Meaning	Behavior
Success	0000	Film Session successfully created	The SCP has completed the operation successfully.
Other than Success	<>0000	Other status	On any other status then success, the job remains in the queue manager, with status failed.

4.2.2.3.1.5. SOP Specific Conformance for Printer SOP Class of the Basic Color Print Management Meta SOP Class

Not applicable, Printer SOP Class is not supported.

4.2.2.3.1.5.1. Dataset Specific Conformance for Printer SOP Class N-EVENT-REPORT-SCP

Not applicable, Printer SOP Class is not supported.

4.2.2.3.1.6. SOP Specific Conformance for Printer SOP Class of the Basic Grayscale Print Management Meta SOP Class

Not applicable, Printer SOP Class is not supported.

4.2.2.3.1.6.1. Dataset Specific Conformance for Printer SOP Class N-EVENT-REPORT-SCP

Not applicable, Printer SOP Class is not supported.

4.2.2.3.1.7. SOP Specific Conformance for Basic Film Box SOP Class of the Basic Grayscale Print Management Meta SOP Class

This section and sub-section includes the manufacturer SOP and Dataset specific information as well the status codes and their corresponding behavior.

The Printer process conforms to the Basic Film Box Sop Class. The following DIMSE service elements are supported: N-CREATE, N-ACTION, and N-DELETE.

4.2.2.3.1.7.1. Dataset Specific Conformance for Basic Film Box SOP Class N-CREATE-SCU

Detail regarding the Dataset Specific response behavior will be reported in this section.

Table 64: Basic Film Box Presentation Module

Attribute Name	Tag	VR	Value	Presence of Value	Source	Comment
Image Display Format	2010,0010	ST	STANDARD\1,1	ALWAYS	CONFIG	
Film Orientation	2010,0040	CS	LANDSCAPE, PORTRAIT	ALWAYS	CONFIG, USER	
Film Size ID	2010,0050	CS		ALWAYS	CONFIG, USER	As in printer configuration file.
Magnification Type	2010,0060	CS		ALWAYS	CONFIG	As in printer configuration file.
Min Density	2010,0120	US		ALWAYS	CONFIG	As in printer configuration file.
Max Density	2010,0130	US		ALWAYS	CONFIG	As in printer configuration file.
Trim	2010,0140	CS	NO, YES	ALWAYS	CONFIG, USER	
Configuration Information	2010,0150	ST		ALWAYS	CONFIG	As in printer configuration file.

Table 65: Basic Film Box Relationship Module

Attribute Name	Tag	VR	Value	Presence of Value	Source	Comment
Referenced Film Session Sequence	2010,0500	SQ		ALWAYS	AUTO	
>Referenced SOP Class UID	0008,1150	UI		ALWAYS	AUTO	UID of Parent Film Session.

>Referenced SOP Instance UID	0008,1155	UI		ALWAYS	AUTO	
------------------------------	-----------	----	--	--------	------	--

This part of the section includes the dataset specific behavior, i.e. error codes, error and exception handling, time-outs, etc.

Table 66: Status Response

Service Status	Error Code	Further Meaning	Behavior
Success	0000	Film Box successfully created	The SCP has completed the operation successfully.
Warning	B605	Requested Min Density or Max Density outside of Printer's operating Range	The print job continues and the warning is logged.
Failure	C616	There is an existing Film Box that has not been printed	The print job is marked as failed and the reason is logged.

4.2.2.3.1.7.2. Dataset Specific Conformance for Basic Film Box SOP Class N-ACTION-SCU

Detail regarding the Dataset Specific response behavior will be reported in this section.

This part of the section includes the dataset specific behavior, i.e. error codes, error and exception handling, time-outs, etc.

Table 67: Status Response

Service Status	Error Code	Further Meaning	Behavior
Success	0000	Film accepted for printing	The print job continues.
Warning	B603	Film Box SOP Instance Hierarchy does not contain Image Box SOP Instances	The print job continues and the warning is logged and reported to the user.
	B604	Image Size is larger than Image Box Size - The Image has been de-magnified	The print job continues and the warning is logged and reported to the user.
	B609	Image Size is larger than Image Box Size - The Image has been cropped to fit	The print job continues and the warning is logged and reported to the user.
	B60A	Image Size or combined Print Image Size is larger than Image Box Size - The Image or combined Print Image has been decimated to fit	The print job continues and the warning is logged and reported to the user.
Failure	C602	Unable to create Print Job SOP Instance - Print Queue is full	The print job is marked as failed and the reason is logged and reported to the user.
	C603	Image Size is larger than Image Box Size	The print job is marked as failed and the reason is logged and reported to the user.
	C613	Combined Print Image Size is larger than Image Box Size	The print job is marked as failed and the reason is logged and reported to the user.

4.2.2.3.1.7.3. Dataset Specific Conformance for Basic Film Box SOP Class N-DELETE-SCU

Detail regarding the Dataset Specific response behavior will be reported in this section.

This part of the section includes the dataset specific behavior, i.e. error codes, error and exception handling, time-outs, etc.

Table 68: Status Response

Service Status	Error Code	Further Meaning	Behavior
Success	0000	Film Session successfully created	The SCP has completed the operation successfully.
Other than Success	<>0000	Other status	On any other status then success, the job remains in the queue manager, with status failed.

4.2.2.3.1.8. SOP Specific Conformance for Basic Film Box SOP Class of the Basic Color Print Management Meta SOP Class

This section and sub-section includes the manufacturer SOP and Dataset specific information as well the status codes and their corresponding behavior.

The Printer process conforms to the Basic Film Box Sop Class. The following DIMSE service elements are supported: N-CREATE, N-ACTION, and N-DELETE.

4.2.2.3.1.8.1. Dataset Specific Conformance for Basic Film Box SOP Class N-CREATE-SCU

Detail regarding the Dataset Specific response behavior will be reported in this section.

Table 69: Basic Film Box Presentation Module

Attribute Name	Tag	VR	Value	Presence of Value	Source	Comment
Image Display Format	2010,0010	ST	STANDARD\1,1	ALWAYS	CONFIG	
Film Orientation	2010,0040	CS	LANDSCAPE, PORTRAIT	ALWAYS	CONFIG, USER	
Film Size ID	2010,0050	CS		ALWAYS	CONFIG, USER	As in printer configuration file.
Magnification Type	2010,0060	CS		ALWAYS	CONFIG	As in printer configuration file.
Min Density	2010,0120	US		ALWAYS	CONFIG	As in printer configuration file.
Max Density	2010,0130	US		ALWAYS	CONFIG	As in printer configuration file.
Trim	2010,0140	CS	NO, YES	ALWAYS	CONFIG, USER	
Configuration Information	2010,0150	ST		ALWAYS	CONFIG	As in printer configuration file.

Table 70: Basic Film Box Relationship Module

Attribute Name	Tag	VR	Value	Presence of Value	Source	Comment
Referenced Film Session Sequence	2010,0500	SQ		ALWAYS	AUTO	
>Referenced SOP Class UID	0008,1150	UI		ALWAYS	AUTO	UID of Parent Film Session.
>Referenced SOP Instance UID	0008,1155	UI		ALWAYS	AUTO	

This part of the section includes the dataset specific behavior, i.e. error codes, error and exception handling, time-outs, etc.

Table 71: Status Response

Service Status	Error Code	Further Meaning	Behavior
Success	0000	Film Box successfully created	The SCP has completed the operation successfully.
Warning	0107	Attribute list error	The print job continues and the warning is logged.
	0116	Attributes out of range	The print job continues and the warning is logged.
	B000 - B007		The print job continues and the warning is logged.
	B605	Requested Min Density or Max Density outside of Printer's operating Range	The print job continues and the warning is logged.
Failure	C616	There is an existing Film Box that has not been printed	The print job is marked as failed and the reason is logged.

4.2.2.3.1.8.2. Dataset Specific Conformance for Basic Film Box SOP Class N-ACTION-SCU

Detail regarding the Dataset Specific response behavior will be reported in this section.

This part of the section includes the dataset specific behavior, i.e. error codes, error and exception handling, time-outs, etc.

Table 72: DICOM Command Response Status Handling Behavior for Basic Film Box N-Action

Service Status	Error Code	Further Meaning	Behavior
Success	0000	Film accepted for printing	The print job continues.
Warning	0107	Attribute list error	The print job continues and the warning is logged.
	0116	Attribute out of range	The print job continues and the warning is logged.
	B000 - B007		The print job continues and the warning is logged.
	B603	Film Box SOP Instance Hierarchy does not contain Image Box SOP Instances	The print job continues and the warning is logged and reported to the user.
	B604	Image Size is larger than Image Box Size - The Image has been de-magnified	The print job continues and the warning is logged and reported to the user.
	B609	Image Size is larger than Image Box Size - The Image has been cropped to fit	The print job continues and the warning is logged and reported to the user.
	B60A	Image Size or combined Print Image Size is larger than Image Box Size - The Image or combined Print Image has been decimated to fit	The print job continues and the warning is logged and reported to the user.
Failure	<> 0000	Any other status then success	The print job is marked as failed; the reason is logged and reported to the user.

4.2.2.3.1.8.3. Dataset Specific Conformance for Basic Film Box SOP Class N-DELETE-SCU

Detail regarding the Dataset Specific response behavior will be reported in this section.

This part of the section includes the dataset specific behavior, i.e. error codes, error and exception handling, time-outs, etc.

Table 73: Status Response

Service Status	Error Code	Further Meaning	Behavior
Success	0000	Film Session successfully created	The SCP has completed the operation successfully
Other than Success	<>0000	Any other status then success	The job remains in the queue manager, with status failed

4.2.2.3.1.9. SOP Specific Conformance for Basic Grayscale Image Box SOP Class of the Basic Grayscale Print Management Meta SOP Class

This section and sub-section includes the manufacturer SOP and Dataset specific information as well the status codes and their corresponding behavior.

The Printer process conforms to the Basic Grayscale Image Box Sop Class. The following DIMSE service element is supported: N-SET.

4.2.2.3.1.9.1. Dataset Specific Conformance for Basic Grayscale Image Box SOP Class N-SET-SCU

Detail regarding the Dataset Specific response behavior will be reported in this section.

Table 74: Image Box Pixel Presentation Module

Attribute Name	Tag	VR	Value	Presence of Value	Source	Comment
Image Box Position	2020,0010	US	1	ALWAYS	AUTO	
Basic Grayscale Image Sequence	2020,0110	SQ		ALWAYS	AUTO	
>Samples per Pixel	0028,0002	US	1, 3	ALWAYS	AUTO	
>Photometric Interpretation	0028,0004	CS	MONOCHROME2, RGB	ALWAYS	AUTO	
>Rows	0028,0010	US		ALWAYS	AUTO	As in printer configuration file.
>Columns	0028,0011	US		ALWAYS	AUTO	As in printer configuration file.
>Pixel Aspect Ratio	0028,0034	IS		ALWAYS	AUTO	Must be present if not 1/1.
>Bits Allocated	0028,0100	US	8	ALWAYS	AUTO	
>Bits Stored	0028,0101	US	8	ALWAYS	AUTO	
>High Bit	0028,0102	US	7	ALWAYS	AUTO	
>Pixel Representation	0028,0103	US	0	ALWAYS	AUTO	
>Pixel Data	7FE0,0010	OW/OB		ALWAYS	AUTO	

This part of the section includes the dataset specific behavior, i.e. error codes, error and exception handling, time-outs, etc.

Table 75: DICOM Command Response Status Handling Behavior for Basic Grayscale Image Box N-SET

Service Status	Error code	Further meaning	Behavior
Success	0000		The print job continues
Warning	0107		The print job is continues and the warning is logged.
	0116		The print job is continues and the warning is logged.
	B000 - B007		The print job is continues and the warning is logged.
	B604		The print job continues, the warning is logged and reported to the user.
	B605		The print job continues, the warning is logged and reported to the user.
	B609		The print job continues, the warning is logged and reported to the user.
	B60A		The print job continues, the warning is logged and reported to the user.
Error	<xxxx>	All other error code not found in this list	The print job is marked as failed and the reason is logged and reported to the user

4.2.2.3.1.10. SOP Specific Conformance for Basic Color Image Box SOP Class of the Basic Color Print Management Meta SOP Class

This section and sub-section includes the manufacturer SOP and Dataset specific information as well the status codes and their corresponding behavior.

The Printer process conforms to the Color Image Box Sop Class. The following DIMSE service element is supported: N-SET

4.2.2.3.1.10.1. Dataset Specific Conformance for Basic Color Image Box SOP Class N-SET-SCU

Detail regarding the Dataset Specific response behavior will be reported in this section.

Table 76: Image Box Pixel Presentation Module

Attribute Name	Tag	VR	Value	Presence of Value	Source	Comment
Image Box Position	2020,0010	US	1	ALWAYS	AUTO	
Basic Color Image Sequence	2020,0111	SQ		ALWAYS	AUTO	
>Samples per Pixel	0028,0002	US	3	ALWAYS	AUTO	
>Photometric Interpretation	0028,0004	CS	RGB	ALWAYS	AUTO	
>Planar Configuration	0028,0006	US	0, 1	ALWAYS	AUTO	
>Rows	0028,0010	US		ALWAYS	AUTO	As in printer configuration file.
>Columns	0028,0011	US		ALWAYS	AUTO	As in printer configuration file.
>Pixel Aspect Ratio	0028,0034	IS		ALWAYS	AUTO	Must be present if not 1/1.
>Bits Allocated	0028,0100	US	8	ALWAYS	AUTO	
>Bits Stored	0028,0101	US	8	ALWAYS	AUTO	
>High Bit	0028,0102	US	7	ALWAYS	AUTO	
>Pixel Representation	0028,0103	US	0	ALWAYS	AUTO	
>Pixel Data	7FE0,0010	OW/OB		ALWAYS	AUTO	

This part of the section includes the dataset specific behavior, i.e. error codes, error and exception handling, time-outs, etc.

Table 77: DICOM Command Response Status Handling Behavior for Basic Color Image Box N-SET

Service Status	Error Code	Further Meaning	Behavior
Success	0000	Image successfully stored in Image Box	The print job continues.
Warning	0107	Attribute list error	The print job continues and the warning is logged.
	0116	Attribute out of range	The print job continues and the warning is logged.
	B000 - B007		The print job continues and the warning is logged.
	B604	Image Size is larger than Image Box Size - The Image has been de-magnified	The print job continues and the warning is logged and reported to the user.
	B605	Requested Min Density or Max Density outside of Printer's operating Range	The print job continues and the warning is logged and reported to the user.
	B609	Image Size is larger than Image Box Size - The Image has been cropped to fit	The print job continues and the warning is logged and reported to the user.
Error	B60A	Image Size or combined Print Image Size is larger than Image Box Size - The Image or combined Print Image has been decimated to fit	The print job continues and the warning is logged and reported to the user.
	<xxxx>	all other errors than found in this list	The print job is marked as failed and the reason is logged and reported to the user.

4.2.2.4. Association Acceptance Policy

Not applicable, Print Manager AE never accepts an association.

4.3. Network Interfaces

4.3.1. Physical Network Interfaces

The System provides only DICOM V3.0 TCP/IP Network Communication Support as defined in PS 3.8 of the DICOM standard.

IQon CT inherits its TCP/IP stack from Windows 7 (i.e. the operating system platform).

IQon CT supports a single network interface Ethernet ISO 8802-3.

With standard supported physical medium include:

IEEE 802.3-1995, 10BASE-T

IEEE 802.3-1995, 100BASE-TX (Fast Ethernet)

IEEE 802.3, 1000BASE-X (Fiber Optic Gigabit Ethernet).

4.3.2. Additional Protocols

Additional protocols such as used for network management are not applicable.

4.4. Configuration

Any implementation's DICOM conformance may be dependent upon configuration, which takes place at the time of installation. Issues concerning configuration are addressed in this section.

4.4.1. AE Title/Presentation Address Mapping

The IQon CT system is configured by means of a configuration program. This program is accessible at start-up of the IQon CT system. It is password protected and intended to be used by the administrator onsite or Philips Customer Support Engineers only.

Per configuration in LAN Config Tool, the system allows to accept associations from a range of IP addresses (it will not check source IP or Calling AE Title). With incoming association requests the system allows acceptance of a range of defined IP addresses which is configurable in the LAN Config application. The system is not IP or AE title sensitive.

An important installation issue is the translation from AE title to presentation address. With incoming association requests the system allows acceptance of a range of defined IP addresses which is configurable in the LAN Config application. How this is performed is described in this section. The system is not IP or AE title sensitive.

4.4.1.1. Local AE Titles

The local AE title mapping and configuration are specified as:

Table 78: AE Title configuration table

Application Entity	Default AE Title	Default TCP/IP Port
DICOM Manager	SCU: <system AE title>, SCP: <system AE title> or <local folder>	104 (configurable)
Print Manager	<system AE title>	Configurable

4.4.1.2. Remote AE Title/Presentation Address Mapping

Remote AE Title, IP-Address, Port-number, supported DICOM Services and Transfer Syntaxes are freely configurable.

4.4.2. Parameters

The specification of important operational parameters, their default value and range (if configurable) is specified here.

Table 79: Configuration Local Parameters table

Local Parameters	Configurable	Default Value
Basic Parameters		
Network - Computer Name	Yes	<hostname> Set during installation
Network - IP	Yes	(0.0.0.0)
Network - NetMask	Yes	
Network - Gateway	Yes	(0.0.0.0)
System Port	Yes	104
System - AE Title	Yes	DATABASE
MPPS Repair mode	Yes	Checked
Advanced Parameters		
IP Filter Mode	Yes	Configured Device IPS
Auto Import - Enable	Yes	Unchecked
Auto Import - Input Folder Name	Yes	No Value
Auto Import - Failed Folder Name	Yes	No Value
Auto Import - Import Type	Yes	DICOM
Auto Import – Polling Interval In Seconds	Yes	60
Verify Service Timeout in Seconds	Yes	60
Query Service Timeout in Seconds	Yes	60
Storage Service Timeout in Seconds	Yes	300
Storage Commitment Service Timeout in Seconds	Yes	300
Retrieve Service Timeout in Seconds	Yes	300
Print Service Timeout in Seconds	Yes	300

Table 80: Configuration Remote Parameters Table

Remote Parameters	Configurable	Default Value
Basic Parameters- remote node		
Device Name	Yes	300
Port	Yes	Image
AE-Title	Yes	100
Visible	Yes	Visible
Enable	Yes	Checked
Archived	Yes	Unchecked
CharSet	Yes	Unchecked
Large Archive	Yes	Unchecked
Max PDU	Yes	65536
ARTimer	Yes	5
Transfer Syntax	Yes	ELE and ILE enabled
Advanced Parameters - Query		
Association Timeout In Seconds	Yes	300
Lowest Support Level	Yes	Image
Query Response Size	Yes	100
Advanced Parameter - Store		
Association Timeout In Seconds	Yes	120

Remote Parameters	Configurable	Default Value
Advanced Parameter - Retrieve		
Association Timeout In Seconds	Yes	0
Advanced Parameter - Storage Commitment		
Association Timeout In Seconds	Yes	120
Advanced Parameter – Worklist Query		
Association Timeout In Seconds	Yes	120
Query Response Size	Yes	100
Advanced Parameter - MPPS		
Association Timeout In Seconds	Yes	120

Table 81: Configuration General Print Parameters Table

General Print Parameter	Configurable	Default Value
Advanced Parameter		
Association Timeout In Seconds	Yes	150

Printers are configurable by a selection of the default printer types. Every printer type has a fixed configuration, but can be extended with new ones. The default printer settings are defined in the printer configuration file.

5. Media Interchange

5.1. Implementation model

The implementation model identifies the DICOM Application Entities for Media in specific implementation and relates the Application Entities to Real-World Activities.

5.1.1. Application Data Flow Diagram

As part of the implementation model, an application data flow diagram is included. The next Figure shows the media interchange application data flow as a functional overview of the Media AE for DICOM CD and DVD.

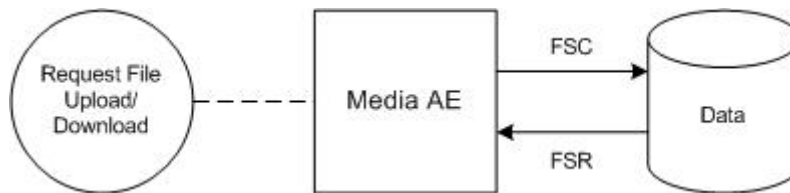

Figure 17: Media Interchange Application Data Flow Diagram

The Media AE acts as a FSR, for CD and DVD, when reading the directory of the medium. The Media AE acts as a FSC for CD and DVD, when writing the selected images in a patient folder onto the medium.

5.1.2. Functional Definitions of AE's

This section contains a functional definition for each local Application Entity. It's described in general terms the functions to be performed by the AE, and the DICOM services used to accomplish these functions.

The IQon CT system can create and Read CD/DVD.

The Media AE in an IQon CT system supports the following functions for CD and DVD as FSR:

- Read the DICOMDIR File from the medium (representing the directory of the DICOM File(s) as recorded on the medium). This information may be displayed as an ordered list of icon images and, if present, with pertinent identifying information (patient name, etc.).
- Read the selected image from the medium and display it on the monitor of the View Station. This information is displayed as an ordered list of frames of the selected image or as a dynamic review of the selected image.

Remark: only CD's and DVD's that were created according to the application profiles STD-GEN-CD, STD-CTMR-CD and STD-CTMR-DVD are supported as FSR by the IQon CT system.

And for CD and DVD as FSC:

- Initialize the medium.
- Write a DICOM File-set onto the medium.
- Create a DICOMDIR File.
- Extend the DICOM File-set and update the DICOMDIR File accordingly. (DICOM Media Storage Service Class).

5.1.3. Sequencing of Real World Activities

A Real World Activity of the Media AE is: The user selects a set of objects to write to the CD/DVD. Then the CD /DVD will be created with the selected objects. Once the CD/DVD has been created, the user can read this CD/DVD on the IQon CT system or for transport to another device for reading.

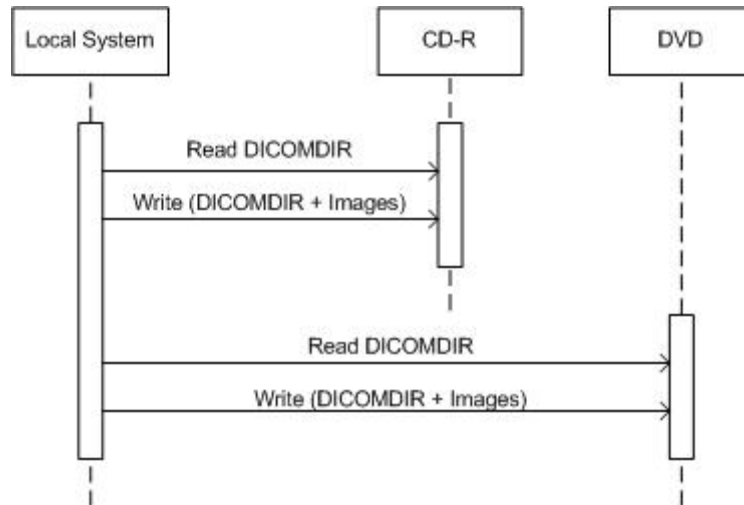

Figure 18: (Real World) Activity - Media

Another Real World Activity of the Media AE is: A CD/DVD from another system or previously created CD/DVD can be read by the IQon CT system.

Remark: DVD's that were created following the definition of the STD-GEN-DVD-JPEG application profile are not supported for reading since IQon does not support JPEGBaseline and JPEG2000 compression

After data is written to DVD, the DVD is finalized; the finalized DVD can now be read on mostly every DVD reader.

5.2. AE Specifications

This section in the DICOM Conformance Statement specifies a set of Media Application Entities.

5.2.1. Media AE Media - Specification

The supported Application Profiles, their Roles and the Service Class options, all defined in DICOM terminology, are listed in the following table.

For reading and writing the media AE provides standard conformance to:

- DICOM media Storage Service and File Format ([DICOM] PS 3.10);
- Media Storage Application Profiles ([DICOM] PS 3.11); and
- Media Formats and Physical Media for Media Interchange ([DICOM] PS 3.12) for Reading (FSR) and Writing (FSC).

IQon CT system does not support multi-session writes to CD/DVD's.

Supported media:

- CD: CD-R and CD-RW
- DVD: DVD-R, DVD+R, DVD-RW and DVD+RW.

The supported Application Profiles, their roles and the Service Class (SC) options, all defined in DICOM terminology, are listed in the next Table.

Table 82: AE Media AE related Application Profiles, RWA activities and roles

Supported Application Profile	Identifier	Real-World Activities	Roles
CT/MR Studies on CD-R	STD-CTMR-CD	Create File-set	FSC
		Read File-set	FSR
		Display Directory	DD
General Purpose CD-R Interchange	STD-GEN-CD	Create File-set	FSC
		Read File-set	FSR
		Display Directory	DD
CT/MR Studies on DVD Media	STD-CTMR-DVD	Create File-set	FSC
		Read File-set	FSR
		Display Directory	DD
General Purpose DVD Interchange with JPEG	STD-GEN-DVD-JPEG	Create File-set	FSC

5.2.1.1. File Meta Information for the Media AE

This section contains the values of the file Meta Information that pertain to the Application Entity (see PS 3.10). These are:

- Source Application Entity Title,
- Private Information Creator UID,
- Private Information.

The Application Entity title is registered into the DICOM File Meta Information header and is supported by the CD/DVD-Writer (CD/DVD write option) acting as a FSC.

Table 83: File Meta Information for the Media AE

Implementation Class UID	1.3.46.670589.33.101.1
Implementation Version Name	IQon-Spectral CT

5.2.1.2. Real-World Activities

The AE specification contains a description of the Real-World Activities, which invoke the particular AE.

5.2.1.2.1. RWA - Read File-set

When an image transfer from CD or DVD is initiated then the Media AE acts as an FSR using the interchange option to import SOP Instances from the CD or DVD medium.

5.2.1.2.1.1. Media Storage Application Profile

The media AE supports the RWA Read File-set for the STD-CT/MR studies on CD, the STD-GEN-CD and CT/MR Studies application profiles.

5.2.1.2.1.1.1. Options

Not applicable.

5.2.1.2.2. RWA - Create File-set

This Media Application Entity has a File-set Creator functionality which is describe here.

When an image transfer to CD/DVD is initiated then the Media AE acts as an FSC using the interchange option to export SOP Instances from the local database to a CD/DVD medium.

5.2.1.2.2.1. Media Storage Application Profile

The application Profile that is used by this Media Application Entity is specified in this section.

As depicted in the table in section 5.2.1, the Media AE supports the RWA Write Images for the STD-CTMR-CD, STD-GEN-CD, STD-GEN-DVD-JPEG and the STD-CTMR-DVD Application Profile.

The DICOMDIR file will be extended when new images are written. In case some attributes are not present in an image but are specified as mandatory in the DICOMDIR definition in DICOM Media, a generated value will be filled in.

Implementation remarks and restrictions

When writing the DICOMDIR records, key values are generated when no value of the corresponding attribute is supplied, according to the following tables.

Table 84: Generated Keys

Key	Tag	Generated Value
Study Keys		
Study Date	(0008,0020)	Date on which this Study was created.
Study Time	(0008,0030)	Time on which this Study was created.
Study Keys		
Series Number	(0020,0011)	1
Image Keys		
Instance Number	(0020,0013)	1 (if empty)

The data selected to write to the media must fit on the currently inserted media. If it does not fit, an error is generated and it is up to the operator to re-select a smaller amount of data to be written to the media. The system will not request additional media or write across multiple media.

Table 85: Supported attributes in the DICOMDIR

DICOM Tag	Description
0002,0000	Group 0002 Length
0002,0001	File Meta Information Version
0002,0002	UI Media Storage Sop Class UID
0002,0003	UI Media Storage Sop Instance UID
0002,0010	UI Transfer Syntax UID
0002,0012	UI Implementation Class UID
0002,0013	Implementation Version Name
0002,0016	Source Application Entity Title
File Set and Directory Information	
0004,1130	File Set ID
0004,1200	First Directory Record Offset
0004,1202	Last Directory Record Offset
0004,1212	File Set Consistency Flag

DICOM Tag	Description
0004,1220	Directory Record Sequence
Patient level	
0004,1400	Offset Of The Next Dir Record
0004,1410	Record In Use Flag
0004,1420	Offset of Referenced Lower-Level Directory Entity
0004,1430	Directory Record Type
0008,0005	Specific Character Set
0010,0010	Patient's Name
0010,0020	Patient ID
Study level	
0004,1400	Offset Of The Next Dir Record
0004,1410	Record In Use Flag
0004,1420	Offset Of Ref Lower Level Dir Entity
0004,1430	Directory Record Type
0008,0005	Specific Character Set
0008,0020	Study Date
0008,0030	Study Time
0008,0050	Accession Number
0008,0061	Modalities in Study
0008,0080	Institution Name
0008,0090	Referring Physician's Name
0008,1070	Operators Name
0010,0030	Patient's Birth Date
0010,0040	Patient's Sex
0008,1030	Study Description
0020,000D	Study Instance UID
0020,0010	Study ID
0020,1206	Number Of Study Related Series
0020,1208	Number Of Study Related Instances
0040,1001	Requested Procedure ID
Series level	
0004,1400	Offset Of The Next Dir Record
0004,1410	Record In Use Flag
0004,1420	>Offset of Referenced Lower-Level Directory Entity
0004,1430	Directory Record Type
0008,0005	Specific Character Set
0008,0021	Series Date
0008,0023	Content Date
0008,0031	Series Time
0008,0033	Content Time
0008,0060	Modality
0008,0070	Manufacturer
0008,103E	Series Description
0018,1030	Protocol Name
0020,000E	Series Instance UID
0020,0011	Series Number
0020,1209	Number of Series Related Instances

DICOM Tag	Description
0040,0275	Request Attributes Sequence
Image level	
0004,1400	Offset Of The Next Dir Record
0004,1410	Record In Use Flag
0004,1420	Offset Of Ref Lower Level Dir Entity
0004,1430	Directory Record Type
0004,1500	Referenced File ID
0004,1510	Referenced Sop Class UID In File
0004,1511	Ref Sop Instance UID In File
0004,1512	Referenced Transfer Syntax UID in FILE
0008,0005	Specific Character Set
0008,0008	Image Type
0008,0012	Instance Creation Date
0008,0013	Instance Creation Time
0008,0016	SOP Class UID
0008,0018	SOP Instance UID
0008,0022	Acquisition Date
0008,0023	Content Date
0008,0032	Acquisition Time
0008,0033	Content Time
0018,0010	Contrast/Bolus Agent
0018,0050	Slice Thickness
0018,0060	KVP
0018,1100	Reconstruction Diameter
0018,1120	Gantry/Detector Tilt
0018,1141	Angular Position
0020,0013	Instance Number
0020,0032	Image Position (Patient)
0020,0037	Image Orientation (Patient)
0020,0052	Frame of Reference UID
0020,1041	Slice Location
0020,4000	Image Comments
0028,0002	Samples per Pixels
0028,0004	Photometric Interpretation
0028,0010	Rows
0028,0011	Columns
0028,0030	Pixel Spacing
0028,0100	Bits Allocated

5.2.1.2.2.1.1. Options

Not applicable.

5.2.1.2.3. RWA - Display Directory

When a database open action is initiated on the CD/DVD then the Media AE acts as an FSR using the interchange option to read the DICOMDIR of the CD/DVD media.

This will result in an overview of the patients, studies, series and images on the IQon CT screen.

5.2.1.2.3.1. Media Storage Application Profile

The media AE supports the RWA Display Directory for the STD-CT/MR studies on CD, the STD-GEN-CD, the General Purpose DVD Interchange with JPEG and CT/MR Studies on DVD Media application profiles.

5.2.1.2.3.1.1. Options

The mandatory DICOMDIR keys are required for the correct display of directory information. The display is structured according the DICOM Composite Information Model: Patient, Study, Series, and Image.

The DICOM standard specifies certain attributes of the DICOMDIR as mandatory. However, these attributes may not be mandatory for the related SOP class IOD. For those attributes the default values apply.

5.3. Augmented and Private Application Profiles

Not applicable

5.4. Media Configuration

Any configuration issues may be found in the Networking Section 4.4 Configuration.

6. Support of Character Sets

Any support for character sets in Network and Media services is described here.

Table 86: Supported DICOM Character Sets

Character Set Description	Defined Term	ESC Sequence	ISO Registration Number	Code Element	Character Set
Latin alphabet No. 1	ISO_IR 100	-	ISO-IR 6	G0	ISO 646
		-	ISO-IR 100	G1	Supplementary set of ISO 8859
Default repertoire	-	-	ISO-IR 6	G0	ISO 646
		-	-	-	-

7. Security

7.1. Security Profiles

Not applicable.

7.1.1. Security use Profiles

Not applicable.

7.1.2. Security Transport Connection Profiles

Not applicable.

7.1.3. Digital Signature Profiles

Not applicable.

7.1.4. Media Storage Security Profiles

Not applicable.

7.1.5. Attribute Confidentiality Profiles

No instances of the Encrypted Attributes Data Set are created. No Transfer Syntaxes are supported for encoding/decoding of Encrypted Attributes Data Sets.

The table below lists the attributes that are replaced during the anonymisation process.

The terms used to describe the replacement value can be read as below:

- Empty: The attribute will have a value of zero length, is cleared by IQon CT system.
- Copied: Attribute has same value as original.

Table 87: Basic Application Level Confidentiality Profile Attributes

Attribute Name	Tag	VR	Replacement Value
Specific Character Set	0008,0005	CS	Copied from original
Instance Creator UID	0008,0014	UI	[empty]
SOP Instance UID	0008,0018	UI	New created UID
Study Date	0008,0020	DT	Replaced by new value
Series Date	0008,0021	DT	Replaced by new value
Acquisition Date	0008,0022	DT	Replaced by new value
Content Date	0008,0023	DT	Replaced by new value
Study Time	0008,0030	TM	Copied from original
Series Time	0008,0031	TM	Copied from original
Acquisition Time	0008,0032	TM	Copied from original
Content Time	0008,0033	TM	Copied from original
Accession Number	0008,0050	SH	[empty]
Institution Name	0008,0080	LO	Copied from original or [empty] (according to selection in dialog)
Institution Address	0008,0081	ST	Copied from original or [empty] (according to selection in dialog)
Referring Physician's Name	0008,0090	PN	[empty]
Referring Physician's Address	0008,0092	ST	[empty]
Referring Physician's Telephone Numbers	0008,0094	SH	[empty]

Attribute Name	Tag	VR	Replacement Value
Station Name	0008,1010	SH	[empty]
Study Description	0008,1030	LO	[empty]
Series Description	0008,103E	LO	Copied from original
Institutional Department Name	0008,1040	LO	[empty]
Physician(s) of Record	0008,1048	PN	[empty]
Performing Physicians' Name	0008,1050	PN	[empty]
Name of Physician(s) Reading Study	0008,1060	PN	[empty]
Operators' Name	0008,1070	PN	[empty]
Admitting Diagnoses Description	0008,1080	LO	[empty]
Admitting Diagnoses Code SQ	0008,1084	SQ	Copied from Original
Manufacturing's Model Name	0008,1090	LO	[empty]
Referenced Study Sequence	0008,1110	SQ	[empty]
Referenced Patient Sequence	0008,1120	SQ	[empty]
Referenced Image Sequence	0008,1140	SQ	Replaced by new value
Derivation Description	0008,2111	ST	[empty]
Patient's Name	0010,0010	PN	Initials - Last and First Name component can be changed by user
Patient ID	0010,0020	LO	[empty] - Can be changed by user
Patient's Birth Date	0010,0030	DA	Replaced by new value
Patient's Birth Time	0010,0032	TM	Replaced by new value
Patient's Sex	0010,0040	CS	Copied from original
Other Patient ID's	0010,1000	LO	[empty]
Other Patient Names	0010,1001	PN	[empty]
Patient's Age	0010,1010	AS	Copied from original
Patient Height	0010,1020	DS	Copied from original
Patient Weight	0010,1030	DS	Copied from original
Medical Record Locator	0010,1090	LO	[empty]
Medical Alerts	0010,2000	LO	[empty]
Ethnic Group	0010,2160	SH	[empty]
Occupation	0010,2180	SH	[empty]
Additional Patient's History	0010,21B0	LT	[empty]
Pregnancy Status	0010,21C0	US	[empty]
Patient Comment	0010,4000	LT	[empty]
Device Serial Number	0018,1000	LO	[empty]
Protocol Name	0018,1030	LO	[empty]
Study Instance UID	0020,000D	UI	New created UID
Series Instance UID	0020,000E	UI	New created UID
Study ID	0020, 0010	SH	Copied from original
Frame of Reference UID	0020,0052	UI	Copied from original
Synchronization Frame of Reference UID	0020,0200	UI	Copied from original
Image Comments	0020,4000	LT	[empty]
Requesting Physician	0032,1032	PN	[empty]
Requesting Service	0032,1033	LO	[empty]
Requested Procedure Description	0032,1060	LO	[empty]
Requested Procedure Code Sequence	0032,1064	SQ	[empty]
Admission ID	0038,0010	LO	[empty]
Special Needs	0038,0050	LO	[empty]
Current Patient Location	0038,0300	LO	[empty]

Attribute Name	Tag	VR	Replacement Value
Patient State	0038,0500	LO	[empty]
Scheduled Procedure Step Sequence	0040,0100	SQ	[empty]
Performed Procedure Step Start Date	0040,0244	DA	Copied from original
Performed Procedure Step Start Time	0040,0245	TM	Copied from original
Performed Procedure Step ID	0040,0253	SH	Copied from original
Performed Procedure Step Description	0040,0254	LO	Copied from original
Request Attributes Sequence	0040,0275	SQ	[empty]
Requested Procedure ID	0040,1001	SH	[empty]
Names of Intended recipients of Results	0040,1010	PN	[empty]
Requested Procedure Comments	0040,1400	LT	[empty]
Imaging Service Request Comments	0040,2400	LT	[empty]
UID	0040,A124	UI	Copied from original
Content Sequence	0040,A730	SQ	[empty]
Storage Media File Set UID	0088,0140	UI	[empty]
Referenced Frame of Reference UID	3006,0024	UI	[empty]
Related Frame of Reference UID	3006,00C2	UI	[empty]

7.1.6. Network Address Management Profiles

Not applicable.

7.1.7. Time Synchronization Profiles

Not applicable.

7.1.8. Application Configuration Management Profiles

Not applicable.

7.1.9. Audit Trail Profiles

Not applicable.

7.2. Association Level Security

Not applicable.

7.3. Application Level Security

Not applicable.

8. Annexes of applications.

8.1. IQon CT Acquisition application

8.1.1. IOD contents (For conventional images).

8.1.1.1. Created SOP Instances

General rules

This section specifies each IOD related to conventional images created by the CT scanner application or conventional images created by the viewing applications running on the IQon system or conventional images created by the Spectral CT viewer application running on the IQon system. IOD's related to the spectral images are discussed at section 8.1.2.

The viewing applications running on IQon (CT Viewer, Cardiac CT viewer,...) can create additional DICOM images that are based on the loaded CT images in these viewers. Most of the attributes or even the whole modules (Patient, General Study, etc.) are just copied from the source CT images.

DICOM Overlays are only created for saved Secondary Capture SOP Class images. When images with ROI, Annotations, etc. (group 50xx) are saved as DICOM Secondary Captures, the 50xx groups attributes are converted into DICOM Overlays attributes (group 60xx). In case SCP does not support group 60xx attributes - the IQon CT has a configurable option (in LAN Config) to burn the overlays into the pixel data thus allowing any PACS to display them.

For images created by the viewing applications running on IQon, the attribute "Burned In Annotation", has the value "YES" in case the option "save display" is used in the save image window. The attribute "Burned In Annotation" has the value "NO" for derived objects, if saved with "hide titles" (for images that are saved as secondary capture SOP Class object).

For Value Representation (VR) equal to Patient's Name (PN), the leading spaces into the Patient's Name will be treated as insignificant for matching purposes.

From the Patient's Name only the first 32 characters are displayed into the Quick View Viewer.

A Time attribute contains a string of characters of the format "hhmmss.frac". The Fractional part is always 3 decimal places.

Derived CT Image Attributes

Image Plane module attributes:

- All derived CT images, except curved (panoramic) slab, contain the Image Position (0020,0032) and Image Orientation (0020,0037) attributes.
- All derived CT (including curve slab) images contain the Pixel Spacing (0028,0030) and Slice Thickness (0018,0050) attributes.
- Non-Square pixels are not supported by "IQon CT viewers".

Export Converters

A number of configurable export convertors allow the system to modify certain IOD when sent to specific SCP.

Color-to-Monochrome Converter

The Color (24-bits) SC IOD is converted to a monochrome 8-bit or 12 bit SC IOD, configurable by FSE. A new UID is generated for the converted image.

Burn Overlays Converter

The overlays on the images are burned into the Pixel data for the image and the DICOM overlay groups (50xx and 60xx) are removed from the IOD. This convertor works only on Secondary Capture IOD's.

Convert Philips Tags to CCA Cardiac Tags

Private Philips DICOM attributes are converted to allow the IOD to be processed by non-Philips systems.

Copied modules to the derived IOD's

The following table lists the modules that are always copied from the source images when the created SOP Class IOD is the same as the source SOP Class IOD.

Table 88: Modules copied to the derived IOD's table

Information Entity	Module Name
Patient	Patient Module
	Clinical Trial Subject Module
Study	General Study Module
	Patient Study Module
	Clinical Trial Study Modules
Series	General Series Modules
	Clinical Trial Series Module
Frame of Reference	Frame of Reference Module
Equipment	General Equipment Module

This section specifies each IOD created (including private IOD's). It should specify the attribute name, tag, VR, and value. The value should specify the range and source (e.g. user input, Modality Worklist, automatically generated, etc.). For content items in templates, the range and source of the concept name and concept values should be specified. Whether the value is always present or not shall be specified.

Abbreviations used in the IOD tables for the column "Presence of Module" are:

ALWAYS The module is always present
 CONDITIONAL The module is used under specified condition

Abbreviations used in the Module table for the column "Presence of Value" are:

ALWAYS The attribute is always present with a value
 EMPTY The attribute is always present without any value (attribute sent zero length)
 VNAP The attribute is always present and its Value is Not Always Present
 (attribute sent zero length if no value is present)
 ANAP The attribute is present under specified condition – if present then it will always have a value
 ANAPCV The attribute is present under specified condition – if present then its Value is Not Always Present
 (attribute sent zero length if condition applies and no value is present)
 ANAPEV The attribute is present under specified condition – if present then it will not have any value

The abbreviations used in the Module table for the column "Source" are:

AUTO The attribute value is generated automatically
 CONFIG The attribute value source is a configurable parameter
 COPY The attribute value source is another SOP instance
 FIXED The attribute value is hard-coded in the application
 IMPLICIT The attribute value source is a user-implicit setting
 MPPS The attribute value is the same as that use for Modality Performed Procedure Step
 MWL The attribute value source is a Modality Worklist
 USER The attribute value source is explicit user input

Items in the Value and Comment columns in the following tables are filled in where appropriate to further clarify the use or meaning of each attribute beyond the definition provided by the DICOM Standard. All others are left blank for ease of use. See PS3.3 of the DICOM Standard for the complete attribute definitions

8.1.1.2. List of created SOP Classes

Table 89: List of created SOP Classes

SOP Class Name	SOP Class UID
CT Image Storage SOP Class	1.2.840.10008.5.1.4.1.1.2
Secondary Capture Image Storage SOP Class	1.2.840.10008.5.1.4.1.1.7
General ECG Waveform Storage SOP Class	1.2.840.10008.5.1.4.1.1.9.1.2
X-Ray Radiation Dose SR	1.2.840.10008.5.1.4.1.1.88.67

8.1.1.2.1. CT Image Storage SOP Class

Table 90: IOD of Created CT Image Storage SOP Class Instances

Information Entity	Module	Presence Of Module
Patient	Patient Module	ALWAYS
Study	General Study Module	ALWAYS
Study	Patient Study Module	ALWAYS
Series	General Series Module	ALWAYS
Frame of Reference	Frame of Reference Module	ALWAYS
Equipment	General Equipment Module	ALWAYS
Image	General Image Module	ALWAYS
Image	Image Plane Module	ALWAYS
Image	Image Pixel Module	ALWAYS
Image	Contrast/Bolus Module	CONDITIONAL
Image	CT Image Module	ALWAYS
Image	Overlay Plane Module	CONDITIONAL
Image	VOI LUT Module	CONDITIONAL
Image	SOP Common Module	ALWAYS
	Extended Dicom and Private attributes	CONDITIONAL

Table 91: Patient Module

Attribute Name	Tag	VR	Value	Presence of Value	Source	Comment
Referenced Patient Sequence	0008,1120	SQ		ANAP	MWL	
>Referenced SOP Class UID	0008,1150	UI		ALWAYS	MWL	
>Referenced SOP Instance UID	0008,1155	UI		ALWAYS	MWL	
Patient's Name	0010,0010	PN		VNAP	MWL, USER	
Patient ID	0010,0020	LO		VNAP	MWL, USER	
Patient's Birth Date	0010,0030	DA		VNAP	MWL, USER	
Patient's Sex	0010,0040	CS		VNAP	MWL, USER	
Other Patient IDs	0010,1000	LO		ANAPCV	MWL, USER	
Ethnic Group	0010,2160	SH		ANAPCV	MWL	
Patient Comments	0010,4000	LT		ANAPCV	MWL	

Table 92: General Study Module

Attribute Name	Tag	VR	Value	Presence of Value	Source	Comment
Study Date	0008,0020	DA		VNAP	AUTO	
Study Time	0008,0030	TM		VNAP	AUTO	
Accession Number	0008,0050	SH		VNAP	MWL, USER	
Referring Physician's Name	0008,0090	PN		VNAP	MWL, USER	
Study Description	0008,1030	LO		ANAPCV	AUTO	
Referenced Study Sequence	0008,1110	SQ		ANAPCV	MWL	
>Referenced SOP Class UID	0008,1150	UI		ALWAYS	MWL	
>Referenced SOP Instance UID	0008,1155	UI		ALWAYS	MWL	
Study Instance UID	0020,000D	UI		ALWAYS	AUTO	
Study ID	0020,0010	SH		VNAP	AUTO	

Table 93: Patient Study Module

Attribute Name	Tag	VR	Value	Presence of Value	Source	Comment
Admitting Diagnoses Description	0008,1080	LO		ANAPCV	MWL	
Patient's Age	0010,1010	AS		ANAPCV	AUTO	
Patient's Size	0010,1020	DS		ANAPCV	MWL, USER	
Patient's Weight	0010,1030	DS		ANAPCV	MWL, USER	
Additional Patient History	0010,21B0	LT		ANAPCV	MWL	

Table 94: General Series Module

Attribute Name	Tag	VR	Value	Presence of Value	Source	Comment
Series Date	0008,0021	DA		ANAPCV	AUTO	
Series Time	0008,0031	TM		ANAPCV	AUTO	
Modality	0008,0060	CS	CT	ALWAYS	AUTO	
Series Description	0008,103E	LO		ANAPCV	AUTO	
Operators' Name	0008,1070	PN		ANAPCV	AUTO	
Referenced Performed Procedure Step Sequence	0008,1111	SQ		ANAPCV	AUTO	
>Referenced SOP Class UID	0008,1150	UI		ALWAYS	AUTO	
>Referenced SOP Instance UID	0008,1155	UI		ALWAYS	AUTO	
Body Part Examined	0018,0015	CS		ANAPCV	AUTO	
Protocol Name	0018,1030	LO		ANAPCV	AUTO	
Patient Position	0018,5100	CS		ANAPCV	AUTO	
Series Instance UID	0020,000E	UI		ALWAYS	AUTO	
Series Number	0020,0011	IS		VNAP	AUTO	
Request Attributes Sequence	0040,0275	SQ		ANAPCV	AUTO	

>Requested Procedure Code Sequence	0032,1064	SQ		ANAP	AUTO	
>>Code Value	0008,0100	SH		ALWAYS	AUTO	
>>Coding Scheme Designator	0008,0102	SH		ALWAYS	AUTO	
>>Code Meaning	0008,0104	LO		ALWAYS	AUTO	
>Scheduled Procedure Step Description	0040,0007	LO		ANAPCV	AUTO	
>Scheduled Procedure Step ID	0040,0009	SH		ANAP	AUTO	
>Requested Procedure ID	0040,1001	SH		ANAP	AUTO	
Performed Procedure Step Start Date	0040,0244	DA		ANAPCV	AUTO	
Performed Procedure Step Start Time	0040,0245	TM		ANAPCV	AUTO	
Performed Procedure Step ID	0040,0253	SH		ANAPCV	AUTO	
Performed Procedure Step Description	0040,0254	LO		ANAPCV	AUTO	
Performed Protocol Code Sequence	0040,0260	SQ		ANAPCV	AUTO	
>Code Value	0008,0100	SH		ALWAYS	AUTO	
>Coding Scheme Designator	0008,0102	SH		ALWAYS	AUTO	
>Code Meaning	0008,0104	LO		ALWAYS	AUTO	

Table 95: Frame of Reference Module

Attribute Name	Tag	VR	Value	Presence of Value	Source	Comment
Frame of Reference UID	0020,0052	UI		ALWAYS	AUTO	
Position Reference Indicator	0020,1040	LO		VNAP	AUTO	

Table 96: General Equipment Module

Attribute Name	Tag	VR	Value	Presence of Value	Source	Comment
Manufacturer	0008,0070	LO	Philips	VNAP	CONFIG	
Institution Name	0008,0080	LO		ANAPCV	CONFIG, USER	
Institution Address	0008,0081	ST		ANAPCV	CONFIG, USER	
Station Name	0008,1010	SH		ANAPCV	CONFIG	
Institutional Department Name	0008,1040	LO		ANAPCV	CONFIG	
Manufacturer's Model Name	0008,1090	LO		ANAPCV	AUTO	
Device Serial Number	0018,1000	LO		ANAPCV	AUTO, CONFIG	
Software Version(s)	0018,1020	LO		ANAPCV	AUTO	

Table 97: General Image Module

Attribute Name	Tag	VR	Value	Presence of Value	Source	Comment
Acquisition Date	0008,0022	DA		ANAPCV	AUTO	
Content Date	0008,0023	DA		ANAPCV	AUTO	
Acquisition Time	0008,0032	TM		ANAPCV	AUTO	

Content Time	0008,0033	TM		ANAPCV	AUTO	
Referenced Image Sequence	0008,1140	SQ		ANAPCV	AUTO	
>Referenced SOP Class UID	0008,1150	UI		ALWAYS	AUTO	
>Referenced SOP Instance UID	0008,1155	UI		ALWAYS	AUTO	
Instance Number	0020,0013	IS		VNAP	AUTO	
Quality Control Image	0028,0300	CS		ANAPCV	AUTO	

Table 98: Image Plane Module

Attribute Name	Tag	VR	Value	Presence of Value	Source	Comment
Slice Thickness	0018,0050	DS		VNAP	AUTO	
Image Position (Patient)	0020,0032	DS		ALWAYS	AUTO	
Image Orientation (Patient)	0020,0037	DS		ALWAYS	AUTO	
Slice Location	0020,1041	DS		ANAPCV	AUTO	
Pixel Spacing	0028,0030	DS		ALWAYS	AUTO	

Table 99: Image Pixel Module

Attribute Name	Tag	VR	Value	Presence of Value	Source	Comment
Rows	0028,0010	US		ALWAYS	AUTO	
Columns	0028,0011	US		ALWAYS	AUTO	
Pixel Representation	0028,0103	US	0	ALWAYS	FIXED	
Pixel Data	7FE0,0010	OW/OB		ANAP	AUTO	

Table 100: Contrast/Bolus Module

Attribute Name	Tag	VR	Value	Presence of Value	Source	Comment
Contrast/Bolus Agent	0018,0010	LO		VNAP	AUTO	
Contrast/Bolus Route	0018,1040	LO		ANAPCV	AUTO	
Contrast/Bolus Start Time	0018,1042	TM		ANAPCV	AUTO	

Table 101: CT Image Module

Attribute Name	Tag	VR	Value	Presence of Value	Source	Comment
Image Type	0008,0008	CS		ALWAYS	AUTO	
Scan Options	0018,0022	CS		ANAPCV	AUTO	
KVP	0018,0060	DS		VNAP	AUTO	
Data Collection Diameter	0018,0090	DS		ANAPCV	AUTO	
Reconstruction Diameter	0018,1100	DS		ANAPCV	AUTO	
Distance Source to Detector	0018,1110	DS		ANAPCV	AUTO	
Distance Source to Patient	0018,1111	DS		ANAPCV	AUTO	
Gantry/Detector Tilt	0018,1120	DS		ANAPCV	AUTO	
Table Height	0018,1130	DS		ANAPCV	AUTO	
Exposure Time	0018,1150	IS		ANAPCV	AUTO	
X-ray Tube Current	0018,1151	IS		ANAPCV	AUTO	
Exposure	0018,1152	IS		ANAPCV	AUTO	
Convolution Kernel	0018,1210	SH		ANAPCV	AUTO	
Revolution Time	0018,9305	FD		ANAPCV	AUTO	
Single Collimation Width	0018,9306	FD		ANAPCV	AUTO	

Total Collimation Width	0018,9307	FD		ANAPCV	AUTO	
Table Speed	0018,9309	FD		ANAPCV	AUTO	
Table Feed per Rotation	0018,9310	FD		ANAPCV	AUTO	
Spiral Pitch Factor	0018,9311	FD		ANAPCV	AUTO	
Exposure Modulation Type	0018,9323	CS		ANAPCV	AUTO	
Estimated Dose Saving	0018,9324	FD		ANAPCV	AUTO	
CTDIvol	0018,9345	FD		ANAPCV	AUTO	
CT Additional X-Ray Source Sequence	0018,9360	SQ		ANAPCV	AUTO	
>X-Ray Tube Current in mA	0018,9330	FD		ALWAYS	AUTO	
Acquisition Number	0020,0012	IS		VNAP	AUTO	
Samples per Pixel	0028,0002	US		ALWAYS	AUTO	
Photometric Interpretation	0028,0004	CS		ALWAYS	AUTO	
Bits Allocated	0028,0100	US		ALWAYS	AUTO	
Bits Stored	0028,0101	US		ALWAYS	AUTO	
High Bit	0028,0102	US		ALWAYS	AUTO	
Rescale Intercept	0028,1052	DS	-1024	ALWAYS	FIXED	
Rescale Slope	0028,1053	DS	1	ALWAYS	FIXED	
Rescale Type	0028,1054	LO	HU	ALWAYS	FIXED	

Table 102: Overlay Plane Module

Attribute Name	Tag	VR	Value	Presence of Value	Source	Comment
Overlay Rows	6000,0010	US		ALWAYS	AUTO	
Overlay Columns	6000,0011	US		ALWAYS	AUTO	
Overlay Type	6000,0040	CS		ALWAYS	AUTO	
Overlay Origin	6000,0050	SS		ALWAYS	AUTO	
Overlay Bits Allocated	6000,0100	US		ALWAYS	AUTO	
Overlay Bit Position	6000,0102	US		ALWAYS	AUTO	
Overlay Data	6000,3000	OW/OB		ALWAYS	AUTO	

Table 103: VOI LUT Module

Attribute Name	Tag	VR	Value	Presence of Value	Source	Comment
Window Center	0028,1050	DS		ANAP	AUTO	
Window Width	0028,1051	DS		ANAP	AUTO	

Table 104: SOP Common Module

Attribute Name	Tag	VR	Value	Presence of Value	Source	Comment
Specific Character Set	0008,0005	CS		ANAP	AUTO	
Instance Creation Date	0008,0012	DA		ANAPCV	AUTO	
Instance Creation Time	0008,0013	TM		ANAPCV	AUTO	
SOP Class UID	0008,0016	UI		ALWAYS	AUTO	
SOP Instance UID	0008,0018	UI		ALWAYS	AUTO	
Contributing Equipment Sequence	0018,A001	SQ		ANAPCV	AUTO	
>Manufacturer	0008,0070	LO		ALWAYS	AUTO	
>Institution Name	0008,0080	LO		ANAPCV	AUTO	
>Institution Address	0008,0081	ST		ANAPCV	AUTO	
>Station Name	0008,1010	SH		ANAPCV	AUTO	

>Institutional Department Name	0008,1040	LO		ANAPCV	AUTO	
>Manufacturer's Model Name	0008,1090	LO		ANAPCV	AUTO	
>Device Serial Number	0018,1000	LO		ANAPCV	AUTO	
>Software Version(s)	0018,1020	LO		ANAPCV	AUTO	
>Purpose of Reference Code Sequence	0040,A170	SQ		ALWAYS	AUTO	
>>Code Value	0008,0100	SH		ALWAYS	AUTO	
>>Coding Scheme Designator	0008,0102	SH		ALWAYS	AUTO	
>>Code Meaning	0008,0104	LO		ALWAYS	AUTO	

8.1.1.2.2. Secondary Capture Image Storage SOP Class

Table 105: IOD of Created Secondary Capture Image Storage SOP Class Instances

Information Entity	Module	Presence Of Module
Patient	Patient Module	ALWAYS
Study	General Study Module	ALWAYS
Study	Patient Study Module	ALWAYS
Series	General Series Module	ALWAYS
Equipment	General Equipment Module	ALWAYS
Equipment	SC Equipment Module	ALWAYS
Image	General Image Module	ALWAYS
Image	Image Pixel Module	ALWAYS
Image	SC Image Module	ALWAYS
Image	Overlay Plane Module	CONDITIONAL
Image	VOI LUT Module	CONDITIONAL
Image	SOP Common Module	ALWAYS
	Extended Dicom and Private attributes	CONDITIONAL

Table 106: Patient Module

Attribute Name	Tag	VR	Value	Presence of Value	Source	Comment
Referenced Patient Sequence	0008,1120	SQ		ANAP	COPY	
>Referenced SOP Class UID	0008,1150	UI		ALWAYS	COPY	
>Referenced SOP Instance UID	0008,1155	UI		ALWAYS	COPY	
Patient's Name	0010,0010	PN		VNAP	COPY	
Patient ID	0010,0020	LO		VNAP	COPY	
Patient's Birth Date	0010,0030	DA		VNAP	COPY	
Patient's Sex	0010,0040	CS		VNAP	COPY	
Other Patient IDs	0010,1000	LO		ANAPCV	COPY	
Ethnic Group	0010,2160	SH		ANAPCV	COPY	
Patient Comments	0010,4000	LT		ANAPCV	COPY	

Table 107: General Study Module

Attribute Name	Tag	VR	Value	Presence of Value	Source	Comment
Study Date	0008,0020	DA		VNAP	COPY	
Study Time	0008,0030	TM		VNAP	COPY	

Accession Number	0008,0050	SH		VNAP	COPY	
Referring Physician's Name	0008,0090	PN		VNAP	COPY	
Study Description	0008,1030	LO		ANAPCV	COPY	
Referenced Study Sequence	0008,1110	SQ		ANAPCV	COPY	
>Referenced SOP Class UID	0008,1150	UI		ALWAYS	COPY	
>Referenced SOP Instance UID	0008,1155	UI		ALWAYS	COPY	
Study Instance UID	0020,000D	UI		ALWAYS	COPY	
Study ID	0020,0010	SH		VNAP	COPY	

Table 108: Patient Study Module

Attribute Name	Tag	VR	Value	Presence of Value	Source	Comment
Admitting Diagnoses Description	0008,1080	LO		ANAPCV	COPY	
Patient's Age	0010,1010	AS		ANAPCV	COPY	
Patient's Size	0010,1020	DS		ANAPCV	COPY	
Patient's Weight	0010,1030	DS		ANAPCV	COPY	
Additional Patient History	0010,21B0	LT		ANAPCV	COPY	

Table 109: General Series Module

Attribute Name	Tag	VR	Value	Presence of Value	Source	Comment
Series Date	0008,0021	DA		ANAPCV	AUTO	
Series Time	0008,0031	TM		ANAPCV	AUTO	
Series Description	0008,103E	LO		ANAPCV	AUTO	
Operators' Name	0008,1070	PN		ANAPCV	AUTO	
Referenced Performed Procedure Step Sequence	0008,1111	SQ		ANAPCV	AUTO	
>Referenced SOP Class UID	0008,1150	UI		ALWAYS	AUTO	
>Referenced SOP Instance UID	0008,1155	UI		ALWAYS	AUTO	
Body Part Examined	0018,0015	CS		ANAPCV	AUTO	
Protocol Name	0018,1030	LO		ANAPCV	AUTO	
Patient Position	0018,5100	CS		ANAPCV	AUTO	
Series Instance UID	0020,000E	UI		ALWAYS	AUTO	
Series Number	0020,0011	IS		VNAP	AUTO	
Performed Procedure Step Start Date	0040,0244	DA		ANAPCV	AUTO	
Performed Procedure Step Start Time	0040,0245	TM		ANAPCV	AUTO	
Performed Procedure Step ID	0040,0253	SH		ANAPCV	AUTO	
Performed Procedure Step Description	0040,0254	LO		ANAPCV	AUTO	
Performed Protocol Code Sequence	0040,0260	SQ		ANAPCV	AUTO	
>Code Value	0008,0100	SH		ALWAYS	AUTO	
>Coding Scheme Designator	0008,0102	SH		ALWAYS	AUTO	
>Code Meaning	0008,0104	LO		ALWAYS	AUTO	

Table 110: General Equipment Module

Attribute Name	Tag	VR	Value	Presence of Value	Source	Comment
Manufacturer	0008,0070	LO		VNAP	COPY	
Institution Name	0008,0080	LO		ANAPCV	COPY	
Institution Address	0008,0081	ST		ANAPCV	COPY	
Station Name	0008,1010	SH		ANAPCV	COPY	
Institutional Department Name	0008,1040	LO		ANAPCV	COPY	
Manufacturer's Model Name	0008,1090	LO		ANAPCV	COPY	
Device Serial Number	0018,1000	LO		ANAPCV	COPY	
Software Version(s)	0018,1020	LO		ANAPCV	COPY	

Table 111: SC Equipment Module

Attribute Name	Tag	VR	Value	Presence of Value	Source	Comment
Modality	0008,0060	CS	CT	ANAPCV	FIXED	
Conversion Type	0008,0064	CS	WSD	ALWAYS	AUTO	
Secondary Capture Device Manufacturer	0018,1016	LO		ANAPCV	COPY	
Secondary Capture Device Manufacturer's Model Name	0018,1018	LO		ANAPCV	COPY	
Secondary Capture Device Software Version(s)	0018,1019	LO		ANAPCV	COPY	

Table 112: General Image Module

Attribute Name	Tag	VR	Value	Presence of Value	Source	Comment
Image Type	0008,0008	CS	Value 1: DERIVED, Value 2: SECONDARY	ANAPCV	AUTO	
Acquisition Date	0008,0022	DA		ANAPCV	AUTO	
Acquisition Time	0008,0032	TM		ANAPCV	AUTO	
Acquisition Number	0020,0012	IS		ANAPCV	AUTO	
Instance Number	0020,0013	IS		VNAP	AUTO	
Patient Orientation	0020,0020	CS		ANAPCV	AUTO	
Image Comments	0020,4000	LT		ANAPCV	AUTO	
Quality Control Image	0028,0300	CS		ANAPCV	AUTO	
Burned In Annotation	0028,0301	CS		ANAPCV	AUTO	For Patient Info "YES" for Other "No"

Table 113: Image Pixel Module

Attribute Name	Tag	VR	Value	Presence of Value	Source	Comment
Samples per Pixel	0028,0002	US	1, 3	ALWAYS	AUTO	
Photometric Interpretation	0028,0004	CS	MONOCHROME2, RGB	ALWAYS	AUTO	
Planar Configuration	0028,0006	US	1	ANAP	FIXED	
Rows	0028,0010	US	512	ALWAYS	AUTO	512 or more
Columns	0028,0011	US	512	ALWAYS	AUTO	
Bits Allocated	0028,0100	US	16, 8	ALWAYS	AUTO	
Bits Stored	0028,0101	US	12, 8	ALWAYS	AUTO	
High Bit	0028,0102	US	11, 7	ALWAYS	AUTO	
Pixel Representation	0028,0103	US	0	ALWAYS	FIXED	

Pixel Data	7FE0,0010	OW/OB		ANAP	AUTO	
------------	-----------	-------	--	------	------	--

Table 114: SC Image Module

Attribute Name	Tag	VR	Value	Presence of Value	Source	Comment
Date of Secondary Capture	0018,1012	DA		ANAPCV	AUTO	
Time of Secondary Capture	0018,1014	TM		ANAPCV	AUTO	

Table 115: Overlay Plane Module

Attribute Name	Tag	VR	Value	Presence of Value	Source	Comment
Overlay Rows	6000,0010	US		ALWAYS	AUTO	
Overlay Columns	6000,0011	US		ALWAYS	AUTO	
Overlay Type	6000,0040	CS		ALWAYS	AUTO	
Overlay Origin	6000,0050	SS		ALWAYS	AUTO	
Overlay Bits Allocated	6000,0100	US		ALWAYS	AUTO	
Overlay Bit Position	6000,0102	US		ALWAYS	AUTO	
Overlay Data	6000,3000	OW/OB		ALWAYS	AUTO	

Table 116: VOI LUT Module

Attribute Name	Tag	VR	Value	Presence of Value	Source	Comment
Window Center	0028,1050	DS		ANAP	AUTO	
Window Width	0028,1051	DS		ANAP	AUTO	

Table 117: SOP Common Module

Attribute Name	Tag	VR	Value	Presence of Value	Source	Comment
Specific Character Set	0008,0005	CS		ANAP	COPY	
Instance Creation Date	0008,0012	DA		ANAPCV	AUTO	
Instance Creation Time	0008,0013	TM		ANAPCV	AUTO	
SOP Class UID	0008,0016	UI	1.2.840.10008.5.1.4.1.1.7	ALWAYS	FIXED	
SOP Instance UID	0008,0018	UI		ALWAYS	AUTO	
Contributing Equipment Sequence	0018,A001	SQ		ANAPCV	AUTO	
>Manufacturer	0008,0070	LO		ALWAYS	AUTO	
>Institution Name	0008,0080	LO		ANAPCV	AUTO	
>Institution Address	0008,0081	ST		ANAPCV	AUTO	
>Station Name	0008,1010	SH		ANAPCV	AUTO	
>Institutional Department Name	0008,1040	LO		ANAPCV	AUTO	
>Manufacturer's Model Name	0008,1090	LO		ANAPCV	AUTO	
>Device Serial Number	0018,1000	LO		ANAPCV	AUTO	
>Software Version(s)	0018,1020	LO		ANAPCV	AUTO	
>Purpose of Reference Code Sequence	0040,A170	SQ		ALWAYS	AUTO	
>>Code Value	0008,0100	SH		ALWAYS	AUTO	
>>Coding Scheme Designator	0008,0102	SH		ALWAYS	AUTO	
>>Code Meaning	0008,0104	LO		ALWAYS	AUTO	

8.1.1.2.3. General ECG Waveform Storage SOP Class

Table 118: IOD of Created General ECG Waveform Storage SOP Class Instances

Information Entity	Module	Presence Of Module
Patient	Patient Module	CONDITIONAL
Study	General Study Module	CONDITIONAL
Study	Patient Study Module	CONDITIONAL
Series	General Series Module	CONDITIONAL
Equipment	General Equipment Module	CONDITIONAL
Waveform	Waveform Identification Module	CONDITIONAL
Waveform	Waveform Module	CONDITIONAL
	Extended Dicom and Private attributes	CONDITIONAL

Table 119: Patient Module

Attribute Name	Tag	VR	Value	Presence of Value	Source	Comment
Referenced Patient Sequence	0008,1120	SQ		ANAP	MWL	
>Referenced SOP Class UID	0008,1150	UI		ALWAYS	AUTO	
>Referenced SOP Instance UID	0008,1155	UI		ALWAYS	AUTO	
Patient's Name	0010,0010	PN		VNAP	USER	
Patient ID	0010,0020	LO		VNAP	USER	
Patient's Birth Date	0010,0030	DA		VNAP	USER	
Patient's Sex	0010,0040	CS		VNAP	USER	
Other Patient IDs	0010,1000	LO		ANAPCV	MWL, USER	
Ethnic Group	0010,2160	SH		ANAPCV	MWL	
Patient Comments	0010,4000	LT		ANAPCV	MWL	

Table 120: General Study Module

Attribute Name	Tag	VR	Value	Presence of Value	Source	Comment
Study Date	0008,0020	DA		VNAP	AUTO	
Study Time	0008,0030	TM		VNAP	AUTO	
Accession Number	0008,0050	SH		VNAP	USER	
Referring Physician's Name	0008,0090	PN		VNAP	USER	
Study Description	0008,1030	LO		ANAPCV	USER	
Referenced Study Sequence	0008,1110	SQ		ANAPCV	MWL	
>Referenced SOP Class UID	0008,1150	UI		ALWAYS	AUTO	
>Referenced SOP Instance UID	0008,1155	UI		ALWAYS	AUTO	
Study Instance UID	0020,000D	UI		ALWAYS	AUTO	
Study ID	0020,0010	SH		VNAP	AUTO	

Table 121: Patient Study Module

Attribute Name	Tag	VR	Value	Presence of Value	Source	Comment
Admitting Diagnoses Description	0008,1080	LO		ANAPCV	MWL	
Patient's Age	0010,1010	AS		ANAPCV	AUTO	

Patient's Size	0010,1020	DS		ANAPCV	MWL, USER	
Patient's Weight	0010,1030	DS		ANAPCV	MWL, USER	
Additional Patient History	0010,21B 0	LT		ANAPCV	MWL	

Table 122: General Series Module

Attribute Name	Tag	VR	Value	Presence of Value	Source	Comment
Series Date	0008,0021	DA		ANAPCV	AUTO	
Series Time	0008,0031	TM		ANAPCV	AUTO	
Modality	0008,0060	CS	ECG	ALWAYS	AUTO	
Series Description	0008,103E	LO		ANAPCV	AUTO	
Operators' Name	0008,1070	PN		ANAPCV	USER	
Referenced Performed Procedure Step Sequence	0008,1111	SQ		ANAPCV	AUTO	
>Referenced SOP Class UID	0008,1150	UI		ALWAYS	AUTO	
>Referenced SOP Instance UID	0008,1155	UI		ALWAYS	AUTO	
Body Part Examined	0018,0015	CS		ANAPCV	AUTO	
Protocol Name	0018,1030	LO		ANAPCV	AUTO	
Patient Position	0018,5100	CS		ANAPCV	AUTO	
Series Instance UID	0020,000E	UI		ALWAYS	AUTO	
Series Number	0020,0011	IS		VNAP	AUTO	
Performed Procedure Step Start Date	0040,0244	DA		ANAPCV	AUTO	
Performed Procedure Step Start Time	0040,0245	TM		ANAPCV	AUTO	
Performed Procedure Step ID	0040,0253	SH		ANAPCV	AUTO	
Performed Procedure Step Description	0040,0254	LO		ANAPCV	AUTO	
Performed Protocol Code Sequence	0040,0260	SQ		ANAPCV	AUTO	
>Code Value	0008,0100	SH		ALWAYS	AUTO	
>Coding Scheme Designator	0008,0102	SH		ALWAYS	AUTO	
>Code Meaning	0008,0104	LO		ALWAYS	AUTO	

Table 123: General Equipment Module

Attribute Name	Tag	VR	Value	Presence of Value	Source	Comment
Manufacturer	0008,0070	LO		VNAP	FIXED	
Institution Name	0008,0080	LO		ANAPCV	CONFIG	
Institution Address	0008,0081	ST		ANAPCV	CONFIG	
Station Name	0008,1010	SH		ANAPCV	CONFIG	
Institutional Department Name	0008,1040	LO		ANAPCV	CONFIG	
Manufacturer's Model Name	0008,1090	LO		ANAPCV	CONFIG	
Device Serial Number	0018,1000	LO		ANAPCV	CONFIG	
Software Version(s)	0018,1020	LO		ANAPCV	CONFIG	

Table 124: Waveform Identification Module

Attribute Name	Tag	VR	Value	Presence of Value	Source	Comment
Content Date	0008,0023	DA		ALWAYS	AUTO	
Acquisition Date time	0008,002A	DT		ALWAYS	AUTO	
Content Time	0008,0033	TM		ALWAYS	AUTO	
Instance Number	0020,0013	IS		ALWAYS	AUTO	

Table 125: Waveform Module

Attribute Name	Tag	VR	Value	Presence of Value	Source	Comment
Waveform Sequence	5400,0100	SQ		ALWAYS	AUTO	
>Multiplex Group Time Offset	0018,1068	DS		ANAP	AUTO	
>Waveform Originality	003A,0004	CS		ALWAYS	AUTO	
>Number of Waveform Channels	003A,0005	US		ALWAYS	AUTO	
>Number of Waveform Samples	003A,0010	UL		ALWAYS	AUTO	
>Sampling Frequency	003A,001A	DS		ALWAYS	AUTO	
>Channel Definition Sequence	003A,0200	SQ		ALWAYS	AUTO	
>>Channel Source Sequence	003A,0208	SQ		ALWAYS	AUTO	
>>>Code Value	0008,0100	SH		ALWAYS	AUTO	
>>>Coding Scheme Designator	0008,0102	SH		ALWAYS	AUTO	
>>>Code Meaning	0008,0104	LO		ALWAYS	AUTO	
>>Channel Sample Skew	003A,0215	DS		ANAP	AUTO	
>>Waveform Bits Stored	003A,021A	US		ALWAYS	AUTO	
>Waveform Bits Allocated	5400,1004	US		ALWAYS	AUTO	
>Waveform Sample Interpretation	5400,1006	CS		ALWAYS	AUTO	
>Waveform Data	5400,1010	OW/OB		ALWAYS	AUTO	

8.1.1.2.4. X-Ray Radiation Dose SR

Table 126: IOD of Created X-Ray Radiation Dose SR Instances

Information Entity	Module	Presence Of Module
Patient	Patient Module	ALWAYS
Study	General Study Module	ALWAYS
Study	Patient Study Module	ALWAYS
Series	SR Document Series Module	ALWAYS
Equipment	General Equipment Module	ALWAYS
Equipment	Enhanced General Equipment Module	ALWAYS
Document	SR Document General Module	ALWAYS
Document	SR Document Content Module	ALWAYS
Document	SOP Common Module	ALWAYS

Table 127: Patient Module

Attribute Name	Tag	VR	Value	Presence of Value	Source	Comment
Referenced Patient Sequence	0008,1120	SQ		ANAP	COPY	
>Referenced SOP Class UID	0008,1150	UI		ALWAYS	COPY	
>Referenced SOP Instance UID	0008,1155	UI		ALWAYS	COPY	
Patient's Name	0010,0010	PN		VNAP	COPY	
Patient ID	0010,0020	LO		VNAP	COPY	
Patient's Birth Date	0010,0030	DA		VNAP	COPY	
Patient's Sex	0010,0040	CS		VNAP	COPY	
Other Patient IDs	0010,1000	LO		ANAPCV	COPY	
Ethnic Group	0010,2160	SH		ANAPCV	COPY	
Patient Comments	0010,4000	LT		ANAPCV	COPY	

Table 128: General Study Module

Attribute Name	Tag	VR	Value	Presence of Value	Source	Comment
Study Date	0008,0020	DA		VNAP	COPY	
Study Time	0008,0030	TM		VNAP	COPY	
Accession Number	0008,0050	SH		VNAP	COPY	
Referring Physician's Name	0008,0090	PN		VNAP	COPY	
Study Description	0008,1030	LO		ANAPCV	COPY	
Study Instance UID	0020,000D	UI		ALWAYS	COPY	
Study ID	0020,0010	SH		VNAP	COPY	

Table 129: Patient Study Module

Attribute Name	Tag	VR	Value	Presence of Value	Source	Comment
Admitting Diagnoses Description	0008,1080	LO		ANAPCV	COPY	
Admitting Diagnoses Code Sequence	0008,1084	SQ		ANAPCV		
>Code Value	0008,0100	SH		ALWAYS		
>Coding Scheme Designator	0008,0102	SH		ALWAYS		
>Coding Scheme Version	0008,0103	SH		ANAP		
>Code Meaning	0008,0104	LO		ALWAYS		
Patient's Age	0010,1010	AS		ANAPCV	COPY	
Patient's Size	0010,1020	DS		ANAPCV	COPY	
Patient's Weight	0010,1030	DS		ANAPCV	COPY	
Additional Patient History	0010,21B0	LT		ANAPCV	COPY	

Table 130: SR Document Series Module

Attribute Name	Tag	VR	Value	Presence of Value	Source	Comment
Series Date	0008,0021	DA		ANAPCV	COPY	
Series Time	0008,0031	TM		ANAPCV	COPY	
Modality	0008,0060	CS	SR	ALWAYS	FIXED	
Series Description	0008,103E	LO	Radiation Dose Information	ANAPCV	FIXED	

Referenced Performed Procedure Step Sequence	0008,1111	SQ		VNAP	AUTO	
>Referenced SOP Class UID	0008,1150	UI		ALWAYS	AUTO	
>Referenced SOP Instance UID	0008,1155	UI		ALWAYS	AUTO	
Series Instance UID	0020,000E	UI		ALWAYS	AUTO	
Series Number	0020,0011	IS	5000	ALWAYS	FIXED	

Table 131: General Equipment Module

Attribute Name	Tag	VR	Value	Presence of Value	Source	Comment
Manufacturer	0008,0070	LO		VNAP	COPY	
Institution Name	0008,0080	LO		ANAPCV	COPY	
Institution Address	0008,0081	ST		ANAPCV	COPY	
Station Name	0008,1010	SH		ANAPCV	COPY	
Institutional Department Name	0008,1040	LO		ANAPCV	COPY	
Manufacturer's Model Name	0008,1090	LO		ANAPCV	COPY	
Device Serial Number	0018,1000	LO		ANAPCV	COPY	
Software Version(s)	0018,1020	LO		ANAPCV	COPY	

Table 132: Enhanced General Equipment Module

Attribute Name	Tag	VR	Value	Presence of Value	Source	Comment
Manufacturer	0008,0070	LO		ALWAYS	AUTO	
Manufacturer's Model Name	0008,1090	LO		ALWAYS	AUTO	
Device Serial Number	0018,1000	LO		ALWAYS	AUTO	
Software Version(s)	0018,1020	LO		ALWAYS	AUTO	

Table 133: SR Document General Module

Attribute Name	Tag	VR	Value	Presence of Value	Source	Comment
Content Date	0008,0023	DA		ALWAYS	AUTO	
Content Time	0008,0033	TM		ALWAYS	AUTO	
Instance Number	0020,0013	IS	1	ALWAYS	FIXED	
Performed Procedure Code Sequence	0040,A372	SQ		VNAP	AUTO	
>Code Value	0008,0100	SH		ANAP	AUTO	
>Coding Scheme Designator	0008,0102	SH		ANAP	AUTO	
>Code Meaning	0008,0104	LO		ANAP	AUTO	
Completion Flag	0040,A491	CS	COMPLETE	ALWAYS	FIXED	
Verification Flag	0040,A493	CS	UNVERIFIED	ALWAYS	FIXED	

Table 134: SR Document Content Module

Attribute Name	Tag	VR	Value	Presence of Value	Source	Comment
Value Type	0040,A040	CD	CONTAINER	ALWAYS	FIXED	
Concept Name Code Sequence	0040,A043	SQ		ALWAYS	AUTO	
>Code Value	0008,0100	SH		EMPTY	AUTO	
>Coding Scheme Designator	0008,0102	SH		EMPTY	AUTO	
>Code Meaning	0008,0104	LO		EMPTY	AUTO	

Continuity Of Content	0040,A050	CS		ALWAYS	AUTO	
Content Template Sequence	0040,A504	SQ		ALWAYS	FIXED	
>Mapping Resource	0008,0105	CS	DCMR	ALWAYS	FIXED	
>Template Identifier	0040,DB00	CS	TID 10011	ALWAYS	FIXED	
Content Sequence	0040,A730	SQ		ANAP	AUTO	
Content Template Sequence	0040,A504	SQ		ALWAYS	FIXED	

Table 135: SOP Common Module

Attribute Name	Tag	VR	Value	Presence of Value	Source	Comment
Specific Character Set	0008,0005	CS		ANAP	COPY	
Instance Creation Date	0008,0012	DA		ANAPCV	COPY	
Instance Creation Time	0008,0013	TM		ANAPCV	COPY	
SOP Class UID	0008,0016	UI	1.2.840.10008.5.1.4.1.1.88.6 7	ALWAYS	FIXED	
SOP Instance UID	0008,0018	UI		ALWAYS	COPY	

8.1.2. IOD contents (For spectral images)

8.1.2.1. Created SOP Instances

This section specifies each IOD related to spectral images created by the CT scanner application and spectral images created by the Spectral CT viewer application running on the IQon system.

The CT scanner application and the Spectral CT viewer can create the following type of spectral images:

- Monochromatic Images (CT IOD)
- Spectral HU-Modified Images (CT IOD)
- Spectral non-HU Images (CT IOD)
- Spectral Color Images (SC IOD)
- Spectral Base Images (SC IOD)
- Spectral High/Low Images (CT IOD)

This chapter describes the attributes and attribute values that have values related to the SPECTRAL acquisition mode.

All created images are DERIVED images with the following exceptions:

- Mono-E images (both types) in case "Block measurements" is unchecked in preference settings
- Spectral High/Low images

Derived CT Image Attributes

Image Plane module attributes:

- All derived CT images, contain the Image Position (0020,0032) and Image Orientation (0020,0037) attributes.
- All derived CT images contain the Pixel Spacing (0028,0030) and Slice Thickness (0018,0050) attributes.

Copied modules to the derived IOD's

The following table lists the modules that are always copied from the source images when the created SOP Class IOD is the same as the source SOP Class IOD.

Table 136: Modules copied to the derived IOD's table

Information Entity	Module Name
Patient	Patient Module
	Clinical Trial Subject Module
Study	General Study Module
	Patient Study Module
	Clinical Trial Study Modules
Series	General Series Modules
	Clinical Trial Series Module
Frame of Reference	Frame of Reference Module
Equipment	General Equipment Module

The copied attributes from the original images are not included in the description of the created Spectral images in the chapter.

Abbreviations used in the Module table for the column "Presence of Value" are:

ALWAYS	The attribute is always present with a value
EMPTY	The attribute is always present without any value (attribute sent zero length)
VNAP	The attribute is always present and its Value is Not Always Present (attribute sent zero length if no value is present)

ANAP	The attribute is present under specified condition – if present then it will always have a value
ANAPCV	The attribute is present under specified condition – if present then its Value is Not Always Present (attribute sent zero length if condition applies and no value is present)
ANAPEV	The attribute is present under specified condition – if present then it will not have any value

The abbreviations used in the Module table for the column "Source" are:

AUTO	The attribute value is generated automatically
CONFIG	The attribute value source is a configurable parameter
COPY	The attribute value source is another SOP instance
FIXED	The attribute value is hard-coded in the application
IMPLICIT	The attribute value source is a user-implicit setting
MPPS	The attribute value is the same as that use for Modality Performed Procedure Step
MWL	The attribute value source is a Modality Worklist
USER	The attribute value source is explicit user input

Items in the Value and Comment columns in the following tables are filled in where appropriate to further clarify the use or meaning of each attribute beyond the definition provided by the DICOM Standard. All others are left blank for ease of use. See PS3.3 of the DICOM Standard for the complete attribute definitions

8.1.2.2. List of created SOP Classes

Table 137: List of created SOP Classes

SOP Class Name	SOP Class UID
CT Image Storage SOP Class	1.2.840.10008.5.1.4.1.1.2
Secondary Capture Image Storage SOP Class	1.2.840.10008.5.1.4.1.1.7

8.1.2.2.1. Monochromatic Image (MONO-E)

Monochromatic images are created as a standard CT IOD image with specific attributes and attribute values as specified in the table below:

Table 138: General Series Module

Attribute Name	Tag	VR	Value	Presence of Value	Source	Comment
Series Date	0008,0021	DA		ALWAYS	AUTO	
Series Time	0008,0031	TM		ALWAYS	AUTO	
Series Description	0008,103E	LO	Image Type Description & <any additional applicable comment> Possible value for Image Type Description" - MonoE<keV value>keV - MonoExxkeV (Equiv. to conventional CT)	ALWAYS	AUTO	Example: MonoE70keV, Spectral (2)
Series Number	0020,0011	IS		ALWAYS	AUTO	
Series Instance UID	0020,000E	UI		ALWAYS	AUTO	

Table 139: General Equipment Module

Attribute Name	Tag	VR	Value	Presence of Value	Source	Comment
Manufacturer's Model Name	0008,1090	LO	IQon - Spectral CT	ALWAYS	AUTO	

Table 140: SC Equipment Module

Attribute Name	Tag	VR	Value	Presence of Value	Source	Comment
Conversion Type	0008,0064	CS	WSD	ALWAYS	AUTO	

Table 141: General Image Module

Attribute Name	Tag	VR	Value	Presence of Value	Source	Comment
Image Type	0008,0008	CS	DERIVED\SECONDARY\AXIALMONO_ENERGY Or ORIGINAL\PRIMARY\AXIALMONO_ENERGY	ALWAYS	AUTO	
Burned In Annotations	0028,0301	CS	NO or YES	ANAP	AUTO	Value depends if patient identification information is burned into the images. If no patient identification information is burned into the images, tag may not appear.
Image Comments	0020,4000	LT	Same as Series Description	ANAP	AUTO	Example: MonoE70keV, Spectral (2)

Table 142: CT Image Module

Attribute Name	Tag	VR	Value	Presence of Value	Source	Comment
Rescale Type	0028,1054	LO	HU	ALWAYS	AUTO	

Table 143: Image Pixel Module

Attribute Name	Tag	VR	Value	Presence of Value	Source	Comment
Rows	0028,0010	US		ALWAYS	AUTO	
Columns	0028,0011	US		ALWAYS	AUTO	

Table 144: VOI LUT Module

Attribute Name	Tag	VR	Value	Presence of Value	Source	Comment
Window Center	0028,1050	DS		ANAP	AUTO	
Window Width	0028,1051	DS		ANAP	AUTO	

Table 145: SOP Common Module

Attribute Name	Tag	VR	Value	Presence of Value	Source	Comment
Instance Creation Date	0008,0012	DA		ALWAYS	AUTO	
Instance Creation Time	0008,0013	TM		ALWAYS	AUTO	
SOP Class UID	0008,0016	UI	1.2.840.10008.5.1.4.1.1.2	ALWAYS	AUTO	
SOP Instance UID	0008,0018	UI		ALWAYS	AUTO	

Table 146: Private attributes for Monochromatic Images

Attribute Name	Tag	VR	Value	Presence of Value	Source	Comment
Private Creator	01E1,0010	LO	ELSCINT1	ALWAYS	AUTO	
Reference Sequence	01E1,1055	SQ		ANAP	AUTO	
>SOP Instance UID	0008,0018	UI		ALWAYS	AUTO	<Instance UID for the corresponding SBI image>
>Study Instance UID	0020,000D	UI		ALWAYS	AUTO	<Study UID for the study which contains the corresponding SBI series>
>Study ID	0020,0010	SH		ANAP	AUTO	<Study ID for the corresponding SBI series>
>Series Number	0020,0011	IS		ANAP	AUTO	<Series number for the corresponding SBI series>
>Series Instance UID	0020,000E	UI		ALWAYS	AUTO	<Series UID for the corresponding SBI series>
>Instance Number	0020,0013	IS		ANAP	AUTO	<Image number for the corresponding SBI image>
>Reference type	01E1,1056	CS	SBI	ALWAYS	AUTO	
>Reference level	01E1,1057	CS	SERIES	ANAP	AUTO	
Private Creator	01F7,0010	LO	ELSCINT1	ALWAYS	AUTO	
>Reference SBI type	01F7,10CE	LT	SBI_CSPN	ANAP	AUTO	
Private Creator	01F1,0010	LO	ELSCINT1	ALWAYS	AUTO	
Elscint_Detectors_Layers	01F1,104F	US	31 32	ALWAYS	AUTO	31 = MonoExxkeV 32 = MonoExxkev (equiv to conventional CT)
keV	01F7,10CB	DS		ALWAYS	AUTO	
Elscint_SBI_version	01F7,10CC	ST	XX.YY: <SBI structure information> //XX – Major version number which represents the structure of the SBI. //YY – Minor version number which represents the parameters content of the SBI.	ANAP	AUTO	
Elscint_SC_CT_equivalent	01F7,10CD	CS	YES	ANAP	AUTO	
ElscintCT_Burned_Spectral_Annotations	01F7,10D3	LT	0 = no annotations are burned into the pixels in the image. 1 = annotations are burned into the pixels in the image.	ANAP	AUTO	Tag shall be present where annotations were added to the object.
Elscint_Idose_level	01F7,109B	IS	0 // No image iDose 1-7 // iDose Level	VNAP	AUTO	
Elscint_Head_Body	01F7,10D4	SH	head or body	ALWAYS	AUTO	According to scan type
Elscint_Spectral_Level	01F7,10D6	IS	0-7 // Spectral Level	ALWAYS	AUTO	

8.1.2.2.2. Spectral HU-Modified Images

Spectral HU-Modified images are created as a standard CT IOD image with specific attributes and attribute values as specified in the table below:

Table 147: General Series Module

Attribute Name	Tag	VR	Value	Presence of Value	Source	Comment
Series Date	0008,0021	DA		ALWAYS	AUTO	
Series Time	0008,0031	TM		ALWAYS	AUTO	
Series Description	0008,103E	LO	- VNC [HU*] - Contrast-Enh. Structures [HU] - Uric Acid [HU] - Uric Acid removed [HU] - Iodine removed [HU]	ANAP	AUTO	Image Type Description & <any additional applicable comment>
Series Number	0020,0011	IS		ALWAYS	AUTO	
Series Instance UID	0020,000E	UI		ALWAYS	AUTO	

Table 148: General Equipment Module

Attribute Name	Tag	VR	Value	Presence of Value	Source	Comment
Manufacturer's Model Name	0008,1090	LO	IQon - Spectral CT	ALWAYS	AUTO	

Table 149: SC Equipment Module

Attribute Name	Tag	VR	Value	Presence of Value	Source	Comment
Conversion Type	0008,0064	CS	WSD	ALWAYS	AUTO	

Table 150: General Image Module

Attribute Name	Tag	VR	Value	Presence of Value	Source	Comment
Image Type	0008,0008	CS	DERIVED\SECONDAR YAXIAL\ MAT_SPRS	ALWAYS	AUTO	
Image Comments	0020,4000	LT	- VNC [HU*] - Contrast-Enh. Structures [HU] - Uric Acid [HU] - Uric Acid removed [HU] - Iodine removed [HU]			Same as series description.
Burned In Annotations	0028,0301		NO or YES	ANAP	AUTO	Value depends if patient identification information is burned into the images. If no patient identification information is burned into the images, tag may not appear.

Table 151: CT Image Module

Attribute Name	Tag	VR	Value	Presence of Value	Source	Comment
Rescale Intercept	0028,1052	DS		ALWAYS	COPY	Same as in original image
Rescale Slope	0028,1053	DS	1	ALWAYS	AUTO	
Rescale Type	0028,1054	LO	HU* //for VNC [HU*] HU // for Contrast-Enh.Structures [HU] & Iodine Removed [HU]	ALWAYS	AUTO	

Table 152: Image Pixel Module

Attribute Name	Tag	VR	Value	Presence of Value	Source	Comment
Rows	0028,0010	US		ALWAYS	AUTO	
Columns	0028,0011	US		ALWAYS	AUTO	

Table 153: VOI LUT Module

Attribute Name	Tag	VR	Value	Presence of Value	Source	Comment
Window Center	0028,1050	DS		ANAP	AUTO	
Window Width	0028,1051	DS		ANAP	AUTO	

Table 154: SOP Common Module

Attribute Name	Tag	VR	Value	Presence of Value	Source	Comment
Instance Creation Date	0008,0012	DA		ALWAYS	AUTO	
Instance Creation Time	0008,0013	TM		ALWAYS	AUTO	
SOP Class UID	0008,0016	UI	1.2.840.10008.5.1.4.1.1.2	ALWAYS	AUTO	
SOP Instance UID	0008,0018	UI		ALWAYS	AUTO	

Table 155: Private attributes for Spectral HU-Modified Images

Attribute Name	Tag	VR	Value	Presence of Value	Source	Comment
Private Creator	01E1,0010	LO	ELSCINT1	ALWAYS	AUTO	
Reference Sequence	01E1,1055	SQ		ANAP	AUTO	
>SOP Instance UID	0008,0018	UI		ALWAYS	AUTO	<Instance UID for the corresponding SBI image>
>Study Instance UID	0020,000D	UI		ALWAYS	AUTO	<Study UID for the study which contains the corresponding SBI series>
>Series Instance UID	0020,000E	UI		ALWAYS	AUTO	<Series UID for the corresponding SBI series>
>Study ID	0020,0010	SH		ANAP	AUTO	<Study ID for the corresponding SBI series>
>Series Number	0020,0011	IS		ANAP	AUTO	<Series number for the corresponding SBI series>

>Instance Number	0020,0013	IS		ANAP	AUTO	<Image number for the corresponding SBI image>
>Reference type	01E1,1056	CS	SBI	ALWAYS	AUTO	
>Reference level	01E1,1057	CS	SERIES	ALWAYS	AUTO	
>Reference SBI type	01F7,0010	LO	ELSCINT1	ALWAYS	AUTO	
>Reference SBI type	01F7,10CE	LT	SBI_CSPN	ANAP	AUTO	
Private Creator	01F1,0010	LO	ELSCINT1	ALWAYS	AUTO	
Elsclint_Detectors_Layers	01F1,104F	US	36 Contrast-Enh. Structures [HU] 37 Iodine removed [HU] 39 VNC [HU*] 40 Uric Acid removed [HU] 41 Uric Acid [HU]	ALWAYS	AUTO	
Elsclint_SBI_version	01F7,10CC	ST	XX.YY: <SBI structure information> //XX – Major version number which represents the structure of the SBI. //YY – Minor version number which represents the parameters content of the SBI.	ANAP	AUTO	
Elsclint_SC_CT_equivalent	01F7,10CD	CS	YES	ANAP	AUTO	
ElsclintCT_Burned_Spectral_Annotations	01F7,10D3	LT	0 or 1	ALWAYS	AUTO	0 = No annotations are burned into the pixel data 1 = Annotations are burned into the pixel data
Elsclint_Idose_level	01F7,109B	IS	0 // No image iDose 1-7 // iDose Level	VNAP	AUTO	
Elsclint_Head_Body	01F7,10D4	SH	head or body	ALWAYS	AUTO	According to scan type
Elsclint_Spectral_Level	01F7,10D6	IS	0-7 // Spectral Level	ALWAYS	AUTO	

8.1.2.2.3. Spectral non-HU Images

Spectral non-HU images are created as a standard CT IOD image with specific attributes and attribute values as specified in the table below:

Table 156: General Series Module

Attribute Name	Tag	VR	Value	Presence of Value	Source	Comment
Series Date	0008,0021	DA		ALWAYS	AUTO	
Series Time	0008,0031	TM		ALWAYS	AUTO	
Series Description	0008,103E	LO	Possible values for Image Type Description: <ul style="list-style-type: none"> - Z Effective - Iodine no Water [mg/ml*] - Iodine Density [mg/ml] 	ANAP	AUTO	Image Type Description & <any additional applicable comment>
Series Number	0020,0011	IS		ALWAYS	AUTO	
Series Instance UID	0020,000E	UI		ALWAYS	AUTO	

Table 157: General Equipment Module

Attribute Name	Tag	VR	Value	Presence of Value	Source	Comment
Manufacturer's Model Name	0008,1090	LO	IQon - Spectral CT	ALWAYS	AUTO	

Table 158: SC Equipment Module

Attribute Name	Tag	VR	Value	Presence of Value	Source	Comment
Conversion Type	0008,0064	CS	WSD	ALWAYS	AUTO	

Table 159: CT Image Module

Attribute Name	Tag	VR	Value	Presence of Value	Source	Comment
Rescale Intercept	0028,1052	DS	<ul style="list-style-type: none"> • Z Effective: 0 • Iodine no Water [mg/ml*]: -2.4 • Iodine Density [mg/ml]: 0 	ALWAYS	AUTO	

Rescale Slope	0028,1053	DS	according to result; • For Z Effective = 0.013 (to cover range 1-53) • Iodine no Water [mg/ml*] = 0.1 • Iodine Density [mg/ml]= 0.0111 (120kVp) / 0.0111 (140kVp)	ALWAYS	AUTO	
Rescale Type	0028,1054	LO	Per Image type: • Iodine Density [mg/ml]: " mg/ml " • Iodine no Water [mg/ml*]: " mg/ml* " • Z Effective: US	ALWAYS	AUTO	

Table 160: General Image Module

Attribute Name	Tag	VR	Value	Presence of Value	Source	Comment
Image Type	0008,0008	CS	"DERIVED\SECONDARYAXIAL\ <type>, </type>, Where <type> is: - ZEFF – Z Effective - MAT_DENS – (Material Density for Iodine no Water [mg/ml*] and Iodine Density [mg/ml])	ALWAYS	AUTO	
Burned In Annotations	0028,0301	CS	NO or YES	ANAP	AUTO	Value depends if patient identification information is burned into the images. If no patient identification information is burned into the images, tag may not appear.
Image Comments	0020,4000	LT	Possible values for Image Type Description: - Z Effective - Iodine no Water [mg/ml*] - Iodine Density [mg/ml]	ANAP	AUTO	Image Type Description & <any additional applicable comment>

Table 161: Image Pixel Module

Attribute Name	Tag	VR	Value	Presence of Value	Source	Comment
Rows	0028,0010	US		ALWAYS	AUTO	
Columns	0028,0011	US		ALWAYS	AUTO	

Table 162: VOI LUT Module

Attribute Name	Tag	VR	Value	Presence of Value	Source	Comment
Window Center	0028,1050	DS	Per Image type: • Iodine Density [mg/ml]: 6 • Iodine no Water [mg/ml*]: 6 • Z Effective: 8	ALWAYS	AUTO	
Window Width	0028,1051	DS	Per Image type: • Iodine Density [mg/ml]: 12 • Iodine no Water [mg/ml*]: 12 • Z Effective: 6	ALWAYS	AUTO	

Table 163: SOP Common Module

Attribute Name	Tag	VR	Value	Presence of Value	Source	Comment
SOP Class UID	0008,0016	UI	1.2.840.10008.5.1.4.1.1.2	ALWAYS	AUTO	

Table 164: Private attributes for Spectral non-HU Images

Attribute Name	Tag	VR	Value	Presence of Value	Source	Comment
Private Creator	01E1,0010	LO	ELSCINT1	ALWAYS	AUTO	
Reference Sequence	01E1,1055	SQ		ANAP	AUTO	
>SOP Instance UID	0008,0018	UI		ALWAYS	AUTO	<Instance UID for the corresponding SBI image>
>Study Instance UID	0020,000D	UI		ALWAYS	AUTO	<Study UID for the study which contains the corresponding SBI series>
>Series Instance UID	0020,000E	UI		ALWAYS	AUTO	<Series UID for the corresponding SBI series>
>Study ID	0020,0010	SH		ALWAYS	AUTO	<Study ID for the corresponding SBI series>
>Series Number	0020,0011	IS		ANAP	AUTO	<Series number for the corresponding SBI series>
>Instance Number	0020,0013	IS		ANAP	AUTO	<Image number for the corresponding SBI image>
>Reference type	01E1,1056	CS	SBI	ALWAYS	AUTO	
>Reference level	01E1,1057	CS	SERIES	ALWAYS	AUTO	
>Private Creator	01F7,0010	LO	ELSCINT1	ANAP	AUTO	
>Reference SBI type	01F7,10CE	LT	SBI_CSPN	ANAP	AUTO	
Private Creator	01F1,0010	LO	ELSCINT1	ALWAYS	AUTO	

Elsclint_Detectors_Layers	01F1,104F	US	33 – Iodine no Water [mg/ml*] 35 – Z Effective 38 – Iodine Density [mg/ml]	ALWAYS	AUTO	
Elsclint_SBI_version	01F7,10CC	ST	XX.YY: <SBI structure information> //XX – Major version number which represents the structure of the SBI. //YY – Minor version number which represents the parameters content of the SBI.	ANAP	AUTO	
Elsclint_SC_CT_equivalent	01F7,10CD	CS	YES	ANAP	AUTO	
ElsclintCT_Burned_Spectral_Annotations	01F7,10D3	LT	0 = No annotations are burned into the pixel data 1 = Annotations are burned into the pixel data	ALWAYS	AUTO	Tag shall be present when annotations were added to the object.
Elsclint_Idose_level	01F7,109B	IS	0 // No image iDose 1-7 // iDose Level	VNAP	AUTO	
Elsclint_Head_Body	01F7,10D4	SH	head or body	ALWAYS	AUTO	According to scan type
Elsclint_Spectral_Level	01F7,10D6	IS	0-7 // Spectral Level	ALWAYS	AUTO	

8.1.2.2.4. Spectral Color Images

Spectral Color images are created as a standard Secondary Capture IOD RGB image with specific attributes and attribute values as specified in the table below:

Table 165: General Series Module

Attribute Name	Tag	VR	Value	Presence of Value	Source	Comment
Series Date	0008,0021	DA		ALWAYS	AUTO	
Series Time	0008,0031	TM		ALWAYS	AUTO	
Series Description	0008,103E	LO	Possible values for Image Type Description: - Z Effective - Iodine no Water [mg/ml*] - Iodine Density [mg/ml]	ANAP	AUTO	Image Type Description & <any additional applicable comment>
Series Number	0020,0011	IS		ALWAYS	AUTO	
Series Instance UID	0020,000E	UI		ALWAYS	AUTO	

Table 166: General Equipment Module

Attribute Name	Tag	VR	Value	Presence of Value	Source	Comment
Manufacturer's Model Name	0008,1090	LO	IQon - Spectral CT	ALWAYS	AUTO	

Table 167: SC Equipment Module

Attribute Name	Tag	VR	Value	Presence of Value	Source	Comment
Conversion Type	0008,0064	CS	WSD	ALWAYS	AUTO	

Table 168: General Image Module

Attribute Name	Tag	VR	Value	Presence of Value	Source	Comment
Image Type	0008,0008	CS	DERIVED\SECONDAR Y\<Default value> \<type>, where <type> is: - ZEFF – Z Effective - MAT_DENS – (Material Density) for Iodine no Water [mg/ml*] and Iodine Density [mg/ml]	ALWAYS	AUTO	

Burned In Annotations	0028,0301	CS	NO or YES	ANAP	AUTO	Value depends if patient identification information is burned into the images. If no patient identification information is burned into the images, tag may not appear.
Image Comments	0020,4000	LT	Same as series description.			

Table 169: Image Pixel Module

Attribute Name	Tag	VR	Value	Presence of Value	Source	Comment
Samples per Pixel	0028,0002	US	3	ALWAYS	AUTO	
Photometric Interpretation	0028,0004	CS	RGB	ALWAYS	AUTO	
Planar Configuration	0028,0006	US	1	ALWAYS	AUTO	
Rows	0028,0010	US		ALWAYS	AUTO	
Columns	0028,0011	US		ALWAYS	AUTO	
Bits Allocated	0028,0100	US	8	ALWAYS	AUTO	
Bits Stored	0028,0101	US	8	ALWAYS	AUTO	
High Bit	0028,0102	US	7	ALWAYS	AUTO	
Pixel Representation	0028,0103	US	0	ALWAYS	AUTO	

Table 170: VOI LUT Module

Attribute Name	Tag	VR	Value	Presence of Value	Source	Comment
Window Center	0028,1050	DS		ALWAYS	AUTO	
Window Width	0028,1051	DS		ALWAYS	AUTO	

Table 171: SOP Common Module

Attribute Name	Tag	VR	Value	Presence of Value	Source	Comment
Instance Creation Date	0008,0012	DA		ALWAYS	AUTO	
Instance Creation Time	0008,0013	TM		ALWAYS	AUTO	
SOP Class UID	0008,0016	UI	1.2.840.10008.5.1.4.1.1.7	ALWAYS	AUTO	
SOP Instance UID	0008,0018	UI		ALWAYS	AUTO	

Table 172: Private attributes for Spectral Color Images

Attribute Name	Tag	VR	Value	Presence of Value	Source	Comment
Private Creator	01E1,0010	LO	ELSCINT1	ALWAYS	AUTO	
Reference Sequence	01E1,1055	SQ		ANAP	AUTO	
>SOP Instance UID	0008,0018	UI		ALWAYS	AUTO	<Instance UID for the corresponding SBI image>

>Study Instance UID	0020,000D	UI		ALWAYS	AUTO	<Study UID for the study which contains the corresponding SBI series>
>Series Instance UID	0020,000E	UI		ALWAYS	AUTO	<Series UID for the corresponding SBI series>
>Study ID	0020,0010	SH		ANAP	AUTO	<Study ID for the corresponding SBI series>
>Series Number	0020,0011	SH		ANAP	AUTO	<Series Number for the corresponding SBI series>
>Instance Number	0020,0013	IS		ANAP	AUTO	<Image number for the corresponding SBI image>
>Reference type	01E1,1056	CS	SBI	ALWAYS	AUTO	
>Reference level	01E1,1057	CS	SERIES	ALWAYS	AUTO	
>Private Creator	01F7,0010	LO	ELSCINT1	ALWAYS	AUTO	
>Reference SBI type	01F7,10CE	LT	SBI_CSPN	ANAP	AUTO	
Private Creator	01F1,0010	LO	ELSCINT1	ALWAYS	AUTO	
Elscint_Detectors_Layers	01F1,104F	US	33 – Iodine no Water [mg/ml*] 35 – Z Effective 38 – Iodine Density [mg/ml]	ANAP	AUTO	For Fusion images – tag is not applicable
Elscint_Idose_Level	01F7,109B	US	0 //No image domain idose 1-7 //iDose level	EMPTY	AUTO	
Elscint_SBI_version	01F7,10CC	ST	XX.YY: <SBI structure information> //XX – Major version number which represents the structure of the SBI. //YY – Minor version number which represents the parameters content of the SBI.	ANAP	AUTO	Example: 3: 30-Mar-2015 09:48 COMB_SCATT(250)_PE(250)_N cns:F, CFGs:5
Elscint_SC_CT_equivalent	01F7,10CD	CS	YES	ANAP	AUTO	
ElscintCT_Burned_Spectral_Annotations	01F7,10D3	LT	0 = no annotations are burned into the pixels in the image. 1 = annotations are burned into the pixels in the image.	ALWAYS	AUTO	Tag shall be present where annotations were added to the object.
Elscint_Idose_level	01F7,109B	IS	0 // No image iDose 1-7 // iDose Level	VNAP	AUTO	
Elscint_Head_Body	01F7,10D4	SH	head or body	ANAP	AUTO	According to scan type
Elscint_Spectral_Level	01F7,10D6	IS	0-7 // Spectral Level	ANAP	AUTO	

8.1.2.2.5. Spectral Base Images (SBI)

Spectral Base images are created as a standard Secondary Capture IOD RGB image with specific attributes and attribute values as specified in the table below. The attributes that are copied from the source images are not mentioned.

Table 173: General Series Module

Attribute Name	Tag	VR	Value	Presence of Value	Source	Comment
Series Date	0008,0021	DA		ALWAYS	AUTO	
Series Time	0008,0031	TM		ALWAYS	AUTO	
Series Description	0008,103E	LO	<p>Image Type Description & <any additional applicable comment></p> <p><u>Value for Image Type Description:</u> SBI (C_SC_PE_N)</p> <p>Where: C = Combined; SC = Scatter; PE = PhotoE;; N = Noise</p> <p>→ Followed by <Filter> / <Slice width> / <Contrast></p> <p>→ Followed by “ ” (vertical bar as a delimiter)</p> <p>→ Followed by Clinical Series Description: clinical series description shall be taken from either:</p> <ul style="list-style-type: none"> The 1st spectral series defined for the SBI (parent result) The respective conventional series if no spectral results are defined for the SBI. 	ALWAYS	AUTO	Example: SBI(C_SC_PE_N)_B_10 , Spectral (0)
Series Number	0020,0011	IS	<p>xxx97 (Where: xxx = result number of first relevant result, <97> = fixed number for all SBIs in the acquisition)</p>	ALWAYS	AUTO	

Series Instance UID	0020,000E	UI		ALWAYS	AUTO	
---------------------	-----------	----	--	--------	------	--

Table 174: General Equipment Module

Attribute Name	Tag	VR	Value	Presence of Value	Source	Comment
Manufacturer's Model Name	0008,1090	LO	IQon - Spectral CT	ALWAYS	AUTO	

Table 175: SC Equipment Module

Attribute Name	Tag	VR	Value	Presence of Value	Source	Comment
Conversion Type	0008,0064	CS	WSD	ALWAYS	AUTO	

Table 176: General Image Module

Attribute Name	Tag	VR	Value	Presence of Value	Source	Comment
Image Type	0008,0008	CS	DERIVED\SECONDARY\SBI\CSPN	ALWAYS	AUTO	
Burned In Annotations	0028,0301	CS	NO or YES	ANAP	AUTO	Value depends if patient identification information is burned into the images. If no patient identification information is burned into the images, tag may not appear.
Image Comments	0020,4000	LT		ANAP	AUTO	Same as series description.

Table 177: Image Pixel Module

Attribute Name	Tag	VR	Value	Presence of Value	Source	Comment
Samples per Pixel	0028,0002	US	3	ALWAYS	AUTO	
Photometric Interpretation	0028,0004	CS	RGB	ALWAYS	AUTO	
Planar Configuration	0028,0006	US	1	ALWAYS	AUTO	
Rows	0028,0010	US		ALWAYS	AUTO	As many as needed to accommodate spectral data
Columns	0028,0011	US		ALWAYS	COPY	Same as original
Bits Allocated	0028,0100	US	8	ALWAYS	AUTO	
Bits Stored	0028,0101	US	8	ALWAYS	AUTO	
High Bit	0028,0102	US	7	ALWAYS	AUTO	
Pixel Representation	0028,0103	US	0	ALWAYS	AUTO	

Table 178: VOI LUT Module

Attribute Name	Tag	VR	Value	Presence of Value	Source	Comment
Window Center	0028,1050	DS		ALWAYS	AUTO	Default Windowing to Conventional and MoneE images
Window Width	0028,1051	DS		ALWAYS	AUTO	Default Windowing to Conventional and MoneE images

Table 179: SOP Common Module

Attribute Name	Tag	VR	Value	Presence of Value	Source	Comment
Instance Creation Date	0008,0012	DA		ALWAYS	AUTO	
Instance Creation Time	0008,0013	TM		ALWAYS	AUTO	
SOP Class UID	0008,0016	UI	1.2.840.10008.5.1.4.1.1.7	ALWAYS	AUTO	
SOP Instance UID	0008,0018	UI		ALWAYS	AUTO	

Table 180: Private attributes for Spectral Base Images (SBI)

Attribute Name	Tag	VR	Value	Presence of Value	Source	Comment
Private Creator	01E1,0010	LO	ELSCINT1	ALWAYS	AUTO	
Reference Sequence	01E1,1055	SQ		ANAP	AUTO	
>SOP Instance UID	0008,0018	UI		ALWAYS	AUTO	<Instance UID for the corresponding SBI image>
>Study Instance UID	0020,000D	UI		ALWAYS	AUTO	<Study UID for the study which contains the corresponding SBI series>
>Series Instance UID	0020,000E	UI		ALWAYS	AUTO	<Series UID for the corresponding SBI series>
>Study ID	0020,0010	SH		ANAP	AUTO	<Study ID for the corresponding SBI series>
>Series Number	0020,0011	IS		ANAP	AUTO	<Series number for the corresponding SBI series>
>Instance Number	0020,0013	IS		ANAP	AUTO	<Image number for the corresponding SBI image>
>Reference type	01E1,1056	CS	SBI	ALWAYS	AUTO	
>Reference level	01E1,1057	CS	SERIES	ALWAYS	AUTO	
>Private Creator	01F7,0010	LO	ELSCINT1	ANAP	AUTO	
>Reference SBI type	01F7,10CE	LT	SBI_CSPN	ANAP	AUTO	
Private Creator	01F1,0010	LO	ELSCINT1	ALWAYS	AUTO	
Elscent_Detectors_Layers	01F1,104F	US	21	ALWAYS	AUTO	
Elscent_SBI_version	01F7,10CC	ST	XX.YY: <SBI structure information> //XX – Major version number which represents the structure of the SBI. //YY – Minor version number which represents the parameters content of the SBI.	ALWAYS	AUTO	.Example: 3: 30-Mar-2015 09:48 COMB_SCATT(250)_PE(250)_N cns:F, CFGs:5
Elscent_Idose_level	01F7,109B	IS	0 // No image iDose 1-7 // iDose Level	VNAP	AUTO	
Elscent_Head_Body	01F7,10D4	SH	head or body	ANAP	AUTO	According to scan type
Elscent_Spectral_Level	01F7,10D6	IS	0-7 // Spectral Level	ANAP	AUTO	

8.1.2.2.6. Spectral High/Low Images

Spectral Base images shall be created as a standard CT IOD image. Those images are not for clinical use and can be created only by a service user.

Table 181: General Series Module

Attribute Name	Tag	VR	Value	Presence of Value	Source	Comment
Series Date	0008,0021	DA		ALWAYS	AUTO	
Series Time	0008,0031	TM		ALWAYS	AUTO	
Series Description	0008,103E	LO	Low Energy NOT FOR DIAGNOSIS, Spectral CT & <any additional applicable description> Or High Energy NOT FOR DIAGNOSIS, Spectral CT & <any additional applicable description>	ANAP	AUTO	
Series Number	0020,0011	IS		ALWAYS	AUTO	
Series Instance UID	0020,000E	UI		ALWAYS	AUTO	

Table 182: General Equipment Module

Attribute Name	Tag	VR	Value	Presence of Value	Source	Comment
Manufacturer's Model Name	0008,1090	LO	IQon - Spectral CT	ALWAYS	AUTO	

Table 183: SOP Common Module

Attribute Name	Tag	VR	Value	Presence of Value	Source	Comment
Instance Creation Date	0008,0012	DA		ALWAYS	AUTO	
Instance Creation Time	0008,0013	TM		ALWAYS	AUTO	
SOP Class UID	0008,0016	UI	1.2.840.10008.5.1.4.1.1.2	ALWAYS	AUTO	
SOP Instance UID	0008,0018	UI		ALWAYS	AUTO	

Table 184: General Image Module

Attribute Name	Tag	VR	Value	Presence of Value	Source	Comment
Image Type	0008,0008	CS	ORIGINAL\PRIMARY\AXIAL\HIGH_LOW	ALWAYS	AUTO	

Image Comments	0020,4000	LT	Low Energy NOT FOR DIAGNOSIS, Spectral CT & <any additional applicable description> Or High Energy NOT FOR DIAGNOSIS, Spectral CT & <any additional applicable description>	ANAP	AUTO	Same as Series Description
----------------	-----------	----	---	------	------	----------------------------

Table 185: Private attributes for Spectral High/Low Images

Attribute Name	Tag	VR	Value	Presence of Value	Source	Comment
Private Creator	01F1,0010	LO	ELSCINT1	ALWAYS	AUTO	
Elscint_Detectors_Layers	01F1,104F	US	1 (for Low Energy Images) 2 (for High Energy Images)	ALWAYS	AUTO	
Private Creator	01F7,0010	LO	ELSCINT1	ALWAYS	AUTO	
Elscint_Idose_level	01F7,109B	IS	0 // No image iDose 1-7 // iDose Level	VNAP	AUTO	
Elscint_Head_Body	01F7,10D4	SH	head or body	ALWAYS	AUTO	According to scan type
Elscint_Spectral_Level	01F7,10D6	IS	0-7 // Spectral Level	ALWAYS	AUTO	

8.1.3. Usage of Attributes from Received IOD

The following attributes shall be present in the received IODs in order to be accepted:

For all IODs

- SOP Class UID (0008,0016)
- Study Instance UID (0020,000D)
- Series Instance UID (0020,000E)

For Image IODs

- Pixel Data (7FE0,0010) - Size may not be 0.
- Bits Allocated (0028,0100)

8.1.4. Attribute Mapping

Not applicable.

8.1.5. Coerced/Modified fields

The Import/Export Transparency of DICOM objects means preserving the attributes' values of the objects imported from an external system (remote or removable), optionally processed and then exported to an external system.

The system complies with Level-2 requirements for Storage SCP as defined in DICOM PS 3.4 Appendix B4.1. In other words, all Type 1, Type 2, and Type 3 Attributes defined in the Information Object Definition (IOD) associated with the SOP Class, as well as any Standard Extended attributes (including Private Attributes) included in the SOP Instance, will be stored and may be accessed.

The system does not coerce any Data Elements, except those defined in the DICOM PS 3.4 Appendix B4.1. In other words, when a DICOM object is imported from another system and later exported, all the attributes values will remain unchanged.

In the received IODs, the following attributes may be modified under certain conditions.

Table 186: Modified Attributes

Attribute	Tag	When Modified
Patient's Name	0010,0010	If Empty, the Patient's Name will be set to "Unknown".
Patient ID	0010,0020	If Empty, the Patient ID will be set to "Unknown".
Rows	0028,0010	Is Fixed, if rows columns does not match pixel data size.
SOP Instance UID	0008,0018	If missing, a new SOP Instance UID will be generate by IQon.

8.1.6. Data Dictionary of Private Attributes

Not applicable.

8.1.7. Coded Terminology and Templates

8.1.7.1. Context Groups

Not applicable.

8.1.7.2. Template Specifications

IQon CT scanner can optionally create and store, upon completion of the study, a DICOM CT RADIATION DOSE SR object. The templates that comprise the CT Radiation Dose SR are interconnected as indicated in the figure below:

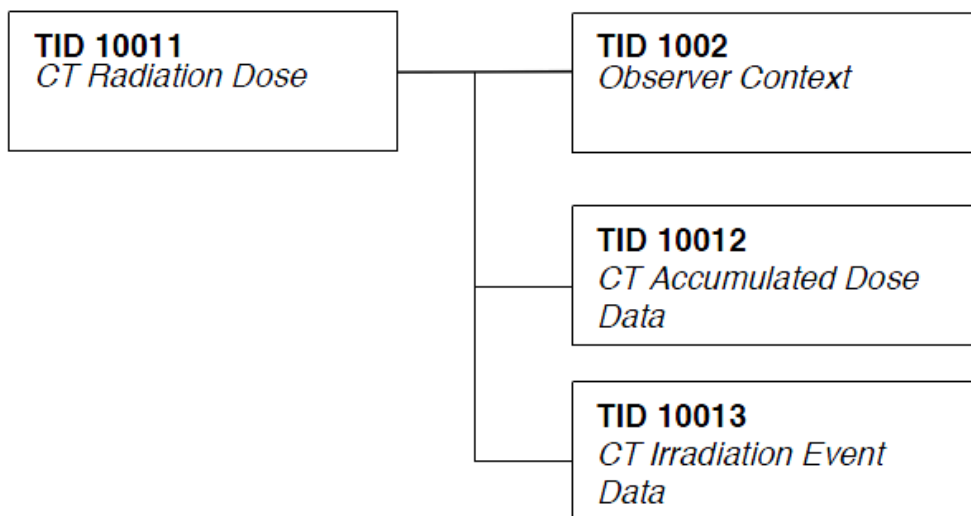

CT Radiation Dose SR IOD Template Structure

This section describes the content of all the templates used in the CT Radiation Dose Reporting SR.

Table 187: Used Templates for CT Radiation Dose Reporting

Template Name	Template ID
CT Radiation Dose	TID 10011
CT Accumulated Dose Data	TID 10012
CT Irradiation Event Data	TID 10013
Observer Context	TID 1002
Device Observer Identifying Attributes	TID 1004
Person Participant	TID 1020
Scanning Length	TID 10014
CT Dose Check Details	TID 10015

8.1.7.2.1. TID 10011 CT Radiation Dose

Table 188: CT Radiation Dose

NL	Relation with Parent	Concept Name	VT	VM	Presence of Value	Value
		X-Ray Radiation Dose Report		1	ALWAYS	
>	HAS CONCEPT MOD	Procedure reported	CODE	1	ALWAYS	Computed Tomography X-Ray
>>	HAS CONCEPT MOD	Has Intent	CODE	1	ALWAYS	Procedure Intent
>		DTID (1002) Observer Context	INCLUDE	1	ALWAYS	
>	HAS OBS CONTEXT	Start of X-Ray Irradiation	DATE/TIME	1	ALWAYS	
>	HAS OBS CONTEXT	End of X-Ray Irradiation	DATE/TIME	1	ALWAYS	
>	HAS OBS CONTEXT	Scope of Accumulation	CODE	1	ALWAYS	Study
>>	HAS PROPERTIES	DCID (10001) UID Types	UIDREF	1	ALWAYS	Study Instance UID (0020,000D)
>	CONTAINS	DTID (10012) CT Accumulated Dose Data	INCLUDE	1	ALWAYS	
>	CONTAINS	DTID (10013) CT Irradiation Event Data	INCLUDE	1-n	ALWAYS	
>	CONTAINS	Source of Dose Information	CODE	1	ALWAYS	Automated Data Collection

8.1.7.2.2. TID 10012 CT Accumulated Dose

Table 189: CT Accumulated Dose

NL	Relation with Parent	Concept Name	VT	VM	Presence of Value	Value
		CT Accumulated Dose Data	CONTAINER	1	ALWAYS	
>	CONTAINS	Total Number Of Irradiation Events	NUMBER	1	ALWAYS	"Total Number of Exposure "
>	CONTAINS	CT Dose Length Product Total	NUMBER	1	ALWAYS	"DLP" (units = mGy*cm)

8.1.7.2.3. TID 10013 CT Irradiation Event Data

Table 190: CT Irradiation Event Data

NL	Relation with Parent	Concept Name	VT	VM	Presence of Value	Value
		CT Acquisition	CONTAINER	1	ALWAYS	
>	CONTAINS	Acquisition Protocol	TEXT	1	ALWAYS	Protocol Name (0018.1030)
>	CONTAINS	Target Region	CODE	1	ALWAYS	Scan Type / Organ Type
>	CONTAINS	CT Acquisition Type	CODE	1	ALWAYS	Acquisition Type: Constant Angle/ Spiral Acquisition/Sequenced Acquisition
>	CONTAINS	Procedure Context	CODE	1	ALWAYS	“Diagnostic radiography with contrast media “ or “CT without contrast”
>	CONTAINS	Irradiation Event UID	UIDREF	1	ALWAYS	Identical to Irradiation Event UID in the images (0008,3010)
>	CONTAINS	CT Acquisition Parameters	CONTAINER	1	ALWAYS	
>>	CONTAINS	Exposure Time	NUM	1	ALWAYS	Value = Exposure Time (0018,1150) - per scan. (units = s)
>>	CONTAINS	DTID 10014 : Scanning Length	INCLUDE	1	ALWAYS	Value = Scan Length (0018,1302) - per scan (units = mm)
>>	CONTAINS	Nominal Single Collimation Width	NUM	1	ALWAYS	The width of a single row of acquired data Value = Single Collimation Width(0018,9306) - per scan (units = mm)
>>	CONTAINS	Nominal Total Collimation Width	NUM	1	ALWAYS	The width of the total collimation over the area of active x-ray detection Value = Total Collimation Width(0018,9307) - per scan (units = mm)
>>	CONTAINS	Pitch Factor	NUM	1	CONDITIONAL	Only present in case CT acquisition type has value “Spiral Acquisition” or “Sequenced Acquisition” Value = Spiral Pitch factor (0018,9311) - per scan
>>	CONTAINS	Number Of X-Ray Sources	NUM	1	ALWAYS	1
>>	CONTAINS	X-Ray Source Parameters	CONTAINER	1	ALWAYS	
>>>	CONTAINS	Identification of the X-Ray Source	TEXT	1	ALWAYS	A
>>>	CONTAINS	KVP	NUM	1	ALWAYS	Same as KvP (0018,0060) - per scan Units = kV
>>>	CONTAINS	Maximum X-Ray Tube Current	NUM	1	ALWAYS	Value = Max X-ray Tube Current(01E1,1052) - per scan. Units = mA
>>>	CONTAINS	X-Ray Tube Current	NUM	1	ALWAYS	Value = X-ray Tube Current(0018,1151) - per scan Units = mA
>>>	CONTAINS	Exposure Time per Rotation	NUM	1	CONDITIONAL	For Axial & Helix scans only. Value = Rotation Time (01F1,1027) - per scan Units = s

>	CONTAINS	CT Dose	CONTAINER	1	CONDITIONAL	Not present for CT Acquisition Type = Constant Angle
>>	CONTAINS	Mean CT DIvol	NUM	1	ALWAYS	Value = CT DIvol (0018,9345) - per scan Units = mGy
>>	CONTAINS	CT DIw Phantom Type	CODE	1	ALWAYS	Value = "IEC Head Dosimetry Phantom " for 16cm Head phantom Value = "IEC Body Dosimetry Phantom " for 32cm Body phantom
>>	CONTAINS	DLP	NUM	1	ALWAYS	Value = DLP (00E1,1021) - per scan (+/- 2% is acceptable). Units = mGy*cm
>>	CONTAINS	DTID (10015) CT Dose Check Details	INCLUDE	1	ALWAYS	
>	CONTAINS	Comment	TEXT	1	ALWAYS	empty

8.1.7.2.4. TID 1002 Observer Context

Table 191: Observer Context

NL	Relation with Parent	Concept Name	VT	VM	Presence of Value	Value
>	HAS OBS CONTEXT	Observer Type	CODE	1	CONDITIONAL	Device
>	HAS OBS CONTEXT	DTID (1004) Device observer identifying attributes	INCLUDE	1	ALWAYS	

8.1.7.2.5. TID 1004 Device Observer Identifying Attributes

Table 192: Device Observer Identifying Attributes

NL	Relation with Parent	Concept Name	VT	VM	Presence of Value	Value
>	HAS OBS CONTEXT	Device Observer UID	UIDREF	1	ALWAYS	Concatenation of Philips CT Root (1.3.46.670589.33.1) and Network Board MAC address
>	HAS OBS CONTEXT	Device Observer Name	TEXT	1	CONDITIONAL	Station Name (0008,1010): Equals the computer name (under Start->System Settings)
>	HAS OBS CONTEXT	Device Observer Manufacturer	TEXT	1	CONDITIONAL	Manufacturer (0008,0070): Philips
>	HAS OBS CONTEXT	Device Observer Model Name	TEXT	1	CONDITIONAL	Manufacturer's Model Name (0008,1090)
>	HAS OBS CONTEXT	Device Observer Serial Number	TEXT	1	CONDITIONAL	Device Serial Number (0018,1000) As in Preferences -> Institute -> Product Serial Number
>	HAS OBS CONTEXT	Device Observer Physical Location During Observation	TEXT	1	CONDITIONAL	Institution Name (0008,0080): As in Preferences -> Institute -> Name

8.1.7.2.6. TID 1020 Person Participant

Table 193: Person Participant

NL	Relation with Parent	Concept Name	VT	VM	Presence of Value	Value
		Person Name	PNAME	1	ALWAYS	
>	HAS PROPERTIES	Person Role in Procedure	CODE	1	ALWAYS	

8.1.7.2.7. TID 10014 Scanning Length

Table 194: Scanning Length

NL	Relation with Parent	Concept Name	VT	VM	Presence of Value	Value
		Scanning Length	NUM	1	ALWAYS	Value = Scan Length (0018,1302) - per scan Units = mm

8.1.7.2.8. TID 10015 CT Dose Check Details

Table 195: CT Dose Check Details

NL	Relation with Parent	Concept Name	VT	VM	Presence of Value	Value
		Dose Check Details	CONTAINER	1	ALWAYS	
>	CONTAINS	DLP Alert Value Configured	CODE	1	ALWAYS	Yes/No Value depends on whether the relevant (head/body) DLP Alert value is set in preferences.
>	CONTAINS	CTDIvol Alert Value Configured	CODE	1	ALWAYS	Yes/No Value depends on whether the relevant (head/body) CTDIvol Alert value is set in preferences.
>	CONTAINS	DLP Alert Value	NUM	1	CONDITIONAL	Only present if "DLP Alert Value Configured" = Yes. Units = mGy*cm
>	CONTAINS	CTDIvol Alert Value	NUM	1	CONDITIONAL	Only present if "CTDIvol Alert Value Configured" = Yes. Units = mGy
>	CONTAINS	Accumulated DLP Forward Estimate	NUM	1	CONDITIONAL	Only present in case DLP Alert Value Configured = Yes and Accumulated DLP value exceeds the configured DLP Alert value Units= mGy*cm
>	CONTAINS	Accumulated CTDIvol Forward Estimate	NUM	1	CONDITIONAL	Only present in case CTDIvol Alert Value Configured = Yes and Accumulated CTDIvol exceeds the configured CTDIvol alert value. Units = mGy

>	CONTAINS	Reason for Proceeding	TEXT	1	CONDITIONAL	Only present in case "Accumulated DLP Forward Estimate" exceeds DLP Alert Value or "Accumulated CTDIvol Forward Estimate" exceeds CTDIvol Alert Value. Value taken from pop-up window.
>	CONTAINS	DTID 1020:Person Participant	INCLUDE		CONDITIONAL	Only present in case "Accumulated DLP Forward Estimate" exceeds DLP Alert Value or "Accumulated CTDIvol Forward Estimate" exceeds CTDIvol Alert Value. Value taken from pop-up window.
		Dose Check Notification Details	CONTAINER	1	ALWAYS	
>	CONTAINS	DLP Notification Value Configured	CODE	1	ALWAYS	Yes/No Value depends on whether a DLP Notification value was set in the protocol step.
>	CONTAINS	CTDIvol Notification Value Configured	CODE	1	ALWAYS	Yes/No Value depends on whether a CTDIvol Notification value was set in the protocol step
>	CONTAINS	DLP Notification Value	NUM	1	CONDITIONAL	Only present if "DLP Notification Value Configured" = Yes. Units = mGy*cm
>	CONTAINS	CTDIvol Notification Value	NUM	1	CONDITIONAL	Only present if "CTDIvol Notification Value Configured" = Yes. Units = mGy
>	CONTAINS	DLP Forward Estimate	NUM	1	CONDITIONAL	Only present if DLP Forward Estimate exceeds DLP Notification Value. Units= mGy*cm
>	CONTAINS	CTDIvol Forward Estimate	NUM	1	CONDITIONAL	Only present if CTDIvol Forward Estimate exceeds CTDIvol notification value. Units = mGy
>	CONTAINS	Reason for Proceeding	TEXT	1	CONDITIONAL	Only present in case "DLP Forward Estimate" exceeds DLP Notification Value or "CTDIvol Forward Estimate" exceeds CTDIvol Notification Value. Value taken from pop-up window.

8.1.7.3. Private code definitions

Not applicable.

8.1.8. Grayscale Image consistency

Not applicable.

8.1.9. Standard Extended/Specialized/Private SOPs

This section describes (particular) Standard Extended SOP Classes, Specialized SOP Classes, or Private SOP Classes that are used.

Table 196: List of extended SOP Classes

SOP Class Name	SOP Class UID
CT Image Storage SOP Class	1.2.840.10008.5.1.4.1.1.2
Secondary Capture Image Storage SOP Class	1.2.840.10008.5.1.4.1.1.7
General ECG Waveform Storage SOP Class	1.2.840.10008.5.1.4.1.1.9.1.2

8.1.9.1. CT Image Storage SOP Class

Table 197: Extended DICOM attributes for CT Image Storage SOP Class Instances

Attribute Name	Tag	VR	Value	Presence of Value	Source	Comment
Angular Position (retired)	0018,1141	DS		ALWAYS	AUTO	
Acquisition Type	0018,9302	CS		ALWAYS	AUTO	

8.1.9.2. Secondary Capture Image Storage SOP Class

Table 198: Extended DICOM attributes for Secondary Capture Image Storage SOP Class Instances

Attribute Name	Tag	VR	Value	Presence of Value	Source	Comment
Medical Alerts	0010,2000	LO		VNAP	COPY	
Allergies	0010,2110	LO		VNAP	COPY	
Pregnancy Status	0010,21C0	US		VNAP	COPY	
Scan Options	0018,0022	CS		ANAP	COPY	
Slice Thickness	0018,0050	DS		ANAP	COPY	
KVP	0018,0060	DS		ANAP	COPY	
Data Collection Diameter	0018,0090	DS		ANAP	COPY	
Reconstruction Diameter	0018,1100	DS		ANAP	COPY	
Distance Source to Detector	0018,1110	DS		ANAP	COPY	
Distance Source to Patient	0018,1111	DS		ANAP	COPY	
Gantry/Detector Tilt	0018,1120	DS		ANAP	COPY	
Table Height	0018,1130	DS		ANAP	COPY	
Angular Position (retired)	0018,1141	DS		ANAP	COPY	
Exposure Time	0018,1150	IS		ANAP	COPY	
X-ray Tube Current	0018,1151	IS		ANAP	COPY	
Acquisition Type	0018,9302	CS		ANAP	COPY	
Single Collimation Width	0018,9306	FD		ANAP	COPY	
Total Collimation Width	0018,9307	FD		ANAP	COPY	
Table Speed	0018,9309	FD		ANAP	COPY	
Exposure Modulation Type	0018,9323	CS		ANAP	COPY	

Estimated Dose Saving	0018,9324	FD		ANAP	COPY	
Requesting Physician	0032,1032	PN		VNAP	COPY	
Special Needs	0038,0050	LO		VNAP	COPY	
Patient State	0038,0500	LO		VNAP	COPY	
Total Number of Exposures	0040,0301	US		ANAP	COPY	
Exposure Dose Sequence	0040,030E	SQ		ANAP	COPY	
>Acquisition Date time	0008,002A	DT		ANAP	COPY	
>Series Description	0008,103E	LO		ANAP	COPY	
>Contrast/Bolus Agent	0018,0010	LO		ANAP	COPY	
>Body Part Examined	0018,0015	CS		ANAP	COPY	
>KVP	0018,0060	DS		ANAP	COPY	
>Protocol Name	0018,1030	LO		ANAP	COPY	
>Exposure Time	0018,1150	IS		ANAP	COPY	
>X-ray Tube Current	0018,1151	IS		ANAP	COPY	
>Exposure	0018,1152	IS		ANAP	COPY	
>Radiation Mode	0018,115A	CS		ANAP	COPY	
>Scan Length	0018,1302	IS		ANAP	COPY	
>Acquisition Duration	0018,9073	FD		ANAP	COPY	
>Acquisition Type	0018,9302	CS		ANAP	COPY	
>Single Collimation Width	0018,9306	FD		ANAP	COPY	
>Total Collimation Width	0018,9307	FD		ANAP	COPY	
>CTDIvol	0018,9345	FD		ANAP	COPY	
>Series Number	0020,0011	IS		ANAP	COPY	
>Comments on Radiation Dose	0040,0310	ST		ANAP	COPY	
Comments on Radiation Dose	0040,0310	ST		ANAPCV	COPY	

8.1.9.3. General ECG Waveform Storage SOP Class

Table 199: Extended DICOM attributes for General ECG Waveform Storage SOP Class Instances

Attribute Name	Tag	VR	Value	Presence of Value	Source	Comment
Frame of Reference UID	0020,0052	UI		ANAP	AUTO	
Position Reference Indicator	0020,1040	LO		ALWAYS	AUTO	
Image Comments	0020,4000	LT		ALWAYS	AUTO	

8.1.10. Private Transfer Syntaxes

Supported Private Transfer Syntaxes are shown in the next Table.

Table 200: Supported Private Transfer Syntaxes

Transfer Syntax Name	Transfer Syntax UID	Comment
Private CT Transfer Syntax - Explicit VR Little Endian	1.3.46.670589.33.1.4.1	Private ELE (P-ELE).