

DICOM

Conformance Statement

MultiDiagnost Eleva with Flat Detector R5.2

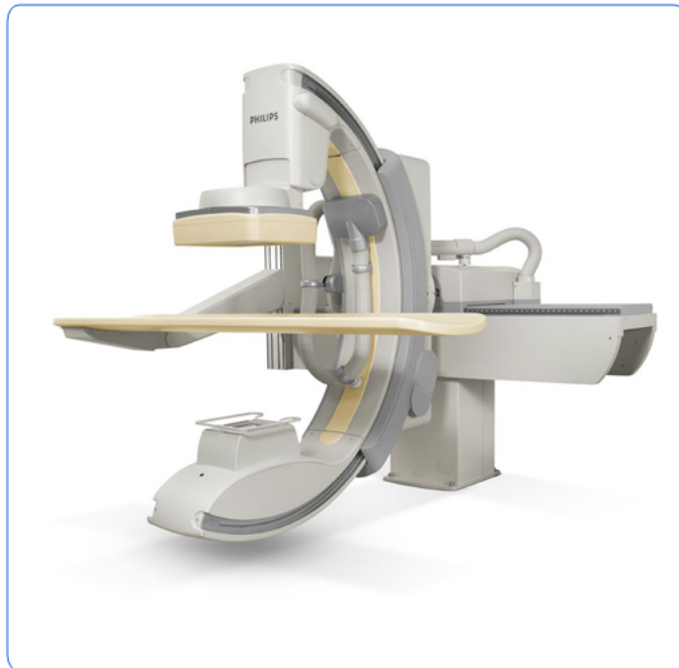

Issued by:

Philips Healthcare Philips Nederlands Best

P.O. Box 10.000
5680 DA Best
The Netherlands

Email: dicom@philips.com

Internet: <http://www.medical.philips.com/connectivity>

Document Number: XPS 031-090050.01

Date: 11-November-2008

1. DICOM CONFORMANCE STATEMENT OVERVIEW

The MultiDiagnost Eleva with Flat Detector is a multifunctional X-ray system, designed to provide faster, more confident diagnoses. It combines a wide applicational range with revolutionary Eleva technology that adapts the system to your way of working. When equipped with Philips' latest dynamic Flat Detector it provides excellent image quality at the lowest possible dose.

The MultiDiagnost Eleva with Flat Detector system is a Digital Fluorography modality. Depending on the purchased options and chosen configuration, the MultiDiagnost Eleva with Flat Detector system provides the following DICOM data exchange features:

- Request workload;
- Issue procedure information to RIS/HIS system;
- Image acquisition and display;
- Image review and processing;
- Image handling, storage and networking;
- Administration of patient, physician and examination data;
- Read and Write DICOM CD-RW disks;
- Read and Write DICOM DVD-RW disks;
- It allows the operator to print images stored in the database on a DICOM printer;
- Copy images from the local database to remote databases and vice versa;
- Import images for viewing;
- Storage Commitment function;
- It allows a remote system to query the MultiDiagnost Eleva with Flat Detector system database and to retrieve images from it;
- Sends out images either as raw data or as processed data.

The main application areas are:

- R/F examinations;
- Vascular examinations;
- Interventional procedures.

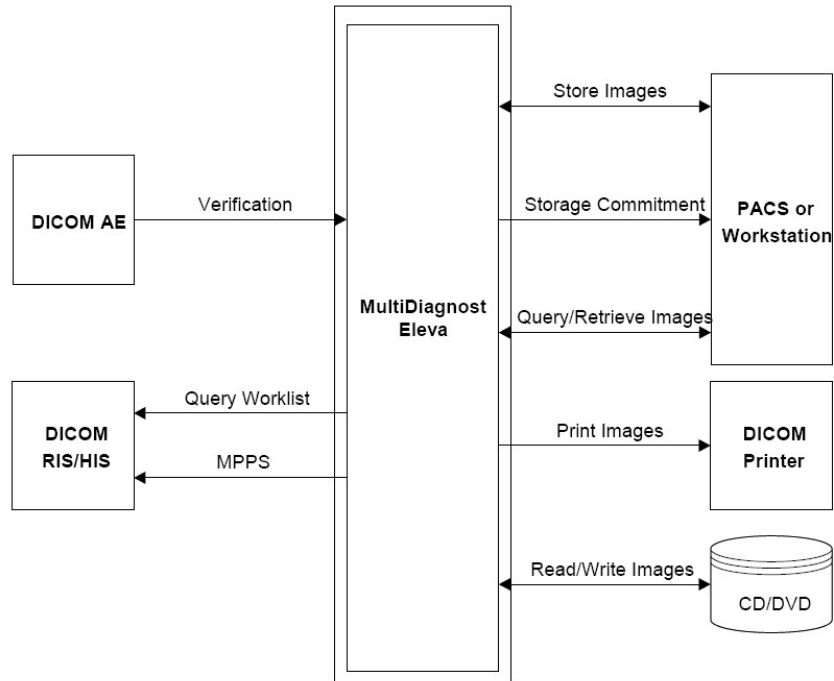

Figure 1: MultiDiagnost Eleva with Flat Detector in a DICOM Network

MultiDiagnost Eleva with Flat Detector allows the operator also to view, analyze and process the images stored in the database. Some advanced analysis and processing applications are primarily designed for images generated by Philips equipment when sent to the MultiDiagnost Eleva with Flat Detector.

Disclaimer:

It is not the intention of the implementation to export imported images.

The following table presents an overview of all network services and the applicable SOP classes as provided by the MultiDiagnost Eleva with Flat Detector.

Table 1: Network Services

SOP Class		User of Service (SCU)	Provider of Service (SCP)
Name	UID		
Other			
Verification SOP Class	1.2.840.10008.1.1	No	Yes
Print Management			
Presentation LUT SOP Class	1.2.840.10008.5.1.1.23	Yes	No
Basic Color Print Management Meta SOP Class	1.2.840.10008.5.1.1.18	Yes	No
>Basic Color Image Box SOP Class	1.2.840.10008.5.1.1.4.1	Yes	No
>Basic Film Box SOP Class	1.2.840.10008.5.1.1.2	Yes	No
>Basic Film Session SOP Class	1.2.840.10008.5.1.1.1	Yes	No
>Printer SOP Class	1.2.840.10008.5.1.1.16	Yes	No
Basic Grayscale Print Management Meta SOP Class	1.2.840.10008.5.1.1.9	Yes	No
>Basic Film Box SOP Class	1.2.840.10008.5.1.1.2	Yes	No
>Basic Film Session SOP Class	1.2.840.10008.5.1.1.1	Yes	No
>Basic Grayscale Image Box SOP Class	1.2.840.10008.5.1.1.4	Yes	No

SOP Class		User of Service (SCU)	Provider of Service (SCP)
Name	UID		
>Printer SOP Class	1.2.840.10008.5.1.1.16	Yes	No
Query/Retrieve			
Patient Root Query/Retrieve Information Model - FIND SOP Class	1.2.840.10008.5.1.4.1.2.1.1	Yes	Yes
Patient Root Query/Retrieve Information Model - MOVE SOP Class	1.2.840.10008.5.1.4.1.2.1.2	Yes	Yes
Patient/Study Only Query/Retrieve Info. Model - FIND SOP Class	1.2.840.10008.5.1.4.1.2.3.1	Yes	Yes
Patient/Study Only Query/Retrieve Info. Model - MOVE SOP Class	1.2.840.10008.5.1.4.1.2.3.2	Yes	Yes
Study Root Query/Retrieve Information Model - FIND SOP Class	1.2.840.10008.5.1.4.1.2.2.1	Yes	Yes
Study Root Query/Retrieve Information Model - MOVE SOP Class	1.2.840.10008.5.1.4.1.2.2.2	Yes	Yes
Transfer			
3D Object new Storage (Private)	1.3.46.670589.5.0.2.1	Yes	Yes
3D Volume Storage new SOP Class (Private)	1.3.46.670589.5.0.1.1	Yes	Yes
Cardio Image Storage new SOP Class (Private)	1.3.46.670589.5.0.8.1	Yes	Yes
Computed Radiography Image Storage SOP Class	1.2.840.10008.5.1.4.1.1.1	Yes	Yes
CT Image Storage SOP Class	1.2.840.10008.5.1.4.1.1.2	Yes	Yes
CT Synthetic Image Storage (Private)	1.3.46.670589.5.0.9	Yes	Yes
CX Synthetic Image Storage (Private)	1.3.46.670589.5.0.12	Yes	Yes
Digital X-Ray Image Storage - For Pres. SOP	1.2.840.10008.5.1.4.1.1.1.1	Yes	Yes
MR Cardio Analysis new Storage (Private)	1.3.46.670589.5.0.11.1	Yes	Yes
MR Image Storage SOP Class	1.2.840.10008.5.1.4.1.1.4	Yes	Yes
MR Synthetic Image Storage (Private)	1.3.46.670589.5.0.10	Yes	Yes
Nuclear Medicine Image Storage SOP Class	1.2.840.10008.5.1.4.1.1.20	Yes	Yes
Perfusion (Private)	1.3.46.670589.5.0.13	Yes	Yes
Perfusion Image Storage (Private)	1.3.46.670589.5.0.14	Yes	Yes
Secondary Capture Image Storage SOP Class	1.2.840.10008.5.1.4.1.1.7	Yes	Yes
Softcopy Presentation State Storage SOP Class	1.2.840.10008.5.1.4.1.1.11.1	Yes	Yes
Specialized PMS X-Ray Image Store	1.3.46.670589.2.3.1.1	Yes	Yes
Surface Storage new (Private)	1.3.46.670589.5.0.3.1	Yes	Yes
Ultrasound Image Storage SOP Class	1.2.840.10008.5.1.4.1.1.6.1	Yes	Yes
Ultrasound Multi-frame Image Storage SOP Class	1.2.840.10008.5.1.4.1.1.3.1	Yes	Yes
XA reconstructed X-ray SOP Class (private)	1.3.46.670589.2.4.1.1	Yes	Yes
X-Ray Angiographic Image Storage SOP Class	1.2.840.10008.5.1.4.1.1.12.1	Yes	Yes
X-Ray Radiofluoroscopic Image Storage SOP Class	1.2.840.10008.5.1.4.1.1.12.2	Yes	Yes
Workflow Management			
Modality Performed Procedure Step SOP Class	1.2.840.10008.3.1.2.3.3	Yes	No
Modality Worklist Information Model - FIND SOP Class	1.2.840.10008.5.1.4.31	Yes	No
Storage Commitment Push Model SOP Class	1.2.840.10008.1.20.1	Yes	No

A table of Supported Media Storage Application Profiles (with roles) is provided.

Note (DVD): Only DVD+R(W), and without JPEG.

Table 2: Media Services

Media Storage Application Profile	File-set Creator (FSC)	File-set Updater (FSU)	File-set Reader (FSR)	Display Directory (DD)
Compact Disk-Recordable				
General Purpose CD-R Interchange	Yes	Yes	Yes	No
DVD				
General Purpose DVD Interchange with JPEG	Yes	No	Yes	No

2. TABLE OF CONTENTS

1.	DICOM CONFORMANCE STATEMENT OVERVIEW	3
2.	TABLE OF CONTENTS	7
3.	INTRODUCTION	9
3.1.	REVISION HISTORY	9
3.2.	AUDIENCE	9
3.3.	REMARKS	9
3.4.	DEFINITIONS, TERMS AND ABBREVIATIONS	10
3.5.	REFERENCES	11
4.	NETWORKING	12
4.1.	IMPLEMENTATION MODEL	12
4.1.1.	Application Data Flow	12
4.1.2.	Functional Definition of AE's	14
4.1.2.1.	Functional Definition of ACP AE	14
4.1.2.2.	Functional Definition of RIS AE	14
4.1.3.	Sequencing of Real World Activities	14
4.2.	AE SPECIFICATIONS	16
4.2.1.	ACP AE	16
4.2.1.1.	SOP Classes	16
4.2.1.2.	Association Policies	17
4.2.1.2.1.	General	17
4.2.1.2.2.	Number of Associations	17
4.2.1.2.3.	Asynchronous Nature	18
4.2.1.2.4.	Implementation Identifying Information	18
4.2.1.2.5.	Communication Failure Handling	18
4.2.1.3.	Association Initiation Policy	18
4.2.1.3.1.	(Real-World) Activity – FIND As SCU	19
4.2.1.3.2.	(Real-World) Activity – MOVE As SCU	26
4.2.1.3.3.	(Real-World) Activity – Image Export	30
4.2.1.3.4.	(Real-World) Activity – Storage Commitment Push Model AS SCU	33
4.2.1.3.5.	(Real-World) Activity – Print Management As SCU	36
4.2.1.4.	Association Acceptance Policy	50
4.2.1.4.1.	(Real-World) Activity – Verification as SCP	50
4.2.1.4.2.	(Real-World) Activity – FIND As SCP	52
4.2.1.4.3.	(Real-World) Activity – MOVE As SCP	58
4.2.1.4.4.	(Real-World) Activity – Image Import	61
4.2.2.	RIS AE	64
4.2.2.1.	SOP Classes	64
4.2.2.2.	Association Policies	64
4.2.2.2.1.	General	64
4.2.2.2.2.	Number of Associations	65
4.2.2.2.3.	Asynchronous Nature	65
4.2.2.2.4.	Implementation Identifying Information	65
4.2.2.2.5.	Communication Failure Handling	65
4.2.2.3.	Association Initiation Policy	65
4.2.2.3.1.	(Real-World) Activity – Modality worklist As SCU	68
4.2.2.3.2.	(Real-World) Activity – Modality Performed Procedure Step As SCU	74
4.2.2.4.	Association Acceptance Policy	81
4.2.2.4.1.	(Real-World) Activity – Verification as SCP	82
4.3.	NETWORK INTERFACES	84
4.3.1.	Physical Network Interfaces	84
4.3.2.	Additional Protocols	84
4.4.	CONFIGURATION	84
4.4.1.	AE Title/Presentation Address Mapping	84
4.4.1.1.	Local AE Titles	84
4.4.1.2.	Remote AE Title/Presentation Address Mapping	84
4.4.2.	Parameters	85
5.	MEDIA INTERCHANGE	88

5.1.	IMPLEMENTATION MODEL	88
5.1.1.	Application Data Flow Diagram.....	88
5.1.2.	Functional Definitions of AE's	88
5.1.3.	Sequencing of Real World Activities.....	89
5.2.	AE SPECIFICATIONS	90
5.2.1.	ACP AE Media - Specification	90
5.2.1.1.	File Meta Information for the ACP AE.....	90
5.2.1.2.	Real-World Activities.....	91
5.2.1.2.1.	RWA - Read File-set.....	91
5.2.1.2.2.	RWA - Create File-set.....	92
5.2.1.2.3.	RWA - Update File-set.....	93
5.3.	AUGMENTED AND PRIVATE APPLICATION PROFILES	94
5.4.	MEDIA CONFIGURATION	94
6.	SUPPORT OF CHARACTER SETS	95
7.	SECURITY	96
7.1.	SECURITY PROFILES	96
7.1.1.	Security use Profiles	96
7.1.2.	Security Transport Connection Profiles	96
7.1.3.	Digital Signature Profiles.....	98
7.1.4.	Media Storage Security Profiles.....	98
7.1.5.	Attribute Confidentiality Profiles	98
7.1.6.	Network Address Management Profiles	99
7.1.7.	Time Synchronization Profiles	99
7.1.8.	Application Configuration Management Profiles.....	99
7.1.9.	Audit Trail Profiles	99
7.2.	ASSOCIATION LEVEL SECURITY.....	100
7.3.	APPLICATION LEVEL SECURITY	100
8.	ANNEXES OF APPLICATION "ELEVA EDI"	101
8.1.	IOD CONTENTS	101
8.1.1.	Created SOP Instance	101
8.1.1.1.	List of created SOP Classes	101
8.1.1.2.	Secondary Capture Image Storage SOP Class.....	102
8.1.1.3.	Softcopy Presentation State Storage SOP Class	104
8.1.1.4.	X-Ray Radiofluoroscopic Image Storage SOP Class.....	108
8.1.2.	Usage of Attributes from Received IOD.....	111
8.1.3.	Attribute Mapping	113
8.1.4.	Coerced/Modified fields.....	114
8.2.	DATA DICTIONARY OF PRIVATE ATTRIBUTES	117
8.3.	CODED TERMINOLOGY AND TEMPLATES	117
8.3.1.	Context Groups	117
8.3.2.	Template Specifications	117
8.3.3.	Private code definitions	117
8.4.	GRAYSCALE IMAGE CONSISTENCY	117
8.5.	STANDARD EXTENDED/SPECIALIZED/PRIVATE SOPS.....	118
8.6.	PRIVATE TRANSFER SYNTAXES.....	118

3. INTRODUCTION

The introduction specifies product and relevant disclaimers as well as any general information that the vendor feels is appropriate.

3.1. Revision History

The revision history provides dates and differences of the different releases.

Table 3: Revision History

Document Version	Date of Issue	Author	Description
00	11-November-2008		Initial version

3.2. Audience

This Conformance Statement is intended for:

- (Potential) customers
- System integrators of medical equipment
- Marketing staf interested in system functionality
- Software designers implementing DICOM interfaces

It is assumed that the reader is familiar with the DICOM standard.

3.3. Remarks

The DICOM Conformance Statement is contained in chapter 4 through 8 and follows the contents and structuring requirements of DICOM PS 3.2.

This DICOM Conformance Statement by itself does not guarantee successful interoperability of Philips equipment with non-Philips equipment. The user (or users agent) should be aware of the following issues:

- **Interoperability**
Interoperability refers to the ability of application functions, distributed over two or more systems, to work successfully together. The integration of medical devices into an IT environment may require application functions that are not specified within the scope of DICOM. Consequently, using only the information provided by this Conformance Statement does not guarantee interoperability of Philips equipment with non-Philips equipment. It is the users responsibility to analyze thoroughly the application requirements and to specify a solution that integrates Philips equipment with non-Philips equipment.
- **Validation**
Philips equipment has been carefully tested to assure that the actual implementation of the DICOM interface corresponds with this Conformance Statement. Where Philips equipment is linked to non-Philips equipment, the first step is to compare the relevant Conformance Statements. If the Conformance Statements indicate that successful information exchange should be possible, additional validation tests will be necessary to ensure the functionality, performance, accuracy and stability of image and image related

data. It is the responsibility of the user (or users agent) to specify the appropriate test suite and to carry out the additional validation tests.

- **New versions of the DICOM Standard**

The DICOM Standard will evolve in future to meet the users growing requirements and to incorporate new features and technologies. Philips is actively involved in this evolution and plans to adapt its equipment to future versions of the DICOM Standard. In order to do so, Philips reserves the right to make changes to its products or to discontinue its delivery. The user should ensure that any non-Philips provider linking to Philips equipment also adapts to future versions of the DICOM Standard. If not, the incorporation of DICOM enhancements into Philips equipment may lead to loss of connectivity (in case of networking) and incompatibility (in case of media).

3.4. Definitions, Terms and Abbreviations

Table 4: Definitions, Terms and Abbreviations

Abbreviations/ Terms	Explanation
AE	Application Entity
ANSI	American National Standard Institute
AP	Application Profile
BOT	Basic Offset Table
CD	Compact Disc
CD-R	CD-Recordable
CD-M	CD-Medical
CR	Computed Radiography
CT	Computed Tomography
DCR	Dynamic Cardio Review
DICOM	Digital Imaging and Communication in Medicine
DIMSE	DICOM Message Service Element
DIMSE-C	DIMSE-Composite
DIMSE-N	DIMSE-Normalized
DX	Digital X-Ray
EBE	Explicit VR Big Endian
ELE	Explicit VR Little Endian
FSC	File-set Creator
FSR	File-set Reader
FSU	File-set Updater
GUI	Graphic User Interface
HIS	Hospital Information System
HL7	Health Level Seven
ILE	Implicit VR Little Endian
IOD	Information Object Definition
ISIS	Information System - Imaging System
MOD	Magneto-Optical Disk
MPPS	Modality Performed Procedure Step
MR	Magnetic Resonance
NEMA	National Electrical Manufacturers Association
NM	Nuclear Medicine
PDU	Protocol Data Unit
RF	X-Ray Radiofluoroscopic
RIS	Radiology Information System

Abbreviations/ Terms	Explanation
RT	Radiotherapy
RWA	Real-World Activity
SC	Secondary Capture
SCM	Study Component Management
SCP	Service Class Provider
SCU	Service Class User
SOP	Service Object Pair
TCP/IP	Transmission Control Protocol/ Internet Protocol
UID	Unique Identifier
US	Ultrasound
USMF	Ultrasound Multi-frame
WLM	Worklist Management
XA	X-Ray Angiographic

3.5. References

- [DICOM] Digital Imaging and Communications in Medicine, Part 1 - 18
(NEMA PS 3.1- PS 3.18),
National Electrical Manufacturers Association (NEMA)
Publication Sales 1300 N. 17th Street, Suite 1847
Rosslyn, Virginia. 22209, United States of America
Internet: <http://medical.nema.org/>
Note that at any point in time the official standard consists of the most recent yearly edition of the base standard (currently 2008) plus all the supplements and correction items that have been approved as Final Text.

4. NETWORKING

This section contains the networking related services (vs. the media related ones).

4.1. Implementation model

The implementation model consists of three sections:

- The application data flow diagram, specifying the relationship between the Application Entities and the "external world" or Real-World Activities,
- A functional description of each Application Entity, and
- The sequencing constraints among them.

4.1.1. Application Data Flow

The Eleva implements two application entities:

- RIS AE;
- ACP AE.

The following figure shows the networking application data flow as a functional overview of these application entities. On the left the local Real-World Activities are presented, whereas on the right the remote Real-World Activities are presented.

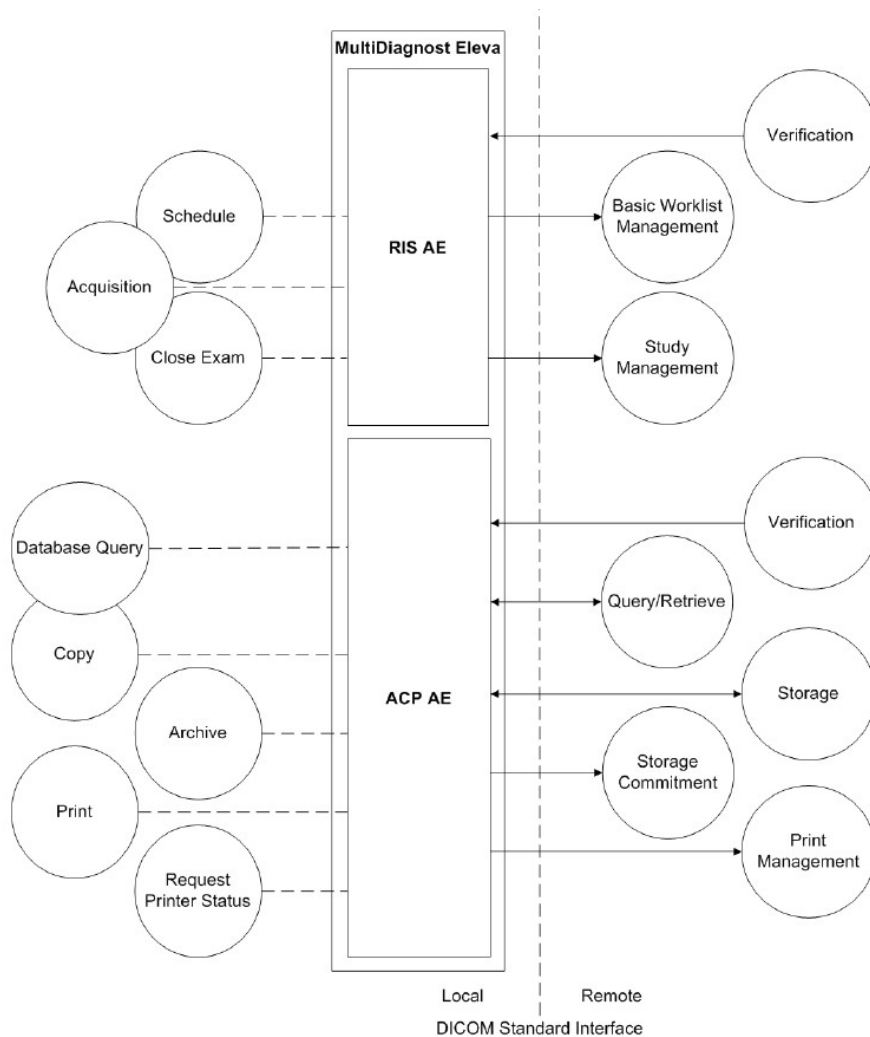

Figure 2: Application Data Flow Diagram

The RIS AE incorporates the following functionality:

- For RWA Verification the Eleva as SCP provides standard Verification Service Class functionality to the requesting SCU.
- For RWA Schedule the Eleva as SCU uses the SCP Basic Worklist Management Service Class to query for the worklist.
- For RWA Acquisition the Eleva as SCU uses the SCP Study Management Service Class to create an MPPS record.
- For RWA Close Exam the Eleva as SCU uses the SCP Study Management Service Class to complete the MPPS record.

The ACP AE incorporates the following functionality:

- For RWA Verification the Eleva as SCP provides standard Verification Service Class functionality to the requesting SCU.
- For RWA Storage the Eleva as SCP provides standard Storage Service Class functionality to the requesting SCU.

- For RWA Query/Retrieve the Eleva as SCP provides standard Query/Retrieve Service Class functionality to the requesting SCU.
- For RWA Copy (triggered by either operator or RWA Query/Retrieve) the Eleva as SCU uses the SCP Storage Service Class functionality to store local images, or the SCP Query/Retrieve Service Class functionality to move remote images.
- For RWA Database Query the Eleva as SCU uses the SCP Query/Retrieve Service Class functionality to query images.
- For RWA Archive the Eleva as SCU uses the SCP Storage Service Class functionality to store local images and the SCP Storage Commitment Service Class functionality to commit these images.
- For RWA Print the Eleva as SCU uses the Print Management Service Class to print local images.
- For RWA Request Printer Status, the Eleva as SCU uses the Print Management Service Class to request the printer status.

4.1.2. Functional Definition of AE's

This section contains a functional definition for each individual local Application Entity.

4.1.2.1. Functional Definition of ACP AE

The ACP AE will act as SCP for Verification (Verification), Storage (Import), and Query/Retrieve (Query; Retrieve). The ACP AE will act as SCU for Storage (Copy; Archive), Storage Commitment (Archive), Query/Retrieve (Database Query; Copy) and Print Management (Print; Request Printer Status).

4.1.2.2. Functional Definition of RIS AE

The RIS AE will act as SCP for Verification (Verification), and will act as SCU for Basic Worklist Management (RIS Query) and Study Management (Acquisition). Initiated by the operator the RIS AE will propose the required presentation contexts for an association with the peer SCP.

4.1.3. Sequencing of Real World Activities

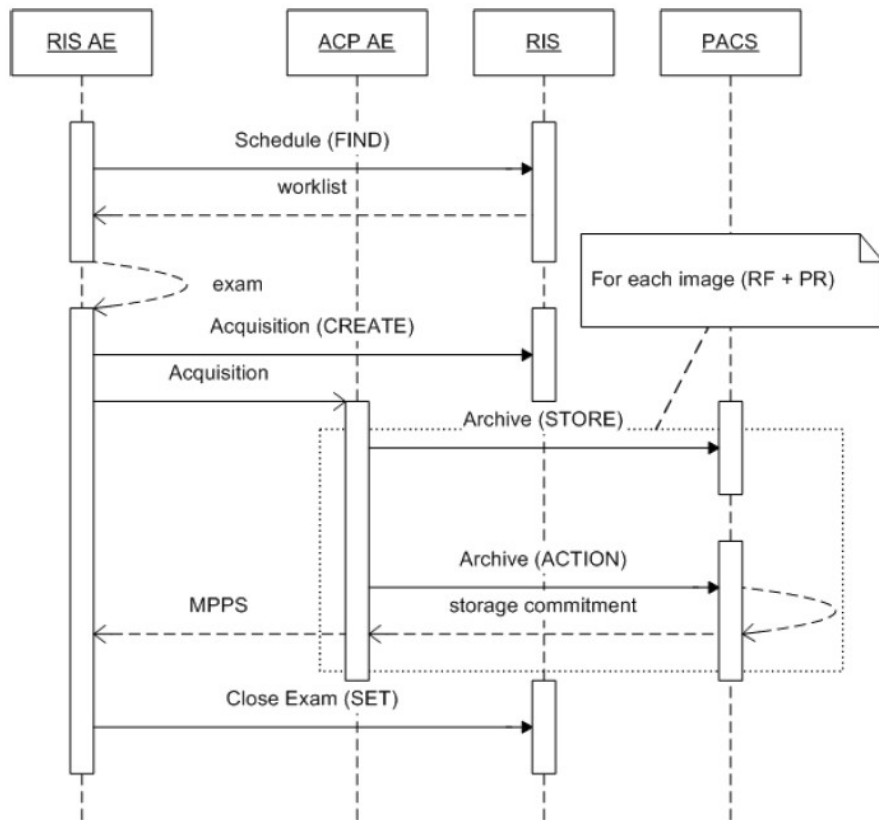

Figure 3: Sequencing of the Real-World Activities of the Eleva

The RIS AE can create an exam as result of a schedule (worklist or manual scheduling by clinical user). The clinical user can select an exam for acquisition. Once an acquisition has started, the MPPS CREATE message is sent from the RIS AE to the RIS. After each acquisition the exam and acquired image data are received by the ACP AE to view, export, or print.

Now the clinical user can archive the acquired images on a PACS; for each acquisition this includes storage of the image (and - if configured - presentation state) and - if configured - storage commitment. For each successful archive job the ACP AE will send the related MPPS data to the RIS AE.

Finally the clinical user can either close or discontinue the exam. As a result the RIS AE will send an MPPS SET message with status "COMPLETED" or "DISCONTINUED" to the RIS and remove the exam from the list.

4.2. AE Specifications

This section in the DICOM Conformance Statement is a set of application entity specifications. There are as many of these subsections as there are different AEs in the implementation.

4.2.1. ACP AE

Detail of this specific Application Entity is specified in this section.

4.2.1.1. SOP Classes

This Application Entity provides Standard Conformance to the following SOP Classes.

Table 5: SOP Classes for ACP AE

SOP Class Name	SOP Class UID	SCU	SCP
3D Object new Storage (Private)	1.3.46.670589.5.0.2.1	Yes	Yes
3D Volume Storage new SOP Class (Private)	1.3.46.670589.5.0.1.1	Yes	Yes
Cardio Image Storage new SOP Class (Private)	1.3.46.670589.5.0.8.1	Yes	Yes
Computed Radiography Image Storage SOP Class	1.2.840.10008.5.1.4.1.1.1	Yes	Yes
CT Image Storage SOP Class	1.2.840.10008.5.1.4.1.1.2	Yes	Yes
CT Synthetic Image Storage (Private)	1.3.46.670589.5.0.9	Yes	Yes
CX Synthetic Image Storage (Private)	1.3.46.670589.5.0.12	Yes	Yes
Digital X-Ray Image Storage - For Pres. SOP	1.2.840.10008.5.1.4.1.1.1.1	Yes	Yes
MR Cardio Analysis new Storage (Private)	1.3.46.670589.5.0.11.1	Yes	Yes
MR Image Storage SOP Class	1.2.840.10008.5.1.4.1.1.4	Yes	Yes
MR Synthetic Image Storage (Private)	1.3.46.670589.5.0.10	Yes	Yes
Nuclear Medicine Image Storage SOP Class	1.2.840.10008.5.1.4.1.1.20	Yes	Yes
Patient Root Query/Retrieve Information Model - FIND SOP Class	1.2.840.10008.5.1.4.1.2.1.1	Yes	Yes
Patient Root Query/Retrieve Information Model - MOVE SOP Class	1.2.840.10008.5.1.4.1.2.1.2	Yes	Yes
Patient/Study Only Query/Retrieve Info. Model - FIND SOP Class	1.2.840.10008.5.1.4.1.2.3.1	Yes	Yes
Patient/Study Only Query/Retrieve Info. Model - MOVE SOP Class	1.2.840.10008.5.1.4.1.2.3.2	Yes	Yes
Perfusion (Private)	1.3.46.670589.5.0.13	Yes	Yes
Perfusion Image Storage (Private)	1.3.46.670589.5.0.14	Yes	Yes
Presentation LUT SOP Class	1.2.840.10008.5.1.1.2.3	Yes	No
Secondary Capture Image Storage SOP Class	1.2.840.10008.5.1.4.1.1.7	Yes	Yes
Softcopy Presentation State Storage SOP Class	1.2.840.10008.5.1.4.1.1.11.1	Yes	Yes
Specialized PMS X-Ray Image Store	1.3.46.670589.2.3.1.1	Yes	Yes
Storage Commitment Push Model SOP Class	1.2.840.10008.1.20.1	Yes	No
Study Root Query/Retrieve Information Model - FIND SOP Class	1.2.840.10008.5.1.4.1.2.2.1	Yes	Yes
Study Root Query/Retrieve Information Model - MOVE SOP Class	1.2.840.10008.5.1.4.1.2.2.2	Yes	Yes
Surface Storage new (Private)	1.3.46.670589.5.0.3.1	Yes	Yes
Ultrasound Image Storage SOP Class	1.2.840.10008.5.1.4.1.1.6.1	Yes	Yes
Ultrasound Multi-frame Image Storage SOP Class	1.2.840.10008.5.1.4.1.1.3.1	Yes	Yes
Verification SOP Class	1.2.840.10008.1.1	No	Yes
XA reconstructed X-ray SOP Class (private)	1.3.46.670589.2.4.1.1	Yes	Yes
X-Ray Angiographic Image Storage SOP Class	1.2.840.10008.5.1.4.1.1.12.1	Yes	Yes
X-Ray Radiofluoroscopic Image Storage SOP Class	1.2.840.10008.5.1.4.1.1.12.2	Yes	Yes
Basic Color Print Management Meta SOP Class	1.2.840.10008.5.1.1.18	Yes	No

SOP Class Name	SOP Class UID	SCU	SCP
>Basic Color Image Box SOP Class	1.2.840.10008.5.1.1.4.1	Yes	No
>Basic Film Box SOP Class	1.2.840.10008.5.1.1.2	Yes	No
>Basic Film Session SOP Class	1.2.840.10008.5.1.1.1	Yes	No
>Printer SOP Class	1.2.840.10008.5.1.1.16	Yes	No
Basic Grayscale Print Management Meta SOP Class	1.2.840.10008.5.1.1.9	Yes	No
>Basic Film Box SOP Class	1.2.840.10008.5.1.1.2	Yes	No
>Basic Film Session SOP Class	1.2.840.10008.5.1.1.1	Yes	No
>Basic Grayscale Image Box SOP Class	1.2.840.10008.5.1.1.4	Yes	No
>Printer SOP Class	1.2.840.10008.5.1.1.16	Yes	No

Note: Any SOP specific behavior is documented later in the conformance statement in the applicable SOP specific conformance section.

4.2.1.2. Association Policies

Each AE specification contains a description of the general association establishment and acceptance policies of the AE.

4.2.1.2.1. General

The DICOM standard application context has specified.

Table 6: DICOM Application Context

Description	Value
Application Context Name	1.2.840.10008.3.1.1.1

4.2.1.2.2. Number of Associations

The number of simultaneous associations that an Application Entity may support as a Initiator or Acceptor is specified.

Table 7: Number of associations as an Association Initiator for this AE

Description	Value
Maximum number of simultaneous associations	Partly limited by UI and configuration - ref. note.

Note: local activities may result in at most 3 simultaneous associations: one association may be used to issue query requests, one association may be used to issue store or retrieve requests, and one association may be used for print requests. Furthermore, the ACP AE may initiate an association for each remote retrieve request, executed by the ACP AE as a C-MOVE operation. These associations are used to issue the C-STORE sub-operations implied by the retrieve requests. The number of simultaneous store associations for this retrieve purpose is principally not limited. The number of simultaneous associations for Storage Commitment is configurable.

Table 8: Number of associations as an Association Acceptor for this AE

Description	Value
Maximum number of simultaneous associations	Configurable

Note: the number of simultaneous supported associations is determined by the available resources (CPU, memory, disk space).

4.2.1.2.3. Asynchronous Nature

The ACP AE does not support asynchronous operations and will not perform asynchronous window negotiation.

4.2.1.2.4. Implementation Identifying Information

The value supplied for Implementation Class UID and version name are documented here.

Table 9: DICOM Implementation Class and Version for ACP AE

Implementation Class UID	1.3.46.670589.5.2.23
Implementation Version Name	ViewForum R6.3

4.2.1.2.5. Communication Failure Handling

The behavior of the AE during communication failure is summarized in next table.

Table 10: Communication Failure Behavior

Exception	Behavior
ARTIM Timeout	In case of association setup the job fails. The reason is logged and reported to the user.
Reply timeout	The action fails and the association is aborted. The reason is logged and reported to the user.
Association timeout SCU	The association is released.
Association aborted	The action fails. The reason is logged and reported to the user.

4.2.1.3. Association Initiation Policy

The Application Entity will response on a received reject Association attempts as shown in next table.

Note: during association negotiation the ACP AE will propose presentation context for all SOP classes as configured for the associated SCP.

Table 11: Association Rejection response

Result	Source	Reason/Diagnosis	Explanation
1 - rejected-permanent	1 - DICOM UL service-user	1 - no-reason-given	
		2 - application-context-name-not supported	
		3 - calling-AE-title-not-recognized	
		7 - called-AE-title-not-recognized	
	2 - DICOM UL service-provider (ACSE related function)	1 - no-reason-given	
		2 - protocol-version-not-supported	

Result	Source	Reason/Diagnosis	Explanation
2 - rejected-transient	3 - DICOM UL service-provider(Presentation related function)	1 - temporary-congestion	
		2 - Local-limit-exceeded	
	1 - DICOM UL service-user	1 - no-reason-given	
		2 - application-context-name-not-supported	
		3 - calling-AE-title-not-recognized	
	2 - DICOM UL service-provider (ACSE related function)	7 - called-AE-title-not-recognized	
		1 - no-reason-given	
3 - DICOM UL service-provider (Presentation related function)	2 - protocol-version-not-supported		
	1 - temporary congestion		
		2 - local-limit-exceeded	

The behavior of the AE on receiving an association abort is summarized in next table.

Table 12: Association Abort Handling

Source	Reason/Diagnosis	Behavior
0 - DICOM UL service-user (initiated abort)	0 - reason-not-specified	
2 - DICOM UL service-provider (initiated abort)	0 - reason-not-specified	
	1 - unrecognized-PDU	
	2 - unexpected-PDU	
	4 - unrecognized-PDU parameter	
	5 - unexpected-PDU parameter	
	6 - invalid-PDU-parameter value	

4.2.1.3.1. (Real-World) Activity – FIND As SCU

4.2.1.3.1.1. Description and Sequencing of Activities

This activity is part of Data Handling, which consists of:

- Archive
- Database Query
- Copy

The following figures show typical sequencing of Data Handling.

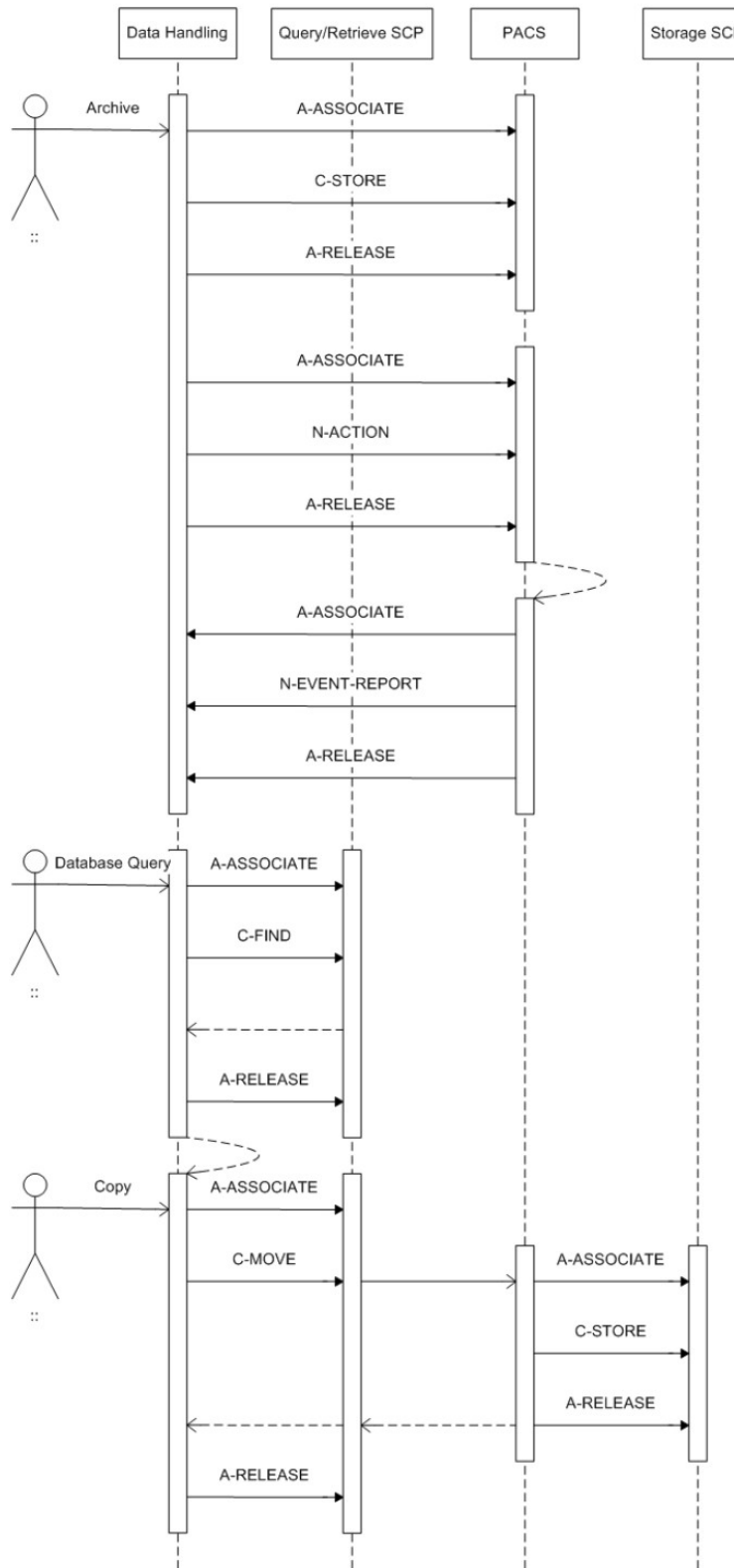

Figure 4: Sequencing of Data Handling (part 1)

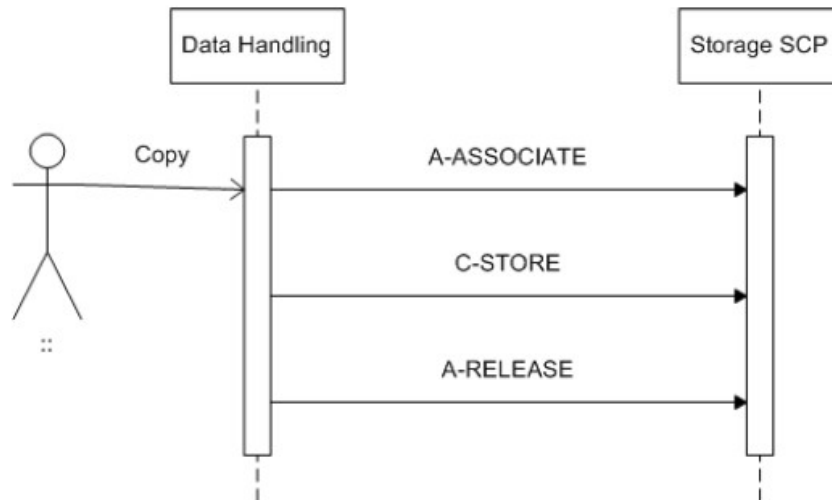

Figure 5: Sequencing of Data Handling (part 2)

The RWA Archive involves the storage and commitment of selected images, typically on a PACS (ref. Figure 6). The operator is able to archive the images selected in a patient folder from the local Eleva database. First the ACP AE initiates an association, stores the selected images from a patient, and releases the association. If storage commitment is configured, then the ACP AE initiates a new association, requests storage commitment for the stored images, and releases the association.

The storage commitment time-out can be configured for Eleva to support synchronous and/or asynchronous storage commitment event reporting.

The RWA Database Query involves the filtering of images in the selected database (ref. Figure 6). If the selected database is on a remote system, the ACP AE will use the Query/Retrieve service to show matching images in that database.

The ACP AE initiates an association to the selected peer entity and uses it to send Query (C-FIND) requests and receive the associated responses. The association is released when the query dialog is closed.

The RWA Copy involves the storage of images from one image database to another. There are three ways for the ACP AE to initiate the RWA Copy.

- The operator is able to copy the images selected in a patient folder from the local Eleva database to another database (ref. Figure 7). For each selected patient the ACP AE initiates an association to the selected peer entity, and uses it to send C-STORE requests and receive the associated C-STORE responses. Each association is released when all selected images in the selected folder of the actual patient have been transmitted. The ACP AE handles the copy requests one after another.
- The operator is able to copy the images selected in a patient folder from a remote database to another database (ref. Figure 6). For each selected patient the ACP AE initiates an association to the selected peer entity, uses it to send C-MOVE requests and receive the associated C-MOVE responses, and then releases the association. The ACP AE handles the copy requests one after another.

- A remote application is able to copy images from the local Eleva database to another database by sending a C-MOVE request to the ACP AE. For each received retrieve request the ACP AE initiates an association to the requested move destination and uses it to send C-STORE requests and receive the associated C-STORE responses (ref. Figure 7). The association is released when all instances, i.e. images and presentation states as selected by the retrieve request identifier, have been stored. The ACP AE is able to simultaneously handle multiple C-MOVE requests.

The export of images can be done as RAW data either as processed data, XA or RF.

Along with the image data the ACP AE also exports Presentation State data. If the SCP supports the Grayscale Softcopy Presentation State storage SOP class then the applicable presentation state data will be transferred as such, otherwise the presentation state data will be merged with the image data before export. Please refer to section 8.1.4 Coerced/Modified fields, for more information on Presentation State storage.

4.2.1.3.1.2. Proposed Presentation Contexts

The presentation contexts are defined in next table.

Table 13: Proposed Presentation Contexts for (Real-World) Activity – FIND As SCU

Presentation Context Table					
Abstract Syntax		Transfer Syntax		Role	Extended Negotiation
Name	UID	Name List	UID List		
Patient Root Query/Retrieve Information Model - FIND SOP Class	1.2.840.10008.5.1.4.1.2.1.1	Explicit VR Big Endian	1.2.840.10008.1.2.2	SCU	None
		Explicit VR Little Endian	1.2.840.10008.1.2.1		
		Implicit VR Little Endian	1.2.840.10008.1.2		
		JPEG Baseline (Process 1)	1.2.840.10008.1.2.4.50		
Patient/Study Only Query/Retrieve Info. Model - FIND SOP Class	1.2.840.10008.5.1.4.1.2.3.1	Explicit VR Big Endian	1.2.840.10008.1.2.2	SCU	None
		Explicit VR Little Endian	1.2.840.10008.1.2.1		
		Implicit VR Little Endian	1.2.840.10008.1.2		
		JPEG Baseline (Process 1)	1.2.840.10008.1.2.4.50		
Study Root Query/Retrieve Information Model - FIND SOP Class	1.2.840.10008.5.1.4.1.2.2.1	Explicit VR Big Endian	1.2.840.10008.1.2.2	SCU	None
		Explicit VR Little Endian	1.2.840.10008.1.2.1		
		Implicit VR Little Endian	1.2.840.10008.1.2		
		JPEG Baseline (Process 1)	1.2.840.10008.1.2.4.50		

Note: For performance reasons the ELE transfer syntax is preferred. Also note that JPEG Baseline is only supported for SOP instances with Photometric Interpretation of YBR_FULL_422.

4.2.1.3.1.3. SOP Specific Conformance for Patient Root Query/Retrieve Information Model - FIND SOP Class

This section and sub-section includes the manufacturer SOP and Dataset specific information as well the status codes and their corresponding behavior.

The ACP AE will not generate queries containing optional keys. The ACP AE will not generate relational queries.

4.2.1.3.1.3.1. Dataset Specific Conformance for Patient Root Q/R Information Model - FIND SOP Class SCU

Detail regarding the Dataset Specific response behavior will be reported in this section.

In the following table the supported query keys for each query level are described. Universal matching is supported as default.

Table 14: Supported Query Keys for Patient Root Information Model

Patient Root Information Model				
Attribute Name	Tag	VR	Type Of Matching	Comment
Query/Retrieve Level	0008,0052	CS		
Specific Character Set	0008,0005	CS		
Q/R Patient level				
Patient ID	0010,0020	LO	Universal, WildCard	Matching key
Patient's Birth Date	0010,0030	DA	Universal	
Patient's Name	0010,0010	PN	Universal, WildCard	Matching key
Patient's Sex	0010,0040	CS	Universal	
Q/R Study level (Patient Root)				
Accession Number	0008,0050	SH	Universal	
Referring Physician's Name	0008,0090	PN	Universal	
Study Date	0008,0020	DA	Universal	
Study ID	0020,0010	SH	Universal	
Study Instance UID	0020,000D	UI	Universal	
Study Time	0008,0030	TM	Universal	
Q/R Series level				
Modality	0008,0060	CS	Universal	
Performing Physician's Name	0008,1050	PN	Universal	
Protocol Name	0018,1030	LO	Universal	
Series Instance UID	0020,000E	UI	Universal	
Series Number	0020,0011	IS	Universal	
Q/R Image level				
Instance Number	0020,0013	IS	Universal	
SOP Instance UID	0008,0018	UI	Universal	

Note: the query results screen will display all patients that have an empty Patient ID as one patient entry.

This part of the section includes the dataset specific behavior, i.e. error codes, error and exception handling, time-outs, etc.

Table 15: Status Response

Service Status	Error Code	Further Meaning	Behavior
Success	0000	Matching is complete	The SCP has successfully returned all matching information
Failed	A700	Refused; out of resources	No find results are displayed. The reason is logged.
	A900	Identifier does not match SOP class	No find results are displayed. The reason is logged.
	Cxxx	Unable to process	No find results are displayed. The reason is logged.
Cancel	FE00	Matching terminated due to Cancel Reques	No find results are displayed. The reason is logged.
Pending	FF00	Matches are continuing - Current match is supplied and any optional keys were supported in the same manner as required keys	The find command continues.
	FF01	Matches are continuing - Warning that one or more optional keys were not supported for existence and/or matching for this identifier	The find command continues.

4.2.1.3.1.4. SOP Specific Conformance for Patient/Study Only Query/Retrieve Info. Model - FIND SOP Class

This section and sub-section includes the manufacturer SOP and Dataset specific information as well the status codes and their corresponding behavior.

The ACP AE will not generate queries containing optional keys. The ACP AE will not generate relational queries.

4.2.1.3.1.4.1. Dataset Specific Conformance for Patient/Study Only Q/R Information Model - FIND SOP Class SCU

Detail regarding the Dataset Specific response behavior will be reported in this section.

In the following table the supported query keys for each query level are described. Universal matching is supported as default.

Table 16: Supported Query Keys for Patient/Study Only Information Model

Patient/Study Only Information Model				
Attribute Name	Tag	VR	Type Of Matching	Comment
Query/Retrieve Level Specific Character Set	0008,0052	CS		
	0008,0005	CS		
Q/R Patient level				
Patient ID	0010,0020	LO	Universal, WildCard	Matching key
Patient's Birth Date	0010,0030	DA	Universal	
Patient's Name	0010,0010	PN	Universal, WildCard	Matching key
Patient's Sex	0010,0040	CS	Universal	
Q/R Study level (Patient Root)				
Accession Number	0008,0050	SH	Universal	
Referring Physician's Name	0008,0090	PN	Universal	
Study Date	0008,0020	DA	Universal	

Study Description	0008,1030	LO	Universal	
Study ID	0020,0010	SH	Universal	
Study Instance UID	0020,000D	UI	Universal	
Study Time	0008,0030	TM	Universal	

Note: the query results screen will display all patients that have an empty Patient ID as one patient entry.

This part of the section includes the dataset specific behavior, i.e. error codes, error and exception handling, time-outs, etc.

Table 17: Status Response

Service Status	Error Code	Further Meaning	Behavior
Success	0000	Matching is complete	The SCP has successfully returned all matching information
Failed	A700	Refused; out of resources	No find results are displayed. The reason is logged.
	A900	Identifier does not match SOP class	No find results are displayed. The reason is logged.
	Cxxx	Unable to process	No find results are displayed. The reason is logged.
Cancel	FE00	Matching terminated due to Cancel Request	No find results are displayed. The reason is logged.
Pending	FF00	Matches are continuing - Current match is supplied and any optional keys were supported in the same manner as required keys	The find command continues.
	FF01	Matches are continuing - Warning that one or more optional keys were not supported for existence and/or matching for this identifier	The find command continues.

4.2.1.3.1.5. SOP Specific Conformance for Study Root Query/Retrieve Information Model - FIND SOP Class

This section and sub-section includes the manufacturer SOP and Dataset specific information as well the status codes and their corresponding behavior.

The ACP AE will not generate queries containing optional keys. The ACP AE will not generate relational queries.

4.2.1.3.1.5.1. Dataset Specific Conformance for Study Root Q/R Information Model - FIND SOP Class SCU

Detail regarding the Dataset Specific response behavior will be reported in this section.

In the following table the supported query keys for each query level are described. Universal matching is supported as default.

Table 18: Supported Query Keys for Study Root Information Model

Study Root Information Model				
Attribute Name	Tag	VR	Type Of Matching	Comment
Query/Retrieve Level	0008,0052	CS		
Specific Character Set	0008,0005	CS		
Q/R Study level (Study Root)				
Accession Number	0008,0050	SH	Universal	
Referring Physician's Name	0008,0090	PN	Universal	
Study Date	0008,0020	DA	Universal	
Study Description	0008,1030	LO	Universal	
Study ID	0020,0010	SH	Universal	
Study Instance UID	0020,000D	UI	Universal	
Study Time	0008,0030	TM	Universal	
Q/R Series level				
Modality	0008,0060	CS	Universal	
Performing Physician's Name	0008,1050	PN	Universal	
Protocol Name	0018,1030	LO	Universal	
Series Instance UID	0020,000E	UI	Universal	
Series Number	0020,0011	IS	Universal	
Q/R Image level				
Instance Number	0020,0013	IS	Universal	
SOP Instance UID	0008,0018	UI	Universal	

Note: the query results screen will display all patients that have an empty Patient ID as one patient entry.

This part of the section includes the dataset specific behavior, i.e. error codes, error and exception handling, time-outs, etc.

Table 19: Status Response

Service Status	Error Code	Further Meaning	Behavior
Success	0000	Matching is complete	The SCP has successfully returned all matching information
Failed	A700	Refused; out of resources	No find results are displayed. The reason is logged.
	A900	Identifier does not match SOP class	No find results are displayed. The reason is logged.
	Cxxx	Unable to process	No find results are displayed. The reason is logged.
Cancel	FE00	Matching terminated due to Cancel Request	No find results are displayed. The reason is logged.
Pending	FF00	Matches are continuing - Current match is supplied and any optional keys were supported in the same manner as required keys	The find command continues.
	FF01	Matches are continuing - Warning that one or more optional keys were not supported for existence and/or matching for this identifier	The find command continues.

4.2.1.3.2. (Real-World) Activity – MOVE As SCU

4.2.1.3.2.1. Description and Sequencing of Activities

This activity is part of Data Handling. See chapter 4.2.1.3.1.1 for a description and sequence diagram.

4.2.1.3.2.2. Proposed Presentation Contexts

The presentation contexts are defined in next table.

Table 20: Proposed Presentation Contexts for (Real-World) Activity – MOVE As SCU

Presentation Context Table					
Abstract Syntax		Transfer Syntax		Role	Extended Negotiation
Name	UID	Name List	UID List		
Patient Root Query/Retrieve Information Model - MOVE SOP Class	1.2.840.10008.5.1.4.1.2.1.2	Explicit VR Big Endian	1.2.840.10008.1.2.2	SCU	None
		Explicit VR Little Endian	1.2.840.10008.1.2.1		
		Implicit VR Little Endian	1.2.840.10008.1.2		
		JPEG Baseline (Process 1)	1.2.840.10008.1.2.4.50		
Patient/Study Only Query/Retrieve Info. Model - MOVE SOP Class	1.2.840.10008.5.1.4.1.2.3.2	Explicit VR Big Endian	1.2.840.10008.1.2.2	SCU	None
		Explicit VR Little Endian	1.2.840.10008.1.2.1		
		Implicit VR Little Endian	1.2.840.10008.1.2		
		JPEG Baseline (Process 1)	1.2.840.10008.1.2.4.50		
Study Root Query/Retrieve Information Model - MOVE SOP Class	1.2.840.10008.5.1.4.1.2.2.2	Explicit VR Big Endian	1.2.840.10008.1.2.2	SCU	None
		Explicit VR Little Endian	1.2.840.10008.1.2.1		
		Implicit VR Little Endian	1.2.840.10008.1.2		
		JPEG Baseline (Process 1)	1.2.840.10008.1.2.4.50		

4.2.1.3.2.3. SOP Specific Conformance for Patient Root Query/Retrieve Information Model - MOVE SOP Class

This section and sub-section includes the manufacturer SOP and Dataset specific information as well the status codes and their corresponding behavior.

The ACP AE provides standard conformance.

4.2.1.3.2.3.1. Dataset Specific Conformance for Patient Root Q/R Information Model - MOVE SOP Class SCU

Detail regarding the Dataset Specific response behavior will be reported in this section.

This part of the section includes the dataset specific behavior, i.e. error codes, error and exception handling, time-outs, etc.

Table 21: Status Response

Service Status	Error Code	Further Meaning	Behavior
Success	0000	Sub-operations complete - No Failures	The move job is marked as completed. The association is released.

Service Status	Error Code	Further Meaning	Behavior
Failed	A701	Refused; out of resourced - Unable to calculate number of matches	The move job is marked as failed. The association is released. The reason is logged and reported to the user.
	A702	Refused; out of resources - Unable to perform sub-operations	The move job is marked as failed. The association is released. The reason is logged and reported to the user.
	A801	Refused; move destination unknown	The move job is marked as failed. The association is released. The reason is logged and reported to the user.
	A900	Identifier does not match SOP class	The move job is marked as failed. The association is released. The reason is logged and reported to the user.
	Cxxx	Unable to process	The move job is marked as failed. The association is released. The reason is logged and reported to the user.
Warning	B000	Sub-operations complete - One or more failures	The move job is marked as completed. The association is released.
Cancel	FE00	Sub-operations terminated due to Cancel Indication	The move job is marked as failed. The association is released. The reason is logged and reported to the user.
Pending	FF00	Sub-operations are continuing	The move job continues.

4.2.1.3.2.4. SOP Specific Conformance for Patient/Study Only Query/Retrieve Info. Model - MOVE SOP Class

This section and sub-section includes the manufacturer SOP and Dataset specific information as well the status codes and their corresponding behavior.

The ACP AE provides standard conformance.

4.2.1.3.2.4.1. Dataset Specific Conformance for Patient/Study Only Q/R Information Model - MOVE SOP Class SCU

Detail regarding the Dataset Specific response behavior will be reported in this section.

This part of the section includes the dataset specific behavior, i.e. error codes, error and exception handling, time-outs, etc.

Table 22: Status Response

Service Status	Error Code	Further Meaning	Behavior
Success	0000	Sub-operations complete - No Failures	The move job is marked as completed. The association is released.
Failed	A701	Refused; out of resources - Unable to calculate number of matches	The move job is marked as failed. The association is released. The reason is logged and reported to the user.
	A702	Refused; out of resources - Unable to perform sub-operations	The move job is marked as failed. The association is released. The reason is logged and reported to the user.
	A801	Refused; move destination unknown	The move job is marked as failed. The association is released. The reason is logged and reported to the user.
	A900	Identifier does not match SOP class	The move job is marked as failed. The association is released. The reason is logged and reported to the user.

Service Status	Error Code	Further Meaning	Behavior
	Cxxx	Unable to process	The move job is marked as failed. The association is released. The reason is logged and reported to the user.
Warning	B000	Sub-operations complete - One or more failures	The move job is marked as completed. The association is released.
Cancel	FE00	Sub-operations terminated due to Cancel Indication	The move job is marked as failed. The association is released. The reason is logged and reported to the user.
Pending	FF00	Sub-operations are continuing	The move job continues.

4.2.1.3.2.5. SOP Specific Conformance for Study Root Query/Retrieve Information Model - MOVE SOP Class

This section and sub-section includes the manufacturer SOP and Dataset specific information as well the status codes and their corresponding behavior.

The ACP AE provides standard conformance.

4.2.1.3.2.5.1. Dataset Specific Conformance for Study Root Query/Retrieve Information Model - MOVE SOP Class SCU

Detail regarding the Dataset Specific response behavior will be reported in this section.

This part of the section includes the dataset specific behavior, i.e. error codes, error and exception handling, time-outs, etc.

Table 23: Status Response

Service Status	Error Code	Further Meaning	Behavior
Success	0000	Sub-operations complete - No Failures	The move job is marked as completed. The association is released.
Failed	A701	Refused; out of resources - Unable to calculate number of matches	The move job is marked as failed. The association is released. The reason is logged and reported to the user.
	A702	Refused; out of resources - Unable to perform sub-operations	The move job is marked as failed. The association is released. The reason is logged and reported to the user.
	A801	Refused; move destination unknown	The move job is marked as failed. The association is released. The reason is logged and reported to the user.
	A900	Identifier does not match SOP class	The move job is marked as failed. The association is released. The reason is logged and reported to the user.
	Cxxx	Unable to process	The move job is marked as failed. The association is released. The reason is logged and reported to the user.
Warning	B000	Sub-operations complete - One or more failures	The move job is marked as completed. The association is released.
Cancel	FE00	Sub-operations terminated due to Cancel Indication	The move job is marked as failed. The association is released. The reason is logged and reported to the user.
Pending	FF00	Sub-operations are continuing	The move job continues.

4.2.1.3.3. (Real-World) Activity – Image Export

4.2.1.3.3.1. Description and Sequencing of Activities

This activity is part of Data Handling. See chapter 4.2.1.3.1.1 for a description and sequence diagram.

4.2.1.3.3.2. Proposed Presentation Contexts

The presentation contexts are defined in next table.

Table 24: Proposed Presentation Contexts for (Real-World) Activity – Image Export

Presentation Context Table					
Abstract Syntax		Transfer Syntax		Role	Extended Negotiation
Name	UID	Name List	UID List		
3D Object new Storage (Private)	1.3.46.670589.5.0.2.1	Explicit VR Big Endian	1.2.840.10008.1.2.2	SCU	None
		Explicit VR Little Endian	1.2.840.10008.1.2.1		
		Implicit VR Little Endian	1.2.840.10008.1.2		
3D Volume Storage new SOP Class (Private)	1.3.46.670589.5.0.1.1	Explicit VR Big Endian	1.2.840.10008.1.2.2	SCU	None
		Explicit VR Little Endian	1.2.840.10008.1.2.1		
		Implicit VR Little Endian	1.2.840.10008.1.2		
Cardio Image Storage new SOP Class (Private)	1.3.46.670589.5.0.8.1	Explicit VR Big Endian	1.2.840.10008.1.2.2	SCU	None
		Explicit VR Little Endian	1.2.840.10008.1.2.1		
		Implicit VR Little Endian	1.2.840.10008.1.2		
Computed Radiography Image Storage SOP Class	1.2.840.10008.5.1.4.1.1.1	Explicit VR Big Endian	1.2.840.10008.1.2.2	SCU	None
		Explicit VR Little Endian	1.2.840.10008.1.2.1		
		Implicit VR Little Endian	1.2.840.10008.1.2		
CT Image Storage SOP Class	1.2.840.10008.5.1.4.1.1.2	Explicit VR Big Endian	1.2.840.10008.1.2.2	SCU	None
		Explicit VR Little Endian	1.2.840.10008.1.2.1		
		Implicit VR Little Endian	1.2.840.10008.1.2		
CT Synthetic Image Storage (Private)	1.3.46.670589.5.0.9	Explicit VR Big Endian	1.2.840.10008.1.2.2	SCU	None
		Explicit VR Little Endian	1.2.840.10008.1.2.1		
		Implicit VR Little Endian	1.2.840.10008.1.2		
CX Synthetic Image Storage (Private)	1.3.46.670589.5.0.12	Explicit VR Big Endian	1.2.840.10008.1.2.2	SCU	None
		Explicit VR Little Endian	1.2.840.10008.1.2.1		
		Implicit VR Little Endian	1.2.840.10008.1.2		
Digital X-Ray Image Storage - For Pres. SOP	1.2.840.10008.5.1.4.1.1.1.1	Explicit VR Big Endian	1.2.840.10008.1.2.2	SCU	None
		Explicit VR Little Endian	1.2.840.10008.1.2.1		
		Implicit VR Little Endian	1.2.840.10008.1.2		
MR Cardio Analysis new Storage (Private)	1.3.46.670589.5.0.11.1	Explicit VR Big Endian	1.2.840.10008.1.2.2	SCU	None
		Explicit VR Little Endian	1.2.840.10008.1.2.1		
		Implicit VR Little Endian	1.2.840.10008.1.2		
MR Image Storage SOP Class	1.2.840.10008.5.1.4.1.1.4	Explicit VR Big Endian	1.2.840.10008.1.2.2	SCU	None
		Explicit VR Little Endian	1.2.840.10008.1.2.1		
		Implicit VR Little Endian	1.2.840.10008.1.2		
MR Synthetic Image Storage (Private)	1.3.46.670589.5.0.10	Explicit VR Big Endian	1.2.840.10008.1.2.2	SCU	None
		Explicit VR Little Endian	1.2.840.10008.1.2.1		
		Implicit VR Little Endian	1.2.840.10008.1.2		
Nuclear Medicine Image Storage SOP Class	1.2.840.10008.5.1.4.1.1.20	Explicit VR Big Endian	1.2.840.10008.1.2.2	SCU	None
		Explicit VR Little Endian	1.2.840.10008.1.2.1		
		Implicit VR Little Endian	1.2.840.10008.1.2		
Perfusion (Private)	1.3.46.670589.5.0.13	Explicit VR Big Endian	1.2.840.10008.1.2.2	SCU	None
		Explicit VR Little Endian	1.2.840.10008.1.2.1		
		Implicit VR Little Endian	1.2.840.10008.1.2		

Presentation Context Table					
Abstract Syntax		Transfer Syntax		Role	Extended Negotiation
Name	UID	Name List	UID List		
Perfusion Image Storage (Private)	1.3.46.670589.5.0.14	Explicit VR Big Endian	1.2.840.10008.1.2.2	SCU	None
		Explicit VR Little Endian	1.2.840.10008.1.2.1		
		Implicit VR Little Endian	1.2.840.10008.1.2		
Secondary Capture Image Storage SOP Class	1.2.840.10008.5.1.4.1.1.7	Explicit VR Big Endian	1.2.840.10008.1.2.2	SCU	None
		Explicit VR Little Endian	1.2.840.10008.1.2.1		
		Implicit VR Little Endian	1.2.840.10008.1.2		
Softcopy Presentation State Storage SOP Class	1.2.840.10008.5.1.4.1.1.11.1	Explicit VR Big Endian	1.2.840.10008.1.2.2	SCU	None
		Explicit VR Little Endian	1.2.840.10008.1.2.1		
		Implicit VR Little Endian	1.2.840.10008.1.2		
Specialized PMS X-Ray Image Store	1.3.46.670589.2.3.1.1	Explicit VR Big Endian	1.2.840.10008.1.2.2	SCU	None
		Explicit VR Little Endian	1.2.840.10008.1.2.1		
		Implicit VR Little Endian	1.2.840.10008.1.2		
Surface Storage new (Private)	1.3.46.670589.5.0.3.1	Explicit VR Big Endian	1.2.840.10008.1.2.2	SCU	None
		Explicit VR Little Endian	1.2.840.10008.1.2.1		
		Implicit VR Little Endian	1.2.840.10008.1.2		
Ultrasound Image Storage SOP Class	1.2.840.10008.5.1.4.1.1.6.1	Explicit VR Big Endian	1.2.840.10008.1.2.2	SCU	None
		Explicit VR Little Endian	1.2.840.10008.1.2.1		
		Implicit VR Little Endian	1.2.840.10008.1.2		
Ultrasound Multi-frame Image Storage SOP Class	1.2.840.10008.5.1.4.1.1.3.1	Explicit VR Big Endian	1.2.840.10008.1.2.2	SCU	None
		Explicit VR Little Endian	1.2.840.10008.1.2.1		
		Implicit VR Little Endian	1.2.840.10008.1.2		
X-Ray Angiographic Image Storage SOP Class	1.2.840.10008.5.1.4.1.1.12.1	Explicit VR Big Endian	1.2.840.10008.1.2.2	SCU	None
		Explicit VR Little Endian	1.2.840.10008.1.2.1		
		Implicit VR Little Endian	1.2.840.10008.1.2		
X-Ray Radiofluoroscopic Image Storage SOP Class	1.2.840.10008.5.1.4.1.1.12.2	Explicit VR Big Endian	1.2.840.10008.1.2.2	SCU	None
		Explicit VR Little Endian	1.2.840.10008.1.2.1		
		Implicit VR Little Endian	1.2.840.10008.1.2		
XA reconstructed X-ray SOP Class (private)	1.3.46.670589.2.4.1.1	Explicit VR Big Endian	1.2.840.10008.1.2.2	SCU	None
		Explicit VR Little Endian	1.2.840.10008.1.2.1		
		Implicit VR Little Endian	1.2.840.10008.1.2		

4.2.1.3.3.3. SOP Specific Conformance for Storage SOP Classes

This section and sub-section includes the manufacturer SOP and Dataset specific information as well the status codes and their corresponding behavior.

Important remarks about the exported images

- In case the remote system does not support modality specific image storage SOP class, the ACP AE will convert the images (if configured to do so) and send them via the Secondary Capture image storage SOP class.

These Secondary Capture images and additional information (like graphics, text and important attribute information) are burnt-in (if configured). The original bit depth of the Secondary Capture image is kept.

Note: Only standard DICOM images can be converted; standard extended, specialized, and private SOP classes cannot be converted.
- A Specialized PMS X-Ray Image Store SOP instance may be converted into a standard DICOM X-Ray Radiofluoroscopic Image Storage SOP instance. When converting an image, the ACP AE will each time create a new SOP

Instance UID; after export the converted image will be omitted and its UID will not reoccur on subsequent conversions.

- In case of color images, all color-coding schemes are sent as they were received.
- Attributes e.g. Study Date and Study Time will be added to images to be exported (if not yet present). This is done because there are imaging systems relying on the existence of these attributes.
- The ACP AE allows the operator to modify attributes of the stored images. ACP AE does not modify the pixel values of the stored images. Modified images retain their original Study, Series and Image UID.
- On the export of an imported image the ACP AE adds private attributes to the image.
- The exported ACP AE images do not contain Instance Number if the original images received from modalities do not contain this attribute or provide information in other attributes for ACP AE to generate it.
- Exported CT/MR images relate Scanogram and Slice images in the following way: Attribute 'Referenced Image Sequence' is present in the slice images and points to the related Scanogram image. Note that Attribute 'Frame of Reference UID' in the Scanogram (Localiser image) and related image slices are not guaranteed to be equal; this depends on the source of the images.
- For Secondary Capture images only one Window Width and Window Centre value is exported.
- Please refer to section 8.1.4 Coerced / Modified fields, for more information on stored images.
- When the location of a graphic or text annotation is specified relatively with regards to the displayed area. (i.e. DICOM attribute: Bounding Box Annotation Units, Anchor Point Annotation Units or Graphic Annotation Units equals "DISPLAY"), the annotation is not displayed.
- Areas occluded by Shutter are always black in ACP AE, whereas it is possible to want it to be white in DICOM.
- On the export of such an image the ACP AE first sets up an association to determine if the SCP supports the Grayscale Softcopy Presentation State SOP Class. If the SCP doesn't supports the Grayscale Softcopy Presentation State service the Graphical information is added to the image object additional a new instance UID is generated for this image.
- All kind of Images sending out, are included with Performed Procedure Step Tags like: (Start Date, Start Time, ID).

Use of optional, private and retired attributes

The transmitted Storage SOP instances may include all optional elements specified in the DICOM standard, depending on the source of the images. The transmitted Storage SOP instances may contain Retired and Private data elements, depending on the source of the images and of the ACP AE configuration. The ACP AE can convert the transfer syntax when exporting images. The ACP AE can implement transfer syntaxes according to the following table.

Table 25: Transfer Syntax Conversion

Syntax	Source	ILE	ELE	EBE	JPEG Baseline
Destination	+	+	+	+	-
ILE	+	+	+	+	-
ELE	+	+	+	+	-
EBE	+	+	+	+	-
JPEG Baseline	+	+	+	+	-

Notes:

- JPEG Baseline is only supported for images with Photometric Interpretation of YBR_FULL_422.
- As ACP AE internally stores the images in uncompressed format, the image data will be compressed to JPEG (RGB to YBR_FULL_422) before export.

4.2.1.3.3.3.1. Dataset Specific Conformance for C-STORE-RQ

Detail regarding the Dataset Specific response behavior will be reported in this section.

This includes the dataset specific behavior, i.e. error codes, error and exception handling, time-outs, etc.

Table 26: Status Response

Service Status	Error Code	Further Meaning	Behavior
Success	0000	Storage is complete	Continues with next store until completed. Then the store job is marked as completed and the association is released.
Failure	A7xx	Refused: Out of Resources	The store job fails and the association is released. The reason is logged and reported to the user.
	A9xx	Error: Data Set does not match SOP class	The store job fails and the association is released. The reason is logged and reported to the user.
	Cxxx	Error: cannot understand	The store job fails and the association is released. The reason is logged and reported to the user.
Warning	B000	Coercion of Data Elements	Continues with next store until completed. Then the store job is marked as completed and the association is released.
	B007	Data Set does not match SOP Class	Continues with next store until completed. Then the store job is marked as completed and the association is released.
	B006	Elements Discarded	Continues with next store until completed. Then the store job is marked as completed and the association is released.

4.2.1.3.4. (Real-World) Activity – Storage Commitment Push Model AS SCU**4.2.1.3.4.1. Description and Sequencing of Activities**

The ACP AE will act as a Storage Commitment SCU for the configured Storage Commitment SCP to receive asynchronous storage commitment reports from storage commitment requests send by the ACP AE Data Handling (as Storage Commitment SCU), using a negotiated presentation context.

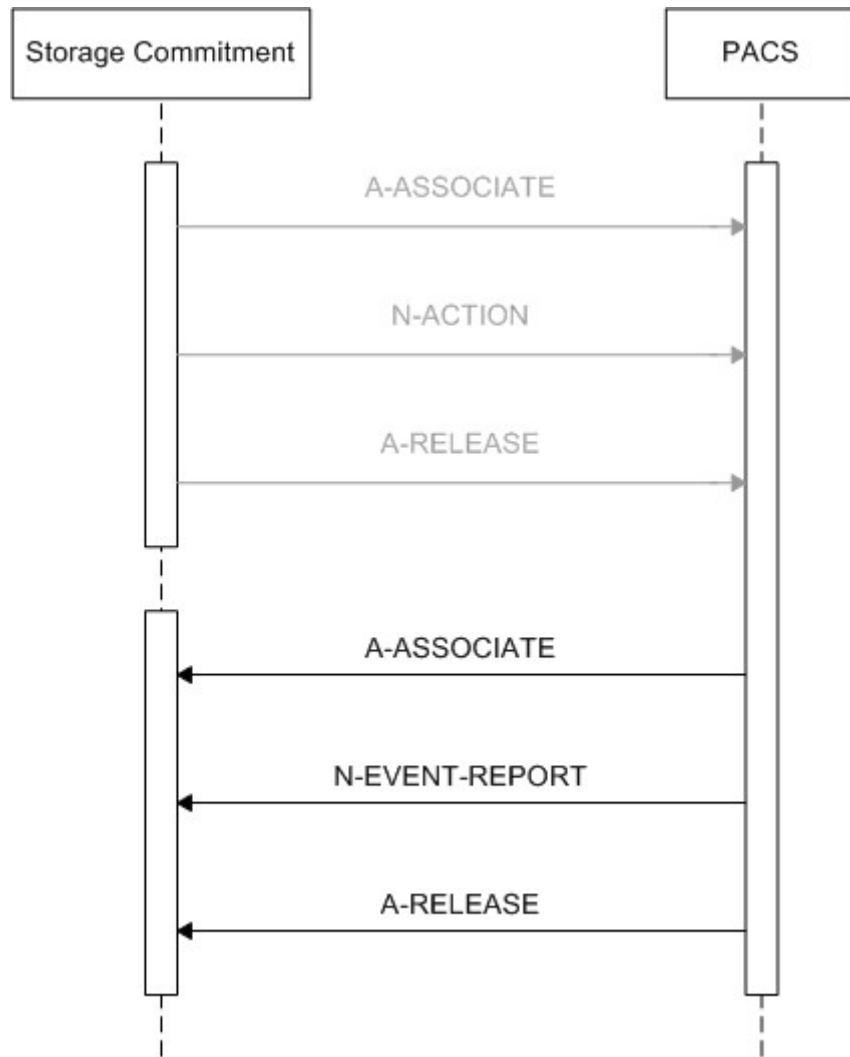

Figure 6: Sequencing of Storage Commitment

After the ACP AE accepts an association from the remote Storage Commitment SCP it will receive storage commitment reports, send responses including the relevant status, and finally release the association on SCP request.

4.2.1.3.4.2. Proposed Presentation Contexts

The presentation contexts are defined in next table.

Table 27: Proposed Presentation Contexts for (Real-World) Activity – Storage Commitment Push Model AS SCU

Presentation Context Table					
Abstract Syntax		Transfer Syntax		Role	Extended Negotiation
Name	UID	Name List	UID List		
Storage Commitment Push Model SOP Class	1.2.840.10008.1.20.1	Explicit VR Big Endian	1.2.840.10008.1.2.2	SCU	None
		Explicit VR Little Endian	1.2.840.10008.1.2.1		
		Implicit VR Little Endian	1.2.840.10008.1.2		

For performance reasons the ELE transfer syntax is preferred and will be chosen in case multiple transfer syntaxes are proposed in the association negotiation.

The ACP AE accepts all contexts in the intersection of the proposed and acceptable presentation contexts. This means that the ACP AE accepts multiple proposed presentation contexts with the same SOP class but different transfer syntaxes. There is no check for duplicate contexts, and these will therefore be accepted.

4.2.1.3.4.3. SOP Specific Conformance for Storage Commitment Push Model SOP Class

This section and sub-section includes the manufacturer SOP and Dataset specific information as well the status codes and their corresponding behavior.

The ACP AE provides standard conformance. For the ACP AE many remote nodes can be configured as Storage SCP. Each of those remote nodes can be configured to assign one Storage Commitment SCP for storage commitment.

4.2.1.3.4.3.1. Dataset Specific Conformance for Storage Commitment Push Model N-ACTION SCU

Detail regarding the Dataset Specific response behavior will be reported in this section.

This part of the section includes the dataset specific behavior, i.e. error codes, error and exception handling, time-outs, etc.

Table 28: Status Response

Service Status	Error Code	Further Meaning	Behavior
Success	0000	Operation complete	Continues with waiting for storage commitment.
Failure	xxxx	(any failure)	The reason is logged.

4.2.1.3.4.3.2. Dataset Specific Conformance for Storage Commitment Push Model N-EVENT-REPORT SCU

Detail regarding the Dataset Specific response behavior will be reported in this section.

This part of the section includes the dataset specific behavior, i.e. error codes, error and exception handling, time-outs, etc.

Table 29: Storage Commitment attribute for N-EVENT-REPORT

Event Type Name	EVENT Type ID	Attribute Name	Tag	Commit
StorageCommitmentRequestSuccessful	1	Transaction UID	0008,1195	
		Referenced SOP Sequence	0008,1199	
		>Referenced SOP Class UID	0008,1150	
		>Referenced SOP Instance UID	0008,1155	
StorageCommitmentRequestCompleteFailures	1	Transaction UID	0008,1195	

Event Type Name	EVENT Type ID	Attribute Name	Tag	Commit
Exist		Referenced SOP Sequence	0008,1199	
		>Referenced SOP Class UID	0008,1150	
		>Referenced SOP Instance UID	0008,1155	
	2	Transaction UID	0008,1195	
		Failed SOP Sequence	0008,1198	
		>Referenced SOP Class UID	0008,1150	
		>Referenced SOP Instance UID	0008,1155	
		>Failure Reason	0008,1197	

On receiving a storage commitment result with Event Type ID 1 (Storage Commitment Request Successful) the Application Entity will mark this images as committed.
 On receiving a storage commitment result with Event Type ID 2 (Storage Commitment Request Complete - Failures Exist) the Application Entity will behave as found in next table.

Table 30: Storage Commitment N-EVENT-REPORT Failure Handling Behavior

ServiceStatus	ErrorCode	Further Meaning	Description
Failure	0110	Processing Failure	The user is notified via pop-up. Retry storage commitment request. log entry

Table 31: Status Response

Service Status	Error Code	Further Meaning	Behavior
Success	0000	Verification is complete	Successful received

4.2.1.3.5. (Real-World) Activity – Print Management As SCU

4.2.1.3.5.1. Description and Sequencing of Activities

This real world activity comprises the following actions.

- Print;
- Request Printer Status.

The following figure shows the typical sequencing of printing.

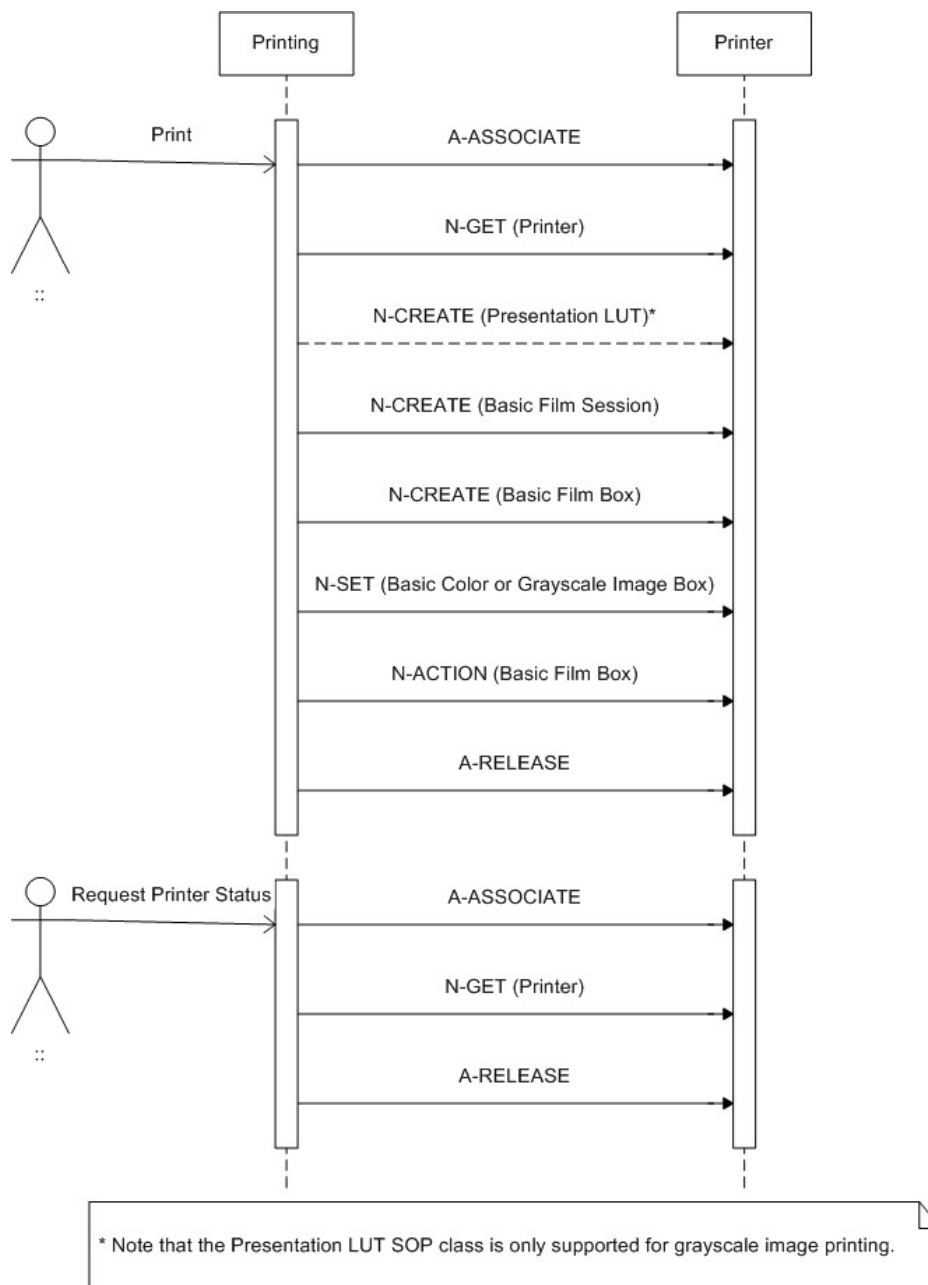

Figure 7: Sequencing of Printing

The RWA Print involves the printing of images by sending the selected images to a Print Management SCP (i.e. DICOM printer). After selecting the print destination (from a list of configured printers) and some print parameters (depending on the configuration and the selected printer) the ACP AE initiates an association to the selected printer and uses it to send the print job.

The ACP AE also has an option for print preview.

The RWA Request Printer Status involves the request for the printer status of the configured printers. The ACP AE will periodically request the printer status. If an association already exists for a print job (RWA Print) then the ACP AE uses this association, otherwise a new association will be initiated.

The status codes as returned by the printer are logged for service purposes and will

not be shown on the GUI.

The Printer Status Tool may be used to reveal the received printer status.

4.2.1.3.5.2. Proposed Presentation Contexts

The presentation contexts are defined in next table.

Table 32: Proposed Presentation Contexts for (Real-World) Activity – Print Management As SCU

Presentation Context Table					
Abstract Syntax		Transfer Syntax		Role	Extended Negotiation
Name	UID	Name List	UID List		
Presentation LUT SOP Class	1.2.840.10008.5.1.1.23	Explicit VR Big Endian	1.2.840.10008.1.2.2	SCU	None
		Explicit VR Little Endian	1.2.840.10008.1.2.1		
		Implicit VR Little Endian	1.2.840.10008.1.2		
Basic Color Print Management Meta SOP Class	1.2.840.10008.5.1.1.18			SCU	None
>Basic Color Image Box SOP Class	1.2.840.10008.5.1.1.4.1	Explicit VR Big Endian	1.2.840.10008.1.2.2	SCU	None
		Explicit VR Little Endian	1.2.840.10008.1.2.1		
		Implicit VR Little Endian	1.2.840.10008.1.2		
>Basic Film Box SOP Class	1.2.840.10008.5.1.1.2	Explicit VR Big Endian	1.2.840.10008.1.2.2	SCU	None
		Explicit VR Little Endian	1.2.840.10008.1.2.1		
		Implicit VR Little Endian	1.2.840.10008.1.2		
>Basic Film Session SOP Class	1.2.840.10008.5.1.1.1	Explicit VR Big Endian	1.2.840.10008.1.2.2	SCU	None
		Explicit VR Little Endian	1.2.840.10008.1.2.1		
		Implicit VR Little Endian	1.2.840.10008.1.2		
>Printer SOP Class	1.2.840.10008.5.1.1.16	Explicit VR Big Endian	1.2.840.10008.1.2.2	SCU	None
		Explicit VR Little Endian	1.2.840.10008.1.2.1		
		Implicit VR Little Endian	1.2.840.10008.1.2		
Basic Grayscale Print Management Meta SOP Class	1.2.840.10008.5.1.1.9			SCU	None
>Basic Film Box SOP Class	1.2.840.10008.5.1.1.2	Explicit VR Big Endian	1.2.840.10008.1.2.2	SCU	None
		Explicit VR Little Endian	1.2.840.10008.1.2.1		
		Implicit VR Little Endian	1.2.840.10008.1.2		
>Basic Film Session SOP Class	1.2.840.10008.5.1.1.1	Explicit VR Big Endian	1.2.840.10008.1.2.2	SCU	None
		Explicit VR Little Endian	1.2.840.10008.1.2.1		
		Implicit VR Little Endian	1.2.840.10008.1.2		
>Basic Grayscale Image Box SOP Class	1.2.840.10008.5.1.1.4	Explicit VR Big Endian	1.2.840.10008.1.2.2	SCU	None
		Explicit VR Little Endian	1.2.840.10008.1.2.1		
		Implicit VR Little Endian	1.2.840.10008.1.2		
>Printer SOP Class	1.2.840.10008.5.1.1.16	Explicit VR Big Endian	1.2.840.10008.1.2.2	SCU	None
		Explicit VR Little Endian	1.2.840.10008.1.2.1		
		Implicit VR Little Endian	1.2.840.10008.1.2		

Note: for performance reasons the ELE transfer syntax is preferred.

This section specifies each IOD created (including private IOD's).

Abbreviations used in the Module table for the column "Presence of Value" are:

ALWAYS The attribute is always present with a value

EMPTY The attribute is always present without any value (attribute sent zero length)

VNAP The attribute is always present and its Value is Not Always Present (attribute sent zero length if no value is present)

ANAP	The attribute is present under specified condition – if present then it will always have a value
VNAPCV	The attribute is present under specified condition – if present then its Value is Not Always Present (attribute sent zero length if condition applies and no value is present)
ANAPEV	The attribute is present under specified condition – if present then it will not have any value

The abbreviations used in the Module table for the column "Source" are:

AUTO	The attribute value is generated automatically
CONFIG	The attribute value source is a configurable parameter
COPY	The attribute value source is another SOP instance
FIXED	The attribute value is hard-coded in the application
IMPLICIT	The attribute value source is a user-implicit setting
MPPS	The attribute value is the same as that use for Modality Performed Procedure Step
MWL	The attribute value source is a Modality Worklist
USER	The attribute value source is explicit user input

4.2.1.3.5.3. SOP Specific Conformance for Presentation LUT SOP Class

This section and sub-section includes the manufacturer SOP and Dataset specific information as well the status codes and their corresponding behavior.

4.2.1.3.5.3.1. Dataset Specific Conformance for Presentation LUT SOP Class N-CREATE SCU

Detail regarding the Dataset Specific response behavior will be reported in this section.

Table 33: Presentation LUT Module

Attribute Name	Tag	VR	Value	Presence of Value	Source	Comment
Presentation LUT Shape	2050,0020	CS	IDENTITY	ALWAYS	FIXED	

This part of the section includes the dataset specific behavior, i.e. error codes, error and exception handling, time-outs, etc.

Table 34: Status Response

Service Status	Error Code	Further Meaning	Behavior
Success	0000	Presentation LUT successfully created	The print job continues.
Warning	B605	Requested Min Density or Max Density outside of printer's operating range. The printer will use its respective minimum or maximum density value instead.	The print job continues and the warning is logged.

4.2.1.3.5.4. SOP Specific Conformance for Basic Color Image Box SOP Class of the Basic Color Print Management Meta SOP Class

This section and sub-section includes the manufacturer SOP and Dataset specific information as well the status codes and their corresponding behavior.

4.2.1.3.5.4.1. Dataset Specific Conformance for Basic Color Image Box N-SET SCU

Detail regarding the Dataset Specific response behavior will be reported in this section.

Table 35: Image Box Pixel Presentation Module

Attribute Name	Tag	VR	Value	Presence of Value	Source	Comment
Image Position	2020,0010	US	1	ALWAYS	FIXED	
Polarity	2020,0020	CS	NORMAL	ALWAYS	FIXED	
Basic Color Image Sequence	2020,0111	SQ		ALWAYS	AUTO	
>Bits Allocated	0028,0100	US	8	ALWAYS	FIXED	
>Bits Stored	0028,0101	US	8	ALWAYS	FIXED	
>Columns	0028,0011	US		ALWAYS	COPY	
>High Bit	0028,0102	US	7	ALWAYS	FIXED	
>Photometric Interpretation	0028,0004	CS	RGB	ALWAYS	FIXED	
>Pixel Data	7FE0,0010	O W/ OB		ALWAYS	COPY	
>Pixel Representation	0028,0103	US	0	ALWAYS	FIXED	
>Planar Configuration	0028,0006	US	0, 1	ALWAYS	COPY	
>Rows	0028,0010	US		ALWAYS	COPY	
>Samples per Pixel	0028,0002	US	3	ALWAYS	FIXED	

This part of the section includes the dataset specific behavior, i.e. error codes, error and exception handling, time-outs, etc.

Table 36: Status Response

Service Status	Error Code	Further Meaning	Behavior
Success	0000	Image successfully stored in Image Box	The print job continues.
Warning	B604	Image Size is larger than Image Box Size - the image has been de-magnified	The print job continues and the warning is logged and reported to the user.
	B605	Requested Min Density or Max Density outside of printer's operating range	The print job continues and the warning is logged and reported to the user.
	B609	Image Size is larger than Image Box Size - the image has been cropped to fit	The print job continues and the warning is logged and reported to the user.
	B60A	Image Size or combined Print Image Size is larger than Image Box Size - the image or combined print image has been decimated to fit	The print job continues and the warning is logged and reported to the user.
Failure	C603	Image Size is larger than Image Box Size	The print job is marked as failed and the reason is logged and reported to the user.
	C605	Insufficient memory in printer to store the image	The print job is marked as failed and the reason is logged and reported to the user.
	C613	Combined Print Image Size is larger than Image Box Size	The print job is marked as failed and the reason is logged and reported to the user.

4.2.1.3.5.5. SOP Specific Conformance for Basic Film Box SOP Class of the Basic Color Print Management Meta SOP Class

This section and sub-section includes the manufacturer SOP and Dataset specific information as well the status codes and their corresponding behavior.

4.2.1.3.5.5.1. Dataset Specific Conformance for Basic Film Box N-ACTION SCU

Detail regarding the Dataset Specific response behavior will be reported in this section.

This part of the section includes the dataset specific behavior, i.e. error codes, error and exception handling, time-outs, etc.

Table 37: Status Response

Service Status	Error Code	Further Meaning	Behavior
Success	0000	Film accepted for printing	The print job continues.
Warning	B603	Film Box SOP Instance Hierarchy does not contain Image Box SOP instances	The print job continues and the warning is logged and reported to the user.
	B604	Image Size is larger than Image Box Size - the image has been de-magnified	The print job continues and the warning is logged and reported to the user.
	B609	Image Size is larger than Image Box Size - the image has been cropped to fit	The print job continues and the warning is logged and reported to the user.
	B60A	Image Size or combined Print Image Size is larger than Image Box Size - the image or combined print image has been decimated to fit	The print job continues and the warning is logged and reported to the user.
Failure	C602	Unable to create Print Job SOP instance - print queue is full	The print job is marked as failed and the reason is logged and reported to the user.
	C603	Image Size is larger than Image Box Size	The print job is marked as failed and the reason is logged and reported to the user.
	C613	Combined Print Image Size is larger than Image Box Size	The print job is marked as failed and the reason is logged and reported to the user.

4.2.1.3.5.5.2. Dataset Specific Conformance for Basic Film Box N-CREATE SCU

Detail regarding the Dataset Specific response behavior will be reported in this section.

Table 38: Basic Film Box Presentation Module

Attribute Name	Tag	VR	Value	Presence of Value	Source	Comment
Configuration Information	2010,0150	ST	L=1, L=V	ALWAYS	CONFIG	
Film Orientation	2010,0040	CS	LANDSCAPE, PORTRAIT, PORTRAIT, LANDSCAPE	ALWAYS	CONFIG	

Film Size ID	2010,0050	CS	10INX12IN, 10INX14IN, 11INX14IN, 11INX17IN, 14INX14IN, 14INX17IN, 24CMX24CM, 24CMX30CM, 8_5INX11IN, 8INX10IN, A3, A4	ALWAYS	CONFIG	
Image Display Format	2010,0010	ST	CUSTOM\1, STANDARD\1,1	ALWAYS	CONFIG	
Magnification Type	2010,0060	CS		ALWAYS	USER	
Max Density	2010,0130	US		VNAP	CONFIG	
Trim	2010,0140	CS	NO, YES	VNAP	CONFIG	

Table 39: Basic Film Box Relationship Module

Attribute Name	Tag	VR	Value	Presence of Value	Source	Comment
Referenced Film Session Sequence	2010,0500	SQ		ALWAYS	AUTO	
>Referenced SOP Class UID	0008,1150	UI	1.2.840.10008.5.1.1.1	ALWAYS	FIXED	
>Referenced SOP Instance UID	0008,1155	UI		ALWAYS	AUTO	UID of parent Film Session
Referenced Presentation LUT Sequence	2050,0500	SQ		ALWAYS	AUTO	
>Referenced SOP Class UID	0008,1150	UI	1.2.840.10008.5.1.1.23	ALWAYS	FIXED	
>Referenced SOP Instance UID	0008,1155	UI		ALWAYS	AUTO	UID of parent Presentation LUT

This part of the section includes the dataset specific behavior, i.e. error codes, error and exception handling, time-outs, etc.

Table 40: Status Response

Service Status	Error Code	Further Meaning	Behavior
Success	0000	Successful operation	The print job continues.
Warning	B605	Requested Min Density or Max Density outside of printer's operating range	The print job continues and the warning is logged
Failed	C616	There is an existing Film Box that has not been printed	The print job is marked as failed and the reason is logged.

4.2.1.3.5.6. SOP Specific Conformance for Basic Film Session SOP Class of the Basic Color Print Management Meta SOP Class

This section and sub-section includes the manufacturer SOP and Dataset specific information as well the status codes and their corresponding behavior.

4.2.1.3.5.6.1. Dataset Specific Conformance for Basic Film Session N-CREATE SCU

Detail regarding the Dataset Specific response behavior will be reported in this section.

Table 41: Basic Film Session Presentation Module

Attribute Name	Tag	VR	Value	Presence of Value	Source	Comment
Film Destination	2000,0040	CS	MAGAZINE, PROCESSOR	ALWAYS	IMPLICIT	
Film Session Label	2000,0050	LO	Philips Medical Systems	ALWAYS	FIXED	
Medium Type	2000,0030	CS	BLUE FILM, CLEAR FILM, PAPER	ALWAYS	IMPLICIT	
Number of Copies	2000,0010	IS	1 to 99	ALWAYS	IMPLICIT, USER	
Print Priority	2000,0020	CS	HIGH, LOW, MED	ALWAYS	IMPLICIT	

This part of the section includes the dataset specific behavior, i.e. error codes, error and exception handling, time-outs, etc.

Table 42: Status Response

Service Status	Error Code	Further Meaning	Behavior
Success	0000	Film Session successfully created	The print job continues.
Warning	B600	Memory Allocation not supported	The print job continues and the warning is logged.

4.2.1.3.5.7. SOP Specific Conformance for Printer SOP Class of the Basic Color Print Management Meta SOP Class

This section and sub-section includes the manufacturer SOP and Dataset specific information as well the status codes and their corresponding behavior.

4.2.1.3.5.7.1. Dataset Specific Conformance for Printer N-GET SCU

Detail regarding the Dataset Specific response behavior will be reported in this section.

Table 43: Printer Module

Attribute Name	Tag	VR	Value	Presence of Value	Source	Comment
Device Serial Number	0018,1000	LO		ANAPEV	FIXED	
Manufacturer	0008,0070	LO		ANAPEV	FIXED	
Manufacturer's Model Name	0008,1090	LO		ANAPEV	FIXED	
Printer Name	2110,0030	LO		ANAPEV	FIXED	
Printer Status	2110,0010	CS		ANAPEV	FIXED	
Printer Status Info	2110,0020	CS		ANAPEV	FIXED	
Software Version(s)	0018,1020	LO		ANAPEV	FIXED	

This part of the section includes the dataset specific behavior, i.e. error codes, error and exception handling, time-outs, etc.

Table 44: Status Response

Service Status	Error Code	Further Meaning	Behavior
Success	0000	Successful operation	The print job continues.
Warning	xxxx	Any warning	The print job continues and the warning is logged.
Failed	xxxx	Any failure	The print job is marked as failed and the reason is logged and reported to the user.

4.2.1.3.5.7.2. Dataset Specific Conformance for Printer N-EVENT-REPORT SCU

Detail regarding the Dataset Specific response behavior will be reported in this section.

This part of the section includes the dataset specific behavior, i.e. error codes, error and exception handling, time-outs, etc.

Table 45: Status Response

Service Status	Error Code	Further Meaning	Behavior
Success	0000	Successful operation	The print job continues.
Warning	xxxx	Any warning	The print job continues and the warning is logged and reported to the user.
Failed	xxxx	Any failure	The print job is marked as failed and the reason is logged and reported to the user.

4.2.1.3.5.8. SOP Specific Conformance for Basic Film Box SOP Class of the Basic Grayscale Print Management Meta SOP Class

This section and sub-section includes the manufacturer SOP and Dataset specific information as well the status codes and their corresponding behavior.

4.2.1.3.5.8.1. Dataset Specific Conformance for Basic Film Box N-ACTION SCU

Detail regarding the Dataset Specific response behavior will be reported in this section.

This part of the section includes the dataset specific behavior, i.e. error codes, error and exception handling, time-outs, etc.

Table 46: Status Response

Service Status	Error Code	Further Meaning	Behavior
Success	0000	Film accepted for printing	The print job continues.

Service Status	Error Code	Further Meaning	Behavior
Warning	B603	Film Box SOP Instance Hierarchy does not contain Image Box SOP instances	The print job continues and the warning is logged and reported to the user.
	B604	Image Size is larger than Image Box Size - the image has been de-magnified	The print job continues and the warning is logged and reported to the user.
	B609	Image Size is larger than Image Box Size - the image has been cropped to fit	The print job continues and the warning is logged and reported to the user.
	B60A	Image Size or combined Print Image Size is larger than Image Box Size - the image or combined print image has been decimated to fit	The print job continues and the warning is logged and reported to the user.
Failure	C602	Unable to create Print Job SOP instance - print queue is full	The print job is marked as failed and the reason is logged and reported to the user.
	C603	Image Size is larger than Image Box Size	The print job is marked as failed and the reason is logged and reported to the user.
	C613	Combined Print Image Size is larger than Image Box Size	The print job is marked as failed and the reason is logged and reported to the user.

4.2.1.3.5.8.2. Dataset Specific Conformance for Basic Film Box N-CREATE SCU

Detail regarding the Dataset Specific response behavior will be reported in this section.

Table 47: Basic Film Box Presentation Module

Attribute Name	Tag	VR	Value	Presence of Value	Source	Comment
Configuration Information	2010,0150	ST	L=1, L=V	ALWAYS	CONFIG	
Film Orientation	2010,0040	CS	LANDSCAPE, PORTRAIT, PORTRAIT, LANDSCAPE	ALWAYS	CONFIG	
Film Size ID	2010,0050	CS	10INX12IN, 10INX14IN, 11INX14IN, 11INX17IN, 14INX14IN, 14INX17IN, 24CMX24CM, 24CMX30CM, 8_5INX11IN, 8INX10IN, A3, A4	ALWAYS	CONFIG	
Image Display Format	2010,0010	ST	CUSTOM\1, STANDARD\1,1	ALWAYS	CONFIG	
Magnification Type	2010,0060	CS		ALWAYS	USER	
Max Density	2010,0130	US		VNAP	CONFIG	
Trim	2010,0140	CS	NO, YES	VNAP	CONFIG	

Table 48: Basic Film Box Relationship Module

Attribute Name	Tag	VR	Value	Presence of Value	Source	Comment
Referenced Film Session Sequence	2010,0500	SQ		ALWAYS	AUTO	
>Referenced SOP Class UID	0008,1150	UI	1.2.840.10008.5.1.1.1	ALWAYS	FIXED	
>Referenced SOP Instance UID	0008,1155	UI		ALWAYS	AUTO	UID of parent Film Session
Referenced Presentation LUT Sequence	2050,0500	SQ		ANAPCV	AUTO	

>Referenced SOP Class UID	0008,1150	UI	1.2.840.10008.5.1.1.23	ALWAYS	FIXED	
>Referenced SOP Instance UID	0008,1155	UI		ALWAYS	AUTO	UID of parent Presentation LUT

This part of the section includes the dataset specific behavior, i.e. error codes, error and exception handling, time-outs, etc.

Table 49: Status Response

Service Status	Error Code	Further Meaning	Behavior
Success	0000	Successful operation	The print job continues.
Warning	B605	Requested Min Density or Max Density outside of printer's operating range	The print job continues and the warning is logged.
Failed	C616	There is an existing Film Box that has not been printed	The print job is marked as failed and the reason is logged.

4.2.1.3.5.9. SOP Specific Conformance for Basic Film Session SOP Class of the Basic Grayscale Print Management Meta SOP Class

This section and sub-section includes the manufacturer SOP and Dataset specific information as well the status codes and their corresponding behavior.

4.2.1.3.5.9.1. Dataset Specific Conformance for Basic Film Session N-CREATE SCU

Detail regarding the Dataset Specific response behavior will be reported in this section.

Table 50: Basic Film Session Presentation Module

Attribute Name	Tag	VR	Value	Presence of Value	Source	Comment
Film Destination	2000,0040	CS	MAGAZINE, PROCESSOR	ALWAYS	IMPLICIT	
Film Session Label	2000,0050	LO	Philips Medical Systems	ALWAYS	FIXED	
Medium Type	2000,0030	CS	BLUE FILM, CLEAR FILM, PAPER	ALWAYS	IMPLICIT	
Number of Copies	2000,0010	IS	1 to 99	ALWAYS	IMPLICIT, USER	
Print Priority	2000,0020	CS	HIGH, LOW, MED	ALWAYS	IMPLICIT	

This part of the section includes the dataset specific behavior, i.e. error codes, error and exception handling, time-outs, etc.

Table 51: Status Response

Service Status	Error Code	Further Meaning	Behavior
Success	0000	Film Session successfully created	The print job continues.
Warning	B600	Memory Allocation not supported	The print job continues and the warning is logged.

4.2.1.3.5.10. SOP Specific Conformance for Basic Grayscale Image Box SOP Class of the Basic Grayscale Print Management Meta SOP Class

This section and sub-section includes the manufacturer SOP and Dataset specific information as well the status codes and their corresponding behavior.

4.2.1.3.5.10.1. Dataset Specific Conformance for Basic Grayscale Image Box N-SET SCU

Detail regarding the Dataset Specific response behavior will be reported in this section.

Table 52: Image Box Pixel Presentation Module

Attribute Name	Tag	VR	Value	Presence of Value	Source	Comment
Image Position	2020,0010	US	1	ALWAYS	FIXED	
Polarity	2020,0020	CS	NORMAL	ALWAYS	FIXED	
Basic Grayscale Image Sequence	2020,0110	SQ		ALWAYS	AUTO	
>Bits Allocated	0028,0100	US	16, 8	ALWAYS	AUTO	
>Bits Stored	0028,0101	US	12, 8	ALWAYS	AUTO	
>Columns	0028,0011	US		ALWAYS	COPY	
>High Bit	0028,0102	US	11, 7	ALWAYS	AUTO	
>Photometric Interpretation	0028,0004	CS		ALWAYS	FIXED	
>Pixel Data	7FE0,0010	O W/ OB		ALWAYS	AUTO	
>Pixel Representation	0028,0103	US	0	ALWAYS	FIXED	
>Rows	0028,0010	US		ALWAYS	COPY	
>Samples per Pixel	0028,0002	US	1	ALWAYS	FIXED	

This part of the section includes the dataset specific behavior, i.e. error codes, error and exception handling, time-outs, etc.

Table 53: Status Response

Service Status	Error Code	Further Meaning	Behavior
Success	0000	Image successfully stored in Image Box	The print job continues.
Warning	B604	Image Size is larger than Image Box Size - the image has been de-magnified	The print job continues and the warning is logged and reported to the user.
	B605	Requested Min Density or Max Density outside of printer's operating range	The print job continues and the warning is logged and reported to the user.
	B609	Image Size is larger than Image Box Size - the image has been cropped to fit	The print job continues and the warning is logged and reported to the user.
	B60A	Image Size or combined Print Image Size is larger than Image Box Size - the image or combined print image has been decimated to fit	The print job continues and the warning is logged and reported to the user.
Failure	C603	Image Size is larger than Image Box Size	The print job is marked as failed and the reason is logged and reported to the user.
	C605	Insufficient memory in printer to store the image	The print job is marked as failed and the reason is logged and reported to the user.
	C613	Combined Print Image Size is larger than Image Box Size	The print job is marked as failed and the reason is logged and reported to the user.

4.2.1.3.5.11. SOP Specific Conformance for Printer SOP Class of the Basic Grayscale Print Management Meta SOP Class

This section and sub-section includes the manufacturer SOP and Dataset specific information as well the status codes and their corresponding behavior.

4.2.1.3.5.11.1. Dataset Specific Conformance for Printer N-GET SCU

Detail regarding the Dataset Specific response behavior will be reported in this section.

Table 54: Printer Module

Attribute Name	Tag	VR	Value	Presence of Value	Source	Comment
Device Serial Number	0018,1000	LO		ANAPEV	FIXED	
Manufacturer	0008,0070	LO		ANAPEV	FIXED	
Manufacturer's Model Name	0008,1090	LO		ANAPEV	FIXED	
Printer Name	2110,0030	LO		ANAPEV	FIXED	
Printer Status	2110,0010	CS		ANAPEV	FIXED	
Printer Status Info	2110,0020	CS		ANAPEV	FIXED	
Software Version(s)	0018,1020	LO		ANAPEV	FIXED	

This part of the section includes the dataset specific behavior, i.e. error codes, error and exception handling, time-outs, etc.

Table 55: Status Response

Service Status	Error Code	Further Meaning	Behavior
Success	0000	Successful operation	The print job continues.
Error	xxxx	(any warning)	The print job continues and the warning is logged.
Failed	xxxx	(any failure)	The print job is marked as failed and the reason is logged and reported to the user.

4.2.1.3.5.11.2. Dataset Specific Conformance for Printer N-EVENT-REPORT SCU

Detail regarding the Dataset Specific response behavior will be reported in this section.

This part of the section includes the dataset specific behavior, i.e. error codes, error and exception handling, time-outs, etc.

Table 56: Status Response

Service Status	Error Code	Further Meaning	Behavior
Success	0000	Successful operation	The print job is marked as completed

Service Status	Error Code	Further Meaning	Behavior
Warning	xxxx	(any warning)	The print job continues and the warning is logged and reported to the user.
Failed	xxxx	(any failure)	The print job is marked as failed and the reason is logged and reported to the user.

4.2.1.4. Association Acceptance Policy

The Application Entity may reject Association attempts as shown in the table below.

Table 57: Association Reject Reasons

Result	Source	Reason/Diagnosis	Explanation
1 - rejected permanent	1 - DICOM UL service-user	1 - no-reason-given	
		2 - application-context-name-not-supported	
		3 - calling-AE-title-not-recognized	
		7 - called-AE-title-not-recognized	
	2 - DICOM UL service provider (ACSE related function)	1 - no-reason-given	
		2 - protocol-version-not-supported	
3 - DICOM UL service provider (Presentation related function)	1 - temporary-congestion		
	2 - local-limit-exceeded		
2 - rejected-transient	1 - DICOM UL service-user	1 - no-Reason-given	
		2 - application-context-name-not-supported	
		3 - calling-AE-title-not-recognized	
		7 - called-AE-title-not-recognized	
	2 - DICOM UL service provider (ACSE related function)	1 - no-reason-given	
		2 - protocol-version-not-supported	
	3 - DICOM UL service provider (Presentation related function)	1 - temporary-congestion	
		2 - local-limit-exceeded	

The behavior of the AE for sending an association abort is summarized in next table

Table 58: Association Abort Policies

Source	Reason/Diagnosis	Behavior
0 - DICOM UL service-user (initiated abort)	0 - reason-not-specified	
2 - DICOM UL service-provider (initiated abort)	0 - reason-not-specified	
	1 - unrecognized-PDU	
	2 - unexpected-PDU	
	4 - unrecognized-PDU parameter	
	5 - unexpected-PDU parameter	
	6 - invalid-PDU-parameter value	

4.2.1.4.1. (Real-World) Activity – Verification as SCP

4.2.1.4.1.1. Description and Sequencing of Activities

The ACP AE accepts associations from systems that wish to verify application level communication using the C-ECHO command.

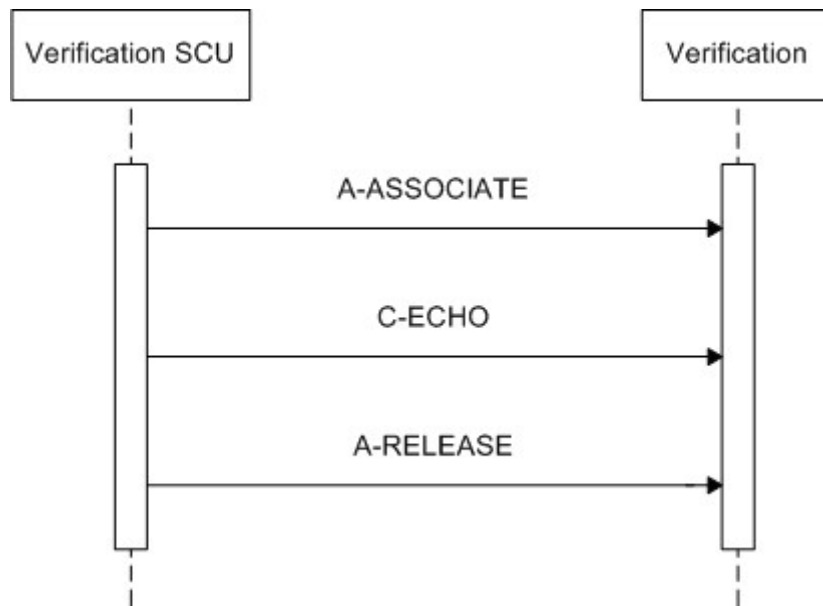

Figure 8: Sequencing of Verification

4.2.1.4.1.2. Accepted Presentation Contexts

The presentation contexts are defined in next table.

Table 59: Acceptable Presentation Contexts for (Real-World) Activity – Verification as SCP

Presentation Context Table					
Abstract Syntax		Transfer Syntax		Role	Extended Negotiation
Name	UID	Name List	UID List		
Verification SOP Class	1.2.840.10008.1.1	Explicit VR Big Endian	1.2.840.10008.1.2.2	SCP	None
		Explicit VR Little Endian	1.2.840.10008.1.2.1		
		Implicit VR Little Endian	1.2.840.10008.1.2		

For performance reasons the ELE transfer syntax is preferred and will be chosen in case multiple transfer syntaxes are proposed in the association negotiation.

The ACP AE accepts all contexts in the intersection of the proposed and acceptable presentation contexts. This means that the ACP AE accepts multiple proposed presentation contexts with the same SOP class but different transfer syntaxes. There is no check for duplicate contexts, and these will therefore be accepted.

4.2.1.4.1.3. SOP Specific Conformance for Verification SOP Class

This section and sub-section includes the manufacturer SOP and Dataset specific information as well the status codes and their corresponding behavior.

4.2.1.4.1.3.1. Dataset Specific Conformance for Verification C-ECHO SCP

Detail regarding the Dataset Specific response behavior will be reported in this section.

This part of the section includes the dataset specific behavior, i.e. error codes, error and exception handling, time-outs, etc.

Table 60: Status Response

Service Status	Error Code	Further Meaning	Behavior
Success	0000	Verification is successful	The ACP AE is able to confirm application level communication.

4.2.1.4.2. (Real-World) Activity – FIND As SCP

4.2.1.4.2.1. Description and Sequencing of Activities

The ACP AE accepts associations from systems that wish to query the ACP AE database using the C-FIND command, and from systems that wish to retrieve images from the ACP AE database using the C-MOVE command.

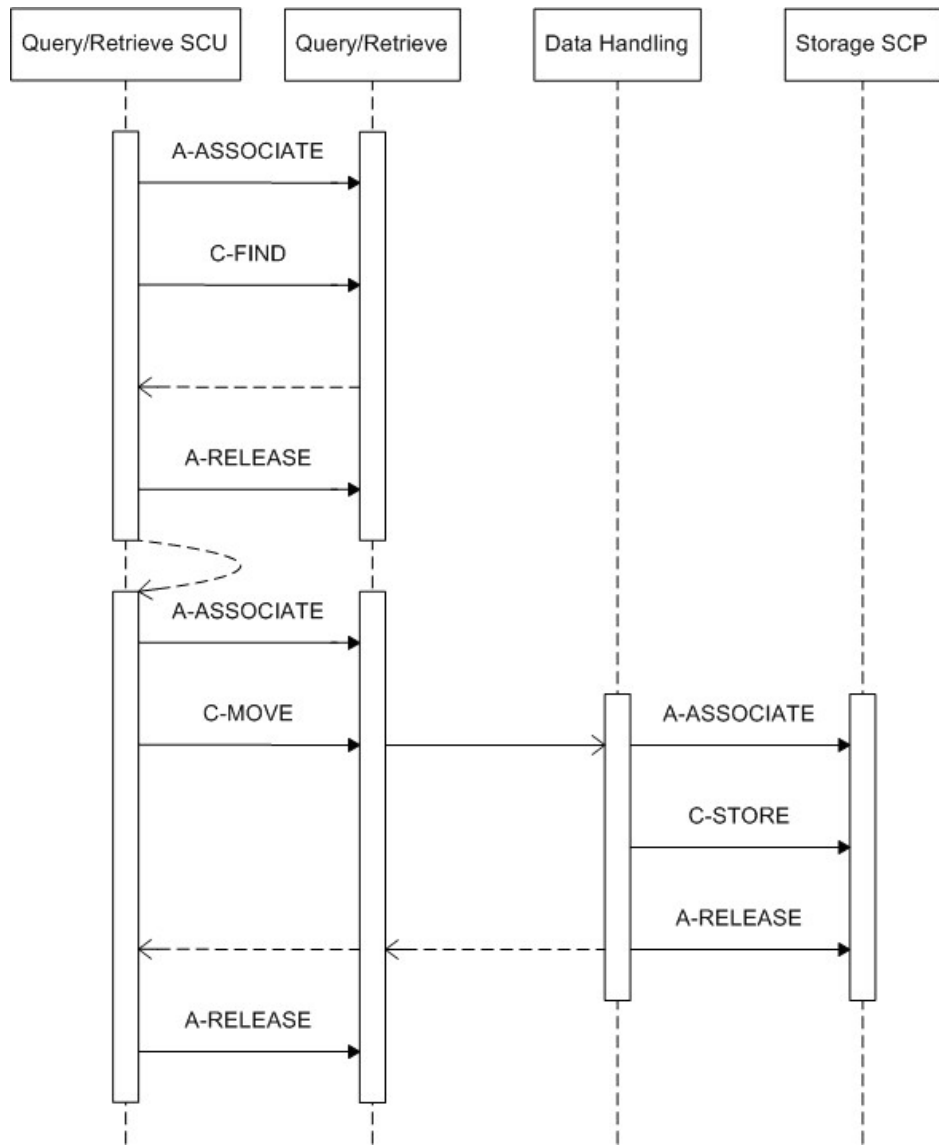

Figure 9: Sequencing of Query/Retrieve

4.2.1.4.2.2. Accepted Presentation Contexts

The presentation contexts are defined in next table.

Table 61: Acceptable Presentation Contexts for (Real-World) Activity – FIND As SCP

Presentation Context Table					
Abstract Syntax		Transfer Syntax		Role	Extended Negotiation
Name	UID	Name List	UID List		
Patient Root Query/Retrieve Information Model - FIND SOP Class	1.2.840.10008.5.1.4.1.2.1.1	Explicit VR Big Endian	1.2.840.10008.1.2.2	SCP	None
		Explicit VR Little Endian	1.2.840.10008.1.2.1		
		Implicit VR Little Endian	1.2.840.10008.1.2		
Patient/Study Only Query/Retrieve Info.	1.2.840.10008.5.1.4.1.2.3.1	Explicit VR Big Endian	1.2.840.10008.1.2.2	SCP	None
		Explicit VR Little Endian	1.2.840.10008.1.2.1		

Presentation Context Table					
Abstract Syntax		Transfer Syntax		Role	Extended Negotiation
Name	UID	Name List	UID List		
Model - FIND SOP Class		Implicit VR Little Endian	1.2.840.10008.1.2		
Study Root Query/Retrieve Information Model - FIND SOP Class	1.2.840.10008.5.1.4.1.2.2.1	Explicit VR Big Endian	1.2.840.10008.1.2.2	SCP	None
		Explicit VR Little Endian	1.2.840.10008.1.2.1		
		Implicit VR Little Endian	1.2.840.10008.1.2		

For performance reasons the ELE transfer syntax is preferred and will be chosen in case multiple transfer syntaxes are proposed in the association negotiation.

The ACP AE accepts all contexts in the intersection of the proposed and acceptable presentation contexts. This means that the ACP AE accepts multiple proposed presentation contexts with the same SOP class but different transfer syntaxes. There is no check for duplicate contexts, and these will therefore be accepted.

4.2.1.4.2.3. SOP Specific Conformance for Patient Root Query/Retrieve Information Model - FIND SOP Class

This section and sub-section includes the manufacturer SOP and Dataset specific information as well the status codes and their corresponding behavior.

The ACP AE provides standard conformance to the Query/Retrieve service class. Relational queries are not supported. The ACP AE will handle simultaneous C-FIND and/or C-MOVE requests simultaneously.

4.2.1.4.2.3.1. Dataset Specific Conformance for Patient Root Q/R Information Model - FIND SOP Class SCP

Detail regarding the Dataset Specific response behavior will be reported in this section.

The ACP AE distinguishes two patients with the same Patient ID but different Patient's Name or Patient's Birth Date. However, the DICOM Query/Retrieve service class has Patient ID as a unique key at patient level, and thus two patients with the same Patient ID cannot be distinguished via a standard DICOM query.

The following query keys are supported.

Table 62: Requested Query Keys for Patient Root Information Model

Patient Root Information Model				
Attribute Name	Tag	VR	Type Of Matching	Comment
Q/R Patient level				
Patient ID	0010,0020	LO		
Patient's Name	0010,0010	PN		
Q/R Study level (Patient Root)				
Accession Number	0008,0050	SH		
Study Date	0008,0020	DA		
Study ID	0020,0010	SH		
Study Instance UID	0020,000D	UI		
Study Time	0008,0030	TM		
Q/R Series level				
Modality	0008,0060	CS		

Series Instance UID	0020,000E	UI		
Series Number	0020,0011	IS		
Q/R Image level				
Instance Number	0020,0013	IS		
SOP Instance UID	0008,0018	UI		

When querying optional keys the ACP AE will respond successfully for available keys if queried per universal matching; otherwise it will respond with warning. Note that when querying optional keys with non-universal matching the ACP AE will return information using universal matching for those keys. Also note that when a query is performed per Patient/Study Only Query/Retrieve Information Model SOP class on patient level, the ACP AE always returns the attribute "Patient's Name", even if it was not requested.

This part of the section includes the dataset specific behavior, i.e. error codes, error and exception handling, time-outs, etc.

Table 63: Status Response

Service Status	Error Code	Further Meaning	Behavior
Success	0000	Matching is complete	The C-FIND request handling is completed, no more query responses are sent.
Failure	A700	Refused - Out of Resources	N/A
	A900	Failed - Identifier does not match SOP class	N/A
	C000	Failed - Unable to process	The query request cannot be parsed. The ACP AE logs the reason.
Warning	B000	Sub-operations complete - one or more failures	N/A
Cancel	FE00	Matching terminated due to Cancel Indication	The query request is cancelled; no more query responses are sent.
Pending	FF00	Matches are continuing - current match is supplied and any optional keys were supported in the same manner as required keys	The C-FIND responses are continuing.
	FF01	Matches are continuing - warning that one or more optional keys were not supported for existence and/or matching for this identifier	The C-FIND responses are continuing.

4.2.1.4.2.4. SOP Specific Conformance for Patient/Study Only Query/Retrieve Info. Model - FIND SOP Class

This section and sub-section includes the manufacturer SOP and Dataset specific information as well the status codes and their corresponding behavior.

The ACP AE provides standard conformance to the Query/Retrieve service class. Relational queries are not supported. The ACP AE will handle simultaneous C-FIND and/or C-MOVE requests simultaneously.

4.2.1.4.2.4.1. Dataset Specific Conformance for Patient/Study Only Q/R Information Model - FIND SOP Class SCP

Detail regarding the Dataset Specific response behavior will be reported in this section.

The ACP AE distinguishes two patients with the same Patient ID but different Patient's Name or Patient's Birth Date. However, the DICOM Query/Retrieve service class has

Patient ID as a unique key at patient level, and thus two patients with the same Patient ID cannot be distinguished via a standard DICOM query.

The following query keys are supported.

Table 64: Requested Query Keys for Patient/Study Only Information Model

Patient/Study Only Information Model				
Attribute Name	Tag	VR	Type Of Matching	Comment
Q/R Patient level				
Patient ID	0010,0020	LO		
Patient's Name	0010,0010	PN		
Q/R Study level (Patient Root)				
Accession Number	0008,0050	SH		
Study Date	0008,0020	DA		
Study ID	0020,0010	SH		
Study Instance UID	0020,000D	UI		
Study Time	0008,0030	TM		

When querying optional keys the ACP AE will respond successfully for available keys if queried per universal matching; otherwise it will respond with warning. Note that when querying optional keys with non-universal matching the ACP AE will return information using universal matching for those keys. Also note that when a query is performed per Patient/Study Only Query/Retrieve Information Model SOP class on patient level, the ACP AE always returns the attribute "Patient's Name", even if it was not requested.

This part of the section includes the dataset specific behavior, i.e. error codes, error and exception handling, time-outs, etc.

Table 65: Status Response

Service Status	Error Code	Further Meaning	Behavior
Success	0000	Matching is complete	The C-FIND request handling is completed, no more query responses are sent.
Failure	A700	Refused - Out of Resources	N/A
	A900	Failed - Identifier does not match SOP class	N/A
	C000	Failed - Unable to process	The query request cannot be parsed. The ACP AE logs the reason.
Warning	B000	Sub-operations complete - one or more failures	N/A
Cancel	FE00	Matching terminated due to Cancel Indication	The query request is cancelled; no more query responses are sent.
Pending	FF00	Matches are continuing - current match is supplied and any optional keys were supported in the same manner as required keys	The C-FIND responses are continuing.
	FF01	Matches are continuing - warning that one or more optional keys were not supported for existence and/or matching for this identifier	The C-FIND responses are continuing.

4.2.1.4.2.5. SOP Specific Conformance for Study Root Query/Retrieve Information Model - FIND SOP Class

This section and sub-section includes the manufacturer SOP and Dataset specific information as well the status codes and their corresponding behavior.

The ACP AE provides standard conformance to the Query/Retrieve service class. Relational queries are not supported. The ACP AE will handle simultaneous C-FIND and/or C-MOVE requests simultaneously.

4.2.1.4.2.5.1. Dataset Specific Conformance for Study Root Q/R Information Model - FIND SOP Class SCP

Detail regarding the Dataset Specific response behavior will be reported in this section.

The ACP AE distinguishes two patients with the same Patient ID but different Patient's Name or Patient's Birth Date. However, the DICOM Query/Retrieve service class has Patient ID as a unique key at patient level, and thus two patients with the same Patient ID cannot be distinguished via a standard DICOM query.

The following query keys are supported.

Table 66: Requested Query Keys for Study Root Information Model

Study Root Information Model				
Attribute Name	Tag	VR	Type Of Matching	Comment
Q/R Study level (Study Root)				
Accession Number	0008,0050	SH		
Study Date	0008,0020	DA		
Study ID	0020,0010	SH		
Study Instance UID	0020,000D	UI		
Study Time	0008,0030	TM		
Q/R Series level				
Modality	0008,0060	CS		
Series Instance UID	0020,000E	UI		
Series Number	0020,0011	IS		
Q/R Image level				
Instance Number	0020,0013	IS		
SOP Instance UID	0008,0018	UI		

When querying optional keys the ACP AE will respond successfully for available keys if queried per universal matching; otherwise it will respond with warning. Note that when querying optional keys with non-universal matching the ACP AE will return information using universal matching for those keys. Also note that when a query is performed per Patient/Study Only Query/Retrieve Information Model SOP class on patient level, the ACP AE always returns the attribute "Patient's Name", even if it was not requested.

This part of the section includes the dataset specific behavior, i.e. error codes, error and exception handling, time-outs, etc.

Table 67: Status Response

Service Status	Error Code	Further Meaning	Behavior
Success	0000	Matching is complete	The C-FIND request handling is completed, no more query responses are sent.
Failure	A700	Refused - Out of Resources	N/A
	A900	Failed - Identifier does not match SOP class	N/A
	C000	Failed - Unable to process	The query request cannot be parsed. The ACP AE logs the reason.

Service Status	Error Code	Further Meaning	Behavior
Warning	B000	Sub-operations complete - one or more failures	N/A
Cancel	FE00	Matching terminated due to Cancel Indication	The query request is cancelled; no more query responses are sent.
Pending	FF00	Matches are continuing - current match is supplied and any optional keys were supported in the same manner as required keys	The C-FIND responses are continuing.
	FF01	Matches are continuing - warning that one or more optional keys were not supported for existence and/or matching for this identifier	The C-FIND responses are continuing.

4.2.1.4.3. (Real-World) Activity – MOVE As SCP

4.2.1.4.3.1. Description and Sequencing of Activities

The ACP AE accepts associations from systems that wish to query the ACP AE database using the C-FIND command, and from systems that wish to retrieve images from the ACP AE database using the C-MOVE command.

See chapter 4.2.1.4.2.1 for the sequencing diagram of Query/Retrieve.

4.2.1.4.3.2. Accepted Presentation Contexts

The presentation contexts are defined in next table.

Table 68: Acceptable Presentation Contexts for (Real-World) Activity – MOVE As SCP

Presentation Context Table					
Abstract Syntax		Transfer Syntax		Role	Extended Negotiation
Name	UID	Name List	UID List		
Patient Root Query/Retrieve Information Model - MOVE SOP Class	1.2.840.10008.5.1.4.1.2.1.2	Explicit VR Big Endian	1.2.840.10008.1.2.2	SCP	None
		Explicit VR Little Endian	1.2.840.10008.1.2.1		
		Implicit VR Little Endian	1.2.840.10008.1.2		
Patient/Study Only Query/Retrieve Info. Model - MOVE SOP Class	1.2.840.10008.5.1.4.1.2.3.2	Explicit VR Big Endian	1.2.840.10008.1.2.2	SCP	None
		Explicit VR Little Endian	1.2.840.10008.1.2.1		
		Implicit VR Little Endian	1.2.840.10008.1.2		
Study Root Query/Retrieve Information Model - MOVE SOP Class	1.2.840.10008.5.1.4.1.2.2.2	Explicit VR Big Endian	1.2.840.10008.1.2.2	SCP	None
		Explicit VR Little Endian	1.2.840.10008.1.2.1		
		Implicit VR Little Endian	1.2.840.10008.1.2		

For performance reasons the ELE transfer syntax is preferred and will be chosen in case multiple transfer syntaxes are proposed in the association negotiation.

The ACP AE accepts all contexts in the intersection of the proposed and acceptable presentation contexts. This means that the ACP AE accepts multiple proposed presentation contexts with the same SOP class but different transfer syntaxes. There is no check for duplicate contexts, and these will therefore be accepted.

4.2.1.4.3.3. SOP Specific Conformance for Patient Root Query/Retrieve Information Model - MOVE SOP Class

This section and sub-section includes the manufacturer SOP and Dataset specific information as well the status codes and their corresponding behavior.

The ACP AE provides standard conformance to the Query/Retrieve service class. Relational queries are not supported. The ACP AE will handle simultaneous C-FIND and/or C-MOVE requests simultaneously.

4.2.1.4.3.3.1. Dataset Specific Conformance for Patient Root Q/R Information Model - MOVE SOP Class SCP

Detail regarding the Dataset Specific response behavior will be reported in this section.

The ACP AE provides standard conformance to the Query/Retrieve service class. Relational queries are not supported. The ACP AE will handle simultaneous C-FIND and/or C-MOVE requests simultaneously.

This part of the section includes the dataset specific behavior, i.e. error codes, error and exception handling, time-outs, etc.

Table 69: Status Response

Service Status	Error Code	Further Meaning	Behavior
Success	0000	Sub-operations complete - no failures	The retrieve command has been completed.
Failure	A701	Refused - Out of Resources: unable to calculate number of matches	N/A
	A702	Refused - Out of Resources: unable to perform sub-operations	N/A
	A801	Refused - Move destination unknown	No storage command will be sent. The ACP AE logs the reason.
	A900	Failed - Identifier does not match SOP class	N/A
	C000	Failed - Unable to process	The retrieve request cannot be parsed. No storage command will be sent. The ACP AE logs the reason.
Warning	B000	Sub-operations complete - one or more failures	N/A
Cancel	FE00	Sub-operations terminated due to Cancel Indication	The retrieve request is cancelled; no more retrieve responses are sent.
Pending	FF00	Sub-operations are continuing	Approximately every 30 seconds to indicate progress.

4.2.1.4.3.4. SOP Specific Conformance for Patient/Study Only Query/Retrieve Info. Model - MOVE SOP Class

This section and sub-section includes the manufacturer SOP and Dataset specific information as well the status codes and their corresponding behavior.

The ACP AE provides standard conformance to the Query/Retrieve service class. Relational queries are not supported. The ACP AE will handle simultaneous C-FIND and/or C-MOVE requests simultaneously.

4.2.1.4.3.4.1. Dataset Specific Conformance for Patient/Study Only Q/R Information Model - MOVE SOP Class SCP

Detail regarding the Dataset Specific response behavior will be reported in this section.

The ACP AE provides standard conformance to the Query/Retrieve service class. Relational queries are not supported. The ACP AE will handle simultaneous C-FIND and/or C-MOVE requests simultaneously.

This part of the section includes the dataset specific behavior, i.e. error codes, error and exception handling, time-outs, etc.

Table 70: Status Response

Service Status	Error Code	Further Meaning	Behavior
Success	0000	Matching is complete	The retrieve command has been completed.
Failure	A701	Refused - Out of Resources: unable to calculate number of matches	N/A
	A702	Refused - Out of Resources: unable to perform sub-operations	N/A
	A801	Refused - Move destination unknown	No storage command will be sent. The ACP AE logs the reason.
	A900	Failed - Identifier does not match SOP class	N/A
	C000	Failed - Unable to process	The retrieve request cannot be parsed. No storage command will be sent. The ACP AE logs the reason.
Warning	B000	Sub-operations complete - one or more failures	N/A
Cancel	FE00	Matching terminated due to Cancel Indication	The retrieve request is cancelled; no more retrieve responses are sent.
Pending	FF00	Sub-operations are continuing	Approximately every 30 seconds to indicate progress.

4.2.1.4.3.5. SOP Specific Conformance for Study Root Query/Retrieve Information Model - MOVE SOP Class

This section and sub-section includes the manufacturer SOP and Dataset specific information as well the status codes and their corresponding behavior.

The ACP AE provides standard conformance to the Query/Retrieve service class. Relational queries are not supported. The ACP AE will handle simultaneous C-FIND and/or C-MOVE requests simultaneously.

4.2.1.4.3.5.1. Dataset Specific Conformance for Study Root Query/Retrieve Information Model - MOVE SOP Class SCP

Detail regarding the Dataset Specific response behavior will be reported in this section.

The ACP AE provides standard conformance to the Query/Retrieve service class. Relational queries are not supported. The ACP AE will handle simultaneous C-FIND and/or C-MOVE requests simultaneously.

This part of the section includes the dataset specific behavior, i.e. error codes, error and exception handling, time-outs, etc.

Table 71: Status Response

Service Status	Error Code	Further Meaning	Behavior
Success	0000	Matching is complete	The retrieve command has been completed.
Failure	A701	Refused - Out of Resources: unable to calculate number of matches	N/A
	A702	Refused - Out of Resources: unable to perform sub-operations	N/A
	A801	Refused - Move destination unknown	No storage command will be sent. The ACP AE logs the reason.
	A900	Failed - Identifier does not match SOP class	N/A
	C000	Failed - Unable to process	The retrieve request cannot be parsed. No storage command will be sent. The ACP AE logs the reason.
Warning	B000	Sub-operations complete - one or more failures	N/A
Cancel	FE00	Sub-operations terminated due to Cancel Indication	The retrieve request is cancelled; no more retrieve responses are sent.
Pending	FF00	Sub-operations are continuing	Approximately every 30 seconds to indicate progress.

4.2.1.4.4. (Real-World) Activity – Image Import

4.2.1.4.4.1. Description and Sequencing of Activities

The ACP AE accepts associations from systems that wish to store images in the ACP AE database using the C-STORE command.

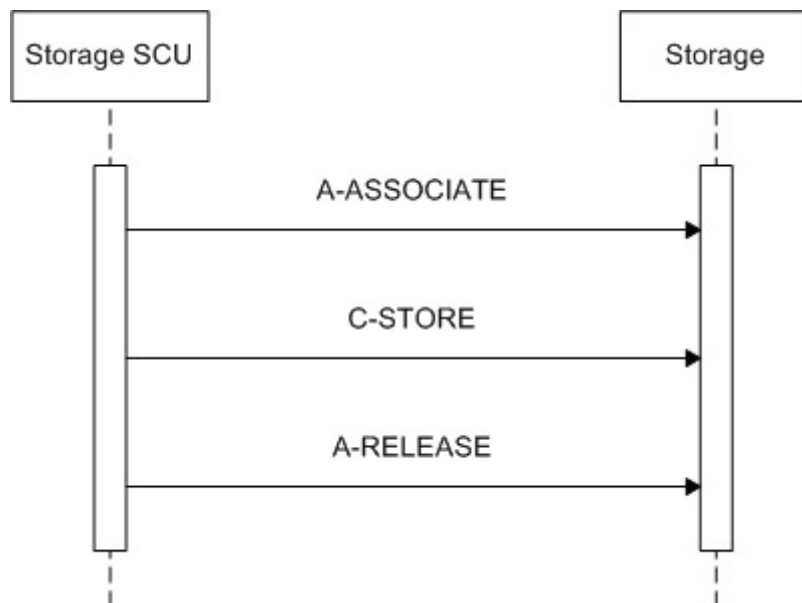

Figure 10: Sequencing of Storage

4.2.1.4.4.2. Accepted Presentation Contexts

The presentation contexts are defined in next table.

Table 72: Acceptable Presentation Contexts for (Real-World) Activity – Image Import

Presentation Context Table					
Abstract Syntax		Transfer Syntax		Role	Extended Negotiation
Name	UID	Name List	UID List		
3D Object new Storage (Private)	1.3.46.670589.5.0.2.1	Explicit VR Big Endian	1.2.840.10008.1.2.2	SCP	None
		Explicit VR Little Endian	1.2.840.10008.1.2.1		
		Implicit VR Little Endian	1.2.840.10008.1.2		
3D Volume Storage new SOP Class (Private)	1.3.46.670589.5.0.1.1	Explicit VR Big Endian	1.2.840.10008.1.2.2	SCP	None
		Explicit VR Little Endian	1.2.840.10008.1.2.1		
		Implicit VR Little Endian	1.2.840.10008.1.2		
Cardio Image Storage new SOP Class (Private)	1.3.46.670589.5.0.8.1	Explicit VR Big Endian	1.2.840.10008.1.2.2	SCP	None
		Explicit VR Little Endian	1.2.840.10008.1.2.1		
		Implicit VR Little Endian	1.2.840.10008.1.2		
Computed Radiography Image Storage SOP Class	1.2.840.10008.5.1.4.1.1.1	Explicit VR Big Endian	1.2.840.10008.1.2.2	SCP	None
		Explicit VR Little Endian	1.2.840.10008.1.2.1		
		Implicit VR Little Endian	1.2.840.10008.1.2		
CT Image Storage SOP Class	1.2.840.10008.5.1.4.1.1.2	Explicit VR Big Endian	1.2.840.10008.1.2.2	SCP	None
		Explicit VR Little Endian	1.2.840.10008.1.2.1		
		Implicit VR Little Endian	1.2.840.10008.1.2		
CT Synthetic Image Storage (Private)	1.3.46.670589.5.0.9	Explicit VR Big Endian	1.2.840.10008.1.2.2	SCP	None
		Explicit VR Little Endian	1.2.840.10008.1.2.1		
		Implicit VR Little Endian	1.2.840.10008.1.2		
CX Synthetic Image Storage (Private)	1.3.46.670589.5.0.12	Explicit VR Big Endian	1.2.840.10008.1.2.2	SCP	None
		Explicit VR Little Endian	1.2.840.10008.1.2.1		
		Implicit VR Little Endian	1.2.840.10008.1.2		
Digital X-Ray Image Storage - For Pres. SOP	1.2.840.10008.5.1.4.1.1.1.1	Explicit VR Big Endian	1.2.840.10008.1.2.2	SCP	None
		Explicit VR Little Endian	1.2.840.10008.1.2.1		
		Implicit VR Little Endian	1.2.840.10008.1.2		
MR Cardio Analysis new Storage (Private)	1.3.46.670589.5.0.11.1	Explicit VR Big Endian	1.2.840.10008.1.2.2	SCP	None
		Explicit VR Little Endian	1.2.840.10008.1.2.1		
		Implicit VR Little Endian	1.2.840.10008.1.2		
MR Image Storage SOP Class	1.2.840.10008.5.1.4.1.1.4	Explicit VR Big Endian	1.2.840.10008.1.2.2	SCP	None
		Explicit VR Little Endian	1.2.840.10008.1.2.1		
		Implicit VR Little Endian	1.2.840.10008.1.2		
MR Synthetic Image Storage (Private)	1.3.46.670589.5.0.10	Explicit VR Big Endian	1.2.840.10008.1.2.2	SCP	None
		Explicit VR Little Endian	1.2.840.10008.1.2.1		
		Implicit VR Little Endian	1.2.840.10008.1.2		
Nuclear Medicine Image Storage SOP Class	1.2.840.10008.5.1.4.1.1.20	Explicit VR Big Endian	1.2.840.10008.1.2.2	SCP	None
		Explicit VR Little Endian	1.2.840.10008.1.2.1		
		Implicit VR Little Endian	1.2.840.10008.1.2		
Perfusion (Private)	1.3.46.670589.5.0.13	Explicit VR Big Endian	1.2.840.10008.1.2.2	SCP	None
		Explicit VR Little Endian	1.2.840.10008.1.2.1		
		Implicit VR Little Endian	1.2.840.10008.1.2		
Perfusion Image Storage (Private)	1.3.46.670589.5.0.14	Explicit VR Big Endian	1.2.840.10008.1.2.2	SCP	None
		Explicit VR Little Endian	1.2.840.10008.1.2.1		
		Implicit VR Little Endian	1.2.840.10008.1.2		
Secondary Capture Image Storage SOP Class	1.2.840.10008.5.1.4.1.1.7	Explicit VR Big Endian	1.2.840.10008.1.2.2	SCP	None
		Explicit VR Little Endian	1.2.840.10008.1.2.1		
		Implicit VR Little Endian	1.2.840.10008.1.2		

Presentation Context Table					
Abstract Syntax		Transfer Syntax		Role	Extended Negotiation
Name	UID	Name List	UID List		
Softcopy Presentation State Storage SOP Class	1.2.840.10008.5.1.4.1.1.11.1	Explicit VR Big Endian	1.2.840.10008.1.2.2	SCP	None
		Explicit VR Little Endian	1.2.840.10008.1.2.1		
		Implicit VR Little Endian	1.2.840.10008.1.2		
Specialized PMS X-Ray Image Store	1.3.46.670589.2.3.1.1	Explicit VR Big Endian	1.2.840.10008.1.2.2	SCP	None
		Explicit VR Little Endian	1.2.840.10008.1.2.1		
		Implicit VR Little Endian	1.2.840.10008.1.2		
Surface Storage new (Private)	1.3.46.670589.5.0.3.1	Explicit VR Big Endian	1.2.840.10008.1.2.2	SCP	None
		Explicit VR Little Endian	1.2.840.10008.1.2.1		
		Implicit VR Little Endian	1.2.840.10008.1.2		
Ultrasound Image Storage SOP Class	1.2.840.10008.5.1.4.1.1.6.1	Explicit VR Big Endian	1.2.840.10008.1.2.2	SCP	None
		Explicit VR Little Endian	1.2.840.10008.1.2.1		
		Implicit VR Little Endian	1.2.840.10008.1.2		
		JPEG Baseline (Process 1)	1.2.840.10008.1.2.4.50		
Ultrasound Multi-frame Image Storage SOP Class	1.2.840.10008.5.1.4.1.1.3.1	Explicit VR Big Endian	1.2.840.10008.1.2.2	SCP	None
		Explicit VR Little Endian	1.2.840.10008.1.2.1		
		Implicit VR Little Endian	1.2.840.10008.1.2		
		JPEG Baseline (Process 1)	1.2.840.10008.1.2.4.50		
X-Ray Angiographic Image Storage SOP Class	1.2.840.10008.5.1.4.1.1.12.1	Explicit VR Big Endian	1.2.840.10008.1.2.2	SCP	None
		Explicit VR Little Endian	1.2.840.10008.1.2.1		
		Implicit VR Little Endian	1.2.840.10008.1.2		
X-Ray Radiofluoroscopic Image Storage SOP Class	1.2.840.10008.5.1.4.1.1.12.2	Explicit VR Big Endian	1.2.840.10008.1.2.2	SCP	None
		Explicit VR Little Endian	1.2.840.10008.1.2.1		
		Implicit VR Little Endian	1.2.840.10008.1.2		
XA reconstructed X-ray SOP Class (private)	1.3.46.670589.2.4.1.1	Explicit VR Big Endian	1.2.840.10008.1.2.2	SCP	None
		Explicit VR Little Endian	1.2.840.10008.1.2.1		
		Implicit VR Little Endian	1.2.840.10008.1.2		

Note: JPEG Baseline only for Ultrasound SOP classes with photometric interpretation of RGB and YBR_FULL_422. Therefore JPEG Baseline transfer syntax may NOT be configured for SCU systems that are capable of handling storage of monochrome images too.

For performance reasons the ELE transfer syntax is preferred and will be chosen in case multiple transfer syntaxes are proposed in the association negotiation.

The ACP AE accepts all contexts in the intersection of the proposed and acceptable presentation contexts. This means that the ACP AE accepts multiple proposed presentation contexts with the same SOP class but different transfer syntaxes. There is no check for duplicate contexts, and these will therefore be accepted.

4.2.1.4.4.3. SOP Specific Conformance for Storage SOP Classes

This section and sub-section includes the manufacturer SOP and Dataset specific information as well the status codes and their corresponding behavior.

The ACP AE provides standard level 1 (Base) conformance to the Storage service class.

4.2.1.4.4.3.1. Dataset Specific Conformance for C-STORE-RSP

Detail regarding the Dataset Specific response behavior will be reported in this section.

This includes the dataset specific behavior, i.e. error codes, error and exception handling, time-outs, etc.

Table 73: Status Response

Service Status	Error Code	Further Meaning	Behavior
Success	0000	Successful stored	The image(s) will be stored in the ACP AE database.
Failure	A700	Refused - Out of Resources	The ACP AE database is full - recovery from this condition is left to the SCU. The ACP AE will send a notification, log the condition, and abort the association.
	A900	Error - Data set does not match SOP class	The SOP class of the image(s) does not match the negotiated abstract syntax. The ACP AE will send a notification, log the condition, and abort the association.
	C000	Error - Cannot understand	The image(s) cannot be parsed. The ACP AE will send a notification, log the condition, and abort the association.
Warning	B000	Coercion of Data Elements	N/A
	B007	Data Set does not match SOP Class	N/A
	B006	Elements Discarded	N/A

4.2.2. RIS AE

Detail of this specific Application Entity is specified in this section.

4.2.2.1. SOP Classes

This Application Entity provides Standard Conformance to the following SOP Classes.

Table 74: SOP Classes for RIS AE

SOP Class Name	SOP Class UID	SCU	SCP
Modality Performed Procedure Step SOP Class	1.2.840.10008.3.1.2.3.3	Yes	No
Modality Worklist Information Model - FIND SOP Class	1.2.840.10008.5.1.4.31	Yes	No
Verification SOP Class	1.2.840.10008.1.1	No	Yes

Note: Any SOP specific behavior is documented later in the conformance statement in the applicable SOP specific conformance section.

4.2.2.2. Association Policies

Each AE specification contains a description of the general association establishment and acceptance policies of the AE.

4.2.2.2.1. General

The DICOM standard application context has specified.

Table 75: DICOM Application Context

Application Context Name	1.2.840.10008.3.1.1.1

4.2.2.2.2. Number of Associations

The number of simultaneous associations that an Application Entity may support as a Initiator or Acceptor is specified.

Table 76: Number of associations as an Association Initiator for this AE

Description	Value
Maximum number of simultaneous associations	configurable

4.2.2.2.3. Asynchronous Nature

Not applicable.

4.2.2.2.4. Implementation Identifying Information

The value supplied for Implementation Class UID and version name are documented here.

Table 77: DICOM Implementation Class and Version for RIS AE

Implementation Class UID	1.3.46.670589.30.1.1
Implementation Version Name	PMS_ELEVA_PA_2.0

4.2.2.2.5. Communication Failure Handling

The behavior of the AE during communication failure is summarized in next table.

Table 78: Communication Failure Behavior

Exception	Behavior
ARTIM Timeout	The association is aborted using A-ABORT and command marked as failed. The reason is logged and reported to the user.
Association aborted	The command is marked as failed. The reason is logged and reported to the user.

4.2.2.3. Association Initiation Policy

The Application Entity will response on a received reject Association attempts as shown in next table.

Table 79: Association Rejection response

Result	Source	Reason/Diagnosis	Behavior
1 - rejected-permanent	1 - DICOM UL service-user	1 - no-reason-given	Association is not established. The following error is logged. Association rejected by peer (1: REJECT_RESULT_permanent, 1: REJECT_SOURCE_dul_user, 1: REJECT_REASON_no_reason_given)

Result	Source	Reason/Diagnosis	Behavior
		2 - application-context-name-not-supported	Association is not established. The following error is logged. Association rejected by peer (1: REJECT_RESULT_permanent, 1: REJECT_SOURCE_dul_user, 2: REJECT_REASON_application_context_not_support)
		3 - calling-AE-title-not-recognized	Association is not established. The following error is logged. Association rejected by peer (1: REJECT_RESULT_permanent, 1: REJECT_SOURCE_dul_user, 3: REJECT_REASON_calling_aetitle_not_recognized)
		7 - called-AE-title-not-recognized	Association is not established. The following error is logged. Association rejected by peer (1: REJECT_RESULT_permanent, 1: REJECT_SOURCE_dul_user, 7: REJECT_REASON_called_aetitle_not_recognized)
	2 - DICOM UL service-provider (ACSE related function)	1 - no-reason-given	Association is not established. The following error is logged. Error: UserRecoverable: impl.dicom.access.PEER: Associationrejected by peer (1: REJECT_RESULT_permanent, 2: REJECT_SOURCE_dul_provider (acse), 1: REJECT_REASON_no_reason_given)
		2 - protocol-version-not-supported	Association is not established. The following error is logged. Association rejected by peer (1: REJECT_RESULT_permanent, 2: REJECT_SOURCE_dul_provider (acse), 2: REJECT_REASON_application_context_not_support)
	3 - DICOM UL service-provider(Presentation related function)	1 - temporary-congestion	Association is not established. The following error is logged. Association rejected by peer (1: REJECT_RESULT_permanent, 3: REJECT_SOURCE_dul_provider (presentation), 1: REJECT_REASON_no_reason_given)
		2 - Local-limit-exceeded	Association is not established. The following error is logged. Association rejected by peer (1: REJECT_RESULT_permanent, 3: REJECT_SOURCE_dul_provider (presentation), 2: REJECT_REASON_application_context_not_support)
2 - rejected-transient	1 - DICOM UL service-user	1 - no-reason-given	Association is not established. The following error is logged. Association rejected by peer (2: REJECT_RESULT_transient, 1: REJECT_SOURCE_dul_user, 1: REJECT_REASON_no_reason_given)
		2 - application-context-name-not-supported	Association is not established. The following error is logged. Association rejected by peer (2: REJECT_RESULT_transient, 1: REJECT_SOURCE_dul_user, 2: REJECT_REASON_application_context_not_support)
		3 - calling-AE-title-not-recognized	Association is not established. The following error is logged. Association rejected by peer (2: REJECT_RESULT_transient, 1: REJECT_SOURCE_dul_user, 3: REJECT_REASON_calling_aetitle_not_recognized)

Result	Source	Reason/Diagnosis	Behavior
		7 - called-AE-title-not-recognized	Association is not established. The following error is logged. Association rejected by peer (2: REJECT_RESULT_transient, 1: REJECT_SOURCE_dul_user, 7: REJECT_REASON_called_aetitle_not_recognized)
	2 - DICOM UL service-provider (ACSE related function)	1 - no-reason-given	Association is not established. The following error is logged. Association rejected by peer (2: REJECT_RESULT_transient, 2: REJECT_SOURCE_dul_provider (acse), 1: REJECT_REASON_no_reason_given)
		2 - protocol-version-not-supported	Association is not established. The following error is logged. Association rejected by peer (2: REJECT_RESULT_transient, 2: REJECT_SOURCE_dul_provider (acse), 2: REJECT_REASON_application_context_not_support)
	3 - DICOM UL service-provider (Presentation related function)	1 - temporary congestion	Association is not established. The following error is logged. Association rejected by peer (2: REJECT_RESULT_transient, 3: REJECT_SOURCE_dul_provider (presentation), 1: REJECT_REASON_no_reason_given)
		2 - local-limit-exceeded	Association is not established. The following error is logged. Association rejected by peer (2: REJECT_RESULT_transient, 3: REJECT_SOURCE_dul_provider (presentation), 2: REJECT_REASON_application_context_not_support)

The behavior of the AE on receiving an association abort is summarized in next table.

Table 80: Association Abort Handling

Source	Reason/Diagnosis	Behavior
0 - DICOM UL service-user (initiated abort)	0 - reason-not-specified	The Eleve terminates the connection with the following log: Association ABORTED by peer (0: ABORT_SOURCE_dul_user, 0: ABORT_REASON_not_specified).
2 - DICOM UL service-provider (initiated abort)	0 - reason-not-specified	The Eleve terminates the connection with the following log: Association ABORTED by peer (2: ABORT_SOURCE_dul_provider, 0: ABORT_REASON_not_specified).
	1 - unrecognized-PDU	The Eleve terminates the connection with the following log: Association ABORTED by peer (2: ABORT_SOURCE_dul_provider, 1: ABORT_REASON_unrecognized_pdu).
	2 - unexpected-PDU	The Eleve terminates the connection with the following log: Association ABORTED by peer (2: ABORT_SOURCE_dul_provider, 2: ABORT_REASON_unexpected_pdu).
	4 - unrecognized-PDU parameter	The Eleve terminates the connection with the following log: Association ABORTED by peer (2: ABORT_SOURCE_dul_provider, 4: ABORT_REASON_unrecognized_pdu_parameter).
	5 - unexpected-PDU parameter	The Eleve terminates the connection with the following log: Association ABORTED by peer (2: ABORT_SOURCE_dul_provider, 5: ABORT_REASON_unexpected_pdu_parameter).

Source	Reason/Diagnosis	Behavior
	6 - invalid-PDU-parameter value	The Eleva terminates the connection with the following log: Association ABORTED by peer (2: ABORT_SOURCE_dul_provider, 6: ABORT_REASON_invalid_pdu_parameter).

4.2.2.3.1. (Real-World) Activity – Modality worklist As SCU

4.2.2.3.1.1. Description and Sequencing of Activities

This activity is a part of Examination Control, which contains the following steps:

- Verification;
- Schedule;
- Acquisition;
- Close Exam.

An examination is regarded equivalent to a DICOM procedure step. It is scheduled or manually entered before an acquisition is being performed.

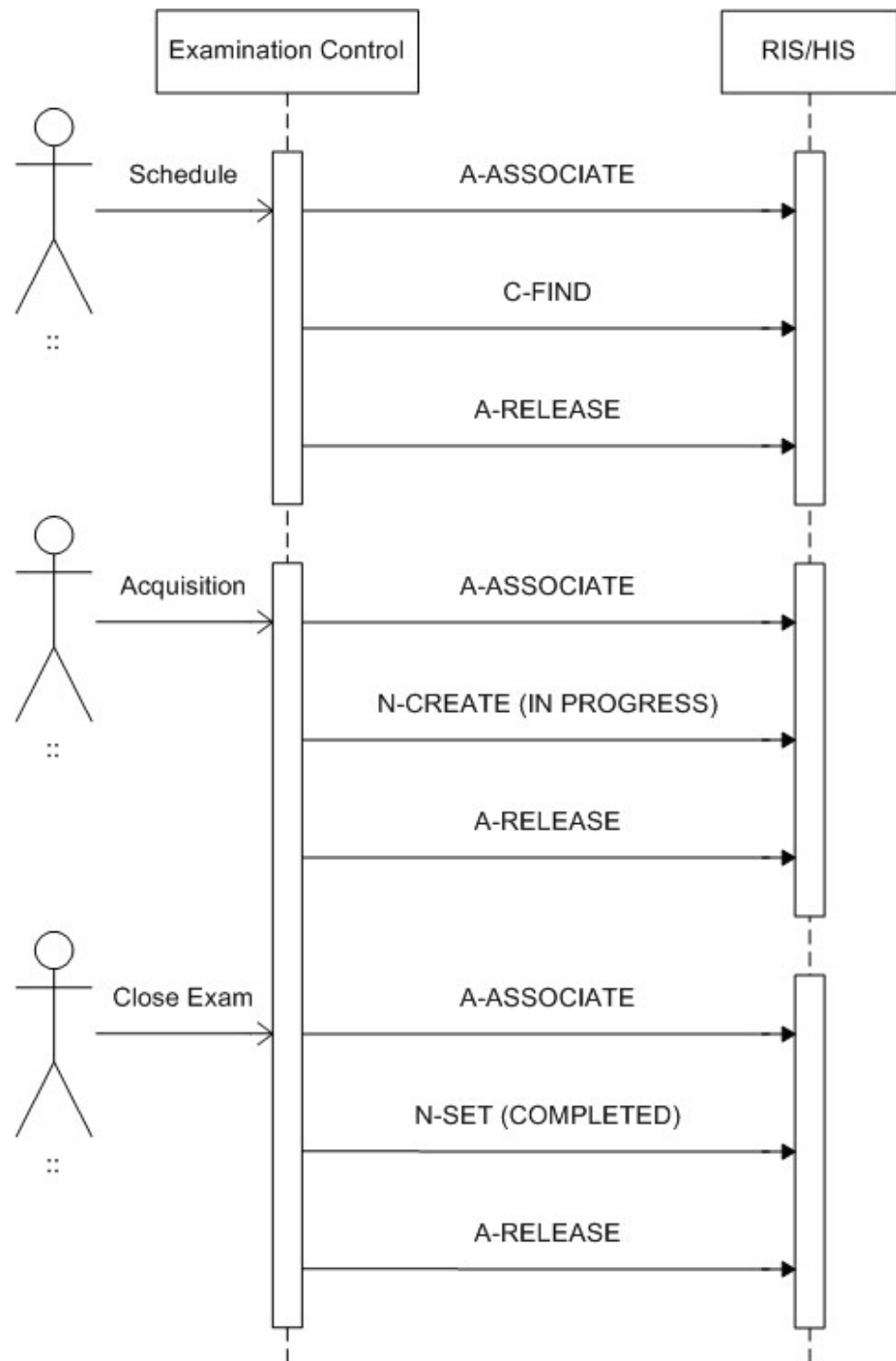

Figure 11: Sequencing of Examination Control

The RWA Schedule distinguishes two queries.

- Broad query: At a configured time interval or after clicking the "RIS Query" button the RIS AE requests an association with the configured remote Basic Worklist Management SCP to perform a broad query. When the association is accepted the RIS AE sends the MWL query request containing the configured matching key values. After the final response the RIS AE releases the association. The MWL query results are displayed in the patient list.

- Patient query: After clicking the "Search RIS" button the operator may modify matching key values. When clicking the "Search now" button the RIS AE requests an association with the configured remote Basic Worklist Management SCP to perform a patient query. When the association is accepted the RIS AE sends the MWL query request containing the specified matching key values. After the final response the RIS AE releases the association. The MWL query results are displayed in the patient list.

The search option is typically triggered by the operator when a patient arrives at the system for examination.

Manually initiated queries can be cancelled by pressing the "Cancel" button on the user interface. In that case the DICOM association will be aborted immediately. As the query is performed asynchronously, intermediate results may be displayed in the mean time.

Now the operator may select a patient examination using the Assisted Acquisition Protocol Setting option.

The RIS AE by default derives the specific acquisition protocol from the Scheduled Protocol Code Sequence items. Furthermore the RIS AE supports 3 more configurable mapping relations. Thus the examination may be selected from:

- Scheduled Protocol Code items -> Code Value (0040,0008) (default);
- Scheduled Procedure Step Description (0040,0007);
- Requested Procedure Code items -> Code Value (0032,1064);
- Requested Procedure Description (0032,1060).

The RIS AE does not evaluate the attributes Coding Scheme Designator (0008,0102), Coding Scheme Version (0008,0103), Code Meaning (0008,0104), but only the Code Value (0008,0100) for mapping the examination settings. Consequently the RIS AE assumes that any used Code Value is unambiguous within the actual RIS domain.

The RIS AE has no limit for the number of items in the Scheduled Protocol Code Sequence.

Any single item results in one or more examinations (depending on the configured mapping). If a sequence contains more than one protocol code, these codes will be displayed as separate examinations on the UI but will be handled by one common MPPS instance.

When an examination is initiated the RIS AE will create an MPPS entry by sending the MPPS N-CREATE message with status IN PROGRESS to the RIS.

When an examination is performed the scheduled protocol code of the examination will be appended to the Performed Protocol Code Sequence of the MPPS.

Each time an acquisition is archived the RIS AE will keep a record of the related MPPS details. When the operator closes the exam the RIS AE will update the RIS by sending the MPPS N-SET message with status COMPLETED.

The operator may cancel an unclosed examination at any time. Depending on the state of the examination and MPPS related system configuration, the MPPS IN PROGRESS message already may have been sent (discontinued case) or not (abandoned case). If not (abandoned case), the RIS AE first generates the MPPS N-CREATE IN PROGRESS message. In both cases the RIS AE sends the MPPS N-SET DISCONTINUED message.

4.2.2.3.1.2. Proposed Presentation Contexts

The presentation contexts are defined in next table.

Table 81: Proposed Presentation Contexts for (Real-World) Activity – Modality worklist As SCU

Presentation Context Table					
Abstract Syntax		Transfer Syntax		Role	Extended Negotiation
Name	UID	Name List	UID List		
Modality Worklist Information Model - FIND SOP Class	1.2.840.10008.5.1.4.31	Explicit VR Big Endian	1.2.840.10008.1.2.2	SCU	None
		Explicit VR Little Endian	1.2.840.10008.1.2.1		
		Implicit VR Little Endian	1.2.840.10008.1.2		

Note: ELE is preferred Transfer Syntax.

4.2.2.3.1.3. SOP Specific Conformance for Modality Worklist Information Model - FIND SOP Class

This section and sub-section includes the manufacturer SOP and Dataset specific information as well the status codes and their corresponding behavior.

4.2.2.3.1.3.1. Dataset Specific Conformance for Modality Worklist Information Model - FIND C-FIND SCU

Detail regarding the Dataset Specific response behavior will be reported in this section.

When date matching is configured, the date value is continuously generated from local system time, including nightshift tolerance in the morning hours taking the schedule from "yesterday".

If the query response contains inconsistent values then the query is retried. Then if the inconsistency still exists the RIS AE will send an A-ABORT with "reason-not-specified".

The Table below provides a description of the RIS AE Worklist Request Identifier and specifies the attributes that are copied into the images.

The table below should be read as follows:

- Attribute Name: Attributes supported to build a Modality Worklist Request Identifier.
- Tag: DICOM tag for this attribute.
- VR: DICOM VR for this attribute.
- M: Matching Keys for (automatic) Worklist Update.
- R: Return Keys. An "X" will indicate that this attribute as Return Key with zero length for Universal Matching.
- Q: Interactive Query Key. An "X" will indicate that this attribute as matching key can be used.
- D: Displayed Keys. An "X" indicates that this Worklist attribute is displayed to the user during a patient registration dialog.
- IOD: An "X" indicates that this Worklist attribute is included into all object Instances created during performance of the related Procedure Step.

Type of matching: The following types of matching exists:

Single Value Matching
List of UID Matching
Wild Card Matching
Range Matching
Sequence Matching
Universal Matching

Table 82: Worklist Request Identifier

Attribute Name	Tag	VR	M	R	Q	D	IOD	Type of Matching	Comment
SOP Common Module									
Specific Character Set	0008,0005	CS	X				X		Configurable.
Patient Identification Module									
Issuer of Patient ID	0010,0021	LO		X					
Other Patient IDs	0010,1000	LO		X		X			Other patient IDs.
Patient ID	0010,0020	LO		X	X	X	X	Single Value, Universal, WildCard	Patient ID. Optional matching key for patient query.
Patient's Name	0010,0010	PN		X	X	X	X	Single Value, Universal, WildCard	Name. Optional matching key for patient query.
Patient Demographic Module									
Confidentiality Constraint on Patient Data Description	0040,3001	LO		X					
Ethnic Group	0010,2160	SH		X		X			
Occupation	0010,2180	SH							
Patient Comments	0010,4000	LT		X		X			
Patient's Age	0010,1010	AS							
Patient's Birth Date	0010,0030	DA		X		X	X		Date of birth. Used to determine patient type.
Patient's Sex	0010,0040	CS		X		X	X		Gender.
Patient's Size	0010,1020	DS		X		X			Height. Used to determine patient type.
Patient's Weight	0010,1030	DS		X		X			Weight. Used to determine patient type.
Patient Medical Module									
Additional Patient History	0010,21B0	LT		X		X			
Contrast Allergies	0010,2110	LO		X		X			
Medical Alerts	0010,2000	LO		X		X			
Pregnancy Status	0010,21C0	US		X		X			
Special Needs	0038,0050	LO		X					
Visit Status Module									
Current Patient Location	0038,0300	LO		X					
Scheduled Procedure Step Module									
Scheduled Procedure Step Sequence	0040,0100	SQ		X					
>Comments on the Scheduled Procedure Step	0040,0400	LT		X					
>Modality	0008,0060	CS	X	X	X			Single Value, Universal	Modality. Configurable matching key values: ""
>Pre-Medication	0040,0012	LO		X					
>Requested Contrast Agent	0032,1070	LO		X					
>Scheduled Performing Physician's Name	0040,0006	PN		X		X	X		
>Scheduled Procedure Step Description	0040,0007	LO		X		X	X		
>Scheduled Procedure Step End Date	0040,0004	DA		X					
>Scheduled Procedure Step End Time	0040,0005	TM		X					

Attribute Name	Tag	VR	M	R	Q	D	IOD	Type of Matching	Comment
>Scheduled Procedure Step ID	0040,0009	SH		X			X		Configurable.
>Scheduled Procedure Step Location	0040,0011	SH		X					
>Scheduled Procedure Step Start Date	0040,0002	DA	X	X	X	X		Single Value,Universal	Date. Displayed until examination becomes in progress. Optional matching key for broad and patient query.
>Scheduled Procedure Step Start Time	0040,0003	TM		X		X			Time. Displayed until examination becomes in progress.
>Scheduled Procedure Step Status	0040,0020	CS		X					
>Scheduled Station AE Title	0040,0001	AE	X	X	X			Single Value,Universal	Scheduled station. Optional matching key for broad query and patient query.
>Scheduled Station Name	0040,0010	SH		X					
>Scheduled Protocol Code Sequence	0040,0008	SQ							
>>Code Meaning	0008,0104	LO							
>>Code Value	0008,0100	SH							
>>Coding Scheme Designator	0008,0102	SH							
>>Coding Scheme Version	0008,0103	SH							
Requested Procedure Module									
Names of Intended Recipients of Results	0040,1010	PN		X		X			
Patient Transport Arrangements	0040,1004	LO		X		X			
Reason for the Requested Procedure	0040,1002	LO		X		X			
Requested Procedure Comments	0040,1400	LT		X		X			
Requested Procedure Description	0032,1060	LO		X		X			
Requested Procedure ID	0040,1001	SH		X	X	X	X	Single Value,Universal, WildCard	Request ID. Optional matching key for patient query.
Requested Procedure Priority	0040,1003	SH		X		X			
Study Instance UID	0020,000D	UI		X			X		
Referenced Study Sequence	0008,1110	SQ		X			X		
>Referenced SOP Class UID	0008,1150	UI		X			X		
>Referenced SOP Instance UID	0008,1155	UI		X			X		
Requested Procedure Code Sequence	0032,1064	SQ		X					
>Code Meaning	0008,0104	LO		X		X			
>Code Value	0008,0100	SH		X		X			
>Coding Scheme Designator	0008,0102	SH		X					
>Coding Scheme Version	0008,0103	SH		X					
Imaging Service Request Module									
Accession Number	0008,0050	SH		X	X	X	X	Single Value,Universal, WildCard	Accession No. Optional matching key for patient query.
Imaging Service Request Comments	0040,2400	LT		X		X			
Issue Date of Imaging Service Request	0040,2004	DA		X		X			
Reason for the Imaging Service Request (RETIRED)	0040,2001	LO		X		X			
Referring Physician's Name	0008,0090	PN		X		X	X		
Requesting Physician	0032,1032	PN		X		X			
Requesting Service	0032,1033	LO		X		X			

This part of the section includes the dataset specific behavior, i.e. error codes, error and exception handling, time-outs, etc.

Table 83: Status Response

Service Status	Error Code	Behavior
Success	0000	The worklist is updated.
Failure	A700	The association is released. The reason is logged.
	A900	Failed - Identifier does not match SOP class
	Cxxx	Failed - Unable to process
Cancel	FE00	The association is released. The reason is logged.
Pending	FF00	The MWL query job continues.

4.2.2.3.2. (Real-World) Activity – Modality Performed Procedure Step As SCU

4.2.2.3.2.1. Description and Sequencing of Activities

This activity is a part of Examination Control, which contains the following steps:

- Verification;
- Schedule;
- Acquisition;
- Close Exam.

See chapter 4.2.2.3.1.1 for the description and sequence diagram.

4.2.2.3.2.2. Proposed Presentation Contexts

The presentation contexts are defined in next table.

Table 84: Proposed Presentation Contexts for (Real-World) Activity – Modality Performed Procedure Step As SCU

Presentation Context Table					
Abstract Syntax		Transfer Syntax		Role	Extended Negotiation
Name	UID	Name List	UID List		
Modality Performed Procedure Step SOP Class	1.2.840.10008.3.1.2.3.3	Explicit VR Big Endian	1.2.840.10008.1.2.2	SCU	None
		Explicit VR Little Endian	1.2.840.10008.1.2.1		
		Implicit VR Little Endian	1.2.840.10008.1.2		

Note: ELE is preferred Transfer Syntax.

4.2.2.3.2.3. SOP Specific Conformance for Modality Performed Procedure Step SOP Class

This section and sub-section includes the manufacturer SOP and Dataset specific information as well the status codes and their corresponding behavior.

If scheduled by the RIS, each examination is the result of one Scheduled Procedure Step. Since an exam may not be re-opened after having been closed, and each exam

workflow context is enclosed in one MPPS, one exam may result in 0:1 MPPS instances. However, image archiving after the examination's closure leads to 1:n MPPS instances per exam.

When the exam is initiated, at first acquisition the RIS AE generates an MPPS N-SET message with status IN PROGRESS. The RIS AE does not generate any intermediate MPPS IN PROGRESS messages for subsequent acquisitions of this examination.

When closing the exam, the RIS AE generates an MPPS N-SET message with status COMPLETED. If the MPPS contains multiple examinations then the operator will be notified to confirm closure of current examination or all examinations. The exam cannot be reopened.

The RIS AE also generates MPPS messages for unscheduled exams.

4.2.2.3.2.3.1. Dataset Specific Conformance for Modality Performed Procedure Step N-CREATE SCU

Detail regarding the Dataset Specific response behavior will be reported in this section.

Table 85: MPPS Request Identifiers for N-CREATE-RQ

Attribute Name	Tag	VR	Value	Comment
Performed Procedure Step Information Module				
Performed Location	0040,0243	SH		As configured.
Performed Procedure Step Description	0040,0254	LO		Copied from MWL.
Performed Procedure Step End Date	0040,0250	DA		Date on which the Performed Procedure Step ended.
Performed Procedure Step End Time	0040,0251	TM		Time on which the Performed Procedure Step ended.
Performed Procedure Step ID	0040,0253	SH		
Performed Procedure Step Start Date	0040,0244	DA		Date on which the Performed Procedure Step started.
Performed Procedure Step Start Time	0040,0245	TM		Time on which the Performed Procedure Step started.
Performed Procedure Step Status	0040,0252	CS	IN PROGRESS	
Performed Procedure Type Description	0040,0255	LO		From User. A description of the type of procedure performed.
Performed Station AE Title	0040,0241	AE		As configured.
Performed Station Name	0040,0242	SH		As configured.
Procedure Code Sequence	0008,1032	SQ		Contents copied from MWL Requested Procedure Code Sequence.
>Code Meaning	0008,0104	LO		
>Code Value	0008,0100	SH		
>Coding Scheme Designator	0008,0102	SH		
>Coding Scheme Version	0008,0103	SH		
Radiation Dose Module				
Entrance Dose	0040,0302	US		
Image and Fluoroscopy Area Dose Product	0018,115E	DS		
Total Number of Exposures	0040,0301	US		
Total Time of Fluoroscopy	0040,0300	US		
Exposure Dose Sequence	0040,030E	SQ		

Attribute Name	Tag	VR	Value	Comment
>Exposure Time	0018,1150	IS		
>Filter Material	0018,7050	CS		
>Filter Type	0018,1160	SH		
>KVP	0018,0060	DS		
>Radiation Mode	0018,115A	CS		
>X-Ray Tube Current in uA	0018,8151	DS		
SOP Common Module				
Specific Character Set	0008,0005	CS		
Performed Procedure Step Relationship Module				
Patient ID	0010,0020	LO		Copied from MWL or entered by operator.
Patient's Birth Date	0010,0030	DA		Copied from MWL or entered by operator.
Patient's Name	0010,0010	PN		Copied from MWL or entered by operator.
Patient's Sex	0010,0040	CS		Copied from MWL or entered by operator.
Referenced Patient Sequence	0008,1120	SQ		Zero length.
>Referenced SOP Class UID	0008,1150	UI		
>Referenced SOP Instance UID	0008,1155	UI		
Scheduled Step Attributes Sequence	0040,0270	SQ		
>Accession Number	0008,0050	SH		
>Requested Procedure Description	0032,1060	LO		Copied from MWL.
>Requested Procedure ID	0040,1001	SH		
>Scheduled Procedure Step Description	0040,0007	LO		Copied from MWL.
>Scheduled Procedure Step ID	0040,0009	SH		
>Study Instance UID	0020,000D	UI		
>Referenced Study Sequence	0008,1110	SQ		
>>Referenced SOP Class UID	0008,1150	UI	1.2.840.10008.3.1.2.3.1	
>>Referenced SOP Instance UID	0008,1155	UI		
>Scheduled Protocol Code Sequence	0040,0008	SQ		Contents copied from MWL.
>>Code Meaning	0008,0104	LO		
>>Code Value	0008,0100	SH		
>>Coding Scheme Designator	0008,0102	SH		
>>Coding Scheme Version	0008,0103	SH		
Image Acquisition Results Module				
Modality	0008,0060	CS	RF	
Study ID	0020,0010	SH		If scheduled then copied from Requested Procedure ID, else equipment generated study identifier.
Performed Protocol Code Sequence	0040,0260	SQ		Zero length.
>Code Meaning	0008,0104	LO		
>Code Value	0008,0100	SH		
>Coding Scheme Designator	0008,0102	SH		
>Coding Scheme Version	0008,0103	SH		
>Protocol Context Sequence	0040,0440	SQ		
>>Content Item Modifier Sequence	0040,0441	SQ		
>>>Date	0040,A121	DA		
>>>DateTime	0040,A120	DT		
>>>Numeric Value	0040,A30A	DS		
>>>Person Name	0040,A123	PN		

Attribute Name	Tag	VR	Value	Comment
>>>Text Value	0040,A160	UT		
>>>Time	0040,A122	TM		
>>>UID	0040,A124	UI		
>>>Value Type	0040,A040	CS		
>>>Concept Code Sequence	0040,A168	SQ		
>>>>Code Meaning	0008,0104	LO		
>>>>Code Value	0008,0100	SH		
>>>>Coding Scheme Designator	0008,0102	SH		
>>>>Coding Scheme Version	0008,0103	SH		
>>>>Context Group Extension Creator UID	0008,010D	UI		
>>>>Context Group Extension Flag	0008,010B	CS		
>>>>Context Group Local Version	0008,0107	DT		
>>>>Context Group Version	0008,0106	DT		
>>>>Context Identifier	0008,010F	CS		
>>>>Mapping Resource	0008,0105	CS		
>>>Concept Name Code Sequence	0040,A043	SQ		
>>>>Code Meaning	0008,0104	LO		
>>>>Code Value	0008,0100	SH		
>>>>Coding Scheme Designator	0008,0102	SH		
>>>>Coding Scheme Version	0008,0103	SH		
>>>>Context Group Extension Creator UID	0008,010D	UI		
>>>>Context Group Extension Flag	0008,010B	CS		
>>>>Context Group Local Version	0008,0107	DT		
>>>>Context Group Version	0008,0106	DT		
>>>>Context Identifier	0008,010F	CS		
>>>>Mapping Resource	0008,0105	CS		
>>>Measurement Units Code Sequence	0040,08EA	SQ		
>>>>Code Meaning	0008,0104	LO		
>>>>Code Value	0008,0100	SH		
>>>>Coding Scheme Designator	0008,0102	SH		
>>>>Coding Scheme Version	0008,0103	SH		
>>>>Context Group Extension Creator UID	0008,010D	UI		
>>>>Context Group Extension Flag	0008,010B	CS		
>>>>Context Group Local Version	0008,0107	DT		
>>>>Context Group Version	0008,0106	DT		
>>>>Context Identifier	0008,010F	CS		
>>>>Mapping Resource	0008,0105	CS		
>>Date	0040,A121	DA		
>>DateTime	0040,A120	DT		
>>Numeric Value	0040,A30A	DS		
>>Person Name	0040,A123	PN		
>>Text Value	0040,A160	UT		
>>Time	0040,A122	TM		
>>UID	0040,A124	UI		
>>Value Type	0040,A040	CS		
>>Concept Code Sequence	0040,A168	SQ		
>>Concept Name Code	0040,A043	SQ		

Attribute Name	Tag	VR	Value	Comment
Sequence				
>>Measurement Units Code Sequence	0040,08EA	SQ		
Performed Series Sequence	0040,0340	SQ		Zero length.
>Operators' Name	0008,1070	PN		
>Performing Physician's Name	0008,1050	PN		
>Protocol Name	0018,1030	LO		
>Retrieve AE Title	0008,0054	AE		
>Series Description	0008,103E	LO		
>Series Instance UID	0020,000E	UI		
>Referenced Image Sequence	0008,1140	SQ		
>>Referenced SOP Class UID	0008,1150	UI		
>>Referenced SOP Instance UID	0008,1155	UI		
>>Referenced Frame Number	0008,1160	IS		
>>Referenced SOP Class UID	0008,1150	UI		
>>Referenced SOP Instance UID	0008,1155	UI		
>Referenced Non-Image Composite SOP Instance Sequence	0040,0220	SQ		
>>Referenced SOP Class UID	0008,1150	UI		
>>Referenced SOP Instance UID	0008,1155	UI		
Billing And Material Management Code Module				
Film Consumption Sequence	0040,0321	SQ		
>Film Size ID	2010,0050	CS		
>Medium Type	2000,0030	CS		
>Number of Films	2100,0170	IS		
Additional Module				
Issuer of Patient ID	0010,0021	LO		

This part of the section includes the dataset specific behavior, i.e. error codes, error and exception handling, time-outs, etc.

Table 86: Status Response

Service Status	Error Code	Further Meaning	Behavior
Success	0000	Successful operation	The SCP has successfully received the modality performed procedure step set request. Log entry.
Failure	0231	Processing failure - performed procedure step object may no longer be updated	The reason is logged.
	xxxx	(any other failure)	The reason is logged.

4.2.2.3.2.3.2. Dataset Specific Conformance for Modality Performed Procedure Step N-SET SCU

Detail regarding the Dataset Specific response behavior will be reported in this section.

Table 87: MPPS Request Identifiers for N-SET-RQ

Attribute Name	Tag	VR	Value	Comment
Performed Procedure Step Information Module				
Performed Procedure Step Description	0040,0254	LO		Copied from MWL.
Performed Procedure Step End Date	0040,0250	DA		
Performed Procedure Step End Time	0040,0251	TM		
Performed Procedure Step Status	0040,0252	CS	COMPLETED, DISCONTINUED	
Procedure Code Sequence	0008,1032	SQ		Contents copied from MWL Requested Procedure Code Sequence.
>Code Meaning	0008,0104	LO		
>Code Value	0008,0100	SH		
>Coding Scheme Designator	0008,0102	SH		
>Coding Scheme Version	0008,0103	SH		
Radiation Dose Module				
Entrance Dose	0040,0302	US		Not sent in case of appended MPPS instances.
Image and Fluoroscopy Area Dose Product	0018,115E	DS		Not accumulating re-processed and non-digital images. Not sent in case of appended MPPS instances.
Total Number of Exposures	0040,0301	US		Not counting re-processed images. Not sent in case of appended MPPS instances.
Total Time of Fluoroscopy	0040,0300	US		Not sent in case of appended MPPS instances.
Exposure Dose Sequence	0040,030E	SQ		Limited to 400 elements
>Exposure Time	0018,1150	IS		
>Filter Material	0018,7050	CS	ALUMINIUM, COPPER	None / 1mm Al + 0.1mm Cu / 1mm Al + 0.2mm Cu / 1mm Al + 0.3mm Cu.
>KVP	0018,0060	DS		
>Radiation Mode	0018,115A	CS	CONTINUOUS, PULSED	
>X-Ray Tube Current in uA	0018,8151	DS		
Image Acquisition Results Module				
Performed Protocol Code Sequence	0040,0260	SQ		All Scheduled Protocol Code Sequence items from MWL for which radiation has been released.
>Code Meaning	0008,0104	LO		
>Code Value	0008,0100	SH		
>Coding Scheme Designator	0008,0102	SH		
>Coding Scheme Version	0008,0103	SH		
Performed Series Sequence	0040,0340	SQ		One item per series or dummy value.
>Operators' Name	0008,1070	PN		
>Performing Physician's Name	0008,1050	PN		The current physician as selected on DAM
>Protocol Name	0018,1030	LO	unknown	
>Retrieve AE Title	0008,0054	AE		
>Series Description	0008,103E	LO		
>Series Instance UID	0020,000E	UI		

Attribute Name	Tag	VR	Value	Comment
>Referenced Image Sequence	0008,1140	SQ		
>>Referenced SOP Class UID	0008,1150	UI	1.2.840.10008.5.1.4.1.1 .12.2	As exported by ACP AE.
>>Referenced SOP Instance UID	0008,1155	UI		As exported by ACP AE.
>Referenced Non-Image Composite SOP Instance Sequence	0040,0220	SQ		
>>Referenced SOP Class UID	0008,1150	UI	1.2.840.10008.5.1.4.1.1 .11.1	As exported by ACP AE.
>>Referenced SOP Instance UID	0008,1155	UI		As exported by ACP AE.
Billing And Material Management Code Module				
Film Consumption Sequence	0040,0321	SQ		
>Film Size ID	2010,0050	CS		
>Medium Type	2000,0030	CS		
>Number of Films	2100,0170	IS		

Note: The Radiation Dose Module does not have meaning if the modality does not generate ionizing radiation or if the generator does not provide the area dose product.

This part of the section includes the dataset specific behavior, i.e. error codes, error and exception handling, time-outs, etc.

Table 88: Status Response

Service Status	Error Code	Further Meaning	Behavior
Success	0000	Successful operation	The SCP has successfully received the modality performed procedure step set request. Log entry.
Failure	0110	Processing failure - performed procedure step object may no longer be updated	The reason is logged.
	xxxx	(any other failure)	The reason is logged.

4.2.2.4. Association Acceptance Policy

The Application Entity may reject Association attempts as shown in the table below.

Table 89: Association Reject Reasons

Result	Source	Reason/Diagnosis	Explanation	
1 - rejected-permanent	1 - DICOM UL service-user	1 - no-reason-given	Association is not established due to any problem other than that specified in the rows below.	
		2 - application-context-name-not-supported	An application context name other than 1.2.840.10008.3.1.1.1 is requested by the SCU during association.	
		3 - calling-AE-title-not-recognized	The configuration does not contain a repository having the Calling AE Title as per the association request, or there is a problem in configuration (related to composing the configuration from the SCU and the SCP configuration).	
		7 - called-AE-title-not-recognized	The called AE Title in the association request does not match the AE Title as per the configuration.	
	2 - DICOM UL service provider (ACSE related function)	1 - no-reason-given	Not used.	
		2 - protocol-version-not-supported	Not used.	
		3 - DICOM UL service provider (Presentation related function)	1 - temporary-congestion 2 - local-limit-exceeded	Not used. Not used.
	2 - rejected-transient	1 - DICOM UL service-user	1 - no-Reason-given	Not used.
			2 - application-context-name-not-supported	Not used.
3 - calling-AE-title-not-recognized			Not used.	
7 - called-AE-title-not-recognized			Not used.	
2 - DICOM UL service provider (ACSE related function)		1 - no-reason-given	Maximum number of associations is exceeded and an association request is received.	
		2 - protocol-version-not-supported	Not used.	
		3 - DICOM UL service provider (Presentation related function)	1 - temporary-congestion 2 - local-limit-exceeded	Not used. Not used.

The behavior of the AE for sending an association abort is summarized in next table

Table 90: Association Abort Policies

Source	Reason/Diagnosis	Behavior
0 - DICOM UL service-user (initiated abort)	0 - reason-not-specified	Association times out due to inactivity Any other problem than ones specified in the rows below. (Examples: Problem while decoding the DICOM stream, Invalid request, Echo SCP was unable to send the Response to SCU, Error writing to SCU stream).
2 - DICOM UL service-provider (initiated abort)	0 - reason-not-specified	
	1 - unrecognized-PDU	An unrecognized PDU type is received.
	2 - unexpected-PDU	The received PDU type is not expected in the current state of connection.

Source	Reason/Diagnosis	Behavior
	4 - unrecognized-PDU parameter	An unrecognized Associate PDU item is received.
	5 - unexpected-PDU parameter	One of the Associate PDU items is received more than once. One of the Associate PDU items is received unexpectedly.
	6 - invalid-PDU-parameter value	One of the Associate PDU items is received more than once. One of the Associate PDU items is not received. Empty Called AE Title String (space-only) is received. Empty Calling AE Title String (space-only) is received. Unknown abstract syntax is received. The length or the format of the received PDU item is invalid.

4.2.2.4.1. (Real-World) Activity – Verification as SCP

4.2.2.4.1.1. Description and Sequencing of Activities

The RIS AE accepts associations from systems that wish to verify application level communication using the C-ECHO command.

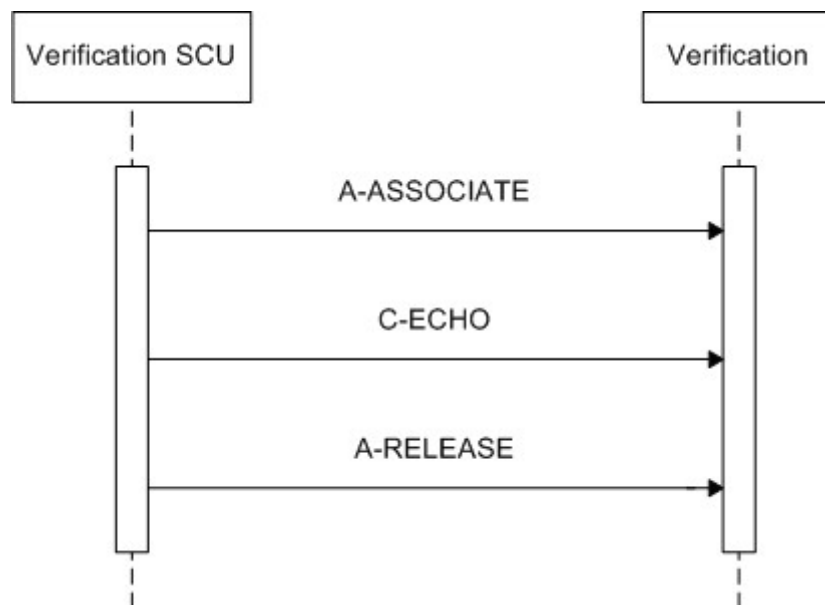

Figure 12: Sequencing of Verification

4.2.2.4.1.2. Accepted Presentation Contexts

The presentation contexts are defined in next table.

Table 91: Acceptable Presentation Contexts for (Real-World) Activity – Verification as SCP

Presentation Context Table					
Abstract Syntax		Transfer Syntax		Role	Extended Negotiation
Name	UID	Name List	UID List		
Verification SOP Class	1.2.840.10008.1.1	Explicit VR Big Endian	1.2.840.10008.1.2.2	SCP	None
		Explicit VR Little Endian	1.2.840.10008.1.2.1		
		Implicit VR Little Endian	1.2.840.10008.1.2		

For performance reasons the ELE transfer syntax is preferred and will be chosen in case multiple transfer syntaxes are proposed in the association negotiation.

The RIS AE accepts all contexts in the intersection of the proposed and acceptable presentation contexts. This means that the RIS AE accepts multiple proposed presentation contexts with the same SOP class but different transfer syntaxes. There is no check for duplicate contexts, and these will therefore be accepted.

4.2.2.4.1.3. SOP Specific Conformance for Verification SOP Class

This section and sub-section includes the manufacturer SOP and Dataset specific information as well the status codes and their corresponding behavior.

4.2.2.4.1.3.1. Dataset Specific Conformance for Verification C-ECHO SCP

Detail regarding the Dataset Specific response behavior will be reported in this section.

This part of the section includes the dataset specific behavior, i.e. error codes, error and exception handling, time-outs, etc.

Table 92: Status Response

Service Status	Error Code	Further Meaning	Behavior
Success	0000	Verification is successful	The ACP AE is able to confirm application level communication.

4.3. Network Interfaces

4.3.1. Physical Network Interfaces

The System provides only DICOM V3.0 TCP/IP Network Communication Support as defined in PS 3.8 of the standard.

TCP/IP is the only protocol stack supported.

Supported physical medium include:

IEEE 802.3-1995 10BASE-T

IEEE 802.3-1995 100BASE-TX (Fast Ethernet)

IEEE 802.3 1000BASE-X (Fiber Optic Gigabit Ethernet).

The TCP/IP Stack as supported by the underlying Operating System.

The API is the WinSock 2 interface as supported by the underlying Operating System.

4.3.2. Additional Protocols

Not applicable

4.4. Configuration

Any implementations DICOM conformance may be dependent upon configuration, which takes place at the time of installation. Issues concerning configuration is addressed in this section.

4.4.1. AE Title/Presentation Address Mapping

An important installation issue is the translation from AE title to presentation address. How this is to be performed is describe here.

Note: The Eleva system is configured by means of a configuration program. This program is accessible at start-up of the Eleva system. It is password protected and intended to be used by Philips Customer Support Engineers only. The configuration program will prompt the Customer Support Engineer to enter configuration information as required by the Eleva.

4.4.1.1. Local AE Titles

The Eleva exists of two Application Entity titles and two IP addresses; one for the RIS AE and one for the ACP AE. At installation the Customer Support Engineer can change the ACP AE host name. The ACP AE can be changed independently.

The local AE title mapping and configuration are specified as:

Table 93: AE Title configuration table

Application Entity	Default AE Title	Default TCP/IP Port
RIS AE	<IP host name of the RIS AE>	3010
ACP AE	<IP host name of the ACP AE>	3010 (not configurable)

4.4.1.2. Remote AE Title/Presentation Address Mapping

Specified is here the configuration of the remote application.

For the RIS AE the AE Title, host names and port numbers of remote applications are configured using the FSF Service tool.

For the ACP AE the AE Title, host names and port numbers of remote applications are configured using the Configuration tool.

Remote Association Initiators

All relevant remote applications that are able to setup a DICOM association towards the ACP AE must be configured at Eleva configuration time.

The Customer Support Engineer must provide the following information for each remote application:

- The Application Entity Title;
- The SOP classes and transfer syntaxes for which the ACP AE accepts associations.

Remote Association Acceptors

The following information must be provided for all relevant remote applications that are able to accept DICOM associations from the RIS AE or the ACP AE:

- The Application Entity Title;
- The Host name / IP address on which the remote application resides;
- The port number at which the remote application accepts association requests.

4.4.2. Parameters

The specification of important operational parameters, their default value and range (if configurable) is specified here.

The configuration parameters for the ACP AE are given in the next table.

Table 94: ACP AE Configuration Parameters table

Parameter	Configurable	Default Value
General Parameters		
Time-out waiting for acceptance or rejection Response to an Association Open Request. (Application Level timeout)	No	
General DIMSE level time-out values	No	
Time-out waiting for response to TCP/IP connect request. (Low-level timeout)	No	
Time-out waiting for acceptance of a TCP/IP message over the network. (Low-level timeout)	No	
Time-out for waiting for data between TCP/IP packets. (Low-level timeout)	No	
Any changes to default TCP/IP settings, such as configurable stack parameters.	No	
Local Configurable Parameters		
Size constraint in maximum object size (see note 1)	No	
Maximum PDU size the AE can receive	Yes	0 (unlimited)
Maximum PDU size the AE can send	No	unlimited
AE specific DIMSE level time-out values	No	
Number of simultaneous associations by service and/or SOP class	No	
SOP class support	Yes	none

Parameter	Configurable	Default Value
Transfer syntax support (see note 1)	Yes	ELE
Remote Configurable Parameters		
Size constraint in maximum object size	No	
Maximum PDU size the AE can receive	Yes	0 (unlimited)
Maximum PDU size the AE can send	No	unlimited
AE specific DIMSE level time-out values	No	
Number of simultaneous associations by service and/or SOP class	No	
SOP class support	Yes	none
Transfer syntax support	Yes	ELE
Storage commitment request must be sent after storage request	Yes	not
Storage commitment time-out (synchronous to asynchronous)	Yes	none
Automatic conversion of images of SOP classes not supported by remote systems into Secondary Capture Image Storage SOP instances	Yes	convert to SC
Export of pure DICOM images (i.e. only the standard DICOM attributes as defined in the related IOD) or extended DICOM images (with additional Standard DICOM, Private and Retired attributes)	Yes	allow all attributes
Support of overlays for DICOM node not supporting Presentation State objects (see note 2)	Yes	enabled
Support of overlays for DICOM node supporting presentation state objects (see note 2)	Yes	disabled
Support of overlays for CD (see note 2)	Yes	disabled
General Print Parameters		
The DICOM printers that may be selected by the operator	Yes	none
Printer Specific Print Parameters (see note 3)		
Medium type	Yes	all available
Film size ID (i.e. media size)	Yes	all available
Resolution (300 / 600 dpi)	Yes	300
Color model (8 / 16 bits color)	Yes	8
Min Density	Yes	0
Max Density	Yes	0

Notes:

1. The JPEG Baseline transfer syntax is only supported for RGB and YBR_FULL_422 images; therefore JPEG Baseline may NOT be configured for systems that are capable of handling storage of monochrome images too.
2. The MultiDiagnost Eleva with Flat Detector Copy-tool can override the configured setting of overlay support.
3. These print parameters can be selected from choice lists. These choice lists are defined via so-called prototypes for each type of printer and print medium. These prototypes are also configurable.

The configuration parameters for the RIS AE are given in the next table.

Table 95: RIS AE Configuration Parameters table

Parameter	Configurable	Default Value
General Parameters		
Time-out waiting for acceptance or rejection Response to an Association Open Request. (Application Level timeout)	Yes	0 (unlimited)
System Control - Location Parameters		
Location - Local system ID (Station Name < 16 Characters)	Yes	RF_System
Location - Hospital name (Institution Name)	Yes	Hospital
System Control - Patient Database Parameters		
Patient Database - Issuer of Patient ID	Yes	
RIS - Network Parameters		

Parameter	Configurable	Default Value
IP address	Yes	
Subnet mask	Yes	
Default gateway	Yes	
RIS - System DICOM Node Parameters		
AE Title	Yes	IP host name of the RIS AE
PortNumber	Yes	3010
Max Data PDU Length	Yes	16384
Artim timeout	Yes	60[s]
Maximum nr of incoming associations	Yes	
RIS - External DICOM Nodes Parameters		
AE Title	Yes	
PortNumber	Yes	
IP Address	Yes	
Artim Timeout	Yes	
Automatic Association Timeout	Yes	
SOP class support	Yes	
Transfer syntax support	Yes	ILE, ELE, EBE
RIS - Worklist Management (WLM) Parameters		
WLM network node name	Yes	
General WLM Settings - Background broad query time interval	Yes	0 [min] (no background query)
DICOM WLM Settings - RIS query time-out	Yes	240 [min]
DICOM WLM Settings - WLM query requests attribute 'specific character set (0008,0005)	Yes	No
DICOM WLM Settings - Scheduled Procedure Step ID (0040,0009) is mandatory	Yes	No
DICOM Query Attributes - Broad query SPS start date	Yes	today
DICOM Query Attributes - Broad query modality	Yes	all
DICOM Query Attributes - Broad query AE title	Yes	ALL
RIS - Emergency Patient Parameters		
Emergency patient sex	Yes	female
Emergency patient name male	Yes	Doe^John
Emergency patient name female	Yes	Doe^Jane
Emergency patient name other	Yes	Doe^J
RIS - MPPS Parameters		
MPPS network node name	Yes	

5. MEDIA INTERCHANGE

5.1. Implementation model

The implementation model identifies the DICOM Application Entities for Media in specific implementation and relate the Application Entities to Real-World Activities.

5.1.1. Application Data Flow Diagram

The Eleva media interchange is implemented in one single application entity only: the ACP AE.

Figure 13 shows the media interchange application data flow as a functional overview of the ACP AE for DICOM CD and DVD media.

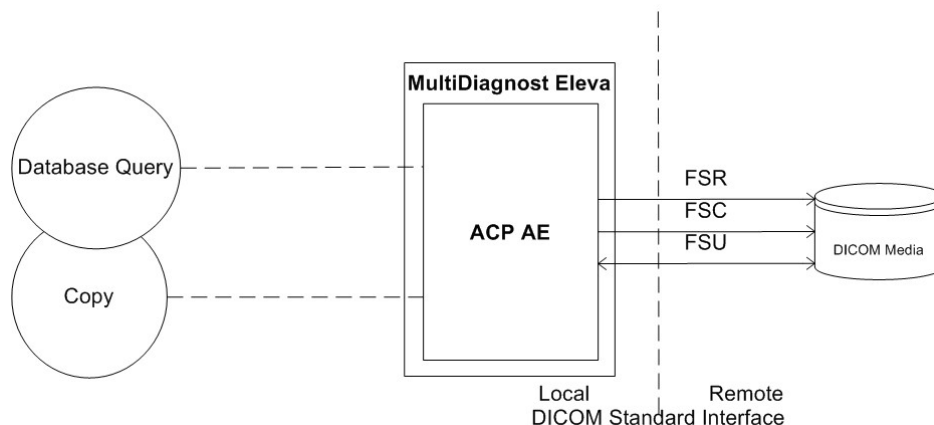

Figure 13: Application Data Flow Diagram

5.1.2. Functional Definitions of AE's

The ACP AE is the one and only application entity within the Eleva. It includes the following service class.

Media Storage Service Class for CD and DVD

For CD media the ACP AE can perform the Media Storage service as SCU with capabilities for:

- RWA Database Query (as FSR);
- RWA Copy (as FSR, FSC, FSU).

For DVD media the ACP AE can perform the Media Storage service as SCU with capabilities for:

- RWA Database Query (as FSR);
- RWA Copy (as FSR, FSC).

The ACP AE implementation to read and write media is the same as the Networking implementation of Data Handling to open database/disk (RWA Database Query) and copy data (RWA Copy). After Database Query the contents of the media is displayed

in the Data management screen. Using Copy the selected content can be copied from media to another database. Copy can also be used to copy selected content from the actual database in the Data management screen to media.

5.1.3. Sequencing of Real World Activities

Whenever a CD or DVD has to be written the ACP AE first tries to read the DICOMDIR. The ACP AE will compile the updated DICOMDIR and any required DICOM images into a CD or DVD session image; this CD or DVD session image will be written to CD or DVD disk.

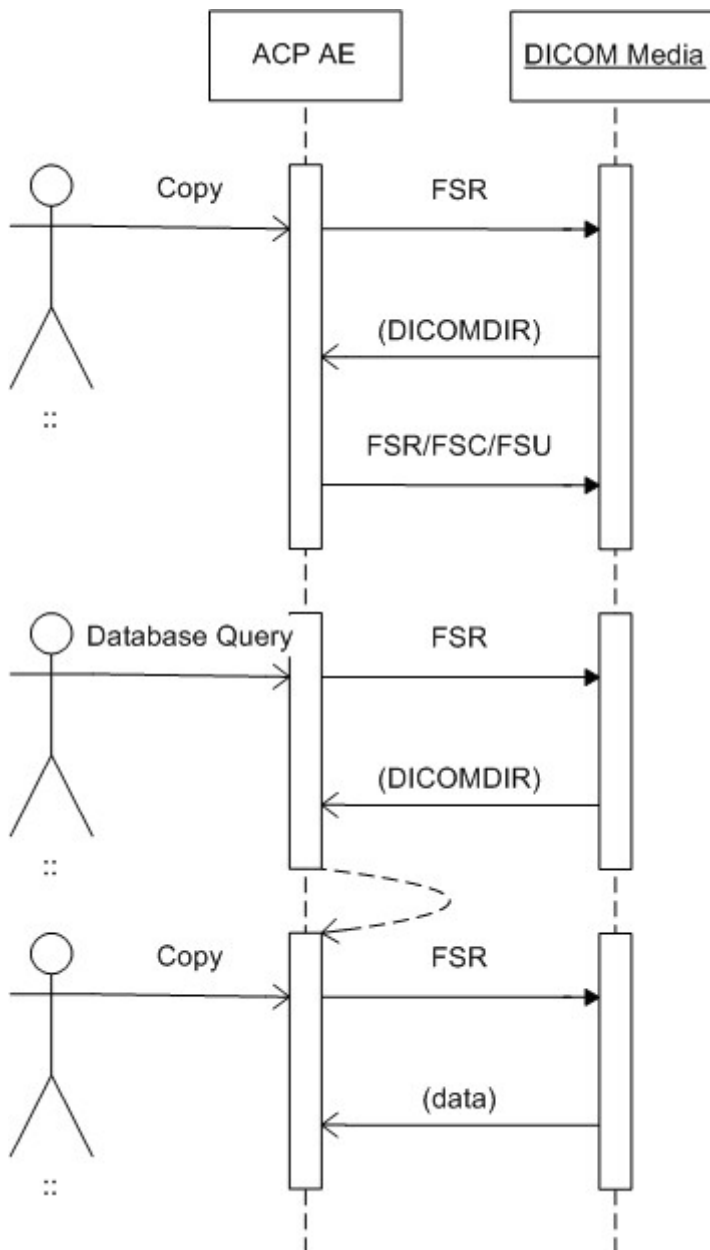

Figure 14: Sequencing of ACP AE Media Interchange

5.2. AE Specifications

This section in the DICOM Conformance Statement specifies a set of Media Application Entities.

5.2.1. ACP AE Media - Specification

For reading and writing the ACP AE provides standard conformance to:

- the DICOM media Storage Service and File Format ([DICOM] PS 3.10);
- the Media Storage Application Profiles ([DICOM] PS 3.11); and
- the Media Formats and Physical Media for Media Interchange ([DICOM] PS 3.12).

The ACP AE supports multi-patient and multi-session CD/DVD disks, both for reading and writing.

Supported media by the ACP AE are:

- CD: CD-R/CD-RW with the profile STD-GEN-CD and
- DVD: DVD+R and DVD+RW with the profile STD-GEN-DVD-JPEG and the transfer syntax ELE (uncompressed).

The DVD-R and DVD-RW media can be read but are NOT supported for writing.

The supported application profiles, their roles and the Service Class (SC) options, all defined in DICOM terminology, are listed in Table 75.

Only adding on instances is supported for the FSU, deleting is not supported. JPEG compression is not supported, only ELE support is implemented.

The Application Profiles and roles are listed below:

Table 96: AE ACP AE related Application Profiles, RWA activities and roles

Supported Application Profile	Identifier	Real-World Activities	Roles
General Purpose CD-R Interchange	STD-GEN-CD	Update File-set	FSU
		Create File-set	FSC
		Read File-set	FSR
General Purpose DVD Interchange with JPEG	STD-GEN-DVD-JPEG	Create File-set	FSC
		Read File-set	FSR

5.2.1.1. File Meta Information for the ACP AE

The Implementation Class UID and the Implementation Version Name in the File Meta Header are as specified for Networking (ref. Table 30 in section 4.2.2.2.4).

Table 97: File Meta Information Version

Description	Value
File Meta Information Version	00, 01

Table 98: File Meta Information for the ACP AE

Implementation Class UID	1.3.46.670589.5.2.23
Implementation Version Name	ViewForum R6.3

5.2.1.2. Real-World Activities

The AE specification contains a description of the Real-World Activities, which invoke the particular AE.

5.2.1.2.1. RWA - Read File-set

This Media Application Entity has a File-set Reader functionality which is describe here.

Database Query

When a database/disk open action is initiated on the CD-R or DVD then the ACP AE acts as an FSR using the interchange option to read the DICOMDIR of the CD or DVD medium.

This will result in an overview of the patients, studies, series and images on the ACP AE screen.

Copy

When an image transfer from CD-R or DVD is initiated then the ACP AE acts as an FSR using the interchange option to import SOP instances from the CD-R/DVD medium.

5.2.1.2.1.1. Media Storage Application Profile

The application Profile that is used by this Media Application Entity is specified in this section.

Database Query

As depicted in Table 75, the ACP AE supports the RWA Database Query for the STD-GEN-CD and the STD-GEN-DVD-JPEG application profile.

Copy

As depicted in Table 75, the ACP AE supports the RWA Copy for the STD-GEN-CD and the STD-GEN-DVD-JPEG application profile.

5.2.1.2.1.1.1. Options**Database Query**

The mandatory DICOMDIR keys are required for the correct displaying of directory information. The displaying is structured according the DICOM Composite Information Model: Patient, Study, Series and Image.

Copy

For ACP AE as FSR the mandatory attributes of the DICOM images are required for the correct storage of the images in the ACP AE internal image database.

Optional attributes and Retired/Private attributes are stored too - if present; this is equivalent with the level 2 (Full) conformance for the Storage service class for Networking; ref. section 4.2.2.4.3.

The same remarks as in section 4.2.2.4.3.3 about the storage of images and about requirements to process read images via the dedicated ACP AE application functions are applicable.

Implementation remarks and restrictions

For STD-GEN-DVD-JPEG profile only DVD+R and DVD+RW with transfer syntax ELE (uncompressed) is supported; JPEG compression is not supported.

The DVD-R and DVD-RW media can be read but are NOT supported for writing.

5.2.1.2.2. RWA - Create File-set

This Media Application Entity has a File-set Creator functionality which is describe here.

Copy

When an image transfer to CD-R or DVD is initiated then the ACP AE acts as an FSC or FSU (CD-R only) using the interchange option to export SOP instances from the local database to a CD-R or DVD medium.

5.2.1.2.2.1. Media Storage Application Profile

The application Profile that is used by this Media Application Entity is specified in this section.

Copy

As depicted in Table 75, the ACP AE supports the RWA Copy for the STD-GEN-CD and the STD-GEN-DVD-JPEG application profile.

5.2.1.2.2.1.1. Options

Copy

For ACP AE as FSC/FSU the same remarks as in section 4.2.2.3.1.3.3 about the existence of optional, retired, and private attributes are applicable. The DICOMDIR file will be extended when new images are written. In case some attributes are not present in an image but are specified as mandatory in the DICOMDIR definition in DICOM media, a generated value will be filled in.

Implementation remarks and restrictions

For STD-GEN-DVD-JPEG profile only DVD+R and DVD+RW with transfer syntax ELE (uncompressed) is supported; JPEG compression is not supported.

The DVD-R and DVD-RW media can be read but are NOT supported for writing.

When writing the DICOMDIR records, key values are generated when no value of the corresponding attribute is supplied, according to the following table.

Table 99: Generated Keys

Key	Tag	Generated Value
PATIENT KEYS		
Patient ID	0010,0020	At import MULTIDIAGNOST ELEVA with FLAT DETECTOR ACP each time creates a new value based on the Study Instance UID for each new study written to the CD-R / DVD (even if this study belongs to a patient recorded earlier). Otherwise the default-generated value will be a succession of "UNKNOWN", the Patient's Name, the Patient's Birth Date, and the Patient's Sex, concatenated by using underscore characters.
STUDY KEYS		
Study Date	0008,0020	Date on which this Study was created.
Study Time	0008,0030	Time on which this Study was created.
Study ID	0020,0010	"UNKNOWN"
SERIES KEYS		
Series Number	0020,0011	1
IMAGE KEYS		
Instance Number	0020,0013	1

The default value for the Pixel Intensity Relationship (0028,1040) is set to DISP.
 The ACP AE can write volumes of the media to that media.
 The ACP AE asks for a new media if media is spanning over more disks.

5.2.1.2.3. RWA - Update File-set

This Media Application Entity has a File-set Updater functionality which is describe here.

Copy

When an image transfer to CD-R or DVD is initiated then the ACP AE acts as an FSC or FSU (CD-R only) using the interchange option to export SOP instances from the local database to a CD-R or DVD medium.

5.2.1.2.3.1. Media Storage Application Profile

The application Profile that is used by this Media Application Entity is specified in this section.

Copy

As depicted in Table 75, the ACP AE supports the RWA Copy for the STD-GEN-CD and the STD-GEN-DVD-JPEG application profile.

5.2.1.2.3.1.1. Options

Copy

For ACP AE as FSC/FSU the same remarks as in section 4.2.2.3.1.3.3 about the existence of optional, retired, and private attributes are applicable. The DICOMDIR file will be extended when new images are written. In case some attributes are not present in an image but are specified as mandatory in the DICOMDIR definition in DICOM media, a generated value will be filled in.

Implementation remarks and restrictions

Only adding on instances is supported for the FSU, deleting is not supported.

5.3. Augmented and Private Application Profiles

Not applicable

5.4. Media Configuration

Any configuration issues may be found in the Networking section 4.4 Configuration.

6. SUPPORT OF CHARACTER SETS

Any support for character sets beyond the default character repertoire in Network and Media services is described here.

Table 100: Supported DICOM Character Sets of MultiDiagnost Eleva with Flat Detector

Character Set Description	Defined Term	ESC Sequence	ISO Registration Number	Code Element	Character Set
Latin alphabet No. 1	ISO_IR 100	-	ISO-IR 6	G0	ISO 646
		-	ISO-IR 100	G1	Supplementary set of ISO 8859
Default repertoire	-	-	ISO-IR 6	G0	ISO 646
		-	-	-	-

When the Eleva receives images with undefined character set then the import will be terminated with error status code.

The default factory settings for the WLM query request attribute "Specific Character Set" (0008,0005) is "NO" and should be configured to "YES" for support of the " ' " (27H) character.

7. SECURITY

7.1. Security Profiles

The Interventional Workstation allows the use of either a conventional (non-secure) DICOM communication or a secure DICOM communication based on the Transport Layer Security (TLS) protocol. If configured, the Interventional Workstation supports security measures for:

- secure authentication of a node
- integrity and confidentiality of transmitted data
- replay protection
- generation of audit trail records
- access control and user authentication

7.1.1. Security use Profiles

Not applicable

7.1.2. Security Transport Connection Profiles

Secure communication is a "mode of operation" supported by the implementation of the DICOM Basic TLS Secure Transport Connection Profile [DICOM]. This functionality will be used by the nodes, which can authenticate each other before they exchange DICOM information. For secure communication the TLS protocol v1.0 is used which provides message authentication, integrity, confidentiality, and replay protection. Confidentiality is optional and can be controlled by the encryption settings. The Interventional Workstation may communicate using the following Cipher Suites:

- TLS_RSA_WITH_NULL_SHA (Node authentication without encryption)
- TLS_RSA_WITH_3DES_SHA (Node authentication with encryption)

The Interventional Workstation supports X.509 certificates. The following TLS Certification checks will be done (TLS Handshake). The machine (either server or client) that will send its certificate will:

- Choose the certificate according to Common Name (CN) value in the Subject-field.
- This name is case-sensitive. All present certificates should have unique CN names.

The server verifies:

- That the client certificate is a X.509 certificate which is not tampered with
- That the client certificate is in the list of trusted certificates
- That the client certificate is not expired (present time is between "Valid From" and "Valid To" fields of the X.509 certificate)
- That the client certificate has the correct purpose (at least the Client Authentication purpose)

The client verifies:

- That the server certificate is a X.509 certificate which is not tampered with
- That the server certificate is in the list of trusted certificates
- That the server certificate is not expired (present time is between "Valid From" and "Valid To" fields of the X.509 certificate)
- That the server certificate has the correct purpose (at least Server Authentication purpose)

No verification is done on:

- Revocation of certificates
- Limiting the connection to a limited set of IP-addresses

Node authentication with or without encryption is only possible when both nodes have:

- An access to their own private keys
- An access to a copy of the certificate of the other node containing its public key

The Interventional Workstation can only read certificates from the certificate stores of the HKEY_LOCAL_MACHINE registry key. It is the responsibility of the Hospital to setup and maintain the certificate stores. This includes the removal of revoked certificates and certificate updates prior to their expiration. Since neither X.500 directories, Lightweight Directory Access Protocol (LDAP) nor Certificate Revocation Lists (CRLs) are supported, the whole certificate chain needs to be replaced after a security breach.

The following figure presents the message flow of TLS handshake supported.

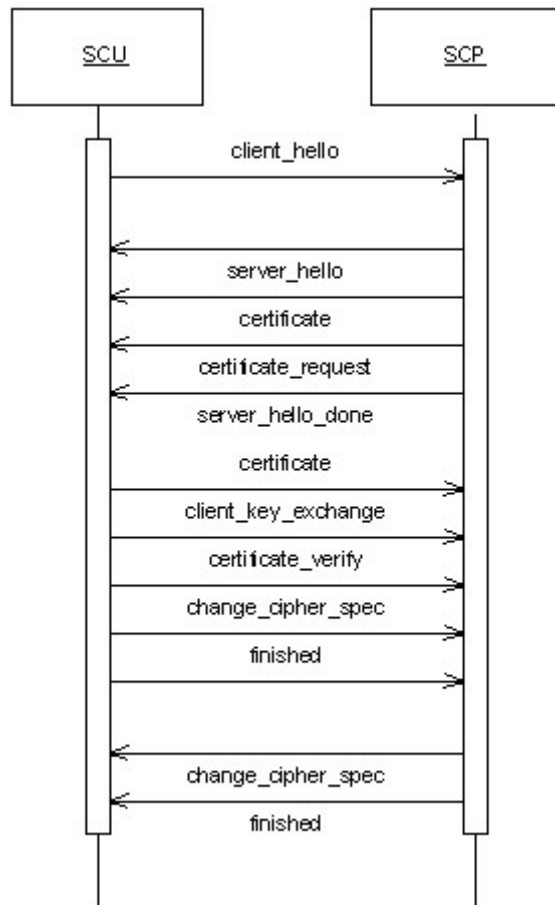

Figure 15: Message flow of TLS handshake

7.1.3. Digital Signature Profiles

Not applicable

7.1.4. Media Storage Security Profiles

Not applicable

7.1.5. Attribute Confidentiality Profiles

No instances of the Encrypted Attributes Data Set are created. No Transfer Syntaxes are supported for encoding/decoding of Encrypted Attributes Data Sets.

The table below lists the protected attributes. The terms used to describe the replacement value can be read as below:

Empty - The attribute will have a value of zero length.

Table 101: Basic Application Level Confidentiality Profile Attributes

Attribute Name	Tag	VR	Replacement Value
Patient's Name	0010,0010	PN	Empty

Attribute Name	Tag	VR	Replacement Value
Patient's Birth Date	0010,0030	DA	Empty
Patient's Sex	0010,0040	CS	Empty
Patient's Age	0010,1010	AS	Empty
Patient ID	0010,0020	LO	After anonymizing, when an image is written into a CD/DVD, the Patient ID in the DIRECTORY RECORD: 0 (PATIENT) will have a unique ID and in the image, the Patient Module will have Empty value for the Patient ID.
Referring Physician's Name	0008,0090	PN	Empty
Performing Physician's Name	0008,1050	PN	Empty
Institution Name	0008,0080	LO	Empty
Study ID	0020, 0010	SH	"UNKNOWN"
Accession Number	0008,0050	SH	Empty

7.1.6. Network Address Management Profiles

Not applicable

7.1.7. Time Synchronization Profiles

Not applicable

7.1.8. Application Configuration Management Profiles

Not applicable

7.1.9. Audit Trail Profiles

The Interventional Workstation can create audit messages according to the IHE Basic Security Integration Profile [IHE] to audit activities, to detect non-compliant behavior in the enterprise, and to facilitate detection of improper creation, access, modification and deletion of Protected Health Information (PHI). These messages may contain information that identifies the patient. The following messages will be created and sent to a central Audit Record Repository according to the Syslog protocol[SYSLOG]:

- ActorConfig (when security or networking configuration of the Interventional Workstation is modified using the service screen)
- ActorStartStop (when the Interventional Workstation starts or shuts down)
- BeginStoringInstances (when an exportable item is transferred from the Interventional Workstation to a remote network node)
- DICOMInstancesDeleted (when a patient or an exportable item is deleted)
- DICOMInstancesUsed (when patient details are viewed in the Interventional Workstation)
- Export (when a secondary capture is printed on a film/paper, and when a patient has been stored on CD/DVD)
- Import (when patient data is read from CD/DVD)
- SecurityAlert (when an authentication of a secure node during TLS negotiation [TLS] fails, e.g. Due to an invalid certificate)

- **UserAuthenticated:** This is logged only when the user logs in. No message is logged upon user logout, since it is not possible to determine the time of logout in every case.

If the central Audit Record Repository is not available, the audit trail record will be stored in a local buffer. Once the central Audit Record Repository is available again, the content of that buffer will be transferred to the central Audit Record Repository. The time that is part of the audit message will be the local system time. This time will be synchronized with a Time Server. The Time Server and central Audit Record Repository are elements of the Hospital infrastructure.

7.2. Association Level Security

Not applicable

7.3. Application Level Security

Not applicable

8. ANNEXES OF APPLICATION "ELEVA EDI"

8.1. IOD Contents

8.1.1. Created SOP Instance

This section specifies each created IOD by this application.

This section specifies each IOD created (including private IOD's). It should specify the attribute name, tag, VR, and value. The value should specify the range and source (e.g. user input, Modality Worklist, automatically generated, etc.). For content items in templates, the range and source of the concept name and concept values should be specified. Whether the value is always present or not shall be specified.

Abbreviations used in the IOD tables for the column "Presence of Module" are:

ALWAYS The module is always present
 CONDITIONAL The module is used under specified condition

Abbreviations used in the Module table for the column "Presence of Value" are:

ALWAYS The attribute is always present with a value
 EMPTY The attribute is always present without any value (attribute sent zero length)
 VNAP The attribute is always present and its Value is Not Always Present (attribute sent zero length if no value is present)
 ANAP The attribute is present under specified condition – if present then it will always have a value
 ANAPCV The attribute is present under specified condition – if present then its Value is Not Always Present (attribute sent zero length if condition applies and no value is present)
 ANAPEV The attribute is present under specified condition – if present then it will not have any value

The abbreviations used in the Module table for the column "Source" are:

AUTO The attribute value is generated automatically
 CONFIG The attribute value source is a configurable parameter
 COPY The attribute value source is another SOP instance
 FIXED The attribute value is hard-coded in the application
 IMPLICIT The attribute value source is a user-implicit setting
 MPPS The attribute value is the same as that use for Modality Performed Procedure Step
 MWL The attribute value source is a Modality Worklist
 USER The attribute value source is explicit user input

8.1.1.1. List of created SOP Classes

Table 102: List of created SOP Classes

SOP Class Name	SOP Class UID
Secondary Capture Image Storage SOP Class	1.2.840.10008.5.1.4.1.1.7
Softcopy Presentation State Storage SOP Class	1.2.840.10008.5.1.4.1.1.11.1
Specialized PMS X-Ray Image Store	1.3.46.670589.2.3.1.1
X-Ray Radiofluoroscopic Image Storage SOP Class	1.2.840.10008.5.1.4.1.1.12.2

8.1.1.2. Secondary Capture Image Storage SOP Class

Table 103: IOD of Created Secondary Capture Image Storage SOP Class Instances

Information Entity	Module	Presence Of Module
Patient	Patient Module	ALWAYS
Study	General Study Module	ALWAYS
Series	General Series Module	ALWAYS
Equipment	General Equipment Module	ALWAYS
Equipment	SC Equipment Module	ALWAYS
Image	General Image Module	ALWAYS
Image	Image Pixel Module	ALWAYS
Image	SC Image Module	ALWAYS
Image	SOP Common Module	ALWAYS
Image	VOI LUT Module	CONDITIONAL

Table 104: Patient Module

Attribute Name	Tag	VR	Value	Presence of Value	Source	Comment
Patient ID	0010,0020	LO		VNAP	COPY	
Patient's Birth Date	0010,0030	DA		VNAP	COPY	
Patient's Name	0010,0010	PN		ALWAYS	COPY	
Patient's Sex	0010,0040	CS		VNAP	COPY	

Table 105: General Study Module

Attribute Name	Tag	VR	Value	Presence of Value	Source	Comment
Accession Number	0008,0050	SH		VNAP	COPY	
Referring Physician's Name	0008,0090	PN		VNAP	COPY	
Study Date	0008,0020	DA		ALWAYS	AUTO	
Study Description	0008,1030	LO		ANAPCV	AUTO, USER	
Study ID	0020,0010	SH		VNAP	COPY	
Study Instance UID	0020,000D	UI		ALWAYS	COPY	
Study Time	0008,0030	TM		ALWAYS	AUTO	
Referenced Study Sequence	0008,1110	SQ		ANAP	COPY	
>Referenced SOP Class UID	0008,1150	UI		ALWAYS	COPY	
>Referenced SOP Instance UID	0008,1155	UI		ALWAYS	COPY	

Table 106: General Series Module

Attribute Name	Tag	VR	Value	Presence of Value	Source	Comment
Body Part Examined	0018,0015	CS		VNAP		New for R5.2
Laterality	0020,0060	CS		ANAPEV	AUTO	Presence defined per EPX. See Note.
Performed Procedure Step Description	0040,0254	LO		VNAP	COPY	
Performed Procedure Step ID	0040,0253	SH		ALWAYS	COPY	
Performed Procedure Step Start Date	0040,0244	DA		ALWAYS	COPY	
Performed Procedure Step Start Time	0040,0245	TM		ALWAYS	COPY	
Performing Physician's Name	0008,1050	PN		VNAP	COPY	Name of the Physician(s) administrating this Series
Protocol Name	0018,1030	LO		VNAP	AUTO, USER	Equal to Series Description.
Series Date	0008,0021	DA		ALWAYS	AUTO	
Series Description	0008,103E	LO		VNAP	USER	Equal to Protocol Name

Series Instance UID	0020,000E	UI		ALWAYS	AUTO	
Series Number	0020,0011	IS		ALWAYS	COPY	
Series Time	0008,0031	TM		ALWAYS	AUTO	
Referenced Performed Procedure Step Sequence	0008,1111	SQ		ANAP	COPY	
>Referenced SOP Class UID	0008,1150	UI		ALWAYS	COPY	
>Referenced SOP Instance UID	0008,1155	UI		ALWAYS	COPY	
Request Attributes Sequence	0040,0275	SQ		ANAP	COPY	
>Scheduled Procedure Step Description	0040,0007	LO		ANAP	COPY	
>Scheduled Protocol Code Sequence	0040,0008	SQ		ANAP	COPY	
>>Code Meaning	0008,0104	LO		ALWAYS	COPY	
>>Code Value	0008,0100	SH		ALWAYS	COPY	
>>Coding Scheme Designator	0008,0102	SH		ALWAYS	COPY	

Table 107: General Equipment Module

Attribute Name	Tag	VR	Value	Presence of Value	Source	Comment
Device Serial Number	0018,1000	LO		ALWAYS	FIXED	
Institution Name	0008,0080	LO		ALWAYS	CONFIG	Hospital
Manufacturer	0008,0070	LO	Philips Medical Systems	ALWAYS	FIXED	
Manufacturer's Model Name	0008,1090	LO	ViewForum	ALWAYS	FIXED	
Software Version(s)	0018,1020	LO	ViewForum 6.3	ALWAYS	AUTO	
Station Name	0008,1010	SH		ANAP	CONFIG	

Table 108: SC Equipment Module

Attribute Name	Tag	VR	Value	Presence of Value	Source	Comment
Conversion Type	0008,0064	CS	DV, WSD	ALWAYS	AUTO	
Modality	0008,0060	CS	RF	ALWAYS	COPY	

Table 109: General Image Module

Attribute Name	Tag	VR	Value	Presence of Value	Source	Comment
Acquisition Date	0008,0022	DA		ALWAYS	COPY	
Acquisition Number	0020,0012	IS		ANAP	AUTO	
Acquisition Time	0008,0032	TM		ALWAYS	COPY	
Content Date	0008,0023	DA		ALWAYS	COPY	
Content Time	0008,0033	TM		ALWAYS	COPY	
Image Comments	0020,4000	LT		ANAP	USER	If entered by user and if annotations are present. Contains the image annotations on normal (non-zoomed) images. Format: (<x>,<y>) <text>
Image Type	0008,0008	CS	DERIVED, SECONDARY	ALWAYS	AUTO	
Instance Number	0020,0013	IS		ALWAYS	AUTO	
Patient Orientation	0020,0020	CS		ANAPEV	AUTO	

Table 110: Image Pixel Module

Attribute Name	Tag	VR	Value	Presence of Value	Source	Comment
Bits Allocated	0028,0100	US	8	ALWAYS	AUTO	
Bits Stored	0028,0101	US	8	ALWAYS	AUTO	
Columns	0028,0011	US	512	ALWAYS	AUTO	Size of snapshot
High Bit	0028,0102	US	7	ALWAYS	AUTO	
Photometric Interpretation	0028,0004	CS	MONOCHROME2, RGB	ALWAYS	AUTO	RGB from ViewForum
Pixel Aspect Ratio	0028,0034	IS	1/1	ANAP	AUTO	

Pixel Data	7FE0,0010	O W/ OB		ALWAYS	IMPLICIT	
Pixel Representation	0028,0103	US	0	ALWAYS	AUTO	
Planar Configuration	0028,0006	US	0	ANAP	AUTO	
Rows	0028,0010	US	512	ALWAYS	AUTO	Size of snapshot
Samples per Pixel	0028,0002	US	1, 3	ALWAYS	AUTO	3 from ViewForum

Table 111: SC Image Module

Attribute Name	Tag	VR	Value	Presence of Value	Source	Comment
Date of Secondary Capture	0018,1012	DA		ANAP	AUTO	
Time of Secondary Capture	0018,1014	TM		ANAP	AUTO	

Table 112: SOP Common Module

Attribute Name	Tag	VR	Value	Presence of Value	Source	Comment
SOP Class UID	0008,0016	UI	1.2.840.10008.5.1.4.1.1.7	ALWAYS	FIXED	
SOP Instance UID	0008,0018	UI		ALWAYS	AUTO	
Specific Character Set	0008,0005	CS	ISO_IR 100	ANAP	COPY	

Table 113: VOI LUT Module

Attribute Name	Tag	VR	Value	Presence of Value	Source	Comment
Window Center	0028,1050	DS		ALWAYS	AUTO	
Window Width	0028,1051	DS		ALWAYS	AUTO	

8.1.1.3. Softcopy Presentation State Storage SOP Class

Table 114: IOD of Created Softcopy Presentation State Storage SOP Class Instances

Information Entity	Module	Presence Of Module
Curve	Displayed Area Module	ALWAYS
Curve	Presentation Series Module	ALWAYS
Presentation State	Presentation State Identification Module	ALWAYS
Presentation State	Presentation State Shutter Module	ALWAYS
Presentation State	Softcopy Presentation LUT Module	ALWAYS
Presentation State	Softcopy VOI LUT Module	CONDITIONAL
Curve	Graphic Annotation Module	CONDITIONAL
Curve	Graphic Layer Module	CONDITIONAL
Presentation State	Presentation State Relationship Module	ALWAYS
Patient	Patient Module	ALWAYS
Study	General Study Module	ALWAYS
Series	General Series Module	ALWAYS
Equipment	General Equipment Module	ALWAYS
Image	Display Shutter Module	ALWAYS
Image	SOP Common Module	ALWAYS
	Additional Module	CONDITIONAL

Table 115: Displayed Area Module

Attribute Name	Tag	VR	Value	Presence of Value	Source	Comment
Displayed Area Selection Sequence	0070,005A	SQ		ALWAYS	IMPLICIT	
>Displayed Area Bottom Right Hand Corner	0070,0053	SL	512, 512, 1024, 2048, 1024, 512, 2048	ALWAYS	IMPLICIT	

>Displayed Area Top Left Hand Corner	0070,0052	SL	1, 1	ALWAYS	IMPLICIT	
>Presentation Pixel Aspect Ratio	0070,0102	IS		ANAP	IMPLICIT	
>Presentation Pixel Spacing	0070,0101	DS		ANAP	IMPLICIT	
>Presentation Size Mode	0070,0100	CS	SCALE TO FIT	ALWAYS	IMPLICIT	

Table 116: Presentation Series Module

Attribute Name	Tag	VR	Value	Presence of Value	Source	Comment
Modality	0008,0060	CS	PR	ALWAYS	FIXED	

Table 117: Presentation State Identification Module

Attribute Name	Tag	VR	Value	Presence of Value	Source	Comment
Content Creator's Name	0070,0084	PN		VNAP	USER	
Content Description	0070,0081	LO		VNAP	USER	
Content Label	0070,0080	CS	AS ACQUIRED, AS LAST SEEN, NEW AT IMPORT	ALWAYS	AUTO	AS ACQUIRED from Eleva, AS LAST SEEN/NEW AT IMPORT from ViewForum.
Instance Number	0020,0013	IS		ALWAYS	AUTO	
Presentation Creation Date	0070,0082	DA		ALWAYS	AUTO	
Presentation Creation Time	0070,0083	TM		ALWAYS	AUTO	

Table 118: Presentation State Shutter Module

Attribute Name	Tag	VR	Value	Presence of Value	Source	Comment
Shutter Presentation Value	0018,1622	US	0	ANAP	AUTO	

Table 119: Softcopy Presentation LUT Module

Attribute Name	Tag	VR	Value	Presence of Value	Source	Comment
Presentation LUT Shape	2050,0020	CS	IDENTITY	ANAP	AUTO	
Presentation LUT Sequence	2050,0010	SQ		ANAP	AUTO	
>LUT Data	0028,3006	US /SS		ALWAYS	AUTO	
>LUT Descriptor	0028,3002	US /SS		ALWAYS	AUTO	

Table 120: Softcopy VOI LUT Module

Attribute Name	Tag	VR	Value	Presence of Value	Source	Comment
Softcopy VOI LUT Sequence	0028,3110	SQ		ALWAYS	AUTO	
>Referenced Image Sequence	0008,1140	SQ		ANAP	AUTO	
>Window Center	0028,1050	DS		ALWAYS	AUTO	
>Window Width	0028,1051	DS		ALWAYS	AUTO	

Table 121: Graphic Annotation Module

Attribute Name	Tag	VR	Value	Presence of Value	Source	Comment
Graphic Annotation Sequence	0070,0001	SQ		ALWAYS	AUTO	
>Graphic Layer	0070,0002	CS	Layer created on import VFGFX	ALWAYS	AUTO	
>Graphic Object Sequence	0070,0009	SQ		ANAP	AUTO	
>>Graphic Annotation Units	0070,0005	CS	PIXEL	ALWAYS	AUTO	
>>Graphic Data	0070,0022	FL		ALWAYS	AUTO	
>>Graphic Dimensions	0070,0020	US		ALWAYS	FIXED	

>>Graphic Filled	0070,0024	CS		ANAP	IMPLICIT	
>>Graphic Type	0070,0023	CS	POLYLINE	ALWAYS	IMPLICIT	
>>Number of Graphics Points	0070,0021	US		ALWAYS	AUTO	
>Text Object Sequence	0070,0008	SQ		ANAP	AUTO	
>>Anchor Point	0070,0014	FL		ANAP	IMPLICIT	
>>Anchor Point Annotation Units	0070,0004	CS	PIXEL	ANAP	AUTO	
>>Anchor Point Visibility	0070,0015	CS	N, Y	ANAP	IMPLICIT	
>>Bounding Box Annotation Units	0070,0003	CS	PIXEL	ANAP	AUTO	
>>Bounding Box Bottom Right Hand Corner	0070,0011	FL		ANAP	IMPLICIT	
>>Bounding Box Text Horizontal Justification	0070,0012	CS	CENTER, LEFT, RIGHT	ANAP	IMPLICIT	
>>Bounding Box Top Left Hand Corner	0070,0010	FL		ANAP	IMPLICIT	
>>Unformatted Text Value	0070,0006	ST		ALWAYS	USER	

Table 122: Graphic Layer Module

Attribute Name	Tag	VR	Value	Presence of Value	Source	Comment
Graphic Layer Sequence	0070,0060	SQ		ALWAYS	AUTO	
>Graphic Layer	0070,0002	CS	VFGFX	ALWAYS	AUTO	
>Graphic Layer Description	0070,0068	LO	ViewForum Graphics	ANAP	AUTO	
>Graphic Layer Order	0070,0062	IS		ALWAYS	AUTO	
>Graphic Layer Recommended Display RGB Value (RETIRED)	0070,0067	US	0xFFFF, 0xFFFF, 0xFFFF	ANAP	AUTO	RGB Value

Table 123: Presentation State Relationship Module

Attribute Name	Tag	VR	Value	Presence of Value	Source	Comment
Referenced Series Sequence	0008,1115	SQ		ALWAYS	AUTO	
>Series Instance UID	0020,000E	UI		ALWAYS	COPY	
>Referenced Image Sequence	0008,1140	SQ		ALWAYS	AUTO	
>>Referenced SOP Class UID	0008,1150	UI	1.2.840.10008.5.1.4.1.1.12.2, 1.3.46.670589.2.3.1.1	ALWAYS	AUTO	
>>Referenced SOP Instance UID	0008,1155	UI		ALWAYS	COPY	

Table 124: Patient Module

Attribute Name	Tag	VR	Value	Presence of Value	Source	Comment
Patient ID	0010,0020	LO		VNAP	COPY	
Patient's Birth Date	0010,0030	DA		VNAP	COPY	
Patient's Name	0010,0010	PN		ALWAYS	COPY	
Patient's Sex	0010,0040	CS		VNAP	COPY	

Table 125: General Study Module

Attribute Name	Tag	VR	Value	Presence of Value	Source	Comment
Accession Number	0008,0050	SH		VNAP	COPY	
Referring Physician's Name	0008,0090	PN		VNAP	COPY	
Study Date	0008,0020	DA		ALWAYS	COPY	
Study Description	0008,1030	LO		VNAP	COPY	
Study ID	0020,0010	SH		VNAP	COPY	
Study Instance UID	0020,000D	UI		ALWAYS	COPY	
Study Time	0008,0030	TM		ALWAYS	COPY	
Referenced Study Sequence	0008,1110	SQ		ANAP	COPY	
>Referenced SOP Class UID	0008,1150	UI		ALWAYS	COPY	

>Referenced SOP Instance UID	0008,1155	UI		ALWAYS	COPY	
------------------------------	-----------	----	--	--------	------	--

Table 126: General Series Module

Attribute Name	Tag	VR	Value	Presence of Value	Source	Comment
Body Part Examined	0018,0015	CS		VNAP		New for R5.2
Laterality	0020,0060	CS		ANAPCV	AUTO	Presence defined per EPX. See Note.
Performed Procedure Step Description	0040,0254	LO		VNAP	COPY	
Performed Procedure Step ID	0040,0253	SH		ANAP	COPY	
Performed Procedure Step Start Date	0040,0244	DA		ANAP	COPY	
Performed Procedure Step Start Time	0040,0245	TM		ANAP	COPY	
Performing Physician's Name	0008,1050	PN		VNAP	AUTO	Current physician
Protocol Name	0018,1030	LO		ANAP	COPY	
Series Date	0008,0021	DA		ALWAYS	AUTO	
Series Description	0008,103E	LO		VNAP		New for R5.2
Series Instance UID	0020,000E	UI		ALWAYS	AUTO	
Series Number	0020,0011	IS		VNAP	AUTO	
Series Time	0008,0031	TM		ALWAYS	AUTO	
Referenced Performed Procedure Step Sequence	0008,1111	SQ		ANAP	COPY	
>Referenced SOP Class UID	0008,1150	UI	1.2.840.10008.3.1.2.3.3	ALWAYS	COPY	
>Referenced SOP Instance UID	0008,1155	UI		ALWAYS	COPY	
Request Attributes Sequence	0040,0275	SQ		ANAP	COPY	
>Requested Procedure ID	0040,1001	SH		ALWAYS	COPY	
>Scheduled Procedure Step Description	0040,0007	LO		ANAP	COPY	
>Scheduled Procedure Step ID	0040,0009	SH		ALWAYS	COPY	

Table 127: General Equipment Module

Attribute Name	Tag	VR	Value	Presence of Value	Source	Comment
Device Serial Number	0018,1000	LO	DSI R6.1.1	ALWAYS	FIXED	
Institution Name	0008,0080	LO	Hospital	VNAP	CONFIG	
Manufacturer	0008,0070	LO	Philips Medical Systems	ALWAYS	FIXED	
Manufacturer's Model Name	0008,1090	LO	ViewForum, Extended Digital Imaging	ALWAYS	AUTO	Writing on CD/DVD as "ViewForum"
Software Version(s)	0018,1020	LO	ViewForum 6.3, ViewForum 3.2, PMS1.1 MIMIT PIIMDictionary, PMS1.1 MIMIT EVIIMDictionary	ALWAYS	FIXED	
Station Name	0008,1010	SH	RF_System	VNAP	CONFIG	

Table 128: Display Shutter Module

Attribute Name	Tag	VR	Value	Presence of Value	Source	Comment
Center of Circular Shutter	0018,1610	IS		ANAP	IMPLICIT	Required if Shutter Shape (0018,1600) is CIRCULAR.
Radius of Circular Shutter	0018,1612	IS		ANAP	IMPLICIT	Required if Shutter Shape (0018,1600) is CIRCULAR.
Shutter Left Vertical Edge	0018,1602	IS		ANAP	IMPLICIT	
Shutter Lower Horizontal Edge	0018,1608	IS		ANAP	IMPLICIT	
Shutter Right Vertical Edge	0018,1604	IS		ANAP	IMPLICIT	
Shutter Shape	0018,1600	CS	CIRCULAR, RECTANGULAR	ALWAYS	AUTO	
Shutter Upper Horizontal Edge	0018,1606	IS		ANAP	IMPLICIT	

Table 129: SOP Common Module

Attribute Name	Tag	VR	Value	Presence of Value	Source	Comment
SOP Class UID	0008,0016	UI	1.2.840.10008.5.1.4.1.1.11.1	ALWAYS	FIXED	
SOP Instance UID	0008,0018	UI		ALWAYS	AUTO	
Specific Character Set	0008,0005	CS	ISO_IR 100	ANAP	IMPLICIT	Configuration issue.

Table 130: Additional Module

Attribute Name	Tag	VR	Value	Presence of Value	Source	Comment
Distance Source to Detector	0018,1110	DS				

8.1.1.4. X-Ray Radiofluoroscopic Image Storage SOP Class**Table 131: IOD of Created X-Ray Radiofluoroscopic Image Storage SOP Class Instances**

Information Entity	Module	Presence Of Module
Patient	Patient Module	ALWAYS
Study	General Study Module	ALWAYS
Series	General Series Module	ALWAYS
Equipment	General Equipment Module	ALWAYS
Image	Cine Module	CONDITIONAL
Image	Multi-Frame Module	CONDITIONAL
Image	Display Shutter Module	CONDITIONAL
Image	General Image Module	ALWAYS
Image	Image Pixel Module	ALWAYS
Image	X-Ray Image Module	ALWAYS
Image	XRF Positioner Module	ALWAYS
Image	X-Ray Acquisition Module	ALWAYS
Image	SOP Common Module	ALWAYS
Image	VOI LUT Module	CONDITIONAL
	Additional Module	CONDITIONAL

Table 132: Patient Module

Attribute Name	Tag	VR	Value	Presence of Value	Source	Comment
Ethnic Group	0010,2160	SH		ANAP	USER	
Other Patient IDs	0010,1000	LO		ANAP	USER	
Other Patient Names	0010,1001	PN		ANAP	USER	
Patient Comments	0010,4000	LT		ANAP	USER	
Patient ID	0010,0020	LO		VNAP	MWL, USER	
Patient's Birth Date	0010,0030	DA		VNAP	MWL, USER	
Patient's Name	0010,0010	PN		ALWAYS	MWL, USER	
Patient's Sex	0010,0040	CS		ANAP	MWL, USER	
Referenced Patient Sequence	0008,1120	SQ		ANAP	AUTO	
>Referenced SOP Class UID	0008,1150	UI	1.2.840.10008.3.1.2.1.1	ANAP	AUTO	
>Referenced SOP Instance UID	0008,1155	UI		ANAP	AUTO	

Table 133: General Study Module

Attribute Name	Tag	VR	Value	Presence of Value	Source	Comment
Accession Number	0008,0050	SH		VNAP	MWL	

Name of Physician(s) Reading Study	0008,1060	PN		ANAP	USER	
Physician(s) of Record	0008,1048	PN		ANAP	USER	
Referring Physician's Name	0008,0090	PN		VNAP	MWL	
Study Date	0008,0020	DA		ALWAYS	AUTO	
Study Description	0008,1030	LO		VNAP	AUTO	
Study ID	0020,0010	SH		ALWAYS	AUTO	
Study Instance UID	0020,000D	UI		ALWAYS	MWL	
Study Time	0008,0030	TM		ALWAYS	AUTO	
Referenced Study Sequence	0008,1110	SQ		ANAP	MWL	
>Referenced SOP Class UID	0008,1150	UI		ALWAYS	MWL	
>Referenced SOP Instance UID	0008,1155	UI		ALWAYS	MWL	

Table 134: General Series Module

Attribute Name	Tag	VR	Value	Presence of Value	Source	Comment
Body Part Examined	0018,0015	CS		VNAP		New for R5.2
Laterality	0020,0060	CS		ANAPEV	AUTO	Presence defined per EPX.
Modality	0008,0060	CS		ALWAYS	FIXED	
Performed Procedure Step Description	0040,0254	LO		VNAP	MWL, USER	
Performed Procedure Step ID	0040,0253	SH		ANAP	AUTO	
Performed Procedure Step Start Date	0040,0244	DA		VNAP	AUTO	
Performed Procedure Step Start Time	0040,0245	TM		VNAP	AUTO	
Performing Physician's Name	0008,1050	PN		VNAP	CONFIG, MWL	Current Physician
Protocol Name	0018,1030	LO		ANAP	AUTO	
Series Date	0008,0021	DA		VNAP	AUTO	
Series Description	0008,103E	LO		VNAP		New for R5.2
Series Instance UID	0020,000E	UI		ALWAYS	AUTO	
Series Number	0020,0011	IS		VNAP	AUTO	
Series Time	0008,0031	TM		VNAP	AUTO	
Referenced Performed Procedure Step Sequence	0008,1111	SQ		ANAP	AUTO	
>Referenced SOP Class UID	0008,1150	UI	1.2.840.10008.3.1.2.3.3	ALWAYS	FIXED	
>Referenced SOP Instance UID	0008,1155	UI		ALWAYS	MPPS	
Request Attributes Sequence	0040,0275	SQ		ANAP	AUTO	
>Requested Procedure ID	0040,1001	SH		ALWAYS	MWL	
>Scheduled Procedure Step Description	0040,0007	LO		ANAP	MWL	
>Scheduled Procedure Step ID	0040,0009	SH		ALWAYS	MWL	

Table 135: General Equipment Module

Attribute Name	Tag	VR	Value	Presence of Value	Source	Comment
Device Serial Number	0018,1000	LO	DSI R6.1.1	ALWAYS	FIXED	
Institution Name	0008,0080	LO	Hospital	VNAP	CONFIG	Hospital name
Manufacturer	0008,0070	LO	Philips Medical Systems	ALWAYS	FIXED	
Manufacturer's Model Name	0008,1090	LO	Extended Digital Imaging	ALWAYS	FIXED	
Software Version(s)	0018,1020	LO	ViewForum 6.3, PMS1.1 MIMIT PIIMDictionary, CRISP R1.2.2, PMS1.1 MIMIT EVIIMDictionary	ALWAYS	FIXED	
Station Name	0008,1010	SH	Eleva	VNAP	CONFIG	Local system ID

Table 136: Cine Module

Attribute Name	Tag	VR	Value	Presence of Value	Source	Comment
Cine Rate	0018,0040	IS		ALWAYS	IMPLICIT	
Frame Time	0018,1063	DS		ALWAYS	IMPLICIT	

Table 137: Multi-Frame Module

Attribute Name	Tag	VR	Value	Presence of Value	Source	Comment
Frame Increment Pointer	0028,0009	AT	0x00181063	ALWAYS	FIXED	

Table 138: Display Shutter Module

Attribute Name	Tag	VR	Value	Presence of Value	Source	Comment
Shutter Left Vertical Edge	0018,1602	IS		ANAP	IMPLICIT	
Shutter Lower Horizontal Edge	0018,1608	IS		ANAP	IMPLICIT	
Shutter Right Vertical Edge	0018,1604	IS		ANAP	IMPLICIT	
Shutter Shape	0018,1600	CS	CIRCULAR, RECTANGULAR	ALWAYS	FIXED	
Shutter Upper Horizontal Edge	0018,1606	IS		ANAP	IMPLICIT	

Table 139: General Image Module

Attribute Name	Tag	VR	Value	Presence of Value	Source	Comment
Acquisition Date	0008,0022	DA		ALWAYS	AUTO	
Acquisition Number	0020,0012	IS		ALWAYS	AUTO	
Acquisition Time	0008,0032	TM		ALWAYS	AUTO	
Content Date	0008,0023	DA		ALWAYS	AUTO	
Content Time	0008,0033	TM		ALWAYS	AUTO	
Instance Number	0020,0013	IS		ALWAYS	AUTO	
Patient Orientation	0020,0020	CS		ANAPEV	AUTO	

Table 140: Image Pixel Module

Attribute Name	Tag	VR	Value	Presence of Value	Source	Comment
Columns	0028,0011	US	512, 1024, 2048	ALWAYS	IMPLICIT	
Pixel Data	7FE0,0010	O W/ OB		ALWAYS	IMPLICIT	
Rows	0028,0010	US	512, 1024, 2048	ALWAYS	IMPLICIT	

Table 141: X-Ray Image Module

Attribute Name	Tag	VR	Value	Presence of Value	Source	Comment
Bits Allocated	0028,0100	US	16	ALWAYS	FIXED	
Bits Stored	0028,0101	US	14	ALWAYS	FIXED	Deviation from DICOM (12 bits)
High Bit	0028,0102	US	13	ALWAYS	FIXED	
Image Type	0008,0008	CS	ORIGINAL, PRIMARY, SINGLE PLANE	ALWAYS	FIXED	
Photometric Interpretation	0028,0004	CS	MONOCHROME2	ALWAYS	FIXED	
Pixel Intensity Relationship	0028,1040	CS	DISP	ALWAYS	FIXED	
Pixel Representation	0028,0103	US	0000	ALWAYS	FIXED	
Samples per Pixel	0028,0002	US	1	ALWAYS	FIXED	

Table 142: XRF Positioner Module

Attribute Name	Tag	VR	Value	Presence of Value	Source	Comment
Distance Source to Detector	0018,1110	DS		ALWAYS	AUTO	In range 95 to 125 cm.
Estimated Radiographic Magnification Factor	0018,1114	DS		VNAP		New for R5.2

Table 143: X-Ray Acquisition Module

Attribute Name	Tag	VR	Value	Presence of Value	Source	Comment
Exposure	0018,1152	IS		ANAPCV	IMPLICIT	The exposure expressed in mAs, calculated from Exposure Time and X-Ray Tube Current.
Exposure Time	0018,1150	IS		ANAPCV	IMPLICIT	Duration of X-Ray exposure in msec.
Image and Fluoroscopy Area Dose Product	0018,115E	DS		ANAP		New for R5.2
KVP	0018,0060	DS		ALWAYS	IMPLICIT	Range 40 to 125 kV.
Radiation Setting	0018,1155	CS	GR, SC	ALWAYS	IMPLICIT	SC = low dose exposure generally corresponding to fluoroscopic settings (e.g. preparation for diagnostic quality image acquisition)
X-ray Tube Current	0018,1151	IS		ANAPCV	IMPLICIT	X-Ray Tube Current in mA.

Table 144: SOP Common Module

Attribute Name	Tag	VR	Value	Presence of Value	Source	Comment
SOP Class UID	0008,0016	UI	1.2.840.10008.5.1.4.1.1.12.2	ALWAYS	FIXED	
SOP Instance UID	0008,0018	UI		ALWAYS	AUTO	
Specific Character Set	0008,0005	CS	ISO_IR 100	ANAP	IMPLICIT	Configuration issue.

Table 145: VOI LUT Module

Attribute Name	Tag	VR	Value	Presence of Value	Source	Comment
Window Center	0028,1050	DS	8191.5	ALWAYS	AUTO	
Window Width	0028,1051	DS	16383.0	ALWAYS	AUTO	

Table 146: Additional Module

Attribute Name	Tag	VR	Value	Presence of Value	Source	Comment
Pixel Spacing	0028,0030	DS				

8.1.2. Usage of Attributes from Received IOD

The following remarks apply for RWA Storage of the ACP AE.

If the Eleva imports an image and during the association negotiation the Presentation State SOP class was not negotiated, then the Eleva creates a Presentation State SOP instance for the imported image. The following table gives an overview of the image formats that can be viewed or stored.

Table 147: Support for Photometric Interpretation

Photometric Interpretation	Storage	Viewing
MONOCHROME1	Yes	Yes
MONOCHROME2	Yes	Yes
RGB	Yes	Yes
YBR_FULL	Yes	No
YBR_FULL_422	Yes*	Yes*
YBR_PARTIAL_422	Yes	No
PALETTE COLOR	Yes	No
other	Yes	No

* Compressed YBR_FULL_422 images received per JPEG baseline transfer are stored (and consequently viewed) as RGB images.

If the Eleva receives improper DICOM, the Eleva tries as much as possible to make it proper DICOM (if configured to do so).

The Eleva also tries to remain as transparent as possible on images; on export the images must be changed only to such extent as really necessary. Therefore it is not guaranteed that all DICOM violations of incoming images are repaired (e.g. enumerated values are not changed).

Thus improper DICOM import may result in improper DICOM export from the Eleva (no checks are available for incorrect UID's, Date/Time formats, etc.).

The Eleva stores all additional standard, private and retired attributes in received images. Retrieval of these attributes VR's is only possible (by means of a C-STORE) if the following conditions are satisfied:

- The image was encoded (when the Eleva was C-STORE SCP) using one of the explicit value representations; or
- The image was encoded (when the Eleva was C-STORE SCP) using implicit value representation and the destination (i.e. a remote C-STORE SCP) has accepted implicit value representation as the only transfer syntax applicable to the storage SOP class of the image (with the Eleva as C-STORE SCU).

Otherwise the VR will be set to Unknown (UN).

Important implementation remarks and restrictions

- See section 8.1.4 Coerced/Modified fields for details on coerced and modified attributes.
- When the location of a Graphic or Text Annotation is specified relatively with regards to the displayed area. (i.e. DICOM attribute: Bounding Box Annotation Units (0070,0003), Anchor Point Annotation Units (0070,0004) or Graphic Annotation Units (0070,0005) equals "DISPLAY"), the annotation is not displayed.
- Areas occluded by shutter are always black in the Eleva, whereas it is possible to want it to be white in DICOM.
- On the export of imported images the Eleva adds private attributes to the image.
- The Eleva does NOT support IVUS (IntraVascular UltraSound) Ultrasound images.

- If during the image transfer the Presentation State instances are transferred before the images, the Eleva changes the content of the images.

Support for additional standard, private and retired attributes

The Eleva stores all additional standard, private, and retired attributes in received images. Retrieval of these attributes is only possible (by means of a C-MOVE request) if the following conditions are satisfied:

- The image was encoded (when the Eleva was C-STORE SCP) using one of the explicit value representations; or
- The image was encoded (when the Eleva was C-STORE SCP) using implicit value representation and the move destination (i.e. a C-STORE SCP) has accepted implicit value representation as the only transfer syntax applicable to the storage SOP class of the image (then the Eleva is C-STORE SCU).

8.1.3. Attribute Mapping

The following table shows the relation between BWLM and MPPS and image storage attributes.

Table 148: Attribute mapping during Modality Workflow

Name	BWLM tag	MPPS Create tag	MPPS Set tag	Image IODtag
Specific Character Set	0008,0005	-	-	0008,0005
Accession Number	0008,0050	0008,0050	-	0008,0050
Modality	0008,0060	0008,0060	-	0008,0060
Referring Physician's Name	0008,0090	-	-	0008,0090
Referenced Study Sequence	0008,1110	0008,1110	-	0008,1110
> Referenced SOP Class UID	-	0008,1150	-	-
> Referenced SOP Instance UID	-	0008,1155	-	-
Referenced Image Sequence	-	-	0008,1140	-
Referenced Non-Image Composite SOP Instance Sequence	-	-	0040,0220	-
> Referenced SOP Class UID	-	-	0008,1150	-
SOP Class UID	-	-	-	0008,0016
> Referenced SOP Instance UID	-	-	0008,1155	-
SOP Instance UID	-	-	-	0008,0018
Patient's Name	0010,0010	0010,0010	-	0010,0010
Patient ID	0010,0020	0010,0020	-	0010,0020
Issuer of Patient ID	0010,0021	0010,0021	-	-
Patient's Birth Date	0010,0030	0010,0030	-	0010,0030
Patient's Sex	0010,0040	0010,0040	-	0010,0040
KVP	-	-	0018,0060	0018,0060
Protocol Name	-	-	0018,1030	0018,1030
Study Instance UID	0020,000D	0020,000D	-	0020,000D
Series Instance UID	-	-	0020,000E	0020,000E
Study ID	0020,0010	0020,0010	-	0020,0010
Requested Procedure Description	0032,1060	0032,1060	-	-
Requested Procedure Code Sequence	0032,1064	-	-	-
Procedure Code Sequence	-	0008,1032	0008,1032	-
Scheduled Performing Physician's Name	0040,0006	-	-	-
Performing Physician's Name	-	-	0008,1050	0008,1050
Scheduled Procedure Step Description	0040,0007	0040,0007	-	0040,0007
Performed Procedure Step Description	-	0040,0254	0040,0254	0040,0254

Name	BWLM tag	MPPS Create tag	MPPS Set tag	Image IODtag
Scheduled Protocol Code Sequence	0040,0008	0040,0008	-	-
Performed Protocol Code Sequence	-	-	0040,0260	-
Scheduled Procedure Step ID	0040,0009	0040,0009	-	0040,0009
Performed Procedure Step Start Date	-	0040,0244	-	0040,0244
Performed Procedure Step Start Time	-	0040,0245	-	0040,0245
Performed Procedure Step ID	-	0040,0253	-	0040,0253
Requested Procedure ID	0040,1001	0040,1001	-	0040,1001

8.1.4. Coerced/Modified fields

In general the Eleva will try and optimize the imported image data. This may involve the removal of redundant data, either or not due to the creation of a Grayscale Softcopy Presentation State object for the image data. This may also involve the creation of extra attributes.

If not available at import then the Eleva will create the additional attributes as listed in the table below.

Table 149: Additional Attributes for Storage

Name	Tag	VR	Generated Value
Performed Procedure Step Start Date	0040,0244	DA	Copied from (0008,0020) Study Date.
Performed Procedure Step Start Time	0040,0245	TM	Copied from (0008,0030) Study Time.
Performed Procedure Step ID	0040,0253	SH	Copied from (0020,0010) Study ID.
Performed Procedure Step Description	0040,0254	LO	Copied from (0008,1030) Study Description.

If the SCU does not propose a Presentation Context for the Grayscale Softcopy Presentation State storage SOP class, then the Eleva will derive Grayscale Softcopy Presentation State data from the imported image data and store this data in a new series within the examination of the imported image.

However, if during import the image is accompanied by Grayscale Softcopy Presentation State data, the Eleva database will avoid data overlap by only storing the relevant data from the first object received; either the first image or its Presentation State!

Thus it will omit data received by succeeding objects concerning the optional attributes (VT=3) listed in Table 148, and clear all mandatory attributes (VT=2) listed in Table 149.

Table 150: Omitted Attributes for Storage

Name	Tag	VR	Comment
PATIENT MODULE			
Referenced Patient Sequence	0008,1120	SQ	
Patient's Birth Time	0010,0032	TM	
Other Patient's ID's	0010,1000	LO	
Other Patient's Names	0010,1001	PN	
Ethnic Group	0010,2160	SH	
Patient Comments	0010,4000	LT	
GENERAL STUDY MODULE			
Referring Physician Identification Sequence	0008,0096	SQ	
Study Description	0008,1030	LO	

Name	Tag	VR	Comment
Procedure Code Sequence	0008,1032	SQ	
Physician(s) of Record	0008,1048	PN	
Physician(s) of Record Identification Sequence	0008,1049	SQ	
Name of Physician(s) Reading Study	0008,1060	PN	
Physician(s) Reading Study IdentificationSequence	0008,1062	SQ	
Referenced Study Sequence	0008,1110	SQ	
PATIENT STUDY MODEL			
Admitting Diagnoses Description	0008,1080	LO	
Admitting Diagnoses Code Sequence	0008,1084	SQ	
Patient's Age	0010,1010	AS	
Patient's Size	0010,1020	DS	
Patient's Weight	0010,1030	DS	
Occupation	0010,2180	SH	
Additional Patient's History	0010,21B0	LT	
CLINICAL TRIAL STUDY MODULE			
Clinical Trial Time Point Description	0012,0051	ST	
GENERAL SERIES MODULE			
Series Date	0008,0021	DA	
Series Time	0008,0031	TM	
Series Description	0008,103E	LO	
Performing Physicians' Name	0008,1050	PN	
Performing Physician Identification Sequence	0008,1052	SQ	
Operators' Name	0008,1070	PN	
Operators Identification Sequence	0008,1072	SQ	
Referenced Performed Procedure Step Sequence	0008,1111	SQ	
Body Part Examined	0018,0015	CS	
Protocol Name	0018,1030	LO	
Smallest Pixel Value in Series	0028,0108	US/SS	
Largest Pixel Value in Series	0028,0109	US/SS	
Performed Procedure Step Start Date	0040,0244	DA	
Performed Procedure Step Start Time	0040,0245	TM	
Performed Procedure Step ID	0040,0253	SH	
Performed Procedure Step Description	0040,0254	LO	
Performed Protocol Code Sequence	0040,0260	SQ	
Request Attributes Sequence	0040,0275	SQ	
Comments on the Performed Procedure Step	0040,0280	ST	
GENERAL EQUIPMENT MODULE			
Institution Name	0008,0080	LO	
Institution Address	0008,0081	SH	
Station Name	0008,1010	LO	
Institutional Department Name	0008,1040	LO	
Manufacturer's Model Name	0008,1090	LO	
Device Serial Number	0018,1000	LO	
Software Version(s)	0018,1020	LO	
Spatial Resolution	0018,1050	DS	
Date of Last Calibration	0018,1200	DA	
Time of Last Calibration	0018,1201	TM	
Pixel Padding Value	0028,0120	US/SS	
DISPLAY SHUTTER MODULE			
Shutter Presentation Value	0018,1622	US	
OVERLAY PLANE MODULE			
Overlay Description	60xx,0022	LO	
Overlay Subtype	60xx,0045	LO	
ROI Area	60xx,1301	IS	
ROI Mean	60xx,1302	DS	
ROI Standard Deviation	60xx,1303	DS	
Overlay Label	60xx,1500	LO	
SOP COMMON MODULE			

Name	Tag	VR	Comment
Instance Creation Date	0008,0012	DA	
Instance Creation Time	0008,0013	TM	
Instance Creator UID	0008,0014	UI	
Coding Scheme Identification Sequence	0008,0110	SQ	
Timezone Offset From UTC	0008,0201	SH	
Contributing Equipment Sequence	0018,A001	SQ	
Instance Number	0020,0013	IS	
SOP Instance Status	0100,0410	CS	
SOP Authorization Date and Time	0100,0420	DT	
SOP Authorization Comment	0100,0424	LT	
Authorization Equipment Certification Number	0100,0426	LO	
MAC Parameters Sequence	4FFE,0001	SQ	
Digital Signatures Sequence	FFFA,FFFA	SQ	

Table 151: Cleared Attributes for Storage

Name	Tag	VR	Comment
PATIENT MODULE			
Patient's Name	0010,0010	PN	
Patient ID	0010,0020	LO	
Patient's Birth Date	0010,0030	DA	
Patient's Sex	0010,0040	CS	
CLINICAL TRIAL SUBJECT MODULE			
Clinical Trial Protocol Name	0012,0021	LO	
Clinical Trial Site ID	0012,0030	LO	
Clinical Trial Site Name	0012,0031	LO	
GENERAL STUDY MODULE			
Study Date	0008,0020	DA	
Study Time	0008,0030	TM	
Accession Number	0008,0050	SH	
Referring Physician's Name	0008,0090	PN	
Study ID	0020,0010	SH	
CLINICAL TRIAL STUDY MODULE			
Clinical Trial Time Point ID	0012,0050	LO	
GENERAL SERIES MODULE			
Series Number	0020,0011	IS	
Laterality	0020,0060	CS	
CLINICAL TRIAL SERIES MODULE			
Clinical Trial Coordinating Center Name	0012,0060	LO	
GENERAL EQUIPMENT MODULE			
Manufacturer	0008,0070	LO	
MASK MODULE			
Recommended Viewing Mode	0028,1090	CS	
OVERLAY/CURVE ACTIVATION MODULE			
Curve Activation Layer	50xx,1001	CS	
Overlay Activation Layer	60xx,1001	CS	

The Eleva allows the operator to modify attributes of the stored images; see Table 150. The Eleva does not modify the pixel values of the stored images. Modified images retain their original Study, Series and Image UID.

Table 152: Modifiable Attributes

Name	Tag	VR	Comment
PATIENT			
Patient's Name	0010,0010	PN	
Patient ID	0010,0020	LO	
Patient's Birth Date	0010,0030	DA	
Patient's Sex	0010,0040	CS	
Medical Alerts	0010,2000	LO	
Contrast Allergies	0010,2110	LO	
Patient Comments	0010,4000	LT	
STUDY			
Accession Number	0008,0050	SH	
Referring Physician's Name	0008,0090	PN	
Study Description	0008,1030	LO	
Physician(s) of Record	0008,1048	PN	
Name of Physician(s) Reading Study	0008,1060	PN	
Admitting Diagnoses Description	0008,1080	LO	
Patient's Age	0010,1010	AS	
Occupation	0010,2180	SH	
Additional Patient History	0010,21B0	LT	
EXAMINATION			
Performed Station Name	0040,0242	SH	
Performed Location	0040,0243	SH	
Performed Procedure Step Description	0040,0254	LO	
Performed Procedure Type Description	0040,0255	LO	
Comments on the Performed Procedure Step	0040,0280	ST	

8.2. Data Dictionary of Private Attributes

Not applicable.

8.3. Coded Terminology and Templates

Not applicable.

8.3.1. Context Groups

Not applicable.

8.3.2. Template Specifications

Not applicable.

8.3.3. Private code definitions

Not applicable.

8.4. Grayscale Image consistency

The high-resolution display monitor attached to the product can be calibrated by using the service tool together with a light probe. See the [VFRB] for details on the calibration procedure.

8.5. Standard Extended/Specialized/Private SOPs

Standard Extended SOP Classes

The standard DICOM SOP classes may be extended with additional attributes:

- Standard attributes of other SOP Classes - the presence of these attributes in exported images can be configured, see section 4.2.2.3.1.3.3;
- Retired (from ACR NEMA 1.0 or 2.0) attributes - the presence of these attributes in exported images can be configured, see section 4.2.2.3.1.3.3;
- Private attributes - the presence of these attributes in exported images can be configured, see section 4.2.2.3.1.3.3.

Standard Specialized SOP Classes

Table 128 lists the supported specialized SOP classes. These SOP classes are only to be used in the Eleva domain. However instances of these specialized SOP Classes may be exported towards a PACS environment and stored in a (central) DICOM archive; if required, then the support of the relevant SOP classes should be configured.

Table 153: Specialized SOP classes of the Eleva System

SOP Class Name	SOP Class UID
Specialized PMS X-Ray Image Store	1.3.46.670589.2.3.1.1
XA Reconstructed X-Ray	1.3.46.670589.2.4.1.1
3D Volume Storage	1.3.46.670589.5.0.1.1
3D Object Storage	1.3.46.670589.5.0.2.1
Surface Storage	1.3.46.670589.5.0.3.1
Cardio Image Storage	1.3.46.670589.5.0.8.1
CT Synthetic Image Storage	1.3.46.670589.5.0.9
MR Synthetic Image Storage	1.3.46.670589.5.0.10
MR Cardio Analysis Storage	1.3.46.670589.5.0.11.1
CX Synthetic Image Storage	1.3.46.670589.5.0.12
Perfusion	1.3.46.670589.5.0.13
Perfusion Image Storage	1.3.46.670589.5.0.14

8.6. Private Transfer Syntaxes

Not applicable.