

DICOM Conformance Statement

DigitalDiagnost R4.3



Issued by:

Philips Medical Systems Nederland BV, a Philips Healthcare company,

P.O. Box 10.000
5680 DA Best
The Netherlands

Internet: <https://www.philips.com/healthcare/about/customer-support>

Document Number: ICAP-PF.0049313

Date: 2020-Aug-19

© 2019 Koninklijke Philips N.V.

SNIP-IOCC-T-020001.09 (Version 1.0)

1. DICOM Conformance Statement Overview

This document is the DICOM Conformance Statement for the Philips Medical Systems DigitalDiagnost R4.3 system.

DigitalDiagnost R4.3 is an embedded modality system for acquiring DICOM images. It provides, among other things, the following features:

- Verification of application level communication.
- Basic Worklist Management (BWLM).
- Storage of images on a remote DICOM System.
- Commitment request for stored images on a remote DICOM system (Push Model)
- Storage of Dose SR instances on as remote DICOM System.
- Study Management per Modality Performed Procedure Step (MPPS).
- Printing of hardcopies on a remote DICOM Printer.
- Storage of images per DICOM Media on CD/DVD.
- Query and Retrieve of instances from an external DICOM system (Q/R)

The figure below shows the position of the DigitalDiagnost R4.3 in a radiology environment.

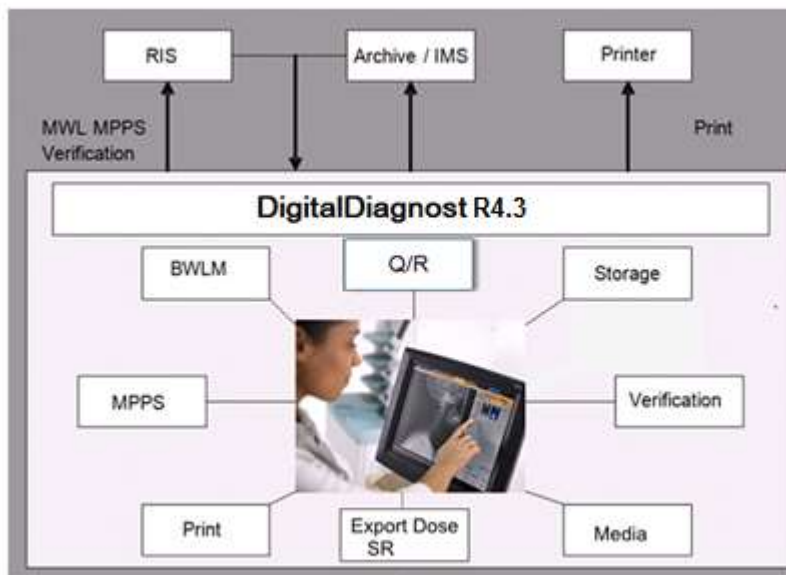

Figure 1: DigitalDiagnost R4.3 in a DICOM network

A table of Supported Networking DICOM Services, (SOP) Classes is provided with roles (User/Provider) and can be found on the next page.

The services can be specified as a SCU, SCP or as an Option, which means that it is either configurable or that it can be purchased separately.

Table 1: Network Services

SOP Class		User of Service (SCU)	Provider of Service (SCP)	Display
Name	UID			
Other				
Verification SOP Class	1.2.840.10008.1.1	Yes	Yes	N/A

SOP Class		User of Service (SCU)	Provider of Service (SCP)	Display
Name	UID			
Print Management				
Basic Grayscale Print Management Meta SOP Class	1.2.840.10008.5.1.1.9	Yes	No	N/A
>Basic Film Box SOP Class	1.2.840.10008.5.1.1.2	Yes	No	N/A
>Basic Film Session SOP Class	1.2.840.10008.5.1.1.1	Yes	No	N/A
>Basic Grayscale Image Box SOP Class	1.2.840.10008.5.1.1.4	Yes	No	N/A
>Printer SOP Class	1.2.840.10008.5.1.1.16	Yes	No	N/A
Query/Retrieve				
Patient Root QR Information Model - FIND SOP Class	1.2.840.10008.5.1.4.1.2.1.1	Yes	No	N/A
Patient Root QR Information Model - MOVE SOP Class	1.2.840.10008.5.1.4.1.2.1.2	Yes	No	N/A
Study Root QR Information Model - FIND SOP Class	1.2.840.10008.5.1.4.1.2.2.1	Yes	No	N/A
Study Root QR Information Model - MOVE SOP Class	1.2.840.10008.5.1.4.1.2.2.2	Yes	No	N/A
Transfer				
Computed Radiography Image Storage SOP Class	1.2.840.10008.5.1.4.1.1.1	Yes	Yes	Yes
Digital X-Ray Image Storage - For Pres. SOP	1.2.840.10008.5.1.4.1.1.1.1	Yes	Yes	Yes
Digital X-Ray Image Storage - For Proc. SOP	1.2.840.10008.5.1.4.1.1.1.1.1	Yes	Yes	Yes
Secondary Capture Image Storage SOP Class	1.2.840.10008.5.1.4.1.1.7	Yes	Yes	Yes
X-Ray Radiation Dose SR	1.2.840.10008.5.1.4.1.1.88.67	Yes	No	No
Workflow Management				
Modality Performed Procedure Step SOP Class	1.2.840.10008.3.1.2.3.3	Yes	No	N/A
Modality Worklist Information Model - FIND SOP Class	1.2.840.10008.5.1.4.31	Yes	No	N/A
Storage Commitment Push Model SOP Class	1.2.840.10008.1.20.1	Yes	No	N/A

A table of Supported Media services by DigitalDiagnost R4.3 are shown in the below table.

Table 2: Media Services

Media Storage Application Profile	File-set Creator (FSC)	File-set Updater (FSU)	File-set Reader (FSR)
Compact Disk-Recordable			
General Purpose CD-R Interchange	Yes	No	No
General Purpose Secure CD-R Interchange	Yes	No	No
DVD			
General Purpose DVD Interchange with JPEG	Yes	No	No
General Purpose Secure DVD Interchange with JPEG	Yes	No	No

2. Table of Contents

1.	DICOM CONFORMANCE STATEMENT OVERVIEW	3
2.	TABLE OF CONTENTS	5
3.	INTRODUCTION	7
3.1.	REVISION HISTORY	7
3.2.	AUDIENCE	7
3.3.	REMARKS	7
3.4.	DEFINITIONS, TERMS AND ABBREVIATIONS.....	8
3.5.	REFERENCES.....	9
4.	NETWORKING	10
4.1.	IMPLEMENTATION MODEL	10
4.1.1.	Application Data Flow.....	10
4.1.2.	Functional Definition of AE's	11
4.1.2.1.	Functional Definition of Eleva AE.....	11
4.1.3.	Sequencing of Real World Activities	12
4.2.	AE SPECIFICATIONS	14
4.2.1.	Eleva AE	14
4.2.1.1.	SOP Classes	14
4.2.1.2.	Association Policies	14
4.2.1.2.1.	General	14
4.2.1.2.2.	Number of Associations.....	15
4.2.1.2.3.	Asynchronous Nature	15
4.2.1.2.4.	Implementation Identifying Information.....	15
4.2.1.2.5.	Communication Failure Handling.....	15
4.2.1.3.	Association Initiation Policy	15
4.2.1.3.1.	(Real-World) Activity – Verification as SCU	17
4.2.1.3.2.	(Real-World) Activity – Modality worklist As SCU	18
4.2.1.3.3.	(Real-World) Activity – Modality Performed Procedure Step as SCU	27
4.2.1.3.4.	(Real-World) Activity – Image Export.....	33
4.2.1.3.5.	(Real-World) Activity – Storage Commitment Push Model AS SCU	36
4.2.1.3.6.	(Real-World) Activity – Structured Dose Report Export	38
4.2.1.3.7.	(Real-World) Activity - Find as SCU.....	40
4.2.1.3.8.	(Real-World) Activity - Move as SCU.....	42
4.2.1.3.9.	(Real-World) Activity – Print Management as SCU.....	45
4.2.1.4.	Association Acceptance Policy	49
4.2.1.4.1.	(Real-World) Activity – Verification as SCP	52
4.3.	NETWORK INTERFACES.....	53
4.3.1.	Physical Network Interfaces	53
4.3.2.	Additional Protocols	53
4.3.3.	IPv4 and IPv6 Support	53
4.4.	CONFIGURATION	53
4.4.1.	AE Title/Presentation Address Mapping.....	53
4.4.1.1.	Local AE Titles.....	53
4.4.1.2.	Remote AE Title/Presentation Address Mapping.....	53
4.4.2.	Parameters.....	53
5.	MEDIA INTERCHANGE	55
5.1.	IMPLEMENTATION MODEL	55
5.1.1.	Application Data Flow Diagram	55
5.1.2.	Functional Definitions of AE's.....	55
5.1.3.	Sequencing of Real World Activities	55
5.2.	AE SPECIFICATIONS	55
5.2.1.	Media Storage Media – Specification	55

5.2.1.1.	File Meta Information for the Media Storage.....	56
5.2.1.2.	Real World Activities.....	56
5.2.1.2.1.	RWA - Create File-set.....	56
5.3.	AUGMENTED AND PRIVATE APPLICATION PROFILES.....	58
5.4.	MEDIA CONFIGURATION.....	59
6.	SUPPORT OF CHARACTER SETS.....	60
7.	SECURITY.....	61
7.1.	SECURITY PROFILES.....	61
7.1.1.	Security use Profiles.....	61
7.1.2.	Security Transport Connection Profiles.....	61
7.1.3.	Digital Signature Profiles.....	62
7.1.4.	Media Storage Security Profiles.....	62
7.1.5.	Attribute Confidentiality Profiles.....	62
7.1.6.	Network Address Management Profiles.....	64
7.1.7.	Time Synchronization Profiles.....	64
7.1.8.	Application Configuration Management Profiles.....	64
7.1.9.	Audit Trail Profiles.....	64
7.2.	ASSOCIATION LEVEL SECURITY.....	64
7.3.	APPLICATION LEVEL SECURITY.....	65
8.	ELEVA.....	66
8.1.	IOD CONTENTS.....	66
8.1.1.	Created SOP Instances.....	66
8.1.1.1.	Computed Radiography Image Storage SOP Class.....	66
8.1.1.2.	Digital X-Ray Image Storage - For Pres. SOP.....	70
8.1.1.3.	Digital X-Ray Image Storage - For Proc. SOP.....	77
8.1.1.4.	Secondary Capture Image Storage SOP Class.....	81
8.1.1.5.	X-Ray Radiation Dose SR SOP Class.....	84
8.1.2.	Usage of Attributes from Received IODs.....	87
8.1.3.	Attribute Mapping.....	87
8.2.	DATA DICTIONARY OF PRIVATE ATTRIBUTES.....	88
8.3.	CODED TERMINOLOGY AND TEMPLATES.....	88
8.3.1.	Context Groups.....	88
8.3.2.	Template Specifications.....	89
8.3.2.1.	X-RAY RADIATION DOSE SR IOD TEMPLATES.....	89
8.3.2.1.1.	TID 10001 Projection X-Ray Radiation Dose.....	90
8.3.2.1.2.	TID 10002 Accumulated X-Ray Dose.....	90
8.3.2.1.3.	TID 10003 Irradiation Event X-Ray Data.....	91
8.3.2.1.1.	TID 10003a Irradiation Event X-Ray Detector Data.....	91
8.3.2.1.2.	TID 10003b Irradiation Event X-Ray Source Data.....	91
8.3.2.1.3.	TID 10003c Irradiation Event X-Ray Mechanical Data.....	92
8.3.2.1.4.	TID 10004 Accumulated Projection X-Ray Dose.....	92
8.3.2.1.5.	TID 1002 Observer Context.....	92
8.3.2.1.6.	TID 1004 Device Observer Identifying Attributes.....	92
8.3.2.1.7.	TID 10007. Accumulated Total Projection Radiography Dose.....	93
8.3.3.	Private code definitions.....	93
8.4.	GRAYSCALE IMAGE CONSISTENCY.....	93
8.5.	STANDARD EXTENDED/SPECIALIZED/PRIVATE SOPS.....	93
8.5.1.	Standard Extended/Specialized/Private SOP Instance.....	93
8.5.1.1.	Computed Radiography Image Storage SOP Class.....	94
8.5.1.2.	Secondary Capture Image Storage SOP Class.....	94
8.5.1.3.	Digital X-Ray Image Storage - For Pres. SOP.....	95
8.5.1.4.	Digital X-Ray Image Storage - For Proc. SOP.....	96
8.5.1.5.	X-Ray Radiation Dose SR SOP Class.....	97
8.6.	PRIVATE TRANSFER SYNTAXES.....	98

3. Introduction

3.1. Revision History

The revision history provides dates and differences of the different releases.

Table 3: Revision History

Document Version	Date of Issue	Description of change
01	2020-08-19	First release for DigitalDiagnost R4.3

3.2. Audience

This Conformance Statement is intended for:

- (Potential) customers
- System integrators of medical equipment
- Marketing staff interested in system functionality
- Software designers implementing DICOM interfaces

It is assumed that the reader is familiar with the DICOM standard.

3.3. Remarks

The DICOM Conformance Statement is contained in chapter 4 through 8 and follows the contents and structuring requirements of DICOM PS 3.2.

This DICOM Conformance Statement by itself does not guarantee successful interoperability of Philips equipment with non-Philips equipment. The user (or user's agent) should be aware of the following issues:

- **Interoperability**
Interoperability refers to the ability of application functions, distributed over two or more systems, to work successfully together. The integration of medical devices into an IT environment may require application functions that are not specified within the scope of DICOM. Consequently, using only the information provided by this Conformance Statement does not guarantee interoperability of Philips equipment with non-Philips equipment. It is the user's responsibility to analyze thoroughly the application requirements and to specify a solution that integrates Philips equipment with non-Philips equipment.
- **Validation**
Philips equipment has been carefully tested to assure that the actual implementation of the DICOM interface corresponds with this Conformance Statement. Where Philips equipment is linked to non-Philips equipment, the first step is to compare the relevant Conformance Statements. If the Conformance Statements indicate that successful information exchange should be possible, additional validation tests will be necessary to ensure the functionality, performance, accuracy and stability of image and image related data. It is the responsibility of the user (or user's agent) to specify the appropriate test suite and to carry out the additional validation tests.
- **New versions of the DICOM Standard**
The DICOM Standard will evolve in future to meet the user's growing requirements and to incorporate new features and technologies. Philips is actively involved in this evolution and plans to adapt its equipment to future versions of the DICOM Standard. In order to do so, Philips reserves the right to make changes to its products or to discontinue its delivery. The user should ensure that any non-Philips provider linking to Philips equipment also adapts to future versions of the DICOM Standard. If not, the incorporation of DICOM enhancements into Philips equipment may lead to loss of connectivity (in case of networking) and incompatibility (in case of media).
The user should ensure that any non-Philips provider linking to Philips equipment also adapts to future versions of the DICOM Standard. If not, the incorporation of DICOM enhancements into Philips equipment may lead to loss of connectivity (in case of networking) and incompatibility (in case of media).

3.4. Definitions, Terms and Abbreviations

Table 4: Definitions, Terms and Abbreviations

Abbreviation/Term	Explanation
AE	Application Entity
ANSI	American National Standard Institute
AP	Application Profile
BOT	Basic Offset Table
BWLM	Basic Worklist Management
CD	Compact Disc
CD-R	CD-Recordable
CD-M	CD-Medical
CR	Computed Radiography
DCR	Dynamic Cardio Review
DICOM	Digital Imaging and Communications in Medicine
DIMSE	DICOM Message Service Element
DIMSE-C	DIMSE-Composite
DIMSE-N	DIMSE-Normalized
DX	Digital X-Ray
EBE	DICOM Explicit VR Big Endian
ELE	DICOM Explicit VR Little Endian
FSC	File-set Creator
FSR	File-set Reader
FSU	File-set Updater
GUI	Graphic User Interface
HIS	Hospital Information System
HL7	Health Level Seven
ILE	DICOM Implicit VR Little Endian
IMS	Image Management System
IOD	Information Object Definition
ISIS	Information System - Imaging System
MOD	Modifier
MPPS	Modality Performed Procedure Step
NEMA	National Electrical Manufacturers Association
PDU	Protocol Data Unit
RF	X-Ray Radiofluoroscopic
RIS	Radiology Information System
RWA	Real-World Activity
SC	Secondary Capture
SCM	Study Component Management
SCP	Service Class Provider
SCU	Service Class User
SOP	Service Object Pair
TCP/IP	Transmission Control Protocol/Internet Protocol

Abbreviation/Term	Explanation
UID	Unique Identifier
WLM	Worklist Management

3.5. References

[DICOM] Digital Imaging and Communications in Medicine, Parts 1 - 22 (NEMA PS 3.1- PS 3.22),
National Electrical Manufacturers Association
1300 North 17th Street
Suite 900
Arlington, Virginia 22209
Internet: <https://www.dicomstandard.org/current>

Note that at any point in time the official standard consists of the most recent yearly edition of the base standard (currently 2020) plus all the supplements and correction items that have been approved as Final Text.

4. Networking

This section contains the networking related services (vs. the media related ones).

4.1. Implementation model

The implementation model consists of three sections:

- The application data flow diagram, specifying the relationship between the Application Entities and the "external world" or Real-World Activities,
- A functional description of each Application Entity, and
- The sequencing constraints among them.

4.1.1. Application Data Flow

The DigitalDiagnost R4.3 system consists of one single application entity, the DigitalDiagnost R4.3 Application Entity (Eleva AE). The figure below shows the networking application data flow as a functional overview of the Eleva AE.

It incorporates the following functionality:

- The Eleva AE can verify application level communication by using the verification service as SCP.
- The Eleva AE can request a worklist by using the Basic Worklist Management service as SCU.
- The Eleva AE can store images by using the Storage service as SCU and use the Storage-Commit SOP-Class perform storage-commit as SCU.
- The Eleva AE can store Dose SR instances by using the Storage service as SCU.
- The Eleva AE can compose the modality performed procedure step by using the Study Management service as SCU.
- The Eleva AE can print images by using the Print Management service as SCU.
- The Eleva AE can Query and retrieve images from a remote DICOM node.

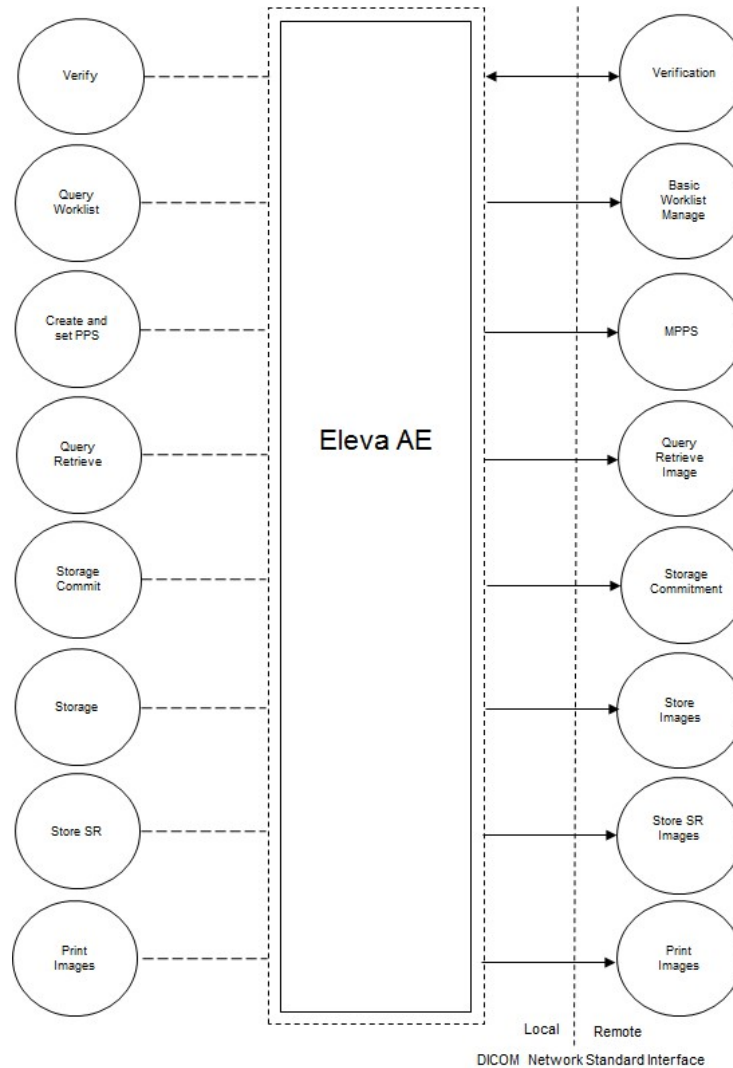

Figure 2: Application Data Flow Diagram

4.1.2. Functional Definition of AE's

This section contains a functional definition for each individual local Application Entity.

4.1.2.1. Functional Definition of Eleva AE

The Eleva AE is the one and only application entity within DigitalDiagnost R4.3 It includes the following service classes.

Verification Service Class

The Eleva AE provides the Verification service as SCP.

A remote SCU sends an association request with the Eleva AE for Verification SOP class. After accepting the association the Eleva AE receives and responds to the Verification request and releases the association when requested.

Basic Worklist Management Service Class

The Eleva AE provides the Basic Worklist Management service as SCU.

Eleva AE requests an association with the configured remote Basic Worklist Management SCP. After accepting the association the Eleva AE sends worklist query, wait for response, and then release the association. The user interface will be updated with the query results.

Storage Service Class

The Eleva AE provides the Storage service as SCU.

After a performed procedure step the Eleva AE stores the related images and the created X-Ray DOSE Report to the configured Storage SCP. It requests an association with the remote Storage SCP for the applicable Storage SOP classes. After accepting the association the Eleva AE will send the store request, wait for response, and then releases the association.

After successful storage the user interface will be updated accordingly.

After successful storage, if selected, the Eleva AE requests storage commitment per Storage Commitment service (ref. Storage Commitment Service Class)

Remark: There is no X-RAY DOSE Report created for the following patient types:

- Emergency Patient
- Bucky Patient
- QA Patient

Storage Commitment Service Class

The Eleva AE provides the Storage Commitment service as SCU.

The Eleva AE requests an association with the selected remote SCP for the Storage Commitment Push Model SOP class. When the association is accepted, the Eleva AE will send the Storage Commitment requests receive the Storage Commitment responses and act accordingly, and release the association. When the remote commitment actions have been finished, the remote SCP will request an association with the Eleva AE (still SCU). After accepting the association, the Eleva AE receives the Storage Commitment reports, and releases the association when requested.

The Storage Commitment Service can be done synchronously and asynchronously.

A detailed specification of the Storage Commitment is described in section 4.2.1.3.6 (Real-World Activity: Storage Commitment Push Model as SCU).

Remark: Storage Commitment is not requested for the exported DOSE SR Report.

Modality Performed Procedure Step Service Class

The Eleva AE provides the Modality Performed Procedure Step as SCU.

Before performing a procedure step the Eleva AE will request an association with the configured remote MPPS SCP. After accepting the association the Eleva AE sends a create request, wait for response, and then releases the association.

After performing a procedure step the Eleva AE will request a new association to send a set request, and after response, release the association. Depending on the status of creates and set and the configuration the Eleva AE performs a retry. The user interface will be updated with the performed procedure step status.

Basic Grayscale Print Management Meta Class

The Eleva AE provides the Basic Grayscale Print Management service as SCU.

After a performed procedure step the Eleva AE will print the related images on the configured Printer. It requests an association with the remote Basic Grayscale Print Management SCP for the applicable Basic Grayscale Print Management SOP class. After accepting the association the Eleva AE sends the print request, waits for response, and then releases the association.

After successful printing the user interface shall be updated accordingly.

4.1.3. Sequencing of Real World Activities

The figure below shows a typical sequence of an examination using a worklist. The user updates the worklist (query Worklist) and then selects and opens an examination. When the user starts the examination (acquiring the first image), the RIS is notified (Create Performed Procedure Step). After the user confirmed each acquisition (image 1-N) per default the image is printed (Print Image) and Image is sent to archive (Store Image). Finally, when closing the examination, the RIS is notified to update the data of the examination (Set Performed Procedure Step).

Note that Print Image will send images to the printer only when enough images were received to fulfill the configured printer format or when the print job is flushed manually. When the last image of an examination is received the print job will be flushed automatically.

Storage Commitment will be requested directly after export. The Storage Commit N-EVENT-REPORT can be sent by PACS at any time (also after "Close Exam")

© 2019 Koninklijke Philips N.V.

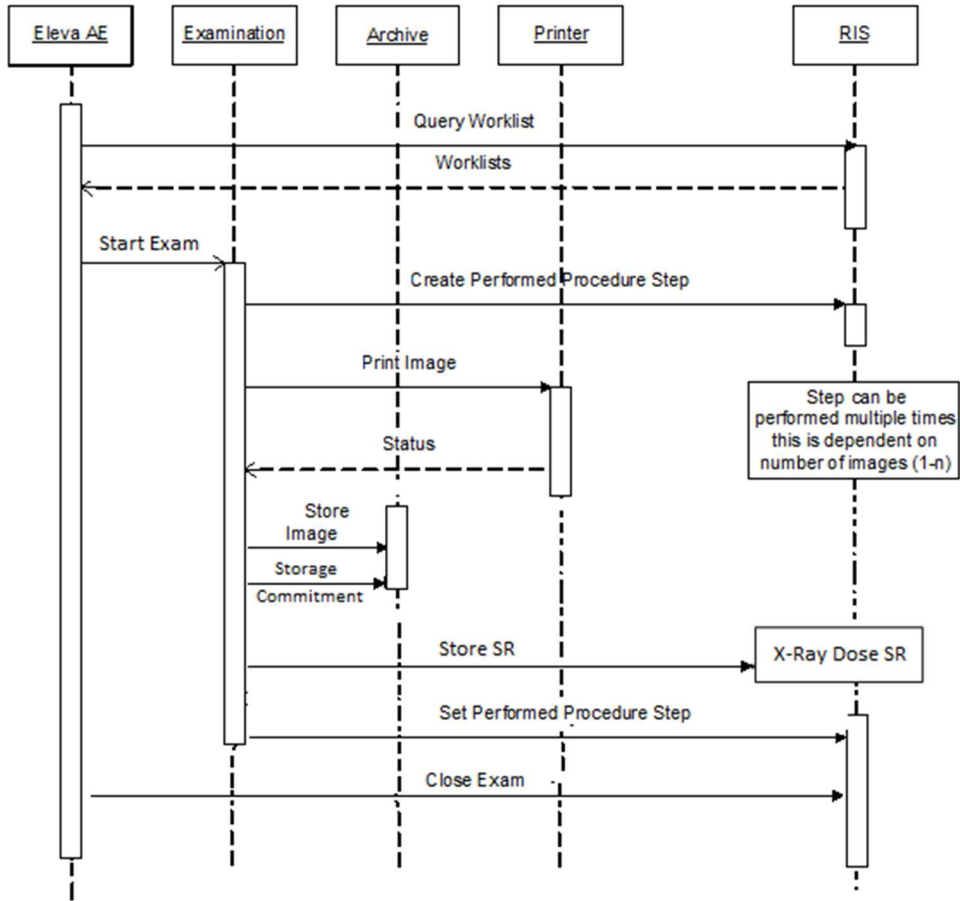

Figure 3: Sequence of an examination

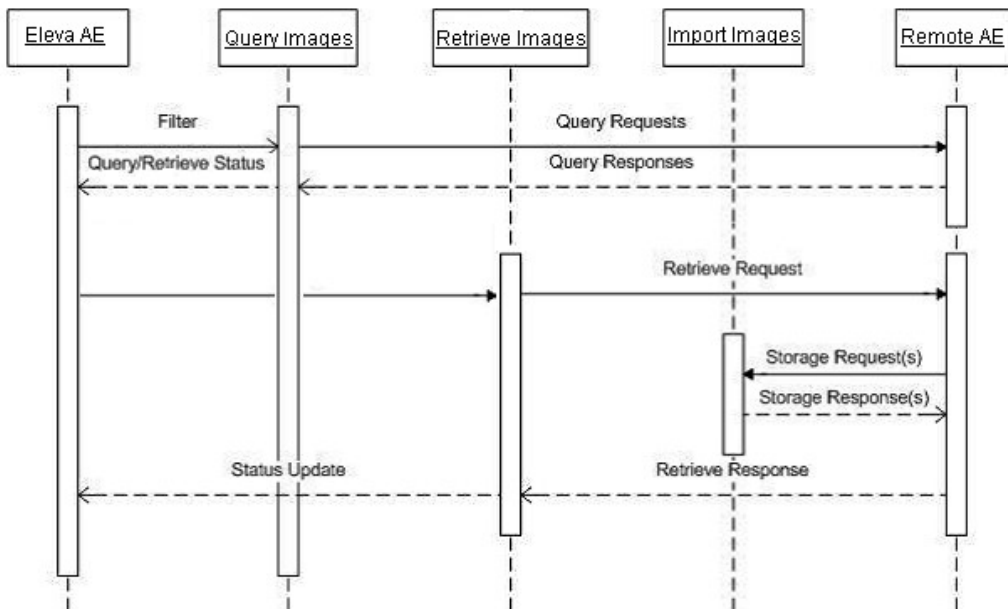

Figure 4: Sequence of Query/Retrieve

4.2. AE Specifications

This section in the DICOM Conformance Statement is a set of Application Entity specifications. There are as many of these subsections as there are different AE's in the implementation.

4.2.1. Eleva AE

Detail of this specific Application Entity is specified in this section.

4.2.1.1. SOP Classes

This Application Entity provides Standard Conformance to the following SOP Classes.

Table 5: SOP Classes for Eleva AE

SOP Class Name	SOP Class UID	SCU	SCP
Verification SOP Class	1.2.840.10008.1.1	Yes	Yes
Modality Performed Procedure Step SOP Class	1.2.840.10008.3.1.2.3.3	Yes	No
Basic Grayscale Print Management Meta SOP Class	1.2.840.10008.5.1.1.9	Yes	No
>Basic Film Session SOP Class	1.2.840.10008.5.1.1.1	Yes	No
>Basic Film Box SOP Class	1.2.840.10008.5.1.1.2	Yes	No
>Basic Grayscale Image Box SOP Class	1.2.840.10008.5.1.1.4	Yes	No
>Printer SOP Class	1.2.840.10008.5.1.1.16	Yes	No
Computed Radiography Image Storage SOP Class	1.2.840.10008.5.1.4.1.1.1	Yes	Yes
Digital X-Ray Image Storage - For Pres. SOP	1.2.840.10008.5.1.4.1.1.1.1	Yes	Yes
Digital X-Ray Image Storage - For Proc. SOP	1.2.840.10008.5.1.4.1.1.1.1.1	Yes	Yes
Secondary Capture Image Storage SOP Class	1.2.840.10008.5.1.4.1.1.7	Yes	Yes
X-Ray Radiation Dose SR	1.2.840.10008.5.1.4.1.1.88.67	Yes	No
Patient Root QR Information Model - FIND SOP Class	1.2.840.10008.5.1.4.1.2.1.1	Yes	No
Patient Root QR Information Model - MOVE SOP Class	1.2.840.10008.5.1.4.1.2.1.2	Yes	No
Study Root QR Information Model - FIND SOP Class	1.2.840.10008.5.1.4.1.2.2.1	Yes	No
Study Root QR Information Model - MOVE SOP Class	1.2.840.10008.5.1.4.1.2.2.2	Yes	No
Storage Commitment Push Model SOP Class	1.2.840.10008.1.20.1	Yes	No
Modality Worklist Information Model - FIND SOP Class	1.2.840.10008.5.1.4.31	Yes	No

Note: Any SOP specific behavior is documented later in the conformance statement in the applicable SOP specific conformance section.

4.2.1.2. Association Policies

Each AE specification contains a description of the general association establishment and acceptance policies of the AE.

4.2.1.2.1. General

The DICOM standard application context is specified below.

Table 6: DICOM Application Context

Description	Value
Application Context Name	1.2.840.10008.3.1.1.1

4.2.1.2.2. Number of Associations

The number of simultaneous associations that an Application Entity may support as an Initiator or Acceptor is specified here.

Table 7: Number of associations as an Association Initiator for this AE

Description	Value
Maximum number of simultaneous associations	3

Table 8: Number of associations as an Association Acceptor for this AE

Description	Value
Maximum number of simultaneous associations	20

4.2.1.2.3. Asynchronous Nature

The implementation supports negotiation of multiple outstanding transactions, along with the maximum number of outstanding transactions supported.

Table 9: Asynchronous nature as an Association Initiator for this AE

Description	Value
Maximum number of outstanding asynchronous transactions	No enforced limit

4.2.1.2.4. Implementation Identifying Information

The value supplied for Implementation Class UID and version name are documented here.

Table 10: DICOM Implementation Class and Version for Eleva AE

Implementation Class UID	1.3.46.670589.30.42.0
Implementation Version Name	PMS_ELEVA_42.0

4.2.1.2.5. Communication Failure Handling

The behavior of the AE during communication failure is summarized in the next table.

Table 11: Communication Failure Behavior

Exception	Behavior
Timeout	The Association is aborted using A-ABORT and command marked as failed. The reason is logged and reported to the user.
Association aborted	The command is marked as failed. The reason is logged and reported to the user.

4.2.1.3. Association Initiation Policy

The Application Entity will respond to a received Association rejection as shown in the table 12.

Table 12: Association Rejection response

Result	Source	Reason/Diagnosis	Behavior
1 - rejected-permanent	1 - DICOM UL service-user	1 - no-reason-given	Error message is shown to user and the error is logged.
		2 - application-context-name-not supported	Error message is shown to user and the error is logged.
		3 - calling-AE-title-not-recognized	Error message is shown to user and the error is logged.
		7 - called-AE-title-not-recognized	Error message is shown to user and the error is logged.

Result	Source	Reason/Diagnosis	Behavior
	2 - DICOM UL service-provider (ACSE related function)	1 - no-reason-given	Error message is shown to user and the error is logged.
		2 - protocol-version-not-supported	Error message is shown to user and the error is logged.
	3 - DICOM UL service-provider (Presentation related function)	1 - temporary-congestion	Error message is shown to user and the error is logged.
		2 - local-limit-exceeded	Error message is shown to user and the error is logged.
2 - rejected-transient	1 - DICOM UL service-user	1 - no-reason-given	Error message is shown to user and the error is logged.
		2 - application-context-name-not-supported	Error message is shown to user and the error is logged.
		3 - calling-AE-title-not-recognized	Error message is shown to user and the error is logged.
		7 - called-AE-title-not-recognized	Error message is shown to user and the error is logged.
	2 - DICOM UL service-provider (ACSE related function)	1 - no-reason-given	Error message is shown to user and the error is logged.
		2 - protocol-version-not-supported	Error message is shown to user and the error is logged.
	3 - DICOM UL service-provider (Presentation related function)	1 - temporary-congestion	Error message is shown to user and the error is logged.
		2 - local-limit-exceeded	Error message is shown to user and the error is logged.

The behavior of the AE on receiving an Association abort is summarized in the next table.

Table 13: Association Abort Handling

Source	Reason/Diagnosis	Behavior
0 - DICOM UL service-user (initiated abort)	0 - reason-not-specified	Error message is shown to user and the error is logged.
2 - DICOM UL service-provider (initiated abort)	0 - reason-not-specified	Error message is shown to user and the error is logged.
	1 - unrecognized-PDU	Error message is shown to user and the error is logged.
	2 - unexpected-PDU	Error message is shown to user and the error is logged.
	4 - unrecognized-PDU-parameter	Error message is shown to user and the error is logged.
	5 - unexpected-PDU-parameter	Error message is shown to user and the error is logged.
	6 - invalid-PDU-parameter-value	Error message is shown to user and the error is logged.

The behavior of the AE during DICOM communication failure is summarized in next table.

Table 14: DICOM Command Communication Failure Behavior

Source	Reason/Diagnosis	Behavior
Timeout	The Association is aborted using A-ABORT and command marked as failed. The reason is logged and reported to the user.	Timeout
Association aborted	The command is marked as failed. The reason is logged and reported to the user.	Association aborted

4.2.1.3.1. (Real-World) Activity – Verification as SCU

4.2.1.3.1.1. Description and Sequencing of Activities

The Eleva AE proposes the following presentation contexts to the remote AE during the association request before sending the C-ECHO

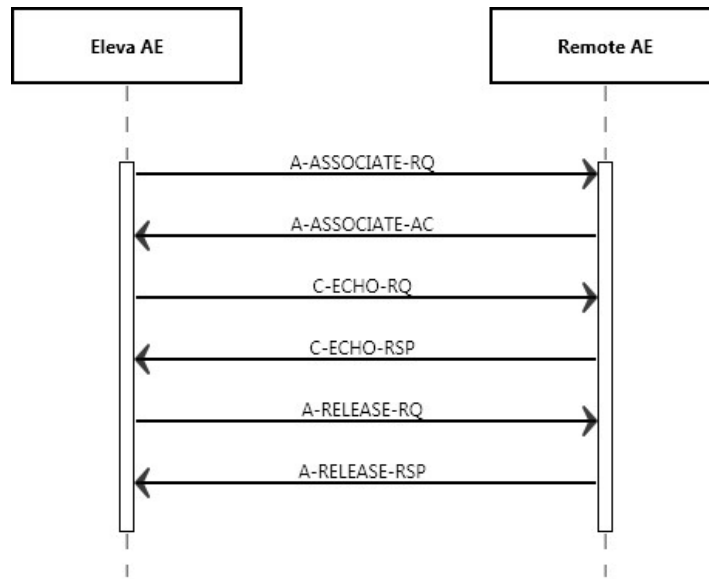

Figure 5: (Real World) Activity - Verification as SCU

Table 15: Proposed Presentation Contexts for (Real-World) Activity – Verification as SCU

Presentation Context Table					
Abstract Syntax		Transfer Syntax		Role	Extended Negotiation
Name	UID	Name List	UID List		
Verification SOP Class	1.2.840.10008.1.1	Explicit VR Big Endian	1.2.840.10008.1.2.2	SCU	None
		Explicit VR Little Endian	1.2.840.10008.1.2.1		
		Implicit VR Little Endian	1.2.840.10008.1.2		

4.2.1.3.1.2. SOP Specific Conformance for Verification SOP Class

This section and sub-section include the manufacturer SOP and Dataset specific information as well the status codes and their corresponding behavior.

4.2.1.3.1.2.1. Dataset Specific Conformance for Verification C-ECHO SCU

Detail regarding the Dataset Specific response behavior will be reported in this section.

This part of the section includes the dataset specific behavior, i.e. error codes, error and exception handling, time-outs, etc.

Table 16: Status Response

Service Status	Error Code	Further Meaning	Behavior
Success	0000	Confirmation	the SCU has successfully send C-ECHO
Other than success	Other than 0000	Problems with sending the C-ECHO	Reason is logged

4.2.1.3.2. (Real-World) Activity – Modality worklist As SCU

4.2.1.3.2.1. Description and Sequencing of Activities

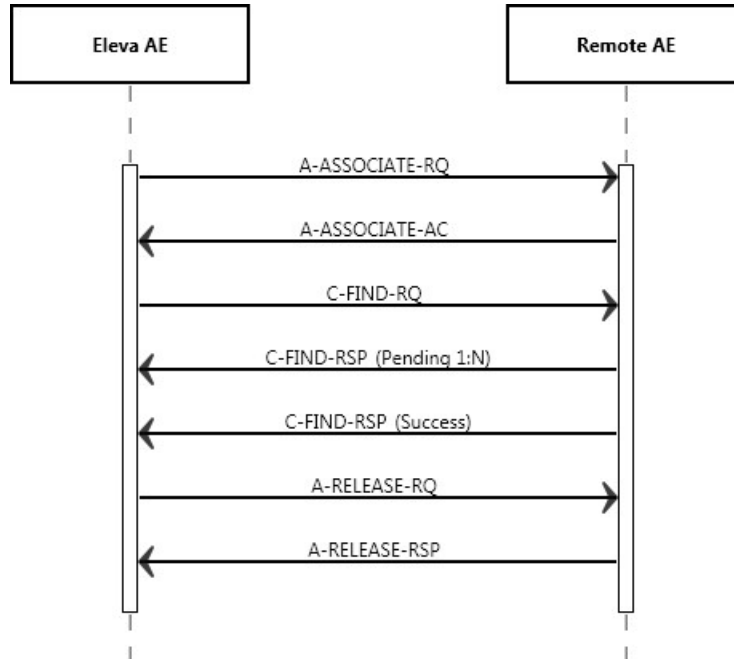

Figure 6: (Real World) Activity - Modality worklist As SCU

For each Broad or specific Worklist request, an association towards the Basic Worklist Management SCP is established and a C-FIND request is transmitted. The Broad query can be configured with a combination of the Matching Keys:

- Scheduled Station AE Title
- Scheduled Procedure Step Start Date
- Modality

Each of the matching keys is optional. The association will be closed on reception of the last C-FIND response. The Worklist Query result is displayed in the Patient List. The query is interruptible if it was triggered by the user.

After clicking the Query Worklist button the Eleva AE shall request an association with the configured remote Basic Worklist Management SCP. When the association is accepted the Eleva AE shall send the broad query find request, wait for response, and then release the association.

This RWA may be initiated in two ways:

After clicking the Patient button at the patient list screen the Eleva AE shall request an association with the configured remote Basic Worklist Management SCP. When the association is accepted the Eleva AE shall send the patient query find request, wait for response, and then release the association. Worklist request identifiers for Patient Query are shown in Table 18.

After clicking button for updating patient list the Eleva AE shall request an association with the configured remote Basic Worklist Management SCP. When the association is accepted the Eleva AE shall send the Broad Query find request, wait for response, and then release the association. Worklist request identifiers for Broad Query are shown in Table 21.

Optionally the Broad Query may also be performed automatically in the system background. The time interval between subsequent background queries is configurable.

Manual and automatic background queries are serialized and do not interfere with another.

4.2.1.3.2.2. Proposed Presentation Contexts

The presentation contexts are defined in table 17.

Table 17: Proposed Presentation Contexts for (Real-World) Activity – Modality worklist As SCU

Presentation Context Table					
Abstract Syntax		Transfer Syntax		Role	Extended Negotiation
Name	UID	Name List	UID List		
Modality Worklist Information Model - FIND SOP Class	1.2.840.10008.5.1.4.31	Explicit VR Big Endian	1.2.840.10008.1.2.2	SCU	None
		Explicit VR Little Endian	1.2.840.10008.1.2.1		
		Implicit VR Little Endian	1.2.840.10008.1.2		

4.2.1.3.2.3. SOP Specific Conformance for Modality Worklist Information Model - FIND SOP Class

This section and sub-section include the manufacturer SOP and Dataset specific information as well the status codes and their corresponding behavior.

4.2.1.3.2.3.1. Dataset Specific Conformance for Modality Worklist Information Model - FIND SOP Class C-FIND-SCU

Detail regarding the Dataset Specific response behavior will be reported in this section.

This part of the section includes the dataset specific behavior, i.e. error codes, error and exception handling, time-outs, etc.

The table below should be read as follows:

Attribute Name:	Attributes supported to build a Modality Worklist Request Identifier.
Tag:	DICOM tag for this attribute.
VR:	DICOM VR for this attribute.
M:	Matching Keys for (automatic) Worklist Update.
R:	Return Keys. An "X" will indicate that Modality will supply this attribute as Return Key with zero length for Universal Matching.
Q:	Interactive Query Key. An "X" will indicate that this attribute as matching key can be used.
D:	Displayed Keys. An "X" indicates that this Worklist attribute is displayed to the user during a patient registration dialog.
IOD:	An "X" indicates that the value of this Worklist attribute will be used in the created Instances of this Performed Procedure Step.
Type of matching:	The following types of matching exists: Single Value Matching List of UID Matching Wild Card Matching Range Matching Sequence Matching Universal Matching

Table 18: Worklist Request Identifier (Patient Query).

Attribute Name	Tag	VR	M	R	Q	D	IOD	Type of Matching	Comment
SOP Common Module									
Specific Character Set	0008,0005	CS							
Patient Identification Module									
Patient's Name	0010,0010	PN			X	X		Single Value, Universal, WildCard	
Patient ID	0010,0020	LO			X	X		Single Value, Universal	
Issuer of Patient ID	0010,0021	LO		X				Universal	
Other Patient IDs	0010,1000	LO		X				Universal	
Other Patient Names	0010,1001	PN		X				Universal	
Patient's Birth Name	0010,1005	PN		X				Universal	
Patient's Mother's Birth Name	0010,1060	PN		X				Universal	
Medical Record Locator	0010,1090	LO		X				Universal	
Patient Demographic Module									
Patient's Birth Date	0010,0030	DA		X		X		Universal	
Patient's Sex	0010,0040	CS		X		X		Universal	
Patient's Age	0010,1010	AS		X				Universal	
Patient's Size	0010,1020	DS		X		X		Universal	
Patient's Weight	0010,1030	DS		X		X		Universal	
Ethnic Group	0010,2160	SH		X		X		Universal	
Occupation	0010,2180	SH		X		X		Universal	
Patient Comments	0010,4000	LT		X		X		Universal	
Confidentiality Constraint on Patient Data Description	0040,3001	LO		X				Universal	
Patients Insurance Plan Code Sequence	0010,0050	SQ						Universal	
>Code Value	0008,0100	SH		X				Universal	
>Coding Scheme Designator	0008,0102	SH		X				Universal	
>Coding Scheme Version	0008,0103	SH		X				Universal	
>Code Meaning	0008,0104	LO		X				Universal	
Patient's Address	0010,1040	LO		X				Universal	
Military Rank	0010,1080	LO		X				Universal	
Branch of Service	0010,1081	LO		X				Universal	
Country of Residence	0010,2150	LO		X				Universal	
Region of Residence	0010,2152	LO		X				Universal	
Patient's Telephone Numbers	0010,2154	SH		X				Universal	
Patient's Religious Preference	0010,21F0	LO		X				Universal	
Patient Medical Module									
Medical Alerts	0010,2000	LO		X		X		Universal	
Allergies	0010,2110	LO		X		X		Universal	
Additional Patient History	0010,21B0	LT		X		X		Universal	
Pregnancy Status	0010,21C0	US		X		X		Universal	
Special Needs	0038,0050	LO		X				Universal	
Patient State	0038,0500	LO		X		X		Universal	
Smoking Status	0010,21A0	CS		X				Universal	
Last Menstrual Date	0010,21d0	DA		X				Universal	

Attribute Name	Tag	VR	M	R	Q	D	IOD	Type of Matching	Comment
Scheduled Procedure Step Module									
Scheduled Procedure Step Sequence	0040,0100	SQ		X					
>Modality	0008,0060	CS	X		X			Single Value, Universal	SOP Classes: CR, DX, OT, US, MG, RF, XA, PX, NM
>Requested Contrast Agent	0032,1070	LO		X				Universal	
>Scheduled Station AE Title	0040,0001	AE	X		X			Single Value, Universal	
>Scheduled Procedure Step Start Date	0040,0002	DA	X		X	X		Single Value, Universal	Value: All, Today, Tomorrow, Yesterday
>Scheduled Procedure Step Start Time	0040,0003	TM		X		X		Universal	
>Scheduled Procedure Step End Date	0040,0004	DA		X				Universal	
>Scheduled Procedure Step End Time	0040,0005	TM		X				Universal	
>Scheduled Performing Physician's Name	0040,0006	PN		X				Universal	
>Scheduled Procedure Step Description	0040,0007	LO		X		X		Universal	
>Scheduled Procedure Step ID	0040,0009	SH		X				Universal	This attribute is mandatory to be sent to Eleva AE. Eleva will not schedule a worklist item without it.
>Scheduled Station Name	0040,0010	SH		X				Universal	
>Scheduled Procedure Step Location	0040,0011	SH		X				Universal	
>Pre-Medication	0040,0012	LO		X				Universal	
>Scheduled Procedure Step Status	0040,0020	CS		X				Universal	
>Comments on the Scheduled Procedure Step	0040,0400	LT		X				Universal	
>Scheduled Protocol Code Sequence	0040,0008	SQ		X				Universal	
>>Code Value	0008,0100	SH		X				Universal	
>>Coding Scheme Designator	0008,0102	SH		X				Universal	
>>Coding Scheme Version	0008,0103	SH		X				Universal	
>>Code Meaning	0008,0104	LO		X				Universal	
Requested Procedure Module									
Study Instance UID	0020,000D	UI		X				Universal	
Requested Procedure Description	0032,1060	LO		X		X		Universal	
Requested Procedure ID	0040,1001	SH			X	X		Single Value, Universal	
Reason for the Requested Procedure	0040,1002	LO		X				Universal	
Requested Procedure Priority	0040,1003	SH		X				Universal	
Patient Transport Arrangements	0040,1004	LO		X				Universal	
Names of Intended Recipients of Results	0040,1010	PN		X				Universal	

Attribute Name	Tag	VR	M	R	Q	D	IOD	Type of Matching	Comment
Requested Procedure Comments	0040,1400	LT		X				Universal	
Requested Procedure Code Sequence	0032,1064	SQ		X				Universal	
>Code Value	0008,0100	SH		X				Universal	
>Coding Scheme Designator	0008,0102	SH		X				Universal	
>Coding Scheme Version	0008,0103	SH		X				Universal	
>Code Meaning	0008,0104	LO		X				Universal	
Study Date	0008,0020	DA		X				Universal	
Requested Procedure Location	0040,1005	LO		X				Universal	
Confidentiality Code	0040,1008	LO		X				Universal	
Reporting Priority	0040,1009	SH		X				Universal	
Imaging Service Request Module									
Accession Number	0008,0050	SH			X	X		Single Value, Universal	
Referring Physician's Name	0008,0090	PN		X				Universal	
Requesting Physician	0032,1032	PN		X				Universal	
Requesting Service	0032,1033	LO		X				Universal	
Reason for the Imaging Service Request (RETIRED)	0040,2001	LO		X				Universal	
Issue Date of Imaging Service Request	0040,2004	DA		X				Universal	
Imaging Service Request Comments	0040,2400	LT		X				Universal	
Admission ID	0038,0010	LO		X				Universal	
Issuer Of Admission ID	0038,0011	LO		X				Universal	
Placer Order Number Procedure	0040,1006	SH		X				Universal	
Filler Order Number Procedure	0040,1007	SH		X				Universal	
IssueTime of Imaging Service Request	0040,2005	TM		X				Universal	
Order Entered By	0040,2008	PN		X				Universal	
Order Enterer's Location	0040,2009	SH		X				Universal	
Order Callback Phone Number	0040,2010	SH		X				Universal	
Placer Order Number Imaging Service Request	0040,2016	LO		X				Universal	
Filler Order Number Imaging Service Request	0040,2017	LO		X				Universal	
Visit Identification Module									
Institution Name	0008,0080	LO		X				Universal	
Institution Address	0008,0081	ST		X				Universal	
Institution Code Sequence	0008,0082	SQ		X				Universal	
>Code Value	0008,0100	SH		X				Universal	
>Coding Scheme Designator	0008,0102	SH		X				Universal	
>Coding Scheme Version	0008,0103	SH		X				Universal	
>Code Meaning	0008,0104	LO		X				Universal	
Visit Status Module									
Referring Physician's Address	0008,0092	LO		X				Universal	
Referring Physician's Telephone Numbers	0008,0094	SH		X				Universal	

Attribute Name	Tag	VR	M	R	Q	D	IOD	Type of Matching	Comment
Admitting Diagnoses Description	0008,1080	LO		X				Universal	
Admitting Diagnoses Code Sequence	0008,1084	SQ		X					
>Code Value	0008,0100	SH		X				Universal	
>Coding Scheme Designator	0008,0102	SH		X				Universal	
>Coding Scheme Version	0008,0103	SH		X				Universal	
>Code Meaning	0008,0104	LO		X				Universal	
Visit Status ID	0038,0008	CS		X				Universal	
Patient's Institution Residence	0038,0400	LO		X				Universal	
Current Patient Location	0038,0300	LO		X				Universal	
Visit Comments	0038,4000	LT		X				Universal	
Visit Relationship Module									
Referenced Study Sequence	0008,1110	SQ		X					
>Referenced SOP Class UID	0008,1150	UI		X				Universal	
>Referenced SOP Instance UID	0008,1155	UI		X				Universal	
Referenced Patient Sequence	0008,1120	SQ		X					
>Referenced SOP Class UID	0008,1150	UI		X				Universal	
>Referenced SOP Instance UID	0008,1155	UI		X				Universal	
Patient Relationship Module									
Referenced Visit Sequence	0008,1125	SQ		X				Universal	
Referenced Patient Alias Sequence	0038,0004	SQ		X				Universal	
Visit Admission Module									
Route Of Admissions	0038,0016	LO		X				Universal	
Admitting Date	0038,0020	DA		X				Universal	
Admitting Time	0038,0021	TM		X				Universal	

Table 19: C-FIND-RQ Status Response

Service Status	Code	Further Meaning	Behavior
Success	0000	Matching is complete	The Worklist is updated.
Failure	A700	Refused – Out of resources	The association is released. The reason is logged.
	A900	Failed – Identifier does not match SOP class	The association is released. The reason is logged.
	Cxxx	Failed – Unable to process	The association is released. The reason is logged.
Cancel	FE00	Matching terminated due to Cancel request	The association is released. The reason is logged.
Pending	FF00	Matches are continuing – Current match is supplied and any optional keys were supported in the same manner as required keys	The Query Worklist job continues.
	FF01	Matches are continuing – Warning that one or more optional keys were not supported for existence and/or matching for this identifier	The Query Worklist job continues.

Table 20: DICOM Command Communication Failure Behavior

Exception	Behavior
RIS query timeout (default 240 seconds)	The Association is aborted using A-ABORT and command marked as failed. The reason is logged and reported to the user.
Association aborted	The command is marked as failed. The reason is logged and reported to the user.

4.2.1.3.2.4. Patient and Study Merge

The Eleva AE looks in its internal database for a Study with the same Study Instance UID (0020, 000D) as given in the Scheduled Procedure Step.

The Patient identifying attributes are DICOM 'Patient ID' (0010, 0020) together with DICOM 'Issuer of Patient ID' (0010, 0021). If a Patient with matching identifying attributes was found, attributes are updated for the internal Patient based on the attributes as given in the Scheduled Procedure Step. The update for the Patient attributes can be disabled in PSC tool (Configuration->Network->External nodes-> Worklist management (WLM) ->Patient information reconciliation).

A Patient is secured from changes if it is

- 1) Selected for acquisition or
- 2) At least one image was already acquired.

A new Study with a Study Instance UID as given in the Scheduled Procedure Step is created.

If a Study Instance UID match was found, all Patient attributes as given in the Scheduled Procedure Step are updated in the internal database for the parent patient of this study. Study attributes are updated for the internal study based on the attributes as given in the Scheduled Procedure Step.

4.2.1.3.2.5. Scheduled Procedure Step (= Examination) Merge

If the Eleva AE's internal database contains no SPS with Scheduled Procedure Step ID (0040, 0009) identifying an incoming Scheduled Procedure Step, it creates a new one and creates a corresponding Examination referencing this Scheduled Procedure Step ID.

If the Eleva AE's internal database contains already an SPS with the Scheduled Procedure Step ID (0040, 0009) identifying an incoming Scheduled Procedure Step, the behavior depends on the corresponding Examination state.

If the Examination is still "scheduled", the SPS attributes are compared to the attributes sent with the most recent WLM query. If at least one attribute differs, the scheduled Examination is deleted and re-scheduled. Manual changes the user might have performed on this Examination are lost.

If the Examination has already started, no changes are performed, and the potential changes of the incoming Scheduled Procedure Step are disregarded.

4.2.1.3.2.5.1. Dataset Specific Conformance for Modality Worklist (Broad Query) C-FIND SCU

The table below should be read as follows:

Attribute Name:	Attributes supported to build a Modality Worklist Request Identifier.
Tag:	DICOM tag for this attribute.
VR:	DICOM VR for this attribute.
M:	Matching Keys for (automatic) Worklist Update.
R:	Return Keys. An "X" will indicate that this attribute can be used as Matching Key for Universal Matching.

Q: Interactive Query Key. An "X" will indicate that this attribute as matching key can be used.

D: Displayed Keys. An "X" indicates that this Worklist attribute is displayed to the user during a patient registration dialog.

IOD: An "X" indicates that the value of this Worklist attribute will be used in the created Instances of this Performed Procedure Step.

Type of matching: The following types of matching exists:
 Single Value Matching
 List of UID Matching
 Wild Card Matching
 Range Matching
 Sequence Matching
 Universal Matching

Table 21: Worklist Request Identifier (Broad Query)

Attribute Name	Tag	VR	M	R	Q	D	IOD	Type of Matching	Comment
SOP Common Module									
Specific Character Set	0008,0005	CS							
Patient Identification Module									
Patient's Name	0010,0010	PN		X		X		Universal	
Patient ID	0010,0020	LO		X		X		Universal	
Issuer of Patient ID	0010,0021	LO		X				Universal	
Other Patient IDs	0010,1000	LO		X				Universal	
Patient Demographic Module									
Patient's Birth Date	0010,0030	DA		X		X		Universal	
Patient's Sex	0010,0040	CS		X		X		Universal	
Patient's Age	0010,1010	AS		X				Universal	
Patient's Size	0010,1020	DS		X				Universal	
Patient's Weight	0010,1030	DS		X		X		Universal	
Ethnic Group	0010,2160	SH		X				Universal	
Occupation	0010,2180	SH		X		X		Universal	
Patient Comments	0010,4000	LT		X				Universal	
Confidentiality Constraint on Patient Data Description	0040,3001	LO		X				Universal	
Patient Medical Module									
Medical Alerts	0010,2000	LO		X		X		Universal	
Allergies	0010,2110	LO		X				Universal	
Additional Patient History	0010,21B0	LT		X				Universal	
Pregnancy Status	0010,21C0	US		X		X		Universal	
Special Needs	0038,0050	LO		X				Universal	
Patient State	0038,0500	LO		X				Universal	
Visit Status Module									
Current Patient Location	0038,0300	LO		X				Universal	
Scheduled Procedure Step Module									
Scheduled Procedure Step Sequence	0040,0100	SQ		X				Universal	
>Modality	0008,0060	CS	X					Single Value, Universal	
>Requested Contrast Agent	0032,1070	LO		X				Universal	
>Scheduled Station AE Title	0040,0001	AE	X					Single Value, Universal	

Attribute Name	Tag	VR	M	R	Q	D	IOD	Type of Matching	Comment
>Scheduled Procedure Step Start Date	0040,0002	DA	X					Single Value, Universal	
>Scheduled Procedure Step Start Time	0040,0003	TM		X				Universal	
>Scheduled Procedure Step End Date	0040,0004	DA		X				Universal	
>Scheduled Procedure Step End Time	0040,0005	TM		X				Universal	
>Scheduled Performing Physician's Name	0040,0006	PN		X		X		Universal	
>Scheduled Procedure Step Description	0040,0007	LO		X				Universal	
>Scheduled Procedure Step ID	0040,0009	SH		X				Universal	
>Scheduled Station Name	0040,0010	SH		X				Universal	
>Scheduled Procedure Step Location	0040,0011	SH		X				Universal	
>Pre-Medication	0040,0012	LO		X				Universal	
>Scheduled Procedure Step Status	0040,0020	CS		X				Universal	
>Comments on the Scheduled Procedure Step	0040,0400	LT		X				Universal	
>Scheduled Protocol Code Sequence	0040,0008	SQ		X				Universal	
>>Code Value	0008,0100	SH		X				Universal	
>>Coding Scheme Designator	0008,0102	SH		X				Universal	
>>Coding Scheme Version	0008,0103	SH		X				Universal	
>>Code Meaning	0008,0104	LO		X				Universal	
Requested Procedure Module									
Study Instance UID	0020,000D	UI		X				Universal	
Requested Procedure Description	0032,1060	LO		X				Universal	
Requested Procedure ID	0040,1001	SH		X				Universal	
Reason for the Requested Procedure	0040,1002	LO		X				Universal	
Requested Procedure Priority	0040,1003	SH		X				Universal	
Patient Transport Arrangements	0040,1004	LO		X				Universal	
Names of Intended Recipients of Results	0040,1010	PN		X				Universal	
Requested Procedure Comments	0040,1400	LT		X				Universal	
Referenced Study Sequence	0008,1110	SQ		X				Universal	
>Referenced SOP Class UID	0008,1150	UI		X				Universal	
>Referenced SOP Instance UID	0008,1155	UI		X				Universal	
Requested Procedure Code Sequence	0032,1064	SQ		X				Universal	
>Code Value	0008,0100	SH		X				Universal	
>Coding Scheme Designator	0008,0102	SH		X				Universal	
>Coding Scheme Version	0008,0103	SH		X				Universal	
>Code Meaning	0008,0104	LO		X				Universal	
Imaging Service Request Module									
Accession Number	0008,0050	SH		X		X		Universal	
Referring Physician's Name	0008,0090	PN		X		X		Universal	

Attribute Name	Tag	VR	M	R	Q	D	IOD	Type of Matching	Comment
Requesting Physician	0032,1032	PN		X		X		Universal	
Requesting Service	0032,1033	LO		X				Universal	
Reason for the Imaging Service Request (RETIRED)	0040,2001	LO		X				Universal	
Issue Date of Imaging Service Request	0040,2004	DA		X				Universal	
Imaging Service Request Comments	0040,2400	LT		X				Universal	

Table 22: Status Response

Service Status	Error Code	Further Meaning	Behavior
Success	0000	Matching is complete	The SCU has successfully returned all matching information
Failure	A700	Refused – Out of resources	The association is released. The reason is logged.
	A900	Failed – Identifier does not match SOP class	The association is released. The reason is logged.
	Cxxx	Failed – Unable to process	The association is released. The reason is logged.
Cancel	FE00	Matching terminated due to Cancel request	The association is released. The reason is logged.
Pending	FF00	Matches are continuing – Current match is supplied and any optional keys were supported in the same manner as required keys	The Query worklist job continues.
	FF01	Matches are continuing – Warning that one or more optional keys were not supported for existence and/or matching for this identifier	The Query worklist job continues.

4.2.1.3.2.5.2. Dataset Specific Conformance for Modality Worklist Information Model - FIND RSP SCU

This section includes the dataset specific behavior, i.e. error codes, error and exception handling, time-outs, etc.

Table 23: DICOM Command Communication Failure Behavior

Exception	Behavior
RIS query timeout (default 240 seconds)	The Association is aborted using A-ABORT and command marked as failed. The reason is logged and reported to the user.
Association aborted	The command is marked as failed. The reason is logged and reported to the user.

4.2.1.3.2.5.3. Dataset Specific Conformance for Modality Worklist Information Model - FIND C-CANCEL SCU

This section includes the dataset specific behavior, i.e. error codes, error and exception handling, time-outs, etc.

Exception	Behavior
Timeout	The Association is aborted using AP-ABORT and command marked as failed. The reason is logged and reported to the user.
Association aborted	The command is marked as failed. The reason is logged and reported to the user.

4.2.1.3.3. (Real-World) Activity – Modality Performed Procedure Step as SCU

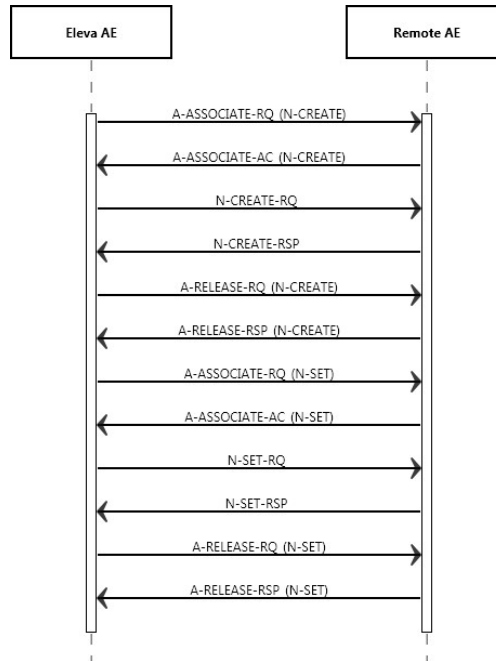

Figure 7: Modality Performed Procedure Step as SCU

4.2.1.3.3.1. Description and Sequencing of Activities

A DigitalDiagnost R4.3 “Examination” is regarded equivalent to a DICOM Procedure Step. It is scheduled or manually entered before an acquisition is taken, and performed by taking acquisitions. If scheduled by the RIS, one Examination is the result of one Scheduled Procedure Step. Since an examination may not be re-opened after having been closed, and each examination workflow context is enclosed in one MPPS, one examination may result in more than one N-SET instances that happens in case of appending an image for existing examination which is already closed.

After the image for a Scheduled Procedure Step has been acquired, the system sets the MPPS status of the related examination to “IN PROGRESS” and generates an initial MPPS N-CREATE message with status IN PROGRESS message. The system does not generate intermediate MPPS IN PROGRESS messages for subsequent acquisitions of this Scheduled Procedure Step instance.

After finishing the appropriate acquisition(s), the system will change the MPPS status of the related examination to “COMPLETED” and generate an MPPS N-SET-COMPLETED message.

DigitalDiagnost R4.3 also generates MPPS messages for unscheduled examinations.

The MPPS COMPLETED message will list the UID’s of all related DICOM archived images, RDSR and the format of (optionally) generated direct prints.

After abandoning or discontinuing a procedure step, the operator may set the MPPS status of the related examination to “DISCONTINUED” and the system generates a MPPS DISCONTINUED message. The reason for abandoning or discontinuing a procedure step is unspecified.

The operator may interchange the performed sequence order of scheduled procedure steps.

MPPS messages may interleave. Depending on the application workflow optimization by the user, an MPPS sequence like this may come up:

- MPPS / Scheduled Procedure Step1: N-CREATE (IN PROGRESS)
- MPPS / Scheduled Procedure Step2: N-CREATE (IN PROGRESS)
- MPPS / Scheduled Procedure Step3: N-CREATE (IN PROGRESS)

...
 MPPS / Scheduled Procedure Step2: N-SET (COMPLETED)
 MPPS / Scheduled Procedure Step1: N-SET (COMPLETED)
 MPPS / Scheduled Procedure Step3: N-SET (COMPLETED)

(i.e.: running multiple procedure steps 'in parallel').

Sequencing of Activities

After storing a performed procedure step the Eleva AE shall request an association with the configured remote Study Management SCP. After accepting the association the Eleva AE shall send a Create request, wait for response, and then release the association.

4.2.1.3.3.2. Proposed Presentation Contexts

The presentation contexts are defined in the next table.

Table 24: Proposed Presentation Contexts for (Real-World) Activity – Modality Performed Procedure Step As SCU

Presentation Context Table					
Abstract Syntax		Transfer Syntax		Role	Extended Negotiation
Name	UID	Name List	UID List		
Modality Performed Procedure Step SOP Class	1.2.840.10008.3.1.2.3.3	Explicit VR Big Endian	1.2.840.10008.1.2.2	SCU	None
		Explicit VR Little Endian	1.2.840.10008.1.2.1		
		Implicit VR Little Endian	1.2.840.10008.1.2		

4.2.1.3.3.3. SOP Specific Conformance for Modality Performed Procedure Step SOP Class

When acquiring the first image of a Scheduled or Unscheduled Procedure Step, DigitalDiagnost R4.3 generates a MPPS IN PROGRESS message.

DigitalDiagnost R4.3 does not generate intermediate IN PROGRESS (N-SET) messages and does not support the Performed Procedure Step Exception Management Option. DigitalDiagnost R4.3 has no Billing Code Tables but it supports the Performed Procedure Step Billing and Material Management Option only for default values for Medium Type (2000,0030) and Film Size ID (2010,0050), if optional Local Print is configured.

Assisted Acquisition Protocol Setting Option

Eleva AE by default derives the specific acquisition protocol from the Scheduled Protocol Code Sequence Items. Any single Item results in an Examination.

Eleva AE supports 3 more (configurable) mapping relations, as shown below:

- Examination is selected from Scheduled Protocol Code Items->Code Value (0040, 0008) (default)
- Examination is selected from Scheduled Procedure Step Description (0040, 0007)
- Examination is selected from Requested Procedure Code Items->Code Value (0032, 1064)
- Examination is selected from Requested Procedure Description (0032, 1060)

Eleva AE does not evaluate the attributes Coding Scheme Version (0008, 0103), Coding Scheme Designator (0008, 0102), Code Meaning (0008, 0104), but only the Code Value (0008, 0100), for mapping the examination settings. I.e. Eleva AE expects that any used Code Value is unique (unambiguous) within a given RIS domain.

Restrictions Depending on Number of Scheduled Protocol Code Items

It is highly recommended that the Scheduled Procedure Step contains only 1 Item in the Scheduled Protocol Code Sequence.

If the Scheduled Procedure Step contains <n> items in the Scheduled Protocol Code Sequence, the Scheduled Procedure Step is split into <n> examinations, where any single examination shows only 1 of the Scheduled Protocol Code Items, but all the other attributes are the same.

When such an examination is returned back via MPPS, also the Performed Protocol Code Sequence will show only 1 item. If all <n> Scheduled Procedure Step Code Items are performed, <n> MPPS instances will be sent back to the RIS, and the sum of all Performed Protocol Code Items will be <n>.

4.2.1.3.3.3.1. Dataset Specific Conformance for Modality Performed Procedure Step SOP Class N-CREATE-SCU

Table 25: MPPS Request Identifiers for N-CREATE-RQ

.Attribute Name	Tag	VR	Value	Comment
Performed Procedure Step Information Module				
Performed Station AE Title	0040,0241	AE	Eleva	Value can be configured
Performed Procedure Step Start Date	0040,0244	DA		Start of the examination
Performed Procedure Step Start Time	0040,0245	TM		Start of the examination
Performed Procedure Step Status	0040,0252	CS		
Performed Procedure Step ID	0040,0253	SH		
Performed Station Name	0040,0242	SH		EMPTY
Performed Location	0040,0243	SH		EMPTY
Performed Procedure Step End Date	0040,0250	DA		Finish of the examination
Performed Procedure Step End Time	0040,0251	TM		Finish of the examination
Performed Procedure Step Description	0040,0254	LO		
Performed Procedure Type Description	0040,0255	LO		
Procedure Code Sequence	0008,1032	SQ		
>Code Value	0008,0100	SH		
>Coding Scheme Designator	0008,0102	SH		
>Coding Scheme Version	0008,0103	SH		
>Code Meaning	0008,0104	LO		
Radiation Dose Module				
Image and Fluoroscopy Area Dose Product	0018,115E	DS		Not sent in case of appended MPPS Instances
Total Number of Exposures	0040,0301	US		
Entrance Dose	0040,0302	US		
Exposure Dose Sequence	0040,030E	SQ		
Entrance Dose in mGy	0040,8302	DS		
Performed Procedure Step Relationship Module				
Patient's Name	0010,0010	PN		
Patient ID	0010,0020	LO		
Issuer of Patient ID	0010,0021	LO		
Patient's Birth Date	0010,0030	DA		
Patient's Sex	0010,0040	CS		
Scheduled Step Attributes Sequence	0040,0270	SQ		

.Attribute Name	Tag	VR	Value	Comment
>Study Instance UID	0020,000D	UI		
>Accession Number	0008,0050	SH		
>Requested Procedure Description	0032,1060	LO		
>Scheduled Procedure Step Description	0040,0007	LO		
>Scheduled Procedure Step ID	0040,0009	SH		
>Requested Procedure ID	0040,1001	SH		
>Referenced Study Sequence	0008,1110	SQ		
>>Referenced SOP Class UID	0008,1150	UI		
>>Referenced SOP Instance UID	0008,1155	UI		
>Scheduled Protocol Code Sequence	0040,0008	SQ		
>>Code Value	0008,0100	SH		
>>Coding Scheme Designator	0008,0102	SH		
>>Code Meaning	0008,0104	LO		
Referenced Patient Sequence	0008,1120	SQ		
Image Acquisition Results Module				
Modality	0008,0060	CS	DX	
Study ID	0020,0010	SH		
Performed Protocol Code Sequence	0040,0260	SQ		
>Code Value	0008,0100	SH		
>Coding Scheme Designator	0008,0102	SH		
>Code Meaning	0008,0104	LO		
Performed Series Sequence	0040,0340	SQ		
Billing And Material Management Code Module				
Film Consumption Sequence	0040,0321	SQ		

Table 26: N-CREATE Status Response

Service Status	Code	Further Meaning	Behavior
Success	0000	Successful operation	The SCP has successfully received the modality performed procedure step create request. Log entry.
Failure	0213	Resource limitation	The command is reported to the user as failed. The reason is logged. After a configured period of time the storage will be retried up to a configured number of times.
	xxxx	Any failure accept	The command is reported to the user as failed. The reason is logged. No retry.

4.2.1.3.3.3.2. Dataset Specific Conformance for Modality Performed Procedure Step SOP Class N-SET-SCU

Table 27: MPPS Request Identifiers for N-SET-RQ

Attribute Name	Tag	VR	Value	Comment
Performed Procedure Step Information Module				
Performed Procedure Step End Date	0040,0250	DA		
Performed Procedure Step End Time	0040,0251	TM		
Performed Procedure Step Status	0040,0252	CS	COMPLETED or DISCONTINUED	

Attribute Name	Tag	VR	Value	Comment
Performed Procedure Step Description	0040,0254	LO		
Procedure Code Sequence	0008,1032	SQ		
>Code Value	0008,0100	SH		
>Coding Scheme Designator	0008,0102	SH		
>Code Meaning	0008,0104	LO		
Radiation Dose Module				
Image and Fluoroscopy Area Dose Product	0018,115E	DS		Not accumulating: re-processed images, non-digital images. Not sent in case of appended MPPS instances.
Total Time of Fluoroscopy	0040,0300	US		
Total Number of Exposures	0040,0301	US		Not accumulating: re-processed images, non-digital images. Not sent in case of appended MPPS instances.
Entrance Dose	0040,0302	US		
Exposure Dose Sequence	0040,030E	SQ		
>KVP	0018,0060	DS		
>Exposure Time	0018,1150	IS		
>Radiation Mode	0018,115A	CS		
>X-Ray Tube Current in uA	0018,8151	DS		
>Comments on Radiation Dose	0040,0310	ST		Note 1
Entrance Dose in mGy	0040,8302	DS		
Image Acquisition Results Module				
Performed Protocol Code Sequence	0040,0260	SQ		
>Code Value	0008,0100	SH		
>Coding Scheme Designator	0008,0102	SH		
>Code Meaning	0008,0104	LO		
Performed Series Sequence	0040,0340	SQ		
>Protocol Name	0018,1030	LO		Copied from Performed Protocol Code Sequence - Item code Value.
>Series Instance UID	0020,000E	UI		
>Retrieve AE Title	0008,0054	AE		
>Series Description	0008,103E	LO		
>Performing Physician's Name	0008,1050	PN		
>Operators' Name	0008,1070	PN		
>Referenced Image Sequence	0008,1140	SQ		
>>Referenced SOP Class UID	0008,1150	UI		
>>Referenced SOP Instance UID	0008,1155	UI		
>Referenced Non-Image Composite SOP Instance Sequence	0040,0220	SQ		
Billing And Material Management Code Module				
Film Consumption Sequence	0040,0321	SQ		
>Medium Type	2000,0030	CS		
>Film Size ID	2010,0050	CS		
>Number of Films	2100,0170	IS		

Note 1: Attribute only present in case MPPS extended mode is enabled.

Table 28: N-SET-RQ Status Response

Service Status	Code	Further Meaning	Behavior
Success	0000	Successful operation	The SCP has successfully received the modality performed procedure step create request. Log entry.
Failure	0110	Processing failure – performed procedure step object may no longer be updated	The reason is logged.
	xxxx	(any other failure)	The reason is logged.

4.2.1.3.4. (Real-World) Activity – Image Export
4.2.1.3.4.1. Description and Sequencing of Activities

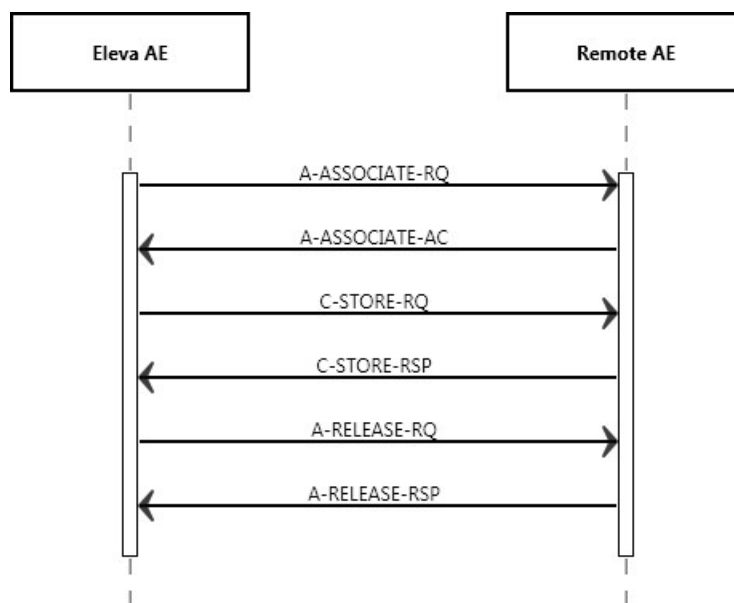

Figure 8: (Real World) Activity - Image Export

Export means that DigitalDiagnost R4.3 stores images without Storage Commitment.

This RWA may be initiated in two ways.

- Manually in the viewer, after clicking the Store button the ELEVA AE will store the selected images at the selected Storage SCP.
- Automatically during an examination, after clicking the Confirm button the ELEVA AE will automatically store the related images of the performed procedure step at the configured Storage SCP.

The ELEVA AE will request an association with the remote Storage SCP for the applicable Storage SOP classes. After accepting the association the ELEVA AE will send the store request, wait for response, and then release the association. The store response status may be inspected on the UI.

Depending on the status of the store the ELEVA AE may queue store requests for retries. The queued store requests can be cancelled from the UI.

4.2.1.3.4.2. Proposed Presentation Contexts

The presentation contexts are defined in the next table.

Table 29: Proposed Presentation Contexts for (Real-World) Activity – Image Export

Presentation Context Table					
Abstract Syntax		Transfer Syntax		Role	Extended Negotiation
Name	UID	Name List	UID List		
Computed Radiography Image Storage SOP Class	1.2.840.10008.5.1.4.1.1.1	Explicit VR Big Endian	1.2.840.10008.1.2.2	SCU	None
		Explicit VR Little Endian	1.2.840.10008.1.2.1		
		Implicit VR Little Endian	1.2.840.10008.1.2		
Digital X-Ray Image Storage - For Pres. SOP	1.2.840.10008.5.1.4.1.1.1.1	Explicit VR Big Endian	1.2.840.10008.1.2.2	SCU	None
		Explicit VR Little Endian	1.2.840.10008.1.2.1		
		Implicit VR Little Endian	1.2.840.10008.1.2		
Digital X-Ray Image Storage - For Proc. SOP	1.2.840.10008.5.1.4.1.1.1.1.1	Explicit VR Big Endian	1.2.840.10008.1.2.2	SCU	None
		Explicit VR Little Endian	1.2.840.10008.1.2.1		
		Implicit VR Little Endian	1.2.840.10008.1.2		
Secondary Capture Image Storage SOP Class	1.2.840.10008.5.1.4.1.1.7	Explicit VR Big Endian	1.2.840.10008.1.2.2	SCU	None
		Explicit VR Little Endian	1.2.840.10008.1.2.1		
		Implicit VR Little Endian	1.2.840.10008.1.2		

By default, all images are DICOM Stored according to the SOP Class Digital XRay. CR Image attributes that are undefined for DX Images are stored in private attributes.

As a configurable choice, Images can be stored as Computed Radiology SOP Class. This capability is required to be compatible with installed radiology equipment.

DX Image attributes that are undefined for CR Images are then stored in private attributes.

Another choice can be DICOM Stored according to Secondary Capture SOP Class. This capability is required to be compatible with installed radiology equipment. Optionally only the attributes defined for Secondary Capture Images or all attributes are stored

For DICOM CR images there is a constraint that a change in position, detector, body part or laterality implies a new series. This has been relaxed for DX images through the use of the 'DX Anatomy Imaged' and 'DX Positioning' Modules, which define attributes at image level.

The DX Image IOD is used in two SOP Classes as defined in the DICOM Standard, a SOP Class for storage of images intended for Presentation, and a SOP Class for storage of images intended for further Processing before presentation.

These are distinguished by their SOP Class UID and by the Enumerated Value of the mandatory Attribute in the DX Series Module, Presentation Intent Type (0008,0068).

It is possible to export / store one single image first as a DICOM CR and secondly as a DICOM DX object, therefore the SOP Instance UIDs of both DICOM image instances have to be different.

The Numbering Scheme shall support 'Hanging Protocols' of PACS systems & Viewing Stations, in case of the CR as well as the DX model:

1. The Series Number shall start with 1 for the first Series of every Study Instance, identified by StudyInstanceUID.
2. The Series Number shall increase by 1 for every new Series Instance within the same Study Instance, by the timely order, the Series Instances are created.
3. The Image Number shall start with 1 for every new Series Instance.
4. The Image Number shall increase by 1 for every new Image Instance within the same SeriesInstanceUID, by the timely order, the Images are exported.

For DX SOP Class is in the DICOM Standard defined:

© 2019 Koninklijke Philips N.V.

The Digital X-Ray (DX) Image Information Object Definition specifies an image that has been created by a digital projection radiography imaging device.

Notes:

- This includes but is not limited to: chest radiography, linear and multi-directional tomography, orthopantomography and skeletal radiography. Acquisition of image data may include but is not limited to: CCD-based sensors, stimuable phosphor imaging plates, amorphous selenium, scintillation based amorphous silicon and secondary capture of film-based images.
- Specific IODs are defined for intra-oral radiography and mammography that further specialize the DX IOD.

A DX image shall consist of the result of a single X-Ray exposure, in order to ensure that the anatomical and orientation attributes are meaningful for the image, permitting safe annotation, appropriate image processing and appropriate dissemination.

Notes:

- The requirement for the DigitalDiagnost R4.3 specifically deprecates the common film/screen and Computed Radiography practice of making multiple exposures on different areas of a cassette or plate by using lead occlusion between exposures. Such acquisitions could be separated and transformed into multiple DX images during an appropriate quality assurance step by an operator.
- The requirement for the DigitalDiagnost R4.3 does not deprecate the acquisition of multiple paired structures during a single exposure, provided that they can be described by the relevant orientation Attributes. For example, an AP or PA projection of both hands side by side is typically obtained in a single exposure, and can be described by a Patient Orientation (0020,0020) of R\H or L\H since both hands are in the same traditional Anatomical Position.

Note: By default new SOP instance UID is created each time when DICOM object is exported. This behavior is configurable.

4.2.1.3.4.3. SOP Specific Conformance for Storage SOP Classes

This section includes the SOP specific behavior, i.e. error codes, error and exception handling, time-outs, etc.

Behavior of an Application Entity SOP class is summarized as shown in next Table. The standard as well as the manufacturer specific status codes and their corresponding behavior are specified.

Table 30: C-STORE-RQ Status Response

Service Status	Code	Further Meaning	Behavior
Success	0000	Storage is complete	UI status is updated
Refused	A7xx	Out of resources	The association is released. The reason is logged. The user is informed.
Error	A9xx	Data set does not match SOP class	The association is released. The reason is logged. The user is informed.
	Cxxx	Cannot understand	The association is released. The reason is logged. The user is informed.
Warning	B000	Coercion of data elements	The association is released. The reason is logged. The user is informed.
	B006	Elements discarded	The association is released. The reason is logged. The user is informed.
	B007	Data set does not match SOP class	The association is released. The reason is logged. The user is informed.

The status can be inspected via the user interface.

4.2.1.3.5. (Real-World) Activity – Storage Commitment Push Model AS SCU

4.2.1.3.5.1. Description and Sequencing of Activities

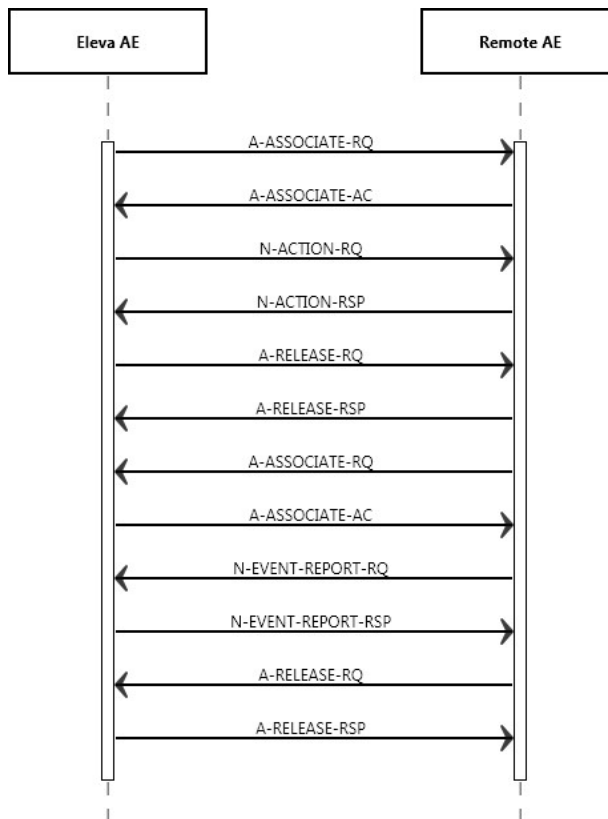

Figure 9: (Real World) Activity – Storage Commitment Push Model as SCU (asynchronous)

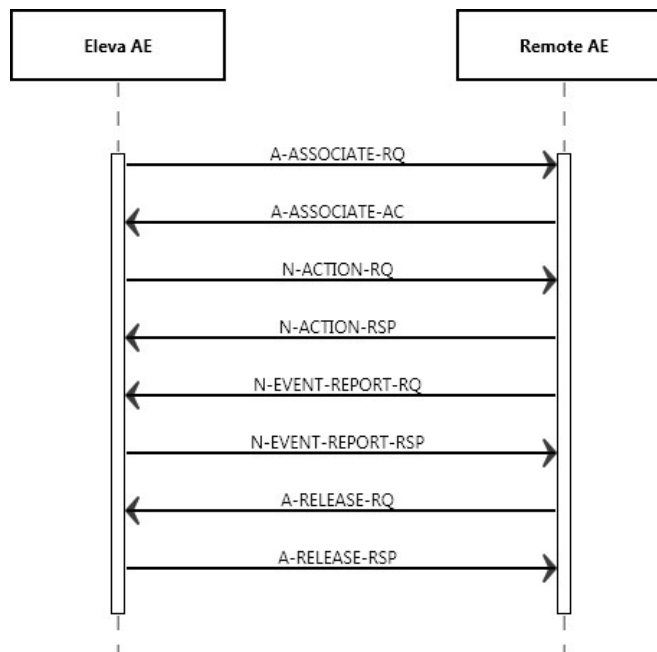

Figure 10: (Real World) Activity – Synchronous Storage Commitment Push Model as SCU (synchronous)

Archive means that DigitalDiagnost R4.3 stores images with Storage Commitment (both synchronous and asynchronous can be configured).

This RWA may be initiated in two ways.

- Manually in the viewer, after clicking the Store button the ELEVA AE will store the selected images at the selected Storage SCP.
- Automatically during an examination, after clicking the Confirm button the ELEVA AE will automatically store the related images of the performed procedure step at the configured Storage SCP.

The ELEVA AE will request an association with the remote Storage SCP for the applicable Storage SOP classes. After accepting the association the ELEVA AE will send the store request, wait for response, and then release the association. The store response status may be inspected on the UI. The transferred image shall not be deleted from the system until the Storage Commit N-Event is received.

Depending on the status of the store the ELEVA AE may queue store requests for retries. The queued store requests can be cancelled from the UI.

When an archive supports DICOM Storage Commitment, this node can be configured for it. For each image that is sent to this node, also a Storage Commitment Request is sent. The image is delete-protected until the Storage Commit Response has been received. The current status is shown in the Image Info Panel.

4.2.1.3.5.2. Proposed Presentation Contexts

The presentation contexts are defined in below table.

Table 31: Proposed Presentation Contexts for (Real-World) Activity – Storage Commitment Push Model AS SCU

Presentation Context Table					
Abstract Syntax		Transfer Syntax		Role	Extended Negotiation
Name	UID	Name List	UID List		
Storage Commitment Push Model SOP Class	1.2.840.10008.1.20.1	Explicit VR Big Endian	1.2.840.10008.1.2.2	SCU	None
		Explicit VR Little Endian	1.2.840.10008.1.2.1		
		Implicit VR Little Endian	1.2.840.10008.1.2		

4.2.1.3.5.3. SOP Specific Conformance for Storage Commitment Push Model SOP Class

This section and sub-section include the manufacturer SOP and Dataset specific information as well the status codes and their corresponding behavior.

4.2.1.3.5.3.1. Dataset Specific Conformance for Storage Commitment Push Model SOP Class N-EVENT-REPORT-SCP

Detail regarding the Dataset Specific response behavior will be reported in this section.

This part of the section includes the dataset specific behavior, i.e. error codes, error and exception handling, time-outs, etc.

Table 32: Storage Commitment Attribute for N-ACTION-RQ

Attribute Name	Tag	Comment
Storage Commitment Module		
Transaction UID	0008,1195	
Referenced SOP Sequence	0008,1199	
>Referenced SOP Class UID	0008,1150	
>Referenced SOP Instance UID	0008,1155	

Table 33: N-ACTION-RQ Status Response

Service Status	Code	Further Meaning	Behavior
Success	0000	Storage is complete	UI status is updated
Refused	A7xx	Out of resources	The association is released. The reason is logged. The user is informed.
Error	A9xx	Data set does not match SOP class	The association is released. The reason is logged. The user is informed.
	Cxxx	Cannot understand	The association is released. The reason is logged. The user is informed.
Warning	B000	Coercion of data elements	The association is released. The reason is logged. The user is informed.
	B006	Elements discarded	The association is released. The reason is logged. The user is informed.
	B007	Data set does not match SOP class	The association is released. The reason is logged. The user is informed.

Table 34: DICOM Command Communication Failure Behavior

Exception	Behavior
Association aborted	The command is marked as failed. The reason is logged and reported to the user.

4.2.1.3.5.3.2. Dataset Specific Conformance for Storage Commitment Push Model N-EVENT-REPORT SCP

This section includes the dataset specific behavior, i.e. error codes, error and exception handling, time-outs, etc.

Table 35: DICOM Command Communication Failure Behavior

Exception	Behavior
Timeout	The Association is aborted using AP-ABORT and command marked as failed. The reason is logged and reported to the user.
Association aborted	The command is marked as failed. The reason is logged and reported to the user.

4.2.1.3.6. (Real-World) Activity – Structured Dose Report Export

4.2.1.3.6.1. Description and Sequencing of Activities

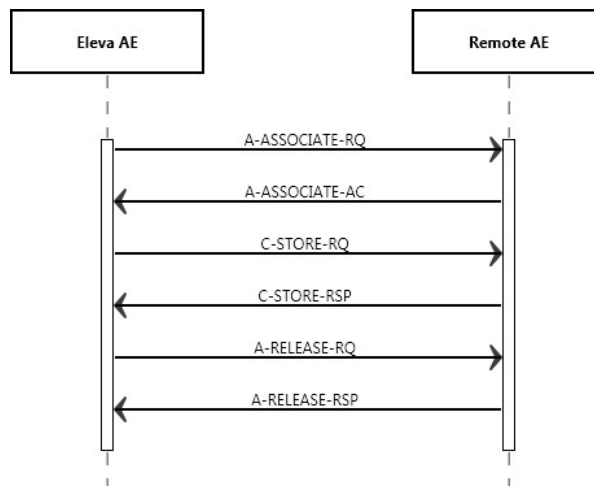

Figure 11: (Real World) Activity – Structured Dose Report Export

The Eleva AE will request an association with the remote Storage SCP for the applicable Storage SOP classes. After accepting the association, the Eleva AE will send the store request, wait for response, and then release the association. The store response status may be inspected on the UI.

4.2.1.3.6.2. Proposed Presentation Contexts

The presentation contexts are defined in below table.

Table 36: Proposed Presentation Contexts for (Real-World) Activity – Image Export

Presentation Context Table					
Abstract Syntax		Transfer Syntax		Role	Extended Negotiation
Name	UID	Name List	UID List		
X-Ray Radiation Dose SR	1.2.840.10008.5.1.4.1.1.88.67	Explicit VR Big Endian	1.2.840.10008.1.2.2	SCU	None
		Explicit VR Little Endian	1.2.840.10008.1.2.1		
		Implicit VR Little Endian	1.2.840.10008.1.2		

4.2.1.3.6.3. SOP Specific Conformance for Storage SOP Classes

This section and sub-section include the manufacturer SOP and Dataset specific information as well the status codes and their corresponding behavior.

4.2.1.3.6.3.1. Dataset Specific Conformance for C-STORE-RQ

Detail regarding the Dataset Specific response behavior will be reported in this section.

This includes the dataset specific behavior, i.e. error codes, error and exception handling, time-outs, etc.

Table 37: Status Response

Service Status	Code	Further Meaning	Behavior
Success	0000	Storage is complete	UI status is updated
Refused	A700	Out of resources	The association is released. On receiving error in C-STORE RSP messages store operation is unsuccessful
Error	A900	Data set does not match SOP class	The association is released. On receiving error in C-STORE RSP messages store operation is unsuccessful.
	C000	Cannot understand	The association is released. On receiving error in C-STORE RSP messages store operation is unsuccessful.
Warning	B000	Coercion of data elements	The association is released. On receiving error in C-STORE RSP messages store operation is unsuccessful.
	B006	Elements discarded	The association is released. On receiving error in C-STORE RSP messages store operation is unsuccessful
	B007	Data set does not match SOP class	The association is released. On receiving error in C-STORE RSP messages store operation is unsuccessful.

Table 38: DICOM Command Communication Failure Behavior

Exception	Behavior
Timeout	The Association is aborted using A-ABORT and command marked as failed. The reason is logged and reported to the user.
Association aborted	The command is marked as failed. The reason is logged and reported to the user.

4.2.1.3.7. (Real-World) Activity - Find as SCU
 4.2.1.3.7.1. Description and Sequencing of Activities

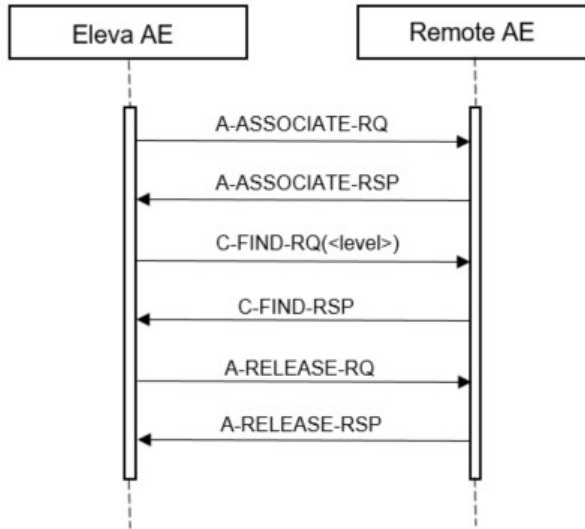

Figure 12 Data Flow Diagram – FIND as SCU

4.2.1.3.7.2. Proposed Presentation Contexts

Table 39 Proposed Presentation Contexts for (Real-World) Activity

Presentation Context Table					
Abstract Syntax		Transfer Syntax		Role	Ext. Neg.
Name	UID	Name	UID		
Patient Root QR Information Model - FIND SOP Class	1.2.840.10008.5.1.4.1.2.1.1	Implicit VR Little Endian: Default Transfer Syntax for DICOM	1.2.840.10008.1.2	SCU	None
		Explicit VR Little Endian	1.2.840.10008.1.2.1		
		Explicit VR Big Endian	1.2.840.10008.1.2.2		
Study Root QR Information Model - FIND SOP Class	1.2.840.10008.5.1.4.1.2.2.1	Implicit VR Little Endian: Default Transfer Syntax for DICOM	1.2.840.10008.1.2	SCU	None
		Explicit VR Little Endian	1.2.840.10008.1.2.1		
		Explicit VR Big Endian	1.2.840.10008.1.2.2		

4.2.1.3.7.3. SOP Specific Conformance for SOP Classes

4.2.1.3.7.3.1. SOP Specific Conformance for Patient Root QR Information Model - FIND SOP Class

4.2.1.3.7.3.1.1. Dataset Specific Conformance for Patient Root QR Information Model - FIND SOP Class C-FIND-SCU

Table 40 C-FIND-RQ Dataset Specification.

Patient Root QR Information Model - FIND SOP Class				
Attribute Name	Tag	V R	Type of Matching	Comment
Query/Retrieve Level	0008,0052	CS	Single Value	Patient, Study, Series
Patient Level Attributes For The Patient Root Query/Retrieve Information Model				
Patient's Name	0010,0010	PN	Single Value, Universal, WildCard	
Patient ID	0010,0020	LO	Single Value, Universal, WildCard	
Patient's Birth Date	0010,0030	DA	Single Value, Universal	
Other Patient Ids	0010,1000	LO	Single Value, Universal, WildCard	
Study Level Keys For The Patient Root Query/Retrieve Information Model				
Study Date	0008,0020	DA	Universal, Range	
Study Time	0008,0030	TM	Universal	
Accession Number	0008,0050	SH	Universal	
Study Instance UID	0020,000D	UI	Universal	
Study ID	0020,0010	SH	Universal	
Series Level Attributes For The Patient Root Query/Retrieve Information Model				
Modality	0008,0060	CS	Universal	
Series Instance UID	0020,000E	UI	Universal	
Series Number	0020,0011	IS	Universal	
Body Part Examined	0018,0015	CS	Universal	

Series level query is done automatically upon successful study level query.

4.2.1.3.7.3.2. SOP Specific Conformance for Study Root QR Information Model - FIND SOP Class

4.2.1.3.7.3.2.1. Dataset Specific Conformance for Study Root QR Information Model - FIND SOP Class C-FIND-SCU

Table 41 C-FIND-RQ Dataset Specification.

Study Root QR Information Model - FIND SOP Class				
Attribute Name	Tag	VR	Type of Matching	Comment
Query/Retrieve Level	0008,0052	CS	Single Value	Study, Series
Study Level Keys For The Study Root Query/Retrieve Information Model				
Study Date	0008,0020	DA	Range, Universal	
Study Time	0008,0030	TM	Universal	
Accession Number	0008,0050	SH	Universal	
Study Description	0008,1030	LO	Universal	
Patient's Name	0010,0010	PN	Single Value, Universal, WildCard	
Patient ID	0010,0020	LO	Single Value, Universal,	

			WildCard	
Patient's Birth Date	0010,0030	DA	Single Value, Universal	
Other Patient Ids	0010,1000	LO	Universal	
Study Instance UID	0020,000D	UI	Universal	
Study ID	0020,0010	SH	Universal	
Series Level Attributes For The Study Root Query/Retrieve Information Model				
Modality	0008,0060	CS	Universal	
Series Instance UID	0020,000E	UI	Universal	
Series Number	0020,0011	IS	Universal	
Body Part Examined	0018,0015	CS	Universal	

Series level query is done automatically upon successful study level query.

This part of the section includes the dataset specific behavior, i.e. error codes, error and exception handling, time-outs, etc.

Table 42: Status Response

Service Status	Error Code	Further Meaning	Behavior
Success	0000	Matching is complete – No final identifier is supplied	Successful completion of the query.
Failure	xxxx	All failures	Query is failed /Error logged

4.2.1.3.8. (Real-World) Activity - Move as SCU

4.2.1.3.8.1. Description and Sequencing of Activities

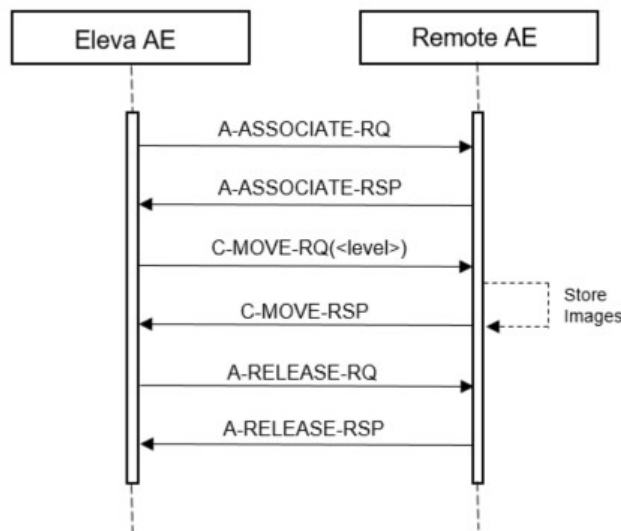

Figure 13: Data Flow Diagram – MOVE as SCU

4.2.1.3.8.2. Proposed Presentation Contexts

Table 43 Proposed Presentation Contexts for (Real-World) Activity

Presentation Context Table					
Abstract Syntax		Transfer Syntax		Role	Ext. Neg.
Name	UID	Name	UID		
Patient Root QR Information Model - MOVE SOP Class	1.2.840.10008.5.1.4.1.2.1.2	Implicit VR Little Endian: Default Transfer Syntax for DICOM	1.2.840.10008.1.2	SCU	None
		Explicit VR Little Endian	1.2.840.10008.1.2.1		
		Explicit VR Big Endian	1.2.840.10008.1.2.2		
Study Root QR Information Model - MOVE SOP Class	1.2.840.10008.5.1.4.1.2.2.2	Implicit VR Little Endian: Default Transfer Syntax for DICOM	1.2.840.10008.1.2	SCU	None
		Explicit VR Little Endian	1.2.840.10008.1.2.1		
		Explicit VR Big Endian	1.2.840.10008.1.2.2		

4.2.1.3.8.3. SOP Specific Conformance for SOP Classes

4.2.1.3.8.3.1. SOP Specific Conformance for Patient Root QR Information Model - MOVE SOP Class

4.2.1.3.8.3.1.1. Dataset Specific Conformance for Patient Root QR Information Model - MOVE SOP Class C-MOVE-SCU

Detail regarding the Dataset Specific response behavior will be reported in this section.

Table 44 C-MOVE-RQ Dataset Specification.

Patient Root QR Information Model - MOVE SOP Class			
Attribute Name	Tag	VR	Comment
Query/Retrieve Level	0008,0052	CS	Series

This part of the section includes the dataset specific behavior, i.e. error codes, error and exception handling, time-outs, etc.

Table 45: Status Response

Service Status	Error Code	Further Meaning	Behavior
Success	0000	Sub-operations complete – No failures	Successful completion of the retrieve; also storage warnings may have occurred.

4.2.1.3.8.3.2. SOP Specific Conformance for Study Root QR Information Model - MOVE SOP Class

4.2.1.3.8.3.2.1. Dataset Specific Conformance for Study Root QR Information Model - MOVE SOP Class C-MOVE-SCU

Table 46 C-MOVE-RQ Dataset Specification.

Study Root QR Information Model - MOVE SOP Class			
Attribute Name	Tag	VR	Comment
Query/Retrieve Level	0008,0052	CS	Series

This part of the section includes the dataset specific behavior, i.e. error codes, error and exception handling, time-outs, etc.

Table 47: Status Response

Service Status	Error Code	Further Meaning	Behavior
Success	0000	Sub-operations complete – No failures	Successful completion of the retrieve; also storage warnings may have occurred.
Failure	xxxx	All failures	Retrieve is failed /Error logged

4.2.1.3.9. (Real-World) Activity – Print Management as SCU

4.2.1.3.9.1. Description and Sequencing of Activities

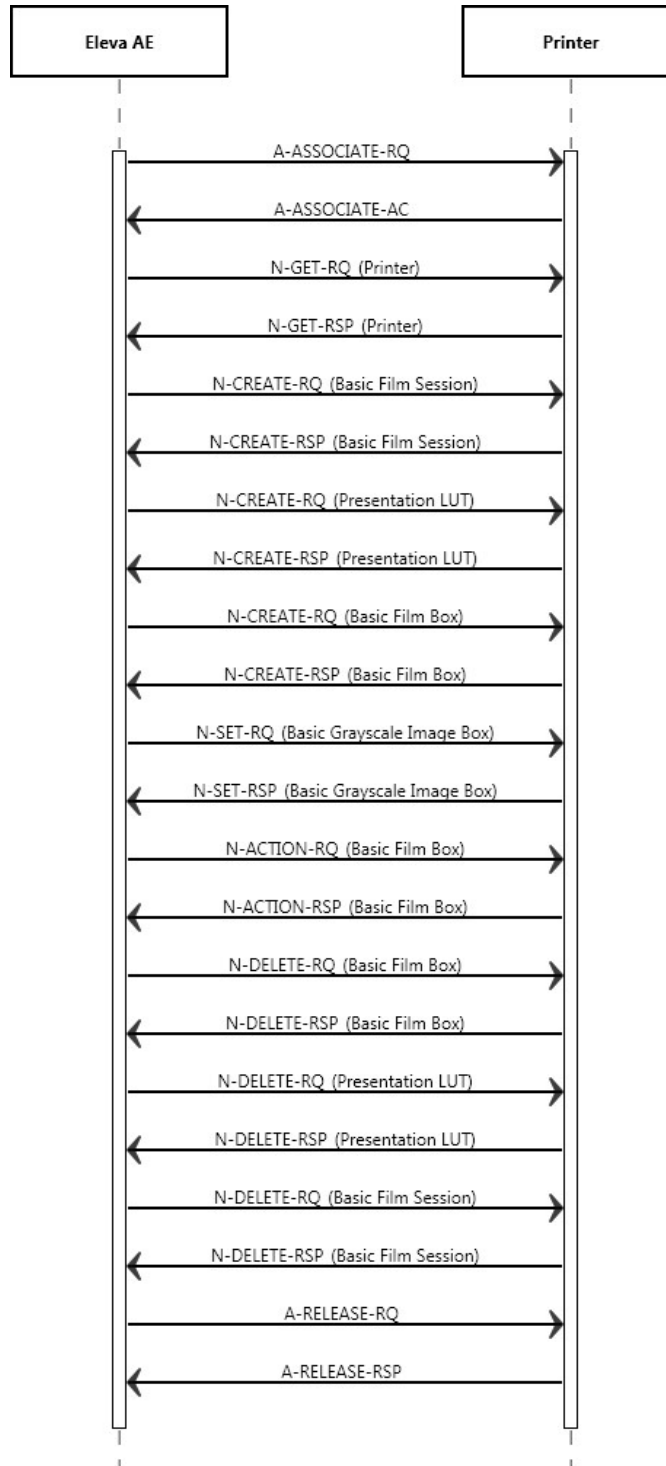

Figure 14: (Real World) Activity - Print Management as SCU

The Eleva AE cannot handle any N-EVENT-REPORT messages.

A print job (film session) comprises one single film box with one single image (that is composed of 1...N modality images).

© 2019 Koninklijke Philips N.V.

The print component in DigitalDiagnost R4.3 supports a highly automated print from acquisition operation mode, which does not interrupt the clinical acquisition workflow.

Supplementary to that is the manual print operation mode that is to be used as advanced interactive print preview and as reprint facility.

There shall be two modes of configuration for automatic printing: auto and auto print with user check.

In auto print mode conflicting and incomplete print jobs are either printed "as is" or must be manually corrected and confirmed.

In Auto print with user check mode all automatically started print jobs have to be confirmed manually.

The behavior of the print GUI on entry is dependent on the configuration not on the workflow context.

The three different print modes are:

- No auto print jobs active: Screen is empty.
- Auto print configured: All incomplete pages and conflict jobs are seen for that patient.
- Auto print with user check configured: All current print jobs are seen for that patient.

By Manual Printing the basic composition of films is possible with click and point functions.

By Auto Print the operation mode the handling of conflicts between configuration and operation is configurable. This means:

If the collimation and thus the image is larger as originally configured it can be configured if the image shall be cut, scaled or the print job with the conflict shall be manually corrected and confirmed.

If the operator omits one of the routine views configured and a page is thus left half-filled it can be configured if the page is going to be printed half-filled, if a layout suitable for the number of available images is chosen instead or if the page must be manually changed and confirmed.

In case of a manual check configured conflict jobs are sent to the print GUI and handled like the Auto print with user check.

Outstanding jobs are shown to the user by:

- An icon in the patient list at every affected patient / study
- User guidance giving patient name of unprinted film at the time the film ready to be printed

By Auto print with user check all print jobs are sent to the Print UI for checking first.

The user is not forced to go there, but outstanding jobs are shown to the user by:

- An icon in the patient list at every affected patient / study
- User guidance giving patient name of unprinted film at the time the film ready to be printed

Depending on the response status of set and the configuration the Eleva AE may perform a retry.

4.2.1.3.9.2. Proposed Presentation Contexts

The presentation contexts are defined in the next table.

Table 48: Proposed Presentation Contexts for (Real-World) Activity – Print Management As SCU

Presentation Context Table					
Abstract Syntax		Transfer Syntax		Role	Extended Negotiation
Name	UID	Name List	UID List		
Basic Grayscale Print Management Meta SOP Class	1.2.840.10008.5.1.1.9	Explicit VR Big Endian	1.2.840.10008.1.2.2	SCU	None
		Explicit VR Little Endian	1.2.840.10008.1.2.1		
		Implicit VR Little Endian	1.2.840.10008.1.2		
>Basic Film Box SOP Class	1.2.840.10008.5.1.1.2	Explicit VR Big Endian	1.2.840.10008.1.2.2	SCU	None
		Explicit VR Little Endian	1.2.840.10008.1.2.1		
		Implicit VR Little Endian	1.2.840.10008.1.2		
>Basic Film Session SOP Class	1.2.840.10008.5.1.1.1	Explicit VR Big Endian	1.2.840.10008.1.2.2	SCU	None
		Explicit VR Little Endian	1.2.840.10008.1.2.1		

Presentation Context Table					
Abstract Syntax		Transfer Syntax		Role	Extended Negotiation
Name	UID	Name List	UID List		
		Implicit VR Little Endian	1.2.840.10008.1.2		
>Basic Grayscale Image Box SOP Class	1.2.840.10008.5.1.1.4	Explicit VR Big Endian	1.2.840.10008.1.2.2	SCU	None
		Explicit VR Little Endian	1.2.840.10008.1.2.1		
		Implicit VR Little Endian	1.2.840.10008.1.2		
>Printer SOP Class	1.2.840.10008.5.1.1.16	Explicit VR Big Endian	1.2.840.10008.1.2.2	SCU	None
		Explicit VR Little Endian	1.2.840.10008.1.2.1		
		Implicit VR Little Endian	1.2.840.10008.1.2		

4.2.1.3.9.3. SOP Specific Conformance for Basic Film Box SOP Class of the Basic Grayscale Print Management Meta SOP Class

This section includes the SOP specific behavior, i.e. error codes, error and exception handling, time-outs, etc.

Behavior of an Application Entity SOP class is summarized as shown in next Table. The standard as well as the manufacturer specific status codes and their corresponding behavior are specified.

4.2.1.3.9.3.1. Dataset Specific Conformance for Basic Film Box SOP Class N-ACTION-SCU

Detail regarding the Dataset Specific response behavior will be reported in this section.

This part of the section includes the dataset specific behavior, i.e. error codes, error and exception handling, time-outs, etc.

Table 49: N-CREATE-RQ Dataset Specification

Attribute Name	Tag	VR	Value	Presence of Value	Source	Comment
SOP Class UID	0008,0016	UI		ALWAYS		
SOP Instance UID	0008,0018	UI		ALWAYS		
Image Display Format	2010,0010	ST		ALWAYS		
Film Orientation	2010,0040	CS		ALWAYS		
Film Size ID	2010,0050	CS		ALWAYS		
Magnification Type	2010,0060	CS		ALWAYS		
Max Density	2010,0130	US		ALWAYS		
Trim	2010,0140	CS		ANAP		
Configuration Information	2010,0150	ST		ALWAYS		
Referenced Film Session Sequence	2010,0500	SQ		ALWAYS		
>Referenced SOP Class UID	0008,1150	UI		ALWAYS		
>Referenced SOP Instance UID	0008,1155	UI		ALWAYS		

4.2.1.3.9.4. SOP Specific Conformance for Basic Film Session SOP Class of the Basic Grayscale Print Management Meta SOP Class

This section and sub-section include the manufacturer SOP and Dataset specific information as well the status codes and their corresponding behavior.

4.2.1.3.9.4.1. Dataset Specific Conformance for Basic Film Session SOP Class N-CREATE-SCU

Detail regarding the Dataset Specific response behavior will be reported in this section.

© 2019 Koninklijke Philips N.V.

This part of the section includes the dataset specific behavior, i.e. error codes, error and exception handling, time-outs, etc.

Table 50: N-CREATE-RQ Dataset Specification

Attribute Name	Tag	VR	Value	Presence of Value	Source	Comment
SOP Class UID	0008,0016	UI		ALWAYS		
SOP Instance UID	0008,0018	UI		ALWAYS		
Number of Copies	2000,0010	IS		ALWAYS		
Print Priority	2000,0020	CS		ALWAYS		
Medium Type	2000,0030	CS		ALWAYS		
Film Destination	2000,0040	CS		ALWAYS		
Film Session Label	2000,0050	LO		ANAP		

4.2.1.3.9.5. SOP Specific Conformance for Basic Grayscale Image Box SOP Class

4.2.1.3.9.5.1. Dataset Specific Conformance for Basic Grayscale Image Box SOP Class N-SET-SCU

Table 51 N-SET-RQ Dataset Specification.

Attribute Name	Tag	VR	Value	Presence of Value	Source	Comment
SOP Class UID	0008,0016	UI		ALWAYS		
SOP Instance UID	0008,0018	UI		ALWAYS		
Image Box Position	2020,0010	US		ALWAYS		
Polarity	2020,0020	CS		ALWAYS		
Basic Grayscale Image Sequence	2020,0110	SQ		ALWAYS		
>Samples Per Pixel	0028,0002	US		ALWAYS		
>Photometric Interpretation	0028,0004	CS		ALWAYS		
>Rows	0028,0010	US		ALWAYS		
>Columns	0028,0011	US		ALWAYS		
>Bits Allocated	0028,0100	US		ALWAYS		
>Bits Stored	0028,0101	US		ALWAYS		
>High Bit	0028,0102	US		ALWAYS		
>Pixel Representation	0028,0103	US		ALWAYS		
>Pixel Data	7FE0,0010	OW/OB		ALWAYS		

4.2.1.3.9.6. SOP Specific Conformance for Printer SOP Class of the Basic Grayscale Print Management Meta SOP Class

This section and sub-section include the manufacturer SOP and Dataset specific information as well the status codes and their corresponding behavior.

Table 52: DICOM Command Response Status Handling Behavior for Grayscale Print Management Meta Sop Class

Service Status	Code	Further Meaning	Behavior
Success	0000	Successful operation	The print job continues.
Failure	xxxx	Any failure	In the AutoPrint mode a GUI is invoked. The status panel of this GUI displays a message based on the 'Further Meaning'. The warning or failure response of a print request that is invoked by the Manual Print Composer GUI will be displayed by a pop-up window (if the user has not closed the GUI before the printer status was delivered).
Warning	xxxx	Any warning	In the AutoPrint mode a GUI is invoked. The status panel of this GUI displays a message based on the 'Further Meaning'. The warning or failure response of a print request that is invoked by the Manual Print Composer GUI will be displayed by a pop-up window (if the user has not closed the GUI before the printer status was delivered).

The behavior of the AE during communication failure is summarized next table.

Table 53: DICOM Command Communication Failure Behavior

Exception	Behavior
Timeout	The Association is aborted using A-ABORT and the command is marked as failed. The reason is logged. After a maximum number of retries the user is notified via pop-up (in preview mode only).
Association aborted	The command is marked as failed. The reason is logged. After a maximum number of retries the user is notified via pop-up (in preview mode only).
Failed to connect	Log entry. After a maximum number of retries the user is notified via pop-up (in preview mode only).

4.2.1.4. Association Acceptance Policy

The Application Entity may reject Association attempts as shown in the table below.

Table 54: Association Reject Reasons

Result	Source	Reason/Diagnosis	Behavior
1 - rejected permanent	1 - DICOM UL service-user	1 - no-reason-given	Association is not established. The following error is logged. Association rejected by peer (1: REJECT_RESULT _permanent, 1: REJECT_SOURCE_dul_user, 1: REJECT_REASON _no_reason_given)
		2 - application-context-name-not-supported	Association is not established. The following error is logged. Association rejected by peer (1: REJECT_RESULT _permanent, 1: REJECT_SOURCE_dul_user, 2: REJECT_REASON _application_context_not_support)
		3 - calling-AE-title-not-recognized	Association is not established. The following error is logged. Association rejected by peer (1: REJECT_RESULT _permanent, 1: REJECT_SOURCE_dul_user, 3: REJECT_REASON _calling_aetitle_not_recognized)
		7 - called-AE-title-not-recognized	Association is not established. The following error is logged. Association rejected by peer (1: REJECT_RESULT _permanent, 1: REJECT_SOURCE_dul_user, 7: REJECT_REASON _called_aetitle_not_recognized)

Result	Source	Reason/Diagnosis	Behavior	
	2 - DICOM UL service provider(ACSE related function)	1 - no-reason-given	Association is not established. The following error is logged. Error: UserRecoverable: impl.dicom.access.PEER: Association rejected by peer (1: REJECT_RESULT_permanent, 2: REJECT_SOURCE_dul_provider(acse), 1: REJECT_REASON_no_reason_given)	
		2 - protocol-version-not-supported	Association is not established. The following error is logged. Association rejected by peer (1: REJECT_RESULT_permanent, 2: REJECT_SOURCE_dul_provider(acse), 2: REJECT_REASON_protocol-version-not-supported)	
	3 - DICOM UL service provider (Presentation related function)	1 - temporary-congestion	Association is not established. The following error is logged. Association rejected by peer (1: REJECT_RESULT_permanent, 3: REJECT_SOURCE_dul_provider(presentation), 1: REJECT_REASON_temporary-congestion)	
		2 - local-limit-exceeded	Association is not established. The following error is logged. Association rejected by peer (1: REJECT_RESULT_permanent, 3: REJECT_SOURCE_dul_provider(presentation), 2: REJECT_REASON_local-limit-exceeded)	
	2 - rejected-transient	1 - DICOM UL service-user	1 - no-reason-given	Association is not established. The following error is logged. Association rejected by peer (2: REJECT_RESULT_transient, 1: REJECT_SOURCE_dul_user, 1: REJECT_REASON_no_reason_given)
			2 - application-context-name-not-supported	Association is not established. The following error is logged. Association rejected by peer (2: REJECT_RESULT_transient, 1: REJECT_SOURCE_dul_user, 2: REJECT_REASON_application_context_not_support)
3 - calling-AE-title-not-recognized			Association is not established. The following error is logged. Association rejected by peer (2: REJECT_RESULT_transient, 1: REJECT_SOURCE_dul_user, 3: REJECT_REASON_calling_aetitle_not_recognized)	
7 - called-AE-title-not-recognized			Association is not established. The following error is logged. Association rejected by peer (2: REJECT_RESULT_transient, 1: REJECT_SOURCE_dul_user, 7: REJECT_REASON_called_aetitle_not_recognized)	
2 - DICOM UL service provider (ACSE related function)		1 - no-reason-given	Association is not established. The following error is logged. Association rejected by peer (2: REJECT_RESULT_transient, 2: REJECT_SOURCE_dul_provider(acse), 1: REJECT_REASON_no_reason_given)	
		2 - protocol-version-not-supported	Association is not established. The following error is logged. Association rejected by peer (2: REJECT_RESULT_transient, 2: REJECT_SOURCE_dul_provider(acse), 2: REJECT_REASON_protocol-version-not-supported)	
3 - DICOM UL service provider (Presentation related function)		1 - temporary-congestion	Association is not established. The following error is logged. Association rejected by peer (2: REJECT_RESULT_transient, 3: REJECT_SOURCE_dul_provider(presentation), 1: REJECT_REASON_temporary-congestion)	

Result	Source	Reason/Diagnosis	Behavior
		2 - local-limit-exceeded	Association is not established. The following error is logged. Association rejected by peer (2: REJECT_RESULT_transient, 3: REJECT_SOURCE_dul_provider (presentation), 2: REJECT_REASON_application_context_not_support)

The behavior of the AE for sending an Association abort is summarized in next table.

Table 55: Association Abort Policies

Source	Reason/Diagnosis	Behavior
0 - DICOM UL service-user (initiated abort)	0 - reason-not-specified	When received, the Eleva Workspot terminates the connection with the following log: Association ABORTED by peer (0: ABORT_SOURCE_dul_user, 0: ABORT_REASON_not_specified).
2 - DICOM UL service-provider (initiated abort)	0 - reason-not-specified	When received, the Eleva Workspot terminates the connection with the following log: Association ABORTED by peer (2: ABORT_SOURCE_dul_provider, 0: ABORT_REASON_not_specified).
	1 - unrecognized-PDU	When received, the Eleva Workspot terminates the connection with the following log: Association ABORTED by peer (2: ABORT_SOURCE_dul_provider, 1: ABORT_REASON_unrecognized_pdu).
	2 - unexpected-PDU	When received, the Eleva Workspot terminates the connection with the following log: Association ABORTED by peer (2: ABORT_SOURCE_dul_provider, 2: ABORT_REASON_unexpected_pdu).
	4 - unrecognized-PDU parameter	When received, the Eleva Workspot terminates the connection with the following log: Association ABORTED by peer (2: ABORT_SOURCE_dul_provider, 4: ABORT_REASON_unrecognized_pdu_parameter).
	5 - unexpected-PDU parameter	When received, the Eleva Workspot terminates the connection with the following log: Association ABORTED by peer (2: ABORT_SOURCE_dul_provider, 5: ABORT_REASON_unexpected_pdu_parameter).
	6 - invalid-PDU-parameter value	When received, the Eleva Workspot terminates the connection with the following log: Association ABORTED by peer (2: ABORT_SOURCE_dul_provider, 6: ABORT_REASON_invalid_pdu_parameter).

4.2.1.4.1. (Real-World) Activity – Verification as SCP

4.2.1.4.1.1. Description and Sequencing of Activities

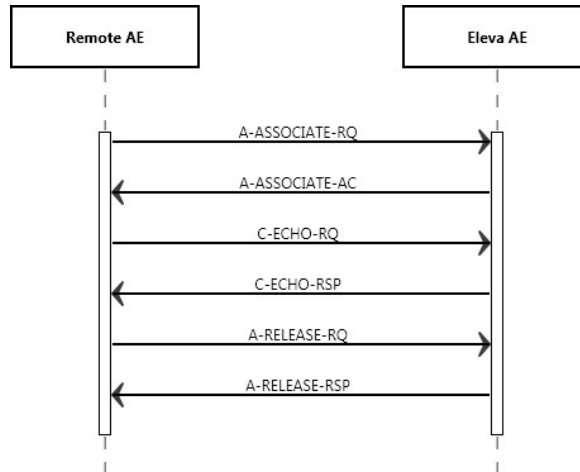

Figure 15: (Real World) Activity - Verification as SCP

4.2.1.4.1.2. Accepted Presentation Contexts

The presentation contexts are defined in the next table.

Table 56: Acceptable Presentation Contexts for (Real-World) Activity – Verification as SCP

Presentation Context Table					
Abstract Syntax		Transfer Syntax		Role	Extended Negotiation
Name	UID	Name List	UID List		
Verification SOP Class	1.2.840.10008.1.1	Explicit VR Big Endian	1.2.840.10008.1.2.2	SCP	None
		Explicit VR Little Endian	1.2.840.10008.1.2.1		
		Implicit VR Little Endian	1.2.840.10008.1.2		

4.2.1.4.1.3. SOP Specific Conformance for Verification SOP Class

This section includes the SOP specific behavior for the verification SOP Class, i.e. error codes, error and exception handling, time-outs, etc. This behavior is summarized in the tables below. The standard as well as the manufacturer specific status codes and their corresponding behavior are specified.

Table 57: Status Response

Service Status	Error Code	Further Meaning	Behavior
Success	0000	Verification is complete	The DigitalDiagnost R4.3 has successfully received the verification request

Table 58: DICOM Command Communication Failure Behavior

Exception	Behavior
Timeout	The Association is aborted using AP-ABORT and command marked as failed. The reason is logged and reported to the user.
Association aborted	The command is marked as failed. The reason is logged and reported to the user.

4.2.1.4.1.3.1.1. Dataset Specific Conformance for Verification SOP Class C-ECHO-SCP
Not Applicable

4.3. Network Interfaces

4.3.1. Physical Network Interfaces

The DigitalDiagnost R4.3 provides DICOM 3.0 TCP/IP Network Communication Support as defined in Part 8 of the DICOM 3.0 Standard. The DigitalDiagnost R4.3 system supports ISO 8802-3 10BASE-T and 100Base-TX and 1000Base-T Ethernet.

4.3.2. Additional Protocols

No additional protocols are used.

4.3.3. IPv4 and IPv6 Support

The DigitalDiagnost R4.3 supports both IPv4 and IPv6 networks communication.

4.4. Configuration

Any implementation's DICOM conformance may be dependent upon configuration, which takes place at the time of installation. Issues concerning configuration is addressed in this section.

4.4.1. AE Title/Presentation Address Mapping

An important installation issue is the translation from AE title to presentation address. How this is to be performed shall be described in this section.

4.4.1.1. Local AE Titles

The local AE title mapping and configuration are specified as:

Table 59 AE Title Configuration

Application Entity	Default AE Title	Default TCP/IP Port
ELEVA AE	ELEVA	3010

4.4.1.2. Remote AE Title/Presentation Address Mapping

All remote applications to be selected as destination (SCP) are configurable for the following items:

- The Application Entity Title of the remote application.

The Presentation Address of where the remote application should accept association requests.

4.4.2. Parameters

The specification of important operational parameters, their default value and range (if configurable) is specified here.

Table 60: Configuration Parameters table

Parameter	Configurable	Default Value
General Parameters		
Maximum PDU receive size	No	-
Maximum PDU send size	Yes	16384
Maximum number of simultaneous associations	Yes	3
ARTIM Timeout Specifies the time in seconds of the ARTIM (Association Request/Reject/Release Timer). Allowed values: 0: unlimited waiting time 0 < n: real time in seconds	Yes	20 [seconds]

Parameter	Configurable	Default Value
Automatic Association Timeout Specifies the association inactivity timeout in seconds after which the association is closed automatically. Allowed values: -1: immediate timeout 0: unlimited waiting time 0 < n: real time in seconds	Yes	0 [unlimited]
Transfer Syntax support: ILE, ELE, EBE	Yes	ILE, ELE, EBE
Storage Specific Parameters		
Automatic export to a configurable destination	Yes	-
Storage Commitment Specific Parameters		
Selection of 'Synchronous' or 'Asynchronous' Storage commitment.	Yes	Radio buttons to select the 'Synchronous' or 'Asynchronous' Storage commitment.
Synchronous Storage Commit Max Reply Waiting Time Specifies the time in seconds that is waited for a storage commitment event report message. After this time the association will be terminated	Yes	Allowed values: -1: immediate timeout 0: unlimited waiting time 0 < n: real time in seconds
Basic Worklist Management Specific Parameters		
RIS query timeout Specifies the time after which the query is automatically aborted Allowed values: 1- 300 seconds	Yes	240 [seconds]
Background broad query time interval Specifies the time until the background query will be repeated. Allowed values: 0: no broad query 0 < n: real time in minutes	Yes	0 [no broad query]
Print Management Specific Parameters		
Automatic print to a configurable destination	Yes	-

5. Media Interchange

5.1. Implementation model

The implementation model identifies the DICOM Application Entities for Media in specific implementation and relates the Application Entities to Real-World Activities.

5.1.1. Application Data Flow Diagram

The DigitalDiagnost R4.3 system consists of one single application entity only: the ELEVA Application Entity.

Next figure shows the Media Interchange application data flow as a functional overview of the Eleva AE.

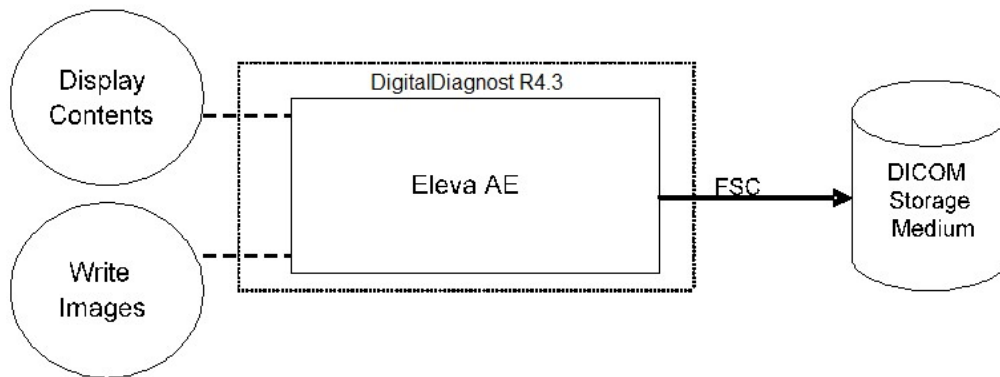

Figure 16: Media Interchange Application Data Flow Diagram

5.1.2. Functional Definitions of AE's

This section shall describe in general terms the functions to be performed by the AE, and the DICOM services used to accomplish these functions.

The ELEVA AE is the one and only application entity within the DigitalDiagnost R4.3. It includes the following service class.

Media Storage Service Class

The ELEVA AE can perform the Media Storage service as SCU, with capabilities for RWA Create File-Set (as FSC).

5.1.3. Sequencing of Real World Activities

Write images can be initiated by selecting a proper export destination, selecting requested images and clicking the export button.

Whenever a CD-R/DVD has to be written the ELEVA AE first tries to read the DICOMDIR. The ELEVA AE will compile the updated DICOMDIR and any required DICOM images into a CD/DVD session image; this CD/DVD session image will be written to CD-R/DVD.

5.2. AE Specifications

This section in the DICOM Conformance Statement specifies a set of Media Application Entities.

5.2.1. Media Storage Media – Specification

The Eleva AE provides Standard Conformance to the DICOM Media Storage Service and File Format ([DICOM] PS 3.10) and the Media Storage Application Profiles STD-GEN-CD ([DICOM] PS 3.11), STD-GEN-DVD-JPEG for creation and also the corresponding secure media profiles STD-GEN-SEC-CD and STD-GEN-SEC-DVD-JPEG.

The supported Application Profiles, their Roles and the Service Class (SC) options, all defined in DICOM terminology, are listed in next table.

Table 61: AE Media Storage related Application Profiles, Real-World Activities and Roles

Supported Application Profile	Identifier	Real-World Activities	Roles
General Purpose CD-R Interchange	STD-GEN-CD	Create File-set	FSC
General Purpose Secure CD-R Interchange	STD-GEN-SEC-CD	Create File-set	FSC
General Purpose DVD Interchange with JPEG	STD-GEN-DVD-JPEG	Create File-set	FSC
General Purpose Secure DVD Interchange with JPEG	STD-GEN-SEC-DVD-JPEG	Create File-set	FSC

5.2.1.1. File Meta Information for the Media Storage

In the file Meta information that pertains to the Application Entity the Source Application Entity Title is set to "PMS_ELEVA_41.0".

Table 62: Implementation Identifying Information

Property	Value
Implementation Class UID	1.3.46.670589.30.42.0
Implementation Version Name	PMS_ELEVA_42.0

5.2.1.2. Real World Activities

The AE specification contains a description of the Real-World Activities, which invoke the particular AE.

5.2.1.2.1. RWA - Create File-set

When an image transfer to CD-R is initiated then the Eleva AE acts as an FSC using the interchange option to export SOP Instances from the local database to a CD-R/DVD medium.

5.2.1.2.1.1. Media Storage Application Profile

The Eleva AE supports the RWA - Create File-SET for the STD-GEN-CD and STD-GEN-DVD-JPEG Application Profiles.

5.2.1.2.1.1.1. Options

The DICOMDIR file will be created on the CD-R/DVD medium when new images are written. In case some attributes are not present in an image but are specified as mandatory in the DICOMDIR definition in DICOM Media, a generated value will filled in.

The Eleva AE can write created image to media of the following listed SOP Classes

Table 63: AE related storage SOP Classes for Media

SOP Class Name	SOP Class UID
Computed Radiography Image Storage SOP Class	1.2.840.10008.5.1.4.1.1.1
Digital X-Ray Image Storage - Presentation SOP Class	1.2.840.10008.5.1.4.1.1.1.1
Digital X-Ray Image Storage - Processing SOP Class	1.2.840.10008.5.1.4.1.1.1.1.1
Secondary Capture Image Storage SOP Class	1.2.840.10008.5.1.4.1.1.7

The Eleva AE can write created image to media with the following listed Transfer Syntax.

Table 64: AE related storage SOP Classes for Media

Transfer Syntax	UID List
Explicit VR Little Endian	1.2.840.10008.1.2.1

The Eleva AE can write created image to media with the following listed Media Storage SOP Class.

Table 65: AE Media Store SOP Class

Media Storage SOP Class Name	Media Storage SOP Class UID
Media Storage Directory Storage	1.2.840.10008.1.3.10

It is possible to Store one single image first as a DICOM CR object and secondly as a DICOM DX object, therefore the "SOP Instance UIDs" and "Referenced SOP Instance UIDs" of both DICOM image instances have to be different.

The Numbering Scheme shall support 'Hanging Protocols' of PACS systems & Viewing Stations, in case of the CR as well as the DX model:

The Series Number starts with 1 for the first Series of every Study Instance, identified by Study Instance UID.

The "Series Number" increases by 1 for every new Series Instance within the same Study Instance, by the timely order, the Series Instances are created.

Every Stored image gets also a unique "Series Instance UID" and "Media Storage SOP Instance UID".

The Image Number starts with 1 for every new Series Instance.

The Image Number increases by 1 for every new Image Instance within the same Series Instance, by the timely order, the Images are created.

5.2.1.2.1.2. Media Storage Application Profile

Not applicable.

Table 66: Supported attributes in the DICOMDIR

DICOM Tag	Description
0002,0000	Meta Element Group Length
0002,0001	File Meta Information Version
0002,0002	Media Storage SOP Class UID
0002,0003	Media Storage SOP Instance UID
0002,0010	Transfer Syntax UID
0002,0012	Implementation Class UID
0002,0013	Implementation Version Name
File Set and Directory Information	
0004,1130	File Set ID
0004,1200	Offset Of The First Directory Record Of The Root Directory Entity
0004,1202	Offset Of The Last Directory Record Of The Root Directory Entity
0004,1212	File Set Consistency Flag
0004,1220	Directory Record Sequence
Patient Level	
0004,1400	Offset Of The Next Directory Record
0004,1410	Record In Use Flag
0004,1420	Offset Of Referenced Lower Level Directory Entity
0004,1430	Directory Record Type
0010,0010	Patients Name

DICOM Tag	Description
0010,0020	Patient ID
Study Level	
0004,1400	Offset Of The Next Directory Record
0004,1410	Record In Use Flag
0004,1420	Offset Of Referenced Lower Level Directory Entity
0004,1430	Directory Record Type
0008,0020	Study Date
0008,0030	Study Time
0008,0050	Accession Number
0008,1030	Study Description
0020,000d	Study Instance UID
0020,0010	Study ID
Series Level	
0004,1400	Offset Of The Next Directory Record
0004,1410	Record In Use Flag
0004,1420	Offset Of Referenced Lower Level Directory Entity
0004,1430	Directory Record Type
0008,0060	Modality
0008,103e	Series Description
0018,0015	Body Part Examined
0018,1030	Protocol Name
0020,000e	Series Instance UID
0020,0011	Series Number
Image Level	
0004,1400	Offset Of The Next Directory Record
0004,1410	Record In Use Flag
0004,1420	Offset Of Referenced Lower Level Directory Entity
0004,1430	Directory Record Type
0004,1500	Referenced File ID
0004,1510	Referenced SOP Class UID In File
0004,1511	Referenced SOP Instance UID In File
0004,1512	Referenced Transfer Syntax UID In File
0008,0008	Image Type
0008,0016	SOP Class UID
0008,0018	SOP Instance UID
0020,0013	Instance Number
0020,0052	Frame Of Reference UID
0028,0010	Rows
0028,0011	Columns
0028,0030	Pixel Spacing

5.3. Augmented and Private Application Profiles

Eleva does not support any augmented or private application profiles.

© 2019 Koninklijke Philips N.V.

5.4. Media Configuration

When creating a CD with anonymous patient data, the following attributes are changed.

Table 67: Anonymous patient data

Attribute	Tag	Change to
Media Storage SOP Instance UID	0002,0003	New UID
Referenced SOP Instance UID in File	0004,1511	New UID
SOP Instance UID	0008,0016	New UID
Accession Number	0008,0050	[empty]
Institution Name	0008,0080	[empty]
Institution Address	0008,0081	[empty]
Referring Physician's Name	0008,0090	[empty]
Station Name	0008,1010	[empty]
Study Description	0008,1030	[empty]
Series Description	0008,103E	[empty]
Institutional Department Name	0008,1040	[empty]
Performing Physician's Name	0008,1050	[empty]
Operators' Name	0008,1070	[empty]
Patient Name	0010,0010	[empty]
Patient ID	0010,0020	New ID
Patient's Birth Date	0010,0030	[empty]
Patient's Sex	0010,0040	[empty]
Other Patient IDs	0010,1000	[empty]
Patient's Size	0010,1020	[empty]
Patient's Weight	0010,1030	[empty]
Device Serial Number	0018,1000	New ID
Study Instance UID	0020,000D	New UID
Series Instance UID	0020,000E	New UID
Study ID	0020,0010	New ID
Requesting Physician	0032,1032	[empty]
Request Attributes Sequence	0040,0270	[empty sequence]
Requested Procedure ID	0040,1001	New ID

6. Support of Character Sets

Any support for character sets in Network and Media services is described here.

Table 68: Supported DICOM Character Sets

Character Set Description	Defined Term	ESC Sequence	ISO Registration Number	Code Element	Character Set
GB18030	GB18030	-	-	-	-
Latin alphabet No. 1	ISO_IR 100	-	ISO-IR 100	G1	Supplementary set of ISO 8859
		-	ISO-IR 6	G0	ISO 646
Latin alphabet No. 2	ISO_IR 101	-	ISO-IR 101	G1	Supplementary set of ISO 8859
		-	ISO-IR 6	G0	ISO 646

7. Security

7.1. Security Profiles

DigitalDiagnost R4.3 conforms to the Media Storage Security Profile and IHE ATNA Integration Profile.

DigitalDiagnost R4.3 allows the use of either a conventional (non-secure) DICOM communication or a secure DICOM communication based on the Transport Layer Security (TLS) protocol. If configured DigitalDiagnost R4.3 supports the following security measures:

- secure authentication of a node
- integrity and confidentiality of transmitted data
- confidentiality of data on DICOM Media
- generation of audit trail records access control and user authentication

7.1.1. Security use Profiles

Not applicable

7.1.2. Security Transport Connection Profiles

DigitalDiagnost R4.3 conforms to the Basic TLS Secure Transport Connection Profile.

DigitalDiagnost R4.3 initiates TLS Connections and accepts TLS Connections with Storage Commitment. TLS ports are configurable.

DigitalDiagnost R4.3 provides a service accessible tool to configure private keys and certificates of the local and remote DICOM nodes.

Secure communication is a "mode of operation" of DigitalDiagnost R4.3 supported by the implementation of the DICOM Basic TLS Secure Transport Connection Profile. This functionality will be used by the nodes that can authenticate each other before they exchange DICOM information. For secure communication the TLS protocol v1.2 is used which provides message authentication, integrity, and confidentiality. Confidentiality is optional and can be controlled by the encryption settings.

DigitalDiagnost R4.3 may communicate using the following Cipher Suites:

TLS_RSA_WITH_NULL_SHA (Node authentication without encryption)

TLS_RSA_WITH_AES_128_CBC_SHA (Node authentication with encryption)

TLS_RSA_WITH_3DES_EDE_CBC_SHA

DigitalDiagnost R4.3 supports X.509 certificates. The following TLS Certification checks will be done (TLS Handshake). The machine (either server or client) that will send its certificate will:

Choose the certificate according to Common Name (CN) value in the Subject-field. This name is case-sensitive. All present certificates should have unique CN names.

The server verifies that

- The client certificate is a X.509 certificate which is valid.
- The Client Authentication (CA) of the client certificate is in the list of trusted certificates.
- The client certificate is not expired (present time is between "Valid From" and "Valid To" fields of the X.509 certificate)
- The client certificate has the correct purpose (at least the Client Authentication purpose), If the purpose is specified.

The client verifies that

- The server certificate is a X.509 certificate which valid.
- The Client Authentication (CA) of the client certificate is in the list of trusted certificates.
- The server certificate is not expired (present time is between "Valid From" and "Valid To" fields of the X.509 certificate)
- The server certificate has the correct purpose (at least Server Authentication purpose), If the purpose is specified.

No verification is done on:

- Revocation of certificates
- Limiting the connection to a limited set of IP-addresses

Node authentication with or without encryption is only possible when both nodes have:

- An access to their own private keys
- An access to a copy of the certificate of the other node containing its public key

Figure below presents the message flow of TLS handshake supported by DigitalDiagnost R4.3.

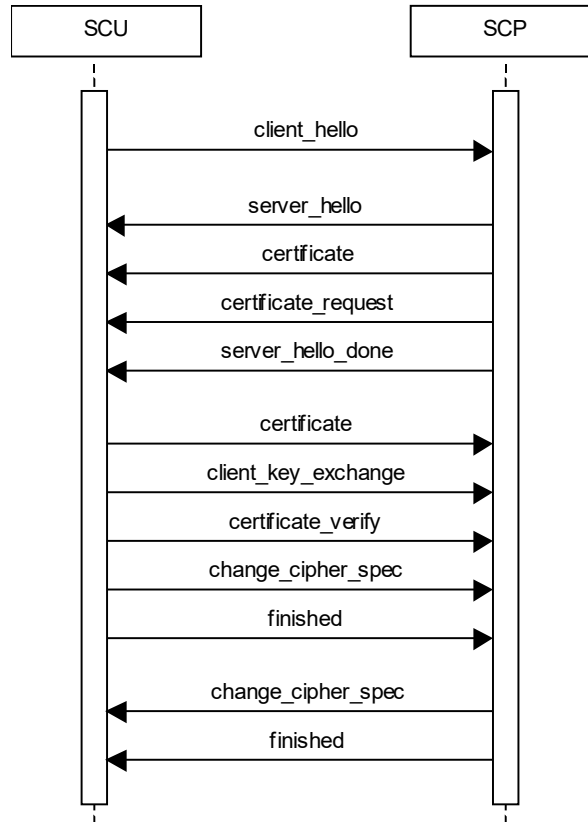

Figure 17: Message flow of TLS handshake

7.1.3. Digital Signature Profiles

Not applicable

7.1.4. Media Storage Security Profiles

DigitalDiagnost R4.3 conforms to the Basic DICOM Media Security Profile. DigitalDiagnost R4.3 use AES or Triple-DES for content encryption. DigitalDiagnost R4.3 uses password-based encryption for key transport of content encryption keys. The password is auto generated by application while the user has an option to change the same. The method used to exchange the password is beyond the control of the application.

7.1.5. Attribute Confidentiality Profiles

DigitalDiagnost R4.3 conforms to the Basic Application Level Confidentiality Profile as de-identifier. De-identified SOP Instances will be created on DICOM Media if specified by the user.

No instances of the Encrypted Attributes Data Set are created. No Transfer Syntaxes are supported for encoding/decoding of Encrypted Attributes Data Sets.

empty: The attribute will have a value of zero length.

n. a.: Not applicable, the attribute is not contained in the standard IOD of DigitalDiagnost R4.3

anon string: The original value is mapped onto a string with a length of max 12 characters UID using the procedure described below.

anon UID: The original value is mapped onto a syntactically valid DICOM UID using the procedure described below.

The above mentioned mapping procedure works as follows:

- The original value is taken as a string of arbitrary length.
- This string is mapped onto a 16-byte value using MD5 hash.
- From this value only the first 8 bytes are used further.
 - To create an anon string these first 8 bytes are mapped onto a 12 characters long string using base 64.
 - To create an anon UID the 8 bytes are read as two integers which are used together with the Implementation Class UID and the device serial number to create a valid DICOM UID: (ImplClassUID).(DevSerialNu).2.Integer(byte[0-3]).Integer(byte[4-7])

MD5 hash makes practically sure that different strings are mapped to different 16-byte values. So the whole procedure ensures that the relationship between SOP Instances by the means of their UIDs remains consistent.

Table 69: Anonymous attributes supported by DigitalDiagnost R4.3

Attribute Name	Tag	Replacement Value
Instance Creator UID	0008,0014	anon UID
SOP Instance UID	0008,0018	anon UID
Accession Number	0008,0050	empty
Institution Name	0008,0080	empty
Institution Address	0008,0081	empty
Referring Physician's Name	0008,0090	empty
Station Name	0008,1010	empty
Study Description	0008,1030	empty
Series Description	0008,103E	empty
Institutional Department Name	0008,1040	empty
Physician(s) of Record	0008,1048	empty
Performing Physicians' Name	0008,1050	empty
Name of Physician(s) Reading Study	0008,1060	empty
Operators' Name	0008,1070	empty
Admitting Diagnoses Description	0008,1080	empty
Referenced SOP Instance UID	0008,1155	anon UID
Derivation Description	0008,2111	empty
Patient's Name	0010,0010	empty
Patient ID	0010,0020	anon ID
Patient's Birth Date	0010,0030	empty
Patient's Birth Time	0010,0032	empty
Patient's Sex	0010,0040	empty
Other Patient Ids	0010,1000	empty
Other Patient Names	0010,1001	empty
Patient's Age	0010,1010	empty
Patient's Size	0010,1020	empty
Patient's Weight	0010,1030	empty
Ethnic Group	0010,2160	empty
Occupation	0010,2180	empty
Additional Patient's History	0010,21B0	empty

Attribute Name	Tag	Replacement Value
Patient Comments	0010,4000	empty
Device Serial Number	0018,1000	anon string
Protocol Name	0018,1030	empty
Study Instance UID	0020,000D	anon UID
Series Instance UID	0020,000E	anon UID
Study ID	0020,0010	anon string
Frame of Reference UID	0020,0052	anon UID
Image Comments	0020,4000	empty
Requesting Physician	0032,1032	empty
Requested Attributes Sequence	0040,0275	empty Sequence
Requested Procedure ID	0040,1001	anon ID
UID	0040,A124	anon UID
Content Sequence	0040,A730	empty
Storage Media File-set UID	0088,0140	anon UID

No attributes or attribute values are inserted.

7.1.6. Network Address Management Profiles

Not applicable

7.1.7. Time Synchronization Profiles

DigitalDiagnost R4.3 conforms to the Basic Time Synchronization Profile as NTP Client.

DigitalDiagnost R4.3 does support secure transactions.

7.1.8. Application Configuration Management Profiles

Not applicable

7.1.9. Audit Trail Profiles

DigitalDiagnost R4.3 creates audit messages according to the IHE ATNA Integration Profile. These messages may contain information that identifies the patient. The following messages will be created and sent to a central Audit Record Repository:

- Application Activity (when DigitalDiagnost R4.3 starts or shuts down).
- Begin Transferring DICOM Instances (when an examination is being transferred from the DigitalDiagnost R4.3 to a remote network node).
- DICOM Instances Transferred (when an examination is transferred from the DigitalDiagnost R4.3 to a remote network node).
- DICOM Instances Accessed (Study is created, modified, accessed, or deleted).
- Node-Authentication-failure (node needs to report a security alert, e.g., a node authentication failure when establishing a secure communications channel)
- User Authentication (when the user logs in or logs out).
- SecurityAlert (when an authentication of a secure node during TLS negotiation fails, e.g. due to an invalid certificate and configuration and other changes).
- Export (when printing job is started or export on media e.g CD, DVD).
- DICOM Study Deleted (If SOP Instances are deleted from a specific study. One event covers all instances deleted for the particular study).
- Actor-Config (security related event caused by database changes)

7.2. Association Level Security

Not applicable

7.3. Application Level Security

DigitalDiagnost R4.3 does not support any specific application level security measures.

- The Application which gives access to Patient records and DICOM communication requires Login with Username and Password.
- The system is used within a secured environment. It is assumed that a secured environment includes at a minimum.
- The OS is solidified by white-listing applications and files. Not white-listed executable files, libraries, drivers, Java apps, ActiveX controls, scripts, and other code are blocked.
- Firewall or router protections to ensure that only approved external hosts have network access to DigitalDiagnost R4.3
- Firewall or router protections to ensure that DigitalDiagnost R4.3 only has network access to approved external hosts and services.
- Any communication with external hosts outside the locally secured environment can be configured to use secure network channels.

Other network security procedures such as automated intrusion detection may be appropriate in some environments.

Additional security features may be established by the local security policy and are beyond the scope of this conformance statement.

8. Eleva

8.1. IOD Contents

8.1.1. Created SOP Instances

This section specifies each IOD created by this application and specifies the content for each IOD created (including private IODs).

For each attribute in the IOD the following information is supplied:

- Attribute name
- Tag
- VR – Value representation
- Value - specifies possible values

Presence of value - specifies if attribute is always present or only under specific conditions

- Source of value - specifies the source of the value
- Comment - gives additional information on the attribute

Abbreviations used in the IOD tables for the column "Presence of Module" are:

- ALWAYS The module is always present.
- CONDITIONAL The module is used under specified condition.

Abbreviations used in the Module table for the column "Presence of Value" are:

- ALWAYS The attribute is always present with a value.
- EMPTY The attribute is always present without any value. (attribute sent zero length)
- VNAP The attribute is always present and its Value is Not Always Present. (attribute sent zero length if no value is present)
- ANAP The attribute is present under specified condition – if present then it will always have a value.

The abbreviations used in the Module table for the column "Source" are:

- AUTO The attribute value is generated automatically.
- CONFIG The attribute value source is a configurable parameter.
- COPY The attribute value source is another SOP instance.
- FIXED The attribute value is hard-coded in the application.
- IMPLICIT The attribute value source is a user-implicit setting.
- MPPS The attribute value is the same as that use for Modality Performed Procedure Step.
- MWL The attribute value source is a Modality Worklist.
- USER The attribute value source is explicit user input.

Table 70: List of Created SOP Classes

SOP Class Name	SOP Class UID
Computed Radiography Image Storage SOP Class	1.2.840.10008.5.1.4.1.1.1
Digital X-Ray Image Storage - For Presentation. SOP	1.2.840.10008.5.1.4.1.1.1.1
Digital X-Ray Image Storage - For Processing. SOP	1.2.840.10008.5.1.4.1.1.1.1.1
X-Ray Radiation Dose SR	1.2.840.10008.5.1.4.1.1.88.67
Secondary Capture Image Storage SOP Class	1.2.840.10008.5.1.4.1.1.7

8.1.1.1. Computed Radiography Image Storage SOP Class

Table 71: SOP Class Modules

Information Entity	Module	Presence
Patient	Patient Module	Always
Study	General Study Module	Always
	Patient Study Module	Always

Series	General Series Module	Always
	CR Series Module	Always
Equipment	General Equipment Module	Always
Image	General Image Module	Always
	Image Pixel Module	Always
	Display Shutter Module	Always
	CR Image Module	Always
	Overlay Plane	Conditional Note: Present when there are annotations or measurements (including labels, markers and electronic shutters) are added to the image
	Modality LUT Module	Always
	VOI LUT Module	Always
	SOP Common Module	Always

Table 72: Patient Module

Attribute Name	Tag	VR	Value	Presence of Value	Source	Comment
Patient's Name	0010,0010	PN		VNAP	MWL,USER	
Patient ID	0010,0020	LO		VNAP	MWL,AUTO	
Issuer of Patient ID	0010,0021	LO		ANAP	MWL,USER	
Patient's Birth Date	0010,0030	DA		VNAP	MWL,USER	
Patient's Sex	0010,0040	CS	F, M, O	VNAP	MWL,USER	
Other Patient IDs	0010,1000	LO		ANAP	MWL,USER	
Ethnic Group	0010,2160	SH		ANAP	MWL,USER	
Patient Comments	0010,4000	LT		ANAP	AUTO	

Table 73: General Study Module

Attribute Name	Tag	VR	Value	Presence of Value	Source	Comment
Study Instance UID	0020,000D	UI		ALWAYS	AUTO	
Study Date	0008,0020	DA		VNAP	AUTO	
Study Time	0008,0030	TM		VNAP	AUTO	
Accession Number	0008,0050	SH		VNAP	MWL, USER	
Referring Physician's Name	0008,0090	PN		VNAP	MWL	
Study ID	0020,0010	SH		VNAP	MWL	
Study Description	0008,1030	LO		ANAPCV	AUTO/ MWL	
Referenced Study Sequence	0008,1110	SQ		ANAP	MWL	
>Referenced SOP Class UID	0008,1150	UI		ANAPEV	MWL	
>Referenced SOP Instance UID	0008,1155	UI		ANAPEV	MWL	
Procedure Code Sequence	0008,1032	SQ		ANAP	MWL	
>Code Value	0008,0100	SH		ALWAYS	MWL	
>Coding Scheme Designator	0008,0102	SH		ALWAYS	MWL	
>Code Meaning	0008,0104	LO		ALWAYS	MWL	

Table 74: Patient Study Module

Attribute Name	Tag	VR	Value	Presence of Value	Source	Comment
Patient's Size	0010,1020	DS		ANAP	MWL, USER	
Patient's Age	0010,0010	AS		ANAP	MWL, USER	
Patient's Weight	0010,1030	DS		VNAP	MWL, USER	
Medical Alerts	0010,2000	LO		ANAP	MWL, USER	
Allergies	0010,2110	LO		ANAP	MWL, USER	
Occupation	0010,2180	SH		ANAP	MWL, USER	
Additional Patient History	0010,21B0	LT		ANAP	MWL, USER	
Pregnancy Status	0010,21C0	US		ANAP	MWL, USER	

Table 75: General Series Module

Attribute Name	Tag	VR	Value	Presence of Value	Source	Comment
Series Date	0008,0021	DA		ANAP	AUTO	
Series Time	0008,0031	TM		ANAP	AUTO	
Modality	0008,0060	CS	CR	ALWAYS	CONFIG	
Series Description	0008,103 ^E	LO		ANAP	MPPS,USER	
Performing Physicians' Name	0008,1050	PN		ANAP	MPPS,USER	
Operators' Name	0008,1070	PN		ANAP	MPPS,USER	
Referenced Performed Procedure Step Sequence	0008,1111	SQ		ANAP	AUTO	
>Referenced SOP Class UID	0008,1150	UI		ALWAYS	AUTO	
>Referenced SOP Instance UID	0008,1155	UI		ALWAYS	AUTO	
Body Part Examined	0018,0015	CS		ANAP	MPPS,USER	
Protocol Name	0018,1030	LO		ANAP	MWL,USER	
Series Instance UID	0020,000E	UI		ALWAYS	MPPS,AUTO	
Series Number	0020,0011	IS		VNAP	MPPS,AUTO	
Laterality	0020,0060	CS		ANAP	CONFIG	
Performed Procedure Step Start Date	0040,0244	DA		ANAP	MPPS,AUTO	
Performed Procedure Step Start Time	0040,0245	TM		ANAP	MPPS,AUTO	
Performed Procedure Step ID	0040,0253	SH		ANAP	MPPS,AUTO	
Performed Procedure Step Description	0040,0254	LO		ANAP	MPPS,AUTO	

Table 76: CR Series Module

Attribute Name	Tag	VR	Value	Presence of Value	Source	Comment
Body Part Examined	0018,0015	CS		VNAP	MPPS,USER	
View Position	0018,5101	CS		VNAP	AUTO	

Table 77: General Equipment Module

Attribute Name	Tag	VR	Value	Presence of Value	Source	Comment
Manufacturer	0008,0070	LO	Philips	ALWAYS	AUTO	
Institution Name	0008,0080	LO		ANAP	CONFIG	
Institution Address	0008,0081	ST		ANAP	CONFIG	

Station Name	0008,1010	SH		ANAP	CONFIG	
Institutional Department Name	0008,1040	LO		ANAP	CONFIG	
Manufacturer's Model Name	0008,1090	LO	DigitalDiagnost R4.3	ANAP	AUTO	
Device Serial Number	0018,1000	LO		ANAP	CONFIG	
Software Versions	0018,1020	LO		ANAP	AUTO	
Spatial Resolution	0018,1050	DS		ANAP	AUTO	

Table 78: General Image Module

Attribute Name	Tag	VR	Value	Presence of Value	Source	Comment
Image Type	0008,0008	CS	ORIGINAL, PRIMARY	ANAP	AUTO	
Acquisition Date	0008,0022	DA		ANAP	AUTO	
Content Date	0008,0023	DA		ANAP	AUTO	
Acquisition Time	0008,0032	TM		ANAP	AUTO	
Content Time	0008,0033	TM		ANAP	AUTO	
Irradiation Event UID	0008,3010	UI		ANAP	AUTO	
Instance Number	0020,0013	IS		VNAP	AUTO	
Patient Orientation	0020,0020	CS		ANAP	USER	
Quality Control Image	0028,0300	CS		ANAP	AUTO	
Burned In Annotation	0028,0301	CS		ANAP	AUTO	
Lossy Image Compression	0028,2110	CS	00	ANAP	AUTO	
Presentation LUT Shape	2050,0020	CS	IDENTITY	ANAP	AUTO	

Table 79: Image Pixel Module

Attribute Name	Tag	VR	Value	Presence of Value	Source	Comment
Samples per Pixel	0028,0002	US		ALWAYS	AUTO	
Photometric Interpretation	0028,0004	CS	MONOCHROME2	ALWAYS	AUTO	
Rows	0028,0010	US		ALWAYS	AUTO	
Columns	0028,0011	US		ALWAYS	AUTO	
Bits Allocated	0028,0100	US	16	ALWAYS	AUTO	
Bits Stored	0028,0101	US	15	ALWAYS	AUTO	
High Bit	0028,0102	US	14	ALWAYS	AUTO	
Pixel Representation	0028,0103	US	0	ALWAYS	AUTO	
Pixel Data	7FE0,0010	OW/OB		ANAP	AUTO	

Table 80: Display Shutter Module

Attribute Name	Tag	VR	Value	Presence of Value	Source	Comment
Shutter Shape	0018,1600	CS		ALWAYS	AUTO	
Vertices of the Polygonal Shutter	0018,1620	IS		ANAP	AUTO	

Table 81: CR Image Module

Attribute Name	Tag	VR	Value	Presence of Value	Source	Comment
----------------	-----	----	-------	-------------------	--------	---------

KVP	0018,0060	DS		ANAP	AUTO	
Distance Source to Detector	0018,1110	DS		ANAP	AUTO	
Distance Source to Patient	0018,1111	DS		ANAP	AUTO	
Exposure Time	0018,1150	IS		ANAP	AUTO	
Exposure	0018,1152	IS		ANAP	AUTO	
Exposure in μ As	0018,1153	IS		ANAP	AUTO	
Imager Pixel Spacing	0018,1164	DS		ANAP	AUTO	
Acquisition Device Processing Description	0018,1400	LO		ANAP	AUTO	
Relative X-Ray Exposure	0018,1405	IS		ANAP	AUTO	
Photometric Interpretation	0028,0004	CS	MONOCHROME2	ALWAYS	AUTO	
Pixel Spacing	0028,0030	DS		ANAP	AUTO	

Table 82: Overlay Plane Module

Attribute Name	Tag	VR	Value	Presence of Value	Source	Comment
Overlay Rows	6000,0010	US		ALWAYS	AUTO	
Overlay Columns	6000,0011	US		ALWAYS	AUTO	
Overlay Type	6000,0040	CS		ALWAYS	AUTO	
Overlay Origin	6000,0050	SS		ALWAYS	AUTO	
Overlay Bits Allocated	6000,0100	US		ALWAYS	AUTO	
Overlay Bit Position	6000,0102	US		ALWAYS	AUTO	
Overlay Data	6000,3000	OW		ALWAYS	AUTO	

Table 83: Modality LUT Module

Attribute Name	Tag	VR	Value	Presence of Value	Source	Comment
Rescale Intercept	0028,1052	DS		ANAP	AUTO	
Rescale Slope	0028,1053	DS		ANAP	AUTO	
Rescale Type	0028,1054	LO		ANAP	AUTO	

Table 84: VOI LUT Module

Attribute Name	Tag	VR	Value	Presence of Value	Source	Comment
Window Center	0028,1050	DS		ANAP	AUTO	
Window Width	0028,1051	DS		ANAP	AUTO	
VOI LUT Function	0028,1056	CS		ANAP	AUTO	

Table 85: SOP Common Module

Attribute Name	Tag	VR	Value	Presence of Value	Source	Comment
SOP Class UID	0008,0016	UI		ALWAYS	AUTO	
SOP Instance UID	0008,0018	UI		ALWAYS	AUTO	
Instance Number	0020,0013	IS		ANAP	AUTO	

8.1.1.2. Digital X-Ray Image Storage - For Pres. SOP

Table 86: SOP Class Modules

Information Entity	Module	Presence
Patient	Patient Module	Always
Study	General Study Module	Always
	Patient Study Module	Conditional Note: Present when RIS send these attributes
Series	General Series Module	Always
	DX Series Module	Always
Frame of Reference	Frame Of Reference Module	Always
Equipment	General Equipment Module	Always
Image	General Image Module	Always
	Image Pixel Module	Always
	DX Anatomy Imaged Module	Always
	DX Image Module	Always
	DX Detector Module	Always
	X-Ray Collimator	Always
	DX Positioning Module	Always
	X-Ray Acquisition Dose Module	Always
	X-Ray Generation Module	Always
	X-Ray Grid Module	Conditional Note: Grid tag is not sent if the status is not known (e.g. portable detector in bucky trace)
	Overlay Plane	Conditional Note: Present when there are annotations or measurements (including labels, markers and electronic shutters) are added to the image
	Acquisition Context Module	Always
	SOP Common Module	Always

Table 87: Patient Module

Attribute Name	Tag	VR	Value	Presence of Value	Source	Comment
Patient's Name	0010,0010	PN		VNAP	MWL, USER	
Patient ID	0010,0020	LO		VNAP	MWL, AUTO	
Issuer of Patient ID	0010,0021	LO		ANAP	MWL, USER	
Patient's Birth Date	0010,0030	DA		VNAP	MWL, USER	
Patient's Sex	0010,0040	CS		VNAP	MWL, USER	
Other Patient Ids	0010,1000	LO		ANAP	MWL, USER	
Patient Comments	0010,4000	LT		ANAP	AUTO	
Ethnic Group	0010,2160	SH		ANAP	MWL, USER	

Table 88: General Study Module

Attribute Name	Tag	VR	Value	Presence of Value	Source	Comment
Study Date	0008,0020	DA		VNAP	AUTO	
Study Time	0008,0030	TM		VNAP	AUTO	
Accession Number	0008,0050	SH		VNAP	MWL, USER	
Referring Physician's Name	0008,0090	PN		VNAP	MWL, USER	
Study Description	0008,1030	LO		ANAP	MWL, USER	
Study Instance UID	0020,000D	UI		ALWAYS	AUTO	
Study ID	0020,0010	SH		VNAP	AUTO	

Table 89: Patient Study Module

Attribute Name	Tag	VR	Value	Presence of Value	Source	Comment
Patient's Age	0010,1010	AS		ANAP	MWL, USER	
Patient's Size	0010,1020	DS		ANAP	MWL, USER	
Patient's Weight	0010,1030	DS		ANAP	MWL, USER,	
Additional Patient History	0010,21B0	LT		ANAP	MWL, USER	

Table 90: General Series Module

Attribute Name	Tag	VR	Value	Presence of Value	Source	Comment
Series Date	0008,0021	DA		ANAP	AUTO	
Series Time	0008,0031	TM		ANAP	AUTO	
Modality	0008,0060	CS	CR	ALWAYS	CONFIG	
Series Description	0008,103 ^E	LO		ANAP	MWL, USER	
Performing Physicians' Name	0008,1050	PN		ANAP	MWL, USER	
Operators' Name	0008,1070	PN		ANAP	MWL, USER	
Referenced Performed Procedure Step Sequence	0008,1111	SQ		ANAP	AUTO	
>Referenced SOP Class UID	0008,1150	UI		ALWAYS	AUTO	
>Referenced SOP Instance UID	0008,1155	UI		ALWAYS	AUTO	
Body Part Examined	0018,0015	CS		ANAP	MWL, USER	
Protocol Name	0018,1030	LO		ANAP	AUTO	
Series Instance UID	0020,000E	UI		ALWAYS	AUTO	
Series Number	0020,0011	IS		VNAP	AUTO	
Laterality	0020,0060	CS		ANAP	CONFIG	
Performed Procedure Step Start Date	0040,0244	DA		ANAP	AUTO	

Performed Procedure Step Start Time	0040,0245	TM		ANAP	AUTO	
Performed Procedure Step ID	0040,0253	SH		ANAP	AUTO	
Performed Procedure Step Description	0040,0254	LO		ANAP	AUTO	

Table 91: DX Series Module

Attribute Name	Tag	VR	Value	Presence of Value	Source	Comment
Modality	0008,0060	CS	DX	ALWAYS	CONFIG	
Presentation Intent Type	0008,0068	CS	FOR PRESENTATION	ALWAYS	AUTO	
Referenced Performed Procedure Step Sequence	0008,1111	SQ		ANAP	AUTO	
>Referenced SOP Class UID	0008,1150	UI		ALWAYS	AUTO	
>Referenced SOP Instance UID	0008,1155	UI		ALWAYS	AUTO	

Table 92: Frame Of Reference Module

Attribute Name	Tag	VR	Value	Presence of Value	Source	Comment
Frame of Reference UID	0020,0052	UI		ALWAYS	AUTO	
Position Reference Indicator	0020,1040	LO		VNAP	AUTO	

Table 93: General Equipment Module

Attribute Name	Tag	VR	Value	Presence of Value	Source	Comment
Manufacturer	0008,0070	LO	Philips	VNAP	AUTO	
Institution Name	0008,0080	LO		ANAP	AUTO	
Institution Address	0008,0081	ST		ANAP	AUTO	
Station Name	0008,1010	SH		ANAP	AUTO	
Institutional Department Name	0008,1040	LO		ANAP	AUTO	
Manufacturer's Model Name	0008,1090	LO	DigitalDiagnost R4.3	ANAP	AUTO	
Device Serial Number	0018,1000	LO		ANAP	AUTO	
Software Versions	0018,1020	LO		ANAP	AUTO	
Spatial Resolution	0018,1050	DS		ANAP	AUTO	

Table 94: General Image Module

Attribute Name	Tag	VR	Value	Presence of Value	Source	Comment
Image Type	0008,0008	CS		ANAP	AUTO	
Acquisition Date	0008,0022	DA		ANAP	AUTO	
Content Date	0008,0023	DA		VNAP	AUTO	
Acquisition Time	0008,0032	TM		ANAP	AUTO	
Content Time	0008,0033	TM		VNAP	AUTO	
Irradiation Event UID	0008,3010	UI		ANAP	AUTO	
Instance Number	0020,0013	IS		VNAP	AUTO	
Patient Orientation	0020,0020	CS		ANAP	AUTO	
Quality Control Image	0028,0300	CS		ANAP	AUTO	
Burned In Annotation	0028,0301	CS		ANAP	AUTO	

Lossy Image Compression	0028,2110	CS		ANAP	AUTO	
Presentation LUT Shape	2050,0020	CS		ANAP	AUTO	

Table 95: Image Pixel Module

Attribute Name	Tag	VR	Value	Presence of Value	Source	Comment
Samples per Pixel	0028,0002	US		ALWAYS	AUTO	
Photometric Interpretation	0028,0004	CS		ALWAYS	AUTO	
Rows	0028,0010	US		ALWAYS	AUTO	
Columns	0028,0011	US		ALWAYS	AUTO	
Bits Allocated	0028,0100	US		ALWAYS	AUTO	
Bits Stored	0028,0101	US		ALWAYS	AUTO	
High Bit	0028,0102	US		ALWAYS	AUTO	
Pixel Representation	0028,0103	US		ALWAYS	AUTO	
Pixel Data	7FE0,0010	OW/OB		ANAP	AUTO	

Table 96: DX Anatomy Imaged Module

Attribute Name	Tag	VR	Value	Presence of Value	Source	Comment
Anatomic Region Sequence	0008,2218	SQ		VNAP	AUTO	
Image Laterality	0020,0062	CS		ALWAYS	CONFIG	

Table 97: DX Image Module

Attribute Name	Tag	VR	Value	Presence of Value	Source	Comment
Image Type	0008,0008	CS	ORIGINAL, PRIMARY	ALWAYS	AUTO	
Acquisition Device Processing Description	0018,1400	LO		ANAP	AUTO	
Patient Orientation	0020,0020	CS		ANAP	AUTO	
Samples per Pixel	0028,0002	US	1	ALWAYS	AUTO	
Photometric Interpretation	0028,0004	CS	MONOCHROME2	ALWAYS	AUTO	
Bits Allocated	0028,0100	US	16	ALWAYS	AUTO	
Bits Stored	0028,0101	US	15, 12, 10	ALWAYS	CONFIG	When Parameter "Increase virtual depth for PACS" is enabled values are : 16,13,11
High Bit	0028,0102	US	14, 11, 9	ALWAYS	AUTO	When Parameter "Increase virtual depth for PACS" is enabled values are : 15,12,10
Pixel Representation	0028,0103	US	0	ALWAYS	AUTO	
Burned In Annotation	0028,0301	CS		ALWAYS	CONFIG	
Pixel Intensity Relationship	0028,1040	CS	LOG	ALWAYS	AUTO	
Pixel Intensity Relationship Sign	0028,1041	SS	1	ALWAYS	AUTO	
Window Center	0028,1050	DS		ANAP	AUTO	
Window Width	0028,1051	DS		ANAP	AUTO	
Rescale Intercept	0028,1052	DS		ALWAYS	AUTO	
Rescale Slope	0028,1053	DS		ALWAYS	AUTO	

Rescale Type	0028,1054	LO		ALWAYS	AUTO	
Lossy Image Compression	0028,2110	CS	00	ALWAYS	AUTO	
Presentation LUT Shape	2050,0020	CS	IDENTITY	ALWAYS	AUTO	

Table 98: DX Detector Module

Attribute Name	Tag	VR	Value	Presence of Value	Source	Comment
Imager Pixel Spacing	0018,1164	DS		ALWAYS	AUTO	
Detector Temperature	0018,7001	DS		ANAP	AUTO	
Detector Type	0018,7004	CS	SCINTILLATOR	VNAP	AUTO	
Detector Mode	0018,7008	LT		ANAP	AUTO	
Detector ID	0018,700A	SH		ANAP	AUTO	
Date of Last Detector Calibration	0018,700C	DA		ANAP	AUTO	
Time of Last Detector Calibration	0018,700E	TM		ANAP	AUTO	
Detector Time Since Last Exposure	0018,7012	DS		ANAP	AUTO	
Detector Manufacturer Name	0018,702A	LO	TRIXELL	ANAP	AUTO	
Detector Manufacturer's Model Name	0018,702B	LO	PIXIUM2430EZ	ANAP	AUTO	
Field of View Rotation	0018,7032	DS		ANAP	AUTO	
Field of View Horizontal Flip	0018,7034	CS		ANAP	AUTO	
Pixel Spacing	0028,0030	DS		ANAP	AUTO	

Table 99: X-Ray Collimator

Attribute Name	Tag	VR	Value	Presence of Value	Source	Comment
Collimator Shape	0018,1700	CS		ALWAYS	AUTO	
Collimator Left Vertical Edge	0018,1702	IS		ANAP	AUTO	
Collimator Right Vertical Edge	0018,1704	IS		ANAP	AUTO	
Collimator Upper Horizontal Edge	0018,1706	IS		ANAP	AUTO	
Collimator Lower Horizontal Edge	0018,1708	IS		ANAP	AUTO	

Table 100: DX Positioning Module

Attribute Name	Tag	VR	Value	Presence of Value	Source	Comment
Distance Source to Detector	0018,1110	DS		ANAP	AUTO	
View Position	0018,5101	CS		ANAP	AUTO	
Distance Source to Patient	0018,1111	DS		ANAP	AUTO	
Estimated Radiographic Magnification Factor	0018,1114	DS		ANAP	AUTO	
Positioner Type	0018,1508	CS		VNAP	AUTO	

Table 101: X-Ray Acquisition Dose Module

Attribute Name	Tag	VR	Value	Presence of Value	Source	Comment
KVP	0018,0060	DS		ANAP	AUTO	
Distance Source to Detector	0018,1110	DS		ANAP	AUTO	

Distance Source to Patient	0018,1111	DS		ANAP	AUTO	
Exposure Time	0018,1150	IS		ANAP	AUTO	
Exposure	0018,1152	IS		ANAP	AUTO	
Exposure in μ As	0018,1153	IS		ANAP	AUTO	
Image and Fluoroscopy Area Dose Product	0018,115E	DS		ANAP	AUTO	
Relative X-Ray Exposure	0018,1405	IS		ANAP	AUTO	
Exposure Time in μ S	0018,8150	DS		ANAP	AUTO	
Entrance Dose	0040,0302	US		ANAP	AUTO	
Entrance Dose in mGy	0040,8302	DS		ANAP	AUTO	

Table 102: X-Ray Generation Module

Attribute Name	Tag	VR	Value	Presence of Value	Source	Comment
Exposure Time	0018,1150	IS		ANAP	AUTO	
KVP	0018,0060	DS		ANAP	AUTO	
Exposure	0018,1152	IS		ANAP	AUTO	
Exposure in μ As	0018,1153	IS		ANAP	AUTO	
Exposure Control Mode Description	0018,7062	LT		ANAP	AUTO	The amplimat fields are coded bitwise bit 0 = upper left field bit 1 = upper right field bit 2 = middle field bit 3 = lower left field bit 4 = lower right field
Exposure Time in μ S	0018,8150	DS		ANAP	AUTO	

Table 103: X-Ray Grid Module

Attribute Name	Tag	VR	Value	Presence of Value	Source	Comment
Grid	0018,1166	CS		ANAP	AUTO	

Table 104: Overlay Plane Module

Attribute Name	Tag	VR	Value	Presence of Value	Source	Comment
Overlay Rows	6000,0010	US		ALWAYS	AUTO	
Overlay Columns	6000,0011	US		ALWAYS	AUTO	
Overlay Type	6000,0040	CS		ALWAYS	AUTO	
Overlay Origin	6000,0050	SS		ALWAYS	AUTO	
Overlay Bits Allocated	6000,0100	US		ALWAYS	AUTO	
Overlay Bit Position	6000,0102	US		ALWAYS	AUTO	
Overlay Data	6000,3000	OW		ALWAYS	AUTO	

Table 105: Acquisition Context Module

Attribute Name	Tag	VR	Value	Presence of Value	Source	Comment
Acquisition Context Sequence	0040,0555	SQ		VNAP	AUTO	

Table 106: SOP Common Module

Attribute Name	Tag	VR	Value	Presence of Value	Source	Comment
SOP Class UID	0008,0016	UI	1.2.840.10008.5.1.4.1.1.1.1	ALWAYS	AUTO	
SOP Instance UID	0008,0018	UI		ALWAYS	AUTO	
Instance Number	0020,0013	IS		ANAP	AUTO	

Table 107: VOI LUT Module

Attribute Name	Tag	VR	Value	Presence of Value	Source	Comment
Window Center	0028,1050	UI		ANAP	AUTO	
Window Width	0028,1051	UI		ANAP	AUTO	

8.1.1.3. Digital X-Ray Image Storage - For Proc. SOP

Table 108: SOP Class Modules

Information Entity	Module	Presence
Patient	Patient Module	Always
Study	General Study Module	Always
	Patient Study Module	Conditional Note: Present when RIS send these attributes
Series	General Series Module	Always
	DX Series Module	Always
Equipment	General Equipment Module	Always
Image	General Image Module	Always
	Image Pixel Module	Always
	DX Anatomy Imaged Module	Always
	DX Image Module	Always
	DX Detector Module	Always
	Acquisition Context Module	Always
	Overlay Module	Conditional Note: Present when there are annotations or measurements (including labels, markers and electronic shutters) are added to the image
	SOP Common Module	Always

Table 109: Patient Module

Attribute Name	Tag	VR	Value	Presence of Value	Source	Comment
Patient's Name	0010,0010	PN		VNAP	MWL, USER	
Ethnic Group	0010,2160	LT		ANAP	MWL, USER	
Patient ID	0010,0020	LO		VNAP	MWL, AUTO	
Issuer of Patient ID	0010,0021	LO		ANAP	MWL, USER	
Patient's Birth Date	0010,0030	DA		VNAP	MWL, USER	

Patient's Sex	0010,0040	CS		VNAP	MWL, USER	
Other Patient IDs	0010,1000	LO		ANAP	MWL, USER	
Patient Comments	0010,4000	LT		ANAP	AUTO	

Table 110: General Study Module

Attribute Name	Tag	VR	Value	Presence of Value	Source	Comment
Study Date	0008,0020	DA		VNAP	MPPS	
Study Time	0008,0030	TM		VNAP	MPPS	
Accession Number	0008,0050	SH		VNAP	MWL,USER	
Referring Physician's Name	0008,0090	PN		VNAP	MWL,USER	
Study Description	0008,1030	LO		ANAP	MWL,USER	
Study Instance UID	0020,000D	UI		ALWAYS	MPPS,AUTO	
Study ID	0020,0010	SH		VNAP	MPPS,AUTO	

Table 111: Patient Study Module

Attribute Name	Tag	VR	Value	Presence of Value	Source	Comment
Patient's Age	0010,1010	AS		ANAP	MWL,USER	
Patient's Size	0010,1020	DS		ANAP	MWL,USER	
Patient's Weight	0010,1030	DS		ANAP	MWL,USER	
Additional Patient History	0010,21B0	LT		ANAP	MWL,USER	

Table 112: General Series Module

Attribute Name	Tag	VR	Value	Presence of Value	Source	Comment
Series Date	0008,0021	DA		ANAP	MPPS	
Series Time	0008,0031	TM		ANAP	MPPS	
Modality	0008,0060	CS	CR	ALWAYS		
Series Description	0008,103 ^E	LO		ANAP	MPPS,USER	
Performing Physicians' Name	0008,1050	PN		ANAP	MPPS,USER	
Operators' Name	0008,1070	PN		ANAP	MPPS,USER	
Referenced Performed Procedure Step Sequence	0008,1111	SQ		ANAP	MPPS,USER	
>Referenced SOP Class UID	0008,1150	UI		ALWAYS	MPPS,USER	
>Referenced SOP Instance UID	0008,1155	UI		ALWAYS	MPPS,USER	
Body Part Examined	0018,0015	CS		ANAP	MPPS,USER	
Protocol Name	0018,1030	LO		ANAP	MWL,USER	
Series Instance UID	0020,000E	UI		ALWAYS	MPPS,AUTO	
Series Number	0020,0011	IS		VNAP	MPPS,AUTO	
Laterality	0020,0060	CS		ANAP	CONFIG	
Performed Procedure Step Start Date	0040,0244	DA		ANAP	MPPS,AUTO	
Performed Procedure Step Start Time	0040,0245	TM		ANAP	MPPS,AUTO	
Performed Procedure Step ID	0040,0253	SH		ANAP	MPPS,AUTO	

Performed Procedure Step Description	0040,0254	LO		ANAP	MPPS,AUTO	
--------------------------------------	-----------	----	--	------	-----------	--

Table 113: General Equipment Module

Attribute Name	Tag	VR	Value	Presence of Value	Source	Comment
Manufacturer	0008,0070	LO	Philips	ALWAYS	AUTO	
Institution Name	0008,0080	LO		ANAP	CONFIG	
Institution Address	0008,0081	ST		ANAP	CONFIG	
Station Name	0008,1010	SH		ANAP	CONFIG	
Institutional Department Name	0008,1040	LO		ANAP	CONFIG	
Manufacturer's Model Name	0008,1090	LO	DigitalDiagnost R4.3	ANAP	CONFIG	
Device Serial Number	0018,1000	LO		ANAP	CONFIG	
Software Versions	0018,1020	LO		ANAP	AUTO	
Spatial Resolution	0018,1050	DS		ANAP	AUTO	

Table 114: General Image Module

Attribute Name	Tag	VR	Value	Presence of Value	Source	Comment
Image Type	0008,0008	CS		ANAP	AUTO	
Acquisition Date	0008,0022	DA		ANAP	AUTO	
Content Date	0008,0023	DA		VNAP	AUTO	
Acquisition Time	0008,0032	TM		ANAP	AUTO	
Content Time	0008,0033	TM		ANAP	AUTO	
Irradiation Event UID	0008,3010	UI		ANAP	AUTO	
Instance Number	0020,0013	IS		VNAP	AUTO	
Patient Orientation	0020,0020	CS		ANAP	AUTO	
Quality Control Image	0028,0300	CS		ANAP	AUTO	
Burned In Annotation	0028,0301	CS		ANAP	AUTO	
Lossy Image Compression	0028,2110	CS		ANAP	AUTO	
Presentation LUT Shape	2050,0020	CS		ANAP	AUTO	

Table 115: Image Pixel Module

Attribute Name	Tag	VR	Value	Presence of Value	Source	Comment
Samples per Pixel	0028,0002	US		ALWAYS	AUTO	
Photometric Interpretation	0028,0004	CS		ALWAYS	AUTO	
Rows	0028,0010	US		ALWAYS	AUTO	
Columns	0028,0011	US		ALWAYS	AUTO	
Bits Allocated	0028,0100	US		ALWAYS	AUTO	
Bits Stored	0028,0101	US		ALWAYS	AUTO	
High Bit	0028,0102	US		ALWAYS	AUTO	
Pixel Representation	0028,0103	US		ALWAYS	AUTO	
Pixel Data	7FE0,0010	OW/OB		ANAP	AUTO	

Table 116: DX Image Module

Attribute Name	Tag	VR	Value	Presence of Value	Source	Comment
Image Type	0008,0008	CS	ORIGINAL, PRIMARY	ALWAYS	AUTO	
Acquisition Device Processing Description	0018,1400	LO		ANAP	AUTO	
Patient Orientation	0020,0020	CS		ANAP	AUTO	
Samples per Pixel	0028,0002	US	1	ALWAYS	AUTO	
Photometric Interpretation	0028,0004	CS		ALWAYS	AUTO	
Bits Allocated	0028,0100	US	16	ALWAYS	AUTO	
Bits Stored	0028,0101	US	15, 12, 10	ALWAYS	CONFIG	
High Bit	0028,0102	US	14, 11, 9	ALWAYS	AUTO	
Pixel Representation	0028,0103	US	0	ALWAYS	AUTO	
Burned In Annotation	0028,0301	CS		ALWAYS	CONFIG	
Pixel Intensity Relationship	0028,1040	CS	LOG	ALWAYS	AUTO	
Pixel Intensity Relationship Sign	0028,1041	SS	1	ALWAYS	AUTO	
Window Center	0028,1050	DS		ANAP	AUTO	
Window Width	0028,1051	DS		ANAP	AUTO	
Rescale Intercept	0028,1052	DS		ALWAYS	AUTO	
Rescale Slope	0028,1053	DS		ALWAYS	AUTO	
Rescale Type	0028,1054	LO		ALWAYS	AUTO	
Lossy Image Compression	0028,2110	CS	00	ALWAYS	AUTO	
Presentation LUT Shape	2050,0020	CS	IDENTITY	ALWAYS	AUTO	

Table 117: DX Anatomy Imaged Module

Attribute Name	Tag	VR	Value	Presence of Value	Source	Comment
Anatomic Region Sequence	0008,2218	SQ		VNAP	AUTO	

Table 118: DX Detector Module

Attribute Name	Tag	VR	Value	Presence of Value	Source	Comment
Detector Type	0018,7004	CS		VNAP	AUTO	

Table 119: Acquisition Context Module

Attribute Name	Tag	VR	Value	Presence of Value	Source	Comment
Acquisition Context Sequence	0040,0555	SQ		VNAP	AUTO	

Table 120: Overlay Plane Module

Attribute Name	Tag	VR	Value	Presence of Value	Source	Comment
Overlay Rows	6000,0010	US		ALWAYS	AUTO	
Overlay Columns	6000,0011	US		ALWAYS	AUTO	
Overlay Type	6000,0040	CS		ALWAYS	AUTO	
Overlay Origin	6000,0050	SS		ALWAYS	AUTO	

Overlay Bits Allocated	6000,0100	US		ALWAYS	AUTO	
Overlay Bit Position	6000,0102	US		ALWAYS	AUTO	
Overlay Data	6000,3000	OW		ALWAYS	AUTO	

Table 121: SOP Common Module

Attribute Name	Tag	VR	Value	Presence of Value	Source	Comment
SOP Class UID	0008,0016	UI		ALWAYS	AUTO	
SOP Instance UID	0008,0018	UI		ALWAYS	AUTO	
Instance Number	0020,0013	IS		ANAP	AUTO	

Table 122: VOI LUT Module

Attribute Name	Tag	VR	Value	Presence of Value	Source	Comment
Window Center	0008,0016	UI		ANAP	AUTO	
Window Width	0008,0018	UI		ANAP	AUTO	

8.1.1.4. Secondary Capture Image Storage SOP Class

Table 123: SOP Class Modules

Information Entity	Module	Presence
Patient	Patient Module	Always
Study	General Study Module	Always
	Patient Study Module	Conditional Note: Present when RIS send these attributes
Series	General Series Module	Always
Equipment	SC Equipment Module	Always
	General Equipment Module	Always
Image	General Image Module	Always
	Image Pixel Module	Always
	SC Image Module	Always
	Overlay Plane	Conditional Note: Present when there are annotations or measurements (including labels, markers and electronic shutters) are added to the image
	SOP Common Module	Always

Table 124: Patient Module

Attribute Name	Tag	VR	Value	Presence of Value	Source	Comment
Patient's Name	0010,0010	PN		VNAP	MWL/ USER	
Patient ID	0010,0020	LO		VNAP	MWL/ AUTO	
Issuer of Patient ID	0010,0021	LO		ANAP	MWL/ USER	
Patient's Birth Date	0010,0030	DA		VNAP	MWL /USER	
Ethnic Group	0010,2160	SH		ANAP	MWL /USER	

Patient's Sex	0010,0040	CS		VNAP	MWL/ USER	
Other Patient IDs	0010,1000	LO		ANAP	MWL/ USER	
Patient Comments	0010,4000	LT		ANAP	AUTO	
					MWL/ USER	

Table 125: General Study Module

Attribute Name	Tag	VR	Value	Presence of Value	Source	Comment
Study Date	0008,0020	DA		VNAP	AUTO	
Study Time	0008,0030	TM		VNAP	AUTO	
Accession Number	0008,0050	SH		VNAP	MWL,USER	
Referring Physician's Name	0008,0090	PN		VNAP	MWL,USER	
Study Description	0008,1030	LO		ANAP	MWL,USER	
Study Instance UID	0020,000D	UI		ALWAYS	MWL,AUTO	
Study ID	0020,0010	SH		VNAP	MWL,AUTO	

Table 126: Patient Study Module

Attribute Name	Tag	VR	Value	Presence of Value	Source	Comment
Patients age	0010,1010	AS		ANAP	MWL,AUTO	
Patient's Size	0010,1020	DS		ANAP	MWL,AUTO	
Patient's Weight	0010,1030	DS		ANAP	MWL,AUTO	
Additional Patient History	0010,21B0	LT		ANAP	MWL,AUTO	

Table 127: General Series Module

Attribute Name	Tag	VR	Value	Presence of Value	Source	Comment
Series Date	0008,0021	DA		ANAP	AUTO	
Series Time	0008,0031	TM		ANAP	AUTO	
Modality	0008,0060	CS	CR	ALWAYS	AUTO	
Series Description	0008,103 ^E	LO		ANAP	MPPS,USER	
Performing Physicians' Name	0008,1050	PN		ANAP	MPPS,USER	
Operators' Name	0008,1070	PN		ANAP	MPPS,USER	
Referenced Performed Procedure Step Sequence	0008,1111	SQ		ANAP	MPPS,USER	
>Referenced SOP Class UID	0008,1150	UI		ALWAYS	MPPS,USER	
>Referenced SOP Instance UID	0008,1155	UI		ALWAYS	MPPS,USER	
Body Part Examined	0018,0015	CS		ANAP	MPPS,USER	
Protocol Name	0018,1030	LO		ANAP	MWL,USER	
Series Instance UID	0020,000E	UI		ALWAYS	MPPS,AUTO	
Series Number	0020,0011	IS		VNAP	MPPS,AUTO	
Laterality	0020,0060	CS		ANAP	CONFIG	
Performed Procedure Step Start Date	0040,0244	DA		ANAP	MPPS,AUTO	
Performed Procedure Step Start Time	0040,0245	TM		ANAP	MPPS,AUTO	

Performed Procedure Step ID	0040,0253	SH		ANAP	MPPS,AUTO	
Performed Procedure Step Description	0040,0254	LO		ANAP	MPPS,AUTO	

Table 128: General Equipment Module

Attribute Name	Tag	VR	Value	Presence of Value	Source	Comment
Manufacturer	0008,0070	LO	Philips	VNAP	AUTO	
Institution Name	0008,0080	LO		ANAP	CONFIG	
Institution Address	0008,0081	ST		ANAP	CONFIG	
Station Name	0008,1010	SH		ANAP	CONFIG	
Institutional Department Name	0008,1040	LO		ANAP	CONFIG	
Manufacturer's Model Name	0008,1090	LO	DigitalDiagnost R4.3	ANAP	AUTO	
Device Serial Number	0018,1000	LO		ANAP	CONFIG	
Software Versions	0018,1020	LO		ANAP	AUTO	
Spatial Resolution	0018,1050	DS		ANAP	AUTO	

Table 129: SC Equipment Module

Attribute Name	Tag	VR	Value	Presence of Value	Source	Comment
Modality	0008,0060	CS	CR,	ANAP	AUTO	
Conversion Type	0008,0064	CS	WSD	ALWAYS	AUTO	

Table 130: General Image Module

Attribute Name	Tag	VR	Value	Presence of Value	Source	Comment
Image Type	0008,0008	CS		ANAP	AUTO	
Acquisition Date	0008,0022	DA		ANAP	AUTO	
Content Date	0008,0023	DA		VNAP	AUTO	
Acquisition Time	0008,0032	TM		ANAP	AUTO	
Content Time	0008,0033	TM		VNAP	AUTO	
Irradiation Event UID	0008,3010	UI		ANAP	AUTO	
Instance Number	0020,0013	IS		VNAP	AUTO	
Patient Orientation	0020,0020	CS		VNAP	USER	
Quality Control Image	0028,0300	CS		ANAP	AUTO	
Burned In Annotation	0028,0301	CS		ANAP	AUTO	
Lossy Image Compression	0028,2110	CS		ANAP	AUTO	
Presentation LUT Shape	2050,0020	CS		ANAP	AUTO	

Table 131: Image Pixel Module

Attribute Name	Tag	VR	Value	Presence of Value	Source	Comment
Samples per Pixel	0028,0002	US		ALWAYS	AUTO	
Photometric Interpretation	0028,0004	CS		ALWAYS	AUTO	
Rows	0028,0010	US		ALWAYS	AUTO	
Columns	0028,0011	US		ALWAYS	AUTO	

Bits Allocated	0028,0100	US		ALWAYS	AUTO	
Bits Stored	0028,0101	US		ALWAYS	AUTO	
High Bit	0028,0102	US		ALWAYS	AUTO	
Pixel Representation	0028,0103	US		ALWAYS	AUTO	
Pixel Data	7FE0,0010	OW/OB		ANAP	AUTO	

Table 132: SC Image Module

Attribute Name	Tag	VR	Value	Presence of Value	Source	Comment
Date of Secondary Capture	0018,1012	DA		ANAP	AUTO	
Time of Secondary Capture	0018,1014	TM		ANAP	AUTO	
Pixel Spacing	0028,0030	DS		ANAP	AUTO	

Table 133: Overlay Plane Module

Attribute Name	Tag	VR	Value	Presence of Value	Source	Comment
Overlay Rows	6000,0010	US		ALWAYS	AUTO	
Overlay Columns	6000,0011	US		ALWAYS	AUTO	
Overlay Type	6000,0040	CS		ALWAYS	AUTO	
Overlay Origin	6000,0050	SS		ALWAYS	AUTO	
Overlay Bits Allocated	6000,0100	US		ALWAYS	AUTO	
Overlay Bit Position	6000,0102	US		ALWAYS	AUTO	
Overlay Data	6000,3000	OW		ALWAYS	AUTO	

Table 134: SOP Common Module

Attribute Name	Tag	VR	Value	Presence of Value	Source	Comment
SOP Class UID	0008,0016	UI		ALWAYS	AUTO	
SOP Instance UID	0008,0018	UI		ALWAYS	AUTO	
Instance Number	0020,0013	IS		ANAP	AUTO	

8.1.1.5. X-Ray Radiation Dose SR SOP Class

Table 135: SOP Class Modules

Information Entity	Module	Presence
Patient	Patient Module	Always
Study	General Study Module	Always
	Patient Study Module	Always
Series	SR Document Series Module	Always
Equipment	General Equipment Module	Always
	Enhanced General Equipment Module	Always
Image	SR Document General Module	Always
	SR Document Content Module	Always
	SOP Common Module	Always

Table 136: Patient Module

Attribute Name	Tag	VR	Value	Presence of Value	Source	Comment
Patient's Name	0010,0010	PN		VNAP	MWL/ USER	
Patient ID	0010,0020	LO		VNAP	MWL/ AUTO	
Issuer of Patient ID	0010,0021	LO		ANAP	MWL/ USER	
Patient's Birth Date	0010,0030	DA		VNAP	MWL /USER	
Patient's Sex	0010,0040	CS		VNAP	MWL/ USER	
Other Patient IDs	0010,1000	LO		ANAP	MWL/ USER	
Patient Comments	0010,4000	LT		ANAP	AUTO	
Ethnic Group	0010,2160	SH		ANAP	MWL/ USER	

Table 137: General Study Module

Attribute Name	Tag	VR	Value	Presence of Value	Source	Comment
Study Date	0008,0020	DA		VNAP	AUTO	
Study Time	0008,0030	TM		VNAP	AUTO	
Accession Number	0008,0050	SH		VNAP	MWL/ USER	
Referring Physician's Name	0008,0090	PN		VNAP	MWL	
Study Description	0008,1030	LO		ANAP	MWL/ AUTO	
Procedure Code Sequence	0008,1032	SQ		ANAP	MWL	
Code Value	0008,0100	SH		ALWAYS		
>Coding Scheme Designator	0008,0101	SH		ALWAYS		
>Coding Scheme Version	0008,0102	SH		ALWAYS		
>Study Instance UID	0020,000D	UI		ALWAYS	AUTO	
Study ID	0020,0010	SH		VNAP	MWL	

Table 138: Patient Study Module

Attribute Name	Tag	VR	Value	Presence of Value	Source	Comment
Patient's Age	0010,1010	AS		ANAP	MWL/ USER	
Patient's Size	0010,1020	DS		ANAP	MWL/ USER	
Patient's Weight	0010,1030	DS		ANAP	MWL/ USER	
Medical Alerts	0010,2000	LO		ANAP		
Allergies	0010,2110	LO		ANAP		
Occupation	0010,2180	SH		ANAP	MWL/ USER	

Additional Patient History	0010,21B0	LT		ANAP	MWL/ USER	
Pregnancy Status	0010,21C0	US		ANAP		
Patient State	0038,0500	LO		ANAP		

Table 139: SR Document Series Module

Attribute Name	Tag	VR	Value	Presence of Value	Source	Comment
Series Date	0008,0021	DA		ANAP		
Series Time	0008,0031	TM		ANAP		
Modality	0008,0060	CS		ALWAYS		
Series Description	0008,103E	LO		ANAP		
Referenced Performed Procedure Step Sequence	0008,1111	SQ		VNAP		
>Referenced SOP Class UID	0008,1150	Ui		ALWAYS		
>Referenced SOP Instance UID	0008,1155	UI		ALWAYS		
Series Instance UID	0020,000E	UI		ALWAYS		
Series Number	0020,0011	IS		ALWAYS		

Table 140: General Equipment Module

Attribute Name	Tag	VR	Value	Presence of Value	Source	Comment
Manufacturer	0008,0070	LO	Philips	VNAP		
Institution Name	0008,0080	LO		ANAP		
Institution Address	0008,0081	ST		ANAP		
Station Name	0008,1010	SH		ANAP		
Institutional Department Name	0008,1040	LO		ANAP		
Manufacturer's Model Name	0008,1090	LO	DigitalDiagnost R4.3	ANAP		
Device Serial Number	0018,1000	LO		ANAP		
Software Versions	0018,1020	LO		ANAP		
Spatial Resolution	0018,1050	DS		ANAP		

Table 141: Enhanced General Equipment Module

Attribute Name	Tag	VR	Value	Presence of Value	Source	Comment
Manufacturer	0008,0070	LO	Philips	VNAP		
Manufacturer's Model Name	0008,1090	LO	DigitalDiagnost R4.3	VNAP		
Device Serial Number	0018,1000	LO		VNAP		
Software Version(s)	0008,1020	LO		VNAP		

Table 142: SR Document General Module

Attribute Name	Tag	VR	Value	Presence of Value	Source	Comment
Content Date	0008,0023	DA		ALWAYS		
Content Time	0008,0033	TM		ALWAYS		
Instance Number	0020,0013	IS		ALWAYS		

Attribute Name	Tag	VR	Value	Presence of Value	Source	Comment
Referenced Request Sequence	0040,A370	SQ		ALWAYS		
> Accession Number	0008,0050	SH		VNAP		
> Referenced Study Sequence	0008,1110	SQ		VNAP		
> Study Instance UID	0020,000D	UI		ALWAYS		
> Requested Procedure Description	0032,1060	LO		VNAP		
> Requested Procedure Code Sequence	0032,1064	SQ		VNAP		
> Requested Procedure ID	0040,1001	SH		VNAP		
> Placer Order Number/Imaging Service Request	0040,2016	LO		VNAP		
> Filler Order Number/Imaging Service Request	0040,2017	LO		VNAP		
Performed Procedure Code Sequence	0040,A372	SQ		VNAP		
Completion Flag	0040,A491	CS		ALWAYS		
Completion Flag Description	0040,A492	LO		ANAP		
Verification Flag	0040,A493	CS		ALWAYS		

Table 143: SR Document Content Module

Attribute Name	Tag	VR	Value	Presence of Value	Source	Comment
Measured Value Sequence	0040,A300	SQ		VNAP		

Table 144: SOP Common Module

Attribute Name	Tag	VR	Value	Presence of Value	Source	Comment
Specific Character Set	0008,0005	CS		ANAP	COPY	
Instance Creation Date	0008,0012	DA		ANAPCV	AUTO	
Instance Creation Time	0008,0013	TM		ANAPCV	AUTO	
SOP Class UID	0008,0016	UI	1.2.840.10008.5.1.4.1.1.88.67	ALWAYS	FIXED	
SOP Instance UID	0008,0018	UI		ALWAYS	AUTO	
Instance Number	0020,0013	IS		ANAPCV	AUTO	

8.1.2. Usage of Attributes from Received IODs

The DigitalDiagnost R4.3 has only an export side. The modality cannot read/view images from a CD, but is able to do Query retrieve from the remote node.

8.1.3. Attribute Mapping

Table 145: Attribute Mapping during Modality Workflow

Name	BWL Tag	MPPS		Image IOD Tag
		Create Tag	Set Tag	
Accession Number	0008,0050	0008,0050	-	0008,0050
Modality	-	0008,0060	-	0008,0060
Referring Physician's Name	0008,0090	-	-	0008,0090
Operators' Name	-	-	0008,1070	0008,1070
Referenced Study Sequence	0008,1110	0008,1110	-	0008,1110

Name	BWL Tag	MPPS		Image IOD Tag
		Create Tag	Set Tag	
Referenced Image Sequence	-	-	(0008,1140)	-
> Referenced SOP Class UID	-	-	0008,1150	0008,0016
SOP Class UID	-	-	0008,1155	0008,0018
> Referenced SOP Instance UID	-	-	0008,1155	0008,0018
SOP Instance UID	-	-	0008,1155	0008,0018
Patient's Name	0010,0010	0010,0010	-	0010,0010
Patient ID	0010,0020	0010,0020	-	0010,0020
Issuer of Patient ID	0010,0021	0010,0021	-	0010,0021
Patient's Birth Date	0010,0030	0010,0030	-	0010,0030
Patient's Sex	0010,0040	0010,0040	-	0010,0040
Other Patient IDs	0010,1000	0010,1000	-	0010,1000
Medical Alerts	0010,2000	-	-	0010,2000
Allergies	0010,2110	-	-	0010,2110
Ethnic group	0010,2160	-	-	0010,2160
Additional Patient History	0010,21B0	-	-	0010,21B0
Pregnancy Status	0010,21C0	-	-	0010,21C0
Patient Comments	0010,4000	-	-	0010,4000
Protocol Name	-	-	0018,1030	0018,1030
Study Instance UID	0020,000D	0020,000D	-	0020,000D
Series Instance UID	-	-	0020,000E	0020,000E
Study ID	-	0020,0010	-	0020,0010
Requesting Service	0032,1033	-	-	0032,1033
Requested Procedure Description	0032,1060	0032,1060	-	-
Requested Procedure Code Sequence3	0032,1064	0008,1032	0008,1032	0008,1032
Performed Procedure Code Sequence	-	-	-	-
Special Needs	0038,0050	-	-	0038,0050
Patient State	0038,0500	-	-	0038,0500
Scheduled Procedure Step Description4	0040,0007	0040,0007	-	0040,0007
Performed Procedure Step Description	-	0040,0254	-	0040,0254
Scheduled Protocol Code Sequence4	0040,0008	0040,0260	0040,0260	0040,0008
Performed Protocol Code Sequence	-	-	-	0040,0260
Scheduled Procedure Step ID	0040,0009	0040,0009	-	0040,0009
Performed Procedure Step Start Date	-	0040,0244	-	0040,0244
Performed Procedure Step Start Time	-	0040,0245	-	0040,0245
Performed Procedure Step ID	-	0040,0253	-	0040,0253
Requested Procedure ID	0040,1001	0040,1001	-	0040,1001

Note 1: Value accumulated from all performed acquisitions including dropped (repeated) acquisitions.

8.2. Data Dictionary of Private Attributes

Please refer section 8.5.

8.3. Coded Terminology and Templates

Not Applicable

8.3.1. Context Groups

Not Applicable

8.3.2. Template Specifications

DigitalDiagnost R4.3 can optionally create and stores, upon completion of the study, a DICOM X-Ray Radiation DOSE SR object.

8.3.2.1. X-RAY RADIATION DOSE SR IOD TEMPLATES

The templates that comprise the X-Ray Radiation Dose SR are interconnected as indicated in the figure below:

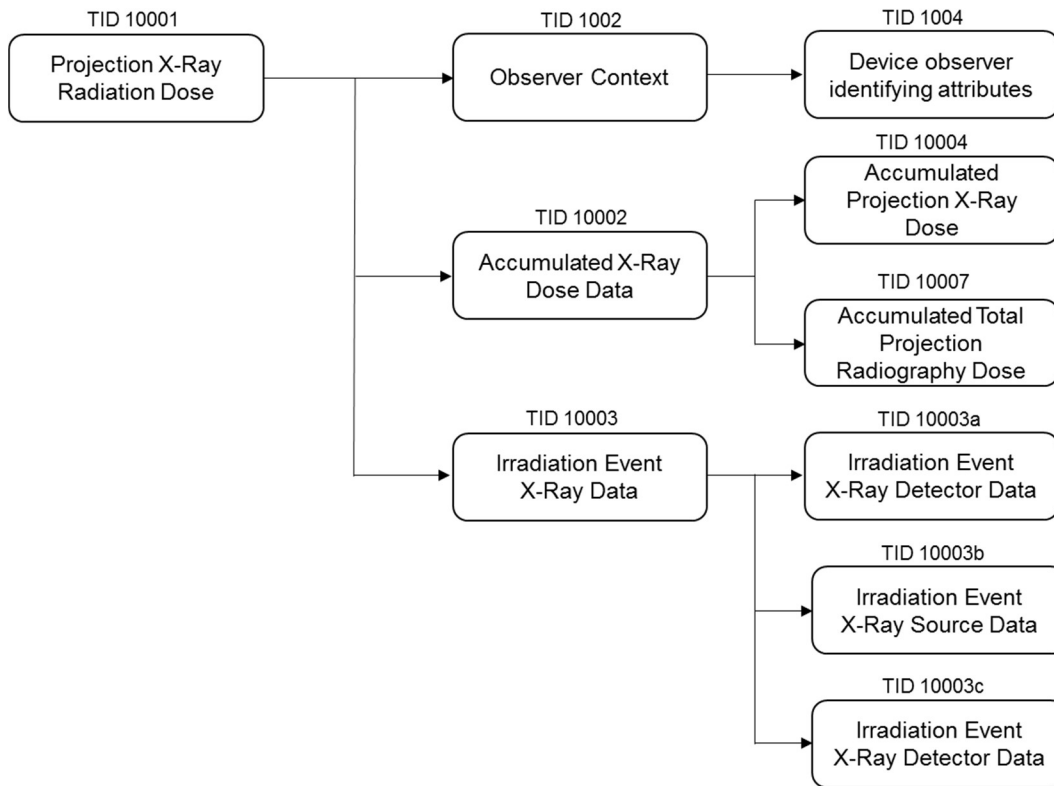

Figure 18: X-Ray Radiation Dose SR IOD Template Structure

This section describes the content of all the templates used in the X-Ray Radiation Dose Reporting SR.

Table 146: Used Templates for X-Ray Radiation Dose Reporting

Template Name	Template ID
Projection X-Ray Radiation Dose	TID 10001
Accumulated X-Ray Dose	TID 10002
Irradiation Event X-Ray Data	TID 10003
Irradiation Event X-Ray Detector Data	TID 10003a
Irradiation Event X-Ray Source Data	TID 10003b
Irradiation Event X-Ray Mechanical Data	TID 10003c
Accumulated Projection X-Ray Dose	TID 10004
Observer Context	TID 1002
Device Observer Identifying Attributes	TID 1004
Accumulated Total Projection Radiography Dose	TID 10007

8.3.2.1.1. TID 10001 Projection X-Ray Radiation Dose

Table 147: Projection X-Ray Radiation Dose

NL	Relation with Parent	Concept Name	VT	VM	Presence of Value	Value
		EV (113701, DCM, "X-Ray Radiation Dose Report")		1	ALWAYS	
>	HAS CONCEPT MOD	EV (121058, DCM, "Procedure reported")	CODE	1	ALWAYS	113704, DCM, "Projection X-Ray"
>>	HAS CONCEPT MOD	EV(G-C0E8, SRT, "Has Intent")	CODE	1	ALWAYS	R-408C3, SRT, "Diagnostic Intent"
>		DTID (1002) Observer Context	INCLUDE	1	ALWAYS	
>	HAS OBS CONTEXT	EV (113705, DCM, "Scope of Accumulation")	CODE	1	ALWAYS	(113016, DCM, "Performed Procedure Step")
>>	HAS PROPERTIES	DCID (10001) UID Types	UIDREF	1	ALWAYS	121126, DCM, Performed Procedure Step SOP Instance UID
>	CONTAINS	EV (113945, DCM, "X-Ray Detector Data Available")	CODE	1	ALWAYS	(R-0038D, SRT, "Yes")
>	CONTAINS	EV (113943, DCM, "X-Ray Source Data Available")	CODE	1	ALWAYS	(R-0038D, SRT, "Yes")
>	CONTAINS	EV (113944, DCM, "X-Ray Mechanical Data Available")	CODE	1	ALWAYS	(R-0038D, SRT, "Yes")
>	CONTAINS	DTID (10002) Accumulated X-Ray Dose	INCLUDE	1	ALWAYS	
>	CONTAINS	DTID (10003) Irradiation Event X-Ray Data	INCLUDE	1-n	ALWAYS	
>	CONTAINS	EV (121106, DCM, "Comment")	TEXT	1	CONDITIONAL	X-Ray Radiation Dose Structured Report related to the Performed Procedure Step
>	CONTAINS	EV (113854, DCM, "Source of Dose Information")	CODE	1	ALWAYS	Automated Data Collection

8.3.2.1.2. TID 10002 Accumulated X-Ray Dose

Table 148: Accumulated X-Ray Dose

NL	Relation with Parent	Concept Name	VT	VM	Presence of Value	Value
>	CONTAINS, CONTINUOUS	EV (113702, DCM, "Accumulated X-Ray Dose Data")	CONTAINER	1	ALWAYS	
>>	HAS CONCEPT MOD	EV (113764, DCM, "Acquisition Plane")	CODE	1	ALWAYS	113622, DCM, "Single Plane"
>	CONTAINS	DTID (10004) Accumulated Projection X-Ray Dose	INCLUDE	1	ALWAYS	
>	CONTAINS	DTID (10007) Accumulated Total Projection Radiography Dose"	INCLUDE	1	CONDITIONAL	If TID (10001) Row 2 = (113704, DCM, "Projection X-Ray") and TID (10001) Row 4 is absent)

8.3.2.1.3. TID 10003 Irradiation Event X-Ray Data

Table 149: Irradiation Event X-Ray Data

NL	Relation with Parent	Concept Name	VT	VM	Presence of Value	Value
>	CONTAINS, CONTINUOUS	EV (113706, DCM, "Irradiation Event X-Ray Data")	CONTAINER	1	ALWAYS	
>>	HAS CONCEPT MOD	EV (113764, DCM, "Acquisition Plane")	CODE	1	ALWAYS	113622, DCM, "Single Plane
>>	CONTAINS	DT (111526, DCM, "DateTime Started")	DATETIME	1	ALWAYS	
>>	CONTAINS	EV (113721, DCM, "Irradiation Event Type")	CODE	1	ALWAYS	Stationary Acquisition
>>	CONTAINS	EV (125203, DCM, "Acquisition Protocol")	TEXT	1	CONDITIONAL	
>>	CONTAINS	EV (113780, DCM, "Reference Point Definition")	CODE	1	ALWAYS	30cm above Tabletop and 30cm in Front of Image Input Surface
>>	CONTAINS	EV (113769, DCM, "Irradiation Event UID")	UIDREF	1	ALWAYS	
>>	CONTAINS	EV (122130, DCM, "Dose Area Product")	NUM	1	ALWAYS	Units = Gy.m2
>>	CONTAINS	EV (123014, DCM, "Target Region")	CODE	1	ALWAYS	Value from CID 4031 Common Anatomic Regions
>	CONTAINS	DTID 10003A Irradiation Event X-Ray Detector Data	INCLUDE	1	CONDITIONAL	IFF TID (10001) Row 8 is absent or has a value of (R-0038D, SRT, "Yes")
>	CONTAINS	DTID 10003B Irradiation Event X-Ray Source Data	INCLUDE	1	CONDITIONAL	IFF TID (10001) Row 9 is absent or has a value of (R-0038D, SRT, "Yes")
>	CONTAINS	DTID 10003C Irradiation Event X-Ray Mechanical Data	INCLUDE	1	CONDITIONAL	IFF TID (10001) Row 10 is absent or has a value of (R-0038D, SRT, "Yes")

8.3.2.1.1. TID 10003a Irradiation Event X-Ray Detector Data

Table 150: Irradiation Event X-Ray Detector Data

NL	Relation with Parent	Concept Name	VT	VM	Presence of Value	Value
	CONTAINS	EV (113845, DCM, "Exposure Index")	NUM	1	CONDITIONAL	Units=no units
	CONTAINS	EV (113795, DCM, "Acquired Image")	IMAGE	1-n	User Defined	
	CONTAINS	EV (113846, DCM, "Target Exposure Index")	NUM	1	User Defined	
	CONTAINS	EV (113847, DCM, "Deviation Index")	NUM	1	User Defined	

8.3.2.1.2. TID 10003b Irradiation Event X-Ray Source Data

Table 151: Irradiation Event X-Ray Source Data

NL	Relation with Parent	Concept Name	VT	VM	Presence of Value	Value
		EV (113738, DCM, "Dose (RP) ")	NUM	1	CONDITIONAL	Units=Gy
		EV (113768, DCM, "Number of Pulses")	NUM	1	CONDITIONAL	(1, UCUM, "no units")

		EV (113742, DCM, "Irradiation Duration")	NUM	1	USER DEFINED	(s, UCUM, "s")
		EV (113733, DCM, "KVP")	NUM	1-n	ALWAYS	Units=kV
		EV (113734, DCM, "X-Ray Tube Current")	NUM	1	ALWAYS	Units=mA
		EV (113736, DCM, "Exposure")	NUM	1-n	CONDITIONAL	Units= uAs
		EV (111632, DCM, "Anode Target Material")	CODE	1	USER DEFINED	

Note: EV (113780, reference point definition) is not present.

8.3.2.1.3. TID 10003c Irradiation Event X-Ray Mechanical Data

Table 152: Irradiation Event X-Ray Mechanical Data

NL	Relation with Parent	Concept Name	VT	VM	Presence of Value	Value
>>		Dose Related Distance Measurements	NUM	1-n	USER DEFINED	Units=mm

8.3.2.1.4. TID 10004 Accumulated Projection X-Ray Dose

Table 153: Accumulated Projection X-Ray Dose

NL	Relation with Parent	Concept Name	VT	VM	Presence of Value	Value
>>	CONTAINS	EV (113727, DCM, "Acquisition Dose Area Product Total")	NUM	1	ALWAYS	Units = Gy.m2
>>	CONTAINS	EV (113729, DCM, "Acquisition Dose (RP) Total")	NUM	1	CONDITIONAL	Units = Gy
>>	CONTAINS	EV (113727, DCM, "Acquisition Dose Area Product Total")	NUM	1	ALWAYS	Units = seconds

8.3.2.1.5. TID 1002 Observer Context

Table 154: Observer Context

NL	Relation with Parent	Concept Name	VT	VM	Presence of Value	Value
>	HAS OBS CONTEXT	EV (121005, DCM, "Observer Type")	CODE	1	CONDITIONAL	Device
	HAS OBS CONTEXT	DTID (1004) Device observer identifying attributes	INCLUDE	1	ALWAYS	

8.3.2.1.6. TID 1004 Device Observer Identifying Attributes

Table 155: Device Observer Identifying Attributes

NL	Relation with Parent	Concept Name	VT	VM	Presence of Value	Value
>	HAS OBS CONTEXT	EV (121012, DCM, "Device Observer UID")	UIDREF	1	ALWAYS	
>	HAS OBS CONTEXT	EV (121013, DCM, "Device Observer Name")	TEXT	1	ALWAYS	Station Name (0008,1010):DiDiDR01

>	HAS OBS CONTEXT	EV (121014, DCM, "Device Observer Manufacturer")	TEXT	1	ALWAYS	Manufacturer (0008,0070): Philips
>	HAS OBS CONTEXT	EV (121015, DCM, "Device Observer Model Name")	TEXT	1	ALWAYS	Manufacturer's Model Name (0008,1090): DigitalDiagnost R4.3
>	HAS OBS CONTEXT	EV (121016, DCM, "Device Observer Serial Number")	TEXT	1	ALWAYS	Device Serial Number (0018,1000)

8.3.2.1.7. TID 10007. Accumulated Total Projection Radiography Dose

Table 156: Accumulated Total Projection Radiography Dose

NL	Relation with Parent	Concept Name	VT	VM	Presence of Value	Value
		EV (113722, DCM, "Dose Area Product Total")	NUM	1	ALWAYS	1.011E-5 Units: (Gy.m2, UCUM, Gy.m2)
		EV (113725, DCM, "Dose (RP) Total")	NUM	1	CONDITIONAL	1.23E-4 Units: (Gy, UCUM, Gy)
		EV (113731, DCM, "Total Number of Radiographic Frames")	NUM	1	User Defined	
		EV (113780, DCM, "Reference Point Definition")	CODE	1	CONDITIONAL	

8.3.3. Private code definitions

Not Applicable

8.4. Grayscale Image consistency

The monitor of DigitalDiagnost R4.3 system can be calibrated according Grayscale Display Function Standard.

The pixel values exported and printed should be interpreted as P-Value. If the export destination or the printer does not support GSDF, DigitalDiagnost R4.3 provides calibration tools to adapt to this device to afford grayscale image consistency. The calibration takes into account ambient luminance and light box luminance.

8.5. Standard Extended/Specialized/Private SOPs

Table 157: List of Extended/Specialized/Private created SOP Instance

SOP Class Name	SOP Class UID
Computed Radiography Image Storage SOP Class	1.2.840.10008.5.1.4.1.1.1
Secondary Capture Image Storage SOP Class	1.2.840.10008.5.1.4.1.1.7
Digital X-Ray Image Storage - For Pres. SOP	1.2.840.10008.5.1.4.1.1.1.1
Digital X-Ray Image Storage - For Proc. SOP	1.2.840.10008.5.1.4.1.1.1.1.1
X-Ray Radiation Dose SR	1.2.840.10008.5.1.4.1.1.88.67

8.5.1. Standard Extended/Specialized/Private SOP Instance

The Storage SOP classes are extended to create a standard extended SOP class by addition of standard and private attributes to the created SOP Instances.

8.5.1.1. Computed Radiography Image Storage SOP Class

Table 158: Addition of standard and private attributes

Attribute Name	Tag	VR	Value	Presence of Value	Source	Comment
Irradiation Event UID	0008,3010	UI		ANAP	AUTO	
Medical Alerts	0010,2000	LO		VNAP	MWL/USER	
Allergies	0010,2110	LO		VNAP	MWL/USER	
Pregnancy Status	0010,21C0	US		VNAP	MWL/USER	
Image and Fluoroscopy Area Dose Product	0018,115E	DS		VNAP	AUTO	
Grid	0018,1166	CS		VNAP	AUTO	
Filter Material	0018,7050	CS		VNAP	AUTO	
Requesting Physician	0032,1032	PN		VNAP	MWL/USER	
Requesting Service	0032,1033	LO		VNAP	MWL/USER	
Requested Procedure Description	0032,1060	LO		VNAP	MWL/USER	
Special Needs	0038,0050	LO		VNAP	MWL/USER	
Patient State	0038,0500	LO		VNAP	MWL/USER	
Performed Station AE Title	0040,0241	AE		VNAP	MPPS/AUTO	
Performed Procedure Step End Date	0040,0250	DA		VNAP	MPPS/AUTO	
Performed Procedure Step End Time	0040,0251	TM		VNAP	MPPS/AUTO	
Performed Procedure Step Status	0040,0252	CS		VNAP	MPPS/AUTO	
Total Number of Exposures	0040,0301	US		VNAP	AUTO	
Requested Procedure ID	0040,1001	SH		VNAP	MWL/USER	
Reason for the Requested Procedure	0040,1002	LO		VNAP	MWL/USER	
Requested Procedure Priority	0040,1003	SH		VNAP	MWL/USER	
Patient Transport Arrangements	0040,1004	LO		VNAP	MWL/USER	
Names of Intended Recipients of Results	0040,1010	PN		VNAP	MWL/USER	
Requested Procedure Comments	0040,1400	LT		VNAP	MWL/USER	
Reason for the Imaging Service Request (RETIRED)	0040,2001	LO		VNAP	MWL	
Issue Date of Imaging Service Request	0040,2004	DA		VNAP	MWL/USER	
Imaging Service Request Comments	0040,2400	LT		VNAP	MWL/USER	
Requested Procedure Code Sequence	0032,1064	SQ		VNAP	MWL	
Exposure Dose Sequence	0040,030E	SQ		VNAP	AUTO	
Film Consumption Sequence	0040,0321	SQ		VNAP	AUTO	

8.5.1.2. Secondary Capture Image Storage SOP Class

Table 159: Addition of standard and private attributes

Attribute Name	Tag	VR	Value	Presence of Value	Source	Comment
Irradiation Event UID	0008,3010	UI		ANAP	AUTO	
Medical Alerts	0010,2000	LO		VNAP	MWL/USER	
Allergies	0010,2110	LO		VNAP	MWL/USER	
Pregnancy Status	0010,21C0	US		VNAP	MWL/USER	
KVP	0018,0060	DS		ANAP	AUTO	
Distance Source to Detector	0018,1110	DS		ANAP	AUTO	
Distance Source to Patient	0018,1111	DS		ANAP	AUTO	
Exposure Time	0018,1150	IS		ANAP	AUTO	
Exposure	0018,1152	IS		ANAP	AUTO	
Exposure in uAs	0018,1153	IS		ANAP	AUTO	

Radiation Setting	0018,1155	CS		VNAP	AUTO	
Image and Fluoroscopy Area Dose Product	0018,115E	DS		VNAP	AUTO	
Grid	0018,1166	CS		VNAP	AUTO	
Filter Material	0018,7050	CS		VNAP	AUTO	
Imager Pixel Spacing	0018,1164	DS		VNAP	AUTO	
Acquisition Device Processing Description	0018,1400	LO		VNAP	AUTO	
Relative X-ray Exposure	0018,1405	IS		VNAP	AUTO	
View Position	0018,5101	CS		VNAP	AUTO	
Requesting Physician	0032,1032	PN		VNAP	MWL/USER	
Requesting Service	0032,1033	LO		VNAP	MWL/USER	
Requested Procedure Description	0032,1060	LO		VNAP	MWL/USER	
Special Needs	0038,0050	LO		VNAP	MWL/USER	
Patient State	0038,0500	LO		VNAP	MWL/USER	
Performed Station AE Title	0040,0241	AE		VNAP	MPPS/AUTO	
Performed Procedure Step End Date	0040,0250	DA		VNAP	MPPS/AUTO	
Performed Procedure Step End Time	0040,0251	TM		VNAP	MPPS/AUTO	
Performed Procedure Step Status	0040,0252	CS		VNAP	MPPS/AUTO	
Total Number of Exposures	0040,0301	US		VNAP	AUTO	
Entrance Dose	0040,0302	US		VNAP	AUTO	
Requested Procedure ID	0040,1001	SH		VNAP	MWL/USER	
Reason for the Requested Procedure	0040,1002	LO		VNAP	MWL/USER	
Requested Procedure Priority	0040,1003	SH		VNAP	MWL/USER	
Patient Transport Arrangements	0040,1004	LO		VNAP	MWL/USER	
Names of Intended Recipients of Results	0040,1010	PN		VNAP	AUTO	
Requested Procedure Comments	0040,1400	LT		VNAP	MWL	
Reason for the Imaging Service Request (RETIRED)	0040,2001	LO		VNAP	MWL	
Issue Date of Imaging Service Request	0040,2004	DA		VNAP	MWL/USER	
Imaging Service Request Comments	0040,2400	LT		VNAP	MWL/USER	
Requested Procedure Code Sequence	0032,1064	SQ		VNAP	MWL	
Exposure Dose Sequence	0040,030E	SQ		VNAP	AUTO	
Film Consumption Sequence	0040,0321	SQ		VNAP	AUTO	

8.5.1.3. Digital X-Ray Image Storage - For Pres. SOP

Table 160: Addition of standard and private attributes

Attribute Name	Tag	VR	Value	Presence of Value	Source	Comment
Irradiation Event UID	0008,3010	UI		ANAP	AUTO	
Medical Alerts	0010,2000	LO		VNAP	MWL/USER	
Allergies	0010,2110	LO		VNAP	MWL/USER	
Pregnancy Status	0010,21C0	US		VNAP	MWL/USER	
Requesting Physician	0032,1032	PN		VNAP	MWL/USER	
Requesting Service	0032,1033	LO		VNAP	MWL/USER	
Requested Procedure Description	0032,1060	LO		VNAP	MWL/USER	
Requested Procedure Code Sequence	0032,1064	SQ			MWL/USER	
Special Needs	0038,0050	LO		VNAP	MWL/USER	
Patient State	0038,0500	LO		VNAP	MWL/USER	
Performed Station AE Title	0040,0241	AE		VNAP	MPPS/AUTO	
Performed Procedure Step End Date	0040,0250	DA		VNAP	MPPS/AUTO	
Performed Procedure Step End Time	0040,0251	TM		VNAP	MPPS/AUTO	

© 2019 Koninklijke Philips N.V.

Performed Procedure Step Status	0040,0252	CS		VNAP	MPPS/AUTO	
Total Number of Exposures	0040,0301	US		VNAP	AUTO	
Requested Procedure ID	0040,1001	SH		VNAP	MWL/AUTO	
Requested Procedure Priority	0040,1003	SH		VNAP	MWL	
Patient Transport Arrangements	0040,1004	LO		VNAP	MWL/USER	
Names of Intended Recipients of Results	0040,1010	PN		VNAP	AUTO	
Requested Procedure Comments	0040,1400	LT		VNAP	MWL	
Reason for the Imaging Service Request (RETIRED)	0040,2001	LO		VNAP	MWL	
Imaging Service Request Comments	0040,2400	LT		VNAP	MWL/USER	
Requested Procedure Code Sequence	0032,1064	SQ		VNAP	MWL	
Exposure Dose Sequence	0040,030E	SQ		VNAP	AUTO	
Film Consumption Sequence	0040,0321	SQ		VNAP	AUTO	

8.5.1.4. Digital X-Ray Image Storage - For Proc. SOP

Table 161: Addition of standard and private attributes

Attribute Name	Tag	VR	Value	Presence of Value	Source	Comment
Irradiation Event UID	0008,3010	UI		ANAP	AUTO	
Medical Alerts	0010,2000	LO		VNAP	MWL/USER	
Allergies	0010,2110	LO		VNAP	MWL/USER	
Pregnancy Status	0010,21C0	US		VNAP	MWL/USER	
Requesting Physician	0032,1032	PN		VNAP	MWL/USER	
Requesting Service	0032,1033	LO		VNAP	MWL/USER	
Requested Procedure Description	0032,1060	LO		VNAP	MWL/USER	
Special Needs	0038,0050	LO		VNAP	MWL/USER	
Patient State	0038,0500	LO		VNAP	MWL/USER	
Performed Station AE Title	0040,0241	AE		VNAP	MPPS/AUTO	
Performed Procedure Step End Date	0040,0250	DA		VNAP	MPPS/AUTO	
Performed Procedure Step End Time	0040,0251	TM		VNAP	MPPS/AUTO	
Performed Procedure Step Status	0040,0252	CS		VNAP	MPPS/AUTO	
Total Number of Exposures	0040,0301	US		VNAP	AUTO	
Requested Procedure ID	0040,1001	SH		VNAP	MWL/AUTO	
Reason for the Requested Procedure	0040,1002	LO		VNAP	MWL	
Requested Procedure Priority	0040,1003	SH		VNAP	MWL	
Patient Transport Arrangements	0040,1004	LO		VNAP	MWL/USER	
Names of Intended Recipients of Results	0040,1010	PN		VNAP	AUTO	
Requested Procedure Comments	0040,1400	LT		VNAP	MWL	
Reason for the Imaging Service Request (RETIRED)	0040,2001	LO		VNAP	MWL	
Imaging Service Request Comments	0040,2400	LT		VNAP	MWL/USER	
Requested Procedure Code Sequence	0032,1064	SQ		VNAP	MWL	
Exposure Dose Sequence	0040,030E	SQ		VNAP	AUTO	
Film Consumption Sequence	0040,0321	SQ		VNAP	AUTO	

8.5.1.5. X-Ray Radiation Dose SR SOP Class

Table 162: Addition of standard and private attributes for X-Ray Radiation Dose SR Instances

Attribute Name	Tag	VR	Value	Presence of Value	Source	Comment
Performing Physician's Name	0008,1050	PN		ANAP	MWL/AUTO/ USER	
Medical Alerts	0010,2000	LO		ANAP	MWL/AUTO/ USER	
Allergies	0010,2110	LO		ANAP	MWL/AUTO/ USER	
Pregnancy Status	0010,21C0	US		ANAP	MWL/AUTO/ USER	
Image and Fluoroscopy Area Dose Product	0018,115E	DS		ANAP	MWL/AUTO/ USER	
Requesting Physician	0032,1032	PN		ANAP	MWL/AUTO/ USER	
Requesting Service	0032,1033	LO		ANAP	MWL/AUTO/ USER	
Requested Procedure Description	0032,1060	LO		ANAP	MWL/AUTO/ USER	
Special Needs	0038,0050	LO		ANAP	MWL/AUTO/ USER	
Patient State	0038,0500	LO		ANAP	MWL/AUTO/ USER	
Performed Station AE Title	0040,0241	AE		ANAP	MWL/AUTO/ USER	
Performed Procedure Step Start Date	0040,0244	DA		ANAP	MWL/AUTO/ USER	
Performed Procedure Step Start Time	0040,0245	TM		ANAP	MWL/AUTO/ USER	
Performed Procedure End Date	0040,0250	DA		ANAP	MWL/AUTO/ USER	
Performed Procedure End Time	0040,0251	TM		ANAP	MWL/AUTO/ USER	
Performed Procedure Step Status	0040,0252	CS		ANAP	MWL/AUTO/ USER	
Performed Procedure Step ID	0040,0253	SH		ANAP	MWL/AUTO/ USER	
Performed Procedure Step Description	0040,0254	LO		ANAP	MWL/AUTO/ USER	
Performed Protocol Code Sequence	0040,0260	SQ		ANAP	MWL/AUTO/ USER	
>Code Value	0008,0100	SH		ALWAYS	MWL/AUTO/ USER	
>Coding Scheme Designator	0008,0102	SH		ALWAYS	MWL/AUTO/ USER	
>Code Meaning	0008,0104	LO		ALWAYS	MWL/AUTO/ USER	
Total Time of Fluoroscopy	0040,0300	US		ANAP	MWL/AUTO/ USER	
Total Number of Exposures	0040,0301	US		ANAP	MWL/AUTO/ USER	
Entrance Dose	0040,0302	US		ANAP	MWL/AUTO/ USER	
Exposure Dose Sequence	0040,030E	SQ		ANAP	MWL/AUTO/ USER	
Film Consumption Sequence	0040,0321	SQ		ANAP	MWL/AUTO/ USER	
Requested Procedure ID	0040,1001	LO		VNAP	MWL/AUTO/ USER	
Reason for the Requested Procedure	0040,1002	LO		VNAP	MWL/AUTO/ USER	
Requested Procedure Priority	0040,1003	SH		VNAP	MWL/AUTO/ USER	
Patient Transport Arrangements	0040,1004	LO		VNAP	MWL/AUTO/ USER	
Names of Intended Recipients of Results	0040,1010	PN		VNAP	MWL/AUTO/ USER	
Requested Procedure Comments	0040,1400	LT		ANAP	MWL/AUTO/ USER	
Reason for the Imaging Service Request (retired)	0040,2001	LO		ANAP	MWL/AUTO/ USER	
Issue Date of Imaging Service Request	0040,2004	DA		ANAP	MWL/AUTO/ USER	

Imaging Service Request Comments	0040,2400	LT		ANAP	MWL/AUTO/ USER	
UID	0040,A124	UI		ANAP	MWL/AUTO/ USER	
Referenced Request Sequence	0040,A370	SQ		ANAP	MWL/AUTO/ USER	
>Accession Number	0008,0050	SH		ANAP	MWL/AUTO/ USER	
>Referenced Study Sequence	0008,1110	SQ		ANAP	MWL/AUTO/ USER	
>Study Instance UID	0020,000D	UI		ANAP	MWL/AUTO/ USER	
>Requested Procedure Description	0032,1060	LO		ANAP	MWL/AUTO/ USER	
>Requested Procedure ID	0040,1001	SH		ANAP	MWL/AUTO/ USER	
>Placer Order Number / Imaging Service Request	0040,2016	LO		ANAP	MWL/AUTO/ USER	
>Filler Order Number / Imaging Service Request	0040,2017	LO		ANAP	MWL/AUTO/ USER	
Performed Procedure Code Sequence	0040,A372	SQ		ANAP	MWL/AUTO/ USER	
>Code Value	0008,0100	SH		ALWAYS	MWL/AUTO/ USER	
>Coding Scheme Designator	0008,0102	SH		ALWAYS	MWL/AUTO/ USER	
>Code Meaning	0008,0104	LO		ALWAYS	MWL/AUTO/ USER	

8.6. Private Transfer Syntaxes

Not Applicable

