

**PHILIPS**

Videowall Display

8000 Series

55BDL8107X



# User Manual (English)

# Table Of Contents

1.	Safety Instructions .....	1
2.	Unpacking and Installation.....	10
2.1.	Unpacking .....	10
2.2.	Unpacking Inspection Instructions .....	12
2.3.	Package Contents.....	15
2.4.	Installation Notes .....	15
2.5.	Mounting on a Wall .....	16
2.5.1.	VESA Grid .....	16
2.6.	Mounting in Portrait Orientation .....	17
2.7.	Operating Instructions of Edge Alignment Kit.....	18
2.7.1.	Installing the Edge Alignment Kit.....	18
2.8.	Using the Edge Finishing Kit (Optional)....	19
2.9.	Using the Gap Pad .....	20
3.	Parts and Functions .....	21
3.1.	Control Panel .....	21
3.2.	Input/Output Terminals.....	22
3.3.	Remote Control.....	23
3.3.1.	General Functions .....	23
3.3.2.	ID Remote Control .....	24
3.3.3.	Inserting the Batteries in the Remote Control.....	25
3.3.4.	Handling the Remote Control.....	25
3.3.5.	Operating Range of the Remote Control.....	25
4.	Connecting External Equipment .....	26
4.1.	Connecting External Equipment (Multimedia Player).....	26
4.1.1.	Using HDMI Video Input.....	26
4.2.	Connecting a PC.....	26
4.2.1.	Using VGA Input.....	26
4.2.2.	Using DVI Input.....	26
4.2.3.	Using HDMI Input .....	27
4.2.4.	Using DisplayPort Input.....	27
4.3.	Connecting Audio Equipment.....	27
4.3.1.	Connecting an External Audio Device .....	27
4.4.	Connecting Multiple Displays in a Daisy-Chain Configuration.....	28
4.4.1.	Display Control Connection .....	28
4.4.2.	Digital Video Connection .....	28
4.5.	IR Connection .....	30
5.	Operation .....	31
5.1.	Watch the Connected Video Source.....	31
5.2.	Change Picture Format.....	31
6.	OSD Menu .....	31
6.1.	Navigating the OSD Menu .....	31
6.1.1.	Navigating the OSD Menu using the Remote Control .....	31
6.1.2.	Navigating the OSD Menu using the Display's Control Buttons.....	31
6.2.	OSD Menu Overview .....	31
6.2.1.	Picture Menu .....	31
6.2.2.	Screen Menu.....	32
6.2.3.	Audio Menu.....	33
6.2.4.	PIP Menu.....	34
6.2.5.	Configuration 1 Menu.....	35
6.2.6.	Configuration 2 Menu.....	36
6.2.7.	Advanced Option Menu.....	37
7.	Input Mode .....	42
8.	Pixel Defect Policy .....	44
8.1.	Pixels and Sub-Pixels.....	44
8.2.	Types of Pixel Defects + Dot Definition.....	44
8.3.	Bright Dot Defects.....	44
8.4.	Dark Dot Defects .....	45
8.5.	Proximity of Pixel Defects .....	45
8.6.	Pixel Defect Tolerances .....	45
8.7.	Mura.....	45
9.	Cleaning and Troubleshooting .....	47
9.1.	Cleaning .....	47
9.2.	Troubleshooting .....	48
10.	Technical Specifications.....	49
	Warranty Policy for Philips Professional Displays.....	51
	Index.....	53

# 1. Safety Instructions

## Safety precautions and maintenance



**WARNING:** Use of controls, adjustments or procedures other than those specified in this documentation may result in exposure to shock, electrical hazards and/or mechanical hazards.

### Read and follow these instructions when connecting and using your display:

This product is intended for use in professional installations in business settings only and is not suitable for domestic purposes. Any use other than that for which this device is intended can void the warranty.

#### Operation:

- Keep the display out of direct sunlight and away from stoves or any other heat sources.
- Keep the display away from oil, otherwise the plastic cover may be damaged.
- It is recommended to set the display up in the well-ventilated place.
- Ultra-violet ray filter is necessary of outdoor operation.
- If the product will be used in extreme conditions such as high temperature, humidity, display patterns or operation time etc It is strongly recommended to contact Philips for application engineering advice. Otherwise, its reliability and function may not be guaranteed. Extreme conditions are commonly found at airports, transit stations, banks, stock market, and controlling systems.
- Remove any object that could fall into ventilation holes or prevent proper cooling of the display's electronics.
- Do not block the ventilation holes on the cabinet.
- When positioning the display, make sure the power plug and outlet are easily accessible.
- When turning off the display by detaching the power cord, wait 6 seconds before re-attaching the power cord for normal operation.
- Ensure the use of an approved power cord provided by Philips at all times. If your power cord is missing, please contact your local service center.
- Do not subject the display to severe vibration or high impact conditions during operation.
- Do not knock or drop the display during operation or transportation.
- The eye bolt is for usage in short-time maintenance and installation. We suggest not to use the eye bolt for more than 1 hour. Prolong usage is prohibited. Please keep a clear safety area under the display while using the eye bolt.

#### Maintenance:

- To protect your display from possible damage, do not put excessive pressure on the LCD panel. When moving your display, grasp the frame to lift; do not lift the display by placing your hands or fingers on the LCD panel.
- Unplug the display if you are not going to use it for an extensive period of time.
- Unplug the display if you need to clean it with a slightly damp cloth. The screen may be wiped with a dry cloth when the power is off. However, never use organic solvent, such as, alcohol, or ammonia-based liquids to clean your display.
- To avoid the risk of shock or permanent damage to the set, do not expose the display to dust, rain, water or an excessively moist environment.
- If your display becomes wet, wipe it with dry cloth as soon as possible.
- If a foreign substance or water gets in your display, turn off the power immediately and disconnect the power cord. Then remove the foreign substance or water, and send the unit to the maintenance center.
- Do not store or use the display in locations exposed to heat, direct sunlight or extreme cold.
- In order to maintain the best performance of your display and ensure a longer lifetime, we strongly recommend using the display in a location that falls within the following temperature and humidity ranges.

### Environmental absolute ratings

Item	Min.	Max.	Unit
Storage temperature	-20	60	°C
Operation temperature	0	40	°C
Glass Surface temperature (Operation)	0	65	°C
Storage humidity	5	95	% RH
Operating humidity	20	80	% RH

- LCD panel temperature need to be 25 degrees Celsius at all time for better luminance performance.
- Only the lifetime of the display stated in this specification is guaranteed if the display is used under the proper operation conditions.

**IMPORTANT:** Always activate a moving screen saver program when you leave your display unattended. Always activate a periodic screen refresh application if the unit will display unchanging static content. Uninterrupted display of still or static images over an extended period may cause “burn in”, also known as “after-imaging” or “ghost imaging”, on your screen. This is a well-known phenomenon in LCD panel technology. In most cases, the “burned in” or “after-imaging” or “ghost imaging” will disappear gradually over a period of time after the power has been switched off.

**WARNING:** Severe “burn-in” or “after-image” or “ghost image” symptoms will not disappear and cannot be repaired. This is also not covered under the terms of your warranty.

#### Service:

- The casing cover should be opened only by qualified service personnel.
- If there is any need for repair or integration, please contact your local service center.
- Do not leave your display under direct sunlight.



If your display does not operate normally, having followed the instructions set out in this document, please contact a technician or your local service center.

#### Stability Hazard.

The device may fall, causing serious personal injury or death. To prevent injury, this device must be securely attached to the floor/wall in accordance with the installation instructions.

#### Read and follow these instructions when connecting and using your display:



- Unplug the display if you are not going to use it for an extensive period of time.
- Unplug the display if you need to clean it with a slightly damp cloth. The screen may be wiped with a dry cloth when the power is off. However, never use alcohol, solvents or ammonia-based liquids.
- Consult a service technician if the display does not operate normally when you have followed the instructions in this manual.
- The casing cover should be opened only by qualified service personnel.
- Keep the display out of direct sunlight and away from stoves or any other heat sources.
- Remove any object that could fall into the vents or prevent proper cooling of the display's electronics.
- Do not block the ventilation holes on the cabinet.
- Keep the display dry. To avoid electric shock, do not expose it to rain or excessive moisture.
- When turning off the display by detaching the power cable or DC power cord, wait for 6 seconds before re-attaching the power cable or DC power cord for normal operation..
- To avoid the risk of shock or permanent damage to the set do not expose the display to rain or excessive moisture.
- When positioning the display, make sure the power plug and outlet are easily accessible.
- **IMPORTANT:** Always activate a screen saver program during your application. If a still image in high contrast remains on the screen for an extended period of time, it may leave an ‘after-image’ or ‘ghost image’ on the front of the screen. This is a well-known phenomenon that is caused by the shortcomings inherent in LCD technology. In most cases, the afterimage will disappear gradually over a period of time after the power has been switched off. Be aware that the after-image symptom cannot be repaired and is not covered under warranty.
- If provided with a 3-pin attachment plug on the power cord, plug the cord into a grounded (earthed) 3-pin outlet. Do not disable the power cord grounding pin, for example, by attaching a 2-pin adapter. The grounding pin is an important safety feature.

## EU Declaration of Conformity

This device complies with the requirements set out in the Council Directive on the Approximation of the Laws of the Member States relating to Electromagnetic Compatibility (2014/30/EU), Low-voltage Directive (2014/35/EU), RoHS Directive (2011/65/EU), 2024/1781 (ESPR regulation).

This product has been tested and found to comply with the harmonized standards for Information Technology Equipment, these harmonized standards published under Directives of Official Journal of the European Union.

### ESD Warnings

When user gets close to the monitor, may cause the equipment discharge and reboot to the display of main menu.

### Warning:

This equipment is compliant with Class A of EN55032/CISPR 32. In a residential environment this equipment may cause radio interference.

## Federal Communications Commission (FCC) Notice (U.S. Only)



**NOTE:** This equipment has been tested and found to comply with the limits for a Class A digital device, pursuant to part 15 of the FCC Rules. These limits are designed to provide reasonable protection against harmful interference when the equipment is operated in a commercial environment. This equipment generates, uses, and can radiate radio frequency energy and, if not installed and used in accordance with the instruction manual, may cause harmful interference to radio communications. Operation of this equipment in a residential area is likely to cause harmful interference in which case the user will be required to correct the interference at his own expense.



Changes or modifications not expressly approved by the party responsible for compliance could void the user's authority to operate the equipment.

Use only an RF shielded cable that was supplied with the display when connecting this display to a computer device.

To prevent damage which may result in fire or shock hazard, do not expose this appliance to rain or excessive moisture.

This device complies with Part 15 of the FCC Rules. Operation is subject to the following two conditions: (1) This device may not cause harmful interference, and (2) this device must accept any interference received, including interference that may cause undesired operation.

TPV USA Corp  
6525 Carnegie Blvd #200  
Charlotte, NC 28211  
USA

## Polish Center for Testing and Certification Notice

The equipment should draw power from a socket with an attached protection circuit (a three-prong socket). All equipment that works together (computer, display, printer, and so on) should have the same power supply source.

The phasing conductor of the room's electrical installation should have a reserve short-circuit protection device in the form of a fuse with a nominal value no larger than 16 amperes (A).

To completely switch off the equipment, the power supply cable must be removed from the power supply socket, which should be located near the equipment and easily accessible.

A protection mark "B" confirms that the equipment is in compliance with the protection usage requirements of standards PN-93/T-42107 and PN-89/E-06251.

### Wymagania Polskiego Centrum Badań i Certyfikacji

Urządzenie powinno być zasilane z gniazda z przyłączonym obwodem ochronnym (gniazdo z kołkiem). Współpracujące ze sobą urządzenia (komputer, monitor, drukarka) powinny być zasilane z tego samego źródła.

Instalacja elektryczna pomieszczenia powinna zawierać w przewodzie fazowym rezerwową ochronę przed zwarciami, w postaci bezpiecznika o wartości znamionowej nie większej niż 16A (amperów).

W celu całkowitego wyłączenia urządzenia z sieci zasilania, należy wyjąć wtyczkę kabla zasilającego z gniazdka, które powinno znajdować się w pobliżu urządzenia i być łatwo dostępne.

Znak bezpieczeństwa "B" potwierdza zgodność urządzenia z wymaganiami bezpieczeństwa użytkowania zawartymi w PN-93/T-42107 i PN-89/E-06251.

### Pozostałe instrukcje bezpieczeństwa

- Nie należy używać wtyczek adapterowych lub usuwać kołka obwodu ochronnego z wtyczki. Jeżeli konieczne jest użycie przedłużacza to należy użyć przedłużacza 3-żyłowego z prawidłowo połączonym przewodem ochronnym.
- System komputerowy należy zabezpieczyć przed nagłymi, chwilowymi wzrostami lub spadkami napięcia, używając eliminatora przepięć, urządzenia dopasowującego lub bezzakłócenowego źródła zasilania.
- Należy upewnić się, aby nic nie leżało na kablach systemu komputerowego, oraz aby kable nie były umieszczone w miejscu, gdzie można byłoby na nie nadeptywać lub potykać się o nie.
- Nie należy rozlewać napojów ani innych płynów na system komputerowy.
- Nie należy wpychać żadnych przedmiotów do otworów systemu komputerowego, gdyż może to spowodować pożar lub porażenie prądem, poprzez zwarcie elementów wewnętrznych.
- System komputerowy powinien znajdować się z dala od grzejników i źródeł ciepła. Ponadto, nie należy blokować otworów wentylacyjnych. Należy unikać kładzenia luźnych papierów pod komputer oraz umieszczania komputera w ciasnym miejscu bez możliwości cyrkulacji powietrza wokół niego.

## Electric, Magnetic and Electromagnetic Fields ("EMF")

1. We manufacture and sell many products targeted at consumers, which, like any electronic apparatus, in general have the ability to emit and receive electromagnetic signals.
2. One of our leading business principles is to take all necessary health and safety measures for our products, to comply with all applicable legal requirements and to stay well within the EMF standards applicable at the time of producing the products.
3. We are committed to develop, produce and market products that cause no adverse health effects.
4. We confirm that if its products are handled properly for their intended use, they are safe to use according to scientific evidence available today.
5. We play an active role in the development of international EMF and safety standards, enabling us to anticipate further developments in standardization for early integration in its products.

## Information for U.K. only

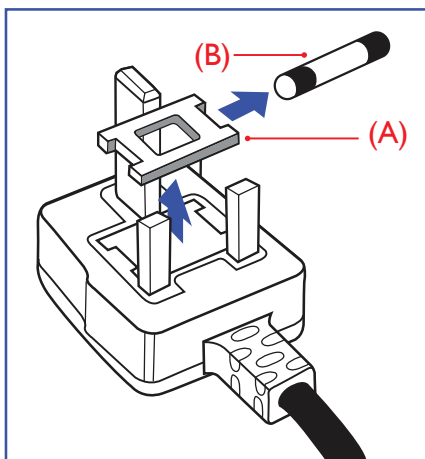

### WARNING - THIS APPLIANCE MUST BE EARTHED.

#### Important:

This apparatus is supplied with an approved moulded 13A plug. To change a fuse in this type of plug proceed as follows:+

1. Remove fuse cover and fuse.
2. Fit new fuse which should be a BS 1362 5A, A.S.T.A. or BSI approved type.
3. Refit the fuse cover.

If the fitted plug is not suitable for your socket outlets, it should be cut off and an appropriate 3-pin plug fitted in its place.

If the main plug contains a fuse, this should have a value of 5A. If a plug without a fuse is used, the fuse at the distribution board should not be greater than 5A.

Note: The severed plug must be destroyed to avoid a possible shock hazard should it be inserted into a 13A socket elsewhere.

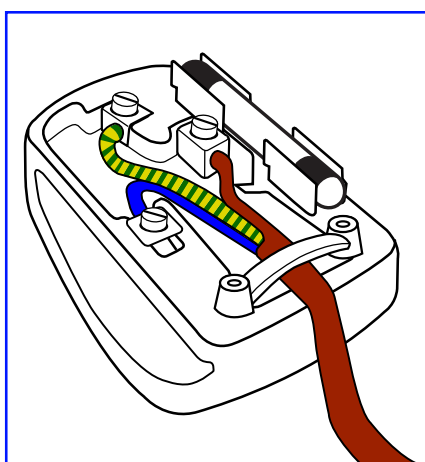

### How to connect a plug

The wires in the mains lead are coloured in accordance with the following code:

BLUE - "NEUTRAL" ("N")

BROWN - "LIVE" ("L")

GREEN & YELLOW - "EARTH" ("E")

1. The GREEN & YELLOW wire must be connected to the terminal in the plug which is marked with the letter "E" or by the Earth symbol or coloured GREEN or GREEN & YELLOW.
2. The BLUE wire must be connected to the terminal which is marked with the letter "N" or coloured BLACK.
3. The BROWN wire must be connected to the terminal which marked with the letter "L" or coloured RED.

Before replacing the plug cover, make certain that the cord grip is clamped over the sheath of the lead - not simply over the three wires.

## North Europe (Nordic Countries) Information

Placering/Ventilation

#### VARNING:

FÖRSÄKRA DIG OM ATT HUVUDBRYTARE OCH UTTAG ÄR LÄTÅTKOMLIGA, NÄR DU STÄLLER DIN UTRUSTNING PÅPLATS.

Placering/Ventilation

#### ADVARSEL:

SØRG VED PLACERINGSFOR, AT NETLEDNINGENS STIK OG STIKKONTAKT ER NEMT TILGÆNGELIGE.

Paikka/Ilmankierto

#### VAROITUS:

SIJOITA LAITE SITEN, ETTÄ VERKKOJOHTO VOIDAAN TARVITTAESSA HELPOSTI IRROTTAA PISTORASIESTA.

Plassering/Ventilasjon

#### ADVARSEL:

NÅR DETTE UTSTYRET PLASSERES, MÅ DU PASSE PÅ AT KONTAKTENE FOR STØMTILFØRSEL ER LETTE Å NÅ.

## 中国 RoHS

根据中国大陆《电器电子产品有害物质限制使用管理办法》，以下部分列出了产品中有害物质的名称及含有信息表。

因型号不同，产品可能不包含以下部分部件，请以产品实际销售配置为准。

产品中有害物质的名称及含有信息表

部件名称	有害物质									
	铅 (Pb)	汞 (Hg)	镉 (Cd)	六价铬 (Cr (VI))	多溴联苯 (PBBs)	多溴二苯 醚 (PBDEs)	邻苯二甲 酸二(2- 乙基)己 酯 (DEHP)	邻苯二甲 酸丁 苄酯 (BBP)	邻苯二甲 酸二 正丁酯 (DBP)	邻苯二甲 酸二异丁 酯 (DIBP)
外壳	○	○	○	○	○	○	○	○	○	○
液晶显示屏	×	○	○	○	○	○	○	○	○	○
电路板组件 *	×	○	○	○	○	○	○	○	○	○
电源适配器	×	○	○	○	○	○	○	○	○	○
电源线 / 连接线	×	○	○	○	○	○	○	○	○	○
遥控器	X	○	○	○	○	○	○	○	○	○

注 1:  
\*： 电路板组件包括印刷电路板及其构成的零部件，如电阻、电容、集成电路、连接器等。  
O： 表示该有害物质在该部件所有均质材料中的含量均不超出电器电子产品有害物质限制使用国家标准要求。  
X： 表示该有害物质至少在该部件的某一均质材料中的含量超出电器电子产品有害物质限制使用国家标准要求。  
注 2： 以上未列出的部件，表明其有害物质含量均不超出电器电子产品有害物质限制使用国家标准要求。



### 环保使用期限

此标识指期限(十年)，电子电气产品中含有的有害物质在正常使用的条件下不会发生外泄或突变，电子电气产品用户使用该电子电气产品不会对环境造成严重污染或对其人身、财产造成严重损害的期限。

### 《废弃电器电子产品回收处理管理条例》提示性说明

为了更好地关爱及保护地球，当用户不再需要此产品或产品寿命终止时，请遵守国家废弃电器电子产品回收处理相关法律法规，将其交给当地具有国家认可的回收处理资质的厂商进行回收处理，不当利用或者处置可能会对环境对人类健康造成影响。

警告：在居住环境中，运行此设备可能会造成无线电干扰。

警語: 使用過度恐傷害視力。

注意事項:

(1) 使用30分鐘請休息10分鐘。

(2) 未滿2歲幼兒不看螢幕，2歲以上每天看螢幕不要超過1小時。

警告使用者:

此為甲類資訊技術設備,於居住環境中使用時,可能會造成射頻擾動,在此種情況下,使用者會被要求採取某些適當的對策。

警告：為避免電磁干擾，本產品不應安裝或使用於住宅環境。

### **Turkey RoHS:**

Türkiye Cumhuriyeti: EEE Yönetmeliğine Uygundur

### **Ukraine RoHS:**

Обладнання відповідає вимогам Технічного регламенту щодо обмеження використання деяких небезпечних речовин в електричному та електронному обладнанні, затвердженого постановою Кабінету Міністрів України від 3 грудня 2008 № 1057

### **End-of-Life Disposal**

Your new Public Information Display contains materials that can be recycled and reused. Specialized companies can recycle your product to increase the amount of reusable materials and to minimize the amount to be disposed of.

Please find out about the local regulations on how to dispose of your old display from your local Philips dealer.

#### **(For customers in Canada and U.S.A.)**

This product may contain lead and/or mercury. Dispose of in accordance to local-state and federal regulations. For additional information on recycling contact [www.eia.org](http://www.eia.org) (Consumer Education Initiative)

## Waste Electrical and Electronic Equipment-WEEE

### Attention users in European Union private households

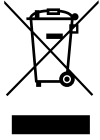

This marking on the product or on its packaging illustrates that, under European Directive 2012/19/EU governing used electrical and electronic appliances, this product may not be disposed of with normal household waste. You are responsible for disposal of this equipment through a designated waste electrical and electronic equipment collection. To determine the locations for dropping off such waste electrical and electronic, contact your local government office, the waste disposal organization that serves your household or the store at which you purchased the product.

### Attention users in United States:

Please dispose of according to all Local, State and Federal Laws. For the disposal or recycling information, contact: [www.mygreenelectronics.com](http://www.mygreenelectronics.com) or [www.eiae.org](http://www.eiae.org).

### End of Life Directives-Recycling



Your new Public Information Display contains several materials that can be recycled for new users.

Please dispose of according to all Local, State, and Federal laws.

ENERGY STAR is a program run by the U.S. Environmental Protection Agency (EPA) and U.S. Department of Energy (DOE) that promotes energy efficiency.



This product qualifies for ENERGY STAR in the "factory default" settings and this is the setting in which power savings will be achieved.

Changing the factory default picture settings or enabling other features will increase power consumption that could exceed the limits necessary to qualify for ENERGY STAR rating.

For more information on the ENERGY STAR program, refer to [energystar.gov](http://energystar.gov).

### Restriction on Hazardous Substances statement (India)

This product complies with the "E-Waste (Management) Rules, 2016" CHAPTER V, rule 16, sub-rule (1) . Whereas New Electrical and Electronic Equipment and their components or consumables or parts or spares do not contain Lead, Mercury, Cadmium, Hexavalent Chromium, polybrominated biphenyls and polybrominated diphenyl ethers beyond a maximum concentration value of 0.1% by weight in homogenous materials for lead, mercury, hexavalent chromium, polybrominated biphenyls and polybrominated diphenyl ethers and of 0.01% by weight in homogenous materials for cadmium. except of exemptions set in Schedule 2 of the Rule.

### E-Waste Declaration for India

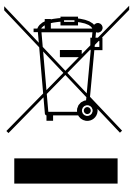

This symbol on the product or on its packaging indicates that this product must not be disposed of with your other household waste. Instead it is your responsibility to dispose of your waste equipment by handing it over to a designated collection point for the recycling of waste electrical and electronic equipment . The separate collection and recycling of your waste equipment at the time of disposal will help to conserve natural resources and ensure that it is recycled in a manner that protects human health and the environment. For more information about E -waste please visit <http://www.india.philips.com/about/sustainability/recycling/index.page> and to know where you can drop off your waste equipment for recycling in India please contact on below given contact details.

Helpline number: 1800-425-6396 (Monday to Saturday, 9 a.m. to 5:30 pm)

E-mail: [india.callcentre@tpv-tech.com](mailto:india.callcentre@tpv-tech.com)

## Batteries



For EU: The crossed-out wheeled bin implies that used batteries should not be put to the general household waste! There is a separate collection system for used batteries, to allow proper treatment and recycling in accordance with legislation.

Please contact your local authority for details on the collection and recycling schemes.

For Switzerland: The used battery is to be returned to the selling point.

For other non-EU countries: Please contact your local authority for correct method of disposal of the used battery.

According to EU PPWR Regulation (EU) 2025/40, the battery can't be disposed improperly. The battery shall be separated to collect by local service.



Após o uso, as pilhas e/ou baterias deverão ser entregues ao estabelecimento comercial ou rede de assistência técnica autorizada.

## 2. Unpacking and Installation

### 2.1. Unpacking

- This product is packed in a carton, together with the standard accessories.
- Any other optional accessories will be packed separately.
- As this product is high and heavy, the operation of moving the device is recommended to be performed by two technicians.
- After opening the carton, ensure that the contents are complete and in good condition.

#### ■ Before Unpacking

- Please read and fully understand unpacking notice before installation.
- Check the condition of the package. Make sure the package is not damaged.
- Please do necessary inspection before you move the display out of the carton.
- Always install the display by experienced technician to prevent any damage.

#### ■ Notice

- Take the display out of the carton box by two adults with both hands.
- Hold the handles.

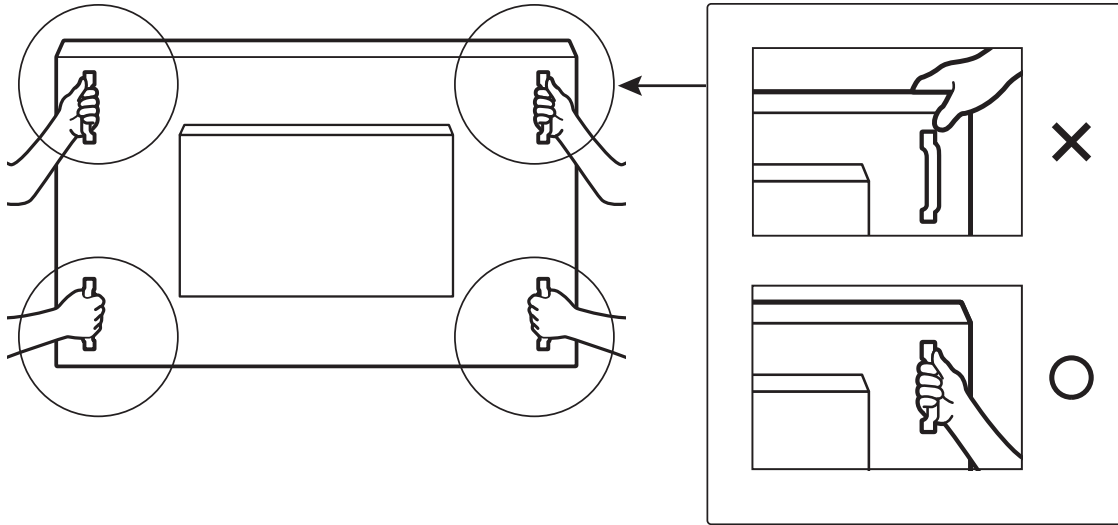

- Please do not grab bezel edge of the display.

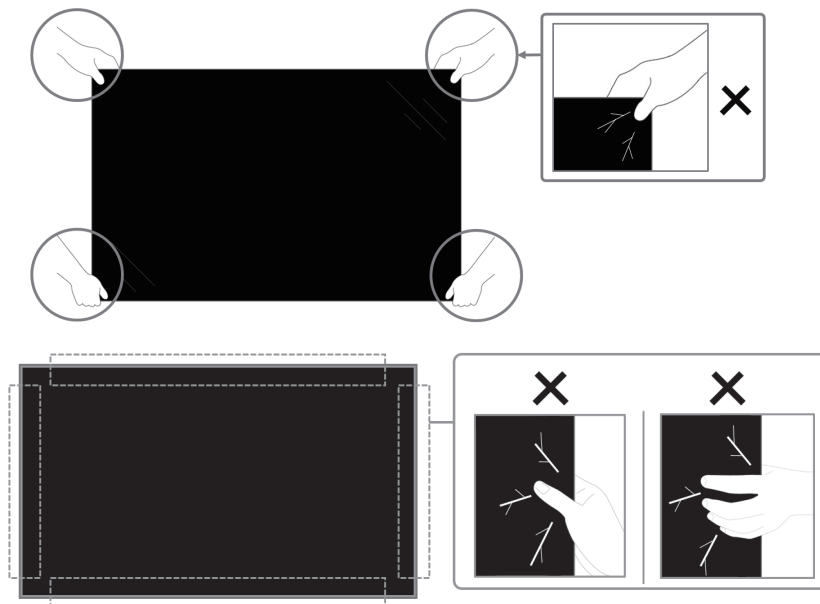

- Please keep the display in a vertical position when moving it.

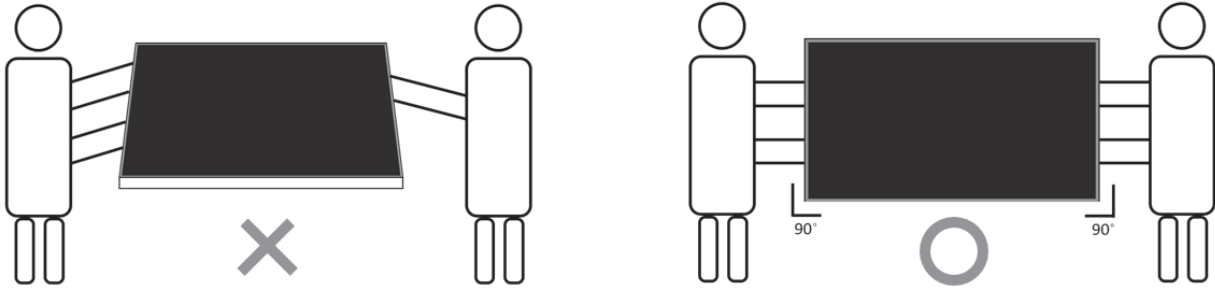

- Place the display vertically and its weight should spread evenly on the surface.

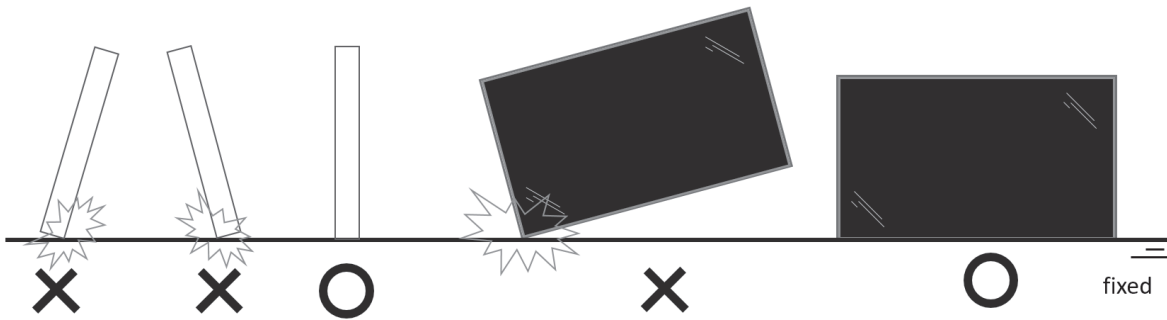

- Avoid bending and torsion during transportation.

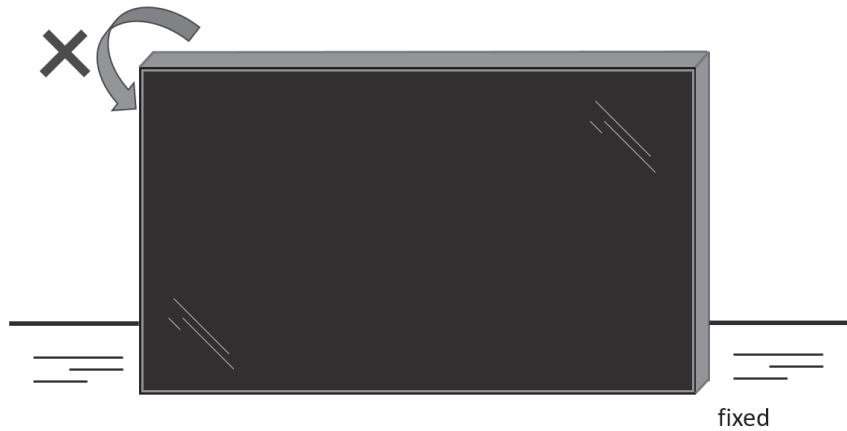

## 2.2. Unpacking Inspection Instructions

- Read the inspection instructions before opening the packaging. (The inspection instructions are printed on the top of the box).
- Ensure the product is in good condition prior to the removal of sealing labels, or the warranty will be void.

(1).Open the carton, take out the accessory pack and top cushion.

(2).Remove the plastic carton locker.

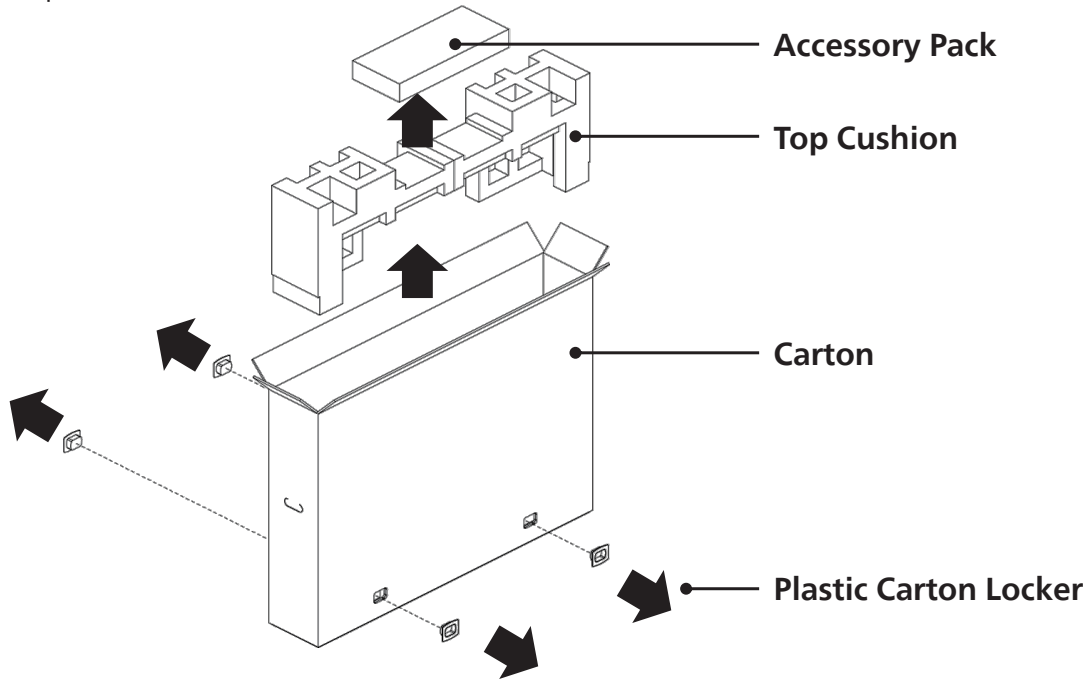

(3).Remove the top carton carefully. Another person should hold the display carefully. If this is not observed, the display may drop.

(4).Remove the front cushion board.

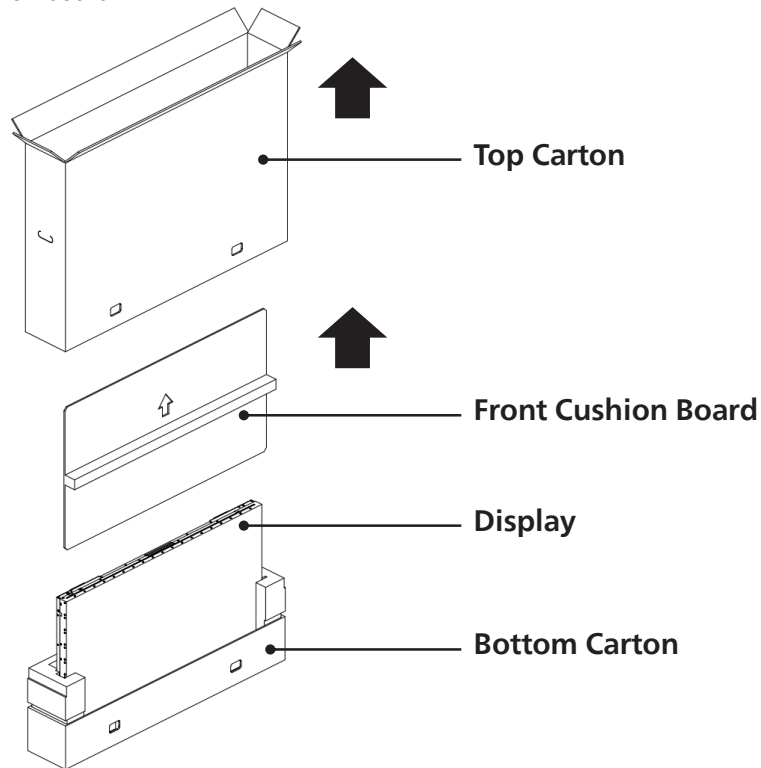

(5). Connect the power cord to the back of the display. Plug the other end of the power cord into an electric outlet to power on the display.

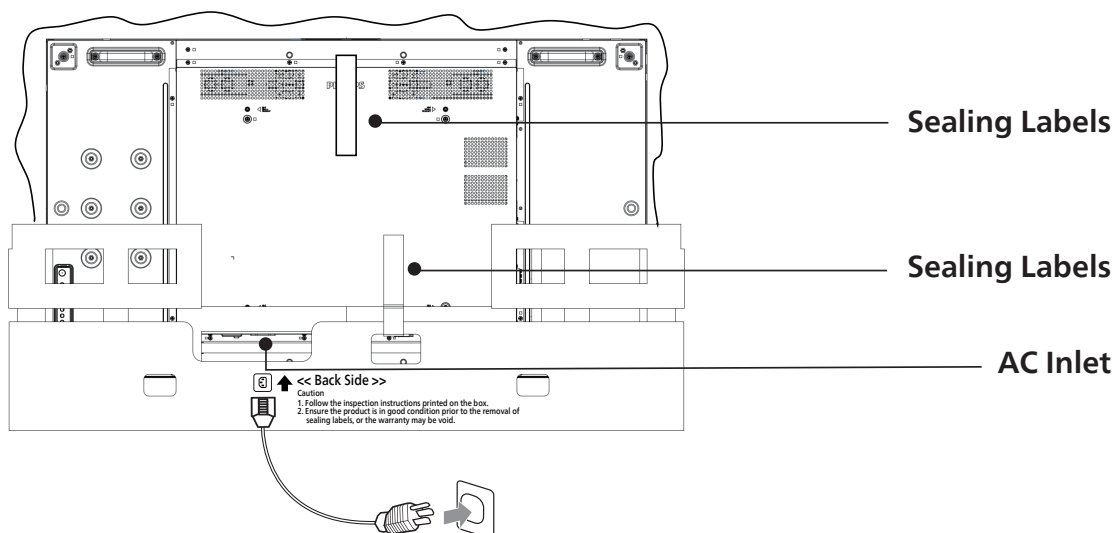

(6). The display will initiate a white screen test. Carefully inspect the screen for abnormalities, especially the four corners of the display.

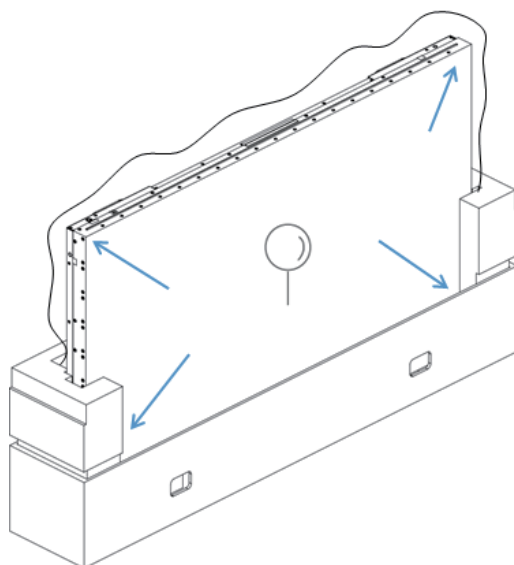

(7). If no damage is found, cut the sealing labels.

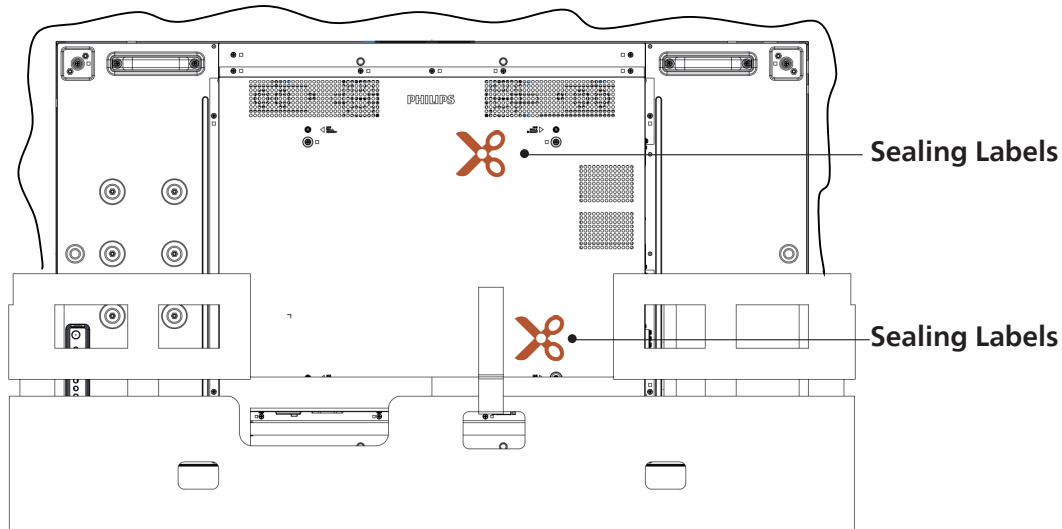

(8).Install the Wall Mount Kit.

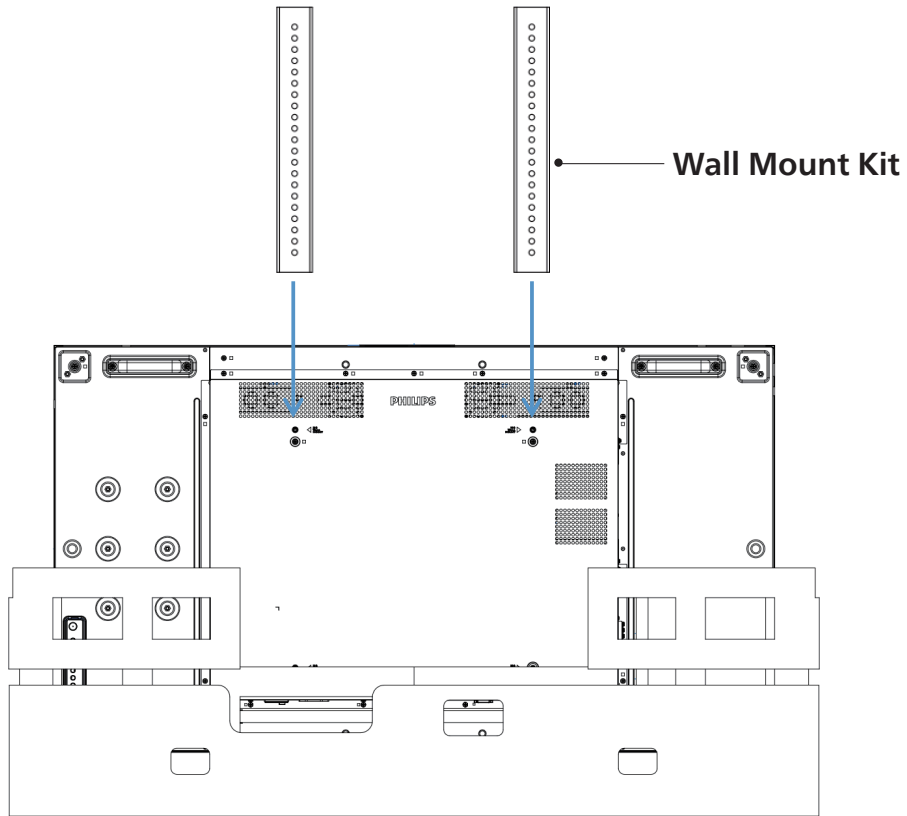

(9).Mount the display to the wall.

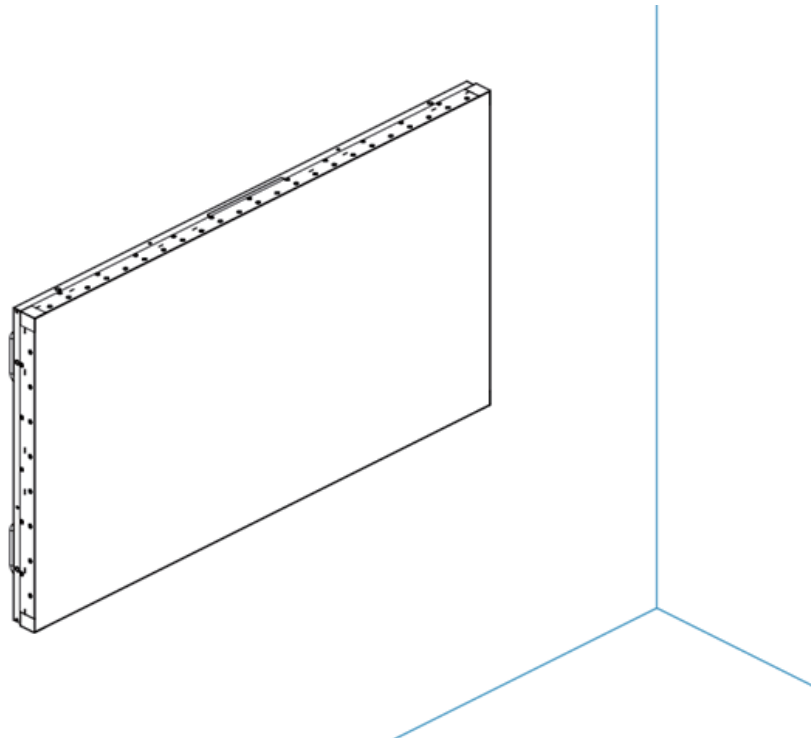

## 2.3. Package Contents

Please verify that you received the following items with your package content:

- LCD Display
- Remote Control and AAA Batteries (Battery availability may vary by region)
- Quick Start Guide
- Power Cord
- Display Port Cable
- IR Sensor Cable
- Edge Alignment Kit-1: 1PCS
- Edge Alignment Kit-2: 2PCS
- Edge Alignment Pin: 2PCS
- DB9(female) to RJ12/45 Adaptor
- RJ45 Cable for Daisy Chain
- Gap Mylar: 3 PCS

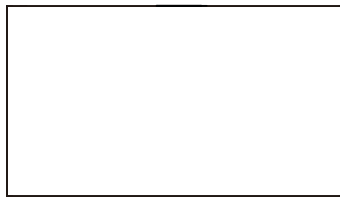

LCD Display

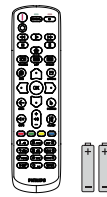

Remote Control and AAA Batteries (Battery availability may vary by region)



Quick Start Guide

\* The supplied power cord varies depending on destination.



Power Cord



Display Port Cable

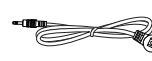

IR Sensor Cable



Edge Alignment Kit-1

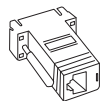

DB9(female) to RJ12/45 Adaptor



RJ45 Cable for Daisy Chain



Edge Alignment Pin X 2 PCS



Edge Alignment Kit-2 X 2 PCS



Gap Mylar X 3 PCS

\* Differences according to regions.

Display design and accessories may differ from those illustrated above.

### NOTES:

- For all other regions, apply a power cord that conforms to the AC voltage of the power socket and has been approved by and complies with the safety regulations of the particular country.
- You might like to save the package box and packing material for shipping the display.

## 2.4. Installation Notes

- Only use the power cable provided with this product. If an extension cord is required, please consult your service agent.
- The product should be installed on a flat surface, or the product may tip over. Leave a space between the rear of the product and the wall for proper ventilation. Do not install the product in a kitchen, bathroom or a place exposed to moisture, failure to do so may shorten the life of the internal parts.
- Do not install the product where it is 3000m and higher in altitude. Failure to do so may result in malfunctions.

## 2.5. Mounting on a Wall

To mount this display on a wall, a standard wall-mounting kit (commercially available) is required. It is recommended that you use a mounting interface that complies with TUV-GS and /or UL1678 standard in North America.

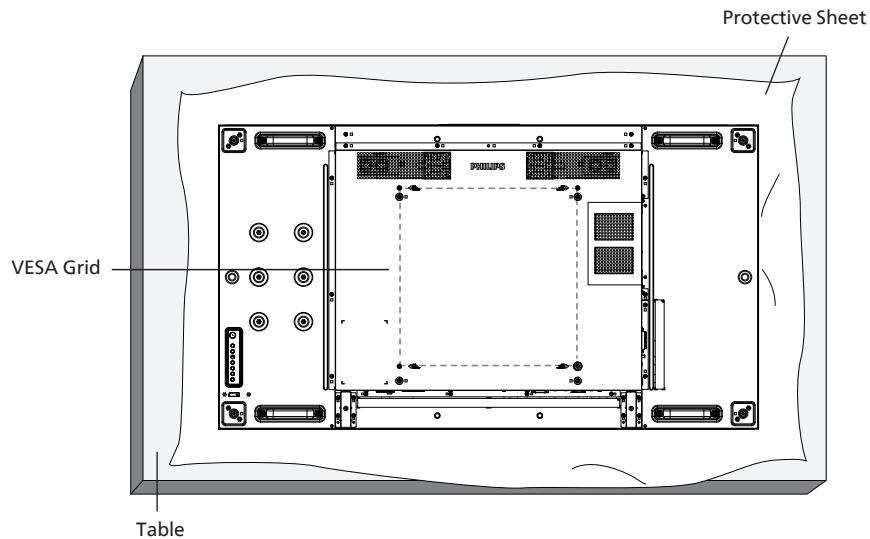

1. Spread a protective sheet which was wrapped around the display when it was packed on a flat surface. Lay the display face-down on the protective sheet to facilitate your operation without scratching the screen.
2. Ensure that you have all accessories necessary for any type of mounting (wall-mounting, ceiling mounting etc).
3. Follow the instructions that come with the base mounting kit. Failure to follow correct mounting procedures could result in damage to the equipment or injury to the user or installer. Product warranty does not cover damage caused by improper installation.
4. For the wall-mounting kit, use M6 mounting screws (with a length 10 mm longer than the thickness of the mounting bracket) and tighten them securely.

### 2.5.1. VESA Grid

55BDL8107X	400(H) x 400(V) mm
------------	--------------------

#### Caution:

To prevent the display from falling:

- For wall or ceiling mounting, we recommend that you install the display with metal brackets which are commercially available. For detailed instructions about the installation, refer to the guide that come with the bracket.
- To prevent the display from falling in case of earthquake or other natural disaster, please contact the manufacturer of the bracket for the mounting location.

#### Required space for ventilation

Leave a space of 100 mm at the top, rear, right and left for ventilation.

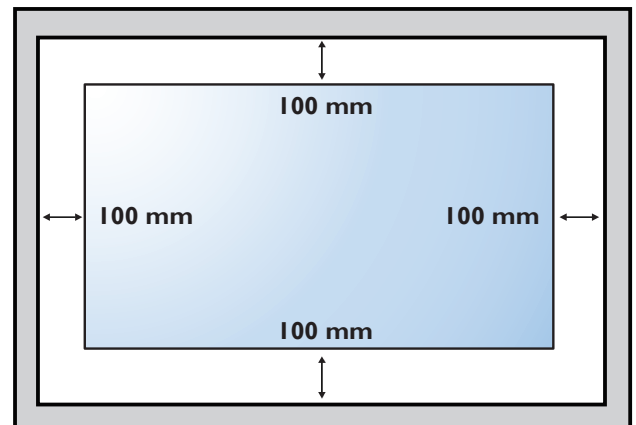

## 2.6. Mounting in Portrait Orientation

This display can be installed in portrait orientation.

Rotate the display 90 degrees counterclockwise based on the back view. The "PHILIPS" LOGO should be on the LEFT side when facing the backside of the display.

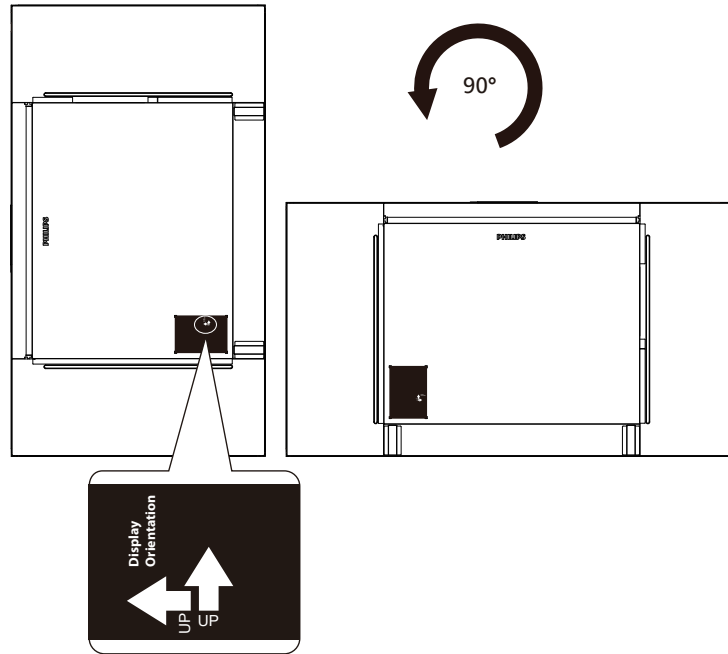

## 2.7. Operating Instructions of Edge Alignment Kit

### 2.7.1. Installing the Edge Alignment Kit

- Before installing the edge alignment kit, the display must be mounted to the frame of video wall correctly.
- We recommend you contact a professional technician when installing the edge alignment kit. We are not responsible for any damage to the product if the installation is not performed by a professional technician.
- Use the provided thumb screw for an easy installation of the edge alignment kit.
- Use the "Edge Alignment Kit-1" for four adjacent displays.

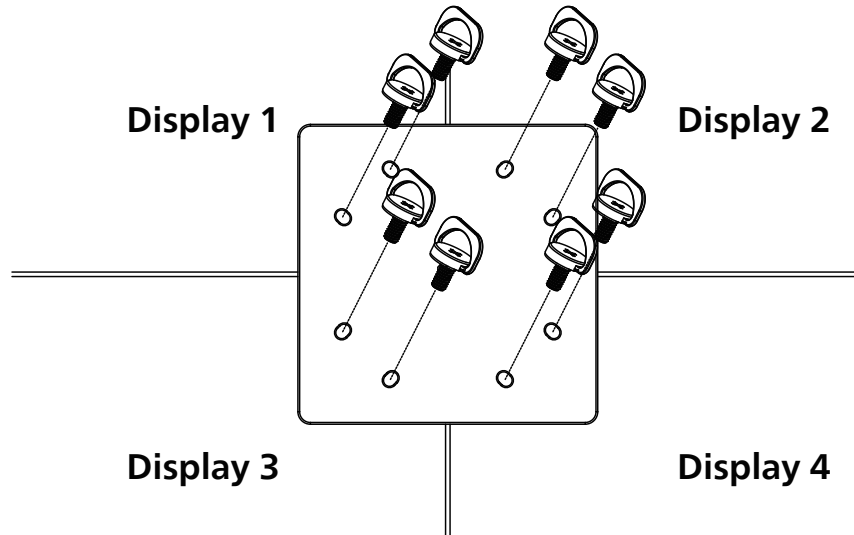

- Use the "Edge Alignment Kit-2" for two adjacent displays.

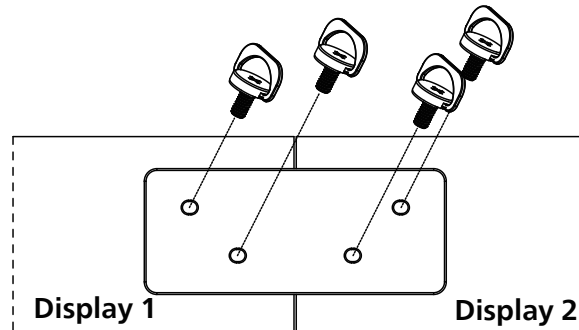

Note: When installing the edge alignment kit, please consult a professional technician for proper installation. We accept no liability for installations not performed by a professional technician.

## 2.8. Using the Edge Finishing Kit (Optional)

You could use the edge finishing kit to protect the display and have a better appearance.

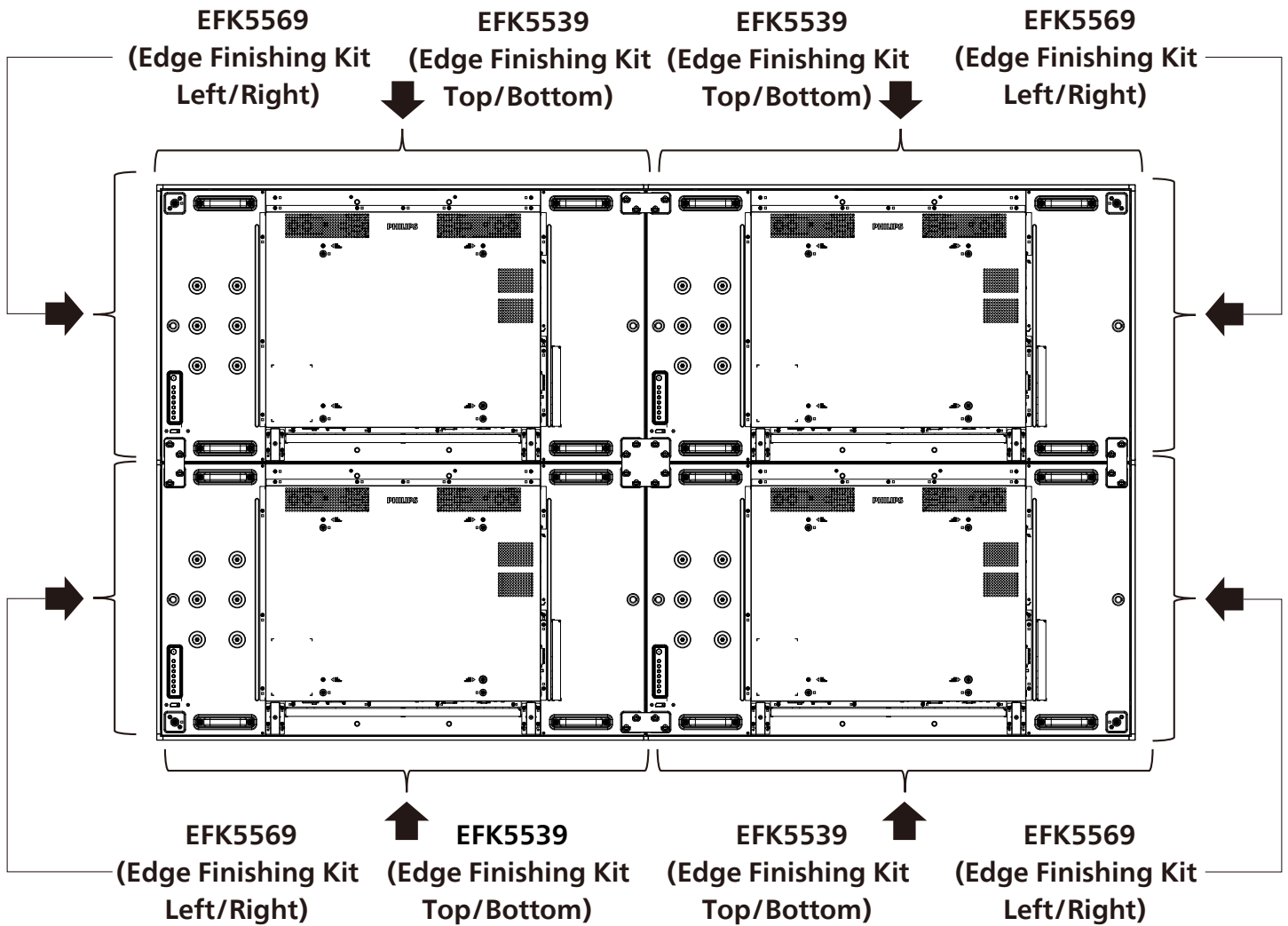

\* For more detailed information, please check the instruction guide in the package of kit.

## 2.9. Using the Gap Pad

Use the gap pad to ensure appropriate space between cascaded displays during video wall installation.

1. Remove the release sheet from the gap pad.

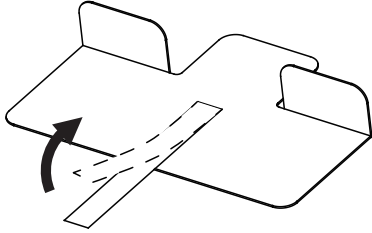

2. Stick the gap pad to the top surface of the display where another display will be stacked. Apply 2 gap pads on the top surface.

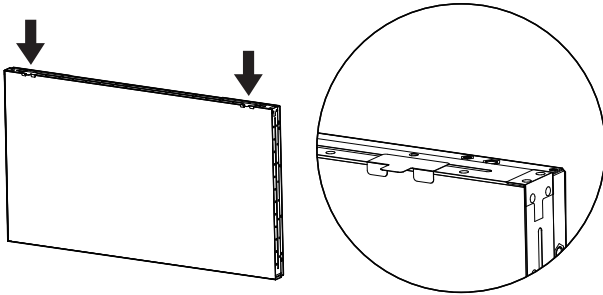

3. Install the top display carefully. After the displays are mounted, make sure you leave enough space between displays for removing the gap pad. If the pad is hard to release, adjust the position of the display to get enough space.

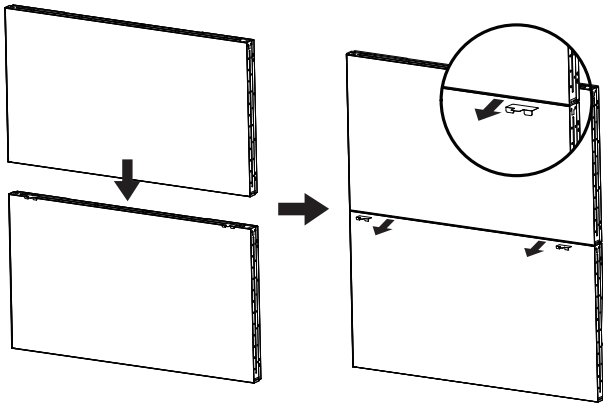

4. Apply another gap pad on the side surface and repeat the same process as step 3.

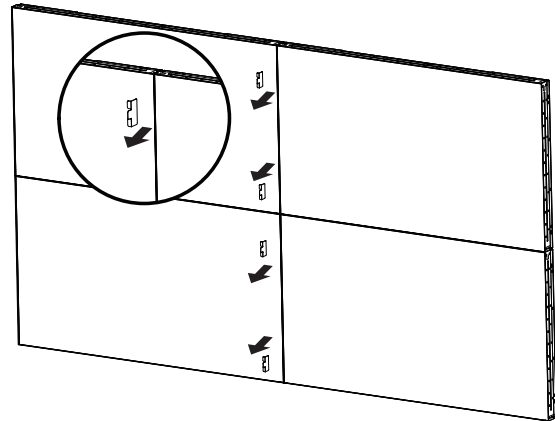
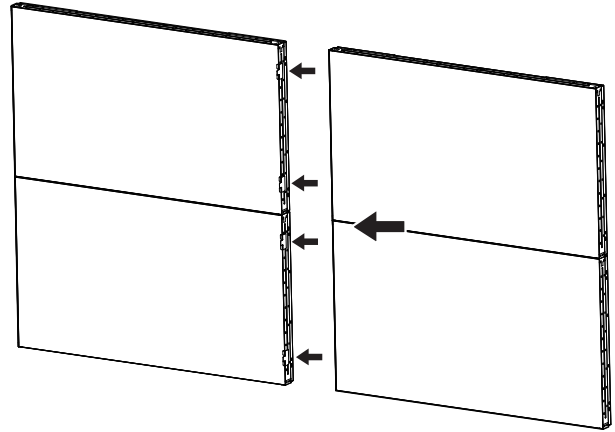

## 3. Parts and Functions

### 3.1. Control Panel

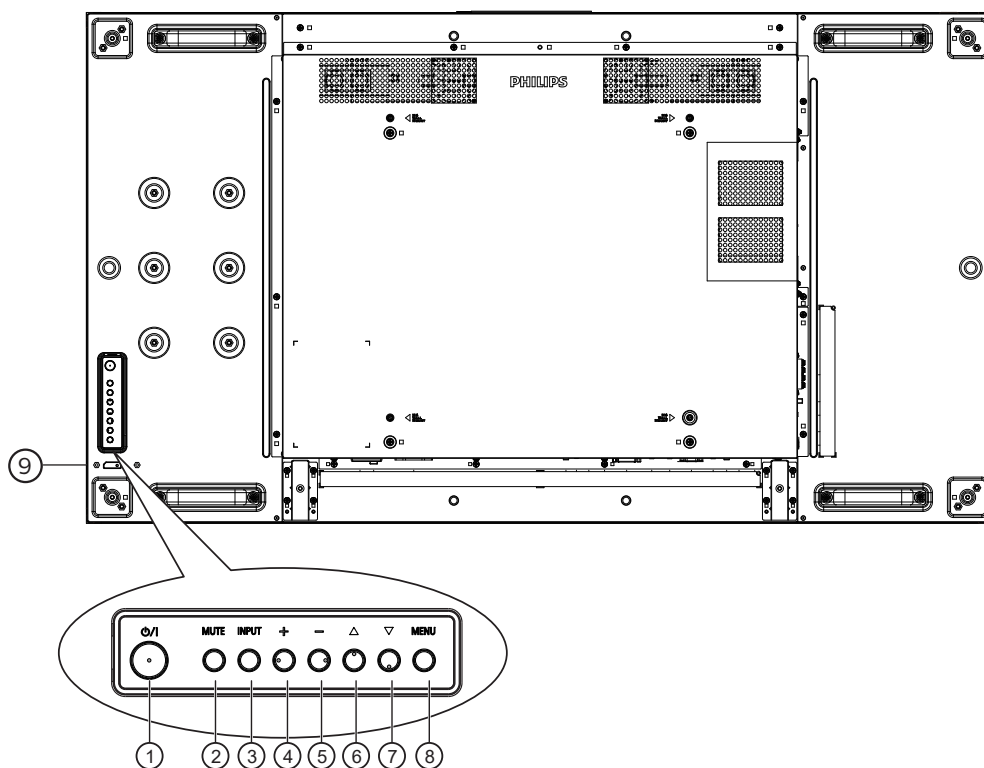

#### ① [Power] button

Press this button to turn the display on or turn the display to standby mode.

#### ② [MUTE] button

Press this button to mute the sound or reactivate sound.

#### ③ [INPUT] button

Choose the input source.

Confirm a selection in the OSD menu.

#### ④ [+] button

Increase the adjustment while OSD menu is on, or increase the audio output level while OSD menu is off.

#### ⑤ [-] button

Decrease the adjustment while OSD menu is on, or decrease the audio output level while OSD menu is off.

#### ⑥ [▲] button

Move the selected item one level up while the OSD menu is On.

#### ⑦ [▼] button

Move the selected item one level down while the OSD menu is on.

#### ⑧ [MENU] button

Return to the previous menu while the OSD menu is on. This button can also be used to activate the OSD menu when the OSD menu is off.

#### ⑨ Remote control sensor and power status indicator

- Receives command signals from the remote control.
- Indicates the operating status of the display:
  - Lights green when the display is turned on.
  - Lights red when the display is in standby mode.
  - Lights amber when the display enters APM mode.
  - When {SCHEDULE} is enabled, the light green blinks and red always on.
  - If the light blinks red, it indicates that a failure has been detected.
  - Lights off when the main power of the display is turned off.

## 3.2. Input/Output Terminals

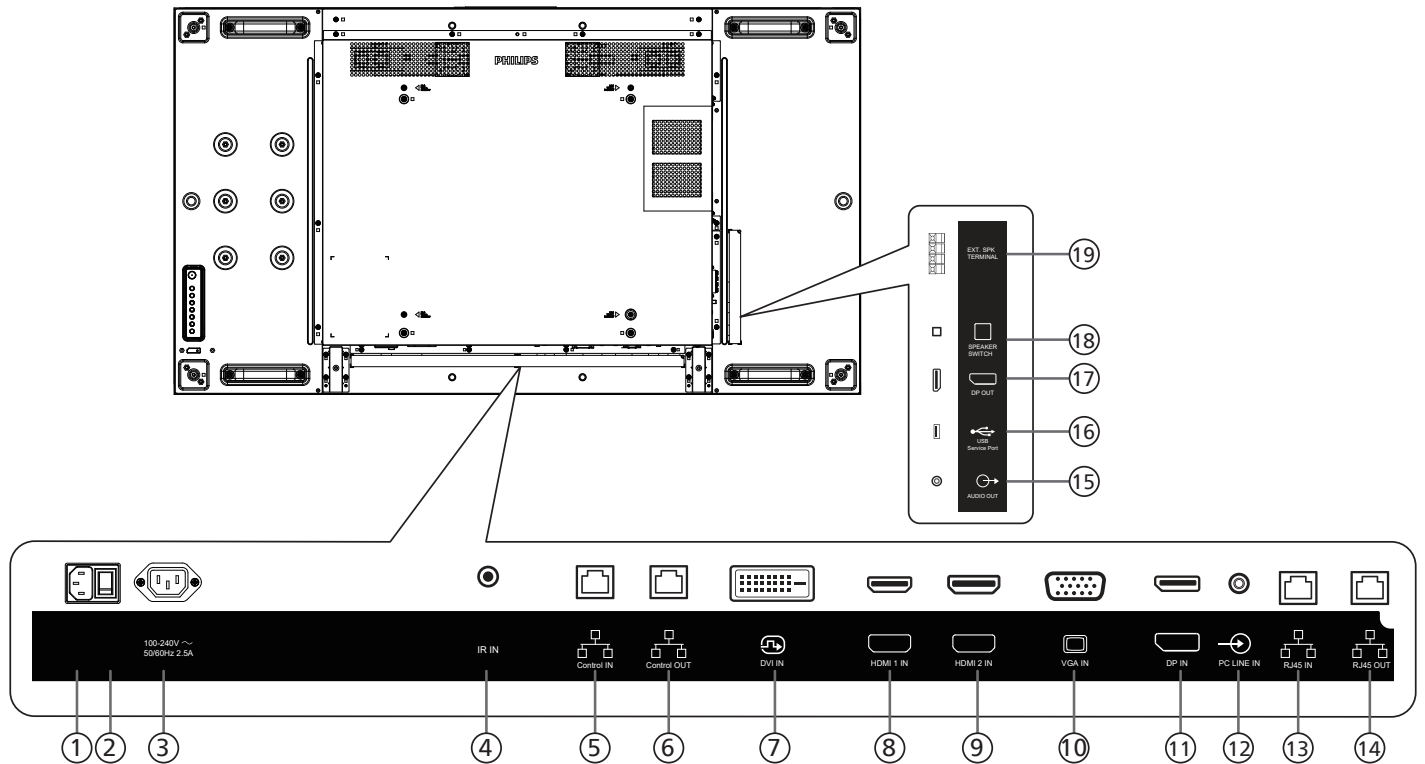

- ① **AC IN**  
AC power input from the wall outlet.
- ② **MAIN POWER SWITCH**  
Switch the main power between On and Off.
- ③ **AC OUT**  
AC power supply to the AC IN jack of a media player.
- ④ **IR IN**  
IR signal input for the loop-through function.
- NOTES:**
- This display's remote control sensor will stop working if the jack [IR IN] is connected.
- ⑤ **Control IN/ ⑥ Control OUT**  
There are RS232 and IR signals built into RJ45 connector for control pass through function.
- ⑦ **DVI IN**  
DVI video input.
- ⑧ **HDMI 1 IN / ⑨ HDMI 2 IN**  
HDMI video/audio input.
- ⑩ **VGA IN (D-Sub)**  
VGA video input.
- ⑪ **DisplayPort IN**  
DisplayPort video input.
- ⑫ **PC LINE IN**  
Audio input for VGA source (3.5mm stereo phone).
- ⑬ **RJ45 IN/ ⑭ RJ45 OUT**  
LAN control function for the use of remote control signal from control center.
- ⑮ **AUDIO OUT**  
Audio output to external AV device.
- ⑯ **USB Service Port**  
Connect your USB storage device.
- ⑰ **DisplayPort OUT**  
DisplayPort video output.
- ⑱ **SPEAKER SWITCH**  
Internal speaker on/off switch.
- ⑲ **SPEAKERS OUT**  
Audio output to external speakers.

### 3.3. Remote Control

#### 3.3.1. General Functions

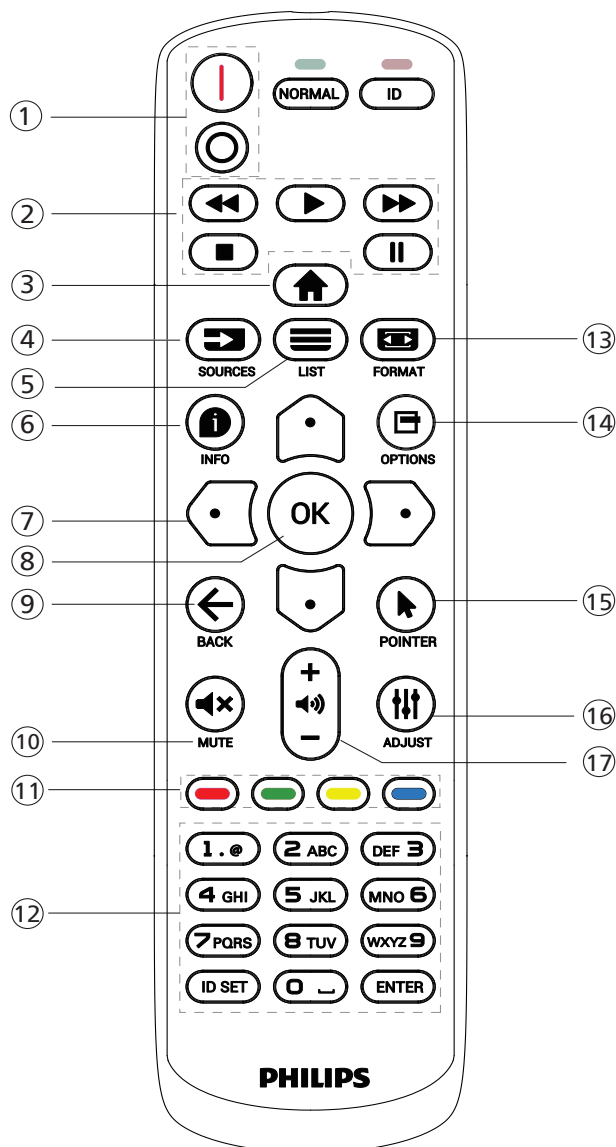

- ⑥ **[i] INFO button**  
Display information about current activity
- ⑦ **[<] [▶] [◀] [▶] NAVIGATION buttons**  
Navigate through menus and choose items..
- ⑧ **[OK] button**  
Confirm an entry or selection.
- ⑨ **[←] BACK button**  
Return to the previous menu page or exit from the previous function.
- ⑩ **[🔇] MUTE button**  
Press to turn the mute function on/off.
- ⑪ **[red] [green] [yellow] [blue] COLOR buttons**  
Reserved
- ⑫ **[NUMERIC] buttons**  
Enter text for network setting, and set up ID for ID mode
- ⑬ **[📺] FORMAT button**  
Change zoom mode.
- ⑭ **[📁] OPTIONS button**  
Access currently available options, picture and sound menus.
- ⑮ **[👉] POINTER button**  
Reserved
- ⑯ **[🔊] ADJUST button**  
Access currently available options, picture and sound menus.
- ⑰ **[−] [+] VOLUME button**  
Adjust the volume.

- ① **[|/o] POWER button**  
[|] Turn the power On.  
[o] Turn the power Off.
- ② **[PLAY] buttons**  
Fast Rewind/Play/Fast forward/Stop/Pause.
- ③ **[🏠] HOME button**  
Access the OSD menu.
- ④ **[📺] SOURCE button**  
Choose input source. Press [🏠] or [📺] button to choose from **USB, Network, HDMI 1, HDMI 2, DisplayPort, DVI-D, VGA**. Press [OK] button to confirm and exit.
- ⑤ **[≡] LIST button**  
Reserved.

### 3.3.2. ID Remote Control

Set remote control ID number when using several displays.

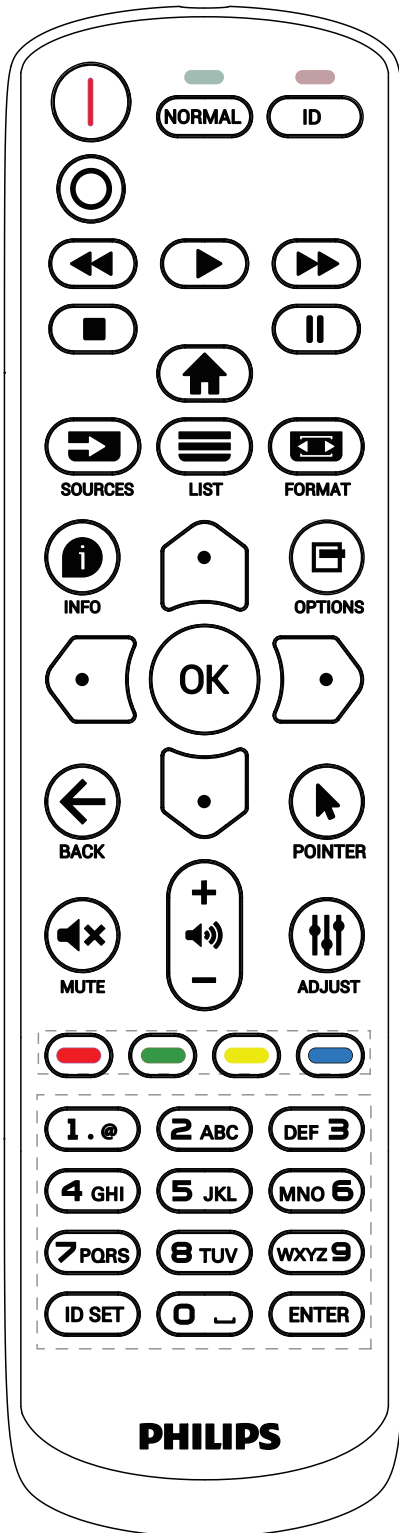

Press [ID] button. The red LED blinks twice.

1. Press [ID SET] button for more than 1 second to enter the ID Mode. The red LED lights up. Press the [ID SET] button again to exit from ID mode. The red LED lights off.

Press the digit numbers [0] ~ [9] to select the display you want to control.

For example: press [0] and [1] for display No.1, press [1] and [1] for display No.11.

The numbers available are from [01] ~ [255].

2. Not pressing any button within 10 seconds will exit the ID Mode.
3. If a wrong button is pressed, wait 1 second after the red LED lights off and then lights up again, then press the correct digits again.
4. Press [ENTER] button to confirm. The red LED blinks twice and then lights off.

#### NOTE:

- Press [NORMAL] button. The green LED blinks twice, indicating the display is in normal operation.
- It is necessary to set up the ID number for each display before selecting its ID number.
- Use "||" (pause) key on the remote control to freeze the screen. Use "▶" (play) key on the remote control to unfreeze the screen.
- The "freeze" feature only can be adopted on "real" video sources like VGA, HDMI, DVI, DP.
- Any operation on the remote control or video mode change will unfreeze the screen.

### 3.3.3. Inserting the Batteries in the Remote Control

The remote control is powered by two 1.5V AAA batteries.

To install or replace batteries:

1. Press and then slide the cover to open it.
2. Insert batteries with the correct polarity (+) and (-).
3. Replace the cover.

#### Caution:

Incorrect use of batteries may cause leakage or explosion. Be sure to follow the instructions below:

- Insert "AAA" batteries with the correct polarity (+ and -).
- Do not mix battery types.
- Do not use a new battery with a used one together. Otherwise, it may cause leakage or shorten the life of the batteries.
- Remove the dead batteries immediately to avoid battery leakage in the battery compartment. Do not touch exposed battery acid, as it may cause injury to your skin.
- Disposal of a battery into fire or a hot oven, or mechanically crushing or cutting of a battery, that can result in an explosion; leaving a battery in an extremely high temperature surrounding environment that can result in an explosion or the leakage of flammable liquid or gas; and a battery subjected to extremely low air pressure that may result in an explosion or the leakage of flammable liquid or gas.

Note: Remove the batteries from the battery compartment when not using for an extended period of time.

### 3.3.4. Handling the Remote Control

- Do not drop or apply shock to the remote control.
- Do not allow any liquid to get inside the remote control. If water has entered the remote control, wipe the remote control with a dry cloth immediately.
- Do not place the remote control near heat and steam sources.
- Do not attempt to disassemble the remote control, unless you need to place batteries in the remote control.

### 3.3.5. Operating Range of the Remote Control

Pointing the remote control at the remote sensor on the display.

Use the remote control within 5 m from the sensor on the display at an angle of 20 degrees from the left and right.

NOTE:

- The remote control may not function properly when the remote control sensor on the display is under direct sunlight or strong illumination, or when an obstacle blocks the signal transmission.
- Use an IR sensor cable for better performance of the remote control. (Refer to IR Connection 30 for details)

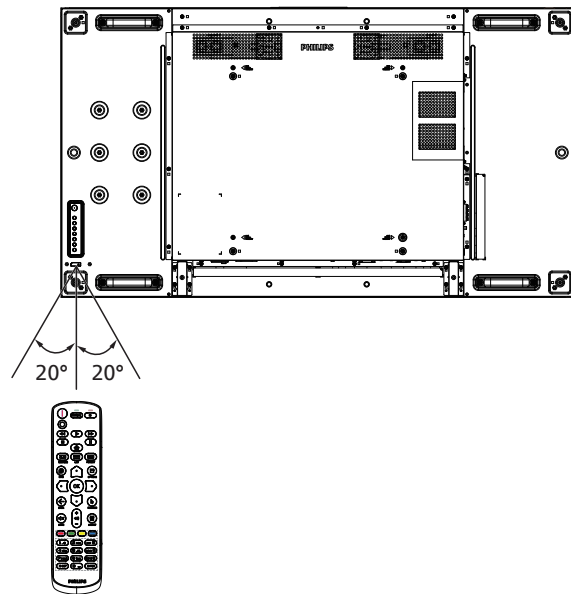

## 4. Connecting External Equipment

### 4.1. Connecting External Equipment (Multimedia Player)

#### 4.1.1. Using HDMI Video Input

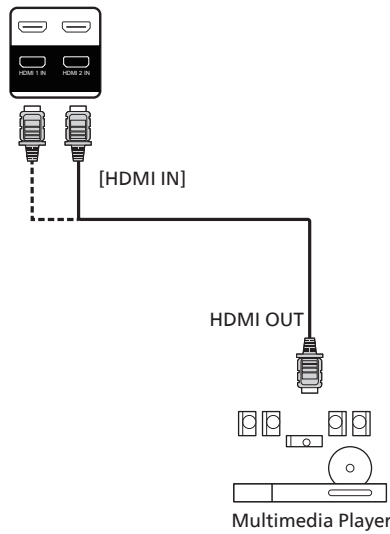

### 4.2. Connecting a PC

#### 4.2.1. Using VGA Input

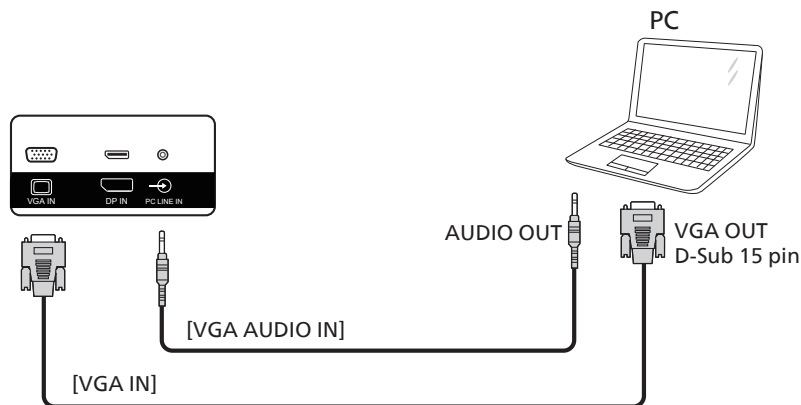

#### 4.2.2. Using DVI Input

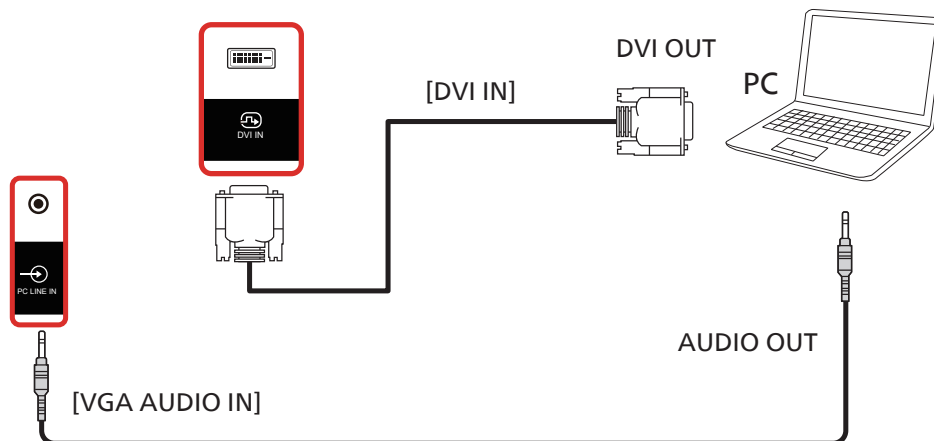

### 4.2.3. Using HDMI Input

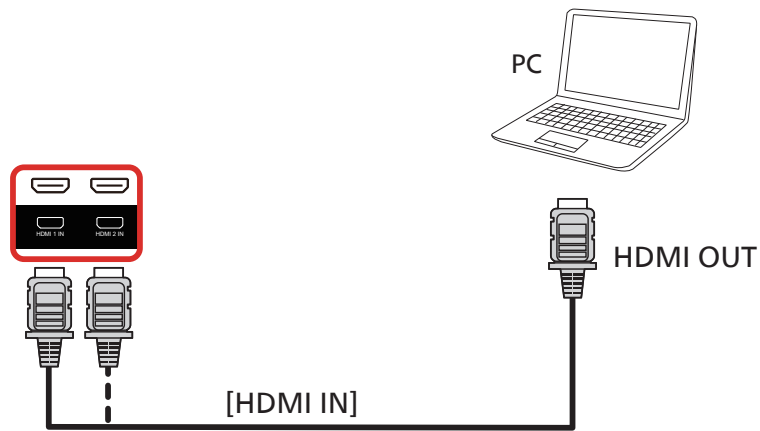

### 4.2.4. Using DisplayPort Input

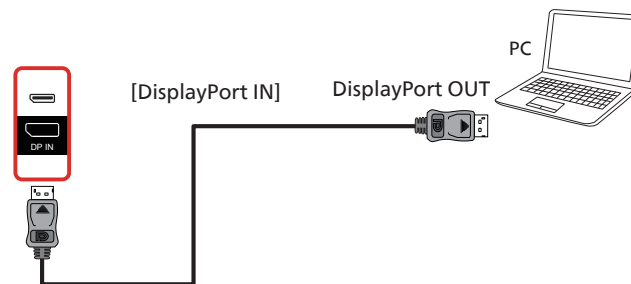

## 4.3. Connecting Audio Equipment

### 4.3.1. Connecting an External Audio Device

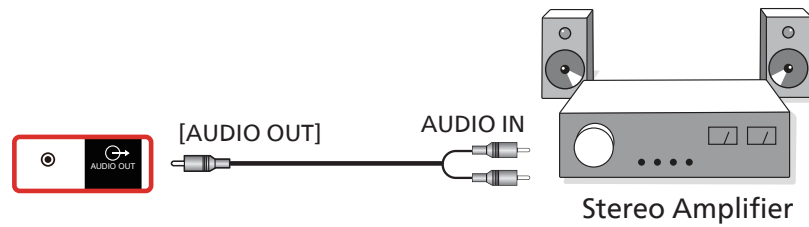

## 4.4. Connecting Multiple Displays in a Daisy-Chain Configuration

You can interconnect multiple displays to create a daisy-chain configuration for applications such as a menu board.

### 4.4.1. Display Control Connection

Connect laptop [RJ45] to [RJ45 IN] of DISPLAY 1, and connect the [RJ45 OUT] connector of DISPLAY 1 to the [RJ45 IN] connector of DISPLAY 2.

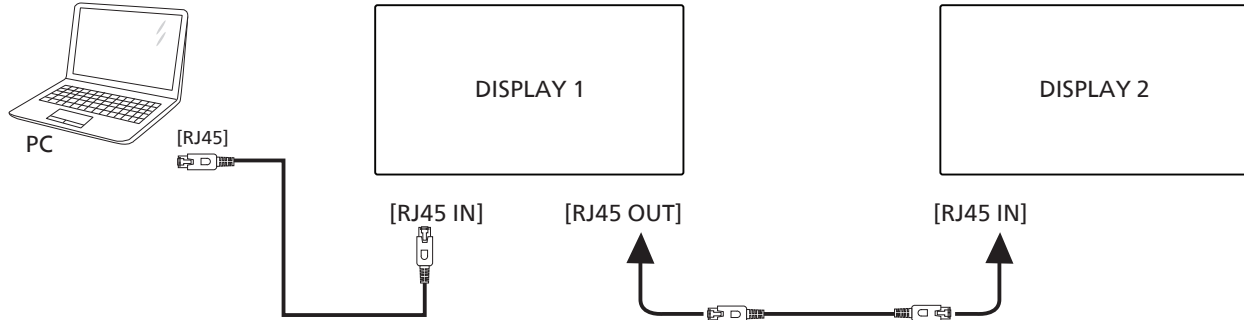

Connect laptop [USB] to adaptor [D89 IN] and connect adaptor [RJ45 OUT] to [Control IN] of DISPLAY 1, and connect the [Control OUT] connector of DISPLAY 1 to the [Control IN] connector of DISPLAY 2.

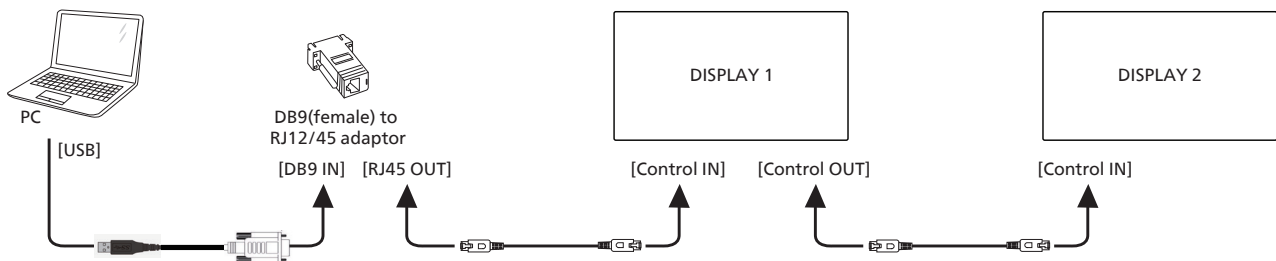

### 4.4.2. Digital Video Connection

Connect laptop [DP] to [DP IN] of DISPLAY 1, and connect the [DP OUT] connector of DISPLAY 1 to the [DP IN] connector of DISPLAY 2.

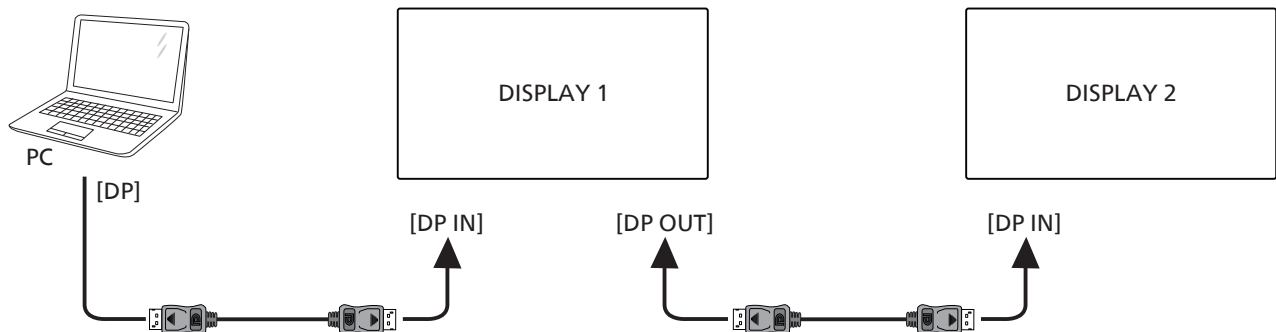

Connect laptop [DVI] to [DVI IN] of DISPLAY 1, and connect the [DP OUT] connector of DISPLAY 1 to the [DP IN] connector of DISPLAY 2.

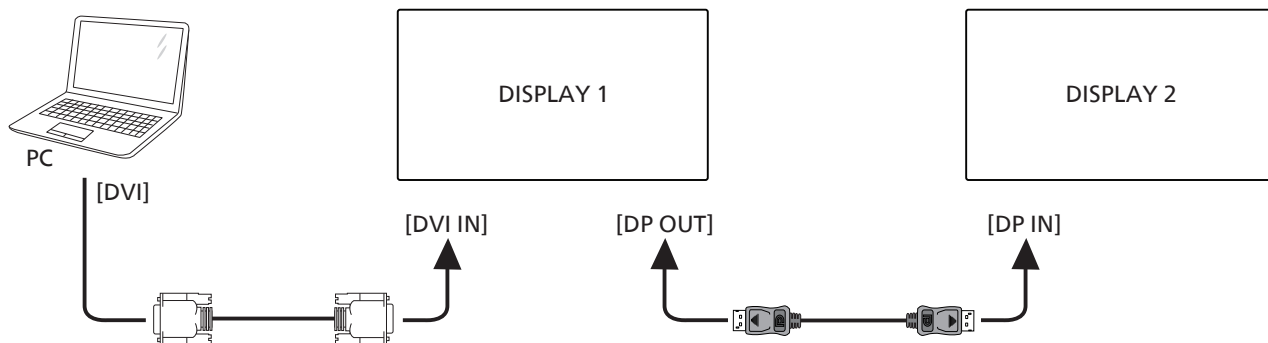

Connect laptop [HDMI] to [HDMI IN] of DISPLAY 1, connect the [DP OUT] connector of DISPLAY 1 to the [DP IN] connector of DISPLAY 2.

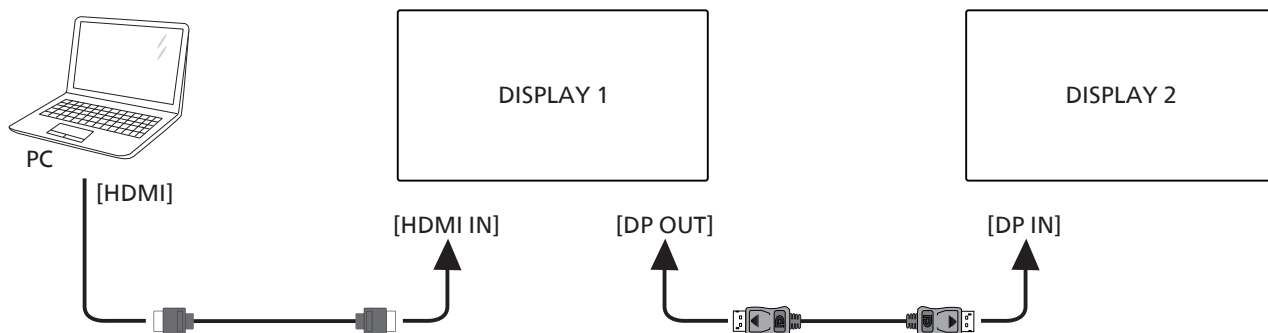

Connect laptop [VGA] to [VGA IN] of DISPLAY 1, and connect the [DP OUT] connector of DISPLAY 1 to the [DP IN] connector of DISPLAY 2.

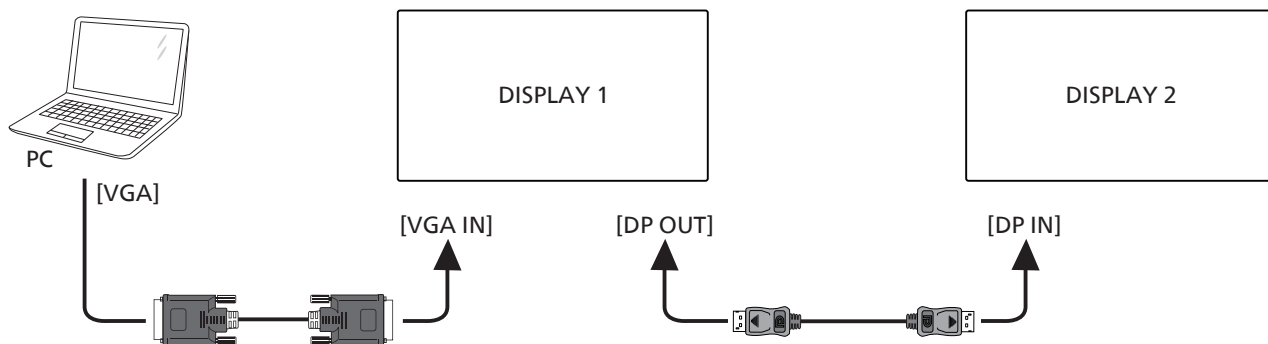

## 4.5. IR Connection

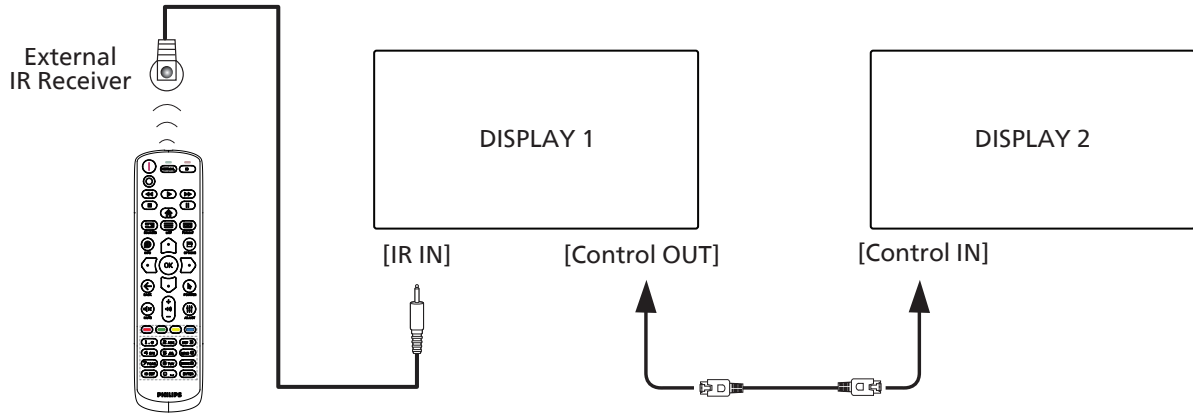



**NOTE:**

1. The remote control sensor of this display will stop working if the [IR IN] is connected.
2. IR loop through connection can support up to 9 displays.
3. IR in daisy chain via Control IN/OUT connection can support up to 9 displays.

## 5. Operation

NOTE: The control button described in this section is mainly on the remote control unless specified otherwise.

### 5.1. Watch the Connected Video Source

1. Press the [  ] SOURCE button.
2. Press [  ] or [  ] button to select a device, then press [OK] button.

### 5.2. Change Picture Format

You can change the picture format to suit the video source. Each video source has its available picture formats.

The available picture formats depend on the video source:

1. Press [  ] FORMAT button to select a picture format.
  - PC mode: {Full} / {4:3} / {1:1} / {16:9} / {21:9} / {Custom}.
  - Video mode: {Full} / {4:3} / {1:1} / {16:9} / {21:9} / {Custom}.









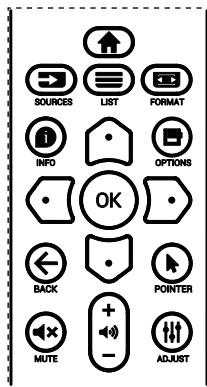

## 6. OSD Menu

An overall view of the On-Screen Display (OSD) structure is shown below. You can use it as a reference for further adjustment of your display.



### 6.1. Navigating the OSD Menu

#### 6.1.1. Navigating the OSD Menu using the Remote Control





1. Press [  ] button on the remote control to display the OSD menu.
2. Press [  ] or [  ] button to choose the item you want to adjust.
3. Press [OK] or [  ] button to enter the submenu.
4. In the submenu, press [  ] or [  ] button to toggle among items, press [  ] or [  ] button to adjust settings. If there is a submenu, press [OK] or [  ] button to enter the submenu.
5. Press [  ] button to return to the previous menu, or press [  ] button to exit the OSD menu.

Notes:

- When there is no OSD menu on the screen, press [  ] to display the menu of {Smart picture}.
- When there is no OSD menu on the screen, press [  ] to display the menu of {Audio source}.

### 6.1.2. Navigating the OSD Menu using the Display's Control Buttons

1. Press [MENU] button to display the OSD menu.
2. Press [ + ] or [ - ] button to choose the item you want to adjust.
3. Press [ + ] button to enter the submenu.
4. In the submenu, press [  ] or [  ] button to toggle among items, press [ + ] or [ - ] button to adjust settings. If there is a submenu, press [ + ] button to enter the submenu.
5. Press [MENU] button to return to the previous menu, or press [MENU] button several times to exit the OSD menu.

## 6.2. OSD Menu Overview

### 6.2.1. Picture Menu

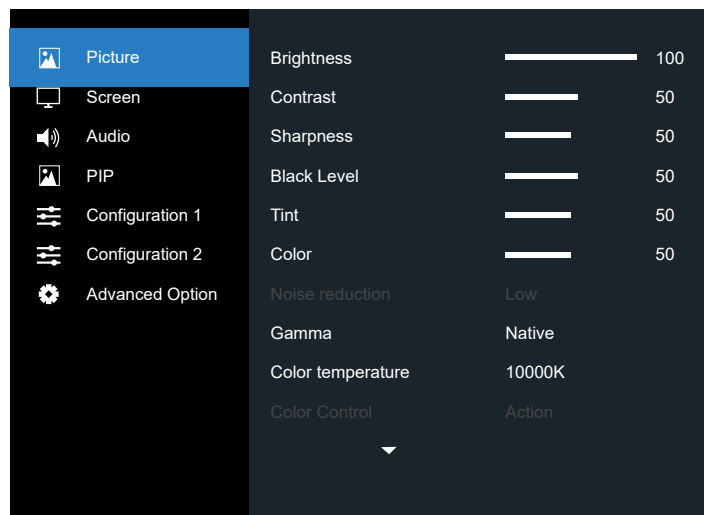

#### Brightness (Picture)

Adjust the overall image and background screen brightness(backlight).

#### Contrast

Adjust the image contrast ratio for the input signal.

#### Sharpness

This function is digitally capable to keep crisp image at any timings.

It is adjustable to get a distinct image or a soft one as you prefer and set independently for each picture mode.

#### Black Level

Adjust the image brightness for the background.

NOTE: sRGB picture mode is standard and cannot be changed.

#### Tint(Hue)

Adjust the tint of the screen.

Press + button the flesh tone color becomes greenish.

Press - button the flesh tone color becomes purplish.

Note: VIDEO mode only.

**Color(Saturation)**

Adjust the color of the screen.

Press + button to increase color depth.

Press - button to decrease color depth.

Note: VIDEO mode only.

**Noise Reduction**

Adjust the noise reduction level.

**Gamma**

Select a display gamma. It refers to the brightness performance curve of signal input. Choose from {Native} / {2.2} / {2.4} / {s gamma} / {D-image}.

Note: sRGB picture mode is standard and cannot be changed.

**Color Temperature**

It is used to adjust the color temperature.

The image becomes reddish as the color temperature decreases, and becomes bluish as the color temperature increases.

CCT	10000° K	9300° K	7500° K	6500° K	5000° K
X	0.279 ± 0.030	0.283 ± 0.030	0.299 ± 0.030	0.313 ± 0.030	0.346± 0.030
Y	0.292 ± 0.030	0.298 ± 0.030	0.315 ± 0.030	0.329 ± 0.030	0.359± 0.030

CCT	4000° K	3000° K	Native	User1	User2
X	0.382± 0.030	0.440± 0.030	0.28± 0.030	0.28 ± 0.030	0.28 ± 0.030
Y	0.384± 0.030	0.403± 0.030	0.29± 0.030	0.29± 0.030	0.29± 0.030

Note:

- The color levels of red, green, and blue are adjusted by the color bars.
- In User1 mode, R/B/G adjust range is 0-255.
- In User2 mode, color temperature adjust range is 3000k-10000k.

**Smart Picture**

PQ setting

PC mode: {Standard} / {Highbright} / {sRGB}.

Video mode: {Standard} / {Highbright} / {Cinema}.

**Smart Power**

Smart Power control is not relative to brightness control:

1. Initial Setting Brightness  
75 (in the range from 0-100).  
Power consumption 70% of maximum power consumption
2. Smart Power  
OFF: no adaptation  
MEDIUM: 80% of power consumption relative to current settings.  
HIGH: 65% of power consumption relative to current settings.

**Color Space**

Color space setting

RGB PC / RGB Video / REC601 / REC702 / Auto.

**Local Dimming**

Turn the local dimming function On/Off.

**Overscan**

Change the display area of the image.

ON: Set to display area about 95%.

OFF: Set to display area about 100%.

**Uniformity**

Turn the uniformity function On/Off.

**Picture Reset**

Reset all settings in the Picture menu.

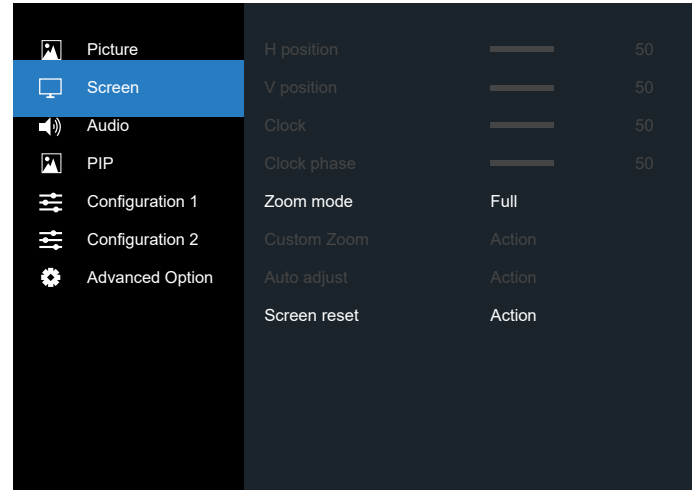
**6.2.2. Screen Menu****H Position**

Control Horizontal Image position within the display area of the LCD.

Press + button to move screen to the right.

Press - button to move screen to the left.

**V Position**

Control Vertical Image position within the display area of the LCD.

Press + button to move screen upward.

Press - button to move screen downward.

**Clock**

Press + button to expand the width of image on the screen to the right.

Press - button to narrow the width of image on the screen to the left.

Note: VGA input only.

**Clock Phase**

Improves focus, clarity and image stability by increasing or decreasing this setting.

Note: VGA input only.

## Zoom Mode

PC mode: {Full} / {4:3} / {1:1} / {16:9} / {21:9} / {Custom}.

Video mode: {Full} / {4:3} / {1:1} / {16:9} / {21:9} / {Custom}.

\*Zoom mode setting is defined by input. If input in multi-windows, the setting will apply for windows with the same input.

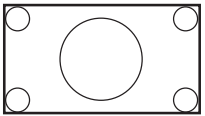
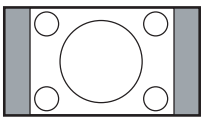
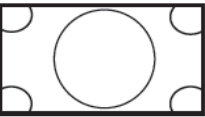
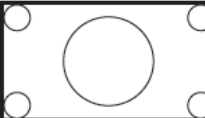
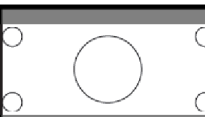

The INFO OSD will show the latest setting.

	<p><b>Full</b> This mode restores the correct proportions of pictures transmitted in 16:9 using the full screen display.</p>
	<p><b>4:3</b> The picture is reproduced in 4:3 format and a black band is displayed on either side of the picture.</p>
	<p><b>1:1</b> This mode displays the image pixel-by-pixel on screen without scaling the original image size.</p>
	<p><b>16:9</b> The picture is reproduced in 16:9 format and a black band at the top and bottom.</p>
	<p><b>21:9</b> The picture is reproduced in 21:9 format and a black band at the top and bottom.</p>
	<p><b>Custom</b> Choose to apply the custom zoom settings in the Custom Zoom submenu.</p>

## Custom Zoom

You can use this function to further customize the zoom settings to suit the image you want to display.

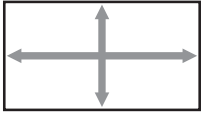
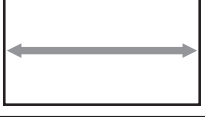
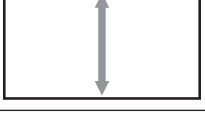
Note: This item is functional only when the {Zoom mode} is set to {Custom}.

	<p><b>Zoom</b> Expands the horizontal and vertical sizes of the image simultaneously.</p>
	<p><b>H Zoom</b> Expands the horizontal size of the image only.</p>
	<p><b>V Zoom</b> Expands the vertical size of the image only.</p>
	<p><b>H Position</b> Moves the horizontal position of the image left or right.</p>

	<p><b>V position</b> Moves the vertical position of the image up or down.</p>
--	---















## Auto Adjust







Press "Set" to detect and adjust H position, V position, Clock, Phase automatically.

## Screen Reset

Reset all settings in the Screen menu to factory preset values.

## 6.2.3. Audio Menu

	Picture	Balance		50
	Screen	Treble		60
	Audio	Bass		60
	PIP	Volume		50
	Configuration 1	Audio out (line out)		30
	Configuration 2	Maximum volume		100
	Advanced Option	Minimum volume		0
		Mute	Off	
		Speaker	On	
		Sync. Volume	Off	

	Picture	Audio source	Digital
	Screen	OPS audio	Digital
	Audio	Audio reset	Action
	PIP		
	Configuration 1		
	Configuration 2		
	Advanced Option		

## Balance

Adjust to emphasize left or right audio output balance.

## Treble

Adjust to increase or decrease higher-pitched sounds.

## Bass

Adjust to increase or decrease lower-pitched sounds.

## Volume

Adjust to increase or decrease the audio output level.

## Audio out (Line out)

Adjust to increase or decrease line out output level.

### Maximum Volume

Adjust your own limitation for the maximum volume setting. This stops the volume from being played too loudly.

### Minimum Volume

Adjust your own limitation for the minimum volume setting.

### Mute

Turn the mute function on/off.

### Speaker

Turn the internal speaker on/off.

Note: This function is only available when "Audio Out Sync" is on.

### Sync. Volume

Enable/disable audio out (line out) volume adjustability to sync with internal speakers volume, but PD Internal speaker sound will be forced to be mute.

### Audio Source

Select the audio input source.

Analog: audio from audio input.

Digital : audio from HDMI/DVI audio.

DisplayPort: audio from DP.

### OPS Audio

Select OPS audio from:

- {Digital}-(Default)
- {Analog}

\*OPS model only.

### Audio Reset

Reset all settings in the Audio menu to factory preset values.

## 6.2.4. PIP Menu

Picture	Sub mode	Off
Screen	PIP size	Small
Audio	PIP position	Bottom-Right
PIP	PIP change	Action
Configuration 1	PIP source	VGA
Configuration 2	PIP audio	Main
Advanced Option	PIP reset	Action

### Sub Mode

Select the sub mode.

Choose from: {Off} / {PIP} / {PBP} / {Quick swap}.

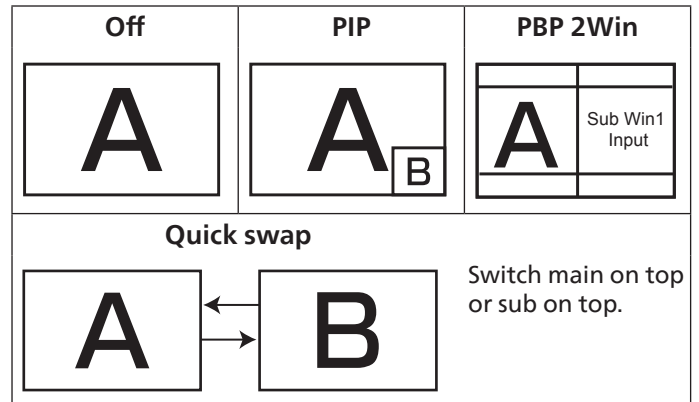

### PIP Size

Select the size of the sub picture in the PIP (Picture-in-Picture) mode.

Choose from: {Small} / {Medium} / {Large}.

### PIP Position

Select the position of the sub picture in the PIP (Picture-in-Picture) mode.

Choose from: {Bottom-Right}/{Bottom-Left}/{Top-Right}/ {Top-Left}/{Center}/{Custom}.

### PIP Change

Exchange Main and PIP / PBP / Quick swap input signal.

### PIP Source

Select the input signal for the sub picture.

NOTE: HDMI1 and HDMI2 can't coexist in PIP mode.

	HDMI1	HDMI2	DVI	DisplayPort	VGA	OPS
HDMI1	O	X	O	O	O	O
HDMI2	X	O	O	O	O	O
DVI	O	O	O	O	O	O
DisplayPort	O	O	O	O	O	O
VGA	O	O	O	O	O	O

### PIP Audio

Select the audio source in the Sub mode.

- {Main} - Select audio from the main picture.
- {Sub} - Select audio from the sub picture.

### PIP Reset

Reset all settings in the PIP menu to factory preset values.

- The PIP function is available only for certain signal source combinations as shown in the table below.
- The availability of the PIP function will also depend on the resolution of the input signal being used.

## 6.2.5. Configuration 1 Menu

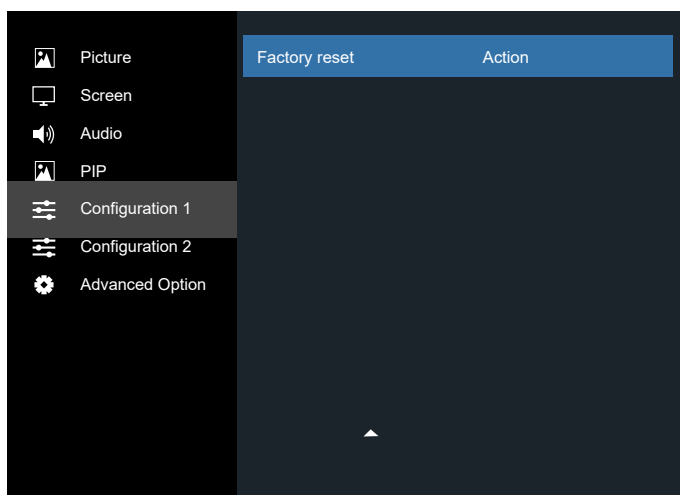
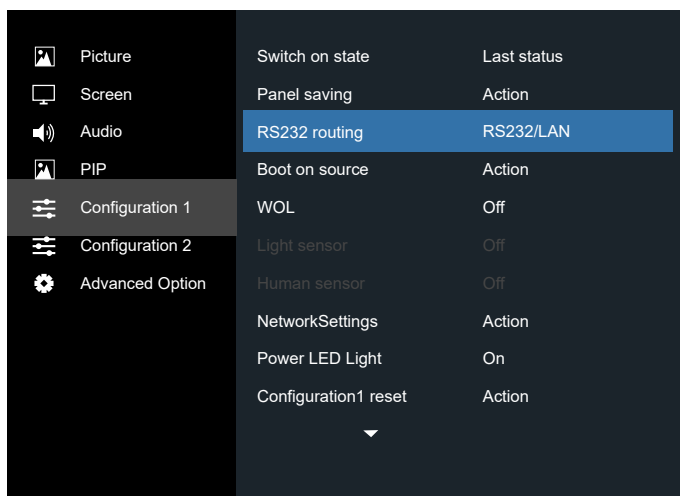

### Switch on State

Select the display status used for the next time you connect the power cord.

- {Power off} - The display will remain off when the power cord is connected to a wall outlet.
- {Forced on} - The display will turn on when the power cord is connected to a wall outlet.
- {Last status} - The display will return to the previous power status (on/off/standby) when removing and replacing the power cord.

### Panel Saving

Choose to enable the panel saving functions and thus reduce the risk of "image persistence" or "ghost-imaging".

- {Brightness} - Select {On} and the image brightness will be reduced to an appropriate level. The Brightness setting in the Picture menu will be unavailable when selected.
- {Pixel shift} - Select the time interval ({Auto} / {10 ~ 900} Seconds / {Off}) for the display to slightly expand the image size and shift the position of pixels in four directions (up, down, left, or right).
- {Cooling fan} - Select for fan speed {Off}{Default}/{Auto}/{Low}/{Medium}/{High}.

### RS232 Routing

Select the network control port.

Choose from: {RS232/LAN}/ {OPS RS232/LAN}.

### Boot on Source

Choose to select source when boot up.

Input: select input source when bootup.

### WOL

Choose to turn on or off the wake on LAN function.

Choose from : {Off} / { On}

### Light Sensor (require Philips accessory CRD41 External Sensor Box)

Choose to turn on or off backlight adjustment according to environment brightness.

Choose from : {Off} / { On}

### Human Sensor (require Philips accessory CRD41 External Sensor Box)

The Human sensor can detect if people approach the display or not.

The display will turn off backlight if it detects nothing in setting time.

The display will return to backlight on when people approach the display.

The options are:

- {Off} (Default), {10 Min.}, {20 Min.}, {30 Min.}, {40 Min.}, {50 Min.}, {60 Min.}

### Network Settings

- DHCP On -> Cannot modify IP address/Subnet mask/ Default gateway
- DHCP Off-> Can manually input IP address/Subnet mask/ Default gateway.

### Power LED Light

Choose to set power indication LED on or off.

Choose {On} for normal use.

### Configuration 1 Reset

Reset all settings in Configuration 1 menu to the factory preset values.

### Factory Reset

Reset all settings in the OSD menus of {Picture}, {Screen}, {Audio}, {PIP}, {Configuration 1}, {Configuration 2}, and {Advanced option} to the factory preset values.

Press [←] or [→] button to select {Reset}, and press [OK] button to do the reset.

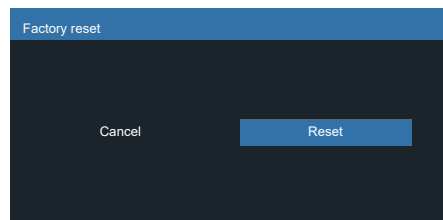

## 6.2.6. Configuration 2 Menu

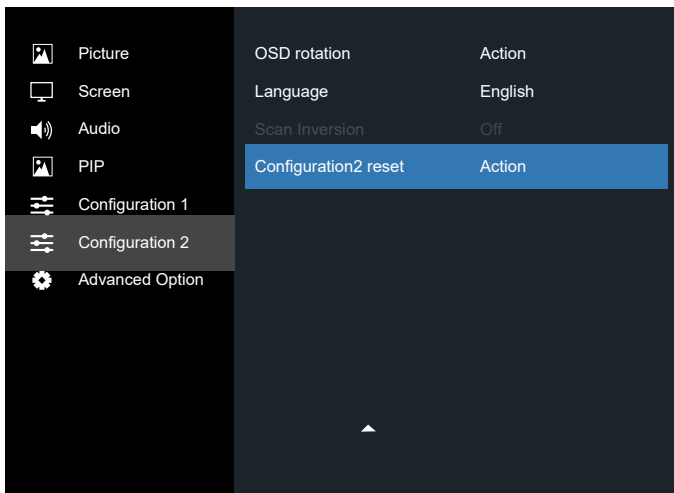
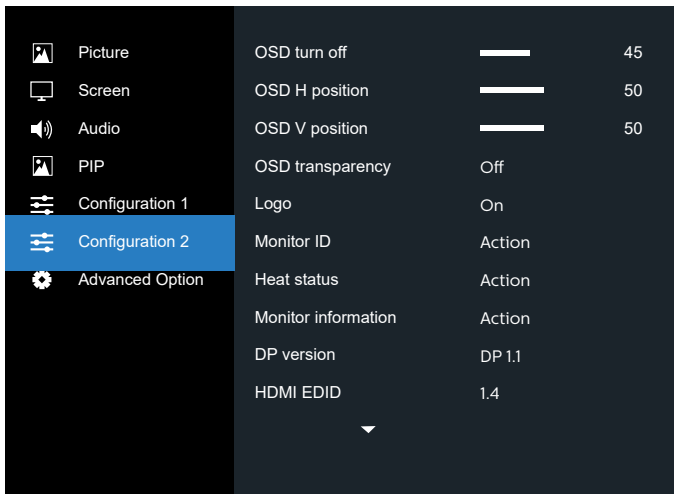

### OSD Turn off

Set the period of time the OSD (on-screen display) menu stays on the screen.

The options are: {0 ~ 120} seconds.

\*{0} does not disappear automatically.

### OSD H Position

Adjust the horizontal position of the OSD menu.

### OSD V Position

Adjust the vertical position of the OSD menu.

### OSD Transparency

Adjust OSD transparency.

- {Off} - Transparency off.
- 20/40/60/80/100.

### Logo

Choose to enable or disable the picture of Logo when turn on your display.

The options are:

- {Off}
- {On} (Default)

## Monitor ID

Set the ID number for controlling the display via the RS232C connection. Each display must have a unique ID number when multiple sets of this display are connected. Monitor ID number range is between 1 to 255.

The option are: {Monitor group} / {Tiling matrix} / {Auto ID}

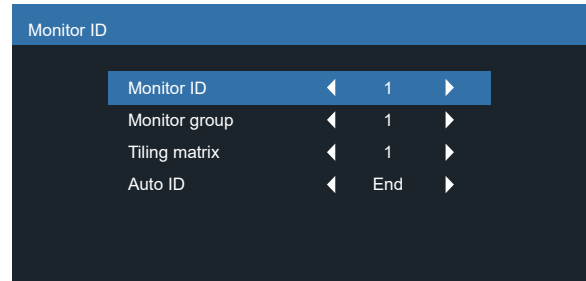

- {Monitor group}
  - The options are: {1-254}
  - {1-254} – {Monitor group} are supported. The default setting is 1.
- {Tiling matrix}
  - Refer to the following example for tiling matrix sets as 4: Note that a splitter or signal extension may be required depending on the number of display installed or other conditions. Please consult your service agent for detail instructions on installation.
- Tiling matrix number range is between 1 to 15. 1 is default setting. The {Auto ID} setup function enables setting up {Monitor ID} of connected machine according to {Tiling matrix} settings.

Example: Tiling matrix sets as 4

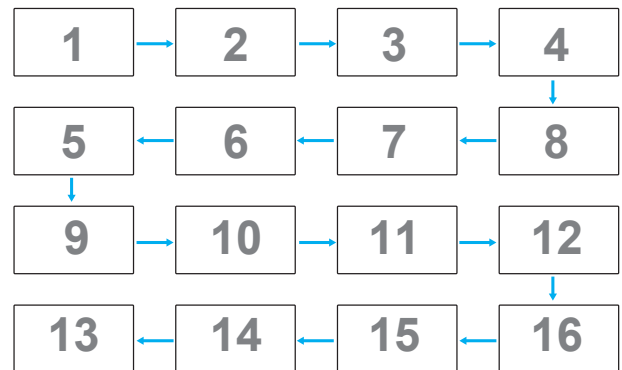

- {Auto ID}
  - The option are: {Start} / {End}. The default is {End}.
  - Switch to Start option to set up IDs of machines backward from current one.
  - Once the setup is completed, the option exits to End automatically.
  - To use this function, serial connect all machines with RS232 cable and set their Control ports to RS232 too.

### Heat Status

This function allows you to check the thermal status at any time.

## Monitor Information

Shows information about your display, including model number, serial number, operating hours and software version.

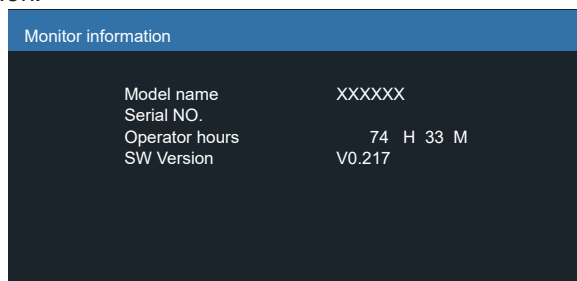

## DP Version

DisplayPort support mode.

The options are:

- {DP 1.1} (Default) : DP 1.1 single stream(clone mode).
- {DP 1.2}: DP 1.2.

NOTE:

1. The DP version must be set the same for all daisy chain displays.
2. For 3840x2160, the dot clock timing should be 533MHz.
3. DP 1.1 not support 4K/60Hz timing.

## HDMI EDID

Switch HDMI EDID type: {HDMI 1.4}, {HDMI 2.0}.

## OSD Rotation

Set the rotation of OSD.

## Language

Select the language used in the OSD menu.

The options are: English/Français/Deutsch/Español/Italiano/简体中文 / 繁體中文 / Português/ 日本語 .

## Scan Inversion

ON: Turn on scan data inversion function of Panel.

OFF: Turn off this function.

Default: Off.

## Configuration 2 Reset

Reset all settings in Configuration 2 menu to the factory preset values.

## 6.2.7. Advanced Option Menu

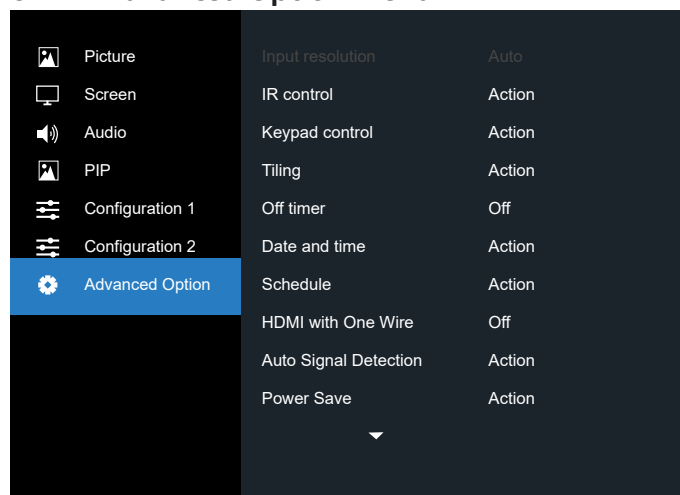

### Input Resolution

Set the resolution of the VGA input. This is only required when the display is unable to detect the VGA input resolution correctly.

Note: This item is functional for VGA input only.

The options are:

- {1024x768 / 1280x768 / 1360x768 / 1366x768}.
- {1400x1050 / 1680x1050}.
- {1600x1200 / 1920x1200}.
- {Auto}: Determines the resolution automatically.

The selected settings will become effective after turning off the power and turning it on again.

### IR Control

Select the operation mode of the remote control when multiple displays are connected via an RS232C connection.

- {Normal} - All displays can be operated normally by the remote control unit.
- {Primary} - Designate this display as the primary display for remote control operation. Only this display can be operated by the remote control. (In primary mode, IR key will always be processed regardless the monitor id/group settings).
- {Secondary} - Designate this display as the secondary display. This display can not be operated by the remote control, and will only receive the control signal from the primary display via the RS232C connection.
- {Lock All} / {Lock all but Volume} / {Lock all but Power} / {Lock all except PWR & VOL}- Lock the remote control function of this display. To unlock, press and hold the [●] INFO button on the remote control for 6 (six) seconds.

Note: If secondary PD is set {Normal}, it always receive IR control signal from primary PD.

### Keypad Control

Choose to enable or disable the display Keypad (control buttons) function.

- {Unlock} - Enable the Keypad function.
- {Lock All} / {Lock all but Volume} / {Lock all but Power} / {Lock all except PWR & VOL} - Disable the Keypad function.

NOTE: "Keypad Control Lock Mode" This function completely disables the access to all Keypad Control functions. To enable or disable the Keypad control lock, press both [+ ] and [ ] buttons and hold down continuously for more than 3 seconds.

### Tiling

With this function you can create a single large-screen matrix (video wall) that consists of up to 225 sets of this display (up to 15-sets on the vertical and 15-sets on the horizontal sides). This function requires a daisy-chain connection.

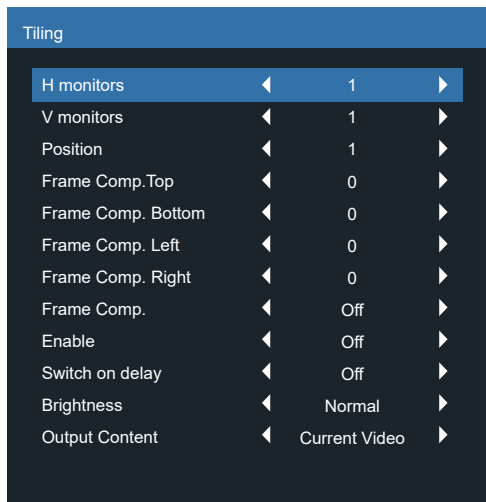

Example: 2 x 2 screen matrix (4 displays)

H monitors = 2 displays

V monitors = 2 displays

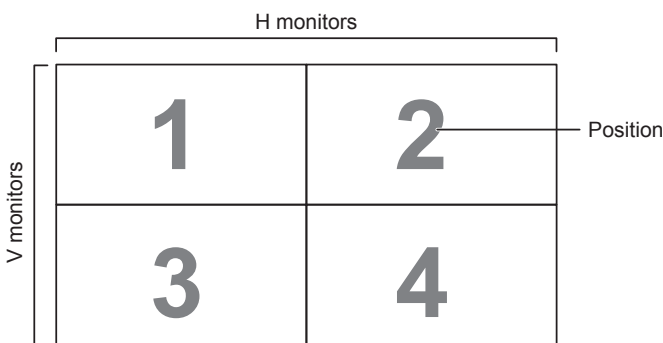

Example: 5 x 5 screen matrix (25 displays)

H monitors = 5 displays

V monitors = 5 displays

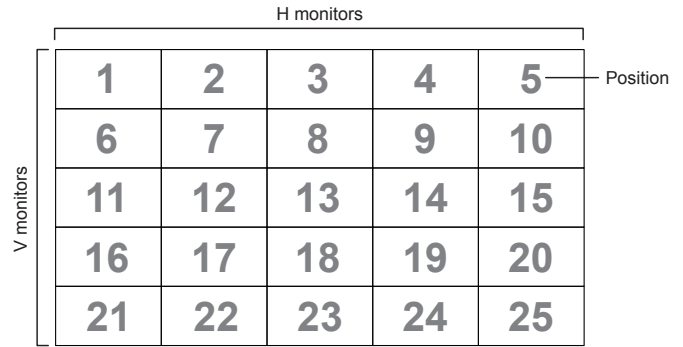

- {H monitors} - Select the number of displays on the horizontal side.
  - {V monitors} - Select the number of displays on the vertical side.
  - {Position} - Select the position of this display in the screen matrix.
  - {Frame comp. Top} - set the pixel numbers of top frame compensation.
  - {Frame comp. Bottom} - set the pixel numbers of bottom frame compensation.
  - {Frame comp. Left} - set the pixel numbers of left frame compensation.
  - {Frame comp. Right} - set the pixel numbers of right frame compensation.
  - {Frame comp.} - Choose to turn the frame compensation function on or off. If selected {Yes}, the display will adjust the image to compensate for the width of the display bezels in order to accurately display the image.
- {On}

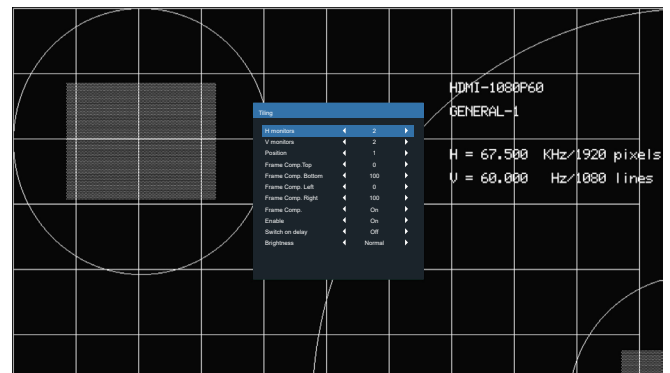

{Off}

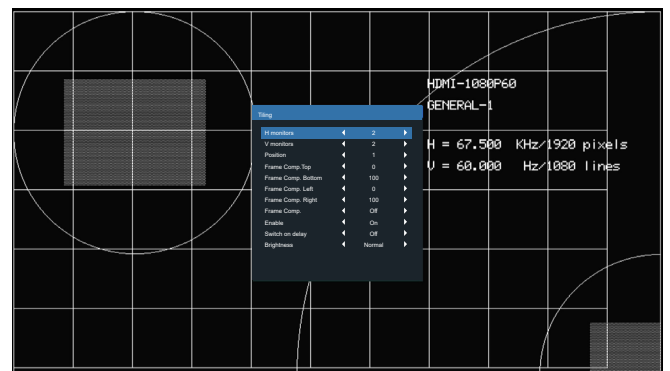

- {Enable} - Choose to enable or disable the Tiling function. If enabled, the display will apply the settings in {H monitors}, {V monitors}, {Position}, and {Frame comp.}.
- {Switch on delay} - Set the power-on delaying time (in seconds). The default option {Auto} allows a sequential powering-on for each display by their ID number when multiple displays are connected. The options are: {Off/ Auto/2-255}.
- Brightness: {Normal}/{ACS}.

{Normal}: Apply OSD brightness value (backlight).

{ACS}: Apply brightness value (backlight) which is adjusted by MIC tool. The default value before adjustment is the same as OSD brightness value, e.g., 70).

Some brightness (backlight) settings cannot be adjusted by OSD. Please refer to Picture Menu Backlight setting priority.

- Output content : Select DP out transfer source.

{Current Video} :transfer Current Video Source.

{Displayport} : Forced to transfer source of Displayport.

Notes:

- Custom Zoom/PIP/Tiling can't coexist.
- Max video input:  
Max video input resolution with tiling enabled: 4K30Hz.  
Max video input resolution with tiling disabled: 4K60Hz.

## Off Timer

Set automatically power off time (in hours).

## Date and Time

Adjust the current date and time for the display's internal clock.

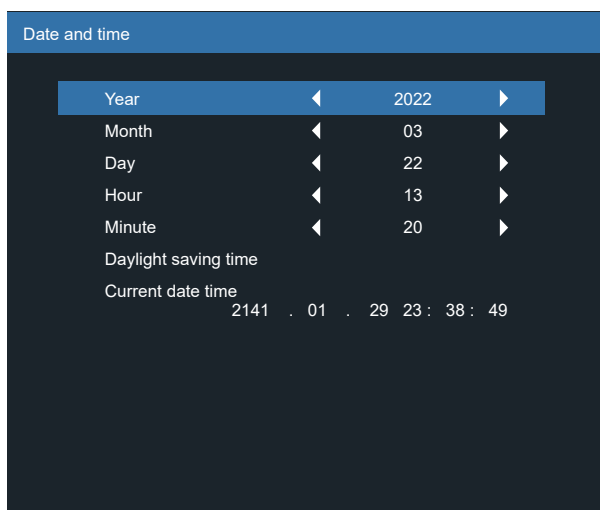

1. Press [OK] button to enter the submenu.
2. Press [↶] or [↷] button to toggle between {Year}, {Month}, {Day}, {Hour}, {Minute}, and {Daylight saving time}.
3. Press [↶] or [↷] button to adjust all settings except {Daylight saving time}.
4. Press [OK] button to enter the {Daylight saving time} submenu.
5. Press [↶] or [↷] button to select item, press [↶] or [↷] button to adjust.

The Daylight saving time definition and behavior:

The current implementation of daylight saving is a reminder tool for the customer who doesn't know how to adjust the clock for daylight saving on and off. It does not adjust the real time clock automatically. Problem is that there are no stable rules per region, or country when to adjust the clock. To solve this, the user must be able to set the daylight saving start and stop date. When daylight saving correction is on (user selectable), the real time clock should be adjusted at the moment in time set in the daylight saving on and off date. At daylight start date the clock should be put forward 1 hour at 2 o'clock. At daylight stop date the clock should be put back 1 hour at 2 o'clock.

The existing daylight on/off menu item should be replaced with the following menu structure:

- Menu item <Daylight saving setup> opens submenu containing the following items:
- Menu item <Daylight-saving start date> Selection item <1st, 2nd, 3rd, 4th, last> Sunday of selection item <1-12 month>
- Menu item <Daylight-saving stop date> Selection item <1st, 2nd, 3rd, 4th, last> Sunday of selection item <1-12 month>
- optional
- Menu item <Correction time> Selection item <0.5, 1.0, 1.5, 2.0> hour
- Menu item <Daylight saving correction> Selection item <on, off>

When "daylight saving" is "on", the real time clock would have been adjusted automatically for winter and summer time when passing the critical moment in time. (eg. march 29, 2009, 02.00 o'clock: time will be set 1 hour later or October 25, 2009, 02.00 o'clock: time will be set 1 hour earlier.)

## Schedule

This function allows you to program up to 7 (seven) different scheduled time intervals for the display to activate.

You can select:

- The time for the display to turn on and turn off.
- The days in a week for the display to activate.
- Which input source the display will use for each scheduled activation period.

NOTE: We recommend you to set up current date and time in the {Date and time} menu before using this function.

Press [OK] or [D] button to enter the submenu.

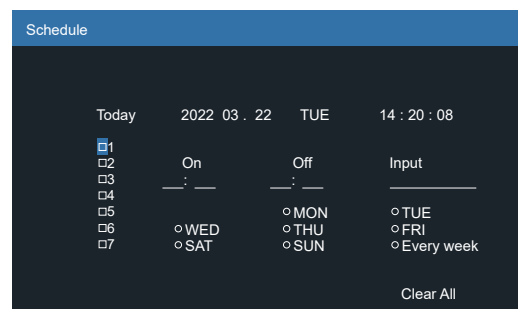

6. Press [↶] or [↷] button to select a schedule item (item number 1 ~ 7), and then press [OK] button to mark the item number.

7. Press [↵] or [⏏] button to select the schedule:
- ① Power-on schedule: Press [⏏] or [↵] button to set the hour and minute for the display to turn on.
  - ② Power-off schedule: Press [⏏] or [↵] button to set the hour and minute for the display to turn off.
- Select or leave an empty “\_” for both the hour and minute slot if you do not want to use this power-on or power-off schedule.
- ③ Input-source selection: Press [⏏] or [↵] button to select an input source. If no input source is selected, the input source will remain the same as last selected.
  - ④ Date schedule: Press [⏏] button to select which day in a week this schedule item will be take effect, and then press the [OK] button.
8. For additional schedule settings, press [←], then repeat the steps above. A check mark in the box next to the number of the schedule item indicates that the selected schedule is in effect.

#### Notes:

- If the schedules overlap, the scheduled power-on time takes priority over scheduled power-off time.
- If there are two schedule items programmed for the same time, the highest numbered schedule takes priority. For example, if schedule items #1 and #2 both set the display to power on at 7:00 AM and off at 5:00 PM, then only schedule item # 2 will take effect.

#### HDMI with One Wire

##### CEC control.

- {Off} - Disable CEC.(Default).
- {On} - Enable CEC.

#### Auto signal detection

Choose to let the display detect and display available signal sources automatically.

- {Off} - Once a signal is connected, it can only be selected manually.

If the selected input is no signal, set the display to display the image automatically according to the search order of each option.

The options are: {All} / {Failover}

- {All}: DP -> HDMI1 -> DVI -> VGA.
- {Failover}
  - Failover 1: User-defined setting. Default: HDMI 1.
  - Failover 2: User-defined setting. Default: HDMI 1.
  - Failover 3: User-defined setting. Default: HDMI 1.
  - Failover 4: User-defined setting. Default: HDMI 1.
  - Failover 5: User-defined setting. Default: HDMI 1.

#### Power Save

##### Power save modes

Mode 1: [TCP off, WOL on, auto off]

DC off -> Power off. LED: Red.

Power Save -> Power off, LED: Red.

Mode 2: [TCP off, WOL on, auto on/off]

DC off -> Power off, LED: Red.

Power Save -> Power Saving.

LED: Orange. Can be wake up.

Mode 3: [TCP on, WOL off, auto on/off]

DC off -> Back light off, LED: Red.

Power Save -> Back light off, LED: Orange. Can be wake up.

Mode 4: [TCP on, WOL off, no auto on/off]

DC off -> Back light off, LED: Red.

Power Save -> Will not enter power save mode. show “no signal” only.

<u>Mode 3</u>	<u>Mode 1(default)</u>
DC OFF: Backlight Off only	DC OFF: Power Off
Power Save: Backlight Off only	Power Save: Power Off
<u>Mode 4</u>	<u>Mode 2</u>
DC OFF: Backlight Off only	DC OFF: Power Off
Power Save: No signal(Backlight On)	Power Save: Power Saving

DC off/on: Press power button by RC.

#### Firmware Update

Update scalar FW by USB.

#### Information OSD

Set the period of time and the information OSD is displayed on the upper right corner of the screen. The information OSD will display when input signal is changed.

The information OSD will remain on the screen with {Off} selection.

The options are: {1 ~ 60} seconds.

## OPS Setting

### Set OPS status

- {Auto} - After selecting {Card OPS} for video source input, the OPS will be set to off when the display power is set to off, or set to on when the display power is set to on. When set to other video source inputs, the OPS will always be set to on.
- {Always off} - The OPS will always be set to off.
- {Always on} - The OPS will always be set to on.

\* OPS model only.

### Advanced Option Reset

Reset all settings except {Date and Time} in the Advanced option menu to factory preset values.

1. Press [OK] or [D] button to enter the submenu.
2. Press [C] or [D] button to select {Reset} and press the [OK] button to restore settings to factory preset values.
3. Press the [←] button or select {Cancel} and press the [OK] button to cancel and then return to the previous menu.

## 7. Input Mode

Item	Resolution	References	H.Freq.(kHz)	V.Freq.(Hz)	Note
1	640x480	VESA DMT, CEA-861-F Format 1	31.469	59.940	
2	640x480	VESA DMT	37.861	72.809	
3	640x480	VESA DMT	37.500	75.000	
4	640x480	VESA DMT	43.269	85.008	
5	800x600	VESA DMT	37.879	60.317	
6	800x600	VESA DMT	48.077	72.188	
7	800x600	VESA DMT	46.875	75.000	
8	800x600	VESA DMT	53.674	85.061	
9	848x480	VESA CVT	29.830	59.659	
10	848x480	VESA CVT	37.684	74.769	
11	848x480	VESA CVT	42.969	84.751	
12	1024x768	VESA DMT	48.363	60.004	
13	1024x768	VESA DMT	56.476	70.069	
14	1024x768	VESA DMT	60.023	75.029	
15	1024x768	VESA DMT	68.677	84.997	
16	1152x864	VESA DMT	63.851	70.012	
17	1152x864	VESA DMT	67.500	75.000	
18	1152x864	VESA DMT	77.094	84.999	
19	1280x768	VESA CVT	39.593	49.929	
20	1280x768	VESA CVT-R	47.396	59.995	
21	1280x768	VESA CVT	47.776	59.870	
22	1280x768	VESA CVT	60.289	74.893	
23	1280x768	VESA CVT	68.633	84.837	
24	1280x960	VESA DMT	60.000	60.000	
25	1280x960	VESA DMT	75.000	75.000	
26	1280x960	VESA DMT	85.938	85.002	
27	1280x1024	VESA DMT	63.981	60.020	
28	1280x1024	VESA DMT	79.976	75.025	
29	1280x1024	VESA DMT	91.146	85.024	
30	1366x768	VESA DMT	47.712	59.790	
31	1400x1050	VESA CVT	54.113	49.965	
32	1400x1050	VESA CVT-R	64.744	59.948	
33	1400x1050	VESA CVT	65.317	59.978	
34	1400x1050	VESA CVT	82.278	74.867	
35	1600x1200	VESA DMT	75.000	60.000	
36	1920x1080	VESA CVT	55.621	49.929	
37	1920x1080	VESA CVT	67.158	59.963	DVI is not supported
38	1920x1080	VESA CVT-R	66.587	59.950	
39	1920x1200	VESA CVT	61.816	49.932	
40	1920x1200	VESA CVT-R	74.038	59.950	
41	1680x1050	VESA CVT	54.121	49.974	
42	1680x1050	VESA CVT	65.290	59.954	
43	1920x2160	CEA-861-F, VIC 16, with vertical parameters doubled	135.000	60.000	VGA is not supported
44	1920x2160	VESA CVT-R	133.293	59.988	VGA is not supported
45	2560x1440	VESA CVT-R	88.787	59.951	VGA is not supported
46	2560x1600	VESA CVT-R	98.713	59.972	VGA is not supported
47	3840x1080	VESA CVT-R	66.625	59.968	VGA is not supported
48	3840x2160	VESA CVT-R	52.438	23.999	VGA is not supported
49	3840x2160	VESA CVT-R	65.688	29.981	VGA is not supported
50	3840x2160	VESA CVT-R	110.500	49.977	VGA is not supported
51	3840x2160	VESA CVT-R	133.313	59.997	VGA is not supported
52	480i	CEA-770.2, CEA-861-F Formats 6 & 7	15.734	59.940	Only HDMI is supported
53	576i	ITU-R BT.601, CEA-861-F Formats 21 & 22	15.625	50.000	Only HDMI is supported
54	480p	CEA-770.2, CEA-861-F Formats 2 & 3	31.469	59.940	

55	576p	ITU-R BT.1358, CEA-861-F Formats 17 & 18	31.250	50.000	
56	1080i	SMPTE 274M, CEA-861-F Format 20	28.125	50.000	
57	1080i	SMPTE 274M, CEA-861-F Format 5	33.750	60.000	
58	720p	SMPTE 296M, CEA-861-F Format 19	37.500	50.000	
59	720p	SMPTE 296M, CEA-861-F Format 4	45.000	60.000	
60	1080p	SMPTE 274M, CEA-861-F Format 32	27.000	24.000	
61	1080p	SMPTE 274M, CEA-861-F Format 33	28.125	25.000	
62	1080p	SMPTE 274M, CEA-861-F Format 34	33.750	30.000	
63	1080p	SMPTE 274M, CEA-861-F Format 31	56.250	50.000	
64	1080p	SMPTE 274M, CEA-861-F Format 16	67.500	60.000	
65	3840x2160	CEA-861-F Format 93, HDMI 1.4b VIC 1	54.000	24.000	VGA is not supported
66	3840x2160	CEA-861-F Format 94, HDMI 1.4b VIC 2	56.250	25.000	VGA is not supported
67	3840x2160	CEA-861-F Format 95, HDMI 1.4b VIC 3	67.500	30.000	VGA is not supported
68	3840x2160	CEA-861-F Format 96, 4:2:0 sub-sampling	67.500	50.000	VGA is not supported
69	3840x2160	CEA-861-F Format 96	112.500	50.000	VGA is not supported
70	3840x2160	CEA-861-F Format 97, 4:2:0 sub-sampling	67.500	60.000	VGA is not supported
71	3840x2160	CEA-861-F Format 97	135.000	60.000	VGA is not supported
72	4096x2160	CEA-861-F Format 98	54.000	24.000	VGA is not supported
73	4096x2160	CEA-861-F Format 99	56.250	25.000	VGA is not supported
74	4096x2160	CEA-861-F Format 100	67.500	30.000	VGA is not supported

- The PC text quality is optimum in HD 1080 mode (1920 x 1080, 60Hz).
- Your PC display screen might appear different depending on the manufacturer (and your particular version of Windows).
- Check your PC instruction book for information about connecting your PC to a display.
- If a vertical and horizontal frequency-select mode exists, select 60Hz (vertical) and 31.5KHz (horizontal). In some cases, abnormal signals (such as stripes) might appear on the screen when the PC power is turned off (or if the PC is disconnected). If so, press the [INPUT] button to enter the video mode. Also, make sure that the PC is connected.
- When horizontal synchronous signals seem irregular in RGB mode, check PC power saving mode or cable connections.
- The display settings table complies to the IBM/VESA standards, and based on the analog input.
- The DVI support mode is regarded as same to the PC support mode.
- The best timing for the vertical frequency to each mode is 60Hz.

## 8. Pixel Defect Policy

We strive to deliver the highest quality products and use some of the industry's most advanced manufacturing processes whilst practicing stringent quality control. However, pixel or sub-pixel defects on the PDP / TFT panels used in Plasma- & LCD- displays are sometimes unavoidable. No manufacturer can guarantee that all panels will be free from pixel defects, but Philips guarantees that any Plasma- & LCD- displays with an unacceptable number of defects will be repaired during the warranty period in line with your local guarantee conditions.

This notice explains the different types of pixel defects and defines the acceptable defect level for the LCD screen. In order to qualify for repair under warranty, the number of pixel defects must exceed a certain level as shown in the reference table. If the LCD screen is within specification a warranty exchange / claim back will be refused. Additionally, because some types or combinations of pixel defects are more noticeable than others, Philips sets even higher quality standards for those.

### 8.1. Pixels and Sub-Pixels

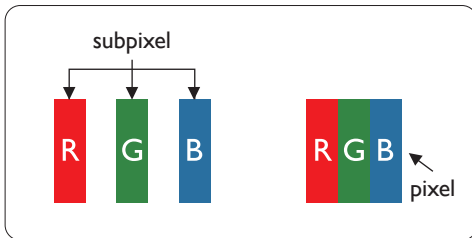

A pixel, or picture element, is composed of three sub-pixels in the primary colors of red, green and blue. Many pixels together form an image. When all sub-pixels of a pixel are lit, the three colored sub-pixels together appear as a single white pixel. When all are dark, the three colored sub-pixels together appear as a single black pixel. Other combinations of lit and dark sub-pixels appear as single pixels of other colors.

### 8.2. Types of Pixel Defects + Dot Definition

Pixel and sub-pixel defects appear on the screen in different ways. There are three categories of pixel defects and several types of sub-pixel defects within each category.

**Dot definition = What is a defective "Dot"?:**

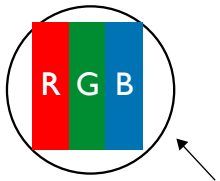

One or more defective, adjacent sub-pixel are defined as one "dot". The no. of defective sub-pixels are not relevant to define a defective dot. This means that a defective dot can consist of one, two or three defective sub-pixels which can be dark or lit.



One dot = One Pixel; consists of three sub-pixels of Red, Green, and Blue.

### 8.3. Bright Dot Defects

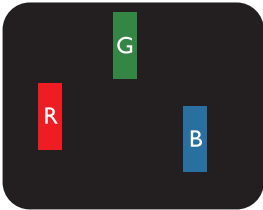
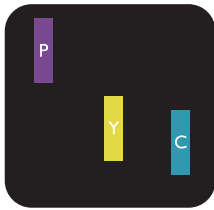
Bright dot defects appear as pixels or sub-pixels that are always lit or "on". These are the examples of bright dot defects:

 <p>One lit red, green or blue sub pixel</p>	 <p>Two adjacent lit sub pixels: Red + Blue = Purple Red + Green = Yellow Green + Blue = Cyan (Light Blue)</p>	 <p>Three adjacent lit sub pixels (one white pixel)</p>
---	---	--

## 8.4. Dark Dot Defects

Black dot defects appear as pixels or sub-pixels that are always dark or "off". These are the examples of black dot defects:

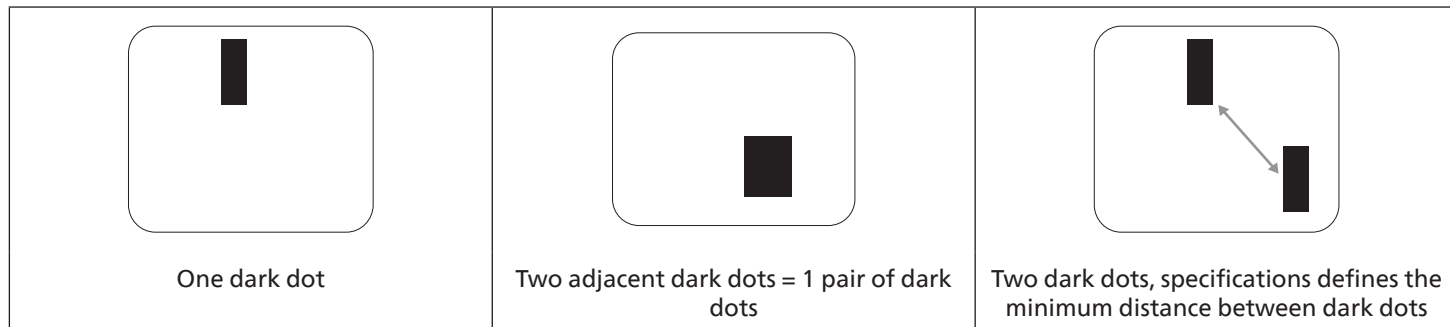

## 8.5. Proximity of Pixel Defects

Because pixel and sub-pixels defects of the same type that are nearby one another may be more noticeable, Philips also specifies tolerances for the proximity of pixel defects. In the table below you can find specifications about:

- Allowed amount of adjacent dark dots = (adjacent dark dots = 1 pair of dark dots)
- Minimum distance between dark dots
- Total no. of all defective dots

## 8.6. Pixel Defect Tolerances

In order to qualify for repair due to pixel defects during the warranty period, a PDP / TFT panel in a Philips Plasma / LCD- display must have pixel or sub-pixel defects exceeding the tolerances listed in the following table.

BRIGHT DOT EFFECT	ACCEPTABLE LEVEL
1 lit sub pixel	2
BLACK DOT EFFECT	ACCEPTABLE LEVEL
1 dark sub pixel	10
TOTAL DOT DEFECTS OF ALL TYPES	12

Note: \* 1 or 2 adjacent sub pixel defects = 1 dot defect

## 8.7. Mura

Dark spots or patches may occasionally appear on some liquid crystal display (LCD) panels. This is known within the industry as Mura, which is a Japanese term for "unevenness." It is used to describe an irregular pattern or area in which uneven screen uniformity appears under certain conditions. Mura is a result of the deterioration of the liquid crystal alignment layer and is most commonly caused by long-term operation under high ambient temperatures. It is an industry- wide phenomenon and Mura is not repairable. It is also not covered by our warranty terms.

Mura has been around since the introduction of LCD technology and with screens getting bigger and in operation 24/7, many displays are running in low light conditions. This all adds to the possibility of Mura affecting displays.

### HOW TO SPOT MURA

There are many symptoms of Mura and also multiple causes. Several of these are listed below:

- Impurities or foreign particles in the crystal matrix
- Uneven distribution of LCD matrix during manufacturing
- Non-uniform luminance distribution of the backlight
- Panel assembly induced stress
- Flaws within the LCD cells
- Thermal induced stress - high temperature operation over long periods of time

## **HOW TO AVOID MURA**

Although we can not guarantee the complete eradication of Mura every time, in general the appearance of Mura can be minimized by these methods:

- Lower the backlight brightness
- Use a screen saver
- Reduce the ambient temperature around the unit

---

## 9. Cleaning and Troubleshooting

### 9.1. Cleaning

#### Caution When Using the Display

- Do not bring your hands, face or objects close to the ventilation holes of the display. The top of the display is usually very hot due to the high temperature of exhaust air being released through the ventilation holes. Burns or personal injuries may occur if any body parts are brought too close. Placing any object near the top of the display could also result in heat related damage to the object as well as the display itself.
- Be sure to disconnect all cables before moving the display. Moving the display with its cables attached may damage the cables and thus cause fire or electric shock.
- Disconnect the power plug from the wall outlet as a safety precaution before carrying out any type of cleaning or maintenance procedure.

#### Front Panel Cleaning Instructions

- The front of the display has been specially treated. Wipe the surface gently using only a cleaning cloth or a soft, lint-free cloth.
- If the surface becomes dirty, soak a soft, lint-free cloth in a mild detergent solution. Wring the cloth to remove excess liquid. Wipe the surface of the display to remove dirt. Then use a dry cloth of the same type to dry.
- Do not scratch or hit the surface of the panel with fingers or hard objects of any kind.
- Do not use volatile substances such as insert sprays, solvents and thinners.

#### Cabinet Cleaning Instructions

- If the cabinet becomes dirty, wipe the cabinet with a soft, dry cloth.
- If the cabinet is extremely dirty, soak a lint-free cloth in a mild detergent solution. Wring the cloth to remove as much moisture as possible. Wipe the cabinet. Use another dry cloth to wipe over until the surface is dry.
- Do not use solution that contains oil to clean the plastic parts. Such product damage the plastic parts and void the warranty.
- Do not allow any water or detergent to come into contact with the surface of the display. If water or moisture gets inside the unit, operating problems, electrical and shock hazards may result.
- Do not scratch or hit the cabinet with fingers or hard objects of any kind.
- Do not use volatile substances such as insert sprays, solvents and thinners on the cabinet.
- Do not place anything made from rubber or PVC near the cabinet for any extended periods of time.

## 9.2. Troubleshooting

Symptom	Possible Cause	Remedy
No picture is displayed	<ol style="list-style-type: none"> <li>1. The power cord is disconnected.</li> <li>2. The main power switch on the back of the display is not switched on.</li> <li>3. The selected input has no connection.</li> <li>4. The display is in standby mode.</li> </ol>	<ol style="list-style-type: none"> <li>1. Plug in the power cord.</li> <li>2. Make sure the power switch is switched on.</li> <li>3. Connect a signal connection to the display.</li> </ol>
Interference displayed on the display or audible noise is heard	Caused by surrounding electrical appliances or fluorescent lights.	Move the display to another location to see if the interference is reduced.
Color is abnormal	The signal cable is not connected properly.	Make sure that the signal cable is attached firmly to the back of the display.
Picture is distorted with abnormal patterns	<ol style="list-style-type: none"> <li>1. The signal cable is not connected properly.</li> <li>2. The input signal is beyond the capabilities of the display.</li> </ol>	<ol style="list-style-type: none"> <li>1. Make sure that the signal cable is attached firmly.</li> <li>2. Check the video signal source to see if it is beyond the range of the display. Please verify its specifications with this display's specification section.</li> </ol>
Display image doesn't fill up the full size of the screen	<ol style="list-style-type: none"> <li>1. The zoom mode is not set correctly.</li> <li>2. Scan Mode may be set incorrectly to underscan.</li> <li>3. If the image exceeds the screen size, Scan Mode may need to be set to Underscan.</li> </ol>	Use the Zoom mode or Custom zoom function in the Screen menu to fine tune display geometry and time frequency parameter.
Can hear sound, but no picture	Source signal cable is connected improperly.	Make sure that both video inputs and sound inputs are correctly connected.
Can see picture but no sound is heard	<ol style="list-style-type: none"> <li>1. Source signal cable is connected improperly.</li> <li>2. Volume is turned all the way down.</li> <li>3. {Mute} is turned on.</li> <li>4. No external speaker connected.</li> </ol>	<ol style="list-style-type: none"> <li>1. Make sure that both video inputs and sound inputs are correctly connected.</li> <li>2. Press [⊕] or [⊖] button to hear sound.</li> <li>3. Switch MUTE off by using the [MUTE] button.</li> <li>4. Connect external speakers and adjust the volume to a suitable level.</li> </ol>
Some picture elements do not light up	Some pixels of the display are off.	This display is manufactured using an extremely high level of precision technology: however, sometimes some pixels of the display may not display. This is not a malfunction.
After-Images can still be seen on the display after the display is powered off. (Examples of still pictures include logos, video games, computer images, and images displayed in 4:3 normal mode)	A still picture is displayed for an over extended period of time	Do not allow a still image to be displayed for an extended period of time as this can cause a permanent after-image to remain on the display.

## 10. Technical Specifications

### Display:

Item	Specifications
Screen Size (Active Area)	54.6" (138.7 cm) LCD
Aspect Ratio	16:9
Number of pixels	1920 (H) x 1080 (V)
Pixel pitch	0.63 (H) x 0.63 (V) [mm]
Displayable colors	8 bits, 16.7 Million colors
Brightness (typical)	700 cd/m <sup>2</sup>
Contrast ratio (typical)	1200:1
Viewing angle	178 degrees

### In/Out Terminals:

Item	Specifications
Speaker Output	Internal Speakers External Speakers
	10W (L) + 10W (R) [RMS]/8Ω 82 dB / W / M / 160 Hz ~ 13 KHz
Audio Output	Phone Jack x 1
	0.5V [rms] (Normal)
Audio Input	3.5 mm Stereo x 1
	0.5V [rms] (Normal)
IR Input	3.5mm Phone jack x 1
	IR in
RJ-45 Input/Output	RJ-45 Jack x 2 (8 pin)
	10/100 LAN Port
Control In/Out	RJ-45 Jack x 2 (8 pin)
	RS232 and IR pass through function
HDMI Input	HDMI Jack x 2 (Type A) (18 pin)
	TMDS (Video + Audio) MAX: Video - 720p, 1080p, 2160p Audio - 48 KHz / 2 Channel (L+R) Supports LPCM only
VGA Input	D-Sub Jack x 1 (15 pin)
	Analog RGB: 0.7V [p-p] (75Ω), H/CS/V: TTL (2.2kΩ), SOG: 1V [p-p] (75Ω) MAX: 1920 x 1080/60 Hz (FHD)
DVI-D	DVI-D Jack x 1 (24 pin)
	TMDS (Video) MAX: 1920 x 1080/60 Hz (FHD)
Displayport In/Out	Displayport Jack x 2 (20 pin)
	Digital RGB: TMDS (Video + Audio) MAX: Video - 720p, 1080p, 2160p Audio - 48 KHz / 2 Channel (L+R) Supports LPCM only
USB Input	USB 2.0 x 1
	For FW Update

**General:**

Item	Specifications
Power Supply	AC 100 - 240V, 50/60Hz
Power Consumption (Max)	370 W
Power Consumption (Typ.)	190 W
Power Consumption (Standby & Off)	<0.5W
Dimensions [W x H x D]	1210.48mm(W) x 681.28mm(H) x 95.25mm(D)(@wall mount)/94.33mm(D)(@handle)
Weight	27.70 Kg
Gross Weight	36.31 Kg

NOTE: OPS power consumption budget is 64W.

**Environmental Condition:**

Item		Specifications
Temperature	Operational	0 ~ 40°C
	Storage	-20 ~ 60°C
Humidity	Operational	20 ~ 80% RH (No condensation)
	Storage	5 ~ 95% RH (No condensation)
Altitude	Operational	0 ~ 5,000 m
	Storage / Shipment	0 ~ 9,000 m

## Warranty Policy for Philips Professional Displays

Thank you for purchasing this Philips product. Philips products are designed and manufactured with high standards and deliver high quality performance, ease of use and ease of installation. If you encounter any difficulties while using your product, we recommend that you first consult the user manual or the information in the support section of the website, where (depending on the product type) you may find a downloadable user manual, frequently asked questions, instruction videos or a support forum.

### LIMITED WARRANTY

In the unlikely event the product requires service, we will arrange for your Philips product to be serviced free-of-charge within the warranty period, provided that the product was used in accordance with the user manual (e.g. in the intended environment).

For these product categories, a partner company of Philips is the warrantor of the product. Please check the documentation supplied with your product.

### WHO IS COVERED?

Your Warranty coverage begins from the first date of purchase of the product. You need to provide proof of purchase to receive warranty service. A valid sales receipt or other valid document showing that you purchased the product is considered proof of purchase.

### WHAT IS COVERED?

If any defect due to faulty materials and/or workmanship occurs within the warranty period, we will make arrangements for a free of charge service. Where a repair is not possible or not commercially viable, we may replace the product with a new or equivalent refurbished product with similar functionality. Replacement will be offered at our discretion and the warranty will continue from the date of original purchase of the first date of purchase of the product. Please note that all parts, including repaired and replaced parts, are covered only for the duration of the original warranty period.

### WHAT IS EXCLUDED? Your warranty does not cover:

- Consequential damages (including but not limited to loss of data or loss of income), nor compensation for activities done by yourself, such as regular maintenance, installing firmware updates or saving or restoring data (Some states do not allow the exclusion of incidental or consequential damages, so the above exclusion may not apply to you. This includes, but is not limited to, prerecorded material, whether copyrighted or not copyrighted.)
- Labor charges for installation or setup of the product, adjustment of customer controls on the product, and installation or repair of various types of external devices (e.g., WiFi, antenna, USB dongles, OPS type devices) and other systems outside of the product.
- Reception problems caused by signal conditions or cable or antenna systems outside the unit.
- A product that requires modification or adaptation to enable it to operate in any country other than the country for which it was designed, manufactured, approved and/or authorized, or repair of products damaged by these modifications.
- If the model or production number on the product has been altered, deleted, removed or made illegible.

The warranty applies on condition that the product has been handled properly for its intended use and in accordance with the operating instructions

#### To Obtain Warranty Service And Information

For detailed warranty coverage information and additional support requirement and help line, please contact the seller and/or system integrator you purchased the product from. Please note in the USA, this limited warranty is only valid for Products purchased in the Continental United States, Alaska, and Hawaii.

#### Before Requesting Service

Please check your user's manual before requesting service. Adjustments of the controls discussed there may save you a service call.

#### WARRANTY PERIOD

Warranty period for PHILIPS signage display is listed as below, for areas not covered in this table, please follow their warranty statement.

Standard warranty period for PHILIPS signage display is listed as below, for areas not covered in this table, please follow the local warranty statement.

<b>Region</b>	<b>Standard Warranty Period</b>
USA, Canada	3 years
China	3 years
Japan	3 years
Rest of world	3 years
Mexico	3 years
Brazil	3 years
Chile	3 years
Peru	3 years

Note that for professional products, the specific warranty terms of the sale- or purchase agreement may apply.

# Index

## C

- Change Picture Format 31
- Cleaning and Troubleshooting 47
- Connecting a PC 26
- Connecting Audio Equipment 27
- Connecting External Equipment 26
- Connecting External Equipment (Multimedia Player) 26
- Connecting Multiple Displays in a Daisy-chain Configuration 28
- Control Panel 21

## I

- Input Mode 42
- Input/Output Terminals 22
- Installation Notes 15
- IR connection 30

## M

- Mounting in Portrait Orientation 17
- Mounting on a Wall 16

## N

- Navigating the OSD Menu 31

## O

- Operating Instructions of Edge Alignment Kit 18
- Operation 31
- OSD Menu 31
- OSD Menu Overview 31

## P

- Package Contents 15
- Parts and Functions 21
- Pixel Defect Policy 44

## R

- Remote Control 23

## S

- Safety Instructions 1

## T

- Technical Specifications 49

## U

- Unpacking 10
- Unpacking and Installation 10
- Using the Edge Finishing Kit (Optional) 19
- Using the Gap Pad 20

## W

- Warranty Policy for Philips Professional Displays 51
- Watch the Connected Video Source 31



2026 © TOP Victory Investments Ltd. All rights reserved.

This product has been manufactured by and is sold under the responsibility of Top Victory Investments Ltd., and Top Victory Investments Ltd. is the warrantor in relation to this product. Philips and the Philips Shield Emblem are registered trademarks of Koninklijke Philips N.V. and are used under license.

Specifications are subject to change without notice.  
Version: V1.00 2026-05-05