

# EVNIA

27M2N6591L



EN

## User manual

Register your product and get support at [www.philips.com/welcome](http://www.philips.com/welcome)

# PHILIPS

# Table of Contents

<b>1. Important .....</b>	<b>1</b>
1.1 Safety precautions and maintenance .....	1
1.2 Notational Descriptions .....	3
1.3 Disposal of product and packing material .....	4
<b>2. Setting up the monitor .....</b>	<b>5</b>
2.1 Installation .....	5
2.2 Operating the monitor .....	7
2.3 Remove the Base Assembly for VESA Mounting .....	11
2.4 MultiView .....	12
<b>3. Image Optimization .....</b>	<b>15</b>
3.1 SmartImage .....	15
3.2 SmartContrast .....	17
3.3 Customize color space .....	17
<b>4. Adaptive Sync .....</b>	<b>18</b>
<b>5. Ambiglow .....</b>	<b>19</b>
<b>6. HDR .....</b>	<b>20</b>
<b>7. Screen maintenance .....</b>	<b>21</b>
<b>8. Technical Specifications .....</b>	<b>25</b>
8.1 Resolution & Preset Modes .....	28
<b>9. Power Management .....</b>	<b>30</b>
<b>10. Customer care and warranty ..</b>	<b>31</b>
10.1 Philips' Flat Panel Monitors Pixel Defect Policy .....	31
10.2 Customer Care & Warranty ....	34
<b>11. Troubleshooting &amp; FAQs .....</b>	<b>35</b>
11.1 Troubleshooting .....	35
11.2 General FAQs .....	36
11.3 Multiview FAQs .....	39
11.4 OLED Screen Cleaning Method .....	40

# 1. Important

This electronic user's guide is intended for anyone who uses the Philips monitor. Take time to read this user manual before you use your monitor. It contains important information and notes regarding the operation of your monitor.

The Philips guarantee applies provided that the product is handled for its intended use, by its operating instructions, and accompanied by the presentation of the original invoice or cash receipt that indicates the date of purchase, dealer's name and model, and production number of the product.

## 1.1 Safety precautions and maintenance

---

### Warnings

The use of controls, adjustments, or procedures other than those specified in this document may result in exposure to shock, electrical hazards, and/or mechanical hazards.

Read and follow these instructions when connecting and using your monitor.

Excessive sound pressure from earphones and headphones can cause hearing loss. Adjustment of the equalizer to maximum capacity increases the earphones and headphones output voltage; thereby increasing the sound pressure level.

### Operation

- Please keep the monitor out of direct sunlight. Lengthy exposure to this type of environment may result in discoloration and damage to the monitor.

- Keep the display away from oil. Oil may damage the plastic cover of the display and void the warranty.
- Remove any object that could fall into ventilation holes or prevent proper cooling of the monitor's electronics.
- Do not block the ventilation holes in the cabinet.
- When positioning the monitor, make sure the power plug and outlet are easily accessible.
- If turning off the monitor by detaching the power cable or DC power cord, wait for 6 seconds before attaching the power cable or DC power cord before returning to normal operation.
- Please use the approved power cord provided by Philips all the times. If your power cord is missing, please contact your local service center. (Please refer to the Service contact information located in the Important information manual.)
- Operate under the specified power supply. Use of incorrect voltage will cause malfunction and may cause fire or electric shock.
- Protect the cable. Do not pull or bend the power cable and signal cable. Do not place the monitor or any other heavy objects on the cables. If damaged, the cables may cause fire or electric shock.
- Do not subject the monitor to severe vibration or high-impact conditions during operation.
- To avoid potential damage, like the panel peeling from the bezel, ensure that the monitor does not tilt downward by more than -5 degrees. If the -5 degree downward tilt angle maximum is exceeded, the monitor

damage will not be covered under warranty.

- Do not knock or drop the monitor during operation and/or transportation.
- Excessive usage of the monitor can cause eye discomfort. It's recommended to take shorter breaks more often at your workstation than longer breaks and less often. For example, a 5-10 minute break after 50-60-minute continuous screen use is likely to be better than a 15-minute break every two hours. Prevent eye strain while using the screen for a constant period by :
  - Looking at something varying distances after a long period of focusing on the screen.
  - Conscious Blinking while you work.
  - Gently closing and rolling your eyes to relax.
  - Reposition your screen to the appropriate height and angle.
  - Adjust the brightness and contrast to an appropriate level.
  - Adjust the environment lighting similar to that of your screen brightness. Avoid fluorescent lighting and surfaces that don't reflect too much light.
  - Seeing a doctor if your symptoms worsen.

## Maintenance

- To protect your monitor from possible damage, do not put excessive pressure on the QD OLED panel. When moving your monitor, grasp the frame to lift; do not lift the monitor by placing your hand or fingers on the QD OLED panel.

- Oil-based cleaning solutions may damage the plastic parts and void the warranty.
- Unplug the monitor if you are not going to use it for an extensive period.
- Unplug the monitor if you need to clean it with a slightly damp cloth. The screen may be wiped with a dry cloth when the power is off. However, never use organic solvents, such as alcohol or ammonia-based liquids.
- To avoid the risk of shock or permanent damage to the set, do not expose the monitor to dust, rain, water, or excessive moisture.
- If your monitor gets wet, wipe it with a dry cloth as soon as possible.
- If a foreign substance or water gets in your monitor, please turn the power off immediately and disconnect the power cord. Then, if damaged, send it to the maintenance center.
- Do not store or use the monitor in locations exposed to heat, direct sunlight, or extreme cold.
- To maintain the best performance of your monitor and use it for a longer lifetime, please use the monitor in a location that falls within the following temperature and humidity ranges:
  - Temperature: 0°C-40°C 32°F-104°F
  - Humidity: 20%-80% RH

## Important information for Burn-in/ Ghost image

- Please always turn on the Screen Saver and Pixel Orbiting functions from the On Screen Display (OSD) menu. For additional information, please refer to Chapter 8 on Screen Maintenance.

- “Burn-in”, “after-imaging”, or “ghost imaging” is a well-known phenomenon in QD OLED panel technology. In most cases, the “burn-in”, “after-imaging” or “ghost imaging” will disappear gradually over some time after the power has been switched off.

 **Warning**

It is highly recommended that you always turn on the Screen Saver and Pixel Orbiting function from On Screen Display (OSD) menu in order to best protect the screen.

Service

- The casing cover should be opened only by qualified service personnel.
- If there is any need for any document for repair or integration, please contact your local service center. (You can refer to the service contact information listed in the important information manual.)
- For transportation information, please refer to “Technical Specifications”.
- Do not leave your monitor in a car under direct sunlight.

 **Note**

Consult a service technician if the monitor does not operate normally or you are not sure what procedure to take when the operating instructions given in this manual.

## 1.2 Notational Descriptions

---

The following subsections describe the notational conventions used in this document.

### Notes, Cautions, and Warnings

Throughout this guide, blocks of text may be accompanied by an icon and printed in bold or italic type. These blocks contain notes, cautions, and/or warnings.

They are used as follows:

 **Note**

This icon indicates important information and tips that help you make better use of your computer system.

 **Caution**

This icon indicates information that tells you how to avoid either potential damage to the hardware or loss of data.

 **Warning**

This icon indicates the potential for bodily harm and tells you how to avoid the problem.

Some warnings may appear in alternate formats and may not be accompanied by an icon. In such cases, the specific presentation of the warning is mandated by the relevant regulatory mechanism.

### 1.3 Disposal of product and packing material

---

#### Waste Electrical and Electronic Equipment-WEEE



This marking on the product or its packaging illustrates that, under European Directive 2012/19/EU governing used electrical and electronic appliances, this product may not be disposed with normal household waste. You are responsible for the disposal of this equipment through a designated waste electrical and electronic equipment collection. To determine the locations for dropping off such waste, contact your local government office, the waste disposal organization that serves your household, or the store at which you purchased the product.

Your new monitor contains materials that can be recycled and reused. Specialized companies can recycle your product to increase the number of reusable materials and minimize the amount to be disposed of.

All redundant packing material has been omitted. We have done our utmost to make the packaging easily separable into mono materials.

Please find out about the local regulations on how to dispose of your old monitor and packing from your sales representative.

#### Taking back/Recycling Information for Customers

Philips establishes technically and economically viable objectives to optimize the environmental performance of the organization's products, services, and activities.

From the planning, design, and production stages, Philips emphasizes the importance of making products that can easily be recycled. At Philips, end-of-life management primarily entails participation in national take-back initiatives and recycling programs whenever possible, preferably in cooperation with competitors, which recycle all materials (products and related packaging material) following all Environmental Laws and taking back programs with the contractor company.

Your display is manufactured with high-quality materials and components which can be recycled and reused.

To learn more about our recycling program please visit:

<http://www.philips.com/a-w/about/sustainability.html>

## 2. Setting up the monitor

### 2.1 Installation

#### 1 Package contents



TTTT  
Screw  
M4 x 4



Power



\*HDMI



\*DP



\*USB A-B

\*Different according to region

#### 2 Install the base

1. Place the monitor face down on a smooth surface. Pay attention not to scratch or damage the screen.

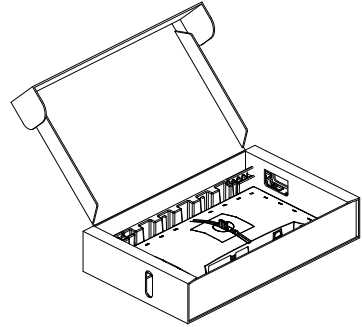

2. Hold the stand with both hands.
  - (1) Gently attach the base to the stand.
  - (2) Use your fingers to tighten the screw located at the bottom of the base.
  - (3) Gently attach the stand to the VESA mount area until the latch locks the stand.

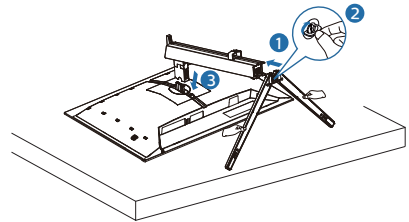

#### ⚠ Caution

Place the monitor face down on a smooth surface. Pay attention not to scratch or damage the screen.

### 3 Connecting to your PC

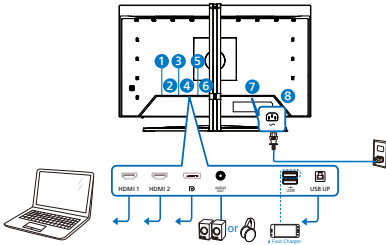

USB hub

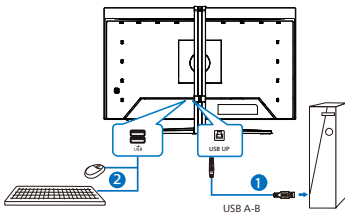

Headphone hook

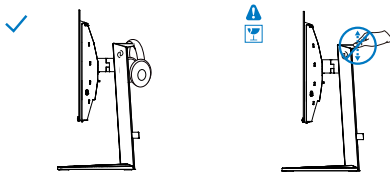

- 1 HDMI 1 input
- 2 HDMI 2 input
- 3 DisplayPort input
- 4 Audio Out
- 5 USB fast charger/USB downstream
- 6 USB UP
- 7 AC/DC power input
- 8 Kensington anti-theft lock

#### Connect to PC

1. Connect the power cord to the back of the monitor firmly.
2. Turn off your computer and unplug its power cable.
3. Connect the monitor signal cable to the video connector on the back of your computer.

4. Plug the power cord of your computer and your monitor into a nearby outlet.
5. Turn on your computer and monitor. If the monitor displays an image, installation is complete.

#### Note

The headphone holder is securely integrated with the monitor stand and is specifically designed for headset storage. Please note that excessive pulling/dragging on the hook, which effectively goes beyond its intended use, may result in damage.

## 2.2 Operating the monitor

### 1 Description of the control buttons

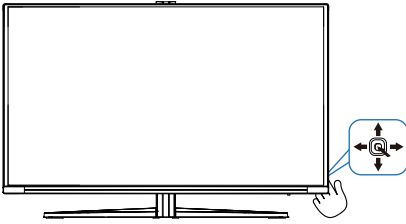

1		Press to switch power on. Press more than 3 seconds to switch power off.
2		Access the OSD menu. Confirm the OSD adjustment.
3		Adjust the Game Mode. Adjust the OSD menu.
4		Change the signal input source. Adjust the OSD menu.
5		SmartImage Game menu. There are multiple selections: Standard, Illustrator, FPS, Racing, RTS, Movie, LowBlue Mode, EasyRead, Economy, Game1 and Game2. When the monitor receives HDR signal, SmartImage will show the HDR menu. There are multiple selections in this menu: HDR Game, HDR Movie, HDR Vivid, Personal, and Off. Return to previous OSD level.

### 2 Description of the On-Screen Display

What is On-Screen Display (OSD)?

On-Screen Display (OSD) is a feature in all Philips LED monitors. It allows an end user to adjust screen performance or select functions of the monitors directly through an on-screen instruction window. A user-friendly OSD interface is shown below:

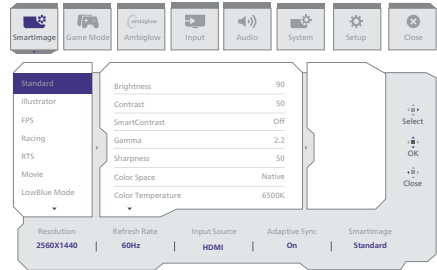

Basic and simple instructions on the control keys

To access the OSD menu on this Philips display, simply use the single toggle button located on the rear side of the display. The single button operates like a joystick. To move the cursor, simply toggle the button in four directions. Press the button to select the desired option.

The OSD Menu

Below is an overall view of the structure of the On-Screen Display. You can use this as a reference when you want to work your way around the different adjustments later on.

Main menu	Sub menu				
SmartImage	Standard, Illustrator, FPS, Racing, RTS, Movie, LowBlue Mode, EasyRead, Economy, Game1, Game2	Brightness	0-100		
		Contrast	0-100		
		SmartContrast	On, Off		
		Gamma	1.8, 2.0, 2.2, 2.4, 2.6		
		Sharpness	0-100		
		Color Space	Native, sRGB, DCI-P3, Adobe RGB		
		Color Temperature	Native, Preset, 5000K, 6500K, 7500K, 8200K, 9300K, 11500K		
		R.G.B. Settings	On, Off		
		Red	0-100		
		Green	0-100		
		Blue	0-100		
		Reset	Yes, No		
		SmartImage(HDR) (HDR source)	HDR Game, HDR Movie, HDR Vivid, Personal	Brightness	0-100
				Contrast	0-100
				Light Enhancement	0-3
				Color Enhancement	0-3
				Reset	Yes, No
		Game Mode	Off	Adaptive Sync	Adaptive Sync On, Adaptive Sync Off
				Crosshair	Off, On, Smart Crosshair On
				Stark ShadowBoost	Off, Level 1, Level 2, Level 3
Smart Sniper	Size Off, 1.0, 1.5, 2.0				
Low Input Lag	Position			Top, Central	
	Low Input Lag On, Low Input Lag Off				
SmartFrame	SmartFrame Off				
	SmartFrame On				
	Size			1.2, 3.4, 5.6, 7	
	Brightness			0-100	
	Contract			0-100	
	H. Position			0-Max	
V. Position	0-Max				
Ambiglow	Light Mode			Follow Video	
				Color Shift	
		Color Wave			
		Color Breathing			
		Starry Night			
	Static Mode				
	Ambiglow Setting	Colors	Rainbow, White, Red, Rose, Magenta, Violet, Blue, Azure, Cyan, Aqua, Green, Pear, Yellow, Orange		
		Brightness	Bright, Brighter, Brightest		
		Speed	Low, Normal, High		
	Reset	Yes, No			
Ambiglow Off					
Input	Input	HDMI 1			
		HDMI 2			
		DisplayPort			
		Auto	On, Off		
Audio	Volume	Volume(0-100)	0-100		
		Mute	Mute On, Mute Off		
		Audio Source	HDMI 1, HDMI 2, DisplayPort		
System	HDMI Refresh Rate	HDMI 1	144Hz, 240Hz		
		HDMI 2	144Hz, 240Hz		
	OSD Setting	Horizontal	0-100		
		Vertical	0-100		
		Transparency	Off, 1, 2, 3, 4		
		OSD Time out	5s, 10s, 20s, 30s, 60s		
	PIP/PBP	PIP/PBP Mode	Off, PIP, PBP		
		PIP/PBP Input	HDMI 1, HDMI 2, DisplayPort		
		PIP-Size	Small, Middle, Large		
		PIP-Position	Top-R, Top-L, Bottom-R, Bottom-L		
		Swap			
	Smart Size	Screen Size	27"W, 24"W, 23"W, 22"W, 21.5"W, 20"W, 19.5"W, 19"W, 18.5"W, 17"		
1:1					
4:3					
Over Scan	Over Scan On, Over Scan Off				
Setup	Power LED	0-4			
		Language	English, Deutsch, Español, Ελληνικά, Français, Italiano, Magyar, Nederlands, Português, Português do Brasil, Polski, Pycckoe, Svenska, Suomi, Türkçe, Čeština, 日本語, 繁體中文, 简体中文, 越南語		
		Resolution Notice	Resolution Notice On, Resolution Notice Off		
		OLED Panel Care	Screen Saver	Off, Slow, Fast	
			Pixel Orbiting	Off, Slow, Normal, Fast	
			Auto Pixel Refresh	On, Off	
			Pixel Refresh	Proceed	
			UniBright	On, Off	
			Multi-Logo Protection	Off, 1, 2, 3, 4	
			Boundary Dimmer	Off, 1, 2, 3, 4	
			Taskbar Dimmer	Off, 1, 2, 3, 4	
		Thermal Protection	On, Off		
		OLED Information	Working Time		
			Time after Pixel Refresh		
			Pixel Refresh Counts		
Information	Model				
	SN				
Reset	Yes, No				

Close

## ☰ Note

- **Game mode:** This model is equipped with new features in OSD which gives you high-quality visual experience.
  - **Stark ShadowBoost**  
This feature enhances dark scenes without overexposing lightened areas. The Stark ShadowBoost feature has three selectable levels that offer texturized images with better color saturation with higher contrast so you can see better in both light and dark environments. In addition, this feature helps you fine-tune your sight so that enemies get exposed more quickly when gaming.
  - **Smart Crosshair**  
Color of Crosshair is set by default. When Smart Crosshair is on, the color will change as complementary color to the background color. Smart Crosshair enhances the accuracy of aiming so you can spot the enemies more easily.
  - **Smart Sniper**  
This feature overlays a zoom window of 1.0x, 1.5x, or 2.0x magnification for precise aiming. It can be placed at the center or top of the screen.
- Please refer to Chapters 7 on Screen Maintenance for details of **OLED Panel Care**.

## 3 Resolution notification

This monitor is designed for optimal performance at its native resolution:2560 x 1440.

When the monitor is powered on at a different resolution, an alert is displayed on the screen as follows: Use 2560 x 1440 for best results.

Display of the native resolution alert can be switched off from Setup in the OSD (On Screen Display) menu.

## 4 Firmware

The over-the-air (OTA) firmware update is through the Evnia Precision Center software and is easily downloadable through the Philips website. What does Evnia Precision Center do? It is an additional software that helps control the photo, audio, and the other on-screen graphic settings of the monitor.

In the "Setup" section, you can check which firmware version you currently have and if you need to upgrade or not. In addition, it is important to note that the firmware upgrades must be done through the Evnia Precision Center software. It is necessary to be connected to a network when updating the firmware on Evnia Precision Center over-the-air (OTA).

## 5 Physical Function

### Tilt

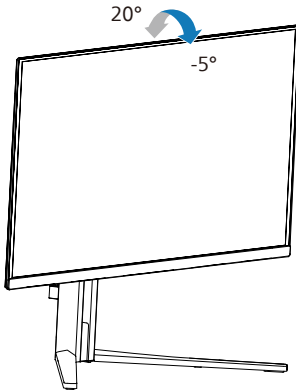

### Height adjustment

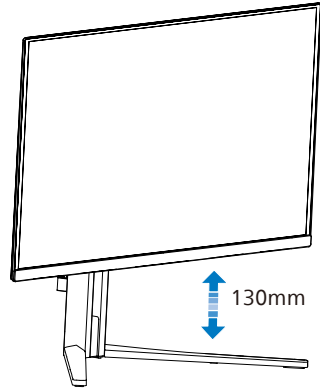

### Swivel

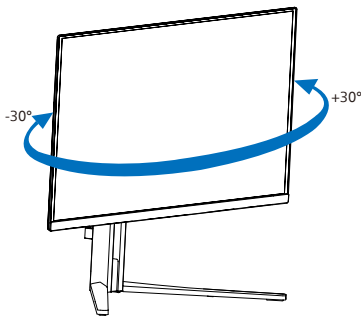

### Pivot

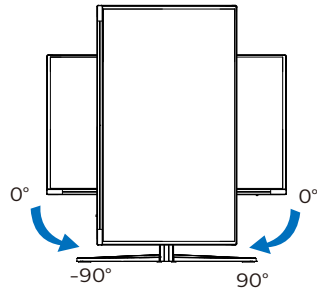

### ⚠ Warning

- To avoid potential screen damage, such as panel peeling, ensure that the monitor does not tilt downward by more than  $-5$  degrees.
- Do not press the screen while adjusting the angle of the monitor. Grasp only the bezel.

## 2.3 Remove the Base Assembly for VESA Mounting

Before you start disassembling the monitor base, please follow the instructions below to avoid any possible damage or injury.

1. Place the monitor face down on a smooth surface. Pay attention not to scratch or damage the screen. Then lift the monitor stand.

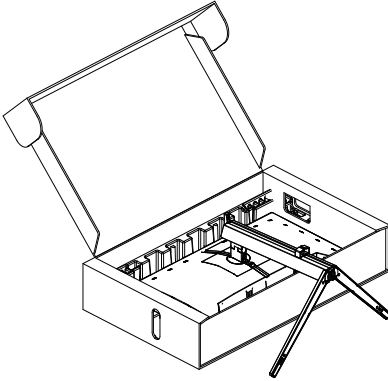

2. While keeping the release button pressed, tilt the stand and slide it out.

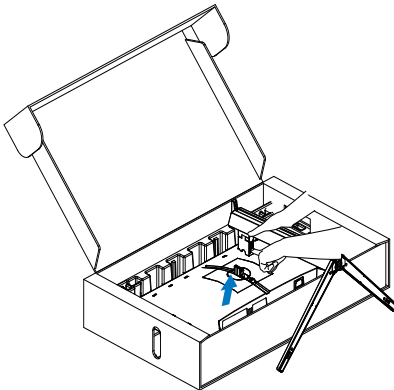

3. Press the button to remove the rear pillar cover

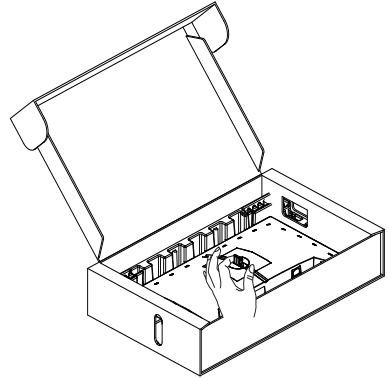

4. Remove VESA Mounting

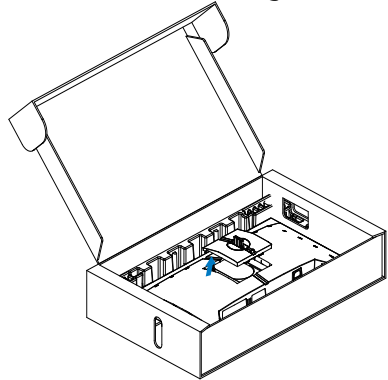

### Note

- This monitor accepts a 100mm x 100mm VESA-Compliant mounting interface. VESA Mounting Screw M4. Always contact the manufacturer for wall-mount installation.
- The two dimensions on the left side of the wall-mounted threaded column are 7.8mm, and the two on the right side are 14.2mm. The depth of the installation holes (including the size of the rear cover) on the left side is 11.5mm, and on the right side it is 16.3mm.

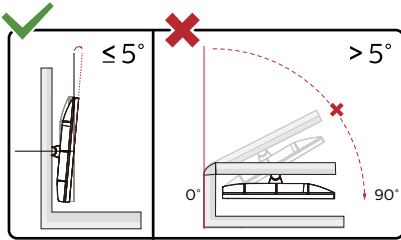
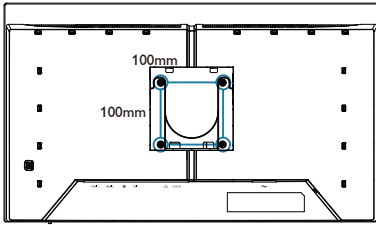

\* Display design may differ from those illustrated in this manual.

### ⚠ Warning

- To avoid potential screen damage, such as panel peeling, ensure that the monitor does not tilt downward by more than -5 degrees.
- Do not press the screen while adjusting the angle of the monitor. Grasp only the bezel.

## 2.4 MultiView



### 1 What is it?

Multiview enables active variety to connect and view so that you can work with multiple devices like PC and Notebook side-by-side simultaneously, thereby making complex multitasking work a breeze.

### 2 Why do I need it?

With the ultra-high-resolution Philips MultiView display, you can comfortably experience a world of connectivity in the office or at home. With this display, you can conveniently enjoy multiple content sources on one screen. For example, You may want to keep an eye on the live news video feed with audio in the small window, while working on your latest blog... or you may want to edit an Excel file from your Ultrabook, while logged into a secured company intranet to access files from a desktop.

### 3 How to enable MultiView by OSD menu?

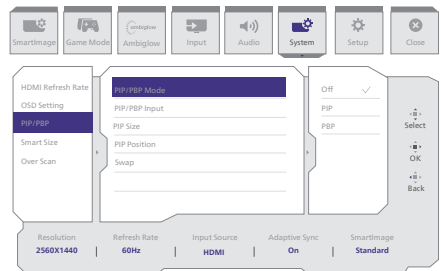

1. Toggle to the right to enter OSD Menu Screen.
2. Toggle to the up or down to select main menu [PIP / PBP], then toggle to the right to confirm.
3. Toggle to the up or down to select [PIP / PBP Mode], then toggle to the right.
4. Toggle to the up or down to select [PIP], [PBP], then toggle to the right to confirm your selection.
5. Now you can move backward to set the [PIP / PBP Input], [PIP Size], [PIP Position] or [Swap].

Toggle to the right to confirm your selection.

#### 4 MultiView in OSD menu

- PIP / PBP Mode: There are two modes for MultiView: [PIP] and [PBP].

[PIP]: Picture in Picture

Open up a sub-window of another signal source.

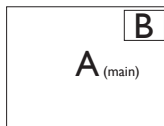

When the sub source is not detected:

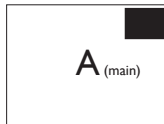

[PBP]: Picture by Picture

Open up a sub-window side-by-side of other signal sources.

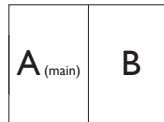

When the sub source is not detected.



#### Note

The black strip located on the top and the bottom of the screen is for measuring the correct aspect ratio when in the PBP mode. If you expect to see full-screen, adjust your device's resolutions to pop-up attention resolution and you will be able to see 2 devices' source screen project to this display without black strips. It is important to note that the analog signal is not supported on full screen in PBP mode.

- PIP / PBP Input: There are different video inputs to choose from as the sub-display source: [HDMI 1], [HDMI 2], [DP].

Please refer to the table below for compatibility of the main/sub-input source.

MultiView		SUB SOURCE POSSIBILITY (x1)		
		Inputs	HDMI 1	HDMI 2
MAIN SOURCE (x1)	HDMI 1	•	•	•
	HDMI 2	•	•	•
	DisplayPort	•	•	•

- PIP Size: When PIP is activated, there are three sub-window sizes to choose from [Small], [Middle], and [Large].

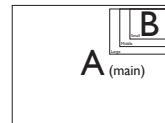

- PIP Position: When PIP is activated, there are four sub-window positions to choose from.

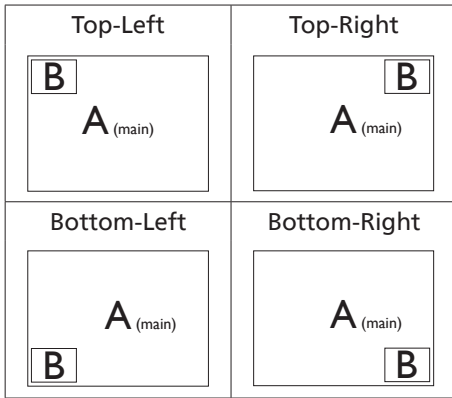

- Swap: The main picture source and the sub-picture source are swapped on the display.

Swap A and B source in [PIP] mode:

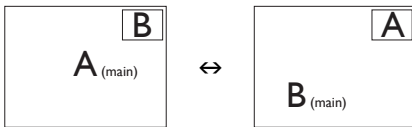

Swap A and B source in [PBP] mode:



- Off: Stop MultiView function.

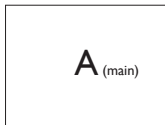

### ⊖ Note

When you activate the SWAP function, the video and its audio source will swap at the same time.

# 3. Image Optimization

## 3.1 SmartImage

### 1 What is it?

SmartImage provides presets that optimize display for different types of content, dynamically adjusting brightness, contrast, color, and sharpness in real-time. Whether you're working with text applications, displaying images, or watching a video, Philips SmartImage delivers great monitor performance.

### 2 Why do I need it?

It is ideal to have a monitor that delivers an optimized display of all your favorite types of content. Our SmartImage software dynamically adjusts brightness, contrast, color, and sharpness in real-time to enhance your monitor viewing experience.

### 3 How does it work?

SmartImage is an exclusive, leading-edge Philips technology that analyzes the content displayed on your screen. Based on the scenario you select, SmartImage dynamically enhances the contrast, color saturation, and sharpness of images to enhance the contents being displayed - all in real time by the press of a single button.

### 4 How to enable SmartImage?

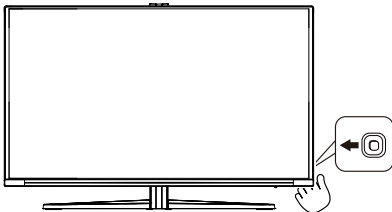

1. Toggle to the left to launch the SmartImage on-screen display.

2. Toggle the up or down to select between the SmartImage modes.
3. The SmartImage on-screen display will remain on screen for 5 seconds, or you can also toggle to the left to make confirmation.

There are multiple selections: Standard, Illustrator, FPS, Racing, RTS, Movie, LowBlue Mode, EasyRead, Economy, Game1 and Game2.

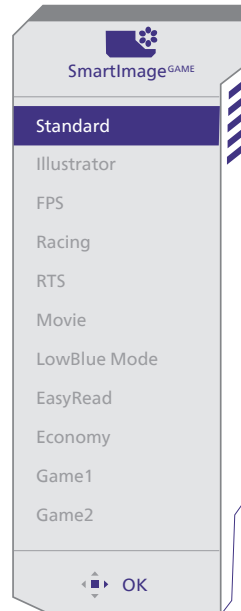

- **Standard:** Enhances text and dampens brightness to increase readability and reduce eye strain. This mode significantly enhances readability and productivity when working with spreadsheets, PDF files, scanned articles, or other similar office applications.
- **Illustrator:** Catering to creators, this setting enables users to select a color space that best suits their needs.
- **FPS:** For playing FPS (First Person Shooters) games. Improves dark theme black level details.

- **Racing:** For playing Racing games. Provides the fastest response time and high color saturation.
- **RTS:** For playing RTS (Real Time Strategy) games, a user-selected portion can be highlighted for RTS games (through SmartFrame). The picture quality can be adjusted for the highlighted portion.
- **Movie:** Ramped up luminance, deepened color saturation, dynamic contrast, and razor sharpness displays every detail in darker areas of your videos without experiencing color washout.
- **LowBlue Mode:** LowBlue Mode for easy-on-the-eyes productivity. Studies have shown that just as ultra-violet rays can cause eye damage, shortwave length blue light rays from LED displays can cause eye damage and affect vision over time. Developed for well-being, the Philips LowBlue Mode setting uses smart software technology to reduce harmful shortwave blue light.
- **EasyRead:** Helps improve reading of text-based applications like PDF ebooks. By using a special algorithm that increases the contrast and boundary sharpness of text content. The display is optimized for a stress-free reading by adjusting the brightness, contrast, and color temperature of the monitor.
- **Economy:** Under this profile, brightness and contrast are adjusted and backlighting is fine-tuned to produce the right display for everyday office applications.
- **Game1:** User's preference settings saved as Game1.
- **Game2:** User's preference settings saved as Game2.

When this display receives an HDR signal from the connected device, select a picture mode that best fits your needs.

There are 5 modes to select: HDR Game, HDR Movie, HDR Vivid, Personal, and Off.

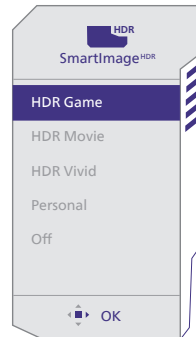

- **HDR Game:** Ideal setting to optimize for playing video games. With brighter white and darker black, the gaming scene is vivid and reveals more details, easily spotting enemies hiding in the dark corner and shadows.
- **HDR Movie:** Ideal setting for watching HDR movies. Deliver better contrast and brightness for a more realistic and immersing viewing experience.
- **HDR Vivid:** Enhancing red, green, and blue for true-to-life visuals.
- **Personal:** Customize available settings in the picture menu.
- **Off:** No optimization by SmartImage HDR.

**Note**

To switch off the HDR function, please disable the Input device and its content. Inconsistent HDR settings between the input device and monitor may cause unsatisfying images.

## 3.2 SmartContrast

---

### 1 What is it?

It is a unique technology that dynamically analyzes displayed content and automatically optimizes a monitor's contrast ratio for maximum visual clarity and viewing enjoyment.

### 2 Why do I need it?

Because SmartContrast offers the best visual clarity and viewing comfort for every type of content. It dynamically controls contrast and adjusts backlighting for bright gaming and video imagery. In addition, by reducing your monitor's power consumption, you save on energy costs and extend the lifetime of your monitor.

### 3 How does it work?





When you activate SmartContrast, it will analyze the content you are displaying in real time to adjust colors and control backlight intensity. This function will dynamically enhance contrast for a great entertainment experience when viewing videos or playing games.

## 3.3 Customize color space

---

You can manually select the appropriate color space mode to properly display the content you are viewing.

### 1 Select appropriate color space mode to fit the content you're viewing:

1. Press  button to enter OSD menu.
2. Press  or  button to select main menu [SmartImage], then press OK button.
3. Press  or  button to select [Color Space].
4. Select one of colors modes.
5. Press OK button to confirm your selection.

### 2 There are multiple selections:

- **Native:** The full range of colors that the display is capable of.
- **sRGB:** Most personal computer applications and games, Internet, and web design.
- **DCI-P3:** Digital cinema projectors, some movies and games, and Apple products. Photography.
- **Adobe RGB:** Graphics applications.



### Note

HDR and color space mode cannot be enabled simultaneously. Please disable HDR before you select one of color space modes.

## 4. Adaptive Sync



### Adaptive Sync

PC gaming has long been an imperfect experience because GPUs and monitors update at different rates. Sometimes a GPU can render many new pictures during a single update of the monitor, and the monitor will show pieces of each picture as a single image. This is called “tearing.” Gamers can fix tearing with a feature called “v-sync,” but the image can become jerky as the GPU waits on the monitor to call for an update before delivering new pictures.

The responsiveness of mouse input and overall frames per second are reduced with v-sync, too. AMD Adaptive Sync technology eliminates all of these problems by letting the GPU update the monitor the moment a new picture is ready, leaving gamers with unbelievably smooth, responsive, tearing-free games.

Followed by the graphic card that are compatible.

- Operating system
  - Windows 11/10
- Graphic Card: R9 290/300 Series & R7 260 Series
  - AMD Radeon R9 300 Series
  - AMD Radeon R9 Fury X
  - AMD Radeon R9 360
  - AMD Radeon R7 360
  - AMD Radeon R9 295X2
  - AMD Radeon R9 290X
  - AMD Radeon R9 290
  - AMD Radeon R9 285
  - AMD Radeon R7 260X
  - AMD Radeon R7 260
- Processor A-Series Desktop and Mobility APUs
  - AMD A10-7890K
  - AMD A10-7870K
  - AMD A10-7850K
  - AMD A10-7800
  - AMD A10-7700K
  - AMD A8-7670K
  - AMD A8-7650K
  - AMD A8-7600
  - AMD A6-7400K
  - AMD RX 6500 XT
  - AMD RX 6600 XT
  - AMD RX 6700 XT
  - AMD RX 6750 XT
  - AMD RX 6800
  - AMD RX 6800 XT
  - AMD RX 6900 XT

## 5. Ambiglow

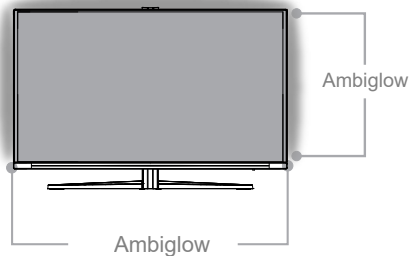

### 1 What is it?

Ambiglow adds a new dimension to your viewing experience. The innovative and exclusive Ambiglow processor continuously adjusts the overall color and brightness of the gamer's surroundings to match the on-screen image. User options like Auto mode and 3-step brightness settings allow you to adjust the ambiance to your liking and available wall surface. Whether you are playing games or watching movies, Philips Ambiglow offers you a unique and immersive viewing experience.

### 2 How does it work?

It is recommended that you dim the lighting conditions in your room for maximum effect. Ensure that Ambiglow is set to "on" mode. Start a movie or play a game from your computer. The monitor will react with appropriate colors creating a halo effect and will match the image on the screen. You can also manually select Bright, Brighter, Brightest mode, or off mode, depending on your preference.

### 3 How to enable Ambiglow

The Ambiglow function can be accessed through the OSD menu. To enable it, follow these steps:

1. Move the joystick to the right to open the OSD menu and navigate to the Ambiglow section.
2. Turn Ambiglow on and choose from various lighting effects (default: Ambiglow Off).
3. Press the joystick to the right again to confirm your selection.

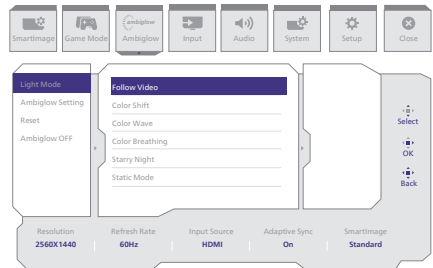

### Note

The features shown are for illustrating lighting effects only. Actual lighting functionality may vary by product specifications. Please refer to the actual product for final details.

## 6. HDR

HDR Settings in Windows 11/10 system.

### Steps

1. Right-click on the desktop, and enter Display settings.
2. Select the display/monitor.
3. Select an HDR-capable display under Rearrange your displays.
4. Select Windows HD Color settings.
5. Adjust Brightness for SDR content.

### Note

Windows 11/10 edition is required. Always upgrade to the most updated version. The link below is for further information from the Microsoft official website.

<https://support.microsoft.com/en-au/help/4040263/windows-10-hdr-advanced-color-settings>

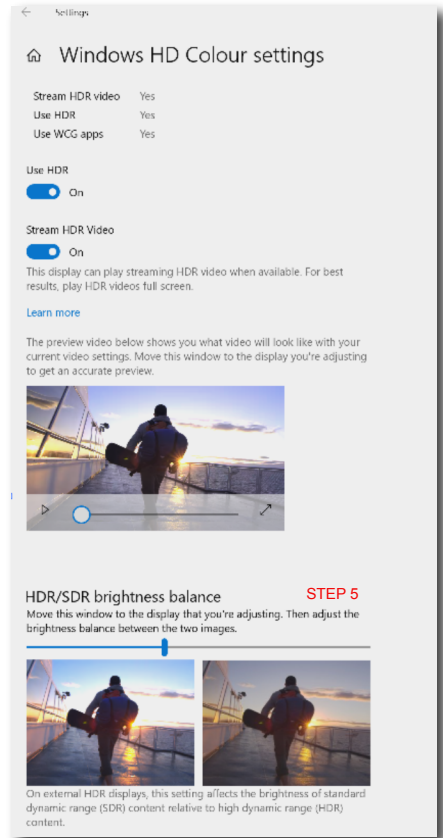
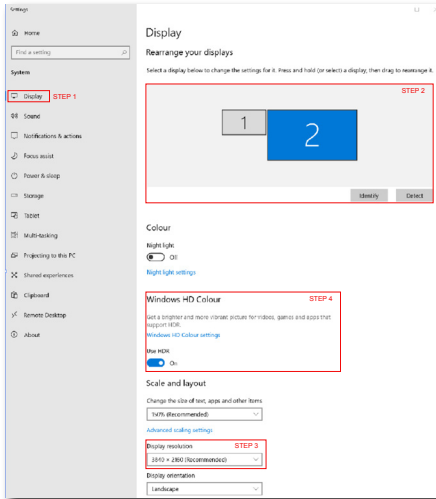

### Note

To switch off the HDR function, please disable it from an Input device and its content. Inconsistent HDR settings between the input device and monitor may cause unsatisfying images.

## 7. Screen maintenance

Following the characteristics of QD OLED displays, there are automatic mechanisms used to protect the screen and reduce image sticking which may request an opportunity to run the refresh process. These mechanism settings may be adjusted in the On-Screen Display (OSD) menu under QD OLED Panel Care.

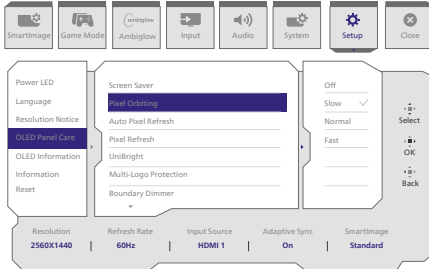

### • Screen Saver

When a static image is detected for a certain period of time, the screen saver function will dim the screen to protect the panel from image sticking, which could lead to burn-in. In contrast, when a moving image is detected, the monitor will recover luminance to previous working status. The default setting for the screen saver function is set at slow and may change to fast if needed.

### • Pixel Orbiting

The Pixel Orbiting feature moves the image a couple of pixels at regular intervals to avoid potential image sticking. In normal circumstances, this feature is not noticeable. The default setting for Pixel Orbiting is slow and you can select normal or fast to adjust the frequency of shifting. It is highly recommended that Pixel Orbiting always remains on in order to protect the screen and to protect your monitor against burn-in.

### • Pixel Refresh:

The Pixel Refresh feature helps

prevent burn-in on the monitor. When cumulative usage reaches 24 hours, the screen will automatically refresh. Additionally, countdown warning messages will appear before reaching the 24-hour limit, after which the refresh will occur automatically. Skipping Pixel Refresh is not possible, as it is a necessary feature to ensure the proper care of your monitor.

When Pixel Refresh is activated, the screen enters standby mode while the process completes, and the LED indicator will blink on and off. Once Pixel Refresh has finished, the LED indicator will stop blinking, and the monitor will return to normal activity. Please note that if the monitor remains in standby mode for over 15 minutes or the user turns off the monitor (with cumulative usage exceeding 16 hours), Pixel Refresh will automatically run. This helps maintain optimal display performance and reduces image retention.

There are Auto Pixel Refresh reminders in the On-Screen Display menu (default: On). Before the 24-hour usage limit of the screen is reached, multiple countdown warning messages will appear. When the countdown ends, the screen will perform pixel refresh.

This message is to notify you that Pixel Refresh will begin in 10 minutes: it is mandatory for proper care of your panel and cannot be skipped.

The Pixel Refresh process will take a few minutes to complete and will be indicated by a blinking power LED light.

Do not unplug the power cable while this process is underway.

### • Multi-Logo Protection

When there are multiple static logos detected on the screen, it's suggested to turn on Multi-Logo Protection; which will dim the screen to protect the panel from image sticking where logos are

detected.



**Multi-Logo  
Detected**

- **Boundary Dimmer**

For special aspect ratios that have a black area in the frame of the screen or a split-screen, the boundary dimmer feature can automatically detect and dim the brightness of specific areas with a large difference in brightness levels.



**Black Letter Detected**



**Black Pillar Detected**



- **Taskbar Dimmer**

The Taskbar Dimmer technology will dim the brightness of the taskbar area on the screen. No brightness changes will be noticeable in the areas other than in the taskbar.



Taskbar Detected

- **Thermal Protection**

When the temperature of the monitor is over 60 degrees Celsius, the Thermal Protection feature will automatically dim the brightness of the screen in order to ensure heat dissipation properly. It is recommended that you turn on the feature for the monitor.

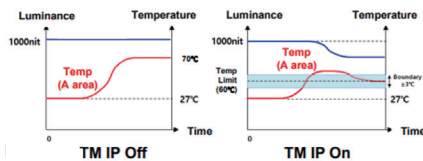

⊖ **Note**

Please note that if the temperature inside the monitor's shell reaches a temperature of over 45 degrees Celsius, Pixel Refresh nor Panel Refresh can be activated.

## LED Indicator

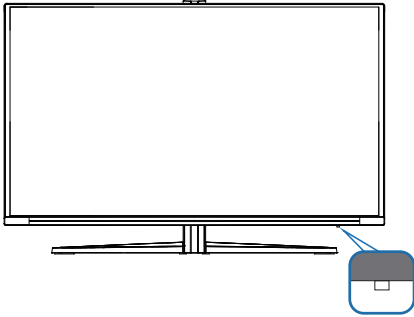

Please refer to the table below to check the different LED indicator statuses.

ITEMS	Power LED
Pixel Refresh	White (fash blink)
Panel Error Detected	Amber (Stable)
Power on	White (Stable)
Stand by	Breathing Light
Power off	No color/light

## 8. Technical Specifications

Picture/Display	
Monitor Panel Type	QD OLED
Panel Size	26.5" W (67.3 cm)
Aspect Ratio	16:9
Pixel Pitch	0.2292 (H) mm x 0.2292 (V) mm
Contrast Ratio(typ.)	1.5M:1
Recommended Resolution	2560 x 1440 @ 60 Hz
Maximum Resolution	2560 x 1440 @ 240 Hz
Viewing Angle	178° (H) / 178° (V) @ C/R > 10000 (typ.)
Display Colors	1.07B (10 bits ) <sup>1</sup>
Picture Enhancement	SmartImage Game /SmartImage HDR
Vertical Refresh Rate	48 Hz - 240 Hz
Horizontal Frequency	30 KHz - 390 KHz
sRGB	YES
Flicker Free	YES
SoftBlue technology	YES <sup>2</sup>
EasyRead	YES
Delta E	YES
HDR	YES
Adaptive Sync	YES
Ambiglow	YES
Over-the-air firmware update	YES
Connectivity	
Signal Input source	HDMI, DisplayPort
Connectors	2 x HDMI 2.1 (HDCP 1.4 / HDCP 2.3) 1 x DisplayPort 1.4 (HDCP 1.4 / HDCP 2.3) 1 x Audio out 1 x USB-B (upstream) 2 x USB-A (downstream with x1 fast charge BC 1.2)
Sync input	Separate Sync
USB	
USB Ports	USB UP x1 (upstream) USB-A x2 (downstream with x1 fast charge B.C 1.2)
Power Delivery	USB-A: x1 fast charge B.C 1.2, up to 7.5W (5V/1.5A)
Super Speed	USB-A: USB 3.2 Gen1, 5 Gbps
Convenience	
MultiView	PIP/PBP mode, 2xdevices

OSD Languages	English, German, Spanish, Greek, French, Italian, Hungarian, Dutch, Portuguese, Brazil Portuguese, Polish, Russian, Swedish, Finnish, Turkish, Czech, Ukrainian, Simplified Chinese, Traditional Chinese, Japanese, Korean		
Other Convenience	VESA mount (100 x 100 mm), Kensington Lock		
Plug & Play Compatibility	DDC/CI, sRGB, Windows 11/10, Mac OS X		
<b>Stand</b>			
Tilt	-5 / +20 degree		
Swivel	-30 / +30 degree		
Height adjustment	130 mm		
Pivot	-90 / +90 degree		
<b>Power</b>			
Consumption	AC Input Voltage at 100VAC , 60Hz	AC Input Voltage at 115VAC , 60Hz	AC Input Voltage at 230VAC , 50Hz
Normal Operation	61.8 W (typ.)	61.3 W (typ.)	61.7 W (typ.)
Sleep (Standby mode)	0.5 W (typ.)	0.5 W (typ.)	0.5 W (typ.)
Off mode	0.3 W (typ.)	0.3 W (typ.)	0.3 W (typ.)
Heat Dissipation*	AC Input Voltage at 100VAC , 60Hz	AC Input Voltage at 115VAC , 60Hz	AC Input Voltage at 230VAC , 50Hz
Normal Operation	210.92 BTU/hr (typ.)	209.22 BTU/hr (typ.)	210.58 BTU/hr (typ.)
Sleep (Standby mode)	1.71 BTU/hr (typ.)	1.71 BTU/hr (typ.)	1.71 BTU/hr (typ.)
Off mode	1.02 BTU/hr (typ.)	1.02 BTU/hr (typ.)	1.02 BTU/hr (typ.)
Power LED indicator	On mode: White, Standby/Sleep mode: White (blinking)		
Power Supply	Built-in, 100-240VAC, 50/60Hz		
<b>Dimensions</b>			
Product with stand (WxHxD)	609 x 531 x 261 mm		
Product without stand (WxHxD)	609 x 355 x 61 mm		
Product with packaging (WxHxD)	730 x 445 x 139 mm		
<b>Weight</b>			
Product with stand	5.98 kg		
Product without stand	4.19 kg		
Product with packaging	8.89 kg		
<b>Operating Condition</b>			
Temperature range (operation)	0°C to 40°C		
Relative humidity (operation)	20% to 80%		

Atmospheric pressure (operation)	700hPa to 1060hPa
Temperature range (Non-operation)	-20°C to 60°C
Relative humidity (Non-operation)	10% to 90%
Atmospheric pressure (Non-operation)	500hPa to 1060hPa
<b>Environmental and energy</b>	
ROHS	YES
Packaging	100% recyclable
Specific Substances	100% PVC BFR free housing
<b>Cabinet</b>	
Color	White
Finish	Texture

<sup>1</sup> For more information, please refer to Chapter 8.1 on Display Input Format.

<sup>2</sup> This monitor features SoftBlue technology. This integrated feature offers increased visual comfort and protection against adverse health effects caused by prolonged exposure to blue light. With the low blue-light panel, the ratio of display emission light in the range from 415-455 nm to the display emission of 400-500nm shall be less than 50%. In addition, it utilizes unique circular polarization technology, which produces a more natural light output compared to traditional linear polarization. This monitor provides optimal visual comfort, minimizes eye strain, and supports sustained focus.

 **Note**

1. The data mentioned in this section is subject to change without notice. Go to [www.philips.com/support](http://www.philips.com/support) to download the latest version of the leaflet.
2. In order to update the monitor's firmware to the latest version, Please download the Evnia Precision Center software from Philips website. It is necessary to be connected to a network when updating the firmware on Evnia Precision Center over-the-air (OTA).

## 8.1 Resolution & Preset Modes

H. freq (kHz)	Resolution	V. freq (Hz)
31.47	640 x 480	59.94
35.00	640 x 480	66.67
37.86	640 x 480	72.81
37.50	640 x 480	75.00
31.47	720 x 400	70.09
35.16	800 x 600	56.25
34.19	800 x 600	60.32
48.08	800 x 600	72.19
46.88	800 x 600	75.00
49.73	832 x 624	74.55
48.36	1024 x 768	60.00
56.48	1024 x 768	70.07
60.02	1024 x 768	75.03
44.77	1280 x 720	59.86
63.98	1280 x 1024	60.02
79.98	1280 x 1024	75.03
89.45	1280 x 1440 PBP nodel	59.91
67.50	1920 x 1080	60.00
88.86	2560 x 1440	60.00
183.00	2560 x 1440	120.00
222.19	2560 x 1440	144.00
247.67	2560 x 1440	165.00
300.20	2560 x 1440	200.00
364.80	2560 x 1440	240.00

### Note

Please note that your display works best at the native resolution of 2560 x 1440. For best output performance, please always ensure that your graphic card is capable of achieving the maximum resolution and refresh rate of this Philips display.

## Display Input Format

	444/RGB	444/RGB
	HDMI 2.1	DP1.4
2560 x 1440@ 240Hz, 10bits	OK*	OK*
2560 x 1440@ 240Hz, 8bits	OK	OK
2560 x 1440@ 200Hz, 10bits	OK	OK
2560 x 1440@ 200Hz, 8bits	OK	OK
Minimum:1920 x 1080@ 60Hz	OK	OK

\*This monitor is capable of 10-bit color processing, it still requires a compatible GPU and devices to function properly. Actual color output performance may vary depending on the monitor display colors.

### Note

In order for the monitor to function properly, your PC's graphics card must support the following: HDMI 2.1FRL with a bandwidth of up to 48 Gbps(Fixed Rate Link), DisplayPort 1.4 with Display Stream Compression (DSC),. The display resolution and refresh rate are also dependent on the computer's graphic card capability.

## 9. Power Management

If you have a VESA DPM compliance display card or software installed on your PC, the monitor can automatically reduce its power consumption when not in use. If an input from a keyboard, mouse, or other input device is detected, the monitor will 'wake up' automatically. The following table shows the power consumption and signaling of this automatic power saving feature:

Power Management Definition					
VESA Mode	Video	H-sync	V-sync	Power Used	LED Color
Active	ON	Yes	Yes	61.3 W (typ.) 101.0 W (max.)	White
Sleep (Standby mode)	OFF	No	No	0.5 W	White (blink)
Off mode	OFF	-	-	0.3 W	OFF

The following setup is used to measure power consumption on this monitor.

- Native resolution: 2560 x 1440
- Contrast: 50%
- Brightness: 90%
- Color temperature: 6500k with full white pattern

### Note

This data is subject to change without notice.

# 10. Customer care and warranty

## 10.1 Philips' Flat Panel Monitors Pixel Defect Policy

Philips strives to deliver the highest quality products. We use some of the industry's most advanced manufacturing processes and practice stringent quality control. However, pixel or sub-pixel defects on the TFT Monitor panels used in flat panel monitors are sometimes unavoidable. No manufacturer can guarantee that all panels will be free from pixel defects, but Philips guarantees that any monitor with an unacceptable number of defects will be repaired and/or replaced under warranty. This notice explains the different types of pixel defects and defines acceptable defect levels for each type. To qualify for repair or replacement under warranty, the number of pixel defects on a TFT Monitor panel must exceed these acceptable levels. For example, no more than 0.0004% of the sub-pixels on a monitor may be defective. Furthermore, Philips sets even higher quality standards for certain types or combinations of pixel defects that are more noticeable than others. This policy is valid worldwide.

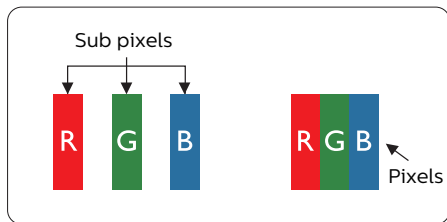

### Pixels and Sub pixels

A pixel, or picture element, is composed of three sub-pixels in the primary colors of red, green, and blue. Many pixels

together form an image. When all the sub-pixels of a pixel are lit, the three colored sub-pixels together appear as a single white pixel. When all are dark, the three colored sub-pixels together appear as a single black pixel. Other combinations of lit and dark sub-pixels appear as single pixels of other colors.

### Types of Pixel Defects

Pixel and sub-pixel defects appear on the screen in different ways. There are two categories of pixel defects and several types of sub-pixel defects within each category.

#### Bright Dot Defects

Bright dot defects appear as pixels or sub-pixels that are always lit or 'on'. Meaning, a bright dot is a sub-pixel that stands out on the screen when the monitor displays a dark pattern. There are three types of bright dot defects: One lit red, green, or blue sub-pixel.

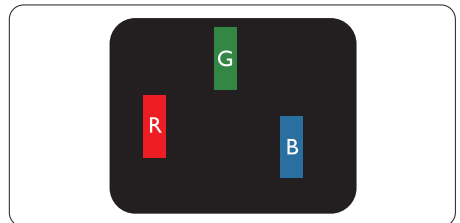

One lit red, green or blue sub pixel.

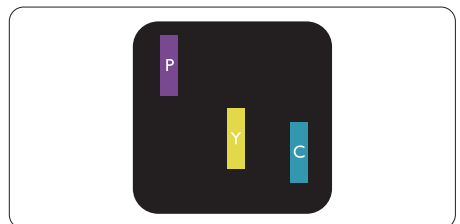

Two adjacent lit sub-pixels:

- Red + Blue = Purple
- Red + Green = Yellow
- Green + Blue = Cyan (Light Blue)

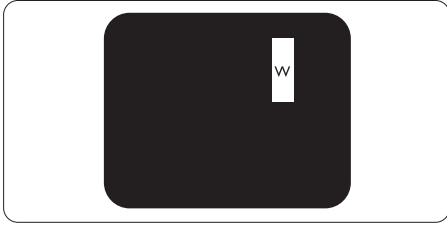

Three adjacent lit sub pixels (one white pixel).

**Note**  
A red or bright blue dot must be more than 50 percent brighter than neighboring dots, while a bright green dot is 30 percent brighter than neighboring dots.

### Black Dot Defects

Black dot defects appear as pixels or sub-pixels that are always dark or 'off'. Meaning, a dark dot is a sub-pixel that stands out on the screen when the monitor displays a light pattern. These are the types of black dot defects.

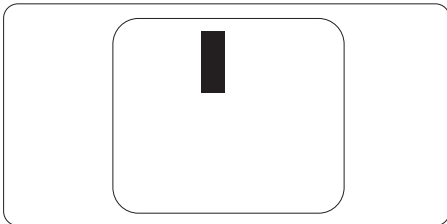

### Proximity of Pixel Defects

Because pixel and sub pixels defects of the same type that are near to one another may be more noticeable, Philips also specifies tolerances for the proximity of pixel defects.

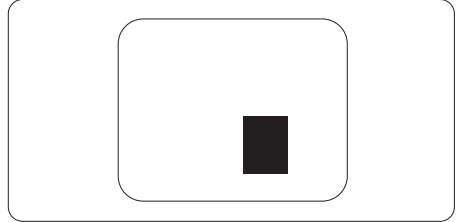

### Pixel Defect Tolerances

To qualify for repair or replacement due to pixel defects during the warranty period, a TFT Monitor panel in a Philips flat panel monitor must have pixel or sub-pixel defects exceeding the tolerances listed in the following tables.

<b>BRIGHT DOT DEFECTS</b>	<b>ACCEPTABLE LEVEL</b>
1 lit subpixel	0
2 adjacent lit subpixels	0
3 adjacent lit subpixels (one white pixel)	0
Distance between two bright dot defects*	0
Total bright dot defects of all types	0
<b>BLACK DOT DEFECTS</b>	<b>ACCEPTABLE LEVEL</b>
1 dark subpixel	5 or fewer
2 adjacent dark subpixels	2 or fewer
3 adjacent dark subpixels	1 or fewer
Distance between two black dot defects*	≥5mm
Total black dot defects of all types	5 or fewer
<b>TOTAL DOT DEFECTS</b>	<b>ACCEPTABLE LEVEL</b>
Total bright or black dot defects of all types	5 or fewer

 **Note**

1 or 2 adjacent sub pixel defects = 1 dot defect

## 10.2 Customer Care & Warranty

For warranty coverage information and additional support requirements valid for your region, please visit [www.philips.com/support](http://www.philips.com/support) website for details or contact your local Philips Customer Care Center.

For an extended warranty, if you would like to extend your general warranty period, an Out of Warranty service package is offered via our Certified Service Center.

For the Warranty Period please refer to Warranty Statement in the Important information manual.

If you wish to make use of this service, please be sure to purchase the service within 30 calendar days of your original purchase date. During the extended warranty period, the service includes pickup, repair, and return service, however, the user will be responsible for all costs accrued.

If the Certified Service Partner cannot perform the required repairs under the offered extended warranty package, we will find alternative solutions for you, if possible, up to the extended warranty period you have purchased.

Please contact our Philips Customer Service Representative or local contact center (by Consumer care number) for more details.

Philips Customer Care Center number listed below.

• Local Standard Warranty Period	• Extended Warranty Period	• Total Warranty Period
• Depend on different Regions	• + 1 Year	• Local Standard warranty period +1
	• + 2 Years	• Local Standard warranty period +2
	• + 3 Years	• Local Standard warranty period +3

\*\*Proof of original purchase and extended warranty purchase required.

### Note

Please refer to the Important information manual for the regional service hotline, which is available on the Philips website support page.

# 11. Troubleshooting & FAQs

## 11.1 Troubleshooting

This page deals with problems that can be corrected by a user. If the problem persists after you have tried these solutions, contact a Philips customer service representative.

### 1 Common Problems

#### No Picture (Power LED not lit)

- Make sure the power cord is plugged into the power outlet and the back of the monitor.
- First, ensure that the power button on the rear of the monitor is in the OFF position, then press it to the ON position.

#### No Picture (Power LED is White)

- Make sure the computer is turned on.
- Make sure the signal cable is properly connected to your computer.
- Make sure the monitor cable has no bent pins on the connecting side. If yes, repair or replace the cable.
- The Energy Saving feature may be activated. Screen says

Check cable connection

- Make sure the monitor cable is properly connected to your computer. (Also refer to the Quick Start Guide).
- Check to see if the monitor cable has bent pins.
- Make sure the computer is turned on.

#### Visible signs of smoke or sparks

- Do not perform any troubleshooting steps
- Disconnect the monitor from the mains power source immediately for safety
- Contact Philips customer service representative immediately.

### 2 Imaging Problems

#### Image vibrates on the screen

- Check that the signal cable is properly securely connected to the graphics board or PC.

The image appears blurred, indistinct, or too dark

- Adjust the contrast and brightness on On-Screen Display.

An "after-image", "burn-in" or "ghost image" remains after the power has been turned off.

- Uninterrupted display of still or static images over an extended period may cause "burn-in", also known as "after-imaging" or "ghost imaging", on your screen. "Burn-in", "after-imaging", or "ghost imaging" is a well-known phenomenon in QD OLED panel technology. In most cases, the "burn-in" "after-imaging" or "ghost imaging" will disappear gradually over some time after the power has been switched off.
- Please always turn on the Screen Saver and Pixel Orbiting functions from the On Screen Display (OSD) menu. For additional information, please refer to Chapter 8 on Screen Maintenance.
- Failure to activate a screen saver, or a periodic screen refresh application may result in severe "burn-in" "after-imaging" or "ghost imaging" symptoms that will not disappear

and cannot be repaired. The damage mentioned above is not covered under your warranty.

The image appears distorted or the text is fuzzy or blurred.

- Set the PC's display resolution to the same mode as the monitor's recommended screen native resolution.

Green, red, blue, dark, and white dots appear on the screen

- The remaining dots are a normal characteristic of the liquid crystal used in today's technology, Please refer to the pixel policy for more detail.

\* The "power on" light is too strong and is disturbing

- You can adjust the "power on" light using the power LED Setup in OSD Main Controls.

For further assistance, refer to the Service contact information listed in the Important information manual and contact a Philips customer service representative.

\* [Functionality is different according to display.](#)

## 11.2 General FAQs

---

Q1: When I install my monitor what should I do if the screen shows 'Cannot display this video mode'?

Ans.: Recommended resolution for this monitor: 2560 x 1440.

- Unplug all cables, then connect your PC to the monitor that you used previously.
- In the Windows Start Menu, select Settings/Control Panel. In the Control Panel Window, select the Display icon. Inside the Display

Control Panel, select the 'Settings' tab. Under the setting tab, in the box labeled 'desktop area', move the sidebar to 2560 x 1440 pixels.

- Open 'Advanced Properties' and set the Refresh Rate to 60 Hz, then click OK.
- Restart your computer and repeat steps 2 and 3 to verify that your PC is set at 2560 x 1440.
- Shut down your computer, disconnect your old monitor, and reconnect your Philips QD OLED monitor.
- Turn on your monitor and then turn on your PC.

Q2: What is the recommended refresh rate for an QD OLED monitor?

Ans.: Recommended refresh rate in QD OLED monitors is 60 Hz, In case of any disturbance on the screen, you can set it up to 165 Hz to see if that removes the disturbance.

Q3: What are the .inf and .icm files? How do I install the drivers (.inf and .icm)?

Ans.: These are the driver files for your monitor. Your computer may ask you for monitor drivers (.inf and .icm files) when you first install your monitor. Follow the instructions in your user manual, and monitor drivers (.inf and .icm files) will be installed automatically.

Q4: How do I adjust the resolution?

Ans.: Your video card/graphic driver and monitor together determine the available resolutions. You can select the desired resolution under Windows® Control Panel with the "Display properties".

Q5: What if I get lost when I am making monitor adjustments via OSD?

Ans.: Press the ➡ button, then select [Setup], press the ↓ button, then select [Reset] to recall all the original factory settings.

Q6: Is the QD OLED screen resistant to scratches?

Ans.: In general it is recommended that the panel surface is not subjected to excessive shocks and is protected from sharp or blunt objects. When handling the monitor, make sure that there is no pressure or force applied to the panel surface side. This may affect your warranty conditions.

Q7: How should I clean the QD OLED surface?

Ans.: Wipe the surface in one direction with a clean microfiber cloth. For detailed cleaning instructions, please refer to Section 11.4 OLED Screen Cleaning Method.

Q8: Can I change the color setting of my monitor?

Ans.: Yes, you can change your color setting through OSD control as per the following procedures.

- Press the ➡ button to show the OSD (On Screen Display) menu
- Select [SmartImage], press the ↓ button, then press the ➡ button to select the option [Color Temperature] then press the ➡ button to enter the color setting, there are eight settings as below.
  1. Color Temperature: The settings are as follows. Native, Preset, 5000K, 6500K, 7500K, 8200K, 9300K, and 11500K. With settings in the 5000K range the panel

appears "warm, with a red-white color tone", while a 11500K temperature yields "cool, blue-white toning".

2. R.G.B. Settings: This is a standard setting for ensuring the correct exchange of colors between different devices (e.g. digital cameras, monitors, printers, scanners, etc).
3. User Define: The user can choose his/her preferred R.G.B. by adjusting red, green, and blue colors.

### ⊖ Note

A measurement of the color of light radiated by an object while it is being heated. This measurement is expressed in terms of absolute scale, (degrees Kelvin). Lower Kelvin temperatures such as 2004K are red; higher temperatures such as 9300K are blue. The neutral temperature is white, at 6504K.

Q9: Can I connect my QD OLED monitor to any PC, workstation, or Mac?

Ans.: Yes. All Philips QD OLED monitors are fully compatible with standard PCs, Macs, and workstations. You may need a cable adapter to connect the monitor to your Mac system. Please contact your Philips sales representative for more information.

Q10: Are Philips QD OLED monitors Plug-and-Play?

Ans.: Yes, the monitors are Plug-and-Play compatible with Windows 11/10, Mac OSX.

Q11: What is Image Sticking, Image Burn-in, After Image, or Ghost Image in QD OLED panels?

Ans.: Uninterrupted display of still or static images over an extended period may cause "burn-in", also known as "after-imaging" or "ghost imaging", on your screen. "Burn-in", "after-imaging", or "ghost imaging" is a well-known phenomenon in QD OLED panel technology. Please always turn on the Screen Saver and Pixel Orbiting functions from the On Screen Display (OSD) menu. For additional information, please refer to Chapter 8 on Screen Maintenance.

 **Warning**

Failure to activate a screen saver, or a periodic screen refresh application may result in severe "burn-in" "after-image" or "ghost image" symptoms that will not disappear and cannot be repaired. The damage mentioned above is not covered under your warranty.

Q12: Why is my Display not showing sharp text, and is displaying jagged characters?

Ans.: Your QD OLED monitor works best at its native resolution of 2560 x 1440. For the best display, please use this resolution.

Q13: How to unlock/lock my hotkey?

Ans.: Please press  for 10 seconds to unlock/lock the hotkey, by doing so, your display pops out "Attention" to show the unlock/lock status as shown below illustrators.



Q14: Where can I find the Important information manual mentioned in EDFU?

Ans.: Important information manual can be downloaded on the Philips website support page.

## 11.3 Multiview FAQs

---

Q1: Can I enlarge the PIP sub-window?

Ans.: Yes, there are 3 sizes to select: [Small], [Middle], [Large]. You can press **➡** to enter the OSD menu. Select your preferred [PIP Size] option from the [PIP / PBP] main menu.

Q2: How to listen to Audio, independent of a video?

Ans.: Normally the audio source is linked to the main picture source. If you want to change audio-source input, you can press **➡** enter in the OSD menu. Select your preferred [Audio Source] option from the [Audio] main menu.

Please note that the next time you turn on your display, the display will by default select the audio source you chose last time. In case you want to change it again, you need to go through the above steps to select your new preferred audio source, which then will become the "default" mode.

Q3: Why do the sub-windows flicker when I enable PIP/PBP?

Ans: It's because the sub-windows video source is interlace timing (i-timing), please change the sub-window signal source to progressive timing (P-timing).

## 11.4 OLED Screen Cleaning Method

- Cleaning Tools:

	Allowed	Prohibited
Cleaning cloth	Microfiber cloth (clean, soft, dust-free)	Tissue paper or toilet paper Eyeglass cleaning cloth Gauze
Cleaner	Purified/distilled water Neutral water/alkaline detergent (such as dishwashing detergent) LCD/LED screen cleaner (acetone-free)	Toluene   acetone / solvents Glass cleaner Household cleaning products Abrasive cleaning solutions Sprays Cleaners containing hydrogen peroxide

- Cleaning Method for Stains (Fingerprints)

Minor stains	<ol style="list-style-type: none"> <li>1. Wipe the film surface in one direction at a time with an available dry cloth to remove stains and dust.</li> <li>2. Dampen a cloth with distilled water and wipe the film surface in one direction.</li> <li>3. Wipe the film surface with an available dry cloth to remove any remaining moisture.</li> </ol>
Stubborn stains	<ol style="list-style-type: none"> <li>1. Wipe the film surface in one direction at a time with an available dry cloth to remove stains and dust.</li> <li>2. Apply a small amount (0.3–0.5 mL, 1–2 drops) of the available cleaner onto the cloth and then wipe the film surface in one direction. * Do not spray the cleaner directly onto the film surface.</li> <li>3. Wipe the film surface with an available dry cloth to remove any remaining moisture.</li> </ol>

 Note

1. If stains persist after using the cleaner, apply a small amount (0.3–0.5 mL, 1–2 drops) of 70% isopropyl alcohol (IPA) onto a cloth and then wipe the film surface. However, prolonged wiping or exposure to IPA may cause film damage.
2. When oil residue builds up, it becomes difficult to clean using normal cleaning methods. Therefore, it is recommended to immediately wipe off any fingerprints from the film surface whenever they are noticed.



2026 © TOP Victory Investments Ltd. All rights reserved.

This product has been manufactured by and is sold under the responsibility of Top Victory Investments Ltd., and Top Victory Investments Ltd. is the warrantor in relation to this product. Philips and the Philips Shield Emblem are registered trademarks of Koninklijke Philips N.V. and are used under license.

Specifications are subject to change without notice.