

The actual accessories may differ from the illustrations, which are for reference purposes only.

Television Quick Start Guide 6700 series

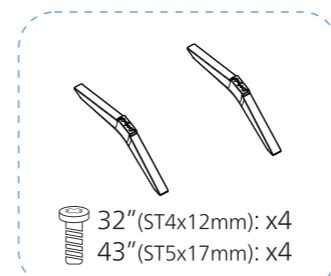

Tool needed for assembly

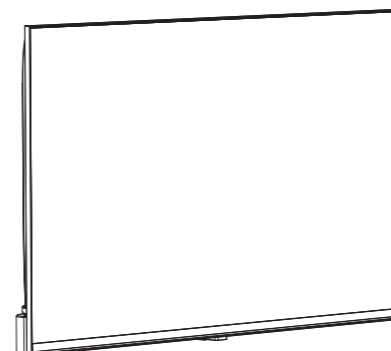

32" (ST4x12mm): x4
43" (ST5x17mm): x4

ST: Flat tail self-tapping screw

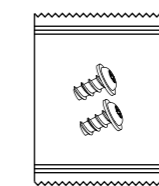

Flat tail self-tapping screw
(2 pieces/bag)

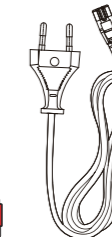
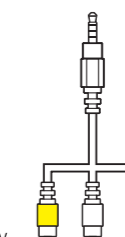

(/68)

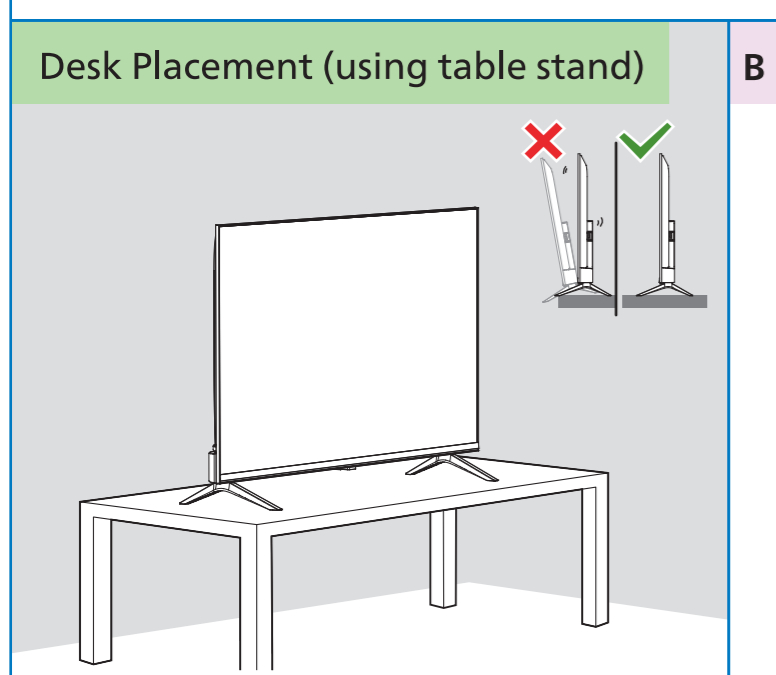
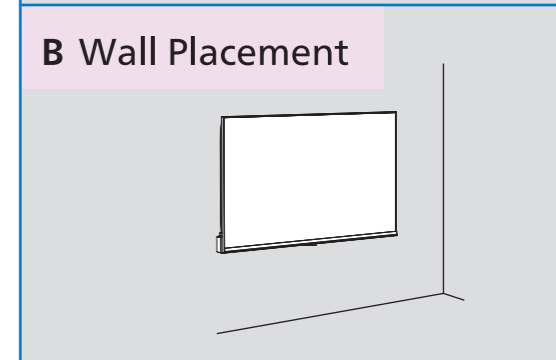
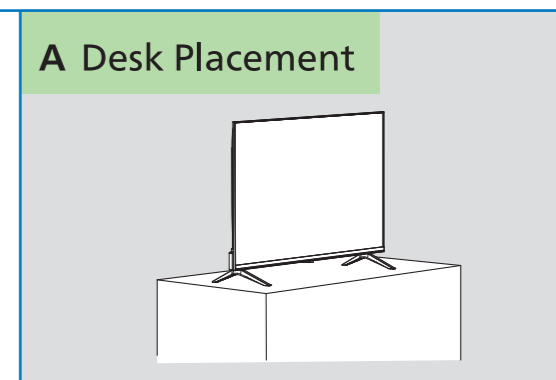
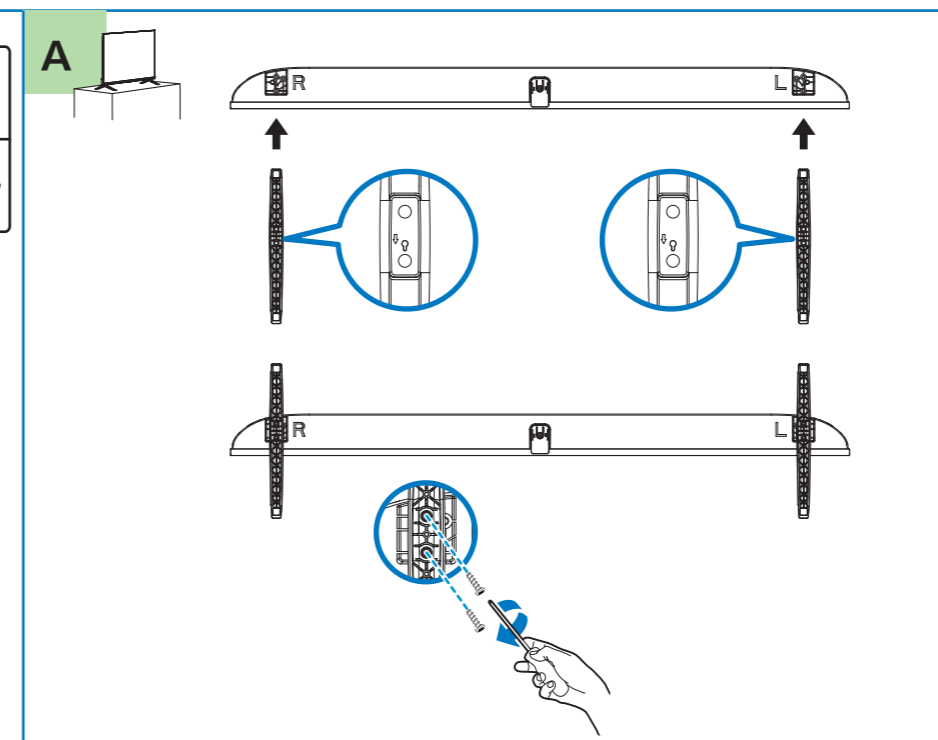
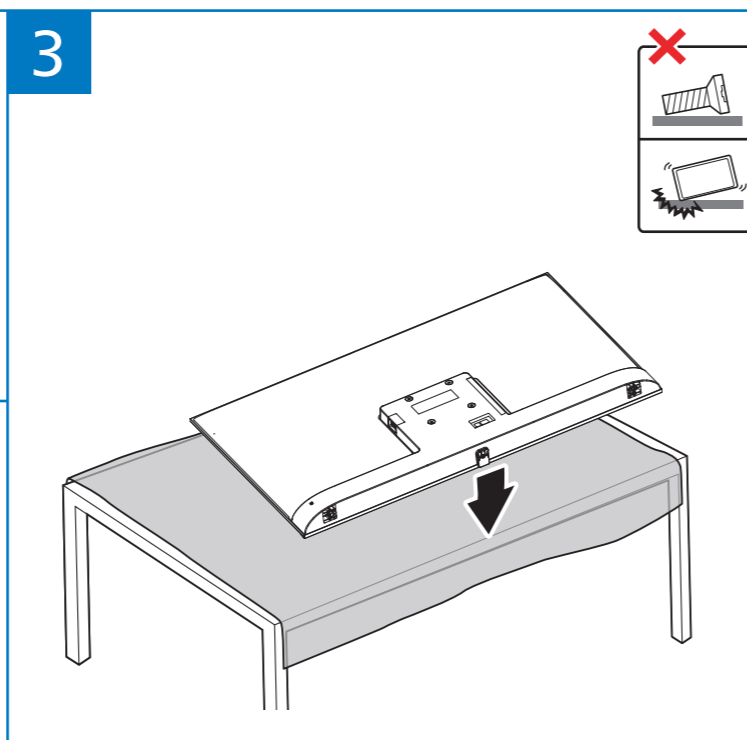
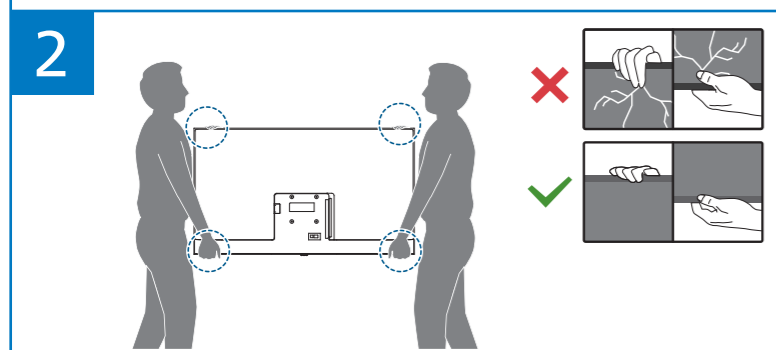
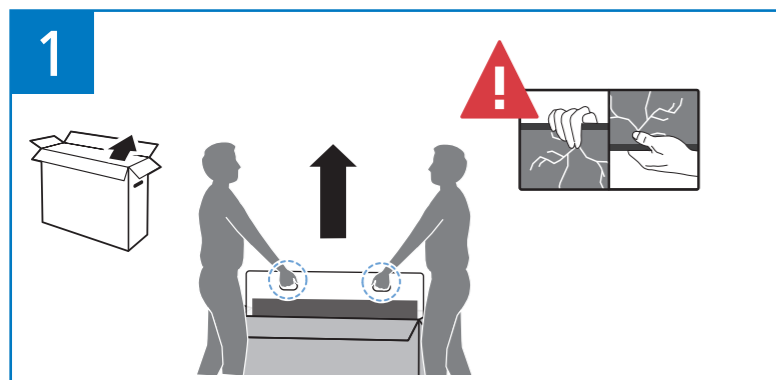
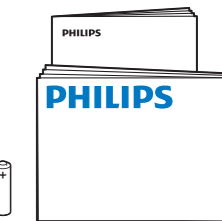

B

Diagonal (inch/cm)	X (mm)	Y (mm)	Screw Size	Screw Length (mm)
32" / 80	100	100	UP: M4 Down: ST4	9.5-10.5 9.5-10.5
43" / 108	100	100	UP: M4 Down: ST4	9.5-10.5 9.5-10.5

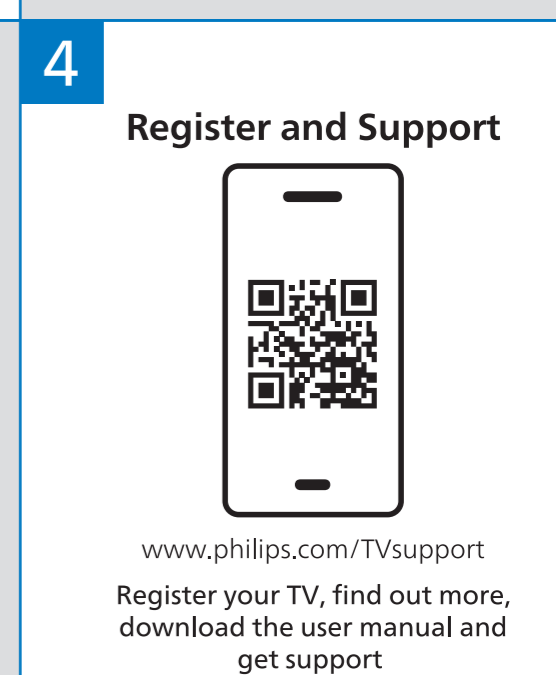
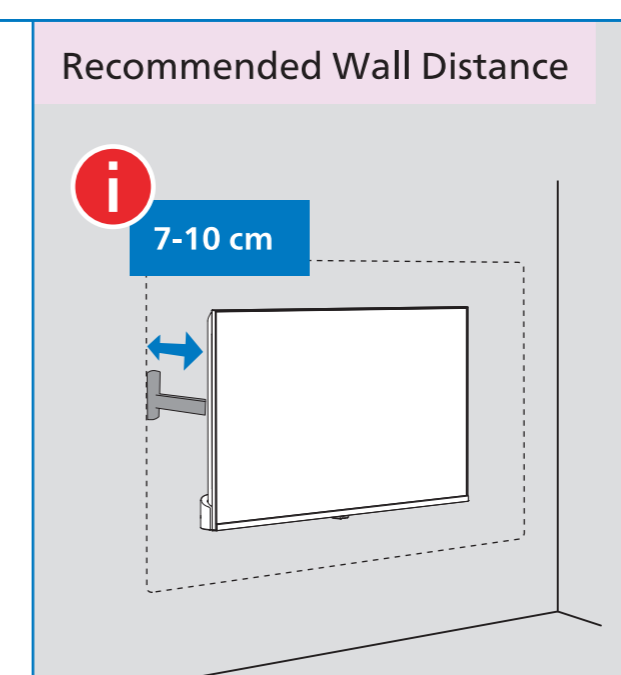



1



To install batteries, slide the battery door up.

2



Use 2x AAA LR03 1.5V (included)

3

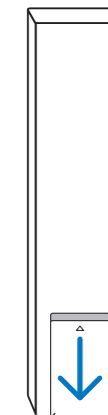

Slide battery door back in place.

Click



English Read the safety instructions.
Bahasa Malaysia Baca arahan Keselamatan.
Bahasa Indonesia Baca petunjuk keselamatan.

Deutsch Lesen Sie die Sicherheitshinweise.
Français Lisez les consignes de sécurité.
Português Leia as instruções de segurança.

ภาษาไทย โปรดอ่านคำแนะนำด้านความปลอดภัย
Tiếng Việt Hãy đọc chỉ dẫn an toàn.
简体中文 请阅读安全说明。

العربية قراءة تعليمات السلامة.



32"/43"

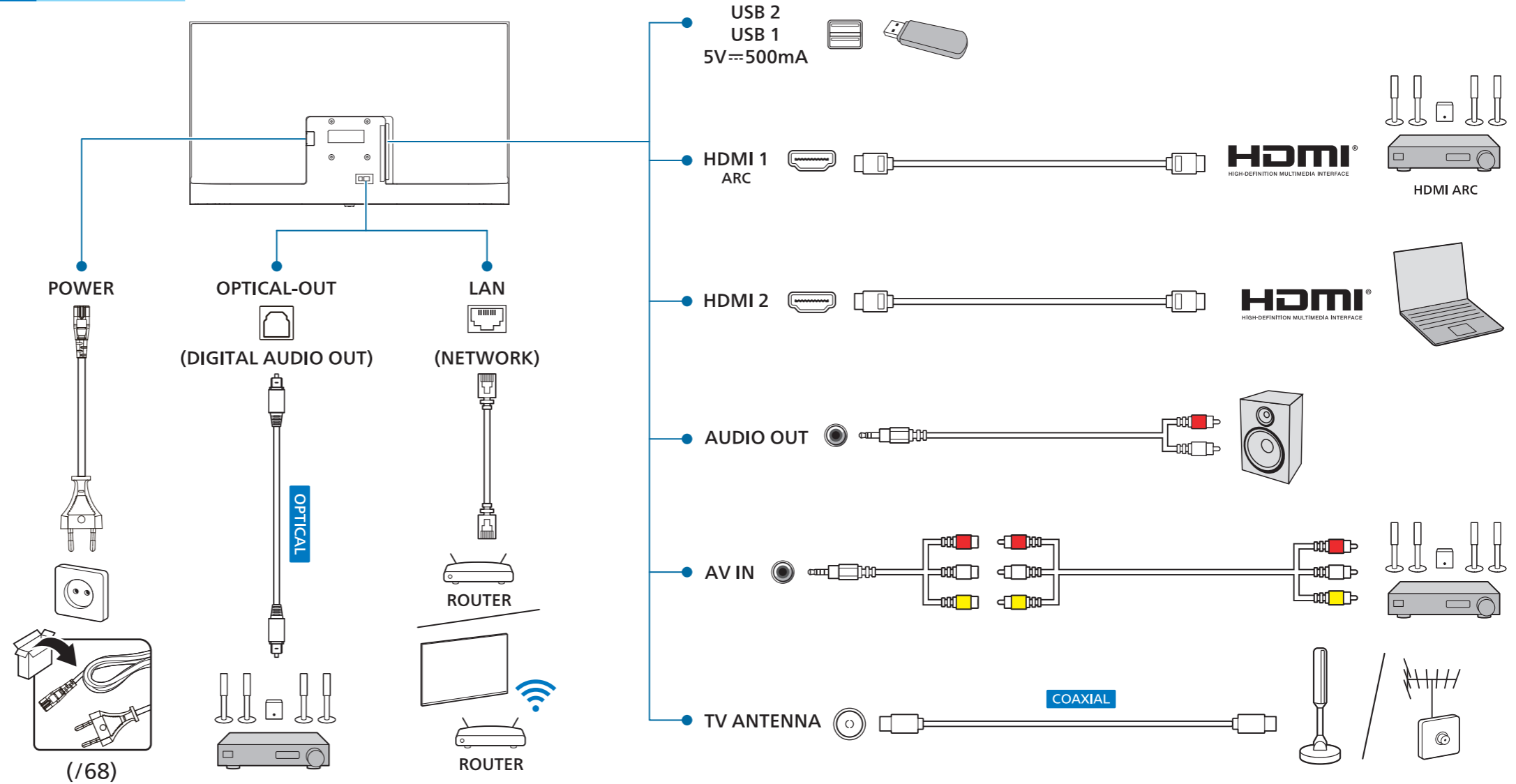

<= 1m

3 sec

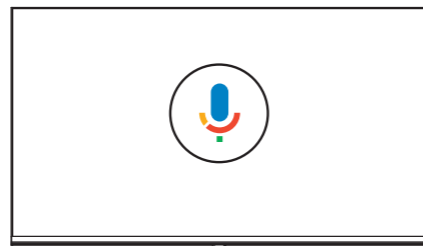
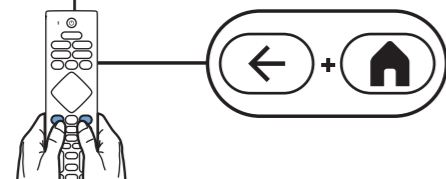

Hey Google

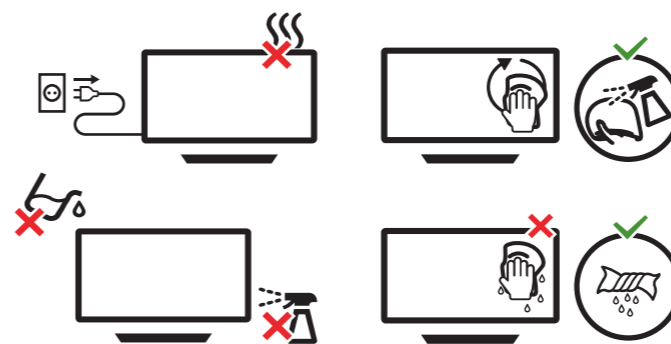
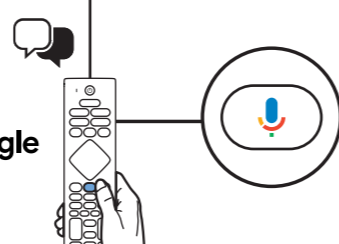

All registered and unregistered trademarks are property of their respective owners. Specifications are subject to change without notice. Philips and the Philips Shield Emblem are registered trademarks of Koninklijke Philips N.V. and are used under license. This product has been manufactured by and is sold under the responsibility of TP Vision Europe B.V., and TP Vision Europe B.V. is the warrantor in relation to this product. 2026 © TP Vision Europe B.V. All rights reserved. www.philips.com/welcome