

# PHILIPS

## Emergency Radio TAR3500



## User manual

Register your product and get support at:  
[www.philips.com/support](http://www.philips.com/support)

## Contents

<b>1</b>	<b>Important</b>	<b>2</b>	<b>7</b>	<b>Listen to AM radio</b>	<b>6</b>
	Safety	2		Tune to AM radio stations	6
<b>2</b>	<b>Your emergency radio</b>	<b>2</b>		Store AM radio stations automatically	6
	Introduction	2		Store AM radio stations manually	6
	What's in the box	2		Select a preset radio station	6
	Overview of the emergency radio	3	<b>8</b>	<b>Listen to WB radio (North America Only)</b>	<b>7</b>
<b>3</b>	<b>Get started</b>	<b>4</b>		Tune to WB radio stations	7
	Charge the built-in battery	4	<b>9</b>	<b>Other features</b>	<b>7</b>
	Install batteries	4		Flashlight	7
	Turn on/off or switch to standby	5		Reading light	7
	Adjust volume	5		SOS	7
	Adjust display brightness	5		USB-A port for charging out	7
<b>4</b>	<b>Clock setting</b>	<b>5</b>		Headphone output	7
	Setting clock	5		Factory reset	7
<b>5</b>	<b>Alarm setting</b>	<b>5</b>	<b>10</b>	<b>Product specifications</b>	<b>7</b>
	Set alarm time	5	<b>11</b>	<b>Troubleshooting</b>	<b>8</b>
	Activate/deactivate alarm timer	5	<b>12</b>	<b>Notice</b>	<b>8</b>
	Snooze the alarm	5			
	Stop alarm sounds	5			
<b>6</b>	<b>Listen to FM radio</b>	<b>6</b>			
	Tune to FM radio stations	6			
	Store FM radio stations automatically	6			
	Store FM radio stations manually	6			
	Select a preset radio station	6			

# 1 Important

## Safety

- Read these instructions.
- Heed all warnings.
- Follow all instructions.
- Do not block any ventilation openings.
- Do not install near any heat sources such as radiators, heat registers, stoves, or other apparatus (including amplifiers) that produce heat.
- Keep this product away from direct sunlight, naked flames or heat.
- The product shall not be exposed to dripping or splashing.
- Place this product on a flat, hard and stable surface.
- Do not place any source of danger on the product (e.g. liquid filled objects, lit candles).
- Never place this product on other electrical equipment.
- Only use attachments/accessories specified by the manufacturer.
- Never remove the casing of this product, refer all servicing to qualified service personnel. Servicing is required when the product has been damaged in any way, such as power-supply cord or plug is damaged, liquid has been spilled or objects have fallen into the apparatus, the apparatus has been exposed to rain or moisture, does not operate normally, or has been dropped.
- A battery (battery pack or battery installed) shall not be exposed to excessive heat such as sunshine, fire or the like.
- Danger of explosion if batteries are incorrectly replaced. Replace only with the same or equivalent type.
- Battery in extreme high or low temperatures during use, storage or transportation, and low air pressure at high altitude can pose safety hazards.
- Risk of explosion if a battery is replaced by an incorrect type.
- Do not replace a battery with an incorrect type that can defeat a safeguard (for example, some lithium battery types).
- Install all batteries correctly.
- Leaving a battery in an extremely high temperature surrounding, or an extremely low air pressure environment may result in an explosion or leakage of flammable liquid or gas.
- Batteries contain chemical substances. They should be disposed of properly.
- If you suspect that a battery has been swallowed or placed inside any part of the body, seek immediate medical attention.
- When you change the batteries, always keep all new and used batteries out of reach of children. Ensure that the battery compartment is completely secure after you replace the battery.
- If the battery compartment cannot be completely secured, discontinue use of the product. Keep out of reach of children and contact the manufacturer.
- This product shall not be exposed to dripping or splashing.
- Do not place any sources of danger on the product (e.g. liquid filled objects, lighted candles).
- Please use the product safely in an environment with temperature between 0°C and 40°C.
- To avoid risk of fire, the product is supplied only by external power source which output shall comply with PS1 (with output capacity less than 15W).
- The power delivered by the charger must be between min. 5 Watts required by the emergency radio equipment, and max. 15 Watts in order to achieve the maximum charging speed.

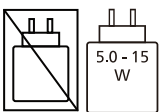

- Please note that your device contains built-in lithium batteries. The charging capacity of lithium batteries will decrease over time due to their self-discharge characteristics. To ensure the longevity of your device's battery, we recommend charging the built-in lithium battery to around 50% every 6 months when the device is not in use.

# 2 Your emergency radio

Congratulations on your purchase, and welcome to Philips! To fully benefit from the support that Philips offers, register your product at [www.philips.com/support](http://www.philips.com/support).

## Introduction

With this emergency radio, you can

- Listen to FM/AM/WB (North America Only) radio
- Set an alarm
- Charge your mobile device via USB
- Use the built-in flashlight
- Use the reading light
- Seek help in emergency

## What's in the box

Check and identify the contents of your package:

- Main unit
- TYPE-C charging cable
- Hand strap
- Quick start guide
- Safety sheet
- Warranty card

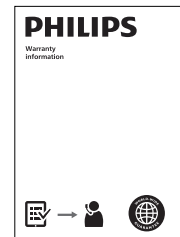
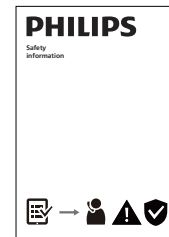
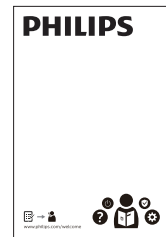
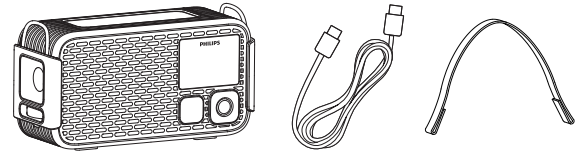

### Note

- Images, illustrations and drawings shown on this user manual are for reference only. Actual product may vary in appearance.

## Overview of the emergency radio

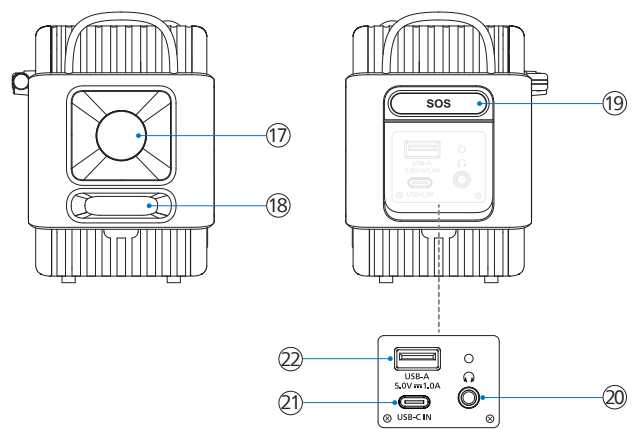
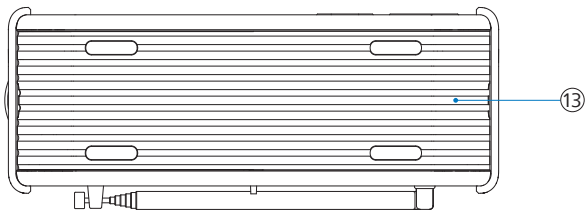
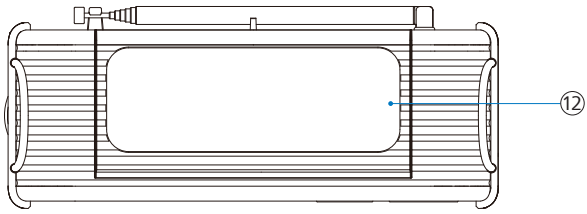
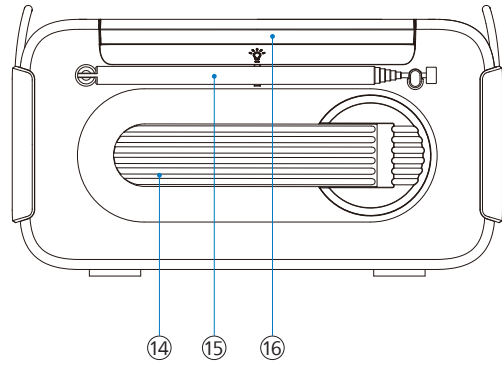
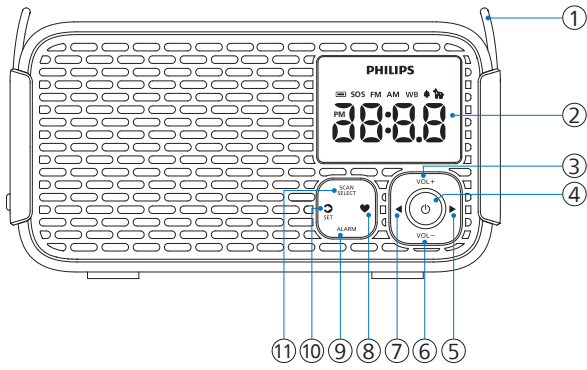

- ① **Hand strap buckle**
  - Insert the supplied strap for easy carrying
- ② **Display panel**
  - Display current status
- ③ **VOL+**
  - Increase the volume
- ④ **Power button**
  - Power on/off, enter standby mode, or stop the alarm
- ⑤ **Right arrow button**
  - Short press: Tune up the frequency (MHz)
  - Long press: Auto-scan upward to search for a station
- ⑥ **VOL-**
  - Decrease the volume
  - Adjust display brightness at standby mode
- ⑦ **Left arrow button**
  - Short press: Tune down the frequency (MHz)
  - Long press: Auto-scan downward to search for a station
- ⑧ **Heart icon button**
  - Short press: Select a preset station
  - Long press: Store the current station as a preset
- ⑨ **ALARM**
  - Short press: Turn the alarm on or off, or stop the alarm
  - Long press: Enter alarm settings
- ⑩ **↻/SET**
  - Short press: Switch with FM/AM/WB (North America only) source
  - Short press: Snooze the alarm for 10min
  - Long press: Enter the clock setting mode

- ⑪ **SCAN/SELECT**
  - Scan and store radio stations automatically
  - Confirm selection
- ⑫ **Solar panel**
- ⑬ **Battery compartment lid**
- ⑭ **Hand crank**
  - Wind to charge the built-in Li-ion battery
- ⑮ **Telescopic antenna**
  - Improve FM/AM/WB (North America Only) radio reception
- ⑯ **Reading light**
- ⑰ **Flashlight**
- ⑱ **Flashlight knob**
  - Turn on/off the flashlight and adjust its brightness
- ⑲ **SOS**
  - Enable or disable SOS and dog-whistle mode
- ⑳ **Headphone jack**
- ㉑ **USB-C port**
  - Use a USB-C cable to charge the emergency radio
- ㉒ **USB-A port**
  - Use a USB cable to charge an external device

### 3 Get started

Always follow the instructions in this chapter in sequence.

#### Charge the built-in battery



The emergency radio is powered by a built-in rechargeable battery.

##### Note

- A red battery icon  appears when the battery level is low. Please charge the built-in battery as soon as possible.

#### USB-C charging

Use the supplied USB Type-C charging cable and connect it to a 5V = 2A power adapter (not supplied). Then connect the cable to the emergency radio to start charging.

- When the emergency radio is charging, the charging icon  will appear.
- When the emergency radio is fully charged, the charging icon  will turn off.

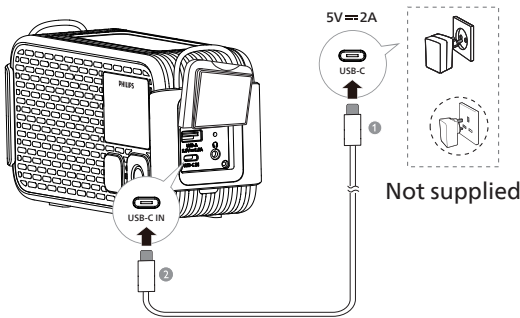

##### Note

- It takes about 3.5 hours to fully charge.
- When fully charged, it can play continuously for 60 hours (volume set to 5).

#### Solar charging

Place the product in direct sunlight to start solar charging. The solar charging icon  will appear.

In standby mode:

- The display will turn off after 10 seconds, except for the solar charging icon , which will remain visible.

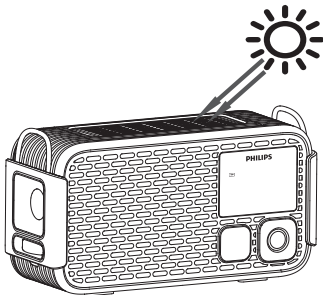

##### Warning

- Do not cover the solar panel when charging.

#### Hand crank charging

You can charge the built-in rechargeable battery by rotating the hand crank generator, the icon  is shown.

If in standby mode:

- The display will light off after 10 seconds except for the icon .

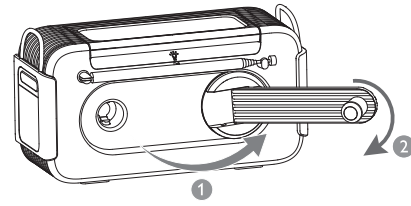

##### Note

- Only use solar charging and hand crank charging in emergency.

#### Install batteries

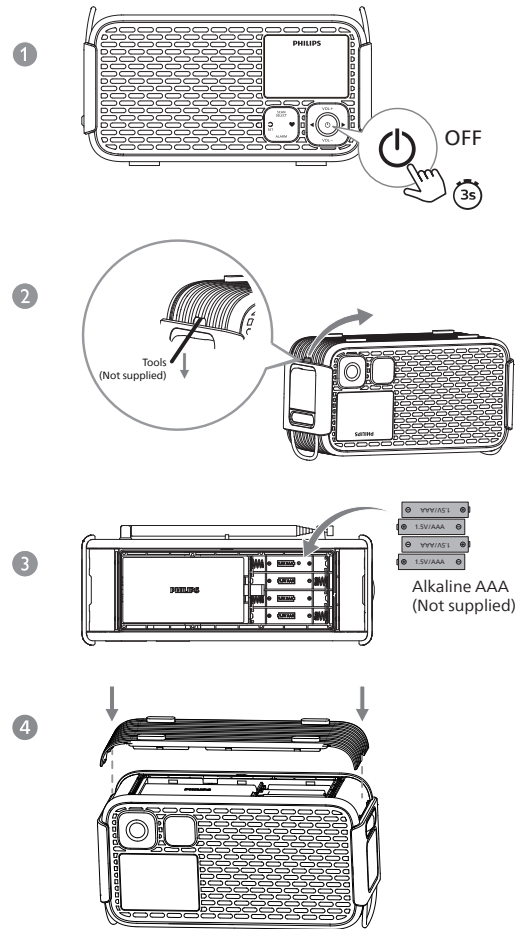

##### Caution

- Risk of explosion! Keep the batteries away from heat, sunshine or fire. Never discard batteries in fire.
- Batteries contain chemical substances, so they should be disposed of properly.
- To enhance the usage effect, it is recommended to use alkaline AAA batteries.
- Do not mix battery types: e.g. alkaline with carbon zinc. Only use batteries of the same type for the set.



- Press and hold  for 3 seconds to turn off the emergency radio.
- Open the battery lid at the bottom of the emergency radio by tools (not supplied), for example, a screwdriver etc.
- Insert 4 alkaline AAA batteries with correct polarity (+/-) as indicated.
- Close the battery lid and press the edges of the battery lid to make sure fasten it tightly.

## Turn on/off or switch to standby

- Press  to turn the emergency radio on.
  - ↳ The emergency radio switches to the last selected source.
- Press  to switch the emergency radio to Standby mode.
  - ↳ The time (if the clock is set) will be displayed for 10 seconds, then the display will turn off when the device is not in USB-C charging.
  - ↳ Press any key except  key to activate the display for 10 seconds when the display light is off.

### Note

- In any mode, press and hold  for 3 seconds to turn off the emergency radio directly. The display screen will turn off.

## Adjust volume

While listening, press **VOL + /VOL -** to adjust volume (volume level: V00~V16).

## Adjust display brightness

In standby mode, press **VOL -** to select different brightness level or turn off the display screen.





- High
- Medium
- Low
- Off

### Note

- If you select Off mode (display turned off), the display will light up at medium brightness when any key is pressed, then automatically turn off again after 10 seconds.

## 4 Clock setting

### Setting clock

- 1 In power on or standby mode, press and hold **SET** for 3 seconds to activate the clock setting mode, the "24H" blinking.
- 2 Press / to select <12H> or <24H> hour format, then press **SET** to confirm. The time will blink.
- 3 Press  to set hour and press  to set minute. Then press **SET** to confirm.
  - ↳ The time is set.

### Note









- If no button is pressed within 10 seconds, the emergency radio will exit clock-setting mode without saving.

## 5 Alarm setting

### Set alarm time

#### Note

- Ensure that the clock has been set correctly.



- 1 Press and hold **ALARM** for 3 seconds to activate the alarm setup mode. The icon  and alarm time will blink.
- 2 Press  to set hour and press  to set minute, then press **ALARM** to confirm. The icon  and "BUZ" (alarm source) will blink.
- 3 Press / to select alarm source: buzzer or radio (FM), then press **ALARM** to confirm.
  - If radio (FM) is selected as the alarm source, the icon  and radio station preset number will blink. Press / to select a preset radio station, then press **ALARM** to confirm.
  - Default alarm source is buzzer.

#### Tip

- The alarm timeout is 60 minutes when there is no user interaction.
- If the radio alarm is selected without a preset station, the buzzer sounds automatically.
- Unless the alarm is deactivated, it is set to ring every day by default.



### Activate/deactivate alarm timer

Press **ALARM** to activate or deactivate the alarm timer.

- ↳ When the alarm timer is activated, the alarm  icon appears.
- ↳ When the alarm timer is deactivated, the alarm icon  disappears.

### Snooze the alarm

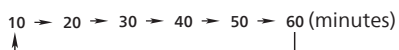
- 1 When the alarm sounds, press **SET**.
  - ↳ The alarm will snooze and ring again after 10 minutes (default setting). The snooze icon  will blink.
- During alarm snooze time, press **SET** to select a different snooze duration (in minutes) to ring gain.

- 2 During the alarm snooze period, press  or **ALARM** to cancel snooze.
  - ↳ The alarm will stop.

### Stop alarm sound

When the alarm sounds, press  or **ALARM**.



- ↳ The alarm will stop, but the alarm setting will remain active.

## 6 Listen to FM radio

### Note

- Keep the emergency radio away from other electronic devices to avoid radio interference.
- For better reception, fully extend and adjust the position of the telescopic antenna.

### Tune to FM radio stations

- 1 Press  to turn on the emergency radio.
- 2 Press  to select FM mode.
- 3 Press and hold  for 3 seconds.  
↳ The emergency radio automatically tunes to a station with strong reception.
- 4 Repeat Step 3 to tune to additional radio stations.

To tune to a station manually:  
Press  to select a frequency.

### Note

- The tuning step of the emergency radio is 50 kHz. Each time you press the , the frequency shown on the display will decrease or increase by 50 kHz.



### Store FM radio stations automatically

In FM mode, press and hold **SCAN** for 3 seconds.  
↳ The radio automatically stores all available FM radio stations and broadcasts the first station.

### Note

- You can store a maximum of 20 FM radio stations.

### Store FM radio stations manually

- 1 In FM mode, tune to an FM radio station.
- 2 Press and hold  for 3 seconds to activate programming mode.  
↳ The preset number begins to blink.
- 3 Press  to select a number.
- 4 Press **SELECT** to confirm.
- 5 Repeat Steps 2 to 4 to store additional radio stations.

### Tip



- To remove a preset station, store another station in the same preset location.

### Select a preset radio station

#### Methods 1

In FM mode, press  to select a preset number.

#### Methods 2



- 1 In FM mode, press .
- 2 Press  to select a preset radio station.

## 7 Listen to AM radio

### Note

- Keep the emergency radio away from other electronic devices to avoid radio interference.
- For better reception, fully extend and adjust the position of the telescopic antenna.

### Tune to AM radio stations

- 1 Press  to turn on the emergency radio.
- 2 Press  to select AM mode.
- 3 Press and hold  for 3 seconds.  
↳ The emergency radio tunes to a station with strong reception automatically.
- 4 Repeat Step 3 to tune to more radio stations.

To tune to a station manually:  
Press  to select a frequency.

### Note

- The tuning grid of the emergency radio is 10kHz. The emergency radio frequency on the display panel will decrease/increase 10kHz by pressing .



### Store AM radio stations automatically

In AM mode, press and hold **SCAN** for 3 seconds.  
↳ the emergency radio stores all the available AM radio stations automatically and broadcasts the first station.

### Note

- You can store a maximum of 20 AM radio stations.



### Store AM radio stations manually

- 1 In AM mode, tune to an AM radio station.
- 2 Press and hold  for 3 seconds to activate programming mode.  
↳ The preset number begins to blink.
- 3 Press  to select a number.
- 4 Press **SELECT** to confirm.
- 5 Repeat Steps 2 to 4 to store additional AM radio stations.

### Tip

- The preset station is automatically confirmed after 3 seconds.

### Select a preset radio station

In AM mode, press the  to select a preset number. Press it again to move to the next preset station, or use  to make a selection.

## 8 Listen to WB radio (North America Only)

### Note

- Keep the emergency radio away from other electronic devices to avoid radio interference.
- For better reception, fully extend and adjust the position of the telescopic antenna.
- North American countries include: the United States, Canada and Mexico.

### Tune to WB radio stations

- 1 Press to turn on the emergency radio.
- 2 Press to select WB mode.
- 3 Press to select a radio station.  
↳ The current radio station is played.

## 9 Other features

### Flashlight

Rotate the flashlight knob on the side to turn the flashlight on or off and adjust its brightness.

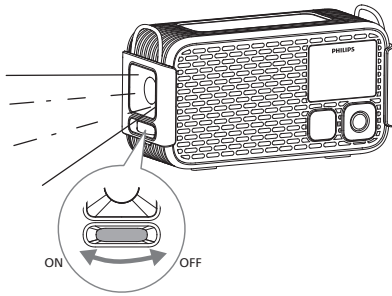

### SOS

When trapped, this unit can emit positioning signals with minimal physical effort, allowing search-and-rescue dogs to locate personnel.

Press **SOS** on the side of the emergency radio to enable or disable SOS and dog whistle mode.

When enabled:

- ↳ A siren sound will be emitted.
- ↳ The flashlight will turn on and flash.
- ↳ The "SOS" indicator will light up red, and the icon will appear on the display.

### Reading light

Flip open or close the top lid on the emergency radio to turn the reading light on or off.

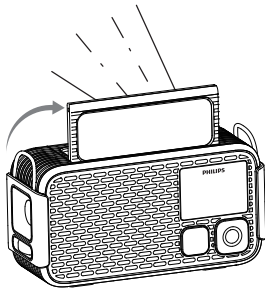

### USB-A port for charging out

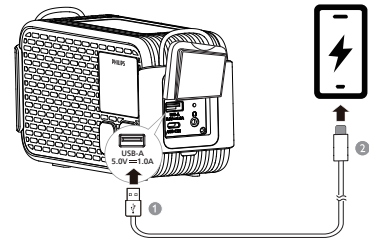

You can use this emergency radio to charge your cellphone or other small devices in an emergency.

Connect the standard size end of a USB cable (not included) to the USB-A port on the side of the emergency radio, then connect the other end to the charging port on your device.

### Headphone output

- 1 Connect a pair of headphones/earphones to the headphone jack on the side of your radio.
- 2 Press **VOL + /VOL -** to adjust the volume.

### Factory reset

- 1 In standby mode, press **VOL -** to set the display brightness to "Low".
- 2 Press and hold for 3 seconds.  
↳ The firmware version will be displayed.
- 3 Press , and all characters and icons on the display screen will light up.
- 4 Press again to restore all radio settings to the factory default settings.  
↳ [---] is displayed on the screen.

## 10 Product specifications

### Note

- Product information is subject to change without prior notice.

#### Amplifier

Rated output power 3W RMS (THD 10%)

#### Tuner

Tuning range (FM) 87.5-108 MHz

Tuning grid 50 kHz

Tuning range (AM) 520-1710 kHz

Tuning grid 10 kHz

Sensitivity

- Mono, 26 dB S/N ratio <22 dBf

Total harmonic distortion <10%

Signal to noise ratio >50 dBA

#### General information

USB-C In port 5V  $\equiv$  2A

USB-A Out port 5.0V  $\equiv$  1.0A

Lithium battery 3.65V/5200mAh

Dimensions (W x H x D) 186x103x77 mm

Weight (main unit) 670g

## 11 Troubleshooting



### Warning

- Never remove the casing of the product.

To keep the warranty valid, never try to repair the device yourself. If you encounter problems when using this device, check the following points before requesting service. If the problem remains unsolved, go to the Philips webpage [www.philips.com/support](http://www.philips.com/support). When you contact Philips, make sure that the device is nearby and the model number and serial number are available.

#### No power

- Make sure the emergency radio is fully charged.
- Make sure the USB socket of the emergency radio is properly connected.

#### No sound

- Adjust the volume on the emergency radio.

#### No response from the emergency radio

- Restart the emergency radio.

#### Poor radio reception

- Keep the emergency radio away from other electronic devices to avoid radio interference.
- Fully extend and adjust the position of the antenna.

#### Alarm does not work

- Set the clock/alarm correctly.

#### Clock/alarm setting erased

- Reset the clock/alarm.

## 12 Notice

### Compliance

Any changes or modifications made to this device that are not expressly approved by MMD Hong Kong Holding Limited may void the user's authority to operate the product. Hereby, TP Vision Europe B.V. declares that this product is in compliance with the essential requirements and other relevant provisions of RED Directive 2014/53/EU and UK Radio Equipment Regulations SI 2017 No 1206. You can find the Declaration of Conformity at [www.philips.com/support](http://www.philips.com/support).



This product complies with the radio interference requirements of the European Community.



This product is designed and manufactured with high-quality materials and components, which can be recycled and reused.



This symbol means the product must not be discarded as household waste and should be delivered to an appropriate collection facility for recycling. Follow local rules and never dispose of the product and rechargeable batteries with normal household waste.

Correct disposal of old products and rechargeable batteries helps prevent negative consequences for the environment and human health.



This symbol means that the product contains batteries covered by European Regulation 2023/1542 which cannot be disposed of with normal household waste. Inform yourself about the local separate collection system for electrical and electronic products and batteries. Follow local rules and never dispose of the product and batteries with normal household waste. Correct disposal of old products and batteries helps prevent negative consequences for the environment and human health.

### Removing the integrated batteries

Make sure the product is disconnected from power before removing the integrated battery.

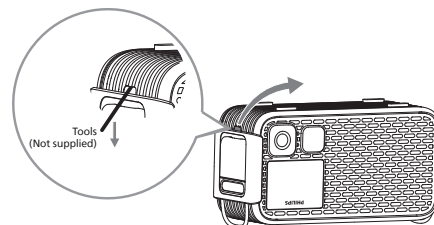

Integrated battery

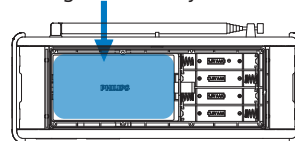

For illustration only



MMD Hong Kong Holding Limited. All rights reserved. Specifications are subject to change without notice. Philips and the Philips Shield Emblem are registered trademarks of Koninklijke Philips N.V. and are used under license. This product has been manufactured by and is sold under the responsibility of MMD Hong Kong Holding Limited or one of its affiliates, and MMD Hong Kong Holding Limited is the warrantor in relation to this product.

