

EVNIA

27M2D5901A



EN

User manual

Register your product and get support at www.philips.com/welcome

PHILIPS

Table of Contents

1. Important	1
1.1 Safety precautions and maintenance	1
1.2 Notational Descriptions	3
1.3 Disposal of product and packing material	4
2. Setting up the monitor	5
2.1 Installation	5
2.2 Operating the monitor	8
2.3 Remove the Base Assembly for VESA Mounting	12
2.4 MultiClient Integrated KVM	13
2.5 MultiView	15
3. Image Optimization	17
3.1 SmartImage	17
3.2 SmartContrast	19
3.3 Customize color space	19
4. Adaptive Sync	20
5. Ambiglow	21
6. HDR	22
7. Technical Specifications	23
7.1 Resolution & Preset Modes	26
8. Power Management	28
9. Customer care and warranty	29
9.1 Philips' Panel Monitors Pixel Defect Policy	29
9.2 Customer Care & Warranty	32
10. Troubleshooting & FAQs	33
10.1 Troubleshooting	33
10.2 General FAQs	34
10.3 Multiview FAQs	37

1. Important

This electronic user's guide is intended for anyone who uses the Philips monitor. Take time to read this user manual before you use your monitor. It contains important information and notes regarding the operation of your monitor.

The Philips guarantee applies provided that the product is handled for its intended use, by its operating instructions, and accompanied by the presentation of the original invoice or cash receipt that indicates the date of purchase, dealer's name and model, and production number of the product.

1.1 Safety precautions and maintenance

Warnings

The use of controls, adjustments, or procedures other than those specified in this document may result in exposure to shock, electrical hazards, and/or mechanical hazards.

Read and follow these instructions when connecting and using your monitor.

Excessive sound pressure from earphones and headphones can cause hearing loss. Adjustment of the equalizer to maximum capacity increases the earphones and headphones output voltage; thereby increasing the sound pressure level.

Operation

- Please keep the monitor out of direct sunlight. Lengthy exposure to this type of environment may result in discoloration and damage to the monitor.

- Keep the display away from oil. Oil may damage the plastic cover of the display and void the warranty.
- Remove any object that could fall into ventilation holes or prevent proper cooling of the monitor's electronics.
- Do not block the ventilation holes in the cabinet.
- When positioning the monitor, make sure the power plug and outlet are easily accessible.
- If turning off the monitor by detaching the power cable or DC power cord, wait for 6 seconds before attaching the power cable or DC power cord before returning to normal operation.
- Please use the approved power cord provided by Philips all the times. If your power cord is missing, please contact your local service center. (Please refer to the Service contact information located in the Important information manual.)
- Operate under the specified power supply. Use of incorrect voltage will cause malfunction and may cause fire or electric shock.
- Protect the cable. Do not pull or bend the power cable and signal cable. Do not place the monitor or any other heavy objects on the cables. If damaged, the cables may cause fire or electric shock.
- Do not subject the monitor to severe vibration or high-impact conditions during operation.
- To avoid potential damage, like the panel peeling from the bezel, ensure that the monitor does not tilt downward by more than -5 degrees. If the -5 degree downward tilt angle maximum is exceeded, the monitor

damage will not be covered under warranty.

- Do not knock or drop the monitor during operation and/or transportation.
- Excessive usage of the monitor can cause eye discomfort. It's recommended to take shorter breaks more often at your workstation than longer breaks and less often. For example, a 5-10 minute break after 50-60-minute continuous screen use is likely to be better than a 15-minute break every two hours. Prevent eye strain while using the screen for a constant period by :
 - Looking at something varying distances after a long period of focusing on the screen.
 - Conscious Blinking while you work.
 - Gently closing and rolling your eyes to relax.
 - Reposition your screen to the appropriate height and angle.
 - Adjust the brightness and contrast to an appropriate level.
 - Adjust the environment lighting similar to that of your screen brightness. Avoid fluorescent lighting and surfaces that don't reflect too much light.
 - Seeing a doctor if your symptoms worsen.

Maintenance

- To protect your monitor from possible damage, do not put excessive pressure on the LCD panel. When moving your monitor, grasp the frame to lift; do not lift the monitor by placing your hand or fingers on the LCD panel.

- Oil-based cleaning solutions may damage the plastic parts and void the warranty.
- Unplug the monitor if you are not going to use it for an extensive period.
- Unplug the monitor if you need to clean it with a slightly damp cloth. The screen may be wiped with a dry cloth when the power is off. However, never use organic solvents, such as alcohol or ammonia-based liquids.
- To avoid the risk of shock or permanent damage to the set, do not expose the monitor to dust, rain, water, or excessive moisture.
- If your monitor gets wet, wipe it with a dry cloth as soon as possible.
- If a foreign substance or water gets in your monitor, please turn the power off immediately and disconnect the power cord. Then, if damaged, send it to the maintenance center.
- Do not store or use the monitor in locations exposed to heat, direct sunlight, or extreme cold.
- To maintain the best performance of your monitor and use it for a longer lifetime, please use the monitor in a location that falls within the following temperature and humidity ranges:
 - Temperature: 0°C-40°C 32°F-104°F
 - Humidity: 20%-80% RH

Important information for Burn-in/ Ghost image

- Please always turn on the Screen Saver and Pixel Orbiting functions from the On Screen Display (OSD) menu. For additional information, please refer to Chapter 8 on Screen Maintenance.

- “Burn-in”, “after-imaging”, or “ghost imaging” is a well-known phenomenon in LCD panel technology. In most cases, the “burn-in”, “after-imaging” or “ghost imaging” will disappear gradually over some time after the power has been switched off.

 **Warning**

It is highly recommended that you always turn on the Screen Saver and Pixel Orbiting function from On Screen Display (OSD) menu in order to best protect the screen.

Service

- The casing cover should be opened only by qualified service personnel.
- If there is any need for any document for repair or integration, please contact your local service center. (You can refer to the service contact information listed in the important information manual.)
- For transportation information, please refer to “Technical Specifications”.
- Do not leave your monitor in a car under direct sunlight.

 **Note**

Consult a service technician if the monitor does not operate normally or you are not sure what procedure to take when the operating instructions given in this manual.

1.2 Notational Descriptions

The following subsections describe the notational conventions used in this document.

Notes, Cautions, and Warnings

Throughout this guide, blocks of text may be accompanied by an icon and printed in bold or italic type. These blocks contain notes, cautions, and/or warnings.

They are used as follows:

 **Note**

This icon indicates important information and tips that help you make better use of your computer system.

 **Caution**

This icon indicates information that tells you how to avoid either potential damage to the hardware or loss of data.

 **Warning**

This icon indicates the potential for bodily harm and tells you how to avoid the problem.

Some warnings may appear in alternate formats and may not be accompanied by an icon. In such cases, the specific presentation of the warning is mandated by the relevant regulatory mechanism.

1.3 Disposal of product and packing material

Waste Electrical and Electronic Equipment-WEEE



This marking on the product or its packaging illustrates that, under European Directive 2012/19/EU governing used electrical and electronic appliances, this product may not be disposed with normal household waste. You are responsible for the disposal of this equipment through a designated waste electrical and electronic equipment collection. To determine the locations for dropping off such waste, contact your local government office, the waste disposal organization that serves your household, or the store at which you purchased the product.

Your new monitor contains materials that can be recycled and reused. Specialized companies can recycle your product to increase the number of reusable materials and minimize the amount to be disposed of.

All redundant packing material has been omitted. We have done our utmost to make the packaging easily separable into mono materials.

Please find out about the local regulations on how to dispose of your old monitor and packing from your sales representative.

Taking back/Recycling Information for Customers

Philips establishes technically and economically viable objectives to optimize the environmental performance of the organization's products, services, and activities.

From the planning, design, and production stages, Philips emphasizes the importance of making products that can easily be recycled. At Philips, end-of-life management primarily entails participation in national take-back initiatives and recycling programs whenever possible, preferably in cooperation with competitors, which recycle all materials (products and related packaging material) following all Environmental Laws and taking back programs with the contractor company.

Your display is manufactured with high-quality materials and components which can be recycled and reused.

To learn more about our recycling program please visit:

<http://www.philips.com/a-w/about/sustainability.html>

2. Setting up the monitor

2.1 Installation

1 Package contents

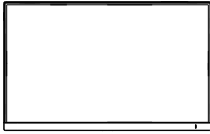

Power



HDMI



DP



USB A-B



USB C-C



USB C-A



USB C-C/A

*Different according to region

2 Install the base

1. Place the monitor face down on soft and smooth surface taking care to avoid scratching or damaging the screen.

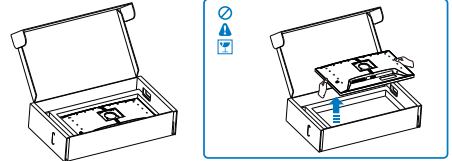

2. Hold the stand with both hands.
 - (1) Gently attach the base to the stand.
 - (2) Use your fingers to tighten the screw located at the bottom of the base, and secure the base to the stand tightly.
 - (3) Gently attach the stand to the VESA mount area until the latch locks the stand.

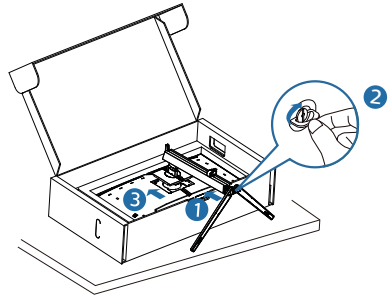

- !** **Caution**
Place the monitor face down on a smooth surface. Pay attention not to scratch or damage the screen.

3 Connecting to your PC

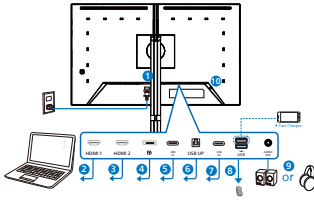

USB C-C



USB Type-C



USB A-C



USB Type-A



USB hub



Headphone hook

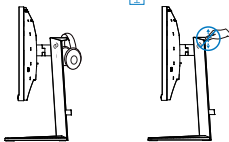

- 1 AC power input
- 2 HDMI 1 input
- 3 HDMI 2 input
- 4 DisplayPort input
- 5 USB C1
- 6 USB UP
- 7 USB C2
- 8 USB downstream/USB fast charger
- 9 Audio Out
- 10 Kensington anti-theft lock

Connect to PC

1. Connect the power cord to the back of the monitor firmly.
2. Turn off your computer and unplug its power cable.
3. Connect the monitor signal cable to the video connector on the back of your computer.
4. Plug the power cord of your computer and your monitor into a nearby outlet.
5. Turn on your computer and monitor. If the monitor displays an image, installation is complete.

Note

The headphone holder is securely integrated with the monitor stand and is specifically designed for headset storage. Please note that excessive pulling/dragging on the hook, which effectively goes beyond its intended use, may result in damage.

4 USB hub

To comply with International energy standards, the USB hub/ports of this display are disabled during Standby and Off modes.

Connected USB devices will not work in this state.

To permanently put the USB function in the "ON" state, please go to OSD Menu, then select "USB standby mode", and switch it to the "ON" state. Somehow if your monitor resets to the factory setting, ensure to select "USB standby mode" to "ON" state in the OSD menu.

5 USB charging

This display has USB ports capable of standard power output including some with USB charging functions (identifiable with power icon ). You can use these ports to charge your Smartphone or power your external HDD, for example. The display must be powered ON at all times to be able to use this function.

Some selected Philips displays may not Power or Charge your device when it enters "Sleep/Standby" mode (White power LED blinking). In that case, please enter to OSD Menu and select "USB Standby Mode", then, turn the function to "ON" mode (default=OFF). This will then keep the USB power and charging functions active even when the monitor is in sleep/standby mode.

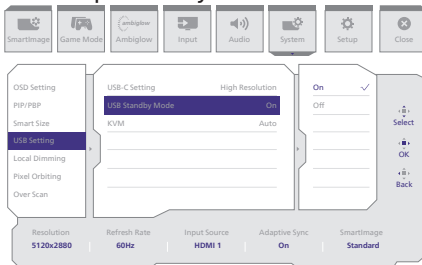

⚠ Warning

USB 2.4Ghz wireless devices, such as wireless mice, keyboards, and headphones, may result in decreased efficiency of radio transmission of USB 3.2 devices. Should this happen, please try the following methods to help reduce the effects:

- Try to keep USB 2.0 receivers away from a USB 3.2 connection port.
- Use a standard USB extension cable or USB hub to increase the space between your wireless receiver and the USB3.2 connection port.

2.2 Operating the monitor

1 Description of the control buttons

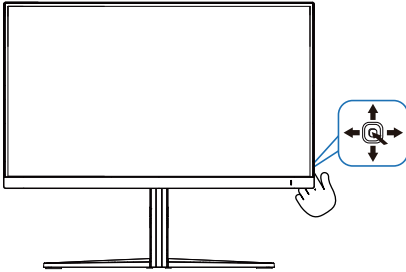

1		Press to switch power on. Press more than 3 seconds to switch power off.
2		Access the OSD menu. Confirm the OSD adjustment.
3		Adjust the Dual Mode. Adjust the OSD menu.
4		Change the signal input source. Adjust the OSD menu.
5		SmartImage Game menu. There are multiple selections: Standard, FPS, Racing, RTS, Movie, LowBlue Mode, EasyRead, Economy, SmartUniformity, Game 1 , Game 2 and D-Mode . When the monitor receives HDR signal, SmartImage will show the HDR menu. There are multiple selections in this menu: HDR Game, HDR Movie, HDR Vivid, DisplayHDR 400, Personal and Off. Return to previous OSD level.

2 Description of the On-Screen Display

What is On-Screen Display (OSD)?

On-Screen Display (OSD) is a feature in all Philips LCD monitors. It allows an end user to adjust screen performance or select functions of the monitors directly through an on-screen instruction window. A user-friendly OSD interface is shown below:

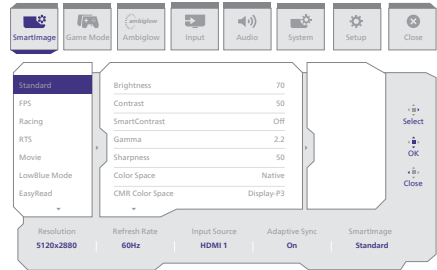

Basic and simple instructions on the control keys

To access the OSD menu on this Philips display, simply use the single toggle button located on the rear side of the display. The single button operates like a joystick. To move the cursor, simply toggle the button in four directions. Press the button to select the desired option.

The OSD Menu

Below is an overall view of the structure of the On-Screen Display. You can use this as a reference when you want to work your way around the different adjustments later on.

Main menu	Sub menu	Option	Value						
SmartImage	Standard, FPS, Racing, RTS, Movie, LocalFile Mode, Eco/Power/Economy, SmartUniformity, Game1, Game2, D-Mode	Brightness	0-100						
		Contrast	0-100						
		SmartContrast	On, Off						
		Gamma	1.8, 2.0, 2.2, 2.4, 2.6, WRGB						
		Sharpness	0-100						
		Color Space	Native, Display P3, DCI-P3, DCI-P3 (GSO), sRGB, Adobe RGB, AdobeRGB2020, Rec. 709						
		CMR Color Space	Display P3, DCI-P3, DCI-P3 (GSO), sRGB, Adobe RGB, AdobeRGB2020, Rec. 709, Custom Mode						
		Color Temperature	On, Off						
		W.B. Settings	On, Off						
		Red	0-100						
		Green	0-100						
		Blue	0-100						
		Reset	Yes, No						
		SmartImage(HDR) (HDR source)	HDR Game, HDR Movie, HDR Vivid	Brightness	0-100				
				Contrast	0-100				
				Tone Mapping	HDR 400, More Details, Balanced, Brighter, HDR10-				
				HDR Color Space	DCI-P3, Rec. 2020				
CMR HDR Color Space	DCI-P3, Rec. 2020								
Light Enhancement	0-3								
Color Enhancement	0-3								
Reset	Yes, No								
DisplayHDR 400	Personal			Brightness	0-100				
				Contrast	0-100				
				Tone Mapping	HDR 400, More Details, Balanced, Brighter, HDR10-				
				HDR Color Space	DCI-P3, Rec. 2020				
				CMR HDR Color Space	DCI-P3, Rec. 2020				
				Light Enhancement	0-3				
				Color Enhancement	0-3				
				Reset	Yes, No				
				Game Mode	Dual Mode	TK 165Hz, QHD 300Hz			
		DP/USB-C Overclock On: SK 160Hz, QHD 300Hz							
		HDMI Overclock On: SK 175Hz, QHD 300Hz							
		Adaptive Sync	Adaptive Sync On, Adaptive Sync Off						
		Smart MBR	MBR Level 0-20						
		Smart MBR Sync	Smart MBR Sync On, Smart MBR Sync Off						
		Contrast	Off, On, Smart Contrast On						
		Sharp ShadowBoost	Off, Level 1, Level 2, Level 3						
		Smart Stripper	Size Off, 1.0, 1.5, 2.0						
Low Input Lag	Position Top, central								
SmartResponse	Off, Fast 1, Faster, Fastest								
Overclock	On, Off								
SmartFrame	SmartFrame Off								
Size	1.3, 2.3, 4.3, 6.7								
Hue, Saturation	Hue, Saturation	Brightness	0-100						
		Contrast	0-100						
		H. Position	0-Max						
		V. Position	0-Max						
		Red	0-100						
		Magenta	0-100						
		Blue	0-100						
		Cyan	0-100						
		Green	0-100						
		Yellow	0-100						
		Ambilight	Light Mode	Follow Video					
				Follow Audio					
				Color Shift					
				Color Wave					
				Color Breathing					
				Starry Night					
				Static Mode					
Ambilight Setting	Ambilight Setting			Colors	Rainbow, White, Red, Rose, Magenta, Violet, Blue, Aqua, Cyan, Aqua, Green, Pear, Yellow, Orange				
				Brightness	Bright, Brighter, Brightest				
				Speed	Low, Normal, High				
				Reset	Yes, No				
				Input	Input	HDMI 1			
						HDMI 2			
						DisplayPort			
						USB C			
						Auto	On, Off		
						Volume(0-100)	0-100		
		Audio	Volume			Mute	Mute On, Mute Off		
						Audio Source	HDMI1, HDMI2, DisplayPort, USB C		
						System	OSD Setting	Horizontal	0-100
								Vertical	0-100
								Transparency	Off, 1, 2, 3, 4
								OSD Time Out	5s, 10s, 20s, 30s, 60s
								PIP/PBP Mode	Off, PIP, PBP
PIP/PBP Input	HDMI1, HDMI 2, DisplayPort, USB C								
PIP Size	Small, Medium, Large								
PIP Position	Top-R, Top-L, Bottom-R, Bottom-L								
Jump									
Smart Size	Smart Size			Full(16:9)					
				13(9:9)					
				Full(Square)					
				13(Square)					
				Aspect					
				24.5"					
		USB Setting	USB Setting	USB-C Setting	High Resolution-Layer 3, USB 2.0, High Data Speed-Layer 3, USB 3.2				
				USB Standby Mode	On, Off				
				AVM	Auto, USB C, USB Up				
				Local Dimming	Local Dimming	Weak, Medium, Strong, Off			
						Pixel Orbiting	Pixel Orbiting On, Pixel Orbiting Off		
						Over Scan	Over Scan On, Over Scan Off		
						Setup	Power LED	0-4	
								Language	English, Deutsch, Español, Français, Italiano, Magyar, Nederlands, Portugals do Brasil, Polski, Porens, Svenska, Sloven, Türkçe, Čeština, Vietnamese, 繁體中文, 简体中文
								Resolution Notice	Resolution Notice On, Resolution Notice Off
								Information	Model
								Reset	SK
Yes, No									

Note

- The local dimming feature cannot be enabled simultaneously with the Ambiglow feature's "Follow Video" function.
 - Game mode: This model is equipped with new features in OSD which gives you high-quality visual experience.
 - Dual Mode
Easily switch between UHD@165Hz for stunning clarity and QHD@330Hz for ultra-smooth gameplay.
 - Smart MBR
In an effort to reduce motion blur, this monitor's LED backlight will work simultaneously with the refresh rate to control brightness levels for the best picture clarity. Please note that Smart MBR is a type of gaming mode and it is recommended to turn the function off when not gaming as it may cause screen-flickering.
 - Smart MBR Sync
This feature pairs Smart MBR together with Adaptive Sync technology; which effectively eliminates motion blur and ghosting on screen. Sharp and speedy gaming visuals are guaranteed, even at high frame rates. Please note that Smart MBR Sync is a type of gaming mode.
 - Smart Crosshair
Color of Crosshair is set by default. When Smart Crosshair is on, the color will change as complementary color to the background color. Smart Crosshair enhances the accuracy of aiming so you can spot the enemies more easily.
 - Stark Shadow Boost
This feature enhances dark scenes without overexposing lightened areas. The Stark ShadowBoost feature has three selectable levels that offer texturized images with better color saturation with higher contrast so you can see better in both light and dark environments. In addition, this feature helps you fine-tune your sight so that enemies get exposed more quickly when gaming.
 - Smart Sniper
This feature enables you to zoom in to multiple targets at once; ultimately making it easier to aim and hit your enemies.
- ### 3 Resolution notification
- This monitor is designed for optimal performance at its native resolution: 5120 x 2880.
- When the monitor is powered on at a different resolution, an alert is displayed on the screen as follows: Use 5120 x 2880 for best results.
- Display of the native resolution alert can be switched off from Setup in the OSD (On Screen Display) menu.
- ### 4 Overclock Your Monitor
- The Overclock function increases the native refresh rate, however, it does have some associated risks along with it. Please follow the instructions below to activate the Overclock feature on your monitor:
1. First, check your PC's graphics card and make sure it is capable of achieving the maximum resolution and refresh rate of this monitor.
 2. If needed, install the latest version of graphics card driver.

3. Ensure the Overclock signal port is available (Please refer to the chapter Resolution & Preset Modes in the dedicated user manual).
4. Modify the refresh rate in the On Screen Display (OSD) settings.

To enable the Overclock feature, you will need to go to OSD menu > Game Mode > Overclock.

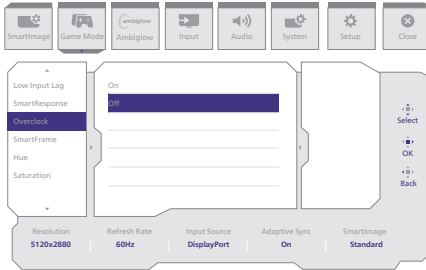

Note

Please note that the default setting for Overclock is off as it can cause irreversible damage to your monitor. If the screen is displayed abnormally after rebooting, please switch off the Overclock setting located in the monitor's OSD menu. Alternatively, you can unplug the power cable. Then, press and hold the left button of the menu toggle on the monitor while plugging the power cable back in. Keep holding the button until the screen turns on. This will turn off the Overclock function, and the monitor will return to its default refresh rate.

5 Firmware

The over-the-air (OTA) firmware update is through the Evnia Precision Center software and is easily downloadable through the Philips website. What does Evnia Precision Center do? It is an additional software that helps control the photo, audio, and the other on-screen graphic settings of the monitor.

In the "Setup" section, you can check which firmware version you currently have and if you need to upgrade or not. In addition, it is important to note that the firmware upgrades must be done through the Evnia Precision Center software. It is necessary to be connected to a network when updating the firmware on Evnia Precision Center over-the-air (OTA).

6 Physical Function

Tilt

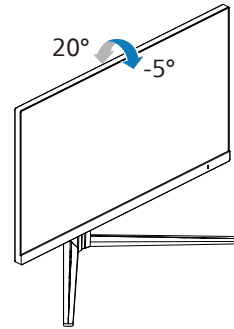

Swivel

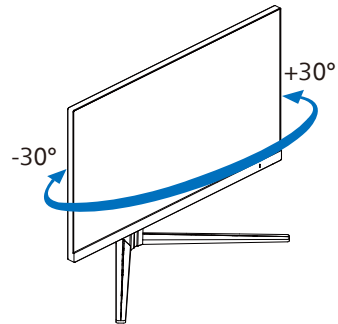

Height adjustment

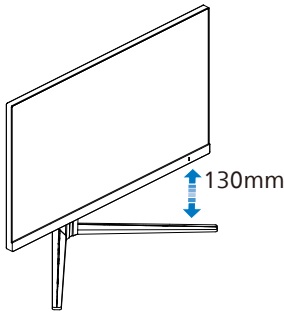

Pivot

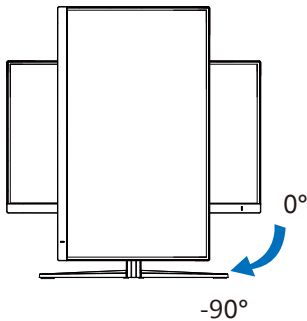

Warning

- To avoid potential screen damage, such as panel peeling, ensure that the monitor does not tilt downward by more than -5 degrees.
- Do not press the screen while adjusting the angle of the monitor. Grasp only the bezel.

2.3 Remove the Base Assembly for VESA Mounting

Before you start disassembling the Display base, please follow the instructions below to avoid any possible damage or injury.

1. Place the monitor face down on a smooth surface. Pay attention not to scratch or damage the screen.

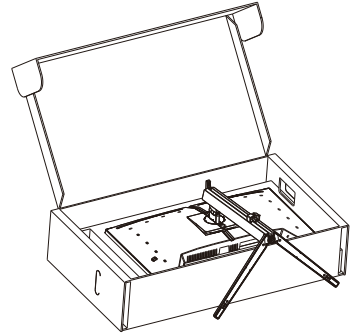

2. While keeping the release button pressed, tilt the stand and slide it out.

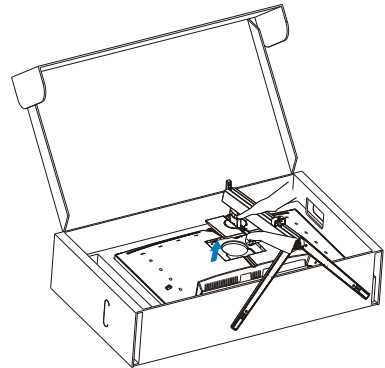

Note

- This monitor accepts a 100mm x 100mm VESA-Compliant mounting interface. VESA Mounting Screw M4. Always contact manufacturer for wall-mount installation.

- The size of the wall-mounted threaded post of this monitor is 10.0 millimeters, and the depth of the wall-mounting hole, including the back cover, is 10.7 millimeters.

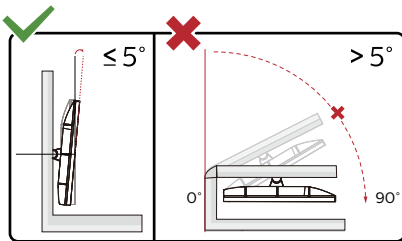
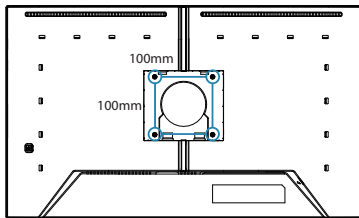

* Display design may differ from those illustrated in this manual.

⚠ Warning

- To avoid potential screen damage, such as panel peeling, ensure that the monitor does not tilt downward by more than -5 degrees.
- Do not press the screen while adjusting the angle of the monitor. Grasp only the bezel.

2.4 MultiClient Integrated KVM

1 What is it?

With MultiClient Integrated KVM switch, you can control two separate PCs with one monitor-keyboard-mouse set up.

2 How to enable MultiClient Integrated KVM

With the built-in MultiClient Integrated KVM, Philips monitor allows to quickly switch your peripherals back and forth between two devices through the OSD menu setting.

Use USB-C and HDMI or DP as input, then use USB-C/USB-B as USB upstream. Please follow the steps for the settings.

- Connect the USB upstream cable from your dual devices to the "USB C" and "USB UP" port of this monitor at the same time.

Source	USB Upstream
HDMI/DP	USB UP
USB C	USB C

- Connect peripherals to the USB downstream port of this monitor.

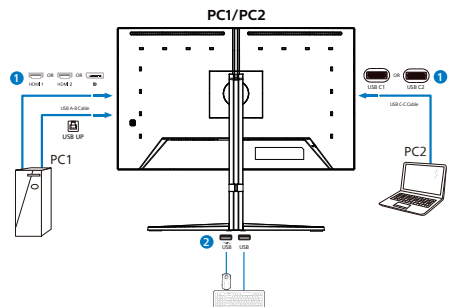

- Enter to OSD menu. Go to KVM layer and select "Auto", "USB C" or "USB Up" to switch the control of peripherals from one device to another. Simply repeat this step for switching the control system using one set of peripheral.

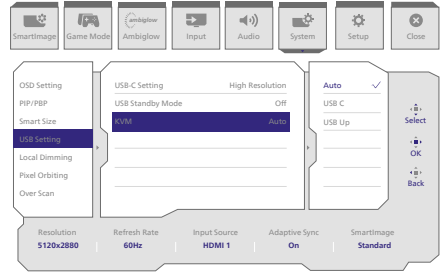
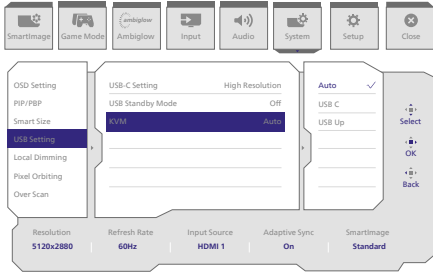

Use DP and HDMI as input then use USB-B/USB-C as USB upstream.

Please follow the steps for the settings.

1. Connect the USB upstream cable from your dual devices to the "USB C" and "USB UP" port of this monitor at the same time.

PC1: USB UP as upstream and HDMI or DP cable for both video and audio transfer.

PC2: USB-C as upstream (USB C-A) and DP or HDMI for both video and audio transfer.

Source	USB Upstream
HDMI or DP	USB UP
DP or HDMI	USB C

2. Connect peripherals to the USB downstream port of this monitor.

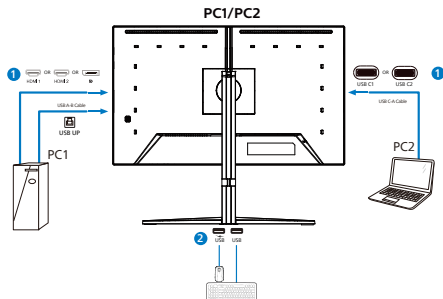

3. Enter to OSD menu. Go to KVM layer and select "Auto", "USB C" or "USB Up" to switch the control of peripherals from one device to another. Simply repeat this step for switching the control system using one set of peripheral.

Note

You can also adopt "MultiClient Integrated KVM" in PBP mode, when you enable PBP, you can see two different sources projected to this monitor side by side simultaneously. "MultiClient Integrated KVM" enhances your operation by using one set of peripherals to control between in two systems through the OSD menu setting. Follow step3 as mentioned above.

2.5 MultiView



1 What is it?

Multiview enables active variety to connect and view so that you can work with multiple devices like PC and Notebook side-by-side simultaneously, thereby making complex multitasking work a breeze.

2 Why do I need it?

With the ultra-high-resolution Philips MultiView display, you can comfortably experience a world of connectivity in the office or at home. With this display, you can conveniently enjoy multiple content sources on one screen. For example, You may want to keep an eye on the live news video feed with audio in the small window, while working on your latest blog... or you may want to edit an Excel file from your Ultrabook, while logged into a secured company intranet to access files from a desktop.

3 How to enable MultiView by OSD menu?

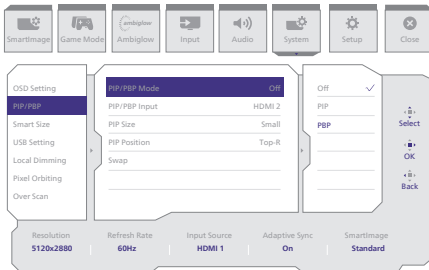

1. Toggle to the right to enter OSD Menu Screen.
2. Toggle to the left or right to select main menu [System], then toggle to the up or down to select [PIP / PBP], then toggle to the right to confirm.
3. Toggle to the up or down to select [PIP / PBP Mode], then toggle to the right.
4. Toggle to the up or down to select [PIP], [PBP], then toggle to the right to confirm your selection.
5. Now you can move backward to set the [PIP / PBP Input], [PIP Size], [PIP Position] or [Swap].
6. Toggle to the right to confirm your selection.

4 MultiView in OSD menu

- PIP / PBP Mode: There are two modes for MultiView: [PIP] and [PBP].

[PIP]: Picture in Picture

Open up a sub-window of another signal source.

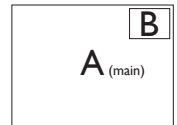

When the sub source is not detected:

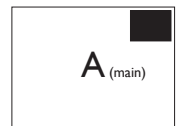

[PBP]: Picture by Picture

Open up a sub-window side-by-side of other signal sources.

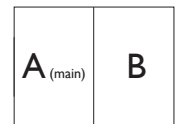

When the sub source is not detected.



Note

The black strip located on the top and the bottom of the screen is for measuring the correct aspect ratio when in the PBP mode. If you expect to see full-screen, adjust your device's resolutions to pop-up attention resolution and you will be able to see 2 devices' source screen project to this display without black strips. It is important to note that the analog signal is not supported on full screen in PBP mode.

- PIP / PBP Input: There are different video inputs to choose from as the sub-display source: [HDMI 1], [HDMI 2], [DP], [USB C1], [USB C2].

Please refer to the table below for compatibility of the main/sub-input source.

		SUB SOURCE POSSIBILITY (x1)				
MultiView	Inputs	HDMI 1	HDMI 2	DisplayPort	USB C1	USB C2
MAIN SOURCE (x1)	HDMI 1	•	•	•	•	•
	HDMI 2	•	•	•	•	•
	DisplayPort	•	•	•	•	•
	USB C1	•	•	•	•	•
	USB C2	•	•	•	•	•

PIP Size: When PIP is activated, there are three sub-window sizes to choose from [Small], [Middle], and [Large].

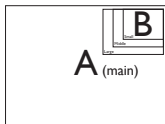

- PIP Position: When PIP is activated, there are four sub-window positions to choose from.

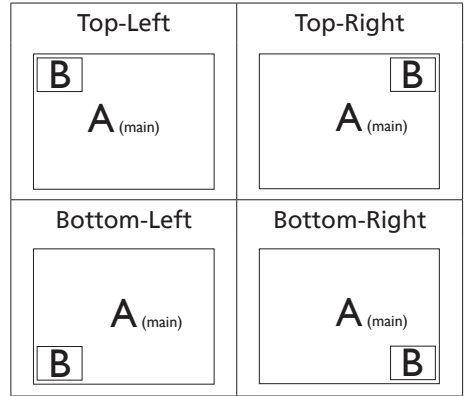

- Swap: The main picture source and the sub-picture source are swapped on the display.

Swap A and B source in [PIP] mode:

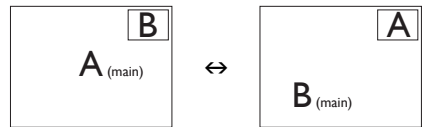

Swap A and B source in [PBP] mode:

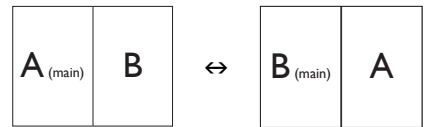

- Off: Stop MultiView function.

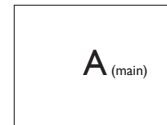

Note

When you activate the SWAP function, the video and its audio source will swap at the same time.

3. Image Optimization

3.1 SmartImage

1 What is it?

SmartImage provides presets that optimize display for different types of content, dynamically adjusting brightness, contrast, color, and sharpness in real-time. Whether you're working with text applications, displaying images, or watching a video, Philips SmartImage delivers great monitor performance.

2 Why do I need it?

It is ideal to have a monitor that delivers an optimized display of all your favorite types of content. Our SmartImage software dynamically adjusts brightness, contrast, color, and sharpness in real-time to enhance your monitor viewing experience.

3 How does it work?

SmartImage is an exclusive, leading-edge Philips technology that analyzes the content displayed on your screen. Based on the scenario you select, SmartImage dynamically enhances the contrast, color saturation, and sharpness of images to enhance the contents being displayed - all in real time by the press of a single button.

4 How to enable SmartImage?

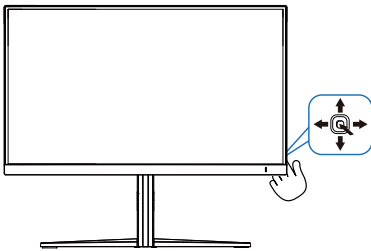

1. Toggle to the left to launch the SmartImage on-screen display.

2. Toggle the up or down to select between the SmartImage modes.
3. The SmartImage on-screen display will remain on screen for 5 seconds, or you can also toggle to the left to make confirmation.

There are multiple selections: Standard, FPS, Racing, RTS, Movie, LowBlue Mode, EasyRead, Economy, SmartUniformity, Game 1, Game 2 and **D Mode**.

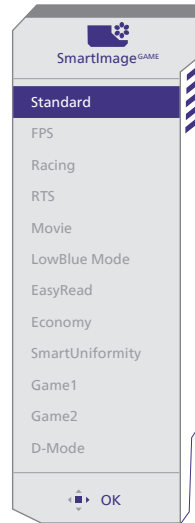

- **Standard:** Enhances text and dampens brightness to increase readability and reduce eye strain. This mode significantly enhances readability and productivity when working with spreadsheets, PDF files, scanned articles, or other similar office applications.
- **FPS:** For playing FPS (First Person Shooters) games. Improves dark theme black level details.
- **Racing:** For playing Racing games. Provides the fastest response time and high color saturation.
- **RTS:** For playing RTS (Real Time Strategy) games, a user-selected portion can be highlighted for RTS

games (through SmartFrame). The picture quality can be adjusted for the highlighted portion.

- **Movie:** Ramped up luminance, deepened color saturation, dynamic contrast, and razor sharpness displays every detail in darker areas of your videos without experiencing color washout.
- **LowBlue Mode:** LowBlue Mode for easy-on-the-eyes productivity. Studies have shown that just as ultra-violet rays can cause eye damage, shortwave length blue light rays from LED displays can cause eye damage and affect vision over time. Developed for well-being, the Philips LowBlue Mode setting uses smart software technology to reduce harmful shortwave blue light.
- **EasyRead:** Helps improve reading of text-based applications like PDF ebooks. By using a special algorithm that increases the contrast and boundary sharpness of text content. The display is optimized for a stress-free reading by adjusting the brightness, contrast, and color temperature of the monitor.
- **Economy:** Under this profile, brightness and contrast are adjusted and backlighting is fine-tuned to produce the right display for everyday office applications.
- **SmartUniformity:** Fluctuations in brightness on different parts of a screen are a common phenomenon among LCD displays. Typical uniformity is measured around 75-80%. By enabling Philips SmartUniformity feature, display uniformity is increased to above 95%. This produces more consistent and true images.
- **Game 1:** User's preference settings saved as Game 1.

- **Game 2:** User's preference settings saved as Game 2.
- **D-Mode:** Optimizes grayscale detail using the DICOM GSDF curve, delivering clearer tonal separation for designers.

When this display receives an HDR signal from the connected device, select a picture mode that best fits your needs.

There are multiple selections: HDR Game, HDR Movie, HDR Vivid, DisplayHDR 400, Personal and Off.

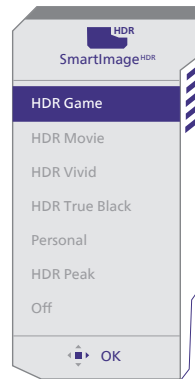

- **HDR Game:** Ideal setting to optimize for playing video games. With brighter white and darker black, the gaming scene is vivid and reveals more details, easily spotting enemies hiding in the dark corner and shadows.
- **HDR Movie:** Ideal setting for watching HDR movies. Deliver better contrast and brightness for a more realistic and immersing viewing experience.
- **HDR Vivid:** Enhancing red, green, and blue for true-to-life visuals.
- **DisplayHDR 400:** Meet VESA DisplayHDR 400 standard.
- **Personal:** Customize available settings in the picture menu.

- **Off:** No optimization by SmartImage HDR.

Note

To switch off the HDR function, please disable the Input device and its content.

Inconsistent HDR settings between the input device and monitor may cause unsatisfying images.

3.2 SmartContrast

1 What is it?

It is a unique technology that dynamically analyzes displayed content and automatically optimizes a monitor's contrast ratio for maximum visual clarity and viewing enjoyment.

2 Why do I need it?

Because SmartContrast offers the best visual clarity and viewing comfort for every type of content. It dynamically controls contrast and adjusts backlighting for bright gaming and video imagery. In addition, by reducing your monitor's power consumption, you save on energy costs and extend the lifetime of your monitor.





3 How does it work?

When you activate SmartContrast, it will analyze the content you are displaying in real time to adjust colors and control backlight intensity. This function will dynamically enhance contrast for a great entertainment experience when viewing videos or playing games.

3.3 Customize color space

You can manually select the appropriate color space mode to properly display the content you are viewing.

1 Select appropriate color space mode to fit the content you're viewing:

1. Press  button to enter OSD menu.
2. Press  or  button to select main menu [SmartImage], then press OK button.
3. Press  or  button to select [Color Space].
4. Select one of colors modes.
5. Press OK button to confirm your selection.

2 There are multiple selections:

- **Native:** The full range of colors that the display is capable of.
- **Display-P3:** Screen devices, especially suitable for Apple products.
- **DCI-P3:** Digital cinema projectors, some movies and games. Photography.
- **DCI-P3 (D50):** Graphic design and prints. D50 white points.
- **sRGB:** Most personal computer applications and games, Internet, and web design.
- **Adobe RGB:** Graphics applications. D65 white points.
- **Adobe RGB (D50):** Graphics applications. D50 white points.
- **Rec. 709:** HD videos.

Note

HDR and color space mode cannot be enabled simultaneously. Please disable HDR before you select one of color space modes.

4. Adaptive Sync



Adaptive Sync

PC gaming has long been an imperfect experience because GPUs and monitors update at different rates. Sometimes a GPU can render many new pictures during a single update of the monitor, and the monitor will show pieces of each picture as a single image. This is called “tearing.” Gamers can fix tearing with a feature called “v-sync,” but the image can become jerky as the GPU waits on the monitor to call for an update before delivering new pictures.

The responsiveness of mouse input and overall frames per second are reduced with v-sync, too. AMD Adaptive Sync technology eliminates all of these problems by letting the GPU update the monitor the moment a new picture is ready, leaving gamers with unbelievably smooth, responsive, tearing-free games.

Followed by the graphic card that are compatible.

- Operating system
 - Windows 11/10
- Graphic Card: R9 290/300 Series & R7 260 Series
 - AMD Radeon R9 300 Series
 - AMD Radeon R9 Fury X
 - AMD Radeon R9 360
 - AMD Radeon R7 360
 - AMD Radeon R9 295X2
 - AMD Radeon R9 290X
 - AMD Radeon R9 290
 - AMD Radeon R9 285
 - AMD Radeon R7 260X
- AMD Radeon R7 260
- Processor A-Series Desktop and Mobility APUs
 - AMD A10-7890K
 - AMD A10-7870K
 - AMD A10-7850K
 - AMD A10-7800
 - AMD A10-7700K
 - AMD A8-7670K
 - AMD A8-7650K
 - AMD A8-7600
 - AMD A6-7400K
 - AMD RX 6500 XT
 - AMD RX 6600 XT
 - AMD RX 6700 XT
 - AMD RX 6750 XT
 - AMD RX 6800
 - AMD RX 6800 XT
 - AMD RX 6900 XT

5. Ambiglow

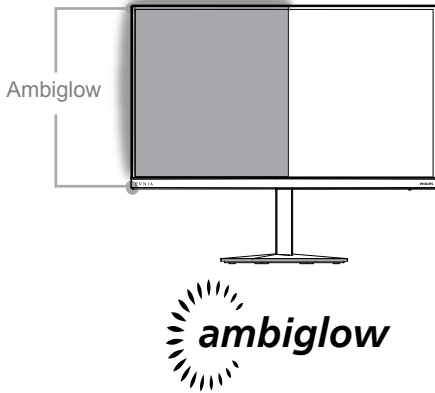

1 What is it?

Ambiglow adds a new dimension to your viewing experience. The innovative and exclusive Ambiglow processor continuously adjusts the overall color and brightness of the gamer's surroundings to match the on-screen image. User options like Auto mode and 3-step brightness settings allow you to adjust the ambiance to your liking and available wall surface. Whether you are playing games or watching movies, Philips Ambiglow offers you a unique and immersive viewing experience.

2 How does it work?

It is recommended that you dim the lighting conditions in your room for maximum effect. Ensure that Ambiglow is set to "on" mode. Start a movie or play a game from your computer. The monitor will react with appropriate colors creating a halo effect and will match the image on the screen. You can also manually select Bright, Brighter, Brightest mode, or off mode, depending on your preference.

3 How to enable Ambiglow

The Ambiglow function can be accessed through the OSD menu. To enable it, follow these steps:

1. Move the joystick to the right to open the OSD menu and navigate to the Ambiglow section.
2. Turn Ambiglow on and choose from various lighting effects (default: Ambiglow Off).
3. Press the joystick to the right again to confirm your selection.

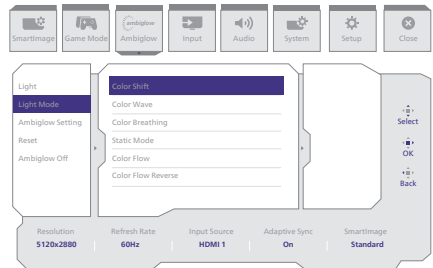

Note

To use the Ambiglow feature, ensure that the Dynamic Lighting feature on your computer is turned off. If Dynamic Lighting is enabled on your device, click the Windows Settings button on the page to quickly access your laptop's Dynamic Lighting settings and turn it off.

6. HDR

HDR Settings in Windows 11/10 system.

Steps

1. Right-click on the desktop, and enter Display settings.
2. Select the display/monitor.
3. Select an HDR-capable display under Rearrange your displays.
4. Select Windows HD Color settings.
5. Adjust Brightness for SDR content.

Note

Windows 11/10 edition is required. Always upgrade to the most updated version. The link below is for further information from the Microsoft official website.

<https://support.microsoft.com/en-au/help/4040263/windows-10-hdr-advanced-color-settings>

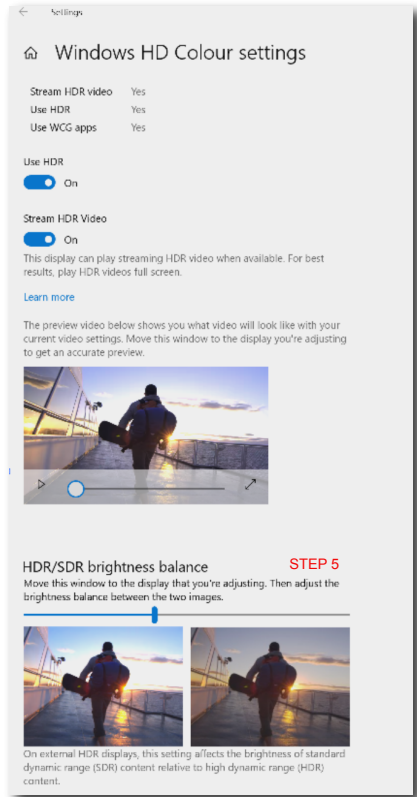
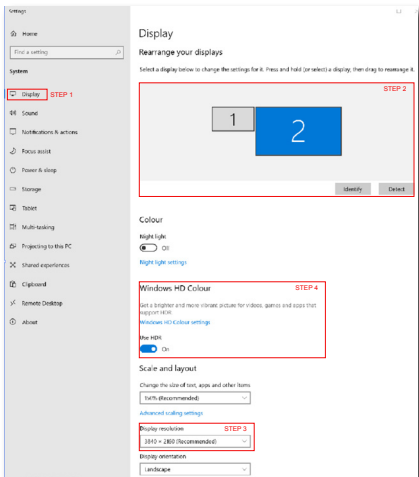

Note

To switch off the HDR function, please disable it from an Input device and its content. Inconsistent HDR settings between the input device and monitor may cause unsatisfying images.

7. Technical Specifications

Picture/Display	
Monitor Panel Type	IPS Technology
Backlight	W-LED
Panel Size	27" W (68.5 cm)
Aspect Ratio	16:9
Pixel Pitch	0.11655 (H) mm x 0.11655 (V) mm
Contrast Ratio (typ.)	1000:1
Recommended Resolution	5120 x 2880 @ 165 Hz
Maximum Resolution	5120 x 2880 @ 165 Hz (5K) 2560 x 1440 @ 330 Hz (QHD)
Viewing Angle	178° (H) / 178° (V) @ C/R > 10 (typ.)
Display Colors	1.07 B (8 bits + FRC) ¹
Picture Enhancement	SmartImage Game /SmartImage HDR
Vertical Refresh Rate	48 Hz - 165 Hz (5K) 48 Hz - 175 Hz (5K HDMI Overclock) 48 Hz - 180 Hz (5K DP Overclock) 48 Hz - 330 Hz (QHD) 48 Hz - 350 Hz (QHD HDMI/DP Overclock)
Horizontal Frequency	30 KHz - 500 KHz
sRGB	YES
Flicker Free	YES
SoftBlue technology	YES ²
Adaptive Sync	YES
EasyRead	YES
SmartUniformity	YES
Delta E	YES
HDR	VESA Certified DisplayHDR™ 400
Ambiglow	YES
Over-the-air firmware update	YES
Connectivity	
Signal Input source	HDMI, DisplayPort, USB-C (DP Alt mode)
Connectors	1 x USB-C (upstream) 2 x HDMI 2.1 (HDCP 1.4, HDCP 2.3) 1 x DisplayPort 2.1 (HDCP 1.4, HDCP 2.3) 1 x Audio out 1 x USB-B (upstream) 2 x USB-A (downstream with x1 fast charge FC 1.2) 1 x USB-C (downstream with x1 PD 15W)
Sync input	Separate Sync

USB			
USB Ports	USB UP x1 (upstream) USB-C x1 (upstream, DP Alt mode) USB-A x2 (downstream with x1 fast charge BC 1.2)		
Power Delivery	USB-C: USB PD version 3.0, up to 96W (5V/3A, 7V/3A, 9V/3A, 10V/3A, 12V/3A, 15V/3A, 20V/ 4.8A) USB-A: x1 fast charge B.C 1.2, up to 7.5W (5V/1.5A)		
Super Speed	USB-C/USB-A: USB 3.2 Gen1, 5 Gbps		
Convenience			
Built-in speaker	5W x 2		
MultiView	PIP/PBP mode, 2xdevices		
OSD Languages	English, German, Spanish, Greek, French, Italian, Hungarian, Dutch, Portuguese, Brazil Portuguese, Polish, Russian, Swedish, Finnish, Turkish, Czech, Ukrainian, Simplified Chinese, Traditional Chinese, Japanese, Korean		
Other Convenience	VESA mount (100 x 100 mm), Kensington Lock		
Plug & Play Compatibility	DDC/CI, sRGB, Windows 11/10, Mac OS X		
Stand			
Tilt	-5 / +20 degree		
Swivel	-30 / +30 degree		
Height adjustment	130 mm		
Pivot	90 degree		
Power			
Consumption	AC Input Voltage at 100VAC , 60Hz	AC Input Voltage at 115VAC , 60Hz	AC Input Voltage at 230VAC, 50Hz
Normal Operation	38.4 W (typ.)	38.3W (typ.)	37.3 W (typ.)
Sleep (Standby mode)	0.5 W (typ.)	0.5 W (typ.)	0.5 W (typ.)
Off mode	0.3 W (typ.)	0.3 W (typ.)	0.3 W (typ.)
Heat Dissipation*	AC Input Voltage at 100VAC , 60Hz	AC Input Voltage at 115VAC , 60Hz	AC Input Voltage at 230VAC , 50Hz
Normal Operation	131.06 BTU/hr (typ.)	130.72 BTU/hr (typ.)	127.30 BTU/hr (typ.)
Sleep (Standby mode)	1.71 BTU/hr (typ.)	1.71 BTU/hr (typ.)	1.71 BTU/hr (typ.)
Off mode	1.02 BTU/hr (typ.)	1.02 BTU/hr (typ.)	1.02 BTU/hr (typ.)
Power LED indicator	On mode: White, Standby/Sleep mode: White (blinking)		
Power Supply	Built-in, 100-240VAC, 50/60Hz		
Dimensions			
Product with stand (WxHxD)	614 x 526 x 262 mm		
Product without stand (WxHxD)	614 x 368 x 75 mm		

Product with packaging (WxHxD)	840 x 478 x 188 mm
Weight	
Product with stand	6.07 kg
Product without stand	4.65 kg
Product with packaging	10.48 kg
Operating Condition	
Temperature range (operation)	0°C to 40°C
Relative humidity (operation)	20% to 80%
Atmospheric pressure (operation)	700 to 1060hPa
Altitude (operation)	0~ 5000 m (0~ 16404ft)
Temperature range (Non-operation)	-20°C to 60°C
Relative humidity (Non-operation)	10% to 90%
Atmospheric pressure (Non-operation)	500 to 1060hPa
Altitude (Non-operation)	0~ 12192m (0~ 40000ft)
Environmental and energy	
ROHS	YES
Packaging	100% recyclable
Specific Substances	100% PVC BFR free housing
Cabinet	
Color	White
Finish	Texture

¹ For more information, please refer to Chapter 7.1 on Display Input Format.

² This monitor features SoftBlue technology. This integrated feature offers increased visual comfort and protection against adverse health effects caused by prolonged exposure to blue light. With the low blue-light panel, the ratio of display emission light in the range from 415-455 nm to the display emission of 400-500nm shall be less than 50%. This monitor provides optimal visual comfort, minimizes eye strain, and supports sustained focus.

Note

1. The data mentioned in this section is subject to change without notice. Go to www.philips.com/support to download the latest version of the leaflet.
2. SmartUniformity and Delta E information sheets are included in the box
3. In order to update the monitor's firmware to the latest version, Please download the Evnia Precision Center software from Philips website. It is necessary to be connected to a network when updating the firmware on Evnia Precision Center over-the-air (OTA).

7.1 Resolution & Preset Modes

H. freq (kHz)	Resolution	V. freq (Hz)
31.47	720 x 400	70.00
31.47	640 x 480	59.94
35.00	640 x 480	66.67
37.86	640 x 480	72.81
37.50	640 x 480	75.00
35.16	800 x 600	56.25
37.88	800 x 600	60.32
48.08	800 x 600	72.19
46.88	800 x 600	75.00
49.73	832 x 624	74.55
48.36	1024 x 768	60.00
56.48	1024 x 768	70.07
60.02	1024 x 768	75.03
79.98	1280 x 1024	75.03
67.50	1920 x 1080	60.00
137.28	1920 x 1080	120.00
177.840	2560 x 1440	120.00
213.408	2560 x 1440	144.00
244.530	2560 x 1440	165.00
296.40	2560 x 1440	200.00
355.680	2560 x 1440	240.00
488.731	2560 x 1440	330.001
176.52	5120 x 2880	60.00
220.65	5120 x 2880	75.00
353.04	5120 x 2880	120.00
423.648	5120 x 2880	144.00
482.13	5120 x 2880	165.00

Note

Please note that your display works best at the native resolution of 5120 x 2880. For best output performance, please always ensure that your graphic card is capable of achieving the maximum resolution and refresh rate of this Philips display.

Display Input Format

5K2K Mode	444/RGB	444/RGB
	HDMI 2.1	DP 2.1
5120 x 2880 165Hz 10bits	OK*	OK*
5120 x 2880 165Hz 8bits	OK	OK
5120 x 2880 144Hz 10bits	OK	OK
5120 x 2880 144Hz 8bits	OK	OK
Minimum:1920 x 1080 @ 60Hz	OK	OK

QHD Mode	444/RGB	444/RGB
	HDMI 2.1	DP 2.1
2560 x 1440 330Hz 10bits	OK*	OK*
2560 x 1440 330Hz 8bits	OK	OK
2560 x 1440 240Hz 10bits	OK	OK
2560 x 1440 240Hz 8bits	OK	OK
Minimum:1920 x 1080 @ 60Hz	OK	OK

*This monitor is capable of 10-bit color processing, it still requires a compatible GPU and devices to function properly. Actual color output performance may vary depending on the monitor display colors.

Note

1. In order for the monitor to function properly, your PC's graphics card must support the following: HDMI2.1 FRL with a bandwidth of up to 48 Gbps (Fixed Rate Link), DisplayPort 2.1 with Display Stream Compression (DSC), The display resolution and refresh rate are also dependent on the computer's graphic card capability.
2. NVIDIA® graphics cards experiences compatibility issues with HDMI 2.1 (FRL6 48Gbps) signal output, may potentially causing display abnormalities such as abnormal display or unexpected computer restarts; therefore, DisplayPort interfaces are recommended for optimal performance with NVIDIA® graphics cards. AMD® graphics cards typically support both HDMI and DisplayPort interfaces. Due to differing strategies among manufacturers, some configuration options may be hidden in driver settings, and actual graphics card support refer to the actual support status

8. Power Management

If you have a VESA DPM compliance display card or software installed on your PC, the monitor can automatically reduce its power consumption when not in use. If an input from a keyboard, mouse, or other input device is detected, the monitor will 'wake up' automatically. The following table shows the power consumption and signaling of this automatic power saving feature:

Power Management Definition					
VESA Mode	Video	H-sync	V-sync	Power Used	LED Color
Active	ON	Yes	Yes	38.3 W (typ.) 242.6 W (max.)	White
Sleep (Standby mode)	OFF	No	No	0.5 W (typ.)	White (blink)
Off mode	OFF	-	-	0.3 W (typ.)	OFF

The following setup is used to measure power consumption on this monitor.

- Native resolution: 5120 x 2880
- Contrast: 50%
- Brightness: 70%
- Color temperature: 6500k with full white pattern

Note

This data is subject to change without notice.

9. Customer care and warranty

9.1 Philips' Panel Monitors Pixel Defect Policy

Philips strives to deliver the highest quality products. We use some of the industry's most advanced manufacturing processes and practice stringent quality control. However, pixel or sub-pixel defects on the TFT Monitor panels used in flat panel monitors are sometimes unavoidable. No manufacturer can guarantee that all panels will be free from pixel defects, but Philips guarantees that any monitor with an unacceptable number of defects will be repaired and/or replaced under warranty. This notice explains the different types of pixel defects and defines acceptable defect levels for each type. To qualify for repair or replacement under warranty, the number of pixel defects on a TFT Monitor panel must exceed these acceptable levels. For example, no more than 0.0004% of the sub-pixels on a monitor may be defective. Furthermore, Philips sets even higher quality standards for certain types or combinations of pixel defects that are more noticeable than others. This policy is valid worldwide.

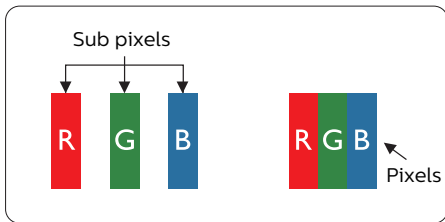

Pixels and Sub pixels

A pixel, or picture element, is composed of three sub-pixels in the primary colors of red, green, and blue. Many pixels together form an image. When all the sub-pixels of a pixel are lit, the three colored sub-pixels together appear as a single white pixel. When all are dark, the three colored sub-pixels together appear as a single black pixel. Other combinations of lit and dark sub-pixels appear as single pixels of other colors.

Types of Pixel Defects

Pixel and sub-pixel defects appear on the screen in different ways. There are two categories of pixel defects and several types of sub-pixel defects within each category.

Bright Dot Defects

Bright dot defects appear as pixels or sub-pixels that are always lit or 'on'. Meaning, a bright dot is a sub-pixel that stands out on the screen when the monitor displays a dark pattern. There are three types of bright dot defects: One lit red, green, or blue sub-pixel.

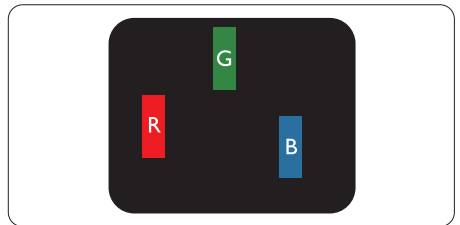

One lit red, green or blue sub pixel.

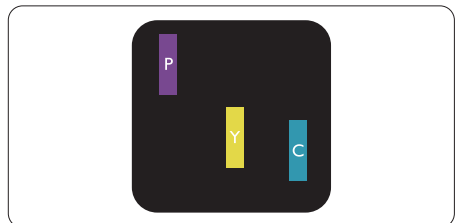

Two adjacent lit sub-pixels:

- Red + Blue = Purple
- Red + Green = Yellow
- Green + Blue = Cyan (Light Blue)

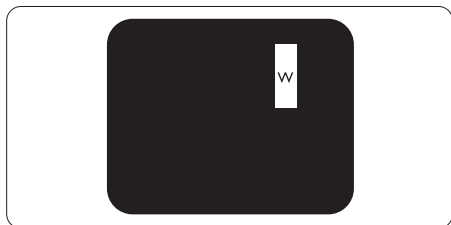

Three adjacent lit sub pixels (one white pixel).

Note

A red or bright blue dot must be more than 50 percent brighter than neighboring dots, while a bright green dot is 30 percent brighter than neighboring dots.

Black Dot Defects

Black dot defects appear as pixels or sub-pixels that are always dark or 'off'. Meaning, a dark dot is a sub-pixel that stands out on the screen when the monitor displays a light pattern. These are the types of black dot defects.

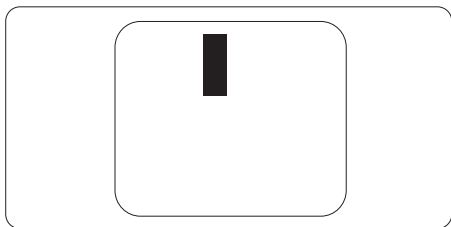

Proximity of Pixel Defects

Because pixel and sub pixels defects of the same type that are near to one another may be more noticeable, Philips also specifies tolerances for the proximity of pixel defects.

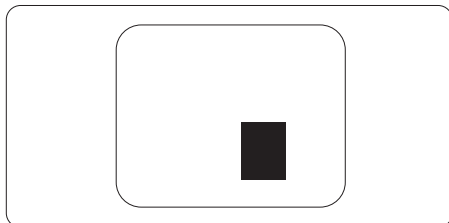

Pixel Defect Tolerances

To qualify for repair or replacement due to pixel defects during the warranty period, a TFT Monitor panel in a Philips flat panel monitor must have pixel or sub-pixel defects exceeding the tolerances listed in the following tables.

BRIGHT DOT DEFECTS	ACCEPTABLE LEVEL
1 lit subpixel	2
2 adjacent lit subpixels	1
3 adjacent lit subpixels (one white pixel)	0
Distance between two bright dot defects*	>15mm
Total bright dot defects of all types	2
BLACK DOT DEFECTS	ACCEPTABLE LEVEL
1 dark subpixel	3 or fewer
2 adjacent dark subpixels	2 or fewer
3 adjacent dark subpixels	0
Distance between two black dot defects*	≥15mm
Total black dot defects of all types	3 or fewer
TOTAL DOT DEFECTS	ACCEPTABLE LEVEL
Total bright or black dot defects of all types	5 or fewer

 **Note**

1 or 2 adjacent sub pixel defects = 1 dot defect

9.2 Customer Care & Warranty

For warranty coverage information and additional support requirements valid for your region, please visit www.philips.com/support website for details or contact your local Philips Customer Care Center.

For an extended warranty, if you would like to extend your general warranty period, an Out of Warranty service package is offered via our Certified Service Center.

For the Warranty Period please refer to Warranty Statement in the Important information manual.

If you wish to make use of this service, please be sure to purchase the service within 30 calendar days of your original purchase date. During the extended warranty period, the service includes pickup, repair, and return service, however, the user will be responsible for all costs accrued.

If the Certified Service Partner cannot perform the required repairs under the offered extended warranty package, we will find alternative solutions for you, if possible, up to the extended warranty period you have purchased.

Please contact our Philips Customer Service Representative or local contact center (by Consumer care number) for more details.

Philips Customer Care Center number listed below.

• Local Standard Warranty Period	• Extended Warranty Period	• Total Warranty Period
• Depend on different Regions	• + 1 Year	• Local Standard warranty period +1
	• + 2 Years	• Local Standard warranty period +2
	• + 3 Years	• Local Standard warranty period +3

**Proof of original purchase and extended warranty purchase required.

Note

Please refer to the Important information manual for the regional service hotline, which is available on the Philips website support page.

10. Troubleshooting & FAQs

10.1 Troubleshooting

This page deals with problems that can be corrected by a user. If the problem persists after you have tried these solutions, contact a Philips customer service representative.

1 Common Problems

No Picture (Power LED not lit)

- Make sure the power cord is plugged into the power outlet and the back of the monitor.
- First, ensure that the power button on the rear of the monitor is in the OFF position, then press it to the ON position.

No Picture (Power LED is White)

- Make sure the computer is turned on.
- Make sure the signal cable is properly connected to your computer.
- Make sure the monitor cable has no bent pins on the connecting side. If yes, repair or replace the cable.
- The Energy Saving feature may be activated. Screen says

Check cable connection

- Make sure the monitor cable is properly connected to your computer. (Also refer to the Quick Start Guide).
- Check to see if the monitor cable has bent pins.
- Make sure the computer is turned on.

Visible signs of smoke or sparks

- Do not perform any troubleshooting steps
- Disconnect the monitor from the mains power source immediately for safety
- Contact Philips customer service representative immediately.

2 Imaging Problems

Image vibrates on the screen

- Check that the signal cable is properly securely connected to the graphics board or PC.

The image appears blurred, indistinct, or too dark

- Adjust the contrast and brightness on On-Screen Display.

An "after-image", "burn-in" or "ghost image" remains after the power has been turned off.

- Uninterrupted display of still or static images over an extended period may cause "burn-in", also known as "after-imaging" or "ghost imaging", on your screen. "Burn-in", "after-imaging", or "ghost imaging" is a well-known phenomenon in LCD panel technology. In most cases, the "burn-in" "after-imaging" or "ghost imaging" will disappear gradually over some time after the power has been switched off.
- Please always turn on the Screen Saver and Pixel Orbiting functions from the On Screen Display (OSD) menu. For additional information, please refer to Chapter 8 on Screen Maintenance.
- Failure to activate a screen saver, or a periodic screen refresh application may result in severe "burn-in" "after-imaging" or "ghost imaging" symptoms that will not disappear

and cannot be repaired. The damage mentioned above is not covered under your warranty.

The image appears distorted or the text is fuzzy or blurred.

- Set the PC's display resolution to the same mode as the monitor's recommended screen native resolution.

Green, red, blue, dark, and white dots appear on the screen

- The remaining dots are a normal characteristic of the liquid crystal used in today's technology, Please refer to the pixel policy for more detail.

* The "power on" light is too strong and is disturbing

- You can adjust the "power on" light using the power LED Setup in OSD Main Controls.

For further assistance, refer to the Service contact information listed in the Important information manual and contact a Philips customer service representative.

* [Functionality is different according to display.](#)

10.2 General FAQs

Q1: When I install my monitor what should I do if the screen shows 'Cannot display this video mode'?

Ans.: Recommended resolution for this monitor: 5120 x 2880.

- Unplug all cables, then connect your PC to the monitor that you used previously.
- In the Windows Start Menu, select Settings/Control Panel. In the Control Panel Window, select the Display icon. Inside the Display Control Panel, select the 'Settings' tab. Under the setting tab, in the box labeled 'desktop area', move the sidebar to 5120 x 2880 pixels.
- Open 'Advanced Properties' and set the Refresh Rate to 60 Hz, then click OK.
- Restart your computer and repeat steps 2 and 3 to verify that your PC is set at 5120 x 2880.
- Shut down your computer, disconnect your old monitor, and reconnect your Philips LCD monitor.
- Turn on your monitor and then turn on your PC.

Q2: What is the recommended refresh rate for an LCD monitor?

Ans.: Recommended refresh rate in LCD monitors is 60 Hz, In case of any disturbance on the screen, you can set it up to 165 Hz to see if that removes the disturbance.

Q3: What are the .inf and .icm files? How do I install the drivers (.inf and .icm)?

Ans.: These are the driver files for your monitor. Your computer may ask you for monitor drivers (.inf and .icm files) when you first install your monitor. Follow

the instructions in your user manual, and monitor drivers (.inf and .icm files) will be installed automatically.

Q4: How do I adjust the resolution?

Ans.: Your video card/graphic driver and monitor together determine the available resolutions. You can select the desired resolution under Windows® Control Panel with the "Display properties".

Q5: What if I get lost when I am making monitor adjustments via OSD?

Ans.: Press the **➡** button, then select [Setup], press the **↓** button, then select [Reset] to recall all the original factory settings.

Q6: Is the LCD screen resistant to scratches?

Ans.: In general it is recommended that the panel surface is not subjected to excessive shocks and is protected from sharp or blunt objects. When handling the monitor, make sure that there is no pressure or force applied to the panel surface side. This may affect your warranty conditions.

Q7: How should I clean the LCD surface?

Ans.: For normal cleaning, use a clean, soft cloth. For extensive cleaning, please use isopropyl alcohol. Do not use other solvents such as ethyl alcohol, ethanol, acetone, hexane, etc.

Q8: Can I change the color setting of my monitor?

Ans.: Yes, you can change your color setting through OSD control as per the following procedures.

- Press the **➡** button to show the OSD (On Screen Display) menu
- Select [SmartImage], press the **↓** button, then press the **➡** button to select the option [Color Temperature] then press the **➡** button to enter the color setting, there are eight settings as below.

1. Color Temperature: The settings are as follows. Native, Preset, 5000K, 6500K, 7500K, 8200K, 9300K, and 11500K. With settings in the 5000K range the panel appears "warm, with a red-white color tone", while a 11500K temperature yields "cool, blue-white toning".
2. R.G.B. Settings: This is a standard setting for ensuring the correct exchange of colors between different devices (e.g. digital cameras, monitors, printers, scanners, etc).
3. User Define: The user can choose his/her preferred R.G.B. by adjusting red, green, and blue colors.

Note

A measurement of the color of light radiated by an object while it is being heated. This measurement is expressed in terms of absolute scale, (degrees Kelvin). Lower Kelvin temperatures such as 2004K are red; higher temperatures such as 9300K are blue. The neutral temperature is white, at 6504K.

Q9: Can I connect my LCD monitor to any PC, workstation, or Mac?

Ans.: Yes. All Philips LCD monitors are fully compatible with standard PCs, Macs, and workstations. You may need a cable adapter to connect the monitor to your Mac system. Please contact your

Philips sales representative for more information.

Q10: Are Philips LCD monitors Plug-and-Play?

Ans.: Yes, the monitors are Plug-and-Play compatible with Windows 11/10, Mac OSX.

Q11: What is Image Sticking, Image Burn-in, After Image, or Ghost Image in LCD panels?

Ans.: Uninterrupted display of still or static images over an extended period may cause "burn-in", also known as "after-imaging" or "ghost imaging", on your screen. "Burn-in", "after-imaging", or "ghost imaging" is a well-known phenomenon in LCD panel technology. Please always turn on the Screen Saver and Pixel Orbiting functions from the On Screen Display (OSD) menu. For additional information, please refer to Chapter 8 on Screen Maintenance.

Warning

Failure to activate a screen saver, or a periodic screen refresh application may result in severe "burn-in" "after-image" or "ghost image" symptoms that will not disappear and cannot be repaired. The damage mentioned above is not covered under your warranty.

Q12: Why is my Display not showing sharp text, and is displaying jagged characters?

Ans.: Your LCD monitor works best at its native resolution of 5120 x 2880. For the best display, please use this resolution.

Q13: How to unlock/lock my hotkey?

Ans.: Please press  for 10 seconds to unlock/lock the hotkey, by doing so, your display pops out "Attention" to show the unlock/lock status as shown below illustrators.

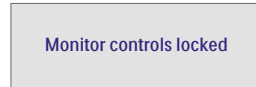
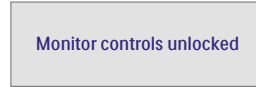

Q14: Where can I find the Important information manual mentioned in EDFU?

Ans.: Important information manual can be downloaded on the Philips website support page.

10.3 Multiview FAQs

Q1: Can I enlarge the PIP sub-window?

Ans.: Yes, there are 3 sizes to select: [Small], [Middle], [Large]. You can press ➡ to enter the OSD menu. Select your preferred [PIP Size] option from the [PIP / PBP] main menu.

Q2: How to listen to Audio, independent of a video?

Ans.: Normally the audio source is linked to the main picture source. If you want to change audio-source input, you can press ➡ enter in the OSD menu. Select your preferred [Audio Source] option from the [Audio] main menu.

Please note that the next time you turn on your display, the display will by default select the audio source you chose last time. In case you want to change it again, you need to go through the above steps to select your new preferred audio source, which then will become the "default" mode.

Q3: Why do the sub-windows flicker when I enable PIP/PBP?

Ans: It's because the sub-windows video source is interlace timing (i-timing), please change the sub-window signal source to progressive timing (P-timing).



2026 © TOP Victory Investments Ltd. All rights reserved.

This product has been manufactured by and is sold under the responsibility of Top Victory Investments Ltd., and Top Victory Investments Ltd. is the warrantor in relation to this product. Philips and the Philips Shield Emblem are registered trademarks of Koninklijke Philips N.V. and are used under license.

Specifications are subject to change without notice.