

PHILIPS

Television
6500 Series

User Manual

32PQT6500/71
43PQT6500/71

Register your product and get support at
www.philips.com/TVsupport



This electrical and electronic product contains some hazardous substances. You may be safe to use it during the environment-friendly use period, and please hand it over to recycle system after environment-friendly use period exceeded.

Suggestive description of the Recycling Administrative Regulations for Waste Electrical and Electronics Products

In order to care and protect the Earth in a better way, please adhere to the national and applicable laws in relation to the recycling management of waste electrical and electronics products when the user no longer needs to use this product, or when it has reached the end of its product life.

Table of contents

1 Caution	2	8 Product information	15
2 Important	3	Display resolutions	15
Safety	3	Multimedia	15
3 Setting Up	6	Audio output power	15
3.1 Read the Safety Instructions	6	Intrinsic resolution	15
3.2 TV Stand and Wall Mounting	6	Tuner/reception/transmission	15
3.3 Power Cable	6	Remote control	15
4 Your TV	7	Power supply	16
Control panel	7	Supported TV mounts	16
Remote control	8	9 Connect Devices	16
Remote control usage	9	9.1 About Connections	17
5 Use your TV	10	9.2 Home Theatre System-HTS	17
Switch the TV on or off	10	9.3 Digital Audio Out-Optical/SPDIF	17
Switch channels	10	9.4 Game Console	17
Watch connected devices	11	9.5 Video Camera	18
Smart TV	11	9.6 AV IN	18
Adjust the TV volume	11	9.7 USB Flash Drive	18
Switch the menu language	11	9.8 Connecting TV	18
6 Settings	12	9.9 Computer	19
Access ti the setting menu	12	10 Connect your TV	19
Picture	12	10.1 Network and Internet	19
Sound	12	11 Troubleshooting	21
Network	12	General issues	21
Pair the device	13	Channel issues	21
Channel Installation	13	Picture issues	21
Child Code	13	Sound issues	22
Device Preferences	13	HDMI connection issues	22
App setting	13	Network connection issues	22
Universal Access	14	Contact us	22
Software Update	14	11 Warranty	23
7 Use more function	14		
EPG	14		
PVR(Optional)	14		
Timeshift(Optional)	14		
USB media function	14		

1 Caution

2026 © TP Vision Europe B.V. All rights reserved. Specifications are subject to change without notice. All trademarks are the property of Koninklijke Philips N.V. or their respective owners. TP Vision Europe B.V. reserves the right to change products at any time without being obliged to adjust previously supplied products. The material in this manual is adequate for the intended use of the system. If the product, or its individual modules or procedures, are used for purposes other than those specified herein, their validity and suitability must first be confirmed. TP Vision Europe B.V. warrants that the material itself does not infringe upon any patents from the United States. No further warranty is expressed or implied. TP Vision Europe B.V. accepts no responsibility for any errors in the content of this document, nor for any issues that arise due to the content of this document. Errors reported to Philips will be rectified and published on the Philips support website as quickly as possible.

Terms of warranty

- Risk of injury, damage to the TV or voided warranty! Never attempt to repair the TV yourself.
- Please only use the TV and accessories as set out by the manufacturer.
- The caution sign printed on the back of the TV indicates the risk of electric shock. Never remove the TV cover. Please contact Philips Customer Support if repairs are needed.
- Operations expressly prohibited in this manual, or any adjustments and assembly steps that are not recommended or authorised in this manual, are not within the scope of the warranty.

Pixel characteristics

This LCD/LED product has a high number of colour pixels. Although its proportion

of effective pixels is 99.999% or more, black dots or bright points of light (red, green or blue) may appear persistently on the screen. This is a structural property of the display (within common industry standards), and is not a fault.

Copyright



Covered by one or more claims of the HEVC patents listed at patentlist.accessadvantage.com.

Future proof with advanced HEVC decoding.



Manufactured under license from Dolby Laboratories. Dolby, Dolby Audio and the double-D symbol are trademarks of Dolby Laboratories Licensing Corporation.



The terms HDMI, HDMI High-Definition Multimedia Interface, HDMI Trade dress and the HDMI Logos are trademarks or registered trademarks of HDMI Licensing Administrator, Inc.

All other registered and unregistered trademarks are the property of their respective owners.

Services and/or software offered by third parties may be changed, suspended, or terminated without prior notice. TP Vision does not bear any responsibility in these sorts of situations.

2 Important

Please read and make sure you understand all instructions before using the TV. Damage caused by a failure to follow the instructions is not covered by the warranty.

Safety

Risk of electric shock or fire!

- Never expose the TV to rain or water. Never place liquid containers (such as vases) next to the TV. If liquids are spilt on or inside the TV, disconnect the TV from the power supply immediately. Contact the Philips Customer Service Centre to have the TV checked before you use it again.
- Never place the TV, remote control or batteries near naked flames or other heat sources (including direct sunlight).
To avoid fire spreading, always keep candles or other naked flames away from the TV, remote control and batteries.



- Never insert any objects into the ventilation slots or other openings on the TV.
- Make sure that no strain is placed on the power cable when swivelling the TV. Strain on the power cable can loosen connections and cause arcing.
- The power plug of the TV must be disconnected to disconnect the TV from the mains supply. When you disconnect the power, always pull out the power plug, and never the cable. Ensure that the power plug, power cable and outlet socket are accessible at all times.

- The power plug is a disconnection device and should be kept so that it is easy to operate.

Risk of short circuit or fire!

- Never expose the remote control or batteries to rain, water or excessive heat.
- Avoid pulling the power plug. Loose power plugs can lead to arcing or fire.

Risk of injury or damage to the TV!

- Two people are required to lift and carry a TV that weighs more than 25 kg or 55 lbs.
- When stand mounting the TV, use only the supplied stand. Secure the stand to the TV tightly. Place the TV on a flat, level surface that can support the combined weight of the TV and the stand.
- When wall mounting the TV, use only a wall mount that can support the weight of the TV. Secure the wall mount to a wall that can support the combined weight of the TV and wall mount. TP Vision Europe B.V. bears no responsibility for improper wall mounting that results in accident, injury or damage.
- If you need to store the TV, disassemble the stand from the TV. Never lay the TV on its back with the stand installed.
- Before you connect the TV to the power outlet, ensure that the power voltage matches the value printed on the back of the TV. Never connect the TV to the power outlet if the voltage is different.
- Parts of this product may be made of glass. Handle with care to avoid injury and damage.

Stability Hazards!

A television set may fall, causing serious personal injury or death. Many injuries,

particularly to children, can be avoided by taking simple precautions such as:

- ALWAYS ensure the television set is not overhanging the edge of the supporting furniture.
- ALWAYS use cabinets or stands or mounting methods recommended by the manufacturer of the television set.
- ALWAYS use furniture that can safely support the television set.
- ALWAYS educate children about the dangers of climbing on furniture to reach the television set or its controls.
- ALWAYS route cords and cables connected to your television so they cannot be tripped over, pulled or grabbed.
- NEVER place a television set in an unstable location.
- NEVER place the television set on tall furniture (for example, cupboards or bookcases) without anchoring both the furniture and the television set to a suitable support.
- NEVER place the television set on cloth or other materials that may be located between the television set and supporting furniture.
- NEVER place items that might tempt children to climb, such as toys and remote controls, on the top of the television or furniture on which the television is placed.

If the existing television set is going to be retained and relocated, the same considerations as above should be applied.

Risk of batteries!

- Do not ingest the battery. Chemical burn hazard.
- The remote control may contain a coin/button cell battery. If the coin/button cell battery is swallowed, it

can cause severe internal burns in just 2 hours and can lead to death.

- Keep new and used batteries away from children.
- If the battery compartment does not close securely, stop using the product and keep it away from children.
- If you think batteries might have been swallowed or placed inside any part of the body, seek immediate medical attention.
- Risk of fire or explosion if the battery is replaced by an incorrect type.
- Replacement of a battery with an incorrect type that can defeat a safeguard (for example, in the case of some lithium battery types).
- Disposal of a battery into fire or a hot oven, or mechanically crushing or cutting of a battery, that can result in an explosion.
- Leaving a battery in an extremely high temperature surrounding environment that can result in an explosion or the leakage of flammable liquid or gas.
- A battery subjected to extremely low air pressure that may result in an explosion or the leakage of flammable liquid or gas.

Risk of overheating!

- Never install the TV in a confined space. Always leave a space of at least 4 inches or 10 cm around the TV for ventilation. Ensure curtains or other objects never cover the ventilation slots on the TV.

Risk of injury, fire or power cord damage!

- Never place the TV or any objects on the power cord.
- Disconnect the TV from the power outlet and antenna before lightning storms. During lightning storms, never touch any part of the TV, power cord or antenna cable.

Risk of hearing damage!

- Avoid using earphones or headphones at high volumes or for prolonged periods of time.

Low temperatures

- If the TV is transported in temperatures below 5°C or 41°F, unpack the TV and wait until the TV temperature matches room temperature before connecting the TV to the power outlet.

Screen care

- Avoid static images as much as possible. Static images are images that remain onscreen for extended periods. Examples include onscreen menus, black bars and time displays. If you must use static images, reduce the screen contrast and brightness to avoid screen damage.
- Unplug the TV before cleaning.
- Use a soft damp cloth to wipe the TV and frame. Never use substances such as alcohol, chemical products or household cleaners to clean the TV.
- Risk of damage to the screen! Never touch, push, rub or strike the screen with an object.
- Wipe off any water as quickly as possible to avoid deformation and discolouration.



Note

Static images may cause permanent damage to the TV screen.

- Do not display static images on LCD TV screens for longer than 2 hours, as this can cause ghosting onscreen. To prevent ghosting, reduce the brightness and contrast of the screen when displaying static images.
- Watching programmes in 4:3 format for extended periods may leave different marks on the left and right of the screen and the border of the

image. Therefore, avoid using this mode for prolonged periods.

- Displaying static images from video games and computers for extended periods may cause an afterimage and ghosting due to screen burn. Reduce the screen brightness and contrast accordingly when using the TV in this way.

Any afterimages, ghosting or marks displayed on the TV screen due to the causes mentioned above are not covered by the warranty.

Recycling



This product has been manufactured using high-performance materials and components that can be recycled and reused.



When the crossed-out wheeled bin symbol is attached to a product, the product is covered by European Directive 2012/19/EU. Familiarise yourself with your local separate collection system for electrical and electronic products.

Follow local regulations and do not dispose of your old products with normal household waste.

Proper disposal of old products helps to prevent potential harm to the environment and human health.



This product contains batteries covered by European Regulation(EU) 2023/1542.

These batteries cannot be disposed of together with normal household waste. Educate yourself on local regulations covering the separate collection of batteries, as proper battery disposal helps to prevent harm to the environment and human health.

3 Setting Up

3.1 Read the Safety Instructions

Read the safety instructions first before you use the TV.

3.2 TV Stand and Wall Mounting

TV Stand



You can find the instructions for mounting the TV stand in the Quick Start Guide that came with the TV. In case you lost this guide, you can download it from www.philips.com/TVsupport. Use the model number of the TV to look for the Quick Start Guide to download.

Wall Mounting

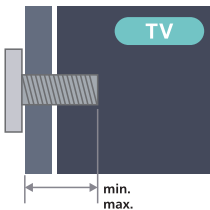
Your TV is also prepared for a VESA-compliant wall mount bracket (sold separately). Wall mount dimensions may vary with different case types; see the Quick Start Guide included in the product packaging to see which sizes will fit your TV. Please use the following dimensions when purchasing a wall mount.



- 32" 100x100mm
- 43" 200x200mm
- 32" Upper: M4 (L:7mm~8mm)
- 32" Lower: M4 (L:7mm~8mm)
- 43" Upper: M6 (L:7mm~8mm)
- 43" Lower: M6 (L:7mm~8mm)

-  M : Machine screw
-  ST : Flat tail self-tapping screw

Caution

Wall mounting the TV requires special skills and should only be performed by qualified personnel. The TV wall mounting should meet safety standards according to the TV's weight. Also read the safety precautions before positioning the TV.

The wall-mounting hole pattern of this TV may differ from standard VESA configurations. Please verify that your chosen wall mount is compatible with the specific mounting pattern of this TV before installation.

TP Vision Europe B.V. bears no responsibility for improper mounting or any mounting that results in accident or injury.

The distance between the wall mounting holes does not comply with the VESA standard.

This television is sold without a wall mount. Please purchase a compatible mount separately for installation.

4.3 Power Cable

- Make sure the power cable is securely inserted in the connector.
- Make sure that the power plug, in the wall socket, is accessible at all times.
- When you unplug the power cable, always pull the plug, never pull the cable.

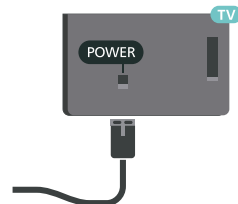

Although this TV has a very low standby power consumption, unplug the power cable to save energy if you do not use the TV for a long period of time.

4 Your TV

Congratulations on your purchase and welcome to Philips! To fully benefit from the support offered by Philips, please register your TV at www.philips.com/TVsupport.

Control panel

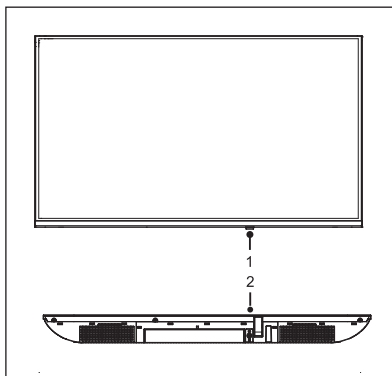

1. Indicator/remote signal receiving window.

2. ⏻ key:

Entering power on or standby with the ⏻ key:

- When insert the power code plug into the electrical socket, you can press ⏻ key to turn on the TV.
- In the power-on state, press key to turn off the TV.

After the TV is turned on:

- In the non-OSD menu, keep pressing ⏻ key to display the function menu.
- In the function menu, keep pressing ⏻ key to select the next item, and press ⏻ key to confirm.

Remote control

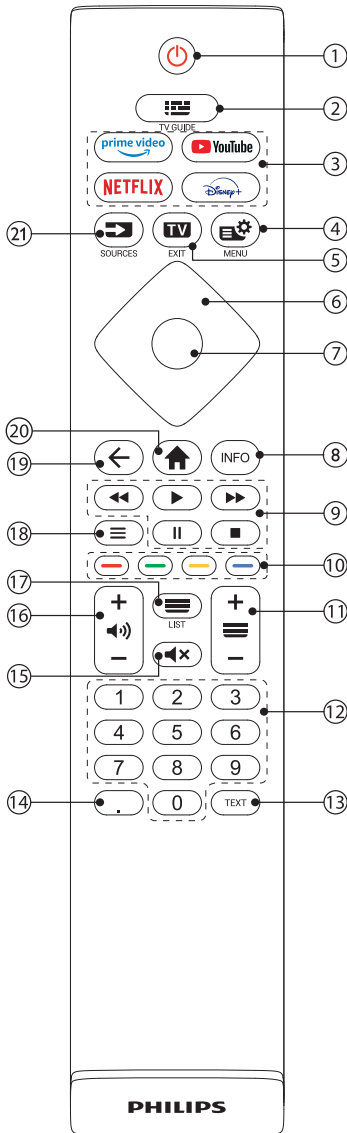

- ① **⏻ (Standby/On)**
Switch the TV on or to standby.
- ② **📺 TV GUIDE**
Access or exit the program guide.
 - Availability of electronic program guide(EPG) is dependent on broadcasters or operators.
- ③ **Access the application.**
Available apps may differ depending on the geographical area or contents provider.
- ④ **⚙️ MENU**
Display the Setting menu.
- ⑤ **TV EXIT**
Exit the menu or return to TV mode.
- ⑥ **▲ ▼ ◀ ▶ (Navigation buttons)**
 - Navigate through menus and select items.
 - In TV mode, press ▲/▼ to change channel.
- ⑦ **OK**
 - Confirm an entry or selection.
 - In TV mode, press this key to show channel list.
- ⑧ **INFO**
Display information about current activity when available.
- ⑨ **◀▶▶▶ || ■ (PlayBack buttons)**
Control movie, music or photo.
- ⑩ **Color buttons**
 - Select tasks or options.
- ⑪ **+ ≡ - (Channel +/-)**
Changes channels.
- ⑫ **0-9 (Numeric buttons 0-9)**
Select channel.
- ⑬ **TEXT**
Show graphic function in DTV mode.
- ⑭ **.**
To enter digital sub-channels.

- ⑮ **⏸ (Mute)**
Mute or restore audio.
- ⑯ **+ 🔊 - (Volume +/-)**
Adjust volume.
- ⑰ **☰ LIST**
Access or exit from the TV channel list.
- ⑱ **☰ (Options)**
In non-smart mode, display the options menu.
- ⑲ **← (Back)**
Return to the previous menu or exit from a certain function , and switch to the previous channel.
- ⑳ **🏠 (Home)**
Access the home page.
- ㉑ **➡ SOURCES**
Select connected devices .

Remote control usage

When you use the remote control, hold it close to the TV and point it at the remote control sensor. Make sure that the line-of-sight between the remote control and TV is not blocked by furniture, walls or other objects.

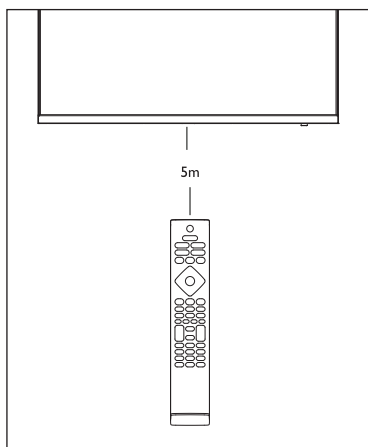

5 Use your TV

This section helps you to perform basic TV operations.

Switch the TV on or off

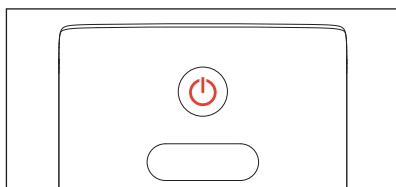
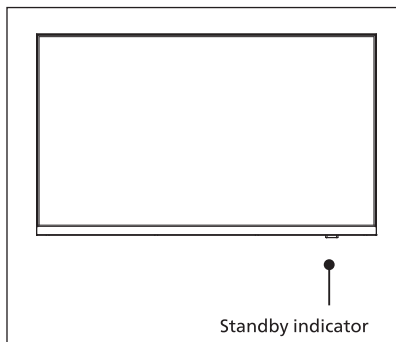

To switch on

- Plug in the power plug.
 - ↳ If the standby indicator lights up, press **⏻** (Standby-On) on the remote control.

To switch to standby

- Press **⏻** (Standby-On) on the remote control.
 - ↳ The standby indicator switches to light up.

Tip

- Though your TV consumes very little power when in standby mode, energy continues to be consumed. When not in use for an extended period of time, disconnect the TV power cable from the power outlet.

Switch channels

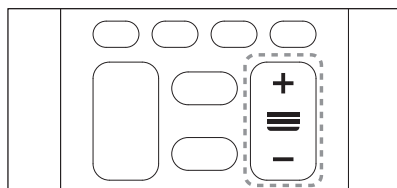

- Press Channel control **+/-** on the remote control.
- Enter a channel number using the numeric buttons on the remote control.
- Press **←** on the remote control to switch and return to the previous channel.

View installed channel

All available channels can be viewed in the channel list.

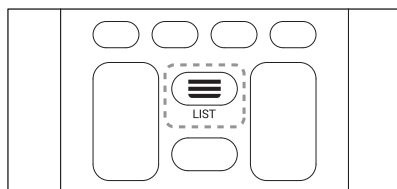

- 1 Press **≡** LIST.
 - ↳ The channel list appears.
- 2 Press **▲** / **▼** to select channels and to browse the channel list.
- 3 Press OK to watch the selected channel.
- 4 Press **←** to switch and return to the last watched channel.

Watch connected devices

Note

- Switch on the device before selecting it as an external signal source.

Use the Sources button

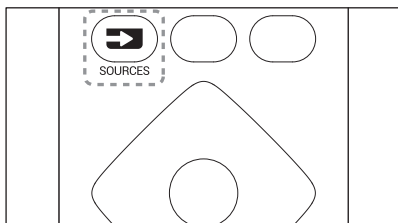

- 1 Press **SOURCES**,
↳ The source list appears.
- 2 Select a source.
 - Press **▼** and press **◀/▶** to select a device except TV.
 - Press **▶** and select **Watch TV**, then Press **▼**. Press **◀/▶** to select TV source: Antenna, Cable.
- 3 Press **OK** to confirm.
↳ The TV switches to the selected device.

Smart TV

Press **▲** to show the home page.

1. Press **◀/▶** key to select an application;
2. Press **OK** to run the application;
3. Press **←** to return to the previous menu.

Note

- Before accessing the Internet, please connect your TV set to the Internet.

Adjust the TV volume

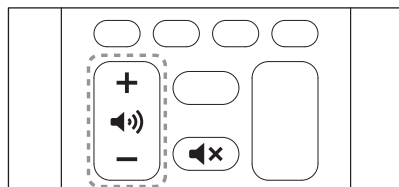

To increase or decrease volume

- Press Volume control **+** / **-** on the remote control.

To mute or unmute sound

- Press **◀X** (Mute).
- Press **◀X** again to restore the sound.

Switch the menu language

Press **MENU** to display the **Setting** menu. Select **More > Device Preferences > Language**, then press **OK**. Press **▲/▼** to select the items.

6 Settings

Note

- Some functions are available only under a specific source.
- Because the product is constantly updated, the software is upgraded at any time, if the software operation is different from the actual operation, please refer to the actual product.

Access to the setting menu

Press **MENU** to display **Setting** menu. Select **More**, and press **OK** to display the settings menu, then press **▲/▼** to select one of the following options:

- **Picture**: Apply the predefined picture setting option.
- **Sound**: Apply the predefined sound setting option.
- **Network**: Set wired and wireless network connections.
- **Bluetooth**: Pair the device.
- **More**: Show more settings
 - **Channel Installation**: Set TV function items.
 - **Child Code**: This function helps parents set channels available for children of different age groups.
 - **Device Preferences**: Set device preferences items.
 - **App setting**: View app setting items.
 - **Universal Access**: Set universal access function items.
 - **Software Update**: Update TV software.

Picture

Press **MENU** to display **Setting** menu. Select **Picture**, and press **OK** to confirm. Press **▶**, and press **▲/▼** to select the items. Then, operate as needed.

- Personalized Picture Settings
- Picture Mode
- Eye Protection Mode
- Aspect Ratio
- Noise Reduction
- DLC

Sound

Press **MENU** to display **Setting** menu. Select **Sound**, and press **OK** to confirm. Press **▶**, and press **▲/▼** to select the items. Then, operate as needed.

- Balance
- Sound Mode
- Surround
- Audio Output Devices
- Select formats
- SPDIF Delay

Network

Press **MENU** to display **Setting** menu. Select **Network**, and press **OK** to display the **Wireless and network** menu. Press **▶**, and press **▲/▼** to select the items. Then, operate as needed.

- Wired or Wi-Fi
- Bluetooth
- HDMI CEC

Note

- The Bluetooth function on certain TV models may cause interference with wireless network connectivity, potentially affecting internet speed. Navigate to **Bluetooth > Bluetooth On/Off** and disable the function, then perform a network speed test.

Note

- A long distance between the TV and the wireless router, or excessive obstructions (e.g., walls, furniture) in between, may weaken the Wi-Fi signal. For optimal performance: Position the TV closer to the router to minimize signal interference and reduce physical obstructions to enhance signal strength.

Pair the device

Press **MENU** to display **Setting** menu. Select **Network**, and press **OK** to display the **Wireless and network** menu, then press **▶**.

1. Select **Bluetooth On/Off**, then press **OK** to turn on the bluetooth.
2. Select **Search for Bluetooth device**, then follow the prompt to connect.

Channel Installation

Before searching, please make sure that the antenna has been connected properly, and select the TV signal source.

Press **MENU** to display the **Setting** menu. Select **More > Channel Installation > Antenna Installation/ Cable Installation**, and press **OK** to enter. Then, operate as needed.

Tip

- During searching, press **←** to return to the previous menu.

Child Code

Press **MENU** to display the **Setting** menu. Select **More > Child Code**. Press **▶** and enter code 1234.

- **Lock System:** Press **OK** to turn on/off **Lock System**.
- **Change Code:** Set a new code for your TV.
- **Parental Lock:** Adjust the program blocking level. This function helps parents block unsuitable channels according to the age of their child. (It is available when the system lock is on)
- **Clear Code:** Clear personal setting.

Device Preferences

Press **MENU** to display the **Setting** menu. Select **More > Device Preferences**, then press **▶**. Press **▲/▼** to select the items, then operate as needed.

- Language:
- Date & Time
- Program Audio & Subtitles
- Teletext
- Keyboard
- Screen saver
- Sleep timer
- About
- Factory settings
- Reset TV
- Restart TV
- Whale OS Cast
- Energy Saver
- Location
- Menu Timer
- Power Desktop

App setting

Press **MENU** to display the **Setting** menu. Select **More > App setting**, then press **▶**. Press **▲/▼** to select the items, then operate as needed.

- Recently opened apps
- View all apps
- App permissions

Universal Access

Press **MENU** to display the **Setting** menu. Select **More > Universal Access**, then press **►**. Press **▲/▼** to select the items, then operate as needed.

- Universal Access
- Hearing impaired
- Audio Description

Software Update

Press **MENU** to display the **Setting** menu. Select **More > Software Update**, then press **►**. Press **▲/▼** to select the items.

- System update
- Current Software

7 Use more functions

EPG

EPG is the electronic program guide provided on digital channels. With EPG, you can

- View the list of currently - broadcast digital programs.
- Watch the current transmitted program.
- Set up a program reminder.

Press **TV GUIDE** to display the TV program guide list. (This feature is available in DTV mode.).

PVR (Option)

In DTV mode, press **SOURCE**, and select **Watch TV > PVR** to display the recording option menu. Set the recording date and time, then select **Apply** and press **OK**. The TV system starts recording. Press **■**, and select **Done**, then press **OK** to save and exit the recording process.

Press **SOURCE**, and select **Watch TV > Recordings**, then press **OK** to show the list of recordings. Select the file you want to play, and press **OK** to start playing it.

While playing, you can press **←** to exit the playback, or press **►(play)/II/◀◀/▶▶/■** to perform shortcut operations.



Note

- This function is available only when the USB device is connected, and the USB in FAT32 format must be used.

Timeshift (Option)

In DTV mode, press **SOURCE**, and select **Watch TV > Timeshift**, then press **OK** to turn on the Timeshift function. Press **►(play)** key to resume playing the program.

When user pauses program for a short time, time-shift function can suspend and cache the playing program to U disk. When user resumes playing, the program can continue to be played.

In the process of the Timeshift, press **►(paly)/◀◀/▶▶/II** to perform shortcut operation. Press **■**, and select **Yes**, then press **OK** to exit time-shift.

USB media function

Please insert a USB device into the USB interface of the TV. Press **▲**, select **Files**,

and press **OK** to enter USB menu.

Select local disk device in the file directory and press **OK** to enter. Select the target folder and press **OK** to enter the folder. Select the target file and press **OK** to play it. Press **←** to return to the previous menu.

While playing, press **OK** can display or hide toolbar. Select the menu option which you want, and press **OK** to perform the operation. You can press to exit the playback, or press **▶** (play)/**II**/**◀◀/▶▶/■** on the remote control to perform shortcut operations.

Note

- NTFS (read-only), FAT and FAT32 USB storage devices are supported.
- Do not remove the USB device while playing, or else the system or device may have problem; Before replace the USB device, please turn off the machine's power supply.

8 Product information

Product information is subject to change without notice. For detailed product information, please visit www.philips.com/TVsupport.

Display resolutions

HDMI Video Formats

- Resolution - refresh rate:
 - 480i - 60Hz
 - 480p - 60Hz
 - 576i - 50Hz
 - 576p - 50Hz
 - 720p - 50Hz, 60Hz
 - 1080i - 50Hz, 60Hz
 - 1080p - 50Hz, 60Hz.

Multimedia

- Supported storage devices: USB (NTFS (read-only), FAT and FAT32 USB storage devices are supported).
- Compatible multimedia file formats:
 - Image: JPEG, PNG, BMP
 - Audio: MPEG1/2 Layer1, MPEG1/2 Layer2, MPEG1/2 Layer3, AC3, EAC3(DDP), VORBIS, FLAC, AAC
 - Video: MPEG 1, MPEG 2, MPEG 4, HEVC/H.265, VP8, VP9, AV1

Audio output power

- 32": 6Wx2
- 43": 6Wx2

Intrinsic resolution

- 32": 1366x768
- 43": 1920X1080

Tuner/reception/transmission

- Aerial input: 75 ohm coaxial
- Supported systems:
 - ATV: NTSC, M
 - DTV: ISDB-T

Remote control

- Batteries: 2 x AAA

Power supply

- Mains power: 100-240V~, 50/60Hz
- Standby power: ≤ 0.5 W
- Ambient temperature: 5 to 35 degrees Celsius
- Power consumption:
- 32": 40W
- 43": 72W

Supported TV mounts

To mount the TV, please purchase a Philips TV mount or any TV mount compliant with the VESA standard. To prevent damage to cables and connectors, be sure to leave a clearance gap of at least 2.2 inches or 5.5cm between the back of the TV to the wall.

Caution

- Please follow all instructions provided with the TV mount. TP Vision Europe B.V. bears no responsibility for improper TV mounting that results in accident, injury or damage.

9 Connect Devices

9.1 About Connections

Connectivity Guide

Always connect a device to the TV with the highest quality connection available. Also, use good quality cables to ensure a good transfer of picture and sound. When you connect a device, the TV recognizes its type and gives each device a correct type name. You can change the type name if you wish. If a correct type name for a device is set, the TV automatically switches to the ideal TV settings when you switch to this device in the Sources menu.

HDMI Ports

HDMI Quality

An HDMI connection has the best picture and sound quality. One HDMI cable combines video and audio signals. Use an HDMI cable for High Definition (HD) TV signals.

To transmit the best signal quality, please use high ultra-speed certified HDMI cables, and the HDMI cable length should not exceed 5 meters.

Anti-copy protection

HDCP (High-bandwidth Digital Content Protection) is a copy protection signal that prevents copying content from a DVD disc or Blu-ray Disc. Also referred to as DRM (Digital Rights Management).

HDMI ARC

Only HDMI 2 supports HDMI ARC (Audio Return Channel) on the TV.

If the device, typically a HomeTheatre System (HTS), soundbar or AV receiver, also has the HDMI ARC connection, connect it to HDMI 2 on this TV. With the HDMI ARC connection, you do not need to connect the extra audio cable that sends the sound of the TV picture to the HTS. The HDMI ARC connection combines both signals.

You can use any HDMI connection on this TV to connect the HTS but ARC is only available for 1 device/connection at a time.

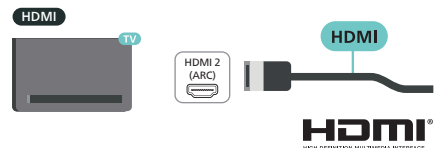

9.2 Home Theatre System-HTS

Connect using HDMI ARC

Connect your home theater (HTS) to your TV using an HDMI cable. You can use the built-in CD player connected to a Philips Soundbar or HTS.

Audio and video synchronization
(synchronization)

If the sound doesn't match the video on the screen, you can use a disc player to set a delay on most home theaters to synchronize the sound with the video.

9.3 Digital Audio Out-Optical/SPDIF

Audio Device

Audio Out -Optical is a high quality sound connection. This optical connection can carry 5.1 audio channels. If your device, typically a Home Theatre System (HTS), has no HDMI ARC connection, you can use this connection with the Audio In-Optical connection on the HTS, The Audio Out-Optical connection sends the sound from the TV to the HTS.

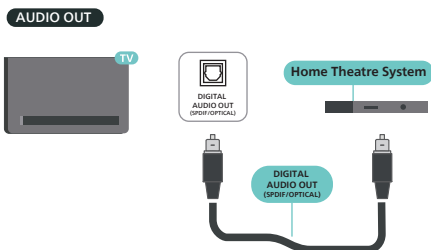

Headphones

You can connect a set of headphones to the connector on the back of the TV. This connection device is a mini-jack 3,5 mm jack. You can additionally adjust the headphone volume.

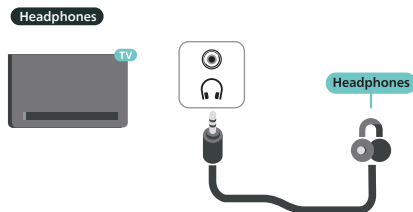

9.4 Game Console

HDMI

For best quality, use a high-speed HDMI cable to connect your game console to your TV.

32"

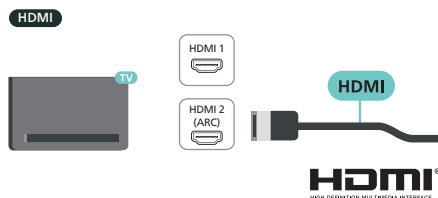

43"

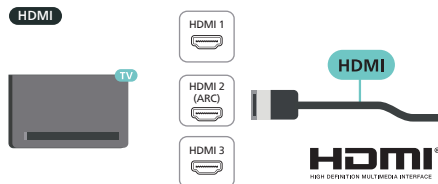

9.5 Video Camera

For best quality, use an HDMI cable to connect the camera to your TV.

32"

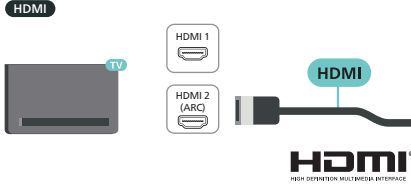

43"

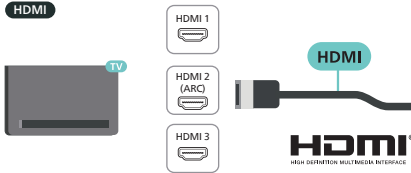

9.6 AV IN

It is used for audio and video transmission between the set-top box and the TV. The connection method is to use a dedicated AV cable.

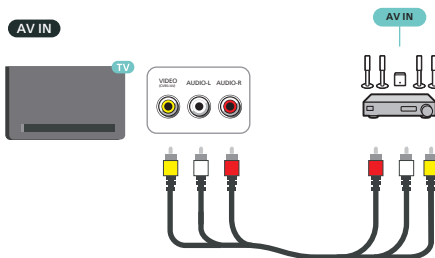

- Ⓜ Yellow (video signal cable)
- Ⓜ White (Audio left channel signal connection cable)
- Ⓜ Red (Audio right channel signal connection cable)

9.7 USB Flash Drive

You can view photos or play your music and videos from a connected USB flash drive.

Insert a USB flash drive in one of the USB connections on the TV while the TV is switched on.

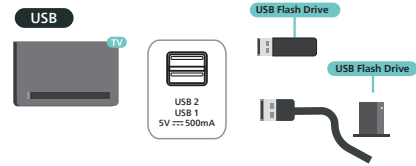

To view the files from the USB flash drive, press Home and click on the MMP(Multi Media Player) app icon to start the app.

To stop watching the USB flash drive content, press EXIT or select another activity. Exit the MMP app before you disconnect the flash drive.

9.8 Connecting TV

TV ANTENNA (RF)

Insert the antenna plug firmly into the Antenna socket at the back of the TV.

You can connect your own antenna or an antenna signal from an antenna distribution system. Use an F Coax 75 Ohm RF antenna connector. Use this antenna connection for ISDB-T input signals.

TV ANTENNA (RF)

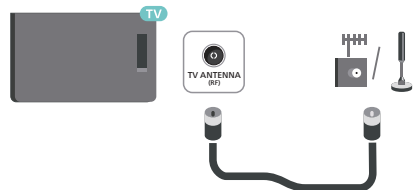

9.9 Computer

You can use a super-fast certified HDMI cable to connect your computer to the TV and use the TV as a computer TV.

* Notes for users of Nvidia graphics cards:
If you connect your computer to the TV via HDMI, the Nvidia graphics card may automatically change the variable refresh rate (VRR) video output to the TV. Before changing the TV's HDMI Ultra HD to Best or Standard, be sure to turn off the VRR function of the display card. Selecting Best or Standard on the TV UI will turn off the TV's VRR support.

*Notes for AMD graphics card users:
If you are connecting your computer to your TV via HDMI, be sure to use the following graphics card settings for proper performance.

-If the video card output is 4096x2160p or 3840x2160p, and uses RGB pixel format, the computer display card should be set to RGB 4:4:4 pixel format at Studio (limited RGB).

-If the display card output video is 2560x1440p 120Hz and uses RGB pixel format, the computer display card should be set to RGB 4:4:4 pixel format at PC standard (full RGB).

10 Connect your TV

10.1 Network and Internet

Home Network

To enjoy the full capabilities of your Philips TV, your TV must be connected to the internet. Connect the TV to a home network with a high-speed Internet connection. You can connect your TV wirelessly or wired to your network router.

Connect to Network

Wireless Connection

What you Need

To connect the TV to the Internet wirelessly, you need a Wi-Fi router with a connection to the Internet.

Use a high-speed (broadband) connection to the Internet.

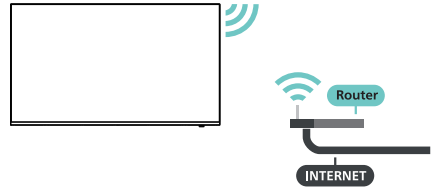

Turn Wi-Fi On or off

⚙ Settings > Network & Internet > Wi-Fi > On/Off.

Make the Connection

⚙ Settings > Network & Internet > Wi-Fi > On/Off.

1 -In the list of found networks,select on your wireless network. If your network is not in the list because the network name is hidden (you switched off the SSID broadcast of therouter),select Add new network to enter the network name yourself.

2 -Depending on the type of router,enter your encryption key -WPA2 or WPA3. If you have entered the encryption key for this network before, you can select OK to connect immediately.

3-A message will be shown when the connection is successful.

Problems

Wireless network not found or distorted

- Microwave ovens, DECT phones or other Wi-Fi 802.11b/g/n/ac devices in your proximity might disturb the wireless network.
- Make sure that the firewalls in your network allow access to the TV's wireless connection.
- If the wireless network does not work properly in your home, try the wired network installation.

Internet does not work

- If the connection to the router is OK, check the router connection to the internet.

The PC and internet connection are slow.

- Look in your wireless router's user manual for information on indoor range, transfer rate and other factors of signal quality.
- Use a high-speed (broadband) internet connection for your router.

DHCP

- If the connection fails, you can check the DHCP (Dynamic Host Configuration Protocol) setting of the router. DHCP should be switched on.

Wired Connection

What You Need

To connect the TV to the internet, you need a network router with a connection to the Internet. Use a high-speed(broadband) connection to the Internet.

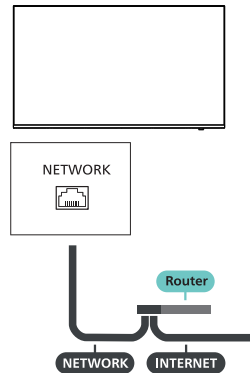

Network and internet settings

View network settings

⚙ Settings > Network & Internet > IP settings > Static.

Here you can view all current network settings, IP address gateway, network prefix length, DNS 1, DNS 2, etc.

Power on with Wi-Fi(WOVLAN)

Wake on LAN power

⚙ Settings > Network & Internet > Wake configs > WoW/WoL.

If the TV enters standby mode, you can use your smartphone or tablet to power on the TV. However, you must first turn on the Power on Wi-Fi or wired (WoW/WoL) setting.

10 Troubleshooting

This section covers common problems and their accompanying solutions.

General issues

The TV cannot be switched on:

- Disconnect the power cable from the power outlet. Wait for one minute before reconnecting it.
- Check that the power cable is securely connected.

The remote control is not working properly:

- Check that the remote control batteries are correctly inserted according to the +/- orientation.
- Replace the remote control batteries if they are flat or weak.
- Clean the remote control and TV sensor lens.

The TV menu is in the wrong language.

- Change the TV menu to your preferred language.

When turning the TV On/Off or to Standby, you hear a creaking sound from the TV chassis:

- No action is required. The creaking sound comes from the normal expansion and contraction of the TV as it cools down and warms up. This does not impact its performance.

Channel issues

Previously installed channels do not appear in the channel list:

- Check that the correct channel list is selected.

Picture issues

The TV is on, but there is no picture:

- Check that the antenna is properly connected to the TV.
- Check that the correct device is selected as the TV source.

There is sound but no picture:

- Check that the picture settings are correctly set.

Poor TV reception from the antenna connection:

- Check that the antenna is properly connected to the TV.
- Loudspeakers, unearthed audio devices, neon lights, high buildings and other large objects can influence reception quality. If possible, try to improve the reception quality by changing the antenna direction or moving devices away from the TV.
- If the reception on one particular channel is poor, please fine tune this channel.

There is poor picture quality from connected devices:

- Check that the devices are connected properly.
- Check that the picture settings are correctly set.

The picture does not fit the screen; it is too big or too small:

- Try using a different picture format.

The picture position is incorrect:

- Picture signals from some devices may not fit the screen correctly. Please check the signal output of the device.

Sound issues

The pictures are showing but sound quality is poor:

Note

- If no audio signal is detected, the TV automatically switches the audio output off - this does not indicate malfunction.

- Check that all cables are properly connected.
- Check that the volume is not set to 0.
- Check that the sound is not muted.
- Check that the sound settings are correctly set.

The pictures are showing but sound comes from one speaker only:

- Verify that sound balance is set to the centre.

HDMI connection issues

There are problems with HDMI devices:

- Please note that HDCP (High-bandwidth Digital Content Protection) support can delay the time taken for a TV to display content from a HDMI device.
- If the TV does not recognise the HDMI device and no picture is displayed, please try switching the signal source to another device before switching it back again.
- If there are intermittent sound disruptions, please check that output settings from the HDMI device are correct.
- If you are using a HDMI to DVI adapter or cable, please check if the audio cable that comes with the product is connected to AUDIO (only for mini jacks).

Network connection issues

Failure to connect to the Internet:

- If the TV is correctly connected to the router, please check the connection between the router and the Internet.

Network speed is slow:

- Please refer to the instruction manual of your router to learn about the factors that may affect transfer rate and signal quality.
- You may need to upgrade your broadband speed.

Contact us

If you cannot resolve your problem, please refer to the FAQs for this model at

www.philips.com/TVsupport.

If the problem remains unresolved, please contact your local Philips Customer Service Centre.



Warning

- Do not attempt to repair the TV yourself. This may cause severe injury, irreparable damage to your TV or void your warranty.



Note

- Please make a note of your TV model and serial number before you contact Philips Customer Service Centre. These numbers are printed on the back/bottom of the TV and on the packaging.

12 Warranty

English
Warranty

Indonesia
Jaminan

简体中文
保修

Malay
Waranti

Deutsch
Garantie

ไทย
การรับประกัน

繁體中文
保固

Français
Garantie

Tiếng Việt
Bảo hành

العربية
الضمان

English - Warranty

Dear Customer,
Thank you for purchasing this Philips product. For the Philips warranty applicable to this product, we refer you to the Philips website www.philips.com/guarantee. In the event you do not have an internet connection, please contact your local Philips Consumer Care Centre. Contact details are given in the Consumer Care Centres list hereafter.

Deutsch - Garantie

Sehr geehrter Kunde, wir beglückwünschen Sie zu Ihrer Entscheidung für dieses Produkt von Philips. Nähere Informationen zu der für dieses Produkt geltenden Philips Garantie finden Sie im Internet unter www.philips.com/guarantee. Die durch Philips gewährte Garantie beeinträchtigt in keiner Weise Ihre gesetzlichen Rechte. Sofern Sie keinen Zugang zum Internet haben, wenden Sie sich bitte an Ihr Philips Info-Center vor Ort. Die entsprechenden Kontaktdaten entnehmen Sie bitte der nachstehenden Liste.

Français - Garantie

Cher client,
Merci d'avoir acheté ce produit Philips. Pour connaître les conditions de garantie Philips applicables à ce produit, reportez-vous à la page www.philips.com/guarantee. Si vous ne possédez pas de connexion Internet, contactez votre Service Consommateurs Philips local. Vous trouverez les coordonnées de tous les Services Consommateurs dans la liste ci-après. Ces informations étaient correctes à la date d'impression. Pour des informations à jour, consultez la page www.philips.com/support.

Indonesia - Jaminan

Pelanggan yang terhormat,
Terima kasih telah membeli produk Philips. Untuk mendapatkan jaminan produk ini, kunjungi situs Web Philips di www.philips.com/guarantee. Jika Anda tidak memiliki sambungan Internet, hubungi Pusat Layanan Pelanggan Philips setempat. Rincian kontak tercantum dalam daftar Pusat Layanan Pelanggan.

ไทย - การรับประกัน

เรียนลูกค้า
ขอขอบคุณที่เลือกซื้อผลิตภัณฑ์ของ Philips สำหรับการรับประกันที่มีผลบังคับใช้กับผลิตภัณฑ์นี้ โปรดอ้างอิงเว็บไซต์ของ Philips www.philips.com/guarantee ในกรณีที่คุณไม่มีอินเทอร์เน็ต โปรดติดต่อศูนย์บริการลูกค้า Philips ประจำท้องถิ่นของคุณ รายละเอียดการติดต่อจะแสดงอยู่ในรายชื่อศูนย์บริการลูกค้าต่อไป

Tiếng Việt - Bảo hành

Kính gửi Quý khách hàng,
Cảm ơn quý vị đã mua sản phẩm Philips này. Để biết bảo hành của Philips có thể áp dụng cho sản phẩm này, chúng tôi xin giới thiệu trang web của Philips www.philips.com/guarantee. Trong trường hợp quý vị không có kết nối internet, vui lòng liên hệ với Trung tâm Chăm sóc Khách hàng của Philips tại địa phương. Chi tiết liên hệ được cung cấp trong danh sách Trung tâm Chăm sóc Khách hàng sau đây.

简体中文 - 保修

尊敬的客户：
感谢您购买此 Philips 产品。有关适用于此产品的 Philips 保修信息，建议您访问 Philips 网站：www.philips.com/guarantee。如果您无法访问 Internet，请联系您当地的 Philips 客户服务中心。将来，我们会在客户服务中心列表中提供详细联系信息。

繁體中文 - 保固

親愛的客戶，您好：
多謝您購買本飛利浦產品。有關適用於本產品的飛利浦保固詳情，請瀏覽飛利浦網站：www.philips.com/guarantee。如您未能連線至互聯網，請與您當地的飛利浦消費者保固中心聯絡。聯絡詳情已詳列於之後的消費者保固中心清單中。

العربية الضمان

عزيزي العميل،
شكرا لكم على شراء هذا المنتج من Philips. لمعرفة شروط ضمان Philips الذي ينطبق على هذا المنتج، راجع موقع www.philips.com/guarantee. في حال لم يكن لديك اتصالاً بالإنترنت، يرجى الاتصال برقم مركز خدمة العملاء المحلي لشركة Philips. يمكن معرفة تفاصيل الاتصال من قائمة مراكز خدمة العملاء فيما يلي.

Malay - Waranti

Pelanggan yang dihormati,
Terima kasih kerana membeli produk Philips. Bagi waranti Philips yang terpakai untuk produk ini, kami merujuk anda kepada laman web Philips www.philips.com/guarantee. Sekiranya anda tidak mempunyai sambungan Internet, sila hubungi Pusat Layanan Pelanggan Philips tempatan anda. Butiran kenalan diberikan dalam senarai Pusat Layanan Pelanggan selepas ini.



User Manual



FAQ



Chat



Forum



Call



Email



Warranty

www.philips.com/support

Australia
1300 998 851

Indonesia
0800-1-822822

Philippines/Pilipinas
632 84204970

Malaysia
1800 220 180

Singapore/ 新加坡
65 6286 7333

Thailand/ ประเทศไทย
0-2746-5431



All registered and unregistered trademarks are property of their respective owners.

Specifications are subject to change without notice.

Philips and the Philips' shield emblem are trademarks of Koninklijke Philips N.V. and are used under license from Koninklijke Philips N.V.

This product has been manufactured by and is sold under the responsibility of TP Vision Europe B.V., and TP Vision Europe B.V. is the warrantor in relation to this product.

2026 © TP Vision Europe B.V. All rights reserved.

www.philips.com/welcome