

PHILIPS

User manual **Split Air Conditioner**

Model:

FAC09CB-CB5KBA4H

FAC12CB-CB5KBA2H

FAC18CD-CB5KBA1H

FAC24CD-CB5KBA1H

Thank you for choosing our product.

For proper operation, please read and keep this manual carefully.

Warnings

Read the manual carefully before using the product.



The unit is loaded with flammable R32 gas.



Read the user manual before using the unit.



Read the installation manual before proceeding with the installation of the unit.



Read the service manual before servicing the unit.

Warnings on the refrigerant

In order to air-condition the room, the unit, and therefore the entire system, uses a special refrigerant inside. The refrigerant used is R32 fluoride.

R32 refrigerant is flammable and odorless. In addition, it can cause explosions in particular conditions. L 'flammable refrigerant, however, is very low. In order to start the flame, a free flame is required.

R32 refrigerant is a less polluting refrigerant than other gases used in refrigeration circuits and causes much less damage to the ozone layer. The influence on the greenhouse effect is also much lower. The R32 refrigerant has excellent thermodynamic characteristics which allow a really high energy efficiency.

For the same cooling capacity, the system therefore needs a lower charge.

Generic warnings

Do not use tools or products to speed up the defrosting process or to clean other than those recommended by the manufacturer.

If repair is necessary, contact the assistance service.

Repair work must be carried out by qualified personnel.

The appliance must be ripos to a local without trigger sources in operation continuously (For example: open flames, an apparatus gas funzionant the or a working electric heater.)

Do not pierce or expose the units to heat.

The unit must be installed, used and stored in a room with a larger surface area than that indicated in the chapter dedicated to the place of installation.

The unit is loaded with flammable R32 gas. For repairs, strictly follow the instructions issued by the manufacturer.

The product should be installed, used and stored in rooms more than 4m².

When using, always bear in mind that the refrigerant is odorless.

Read the manual or the dedicated section of the manual.



Content

1. Precautions.....	1
2. Parts name.....	11
3. Remote controller.....	12
4. Clean and maintenance.....	17
5. Malfunction analysis.....	19
6. Installation drawing.....	22
7. Installation prepare.....	23
8. Installation of indoor unit.....	25
9. Installation of outdoor unit.....	29
10. Check after installation.....	33
11. Test operation.....	33
12. Configuration of connection pipe.....	34
13. Pipe expanding method.....	35
14. Philips Coolhome App User Guide.....	36



This marking indicates that this product should not be disposed with other household wastes throughout the EU. To prevent possible harm to the environment or human health from uncontrolled waste disposal, recycle it responsibly to promote the sustainable reuse of material resources. To return your used device, please use the return and collection systems or contact the retailer where the product was purchased. They can take this product for environmental safe recycling.

Precautions



WARNING

Operation and Maintenance

- This appliance can be used by children aged of 8 years and above and persons with reduced physical, sensory or mental capabilities or lack of experience and knowledge if they have been given supervision or instruction concerning use of the appliance in a safe way and understand the hazards involved.
- Children shall not play with the appliance.
- Cleaning and user maintenance shall not be made by children without supervision.
- Do not connect air conditioner to multi-purpose socket. Otherwise, it may cause fire hazard.
- Do disconnect power supply when cleaning air conditioner. Otherwise, it may cause electric shock.
- If the supply cord is damaged, it must be replaced by the manufacturer, its service agent or similarly qualified persons in order to avoid a hazard.
- Do not wash the air conditioner with water to avoid electric shock.
- Do not spray water on indoor unit. It may cause electric shock or malfunction.
- After removing the filter, do not touch fins to avoid injury.
- Do not use fire or hair dryer to dry the filter to avoid deformation or fire hazard.
- Maintenance must be performed by qualified professionals. Otherwise, it may cause personal injury or damage.
- Do not repair air conditioner by yourself. It may cause electric shock or damage. Please contact dealer when you need to repair air conditioner.
- Do not extend fingers or objects into air inlet or air outlet. It may cause personal injury or damage.
- Do not block air outlet or air inlet. It may cause malfunction.
- Do not spill water on the remote controller, otherwise the remote controller may be broken.
- When below phenomenon occurs, please turn off air conditioner and disconnect power immediately, and then contact the dealer or qualified professionals for service.
 - Power cord is overheating or damaged.
 - There's abnormal sound during operation.
 - Circuit break trips off frequently.
 - Air conditioner gives off burning smell.
 - Indoor unit is leaking.
- If the air conditioner operates under abnormal conditions, it may cause malfunction, electric shock or fire hazard.
- When turning on or turning off the unit by emergency operation switch, please press this switch with an insulating object other than metal.
- Do not step on top panel of outdoor unit, or put heavy objects. It may cause damage or personal injury.

Attachment

- Installation must be performed by qualified professionals. Otherwise, it may cause personal injury or damage.
- Must follow the electric safety regulations when installing the unit.
- According to the local safety regulations, use qualified power supply circuit and circuit break.
- Do install the circuit break. If not, it may cause malfunction.
- An all-pole disconnection switch having a contact separation of at least 3mm in all poles should be connected in fixed wiring.
- Air Conditioner should be properly grounded. Incorrect grounding may cause electric shock.
- Including an circuit break with suitable capacity, please note the following table. Air switch should be included magnet buckle and heating buckle function, it can protect the circuit-short and overload.
- Don't use unqualified power cord.
- Make sure the power supply matches with the requirement of air conditioner. Unstable power supply or incorrect wiring or malfunction. Please install proper power supply cables before using the air conditioner.
- Properly connect the live wire, neutral wire and grounding wire of power socket.
- Be sure to cut off the power supply before proceeding any work related to electricity and safety.
- Do not put through the power before finishing installation.
- If the supply cord is damaged, it must be replaced by the manufacturer, its service agent or similarly qualified persons in order to avoid a hazard.
- The temperature of refrigerant circuit will be high, please keep the interconnection cable away from the copper tube.
- The appliance shall be installed in accordance with national wiring regulations.
- Installation must be performed in accordance with the requirement of NEC and CEC by authorized personnel only.
- The air conditioner is the first class electric appliance. It must be properly grounding with specialized grounding device by a professional. Please make sure it is always grounded effectively, otherwise it may cause electric shock.
- The yellow-green wire in air conditioner is grounding wire, which can't be used for other purposes.
- The grounding resistance should comply with national electric safety regulations.
- The appliance must be positioned so that the plug is accessible.
- All wires of indoor unit and outdoor unit should be connected by a professional.
- If the length of power connection wire is insufficient, please contact the supplier for a new one. Avoid extending the wire by yourself.
- For the air conditioner with plug, the plug should be reachable after finishing installation.
- For the air conditioner without plug, an circuit break must be installed in the line.
- If you need to relocate the air conditioner to another place, only the qualified person can perform the work. Otherwise, it may cause personal injury or damage.

- Select a location which is out of reach for children and far away from animals or plants. If it is unavoidable, please add the fence for safety purpose.
- The indoor unit should be installed close to the wall.

This product complies with the standard EN 61000-3-11. Before connecting the product to the public grid, please consult your local electricity supplier to ensure that the grid complies with the above requirements.

Annex CC (informative)

Transportation, marking and storage for units that employ flammable refrigerants

- The following information is provided for units that employ flammable refrigerants.

CC.1 Transport of equipment containing flammable refrigerants

Attention is drawn to the fact that additional transportation regulations may exist with respect to equipment containing flammable gas. The maximum number of pieces of equipment or the configuration of the equipment, permitted to be transported together will be determined by the applicable transport regulations.

CC.2 Marking of equipment using signs

Signs for similar appliances used in a work area generally are addressed by local regulations and give the minimum requirements for the provision of safety and/or health signs for a work location.

All required signs are to be maintained and employers should ensure that employees receive suitable and sufficient instruction and training on the meaning of appropriate safety signs and the actions that need to be taken in connection with these signs. The effectiveness of signs should not be diminished by too many signs being placed together.

Any pictograms used should be as simple as possible and contain only essential details.

CC.3 Disposal of equipment using flammable refrigerants

See national regulations.

CC.4 Storage of equipment/appliances

The storage of equipment should be in accordance with the manufacturer's instructions.

CC.5 Storage of packed (unsold) equipment

Storage package protection should be constructed such that mechanical damage to the equipment inside the package will not cause a leak of the refrigerant charge.

The maximum number of pieces of equipment permitted to be stored together will be determined by local regulations.

WARNING

1. Installation (Space)

- That the installation of pipe-work shall be kept to a minimum.
- That pipe-work shall be protected from physical damage.
- Where refrigerant pipes shall be compliance with national gas regulations.
- That mechanical connections shall be accessible for maintenance purposes.
- In cases that require mechanical ventilation, ventilation openings shall be kept clear of obstruction.
- When disposing of the product is used, be based on national regulations, properly processed.

2. Servicing

- Any person who is involved with working on or breaking into a refrigerant circuit should hold a current valid certificate from an industry-accredited assessment authority, which authorises their competence to handle refrigerants safely in accordance with an industry recognised assessment specification.

3. Maintenance and repair requiring the assistance of other skilled personnel shall be carried out under the supervision of the person competent in the use of flammable refrigerants.

4. Be more careful that foreign matter(oil, water,etc) does not enter the piping. Also, when storing the piping, securely seal the opening by pinching, taping, etc.

5. All working procedure that affects safety means shall only be carried by competent persons.

6. Appliance shall be stored in a well -ventilated area where the room size corresponds to the room area as specified for operation.

7. The appliance shall be stored so as to prevent mechanical damage from occurring.

8. For ducted products,the ducts connected to an appliance shall not contain a potential ignition source;

9. When connected via an air duct system to one or more rooms, the supply and return air shall be directly ducted to the space. Open areas such as false ceilings shall not be used as a return air duct;

10. Avoid excessive vibration or pulsation to refrigerating piping.

11. Joints shall be tested with detection equipment with a capability of 5 g/year of refrigerant or better, with the equipment in standstill and under operation or under a pressure of at least these standstill or operation conditions after installation. Detachable joints shall NOT be used in the indoor side of the unit (brazed, welded joint could be used).

12. When a FLAMMABLE REFRIGERANT is used, the requirements for installation space of appliance and /or ventilation requirements are determined according to

- the mass charge amount(M) used in the appliance,
- the installation location,
- the type of ventilation of the location or of the appliance.

13. servicing shall be performed only as recommended by the manufacturer.

14. When a FLAMMABLE REFRIGERANT is used, see the following requirements for installation.

- that protection devices, piping, and fittings shall be protected as far as possible against adverse environmental effects, for example, the danger of water collecting and freezing in relief pipes or the accumulation of dirt and debris;
- that precautions shall be taken to avoid excessive vibration or pulsation to refrigerating piping;
- that piping in refrigeration systems shall be so designed and installed to minimize the likelihood of hydraulic shock damaging the system;
- that provision shall be made for expansion and contraction of long runs of piping;
- that solenoid valves shall be correctly positioned in the piping to avoid hydraulic shock and shall not block in liquid refrigerant unless adequate relief is provided;
- Steel pipes and components shall be protected against corrosion with a rustproof coating before applying any insulation
- field-made refrigerant joints indoors shall be tightness tested. The test method shall have a sensitivity of 5 grams per year of refrigerant or better under a pressure of at least 0,25 times the maximum allowable pressure. No leak shall be detected;
- Electrical components that can arc or spark, which are not considered ignition sources due to compliance with 22.116.1 points b), c), d), or f) shall only be replaced with parts specified by the appliance manufacturer. Replacement with other parts may result in the ignition of refrigerant in the event of a leak;

15. Unventilated areas

- For appliances containing flammable refrigerants is installed in an unventilated area, please make sure that it will not stagnate so as to create a fire or explosion hazard for any refrigerant leak.

16. Qualification of workers

Any maintenance, service and repair operations must be required qualification of the working personnel. Every working procedure that affects safety means shall only be carried out by competent persons that joined the training and achieved competence should be documented by a certificate. The training of these procedures is carried out by national training organisations or manufacturers that are accredited to teach the relevant national competency standards that may be set in legislation. All training shall follow the ANNEX HH requirements of IEC 60335-2-40:2022 Edition.

Examples for such working procedures are:

- breaking into the refrigerating circuit;
- opening of sealed components;
- opening of ventilated enclosures.

Information on servicing

1. Checks to the area

Prior to beginning work on systems containing flammable refrigerants, safety checks are necessary to ensure that the risk of ignition is minimised. For repair to the refrigerating system, the following precautions shall be complied with prior to conducting work on the system.

2. Work procedure

Works shall be undertaken under a controlled procedure so as to minimise the risk of a flammable gas or vapour being present while the work is being performed.

3. General work area

All maintenance staff and others working in the local area shall be instructed on the nature of work being carried out. Work in confined spaces shall be avoided.

4. Checking for presence of refrigerant

The area shall be checked with an appropriate refrigerant detector prior to and during work, to ensure the technician is aware of potentially flammable atmospheres. Ensure that the leak detection equipment being used is suitable for use with flammable refrigerants, i.e. no sparking, adequately sealed or intrinsically safe.

5. Presence of fire extinguisher

If any hot work is to be conducted on the refrigeration equipment or any associated parts, appropriate fire extinguishing equipment shall be available to hand. Have a dry powder or CO₂ fire extinguisher adjacent to the charging area.

6. No ignition sources

No person carrying out work in relation to a REFRIGERATING SYSTEM which involves exposing any pipe work shall use any sources of ignition in such a manner that it may lead to the risk of fire or explosion. All possible ignition sources, including cigarette smoking, should be kept sufficiently far away from the site of installation, repairing, removing and disposal, during which refrigerant can possibly be released to the surrounding space. Prior to work taking place, the area around the equipment is to be surveyed to make sure that there are no flammable hazards or ignition risks. "No Smoking" signs shall be displayed.

7. Ventilated area

Ensure that the area is in the open or that it is adequately ventilated before breaking into the system or conducting any hot work. A degree of ventilation shall continue during the period that the work is carried out. The ventilation should safely disperse any released refrigerant and preferably expel it externally into the atmosphere.

8. Checks to the refrigerating equipment

Where electrical components are being changed, they shall be fit for the purpose and to the correct specification. At all times the manufacturer's maintenance and service guidelines shall be followed. If in doubt consult the manufacturer's technical department for assistance. The following checks shall be applied to installations using FLAMMABLE REFRIGERANTS:

- the refrigerant charge is in accordance with the room size within which the refrigerant containing parts are installed;
- the ventilation machinery and outlets are operating adequately and are not

obstructed;

-- if an indirect refrigerating circuit is being used, the secondary circuits shall be checked for the presence of refrigerant;

-- marking to the equipment continues to be visible and legible, marking and signs that are illegible shall be corrected;

-- refrigerating pipe or components are installed in a position where they are unlikely to be exposed to any substance which may corrode refrigerant containing components, unless the components are constructed of materials which are inherently resistant to being corroded or are suitably protected against being so corroded.

9. Checks to electrical devices

Repair and maintenance to electrical components shall include initial safety checks and component inspection procedures. If a fault exists that could compromise safety, then no electrical supply shall be connected to the circuit until it is satisfactorily dealt with. If the fault cannot be corrected immediately but it is necessary to continue operation, and adequate temporary solution shall be used.

This shall be reported to the owner of the equipment so all parties are advised.

Initial safety checks shall include:

-- that capacitors are discharged: this shall be done in a safe manner to avoid possibility of sparking

-- that there no live electrical components and wiring are exposed while charging, recovering or purging the system;

-- that there is continuity of earth bonding.

10. Sealed electrical components

Sealed electrical components shall not be repaired.

11. Cabling

Check that cabling will not be subject to wear, corrosion, excessive pressure, vibration, sharp edges or any other adverse environmental effects. The check shall also take into account the effects of aging or continual vibration from sources such as compressors or fans.

12. Detection of flammable refrigerants

Under no circumstances shall potential sources of ignition be used in the searching for or detection of refrigerant leaks. A halide torch (or any other detector using a naked flame) shall not be used.

The following leak detection methods are deemed acceptable for refrigerant systems. Electronic leak detectors may be used to detect refrigerant leaks but, in the case of FLAMMABLE REFRIGERANTS, the sensitivity may not be adequate, or may need re-calibration. (Detection equipment shall be calibrated in a refrigerant-free area.) Ensure that the detector is not a potential source of ignition and is suitable for the refrigerant used. Leak detection equipment shall be set at a percentage of the LFL of the refrigerant and shall be calibrated to the refrigerant employed, and the appropriate percentage of gas (25 % maximum) is confirmed.

Leak detection fluids are also suitable for use with most refrigerants but the use of detergents containing chlorine shall be avoided as the chlorine may react with the refrigerant and corrode the copper pipe-work.

NOTE Examples of leak detection fluids are

- bubble method,
- fluorescent method agents. If a leak is suspected, all naked flames shall be removed/ extinguished. If a leakage of refrigerant is found which requires brazing, all of the refrigerant shall be recovered from the system, or isolated (by means of shut off valves) in a part of the system remote from the leak. See the following instructions of removal of refrigerant.

13. Refrigerant removal and circuit evacuation

When breaking into the refrigerant circuit to make repairs - or for any other purpose conventional procedures shall be used. However, for flammable refrigerants it is important that best practice be followed, since flammability is a consideration. The following procedure shall be adhered to:

- safely remove refrigerant following local and national regulations;
- evacuate;
- purge the circuit with inert gas (optional for A2L);
- evacuate (optional for A2L);
- continuously flush or purge with inert gas when using flame to open circuit; and open the circuit.

The refrigerant charge shall be recovered into the correct recovery cylinders. The manufacturer shall specify the inert gases that can be used. Compressed air or oxygen shall not be used for purging refrigerant systems. NOTE An example of an inert gas is dry nitrogen. Purging of the refrigerant circuit shall be achieved by breaking the vacuum in the system with inert gas and continuing to fill until the working pressure is achieved, then venting to atmosphere, and finally pulling down to a vacuum. This process shall be repeated until no refrigerant is within the system. The system shall be vented down to atmospheric pressure to enable work to take place. Ensure that the outlet of the vacuum pump is not close to any potential ignition sources and that ventilation is available.

14. Charging procedures

In addition to conventional charging procedures, the following requirements shall be followed:

- Ensure that contamination of different refrigerants does not occur when using charging equipment. Hoses or lines shall be as short as possible to minimise the amount of refrigerant contained in them.
- Cylinders shall be kept in an appropriate position according to the instructions.
- Ensure that the refrigerating system is earthed prior to charging the system with refrigerant.
- Label the system when charging is complete (if not already labelled).
- Extreme care shall be taken not to overfill the refrigerating system.

Prior to recharging the system, it shall be pressure-tested with the appropriate purging gas. The system shall be leak-tested on completion of charging but prior to commissioning. A follow up leak test shall be carried out prior to leaving the site.

15. Decommissioning

Before carrying out this procedure, it is essential that the technician is completely familiar with the equipment and all its detail. It is recommended good practice that

all refrigerants are recovered safely. Prior to the task being carried out, an oil and refrigerant sample shall be taken in case analysis is required prior to re-use of recovered refrigerant. It is essential that electrical power is available before the task is commenced.

a) Become familiar with the equipment and its operation.

b) Isolate system electrically.

c) Before attempting the procedure ensure that:

--mechanical handling equipment is available, if required, for handling refrigerant cylinders;

--all personal protective equipment is available and being used correctly;

--the recovery process is supervised at all times by a competent person;

--recovery equipment and cylinders conform to the appropriate standards.

d) Pump down refrigerant system, if possible.

e) If a vacuum is not possible, make a manifold so that refrigerant can be removed from various parts of the system.

f) Make sure that cylinder is situated on the scales before recovery takes place.

g) Start the recovery machine and operate in accordance with instructions.

h) Do not overfill cylinders (no more than 80 % volume liquid charge)

i) Do not exceed the maximum working pressure of the cylinder, even temporarily.

j) When the cylinders have been filled correctly and the process completed, make sure that the cylinders and the equipment are removed from site promptly and all isolation valves on the equipment are closed off.

k) Recovered refrigerant shall not be charged into another refrigerating system unless it has been cleaned and checked.

16. Labelling

Equipment shall be labelled stating that it has been de-commissioned and emptied of refrigerant. The label shall be dated and signed. For appliances containing flammable refrigerants, ensure that there are labels on the equipment stating the equipment contains flammable refrigerant.

17. Recovery

When removing refrigerant from a system, either for servicing or decommissioning, it is required to follow good practice so that all refrigerants are removed safely.

When transferring refrigerant into cylinders, ensure that only appropriate refrigerant recovery cylinders are employed. Ensure that the correct number of cylinders for holding the total system charge is available. All cylinders to be used are designated for the recovered refrigerant and labelled for that refrigerant (i.e. special cylinders for the recovery of refrigerant). Cylinders shall be complete with pressure-relief valve and associated shut-off valves in good working order. Empty recovery cylinders are evacuated and, if possible, cooled before recovery occurs.

The recovery equipment shall be in good working order with a set of instructions concerning the equipment that is at hand and shall be suitable for the recovery of the flammable refrigerant. Consult manufacturer if in doubt. In addition, a set of calibrated weighing scales shall be available and in good working order. Hoses shall be complete with leak-free disconnect couplings and in good condition.

The recovered refrigerant shall be processed according to local legislation in the correct recovery cylinder, and the relevant waste transfer note arranged. Do not mix refrigerants in recovery units and especially not in cylinders.

If compressors or compressor oils are to be removed, ensure that they have been evacuated to an acceptable level to make certain that flammable refrigerant does not remain within the lubricant. The compressor body shall not be heated by an open flame or other ignition sources to accelerate this process. Draining of oil from a system shall be carried out safely.

18. Transportation, marking and storage for units

1. Transport of equipment containing flammable refrigerants

Compliance with the transport regulations

2. Marking of equipment using signs

Compliance with local regulations

3. Disposal of equipment using flammable refrigerants

Compliance with national regulations

4. Storage of equipment/appliances

The storage of equipment should be in accordance with the manufacturer's instructions.

5. Storage of packed (unsold) equipment

Storage package protection should be constructed such that mechanical damage to the equipment inside the package will not cause a leak of the refrigerant charge.

The maximum number of pieces of equipment permitted to be stored together will be determined by local regulations.

Working temperature range

	Indoor side DB/WB(°C)	Outdoor side DB/WB(°C)
Maximum cooling	32/23	43/26

The operating temperature range (outdoor temperature) for cooling only unit is 18°C~ 52°C.

Parts name

Indoor unit

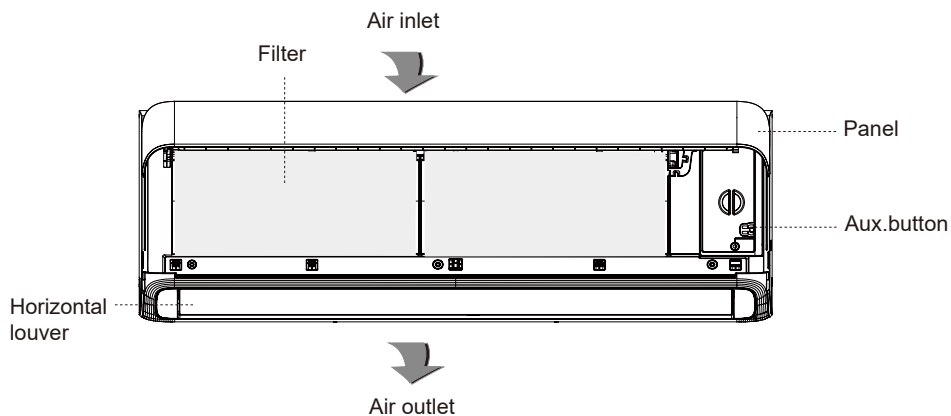

Remote controller



Outdoor unit

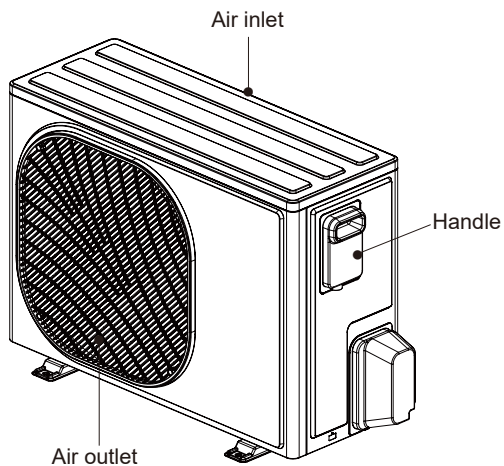

Actual product may be different from above graphics, please refer to actual products.

Remote controller

Note: The remote control is universal for Philips air conditioner. The function of actual product shall prevail.

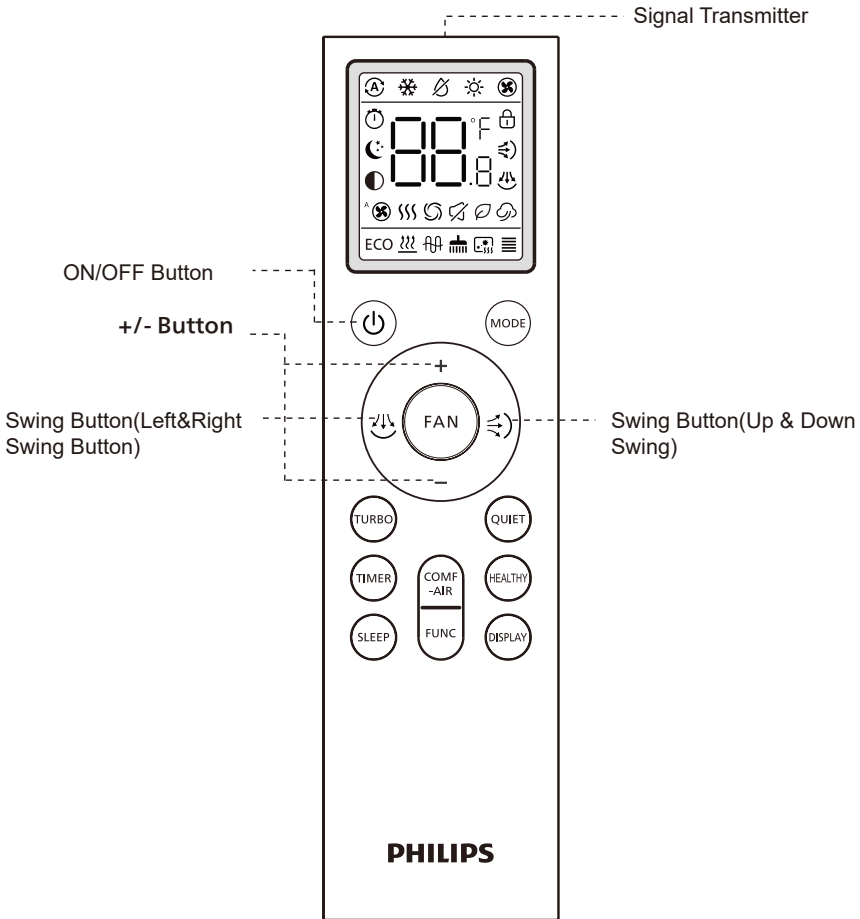

ON/OFF Button

Press the button to turn on/off air conditioner.

+/- Button

Press the button to adjust the temperature.

Every press will make temperature increase/decrease 0.5°C / 1°F . Temperature setting range: 16°C ~ 31°C / 61 ~ 88°F).

After pressing functional button, different functions can be selected.

Swing Button(Left&Right Swing Button)

Used to start/stop left & right swing.

Turbo Button

Press the button to turn on turbo function in cooling, heating or fan mode.

Comfortable Wind

In cooling, dry and heating mode, Comfortable wind can be selected.

Timer Button

Used to set the exact time to turn on/off air conditioner.

The available setting range is 0.5~24h. Press the timer button on the remote and set the tuning on/off time, and adjust the time through +/-button. Press the button again to activate it.

Sleep Mode

Used to turn on/off sleep mode.

Signal Transmitter

Used to transmit signals to air conditioner.

Mode Button

Press the button to select different mode. The mode will switch according to below sequence for every press:

Cooling→Dry→Heating→Fan→Auto→Cooling

Swing Button(Up & Down Swing)

Press the button to turn on/off up & down swing.

Fan Button

Press the button to change the wind speed in cooling or heating mode.

Note: Turbo & Silent wind is not available in auto mode; Auto wind is not available in fan mode; Wind speed cannot be adjusted in dry mode; Wind speed.

Silent Wind Button

In cooling, heating or fan mode, press the button to enter silent mode directly.

Display Button

Press the button to turn on/off the display of indoor unit.

Comfortable Wind Button

In cooling, dry & heating mode, press the button to turn on/off comfortable wind.

In cooling & dry mode, after turn on comfortable wind button, up & down swing will stop;

In heating mode, when turning on comfortable wind, up & down swing will stop.

Sleep Button

In cooling, heating or dry mode, press the button to turn on/off sleep mode. In sleep mode, low wind speed is defaulted, and wind speed can be adjusted.

Holiday mode

In heating mode, pressing Comfort Wind & "+" will activate the Holiday Mode. When switching modes, adjusting temperature, or turning off, the holiday mode will be cancelled.

Celsius/Fahrenheit switching

When turns on, "Sleep + Screen Display" press and hold for 3s to switch between degrees Celsius and Fahrenheit.

Function button

Press the function button to select energy saving, asisted heating, drying, cleaning, and high-temperature sterilization function adjustment in order (energy saving can only be selected in cooling mode, cleaning and high-temperature sterilization can only be selected in shutdown state, drying can only be selected in cooling or dehumidifying mode in power-on state, asisted heating can be selected only in heating mode, and health can be selected in any mode); When the function button is pressed, all the functions that can be selected are displayed, the function is selected by adjusting the up and down buttons, the selected function will be flashed, then determined by the function button.

Energy-saving function

In cooling mode, press the function button, the LCD screen will appear " energy-saving, dry" icon, then press the up and down adjustment buttons to select the energy-saving function, at this time, the LCD screen "energy-saving" icon flashes, press the "function button" to start the energy-saving function.

In energy saving mode, press the on/off button, "MODE" button, "TURBO", "QUIET", or press the function button again to select the energy saving function to exit the energy saving mode.

When the cooling eco mode is activated, the temperature area is displayed at 27°C, the temperature cannot be increased or decreased.

Asisted heating function

In heating mode, press the function button, the LCD screen will appear " asisted heating" icon, then press the up and down adjustment buttons to select the asisted heating function, at this time, the LCD screen "asisted heating" icon flashes, press the "function button" to turn on the asisted heating function. When switching modes or shutting down, the asisted heating will be automatically turned off, or press the function button to select the asisted heating function again to exit the asisted heating mode. (Asisted heating is off by default)

Drying function

In cooling or dehumidifying mode, press the function button, the LCD screen will appear " energy saving, drying" icon, and then press the up and down adjustment buttons to select the drying function, at this time, the LCD screen "dry" icon flashes, press the "function button" to turn on the drying function.

High temperature sterilization function

In the shutdown state, press the function button, the LCD screen will appear "cleaning, high temperature sterilization" icon, then press the up and down adjustment buttons to select the high temperature sterilization function, at this time, the LCD screen "high temperature sterilization" icon flashes, press the "function button" to turn on the high temperature sterilization function, after the high temperature sterilization function is turned on, press the switch to exit the high temperature sterilization function, or press the function button, select the high temperature sterilization function, press the function button, exit the high temperature sterilization function.

Health function

In power-on or power-off state, press "health" button, "Health" icon will appear on the LCD screen. Power off, power on, press "health" button again to exit "health" mode.

Child lock

Press "+" "-" to activate child lock, and the icon will be displayed on remote control; Press "+" "-" again to cancel.

Note: After activate child lock, the buttons will be lock. Please unlock the remote control to use.

Wind Speed

In cooling or heating mode, continue to press wind speed button, the wind speed will be changed in a cycle of Low→Mid→High→Auto.

In auto mode, Turbo & Silent mode is not available. Continue to press wind speed button, the wind speed will be changed in a cycle of Low→Mid→High→Auto.

In fan mode, continue to press wind speed button, the wind speed will be changed in a cycle of Low→Mid→High.

In dry mode, low wind speed can not be adjusted.

In sleep mode, low wind speed is defaulted and the wind speed can be adjusted.

In turbo mode, press wind speed button to switch to auto wind; In silent mode, press the button to switch low wind speed.

Cleaning function:

When the device is in the off state, press the "function" key, and the icons of "Health", "Cleaning" and "High-temperature Sterilization" will appear on the LCD screen.

Then press the up and down adjustment keys to select the cleaning function.

At this time, the "Cleaning" icon on the LCD screen will blink. Press the "Function" Key to turn on the cleaning function. After the cleaning function is turned on, you can press the power switch to exit the cleaning function, or press the function key, select the cleaning function again, and then press the function key to cancel the function.

When the high-temperature sterilization, health or timing function is turned on under the cleaning function state, the cleaning function will be cancelled.

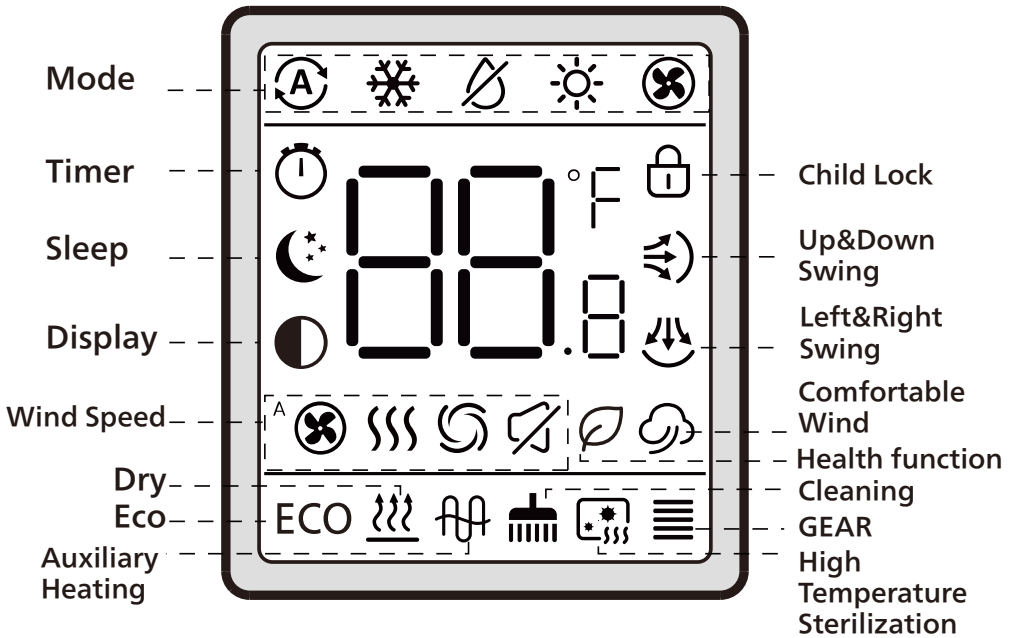

Batteries Load & Replacement

1. Press and slide the battery cover, then remove.
2. Remove used batteries (skip the step when first load)
3. Load two AAA batteries in accordance with the direction marked in the battery cell.
4. Slide on the cover.

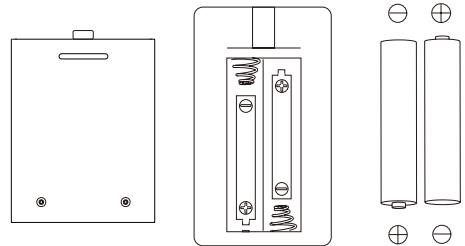

Please ensure the anode cathode are in accordance with battery cell when first loading batteries.

1. When using remote control, ensure that the remote control is aligned with the signal receiving window and there are no obstacles between them; Do not drop or throw the remote control randomly; Do not allow any liquid to flow into the remote control; Do not expose the remote control to sunlight or a heat source.
2. If the remote control does not work, please remove the batteries for 30 seconds then load them. If it still cannot be used, please replace the batteries.
3. When replacing batteries, do not mix old and new batteries, otherwise it may cause the malfunction of remote control.
4. Please remove the battery from the remote control to prevent leaking of batteries from damaging the remote control.
5. Please dispose of waste batteries according to relevant national requirements and do not dispose of them casually.

Clean and maintenance



WARNING

- Turn off the air conditioner and disconnect the power before cleaning the air conditioner to avoid electric shock.
- Do not wash the air conditioner with water to avoid electric shock.
- Do not use volatile liquid to clean the air conditioner.

Clean surface of indoor unit

When the surface of indoor unit is dirty, it is recommended to use a soft dry cloth or wet cloth to wipe it.

Note:

Do not remove the panel when cleaning it.

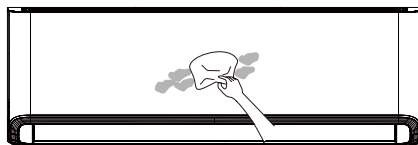

Clean filter

1. Open panel

Pull out the panel to a certain angle as shown in the fig.

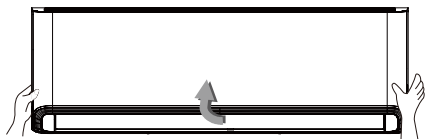

2. Remove filter

Remove the filter as indicated in the fig.

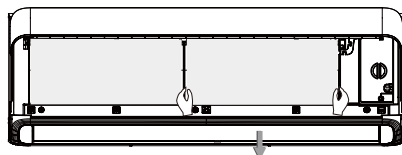

3. Clean filter

Use dust catcher or water to clean the filter. When the filter is very dirty, use the water (below 45°C) to clean it, and then put it in a shady and cool place to dry.

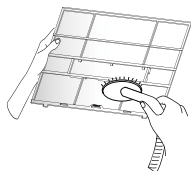

4. Installation filter

Installation the filter and then close the panel cover tightly.

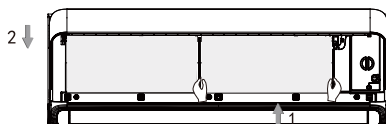

NOTE:

- The filter should be cleaned every three months. If there is much dust in the operation environment, clean frequency can be increased.
- After removing the filter, do not touch fins to avoid injury.
- Do not use fire or hair dryer to dry the filter to avoid deformation or fire hazard.

Checking before use-season

1. Check whether air inlets and air outlets are blocked.
2. Check whether air switch, plug and socket are in good condition.
3. Check whether filter is clean.
4. Check whether drainage pipe is damaged.

Checking after use-season

1. Disconnect power supply.
2. Clean filter and indoor unit's panel.

Notice for recovery

1. Most of packing materials are recyclable materials. Please dispose them in appropriate recycling unit.
2. If you want to dispose the air conditioner, please contact local dealer or consultant service center for the correct disposal method.

Malfunction analysis

General phenomenon analysis

Please check below items before asking for maintenance. If the malfunction still can't be eliminated, please contact local dealer or qualified professionals.

Phenomenon	Check items	Solution
Indoor unit can't receive remote controller's signal or remote controller has no action.	Whether it's interfered severely (such as static electricity, stable voltage)?	Pull out the plug. Reinsert the plug after about 3min, and then turn on the unit again.
	Whether remote controller is within the signal receiving range?	Signal receiving range is 8m.
	Whether there are obstacles?	Remove obstacles.
	Whether remote controller is pointing at the receiving window?	Select proper angle and point the remote controller at the receiving window on indoor unit.
	Is sensitivity of remote controller low; fuzzy display and no display?	Check the batteries. If the power of batteries is too low, please replace them.
	No display when operating remote controller?	Check whether remote controller appears to be damaged. If yes, replace it.
	Fluorescent lamp in room?	Take the remote controller close to indoor unit. Turn off the fluorescent lamp and then try it again.
No air emitted from indoor unit.	Air inlet or air outlet of indoor unit is blocked?	Eliminate obstacles.
	Under heating mode, indoor temperature is reached to set temperature?	After reaching to set temperature, indoor unit will stop blowing out air.
	Heating mode is turned on just now?	In order to prevent blowing out cold air, indoor unit will be started after delaying for several minutes, which is a normal phenomenon.
Air conditioner can't operate	Power failure?	Wait until power recovery.
	Is plug loose?	Reinsert the plug.
	Circuit break trips off or fuse is burnt out?	Ask professional to replace circuit break or fuse.
	Wiring has malfunction?	Ask professional to replace it.
	Unit has restarted immediately after stopping operation?	Wait for 3min, and then turn on the unit again.
	Whether the function setting for remote controller is correct?	Reset the function.

Phenomenon	Check items	Solution
Mist is emitted from indoor unit's air outlet.	Indoor temperature and humidity is high?	Because indoor air is cooled rapidly. After a while, indoor temperature and humidity will be decrease and mist will disappear.
Set temperature can't be adjusted	Unit is operating under auto mode?	Temperature can't be adjusted under auto mode. Please switch the operation mode if you need to adjust temperature.
	Your required temperature exceeds the set temperature range?	Set temperature range: 16°C ~31°C
Cooling (heating) effect is not good.	Voltage is too low?	Wait until the voltage resumes normal.
	Filter is dirty?	Clean the filter.
	Set temperature is in proper range?	Adjust temperature to proper range.
	Door and window are open?	Close door and window.
Odours are emitted	Whether there's odour source, such as furniture and cigarette, etc.	Clean the filter. Eliminate the odoursource.
Air conditioner operates normally suddenly	Whether there's interference, such as thunder, wireless devices, etc.	Disconnect power, put back power, and then turn on the unit again.
Outdoor unit has vapor	Heating mode is turned on?	During defrosting under heating mode, it may generate vapor, which is a normal phenomenon.
"Water flowing" noise	Air conditioner is turned on or turned off just now?	The noise is the sound of refrigerant flowing inside the unit, which is a normal phenomenon.
Cracking noise	Air conditioner is turned on or turned off just now?	This is the sound of friction caused by expansion and/or contraction of panel or other parts due to the change of temperature.

Error Code

When air conditioner status is abnormal, temperature indicator on indoor unit will blink to display corresponding error code. Please refer to below list for identification of error code.

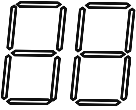

Note:

Above indicator diagram is only for reference. Please refer to actual product for the actual indicator and position.

Below listed error codes are only part error codes. Please refer to error code list in service manual for more information.

Error code	Troubleshooting	Solution
b3	Filter filth blockage alert	Power off, clean filter. If the filter is not dirty, turn off the air conditioner for 2min then restart, the code will be removed automatically.
P6	Overheat protection	Turn off, restart after 5min, if the code occurs again after a few minutes, please contact the professional person.
P2	Over current protection	Turn off, restart after 5min, if the code occurs again after a few minutes, please contact the professional person.
HE	Auxiliary heater drive circuit malfunction	Pull out the plug, please contact the professional person.
L0	Jumper malfunction	Pull out the plug, restart after 3min, if the code occurs again, please contact the professional person.
L1	PG motor(indoor) zero-crossing detecting circuit malfunction	Turn off, restart after a few seconds, if the code occurs again after a few minutes, please contact the professional person.
E5	No feedback signal of indoor unit fan	Turn off, restart after a few seconds, if the code occurs again after a few minutes, please contact the professional person.
E2	Short/open circuit of indoor environment sensor	Pull out the plug, restart after 3min, if the code occurs again, please contact the professional person.
E3	Short/open circuit of indoor unit tube sensor	Pull out the plug, restart after 3min, if the code occurs again, please contact the professional person.
dF	Auto-defrosting	Indoor unit stops running, outdoor unit continues running until the defrosting is completed, then indoor unit starts running

If there're other error codes, please contact qualified professionals for service.

Contact us

When below phenomenon occurs, please turn off air conditioner and disconnect power immediately, and then contact the dealer or qualified professionals for service.

- Power cord is overheating or damaged.
- Air conditioner gives off burning smell.
- There's abnormal sound during operation.
- Circuit break trips off frequently.
- Indoor unit is leaking.

Do not repair or refit the air conditioner by yourself.

If the air conditioner operates under abnormal conditions, it may cause malfunction, electric shock or fire hazard.

Installation drawing

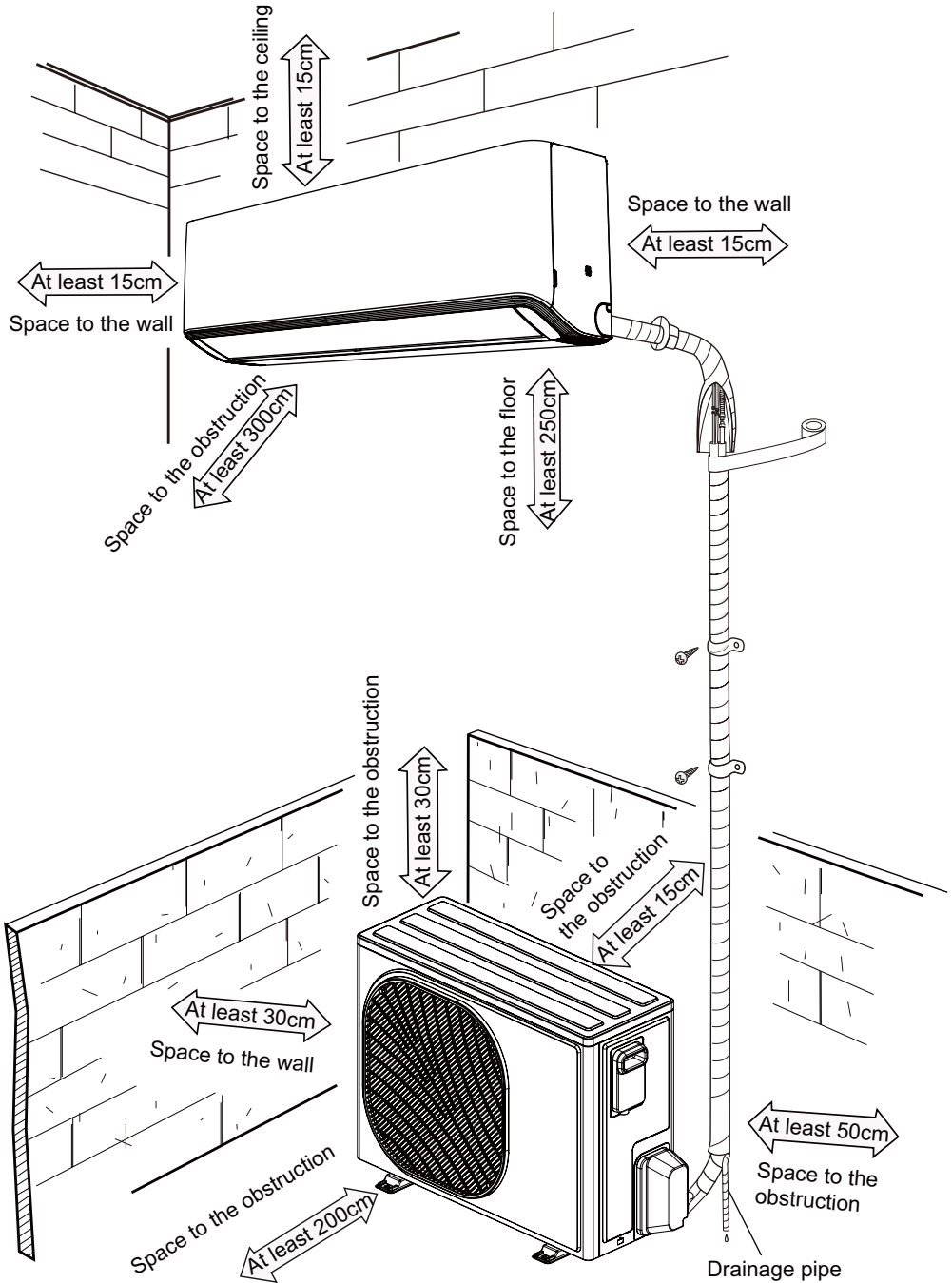

Installation prepare

Tools

1. Level meter	2. Screw driver	3. Impact drill
4. Drill head	5. Pipe expander	6. Torque wrench
7. Open-end wrench	8. Pipe cutter	9. Leakage detector
10. Vacuum pump	11. Pressure meter	12. Universal meter
13. Inner hexagon spanner	14. Measuring tape	

Selection of location

Basic requirement

Installing the unit in the following places may cause malfunction. If it is unavoidable, please consult the local dealer:

1. The place with strong heat sources, vapors, flammable or explosive gas, or volatile objects spread in the air.
2. The place with high-frequency devices (such as welding machine, medical equipment).
3. The place near coast area.
4. The place with oil or fumes in the air.
5. The place with sulfured gas.
6. Other places with special circumstances.
7. The appliance shall not be installed in the laundry.

Indoor unit:

1. There should be no obstruction near air inlet and air outlet.
2. Select a location where the condensation water can be dispersed easily and won't affect other people.
3. Select a location which is convenient to connect the outdoor unit and near the power socket.
4. Select a location which is out of reach for children.
5. The location should be able to withstand the weight of indoor unit and won't increase noise and vibration.
6. The appliance must be installed 2.5m above floor.
7. Don't install the indoor unit right above the electric appliance.
8. Please try your best to keep away from fluorescent lamp.

Outdoor unit:

1. Select a location where the noise and out flow air emitted by the outdoor unit will not affect neighborhood.
2. The location should be well ventilated and dry, in which the outdoor unit won't be exposed directly to sunlight or strong wind.
3. The location should be able to withstand the weight of outdoor unit.
4. Make sure that the installation follows the requirement of installation dimension diagram.
5. Select a location which is out of reach for children and far away from animals or plants. If it is unavoidable, please add the fence for safety purpose.

Safety precaution

1. Must follow the electric safety regulations when installing the unit.
2. According to the local safety regulations, use qualified power supply circuit and circuit break.
3. Make sure the power supply matches with the requirement of air conditioner. Unstable power supply or incorrect wiring or malfunction. Please install proper power supply cables before using the air conditioner.
4. Properly connect the live wire, neutral wire and grounding wire of power socket.
5. Be sure to cut off the power supply before proceeding any work related to electricity and safety.
6. Do not connect the power before finishing installation.
7. If the supply cord is damaged, it must be replaced by the manufacturer, its service agent or similarly qualified persons in order to avoid a hazard.
8. The temperature of refrigerant circuit will be high, please keep the interconnection cable away from the copper tube.
9. The appliance shall be installed in accordance with national wiring regulations.
10. Installation must be performed in accordance with the requirement of NEC and CEC by authorized personnel only.

Grounding requirement

1. The air conditioner is the first class electric appliance. It must be properly grounding with specialized grounding device by a professional. Please make sure it is always grounded effectively, otherwise it may cause electric shock.
2. The yellow-green wire in air conditioner is grounding wire, which can't be used for other purposes.
3. The grounding resistance should comply with national electric safety regulations.
4. The appliance must be positioned so that the plug is accessible.
5. An all-pole disconnection switch having a contact separation of at least 3mm in all poles should be connected in fixed wiring. For models with a power plug, make sure the plug is within reach after installation.
6. Including an circuit break with suitable capacity, please note the following table. Circuit break should be included magnet buckle and heating buckle function, it can protect the circuit-short and overload. (Caution: please do not use the fuse only for protect the circuit)

Air-conditioner	Circuit break capacity	Minimum Sectional Area of Power Cable (mm ²)	Minimum Sectional Area of Power Connecting wire (mm ²)	Power Supply Mode
05K~09K	10A	3G1.0	3G1.0	Indoor
12K	16A	3G1.5	3G1.0	Indoor
18K	16A	3G1.5	3G1.5	Indoor
24K	25A	3G2.5	3G2.5	Indoor
36K	32A	3G2.5	4G2.5	Indoor
36K	32A	3G4.0	3G1.0	Outdoor

Installation of indoor unit

Step 1: Choosing installation location

Recommend the installation location to the client and then confirm it with the client.

Step 2: Install wall-mounting frame

1. Hang the wall-mounting frame on the wall; adjust it in horizontal position with the level meter and then point out the screw fixing holes on the wall.
2. Drill the screw fixing holes on the wall with impact drill (the specification of drill head should be the same as the plastic expansion particle) and then fill the plastic expansion particles in the holes.
3. Fix the wall-mounting frame on the wall with tapping screws (ST4.2X25TA) and then check if the frame is firmly installed by pulling the frame. If the plastic expansion particle is loose, please drill another fixing hole nearby.

Step 3: Open piping hole

1. Choose the position of piping hole according to the direction of outlet pipe. The position of piping hole should be a little lower than the wall-mounted frame, shown as below.

Dimension: 790X275X198

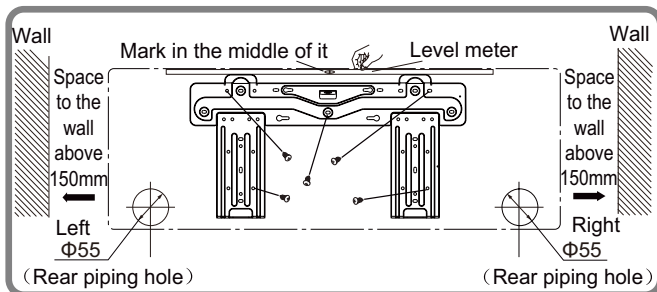

Dimension: 986×312×211

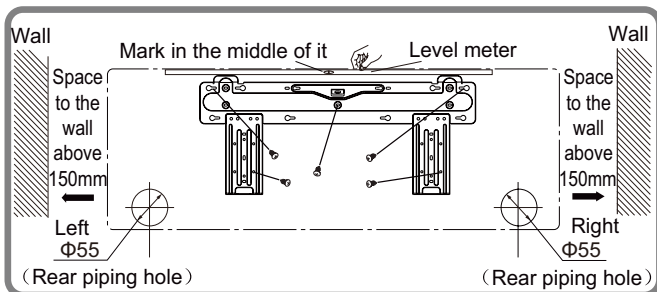

- Open a piping hole with the diameter of $\Phi 55/\Phi 70$ on the selected outlet pipe position. In order to drain smoothly, slant the piping hole on the wall slightly downward to the outdoor side with the gradient of $5\sim 10^\circ$.

NOTE:

- Pay attention to dust prevention and take relevant safety measures when opening the hole.
- The plastic expansion particles are not provided and should be bought locally.

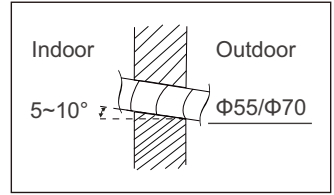

Step 4: Outlet pipe

- The pipe can be led out in the direction of right, rear right or left.
- When select leading out the pipe from left or right, please cut off the corresponding hole on the bottom case.

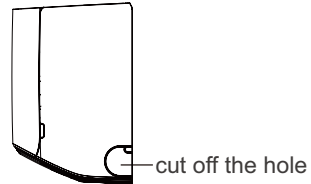
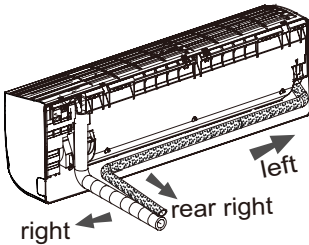

Step 5: Connect the pipe of indoor unit

- Aim the pipe joint at the corresponding bellmouth.
- Pretightening the union nut with hand.
- Adjust the torque force by referring to the following sheet. Place the open-end wrench on the pipe joint and place the torque wrench on the union nut. Tighten the union nut with torque wrench.

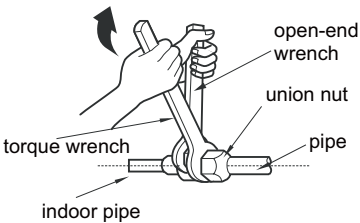
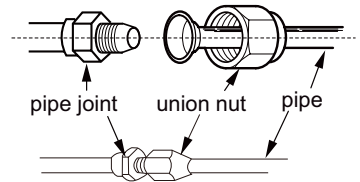

Hex nut diameter	Tightening torque (N.m)
$\Phi 6$	15~20
$\Phi 9.52$	30~40
$\Phi 12$	45~55
$\Phi 16$	60~65
$\Phi 19$	70~75

- Wrap the indoor pipe and joint of connection pipe with insulating pipe, and then wrap it with tape.

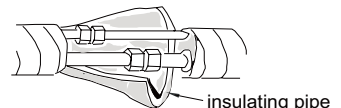

Step 6: Install drain hose

1. Connect the drain hose to the outlet pipe of indoor unit.
2. Bind the joint with tape.

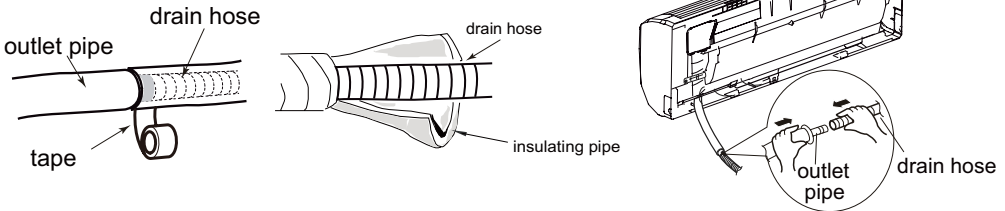

- Add insulating pipe in the indoor drain hose in order to prevent condensation.
- The plastic expansion particles are not provided.

Step 7: Connect wire of indoor unit

1. Open the panel, remove the screw on the wiring cover and then take down the cover.

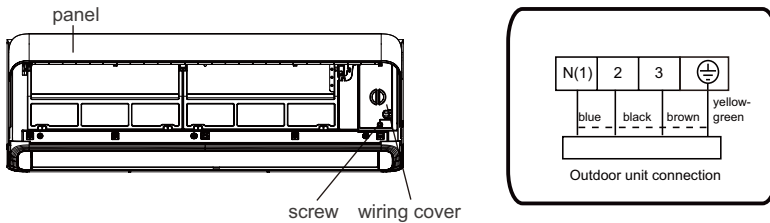

2. Make the power connection wire go through the cable-cross hole at the back of indoor unit and then pull it out from the front side.
3. Remove the wire clip, connect the power connection wire to the wiring terminal according to the color; tighten the screw and then fix the power connection wire with wire clip.
4. Put wiring cover back and then tighten the screw.
5. Close the panel.

NOTE:

- All wires of indoor unit and outdoor unit should be connected by a professional.
- If the length of power connection wire is insufficient, please contact the supplier for a new one. Avoid extending the wire by yourself.
- For the air conditioner with plug, the plug should be reachable after finishing installation.
- For the air conditioner without plug, an air switch must be installed in the line. The air switch should be all-pole parting and the contact parting distance should be more than 3mm.

Step 8: Bind up pipe

1. Bind up the connection pipe, power cord and drain hose with the band.
2. Reserve a certain length of drain hose and power cord for installation when binding them. When binding to a certain degree, separate the indoor power and then separate the drain hose.

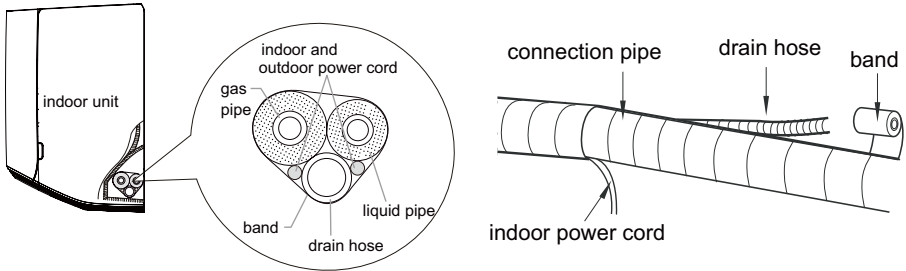

3. Bind them evenly.
4. The liquid pipe and gas pipe should be bound separately at the end.

NOTE:

- The power cord and control wire can't be crossed or winding.
- The drain hose should be bound at the bottom.

Step 9: Hang the indoor unit

1. Put the bound pipes in the wall pipe and then make them pass through the wall hole.
2. Hang the indoor unit on the wall-mounting frame.
3. Stuff the gap between pipes and wall hole with sealing gum.
4. Fix the wall pipe.
5. Check if the indoor unit is installed firmly and closed to the wall.

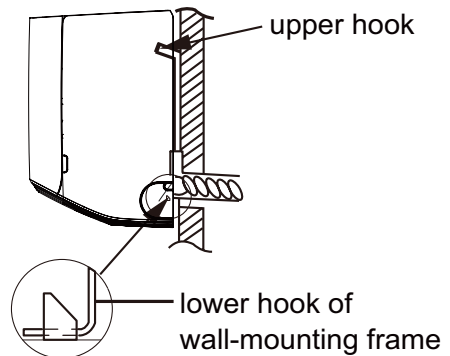
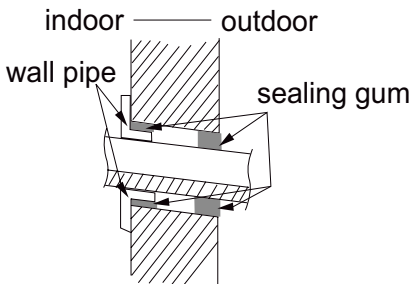

- Do not bend the drain hose too excessively in order to prevent blocking.

Installation of outdoor unit

Step 1: Fix the support of outdoor

Select it according to the actual installation situation

1. Select installation location according to the house structure.
2. Fix the support of outdoor unit on the selected location with expansion screws.

NOTE:

- Take sufficient protective measures when installing the outdoor unit.
- Make sure the support can withstand at least four times of the unit weight.
- The outdoor unit should be installed at least 3cm above the the floor in order to install drainjoint.
- For the unit with cooling capacity of 2300W~5000W, 6 expansion screws are needed; for the unit with cooling capacity of 6000W~8000W, 8 expansion screws are needed; for the unit with cooling capacity of 10000W~16000W, 10 expansion screws are needed.

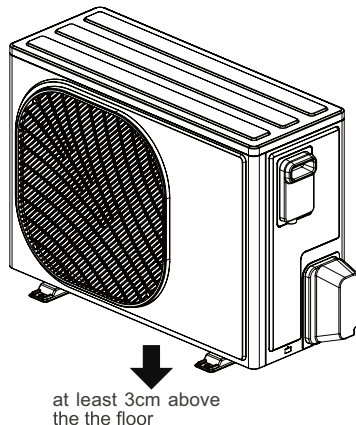

Step 2: Install drain joint (Only for cooling and heating unit)

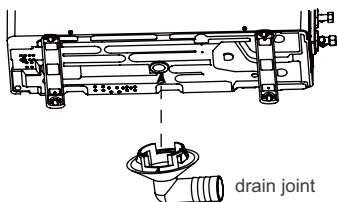

1. Connect the outdoor drain joint into the hole on the chassis, as shown in the picture below.
2. Connect the drain hose into the drain vent.

Step 3: Fix outdoor unit

1. Place the outdoor unit on the support.
2. Fix the foot holes of outdoor unit with bolts.

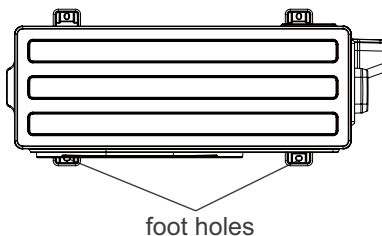

Step 4: Connect indoor and outdoor pipe

1. Loose all screws, then remove the handle & side cover.

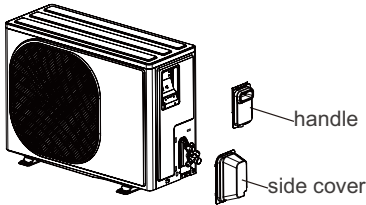

2. Remove the screw cap of valve and aim the pipe joint at the bellmouth of pipe.

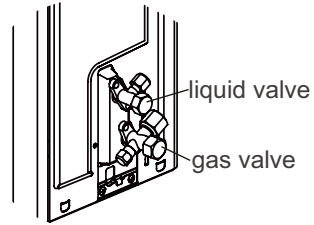

3. Pretightening the union nut with hand.

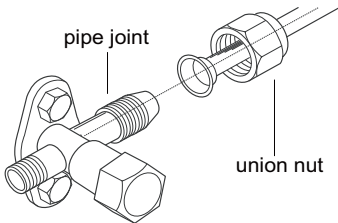

4. Tighten the union nut with torque wrench by referring to the sheet below.

Hex nut diameter	Tightening torque (N.m)
Φ 6	15~20
Φ 9.52	30~40
Φ 12	45~55
Φ 16	60~65
Φ 19	70~75

Step 5: Connect indoor and outdoor pipe

1. Remove the wire clip; connect the power connection wire and signal control wire (only for cooling and heating unit) to the wiring terminal according to the color, fix them with screws.

2. Fix the power connection wire and signal control wire with wire clip (only for cooling and heating unit).

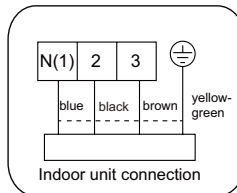
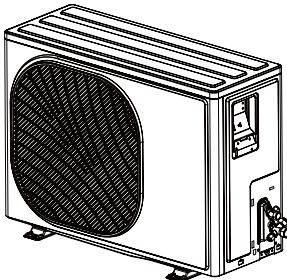

NOTE:

- After tighten the screw, pull the power cord slightly to check if it is firm.
- Never cut the power connection wire to prolong or shorten the distance.

Step 6: Neaten the pipes

1. The pipes should be placed along the wall, bent reasonably and hidden possibly.
Min.semidiometer of bending the pipe is 10cm.
2. If the outdoor unit is higher than the wall hole, you must set a U-shaped curve in the pipe before pipe goes into the room, in order to prevent rain from getting into the room.

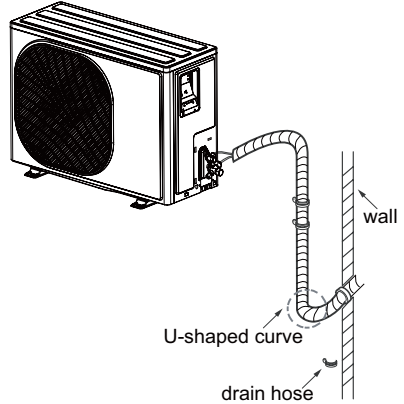

NOTE:

- The through-wall height of drain hose shouldn't be higher than the outlet pipe hole of indoor unit.
- The water outlet can't be placed in water in order to drain smoothly.

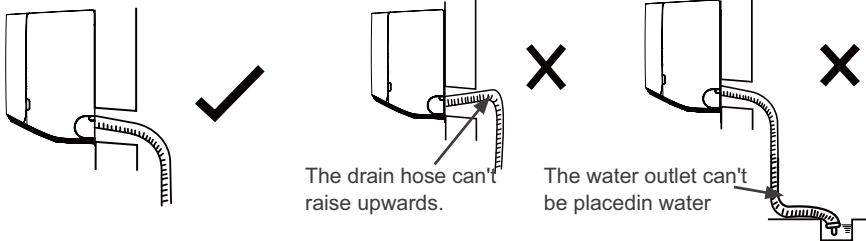

Slant the drain hose slightly downwards. The drain hose can't be curved, raised and fluctuant, etc.

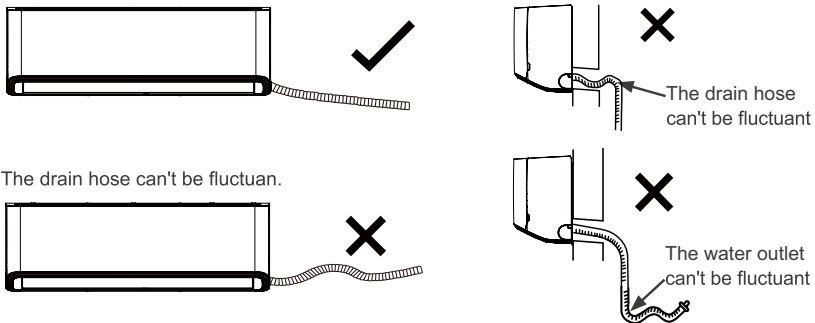

Step 7: Vacuum pumping

Use vacuum pump

1. Remove the valve caps on the liquid valve and gas valve and the nut of refrigerant charging vent.
2. Connect the charging hose of piezometer to the refrigerant charging vent of gas valve and then connect the other charging hose to the vacuum pump.
3. Open the piezometer completely and operate for 10-15min to check if the pressure of piezometer remains in -0.1MPa .
4. Close the vacuum pump and maintain this status for 1-2min to check if the pressure of piezometer remains in -0.1MPa . If the pressure decreases, there may be leakage.
5. Remove the piezometer, open the valve core of liquid valve and gas valve completely with inner hexagon spanner.
6. Tighten the screw caps of valve and refrigerant charging vent.
7. Reinstall the handle.

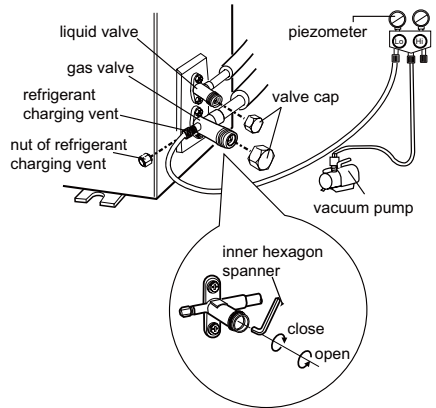

Step 8: Leakage detection

1. With leakage detector:

Check if there is leakage with leakage detector.

2. With soap water:

If leakage detector is not available, please use soap water for leakage detection.

Apply soap water at the suspected position and keep the soap water for more than 3min. If there are air bubbles coming out of this position, there's a leakage.

Check after installation

Check according to the following requirement after finishing installation.

Items to be checked	Possible malfunction
Has the unit been installed firmly?	The unit may drop, shake or emit noise.
Have you done the refrigerant leakage test?	It may cause insufficient cooling (heating) capacity.
Is heat insulation of pipeline sufficient?	It may cause condensation and water dripping.
Is water drained well?	It may cause condensation and water dripping.
Is the voltage of power supply according to the voltage marked on the nameplate?	It may cause malfunction or damaging the parts.
Is electric wiring and pipeline installed correctly?	It may cause malfunction or damaging the parts.
Is the unit grounded securely?	It may cause electric leakage.
Does the power cord follow the specification?	It may cause malfunction or damaging the parts.
Is there any obstruction in the air inlet and outlet?	It may cause insufficient cooling (heating) capacity.
The dust and sundries caused during installation are removed?	It may cause malfunction or damaging the parts.
The gas valve and liquid valve of connection pipe are open completely?	It may cause insufficient cooling (heating) capacity.

Test operation

1. Preparation of test operation

- The client approves the air conditioner.
- Specify the important notes for air conditioner to the client.

2. Method of test operation

- Connect the power, press "ON/OFF" button on the remote controller to start operation.
- Press "MODE" button to select AUTO, COOL, DRY, FAN and HEAT to check whether the operation is normal or not.
- If the ambient temperature is lower than 16°C, the air conditioner can't start cooling.

Configuration of connection pipe

1. Standard length of connection pipe
 - 5m, 7.5m, 8m.
2. Min. length of connection pipe is 3m.
3. Max. length of connection pipe and max. high difference.

Cooling capacity	Max length of connection pipe	Max height difference	Cooling capacity	Max length of connection pipe	Max height difference
5000Btu/h (1465W)	10	5	24000Btu/h (7032W)	25	10
7000Btu/h (2051W)	10	5	28000Btu/h (8204W)	30	10
9000Btu/h (2637W)	10	5	36000Btu/h (10548W)	30	20
12000Btu/h (3516W)	10	5	42000Btu/h (12306W)	30	20
18000Btu/h (5274W)	20	10	48000Btu/h (14064W)	30	20

4. The additional refrigerant oil and refrigerant charging required after prolonging connection pipe.
 - After the length of connection pipe is prolonged for 10m at the basis of standard length, you should add 5ml of refrigerant oil for each additional 5m of connection pipe.
 - The calculation method of additional refrigerant charging amount (on the basis of liquid pipe):
Additional refrigerant charging amount = prolonged length of liquid pipe × additional refrigerant charging amount per meter
 - Basing on the length of standard pipe, add refrigerant according to the requirement as shown in the table. The additional refrigerant charging amount per meter is different according to the diameter of liquid pipe. See the following sheet.

Additional refrigerant charging amount

Diameter of connection pipe		Outdoor unit throttle
Liquid pipe(mm)	Gas pipe(mm)	Refri.Charge(g/m)
Φ6	Φ9.52 or Φ12	15
Φ6 or Φ9.52	Φ16 or Φ19	15
Φ12	Φ19 or Φ22.2	30
Φ16	Φ25.4 or Φ31.8	60
Φ19	-	250
Φ22.2	-	350

Pipe expanding method

Improper pipe expanding is the main cause of refrigerant leakage. Please expand the pipe according to the following steps:

A: Cut the pipe

Confirm the pipe length according to the distance of indoor unit and outdoor unit. Cut the required pipe with pipe cutter.

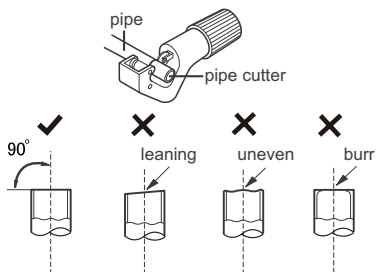

B: Remove the burrs

Remove the burrs with shaper and prevent the burrs from getting into the pipe.

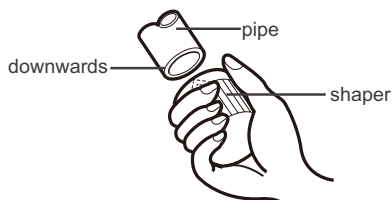

C: Put on suitable insulating pipe

D: Put on the union nut

Remove the union nut on the indoor connection pipe and outdoor valve; install the union nut on the pipe.

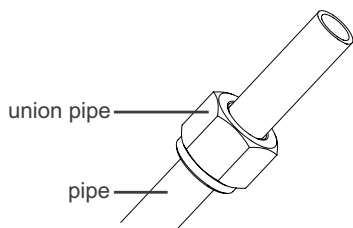

E: Expand the port

Expand the port with expander.

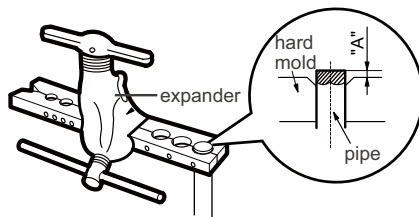

NOTE:

• "A" is different according to the diameter, please refer to the sheet below:

Outer diameter(mm)	A(mm)	
	Max	Min
Φ6 - 6.35(1/4")	1.3	0.7
Φ9.52(3/8")	1.6	1.0
Φ12-12.7(1/2")	1.8	1.0
Φ15.8-16(5/8")	2.4	2.2

F: Inspection

Check the quality of expanding port. If there is any blemish, expand the port again according to the steps above.

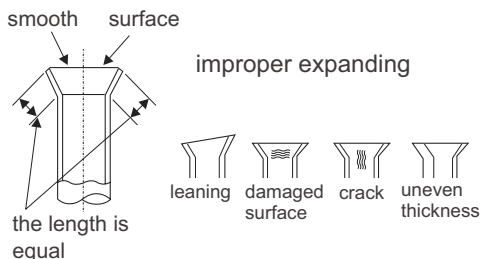

Philips Coolhome App User Guide

App Download

Search for “Philips Coolhome” in the app store and download the app.

Registration & Login

- 1.First-time users should complete the registration process before logging in.
- 2.Tap “Forgot Password” to reset it if users forget their APP login password.

Device Pairing & Adding

- 1.Check if the Wi-Fi, location services, and Bluetooth of the phone is on.
- 2.Tap the “+” icon in the top right corner of the app, select “Add Device”, and choose the corresponding device icon.
- 3.When the air conditioner is on, point the remote control at the indoor unit and press the “Up/Down Swing” button 8 times within 10 seconds.
- 4.The LCD screen will display 'A2' or the Wi-Fi icon will start flashing, indicating that the system has entered pairing mode.
- 5.The LCD screen will show “A3” to indicate that the device has been successfully added.

Device Management

Users can quickly turn the devices(air conditioner) on or off from the home screen. Long press the icon of the online device(air conditioner) to move, delete, rename, or share it.

Device Control Panel

Tap the online device(air conditioner) on the home screen to access its control panel, and remotely manage its settings and functions.



NEED SUPPORT WITH YOUR PRODUCT?

Mulson's TRADING CORP.

LOT 6, CAPRI ROAD, BRGY. CUPANG, MUNTINLUPA CITY, PHILIPPINES.

CONTACT OUR SALES OFFICE : (+632) 8-842-7746 : (+632) 8518-8520 :
(+632) 8807-0991 : (+632) 8807-1085

EMAIL ADDRESS : sales@mulsons.com

FOR AFTER-SALES-SERVICE INQUIRIES OR COMPLAINTS, KINDLY CONTACT:

TEL. NO. (+632) 8842-4970

Luzon area

Email address: service1@mulsons.com
Mobile #(+63) 967-715-7885

89901020001000 1.2512

Visayas & Mindanao area

Email address: service4@mulsons.com
Mobile #(+63) 967-715-7883