

4

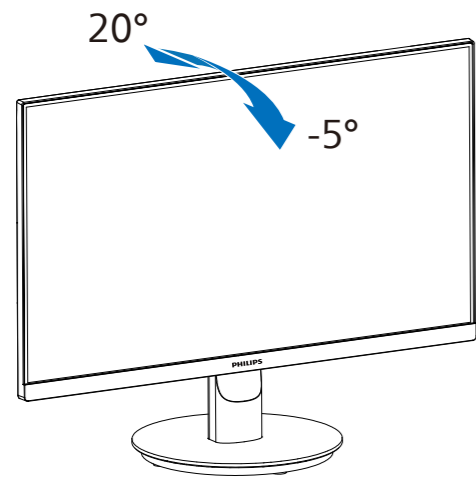

Register your product and get support at www.philips.com/support



FAQ



Software



User Manual

2025 © TOP Victory Investments Ltd. All rights reserved.

This product has been manufactured by and is sold under the responsibility of Top Victory Investments Ltd., and Top Victory Investments Ltd. is the warrantor in relation to this product. Philips and the Philips Shield Emblem are registered trademarks of Koninklijke Philips N.V. and are used under license.

Specifications are subject to change without notice.

HDMI

The terms HDMI, HDMI High-Definition Multimedia Interface, HDMI Trade Dress and the HDMI Logos are trademarks or registered trademarks of HDMI Licensing Administrator, Inc.

www.philips.com



H41G785681335A

PHILIPS

S Line

27259



Quick Start

Register your product and get support at www.philips.com/welcome

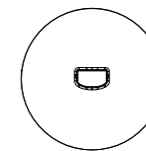
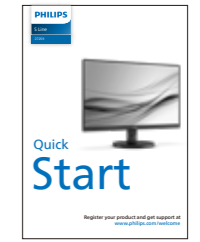
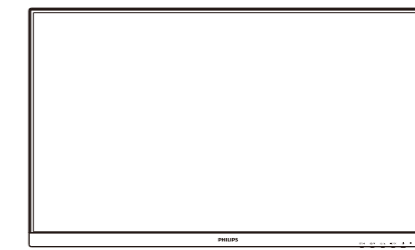

Power

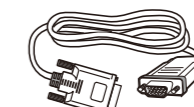

*VGA

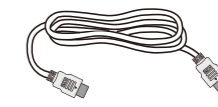

*HDMI

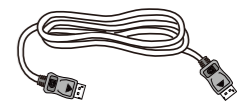

*DP

*Different according to region

Display design may differ from that illustrated

1

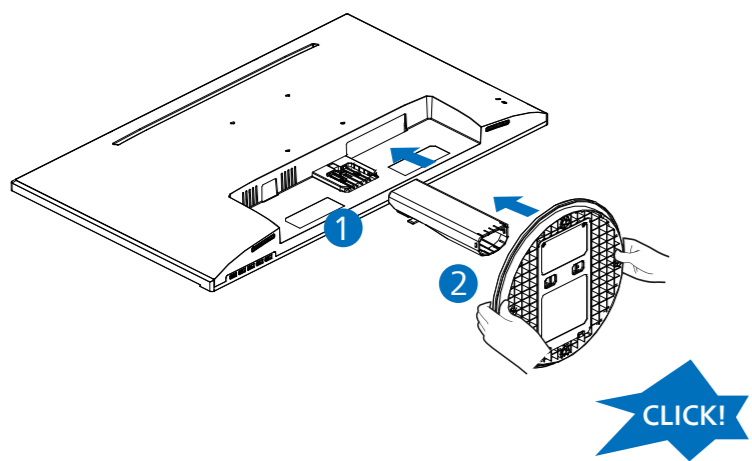

2

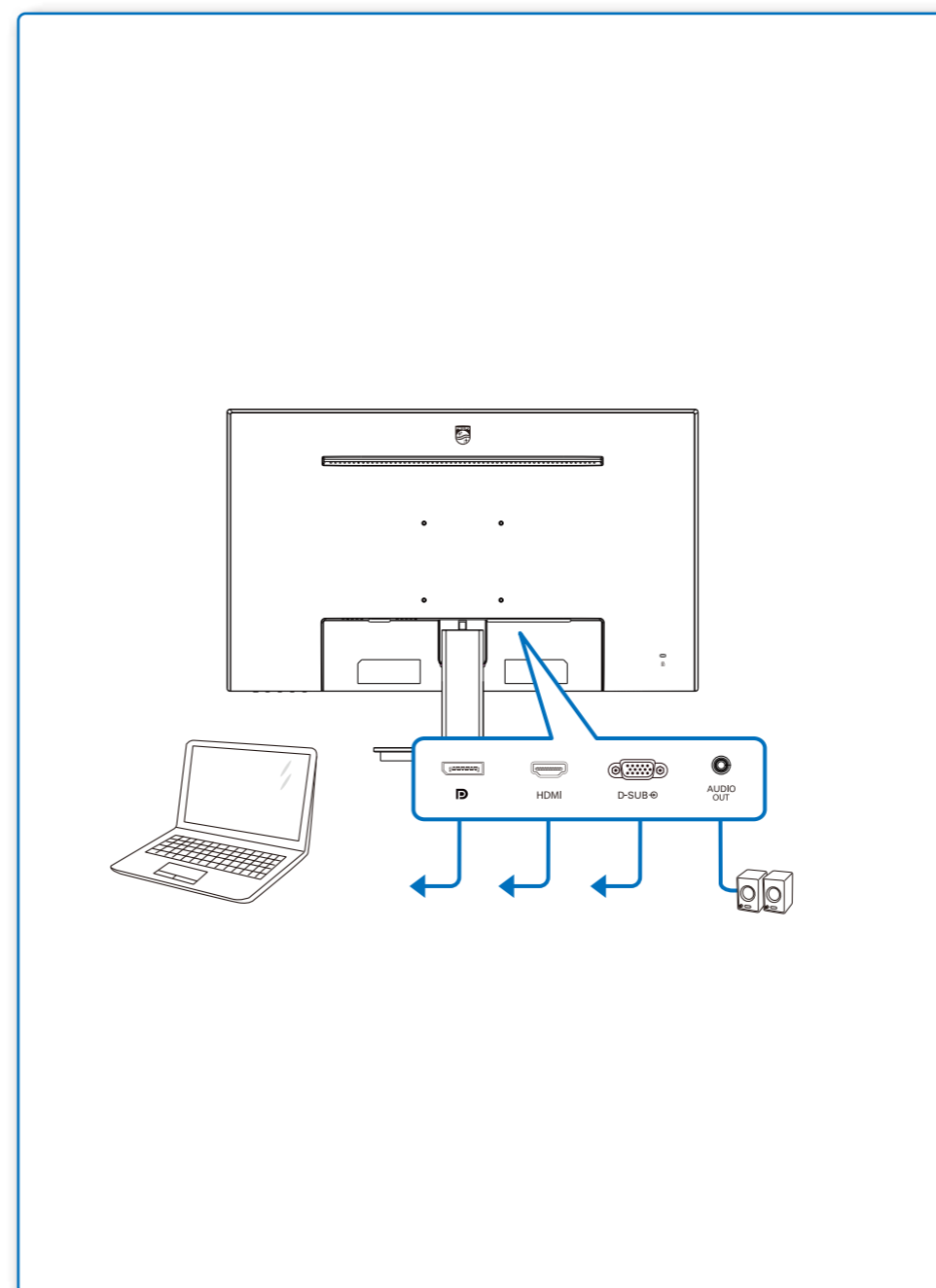
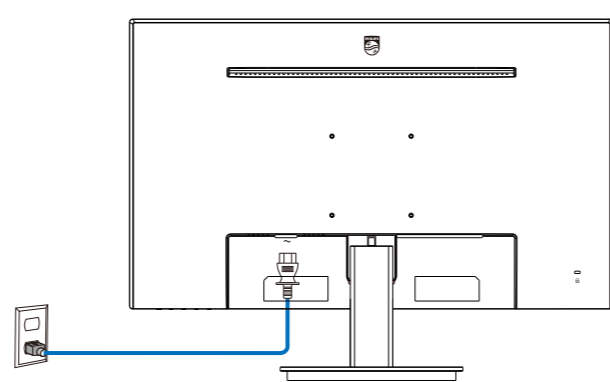

3

