

# PHILIPS

---



# User manual

Register your product and get support at  
**[www.philips.com/support](http://www.philips.com/support)**

Call us:  
**1-833-978-3323**

To obtain assistance, contact Philips customer care center;  
In the U.S., Canada, Puerto Rico, or the U.S. Virgin Islands

# Contents

<b>1</b>	<b>Notice</b>	<b>4</b>			
	Important safety instructions	5			
<b>2</b>	<b>Getting started</b>	<b>9</b>			
	What's included	9			
	Installing TV	10			
	Unpacking and Installing the stands	10			
	Wall mount	11			
	Control Panel & Terminal	11			
	Control panel	11			
	Terminals	12			
	Connect devices	13			
	Watch TV	13			
	Game console/BD/DVD player	13			
	Home theater speaker	14			
	PC screen	15			
	Connect devices - Internet router	15			
<b>3</b>	<b>Completing the first time setup</b>	<b>16</b>			
	Remote	16			
	Installing the Batteries	16			
	Buttons	17			
	Talk to Google Assistant	17			
	Privacy protection built-in	17			
	Initial set-up	18			
	Plug in and turn on TV	18			
	Follow the on-screen instructions	18			
	Get started with setup	18			
	Basic TV mode	20			
	Use basic TV on a Google TV device	20			
	Switch from basic TV to Google TV	20			
<b>4</b>	<b>Using the On-Screen Menu</b>	<b>21</b>			
	Home menu	21			
	Dashboard	21			
	Channels & Inputs	22			
	Display & Sound	22			
	Picture	22			
	Screen	23			
	Sound	23			
	Audio output	24			
	Network & Internet	25			
	Accounts & Profiles	26			
	Google Account	26			
	Privacy	27			
	Apps	28			
	Add more apps	28			
	See all apps	28			
	Unused apps	28			
	Manage updates	28			
	App permissions	28			
	Special app access	28			
	Security	28			
	<b>System</b>	<b>29</b>			
	Ambient Screensaver	29			
	Power and Energy	29			
	About	29			
	System Update	29			
	Device name	29			
	Reset	29			
	Status	29			
	Legal Information	29			
	Model	29			
	Android TV OS Version	29			
	Android TV OS Security Patch level	29			
	Kernel Version	29			
	Android TV OS Build	29			
	Netflix ESN	29			
	Software Version	29			
	TV Life Time	29			
	Date & Time	29			
	Language	29			
	Keyboard	29			
	Storage	30			
	Cast	30			
	System Sounds	30			
	Restart	30			
	<b>Accessibility</b>	<b>30</b>			
	Talkback	30			
	Text to speech	31			
	Text scaling	31			
	Bold text	31			
	Color correction	31			
	Use Accessibility shortcut	31			
	Keyboard accessibility	31			
	Turn on Switch Access	31			
	Audio Description	31			
	Turn on closed captions	31			
	Turn on high contrast text	31			
	<b>Remotes &amp; Accessories</b>	<b>32</b>			
	Pair a Bluetooth device	32			
	Reconnect a paired device	32			
	Fix programs with connecting Bluetooth devices	32			
	Troubleshoot connection issues	32			
	<b>Help &amp; Feedback</b>	<b>33</b>			
	Send feedback	33			
	Help	33			

<b>5 Enhance your Google TV</b>	<b>34</b>
Home menu	34
Add Google account	34
Sign in or add an account	34
Remove or manage accounts	34
Remove your account if you can't use your TV screen	34
Installing apps	35
Search for an app	35
Browse for apps	35
Remove apps	35
Personalized recommendation	35
Add your streaming services	35
Tell us what you like to watch	35
Manage your watchlist	36
Mark what you've watched	36
Rate movies and shows	36
Hide recommendations	36
Turn on Apps only mode	36
Exit Apps only mode	36
Watch your movies & shows in Apps only mode	36
What happens when Apps only mode is on	36
Basic TV mode	37
Switch from basic TV to Google TV	37
What you can do in basic TV	37
What you can't do in basic TV	37
Live TV/EPG	37
Program Guide	37
Live TV from broadcasting	37
Choose your favorite channels	37
Program guide	38
Live TV from streaming providers	38
Pluto TV	38
YouTube TV	38
Sling TV	38
Philo	38
Live TV Settings --- Live	38
Live TV Settings --- Broadcast	39
Kids profile (parental control)	40
Add a kids profile	40
Switch to a kids profile	40
Set up a profile lock	40
Allow or block content or apps	40
Allow or block content in your library based on rating	40
Set a daily screen time limit	40
Set a daily bedtime	40
Add bonus time	41
Report inaccurate content ratings	41
Hide library content	41
Unhide library content	41
Parental Controls	41

Use Phone as remote/Watchlist	42
Use your phone as your Google TV remote	42
Set up your virtual remote	42
Fix problems with the Google TV virtual remote	42
Ambient mode (Digital Photo Frame)	42
Change the screen saver	42
Choose your screen saver	42
Choose which photos show	42
Customise settings	43
Show weather & time on your screen saver	43
Cast to Google TV	43
Cast to Google TV	43
Cast from a device to your TV	43
Fix problems with casting	43
Connect your TV and device to the same Wi-Fi network	43
Update your TV	43
Google Assistant	44
Do more with Google Assistant on Google TV	44
Talk to Google Assistant	44
What you can ask Google Assistant	44
USB camera for Google Meet	45
How to connect USB camera	45

<b>6 Troubleshooting tips</b>	<b>46</b>
Basic issues	46
Network connections	46
Connect Remote control	46
Video	47
Audio	48
Cable/Satellite TV	49
External devices	49
Connect Bluetooth	51

<b>7 Information</b>	<b>52</b>
Glossary	52
Maintenance	52
Specifications	53
Warranty	54
License	55

Register online at [www.philips.com/welcome](http://www.philips.com/welcome) today  
to get the most benefits from your purchase.

Registering your model with Philips makes you eligible for all of the valuable benefits listed below, so don't miss out.  
Register online at [www.philips.com/support](http://www.philips.com/support) to ensure:

#### \*Product safety notification

By registering your product, you'll receive notification – directly from the manufacturer – in the rare case of a product recall or safety defect.

#### \*Additional benefits

Registering your product guarantees that you'll receive all of the privileges to which you're entitled, including special money-saving offers.

Know these **safety** symbols



The caution marking is located on the rear or bottom of the cabinet.

☐ The symbol for CLASS II or double insulated electrical apparatus. This apparatus has been designed in such a way that it does not require a safety connection to electrical earth.

**WARNING:** To reduce the risk of fire or electric shock, do not expose this apparatus to rain or moisture. Apparatus shall not be exposed to dripping or splashing and no objects filled with liquids, such as vases, shall be placed on the apparatus.

**CAUTION:** To prevent electric shock, match wide blade of plug to wide slot, fully insert.



The lightning flash with arrowhead symbol, within an equilateral triangle, is intended to alert the user to the presence of uninsulated "dangerous voltage" within the apparatus's enclosure that may be of sufficient magnitude to constitute a risk of electric shock to persons.



The exclamation point within an equilateral triangle is intended to alert the user to the presence of important operating and maintenance (servicing) instructions in the literature accompanying the apparatus.



Protective earthing terminal. The apparatus should be connected to a mains socket outlet with a protective earthing connection (Only for Class I appliance).

If the apparatus doesn't have the symbol ☐ in its rating label and its power cord has three pins, it means protective earthing connection is needed. The apparatus should be connected to a mains socket outlet with a protective earthing connection (Only for Class I appliance).

**PHILIPS**

For fastest support visit us online for chat and self service  
solutions at [www.philips.com/support](http://www.philips.com/support)

## CHILD SAFETY:

### PROPER TELEVISION PLACEMENT MATTERS

#### THE CONSUMER ELECTRONICS INDUSTRY CARES

- Manufacturers, retailers and the rest of the consumer electronics industry are committed to making home entertainment safe and enjoyable.
- As you enjoy your television, please note that all televisions – new and old – must be supported on proper stands or installed according to the manufacturer's recommendations. Televisions that are inappropriately situated on dressers, bookcases, shelves, desks, speakers, chests, carts, etc., may fall over, resulting in injury.

#### TUNE IN TO SAFETY

- ALWAYS follow the manufacturer's recommendations for the safe installation of your television.
- ALWAYS read and follow all instructions for proper use of your television.
- NEVER allow children to climb on or play on the television or the furniture on which the television is placed.
- NEVER place the television on furniture that can easily be used as steps, such as a chest of drawers.
- ALWAYS install the television where it cannot be pushed, pulled over or knocked down.
- ALWAYS route cords and cables connected to the television so that they cannot be tripped over, pulled or grabbed.

CTA.tech/safety

Consumer Technology  
Association™

#### WALL OR CEILING MOUNT YOUR TELEVISION

- ALWAYS contact your retailer about professional installation if you have any doubts about your ability to safely mount your television.
- ALWAYS use a mount that has been recommended by the television manufacturer and has a safety certification by an independent laboratory (such as UL, CSA, ETL).
- ALWAYS follow all instructions supplied by the television and mount manufacturers.
- ALWAYS make sure that the wall or ceiling where you are mounting the television is appropriate. Some mounts are not designed to be mounted to walls and ceilings with steel studs or cinder block construction. If you are unsure, contact a professional installer.
- Televisions can be heavy. A minimum of two people is required for a wall or ceiling mount installation.

#### MOVING AN OLDER TELEVISION TO A NEW PLACE IN YOUR HOME

- Many new television buyers move their older televisions into a secondary room after the purchase of a flat-panel television. Special care should be made in the placement of older televisions.
- ALWAYS place your older television on furniture that is sturdy and appropriate for its size and weight.
- NEVER place your older television on a dresser where children may be tempted to use the drawers to climb.
- ALWAYS make sure your older television does not hang over the edge of your furniture.

## Important safety instructions

1. Read these instructions.
2. Keep these instructions.
3. Heed all warnings.
4. Follow all instructions.
5. Do not use this apparatus near water.
6. Clean only with dry cloth.
7. Do not block any ventilation openings. Install in accordance with the manufacturer's instructions.
8. Do not install near any heat sources such as radiators, heat registers, stoves, or other apparatus (including amplifiers) that produce heat.
9. Do not defeat the safety purpose of the polarized or grounding-type plug. A polarized plug has two blades with one wider than the other. A grounding type plug has two blades and a third grounding prong. The wide blade or the third prong are provided for your safety. If the provided plug does not fit into your outlet, consult an electrician for replacement of the obsolete outlet.
10. Protect the power cord from being walked on or pinched particularly at plugs, convenience receptacles, and the point where they exit from the apparatus.
11. Only use attachments/accessories specified by the manufacturer.
12. Use only with the cart, stand, tripod, bracket, or table specified by the manufacturer, or sold with the apparatus. When a cart is used, use caution when moving the cart/apparatus combination to avoid injury from tip-over.
13. Unplug this apparatus during lightning storms or when unused for long periods of time.



14. Refer all servicing to qualified service personnel. Servicing is required when the apparatus has been damaged in any way, such as power-supply cord or plug is damaged, liquid has been spilled or objects have fallen into the apparatus, the apparatus has been exposed to rain or moisture, does not operate normally, or has been dropped.

### Note to the CATV system installer:

This reminder is provided to call the CATV system installer's attention to Article 820 of the NEC, ANSI/NFPA 70 and Section 54 of the CEC, Part I that provides guidelines for proper grounding and, in particular, specifies that the cable ground shall be connected to the grounding system of the building, as close to the point of cable entry as practical.

### Example of antenna grounding as per NEC – National Electric Code

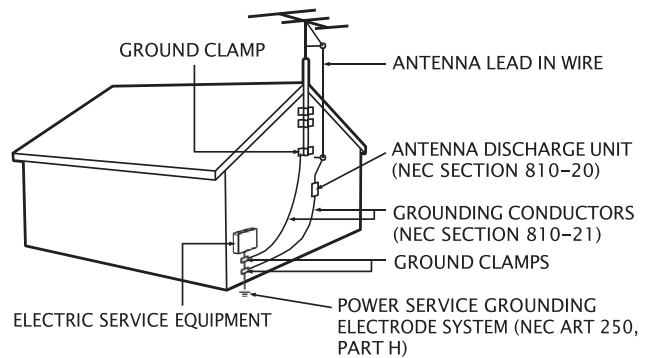

If an outside antenna or cable system is connected to the product, be sure the antenna or cable system is grounded so as to provide some protection against voltage surges and built-up static charges. Article 810 of the NEC, ANSI/NFPA 70 and Section 54 of CEC, Part I provides information with respect to proper grounding of the mast and supporting structure, grounding of the lead in wire to an antenna-discharge unit, size of grounding conductors, location of antenna discharge unit, connection to grounding electrodes, and requirements for the grounding electrode.

The Philips trademarks are registered trademarks of Koninklijke Philips N.V. and are used under license. This product has been manufactured and is sold under the responsibility of Skyworth USA Corporation, and Skyworth USA Corporation is the warrantor in relation to this product.

Skyworth USA Corporation reserves the right to change products at any time without being obliged to adjust earlier supplies accordingly.

The material in this Owner's manual is believed adequate for the intended use of the system. If the product or its individual modules or procedures are used for purposes other than those specified herein, confirmation of their validity and suitability must be obtained. Skyworth USA Corporation warrants that the material itself does not infringe any United States patents. No further warranty is expressed or implied.

Skyworth USA Corporation cannot be held responsible neither for any errors in the content of this document nor for any problems as a result of the content in this document. Errors reported to Skyworth USA Corporation will be adapted and published on the Skyworth USA Corporation support website as soon as possible.

#### Pixel characteristics

This LCD product has a high number of color pixels. Although it has effective pixels of 99.999 % or more, black dots or bright points of light (red, green or blue) may appear constantly on the screen. This is a structural property of the display (within common industry standards) and is not a malfunction.

#### Warranty

No components are user serviceable. Do not open or remove covers to the inside of the product. Repairs may only be done by service centers and official repair shops. Failure to do so shall void any warranty, stated or implied.

Any operation expressly prohibited in this manual, any adjustments or assembly procedures not recommended or authorized in this manual shall void the warranty.

#### Federal communications commission notice

This equipment has been tested and found to comply with the limits for a Class B digital device, pursuant to part 15 of the FCC Rules. These limits are designed to provide reasonable protection against harmful interference in a residential installation. This equipment generates, uses and can radiate radio frequency energy and, if not installed and used in accordance with the instructions, may cause harmful interference to radio communications. However, there is no guarantee that interference will not occur in a particular installation. If this equipment does cause harmful interference to radio or television reception, which can be determined by turning the equipment off and on, the user is encouraged to try to correct the interference by one or more of the following measures:

- Reorient or relocate the receiving antenna.
- Increase the separation between the equipment and the receiver.
- Connect the equipment into an outlet on a circuit different from that to which the receiver is connected.
- Consult the dealer or an experienced radio or television technician for help.

#### Supplier's Declaration of Conformity

Trade name : PHILIPS  
 Responsible party : Skyworth USA Corporation  
 Model : 32PFL6446/F7 40PQF7446/F7  
 Address : 10833 Valley View Street, Suite 415,  
 Cypress, CA 90630, United States

Telephone number : 1 833 978 3323

\* This is not the mailing address for Open Source Software or Customer service.

#### Modifications

This apparatus may generate or use radio frequency energy. Changes or modifications to this apparatus may cause harmful interference.

Any modifications to the apparatus must be approved by Skyworth USA Corporation.

The user could lose the authority to operate this apparatus if an unauthorized change or modification is made.

#### Cables

Connections to this device must be made with shielded cables with metallic RF/EMI connector hoods to maintain compliance with FCC Rules and regulations.

The following FCC/IC RSS applies to the wireless LAN adapter included in this product.

FCC caution: Any changes or modifications not expressly approved by the party responsible for compliance could void the user's authority to operate this equipment.

This transmitter must not be co-located or operated in conjunction with any other antenna or transmitter.

#### FCC/IC RF Exposure Compliance

This equipment complies with FCC/IC radiation exposure limits set forth for an uncontrolled environment and meets the FCC radio frequency (RF) Exposure Guidelines and RSS-102 of the IC radio frequency (RF) Exposure rules.

This equipment should be installed and operated keeping the radiator at least 20 cm or more away from your body.

This device complies with Part 15 of FCC Rules and Industry Canada licence-exempt RSS standard(s). Operation is subject to the following two conditions: (1) this device may not cause interference, and (2) this device must accept any interference, including interference that may cause undesired operation of this device.

5150-5250 MHz band is restricted to indoor operations only.

High-power radars are allocated as primary users (i.e. priority users) of the bands 5250-5350 MHz and 5650-5850 MHz and that these radars could cause interference and/or damage to LE-LAN devices.

Compliance with FCC requirement 15.407(c) and IC requirement RSS-210A9.4.4

Data transmission is always initiated by software, which is the passed down through the MAC, through the digital and analog baseband, and finally to the RF chip. Several special packets are initiated by the MAC. These are the only ways the digital baseband portion will turn on the RF transmitter, which it then turns off at the end of the packet. Therefore, the transmitter will be on only while one of the aforementioned packets is being transmitted. In other words, this device automatically discontinues transmission in case of either absence of information to transmit or operational failure.

## Positioning the TV

- Large screen TVs are heavy. **2 or more** people are required to carry and handle a large screen TV.
- Make sure to hold the upper and bottom frames of the unit firmly as illustrated.
- Install the unit in a horizontal and stable position.
- Do not install the unit in direct sunlight or in a place subject to dust or strong vibration.
- Depending on the environment, the temperature of this unit may increase slightly. This is not a malfunction.
- When installing this unit in a temperate environment, avoid a place with rapid temperature changes.
  - Operating temperature: 41 °F (5 °C) to 104 °F (40 °C)
- This unit should not be used in a tropical environment as it has not been evaluated under such conditions.
- No objects should be placed directly on or under this unit, especially lighted candles or other flaming objects.
- Depending on your external devices, noise or disturbance of the picture and/or sound may be generated if the unit is placed too close to them. In this case, please ensure enough space between the external devices and the unit.
- Do not insert the AC power cord into the power socket outlet before all the connections are made.
- Ensure that you always have easy access to the AC power cord and outlet to disconnect the TV from the AC outlet.
- Before you move the TV, disconnect attached cables to prevent damage to connectors, especially the TV tuner.
- Be sure to unplug the AC power plug from the AC outlet before moving or carrying the unit.
- When moving the TV and then setting it down, please be careful not to pinch the AC power cord under the unit.
- Do not place this unit in an area where it may be exposed to water, oil, or grease such as: near a bathtub, basin, kitchen sink, washing tub, swimming pool, kitchen exhaust fan, etc., or in a damp basement.

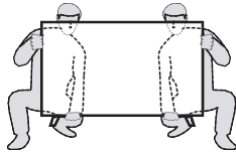

Do not place the unit on the furniture that is capable of being tilted by a child and an adult leaning, pulling, standing, or climbing on it. A falling unit can cause serious injury or even death.

In order to avoid interruption of ventilation, this unit should not be placed in built-in equipment such as a book cabinet, rack, etc., and the vents of this unit should not be covered with anything such as a tablecloth, curtain, newspaper, etc. Make sure that there is enough ventilation space (4 inches/10 cm or more) around this unit.

Press **⏻** (POWER) to turn the unit on and go into standby mode. To completely turn off the unit, you must unplug the AC power plug from the AC power outlet. Disconnect the AC power plug to shut the unit off when trouble is found or not in use. The AC plug shall remain readily available.

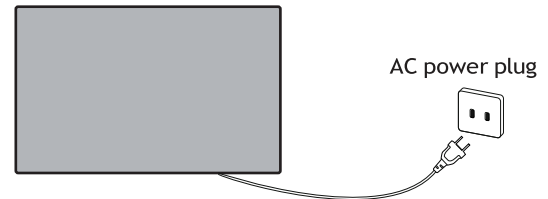

Never use a gas duster or a compressed air duster on this TV. The gas trapped inside of this unit may cause ignition and explosion.

## Environmental care



The packaging of this product is intended to be recycled. Contact your local authorities for information about how to recycle the packaging. For product recycling information, please visit - [www.recycle.philips.com](http://www.recycle.philips.com)

## End of life directives

Philips pays a lot of attention to produce environmental-friendly products in green focal areas. Your new TV contains materials which can be recycled and reused. At the end of its life, specialized companies can dismantle the discarded TV to concentrate the reusable materials and to minimize the amount of materials to be disposed of. Please ensure you dispose of your old TV according to local regulations.

## WARNING:

- replacement of a battery with an incorrect type may defeat a safeguard;
- disposal of a battery into fire or a hot oven, or mechanically crushing or cutting of a battery, may result in an explosion;
- leaving a battery in an extremely high temperature surrounding environment, such as sunshine, fire, or hot surface may result in an explosion or the leakage of flammable liquid or gas;
- a battery subjected to extremely low air pressure may result in an explosion or the leakage of flammable liquid or gas.

## CAUTION

Risk of fire or explosion if the battery is replaced by an incorrect type!

## Regulatory notices

**WARNING:** To prevent injury, this apparatus must be securely attached to the furniture/wall in accordance with the instructions. Tipping, shaking, or rocking the unit may cause injury/death.

## Stability Hazard

A television set may fall, causing serious personal injury or death.

Never place a television set in an unstable location. Many injuries, particularly to children, can be avoided by taking simple precautions such as:

- **ALWAYS** use cabinets or stands or mounting methods recommended by the manufacturer of the television set.
- **ALWAYS** use furniture that can safely support the television set.
- **ALWAYS** ensure the television set is not overhanging the edge of the supporting furniture.
- **ALWAYS** educate children about the dangers of climbing on furniture to reach the television set or its controls.
- **ALWAYS** route cords and cables connected to your television so they cannot be tripped over, pulled or grabbed.
- **NEVER** place a television set in an unstable location.
- **NEVER** place the television set on tall furniture (for example, cupboards or bookcases) without anchoring both the furniture and the television set to a suitable support.
- **NEVER** place the television set on cloth or other materials that may be located between the television set and supporting furniture.
- **NEVER** place items that might tempt children to climb, such as toys and remote controls, on the top of the television or furniture on which the television is placed.

If the existing television set is going to be retained and relocated, the same considerations as above should be applied.

## Preparing to move/ship the unit

Please pack the unit properly by following the diagram on the carton.

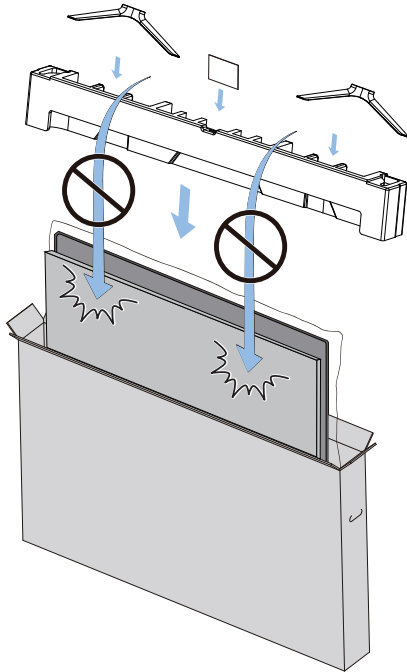

**CAUTION :** Please save the front cardboard\* to use when moving or shipping the TV.

**CAUTION :** To avoid damage to the screen, do not pack the stand on the same side as the TV screen, refer to the illustration above.

\* Cardboard is included in select models only.

## Copyright

All other registered and unregistered trademarks are the property of their respective owners.



The terms HDMI, HDMI High-Definition Multimedia Interface, HDMI trade dress and the HDMI Logos are trademarks or registered trademarks of HDMI Licensing Administrator, Inc.



Manufactured under license from Dolby Laboratories. Dolby, Dolby Audio, and the double-D symbol are trademarks of Dolby Laboratories Licensing Corporations.

Google, Google Home, Google Cast, Google Meet and other marks are trademarks of Google LLC.

Use of key features of this TV requires consent to Google Terms of Service and Privacy Policy.

This device complies with part 15 of the FCC Rules. Operation is subject to the following two conditions: (1) This device may not cause harmful interference, and (2) this device must accept any interference received, including interference that may cause undesired operation.

Features and specifications are subject to change without notice.

Network services, content, and the operating systems and software of this Product may be subject to individual terms and conditions and changed, interrupted, or discontinued at any time and may require fees, registration and credit card information.

The American Academy of Pediatrics discourages television viewing for children younger than two years of age.

Some features may require an always-on broadband internet connection, firmware update and/or a minimum bandwidth. Internet services vary by location.

# 2 Getting started

## What's included

### Quick start guide



### Safety instruction/ Limited warranty



### AC Power Cord



### Remote and Batteries (AAA, 1.5 V x 2)

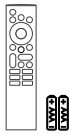

### Stand Screws and Bases



ST4 x 0.787" (20 mm)

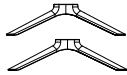

### Note(s)

- If you lose the screws, please purchase the above-mentioned Phillips head screws at your local store.
- If you need to replace these accessories, please refer to the part name or No. with the illustrations and call our toll free customer support line found on the cover of this user manual.

When using a universal remote to operate this unit.

- Make sure the component code on your universal remote is set to our brand. Refer to the instruction book accompanying your remote for more details.
- We do not guarantee 100 % interoperability with all universal remote.

# Installing TV

## Unpacking and Installing the stands

1

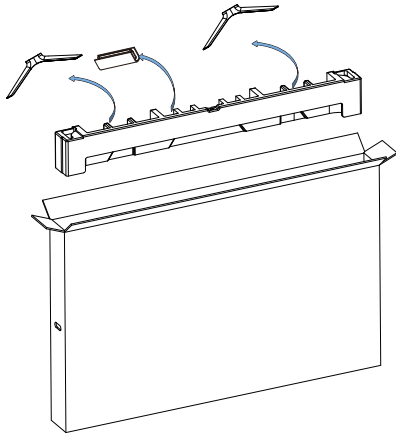

2

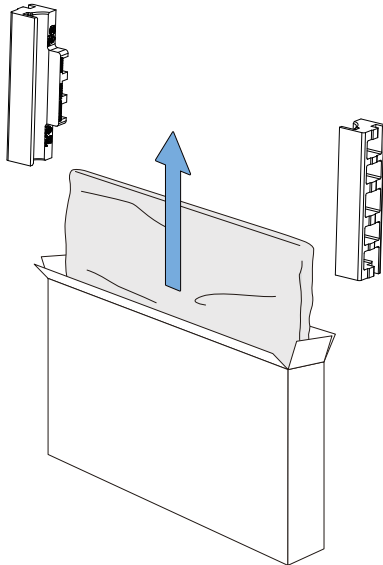

3 Cover a table top with a cloth or blanket to avoid damage to the TV screen. Hold both sides of the TV set to place on the table.

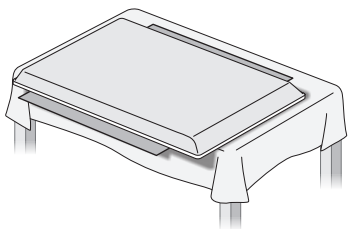

**Note(s)**

- Carefully lay the TV set, with the screen side down, on the front cardboard as shown in the figure.

4 Fasten the stands to the TV with 4 screws (included).

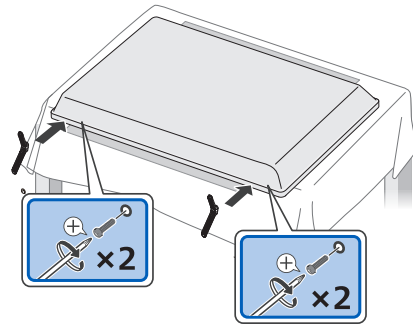

**Note(s)**

While fastening the screws, hold the stand to prevent it from falling.

5 Both stands now be securely fastened.

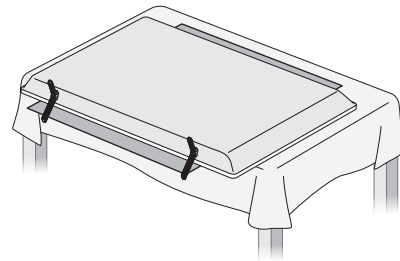

**Note(s)**

- A wide open space is recommended for assembly.
- A Phillips-head screwdriver is required to fasten the stands to the TV set.
- When attaching the stand, ensure that all screws are tightly fastened. If the stand is not properly attached, it could cause the unit to fall, resulting in injuries as well as damage to the unit.
- To remove the stand from this unit, unscrew the Phillips head screws by reversing the procedure. Be careful not to drop the stand when you remove it.

6 Carefully lift the TV set as shown in the illustration and place it onto a stable, level surface.

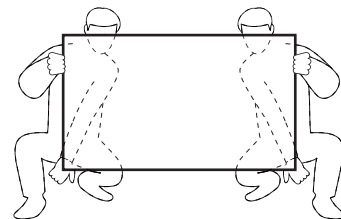

# Wall mount

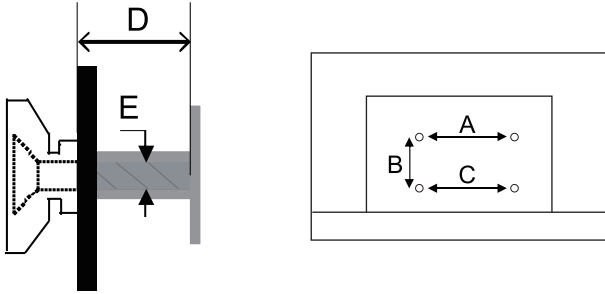

Model Size:		32\40"	
		Top	Down
Screw	Diameter(mm) "E"	M6	M6
	Depth(mm) "D"	Max	10
		Min	10
Quantity		2	2
A*B*C		200*200*200	

Your TV meets the VESA standard for wall mounting. Consult with your local dealer for a wall mount bracket which is compatible with your TV model.

- The net weight of your TV set without stands is:  
43": 13.34lbs/6.05 kg.
- For detailed information on installing the wall mount, refer to the wall mount instruction book.
- Skyworth USA Corporation is not responsible for any damage to the product or injury to yourself or others if you elect to install the TV wall mount bracket or mount the TV onto the bracket.
- The wall mount bracket must be installed by experts.  
Skyworth USA Corporation is not liable for these types of accidents or injuries noted below.
- If installed onto a ceiling or slanted wall, the TV and wall mount bracket may fall which could result in a severe injury.
- Do not use screws that are longer or shorter than their specified length. If screws too long are used this may cause mechanical or electrical damage inside the TV set. If screws too short are used this may cause the TV set to fall.
- Do not fasten the screws by excessive force. This may damage the product or cause the product to fall, leading to an injury.
- For safety reasons use 2 people to mount the TV onto a wall mounting bracket.
- Do not mount the TV onto the wall mounting bracket while your TV is plugged in or turned on. It may result in an electrical shock injury.

When installing the unit on the wall, allow this much space.

- Top : 11.8" (30 cm)
- Left and right side : 5.9" (15 cm)
- Bottom : 3.9" (10 cm)

# Control Panel & Terminal

## Control panel

### TV Control Button

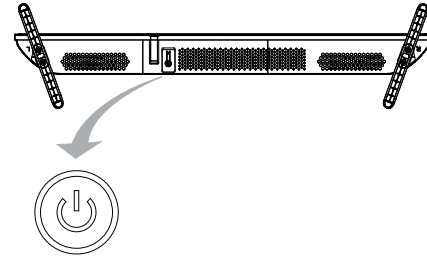

#### ■ In Standby Mode

Press TV control button to turn on the TV.

#### ■ In Working Status

Short press TV control button to call out the following menu of soft keyboard. Inside it, short press TV control button to move the cursor and select the desired item, then long press TV control button to enter or execute the selected item.

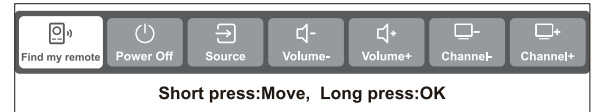

#### Note:

- 1) Only when the Bluetooth remote control has a buzzer on its back and has been paired with the TV successfully, the item "Find my remote" can be found on the menu of soft keyboard.
- 2) "Channel -/+ " may not be shown in the menu of soft keyboard on specific interfaces like the home screen, etc.

## Terminals

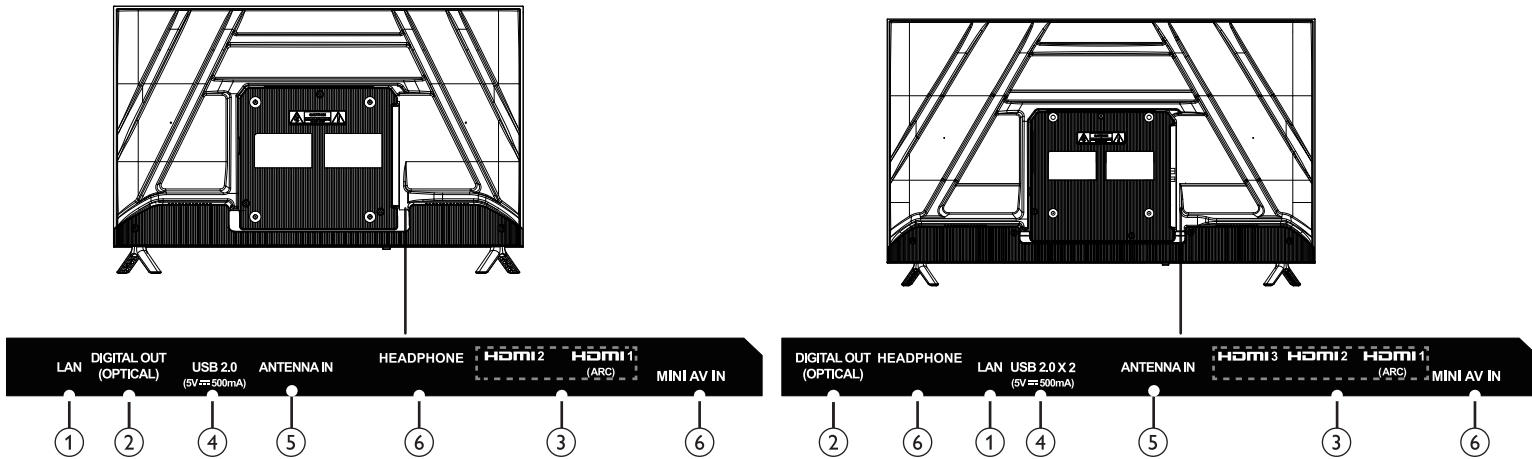

- ① **Ethernet port**  
For internet connection using an Ethernet cable with an RJ-45 connector.
- ② **Digital audio output (Optical) jack**  
Digital audio (SPDIF) output to home theaters and other digital audio systems.
- ③ **HDMI input jack(s)**  
Digital audio and video input from high definition digital devices such as DVD/Blu-ray Disc™ players, Soundbar/cable/satellite set-top boxes, PC's, etc.
  - HDMI-DVI/Analog audio (L/R) jacks signal
  - Composite video/Analog audio (L/R) jacks signal
  - PC connection/Analog audio (L/R) jacks signal with stereo mini 3.5 mm plug audio cable on PC
 \* For HDMI 1 only: In addition to normal HDMI functionality, it outputs TV audio to an HDMI-ARC compliant device, such as a soundbar and home theater system.
- ④ **USB terminal**  
Data input from USB memory stick only.
- ⑤ **43ohm Cable/Antenna connection**  
Signal input from an antenna or Cable/Satellite set-top boxes.
- ⑥ **Headphone audio output jack**  
Headphone 3.5 mm stereo jack for personal listening.  
**Composite input jack**  
Connect composite analog video and audio signal.

### Note(s)

- This TV has a USB port which is designed for connecting peripheral devices, such as a keyboard or mouse. While you may find that a particular keyboard or mouse works to some extent, we cannot guarantee full functionality. You will not damage the TV in any way by trying various keyboards or mouse, but the performance of that device may be limited.

# Connect devices

## Watch TV

Please choose your type.

Be sure your antenna or another device is connected properly before plugging in the AC power cord.

### A. Directly TV to Antenna through RF cable

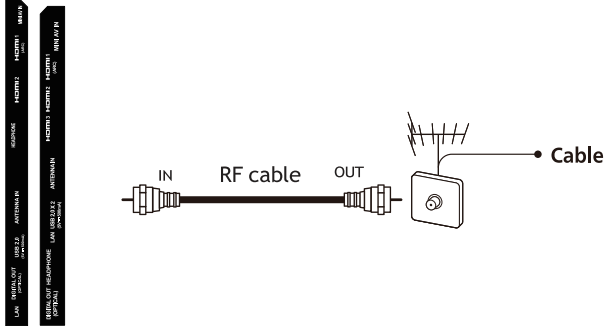

### B. Satellite set-top box through RF cable

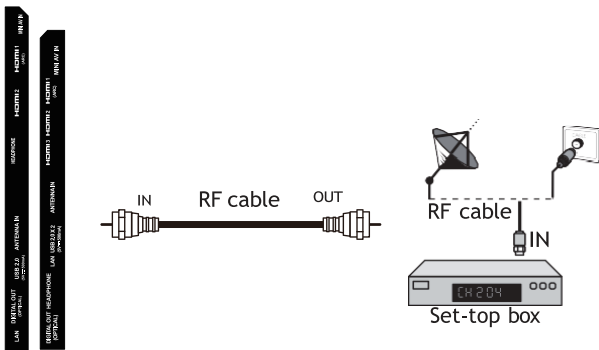

### C. Satellite set-top box through HDMI

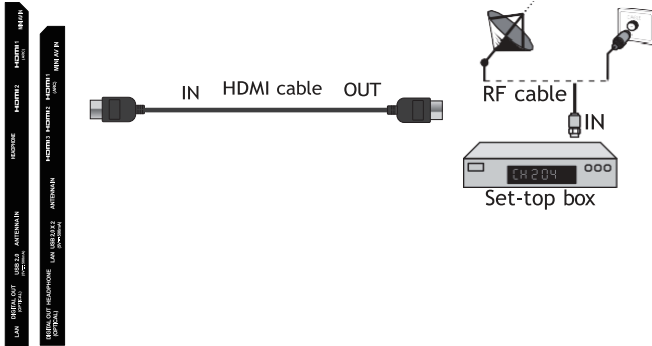

\* You must use UltraHD 4K HDMI cable for 4K video.

#### Note(s)

- If you have any question about the DTV's antenna, visit [www.antennaweb.org](http://www.antennaweb.org) for further information.
- Depending on your antenna system, you may need different types of combiners (mixers) or separators (splitters) for HDTV signal. The minimum RF bandpass on these devices is 2,000 MHz or 2 GHz.
- For your safety and to avoid damage to this unit, please unplug the RF coaxial cable from the antenna input jack before moving the unit.
- If you did use an antenna to receive analog TV, it should also work for DTV reception. Outdoor or attic antennas will be more effective than a set-top box or inside antenna.
- To turn on your reception source easily between antenna and cable, install an antenna selector.
- If you are not receiving a signal from your cable service, contact the cable provider.

## Game console/BD/DVD player

Please choose your type.

*Below cables are not included with the TV and need to be purchased separately:*

- Please purchase the necessary cables at your local store.

*Before you connect the AC power cord:*

Be sure other devices are connected properly before plugging in the AC power cord.

### HDMI - Highest quality

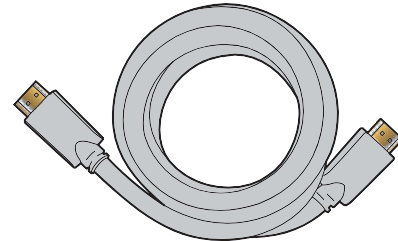

Supports high-definition digital signals and gives highest picture and sound quality. Video and audio signals are combined in one cable. You must use HDMI for full high-definition video and to enable HDMI control (HDMI CEC).

#### Note(s)

- Philips HDMI supports HDCP (High-bandwidth Digital Contents Protection). HDCP is a form of digital rights management that protects high-definition content in Blu-ray Disc™ or DVDs.
- The HDMI1(eARC/ARC) connector on the TV features HDMI-eARC/ARC functionality. This allows output of TV audio to an HDMI-eARC/ARC compliant device.

### A. HDMI — HDMI (High quality)

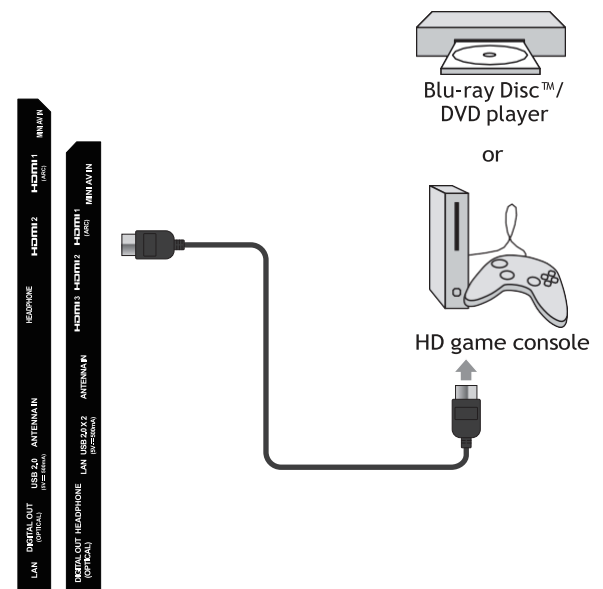

\* You must use UltraHD 4K HDMI cable for 4K video.

B. AV cable (standard quality)

Composite analog connection

Composite analog connection offers standard picture quality for AV devices connected to the unit.

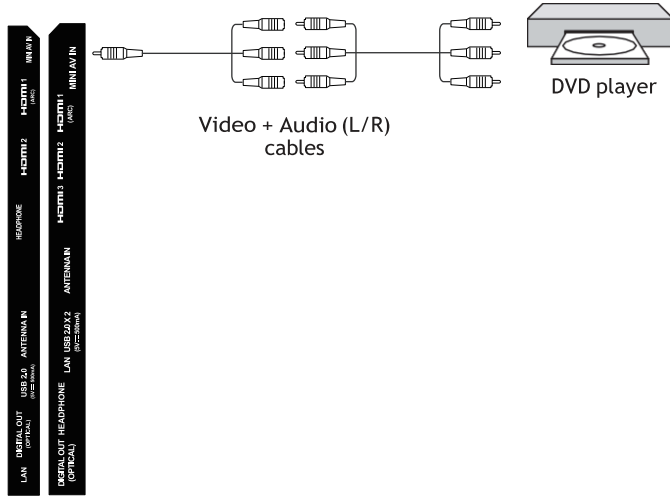

AV Converting Cable



For composite analog connection, AV converting cable (provided with your TV set) should be used between MINI AV IN port and normal AV cable.

Home theater speaker

Please choose your type.

A. Digital audio output cable

You can enjoy multi-channel audio like 5.1ch digital broadcasting sound.

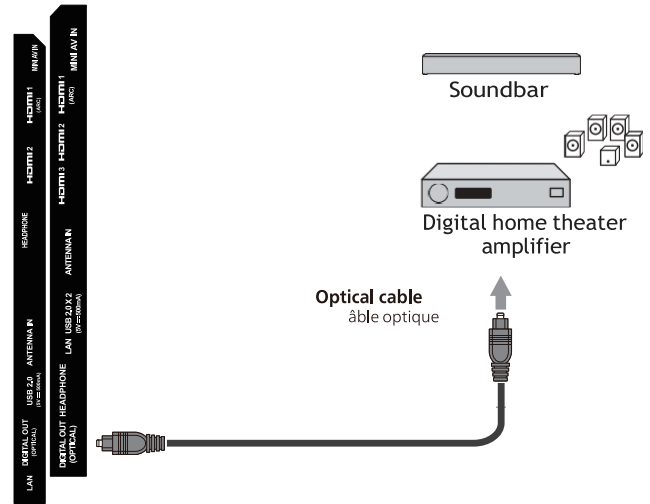

B. HDMI- ARC cable (Audio Return to Channel)

HDMI- ARC allows you to use HDMI control to output TV audio directly to a connected audio device, without the need for an additional digital audio cable.

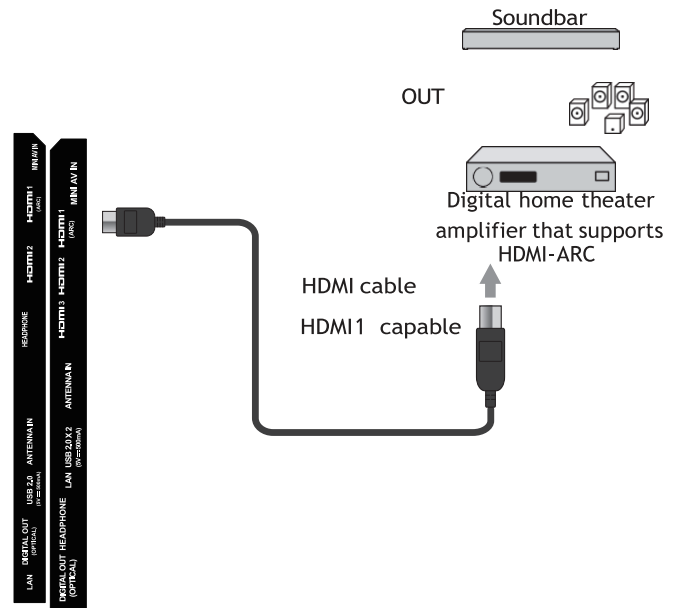

Note(s)

- The HDMI 1 connector is HDMI Audio Return Channel (ARC) compliant. Use it to output digital audio to an HDMI home theater system.
- Be sure that the device is HDMI CEC and ARC compliant and that the TV is connected to the device using an HDMI cable attached to HDMI- ARC connectors.
- The HDMI- ARC connector on the TV features ARC functionality. This allows output of TV audio to an HDMI- ARC compliant device.

## PC screen

Please choose your type.

### A. HDMI cable

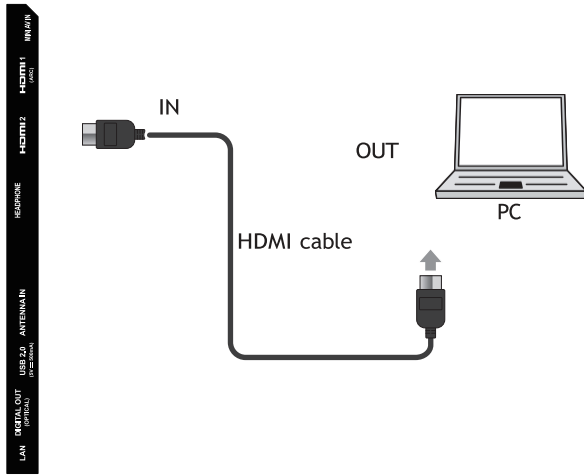

Format	Resolution	Refresh rate
VGA	640 x 480	60 Hz
SVGA	800 x 600	
XGA	1,024 x 768	
WXGA	1,280 x 768	24/30/60 Hz
	1,360 x 768	
FHD	1,920 x 1,080	24/30/60 Hz
UHD	3,840 x 2,160	
		4,096 x 2,160

Other formats or non-standard signals will not be displayed correctly.

\* When connecting with HDMI-DVI, the operation is maximum 2160p@30 Hz.

#### Note(s)

- Please purchase a HDMI-DVI conversion cable that has a ferrite core.
- The following operations may reduce noise.
  - Attach a ferrite core to the AC power cord of your PC.
  - Unplug the AC power cord and use the built-in battery of your portable/laptop PC.
- Some HDMI cables and devices may not be compatible with the TV due to different HDMI specifications.
- Use an HDMI cable with the HDMI logo (a certified HDMI cable). High speed HDMI cable is recommended for the better compatibility.
- The unit accepts 480p, 720p, 1080p, and 2160p video signals only when using the HDMI connection and HDMI-DVI connection. When connecting with HDMI-DVI, the operation is maximum 2160p@30 Hz.
- HDMI-DVI connection requires separate audio connections as well and the audio signals are output as analog (L/R) audio.
- DVI does not display 480i image which is not in compliance with CTA-861-G.
- Overscaling, also referred to as overscanning, is when a computer's display renders outside of the viewable area of a monitor or TV screen. It's like having the outer edges of a photo partially covered by a picture frame due to the picture being too large.

## Internet router

Connecting the TV to the internet using an Ethernet cable

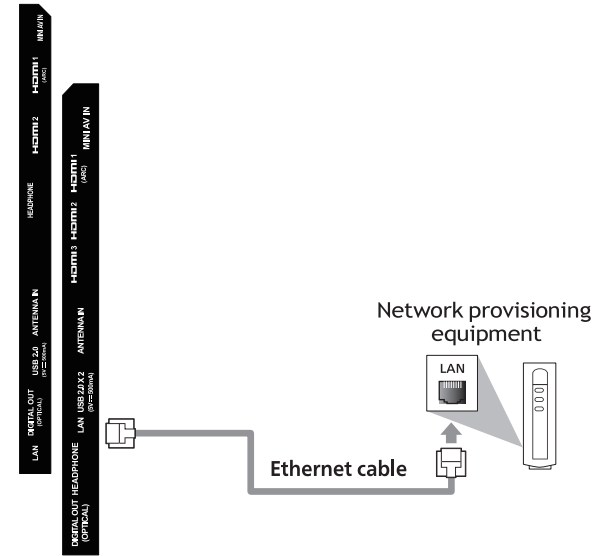

#### Note(s)

- Please purchase shielded Ethernet cables at your local store and use them when you connect to network equipment.
- After connecting an Ethernet cable, set up necessary network settings. Network & Internet → p. 27
- Do not insert any cable other than an Ethernet cable to the Ethernet port to avoid damaging the unit.
- If your telecommunications equipment (modem, etc.) does not have broadband router functions, connect a broadband router.
- If your telecommunications equipment (modem, etc.) has broadband router functions but there is no vacant port, then add a hub.
- For a broadband router, use a router which supports 10BASE-T/100BASE-TX.
- Do not connect your PC directly to the Ethernet port of this unit.

## Headphone

When the headphone is plugged into the HEADPHONE port, Sound of TV speakers will be muted.

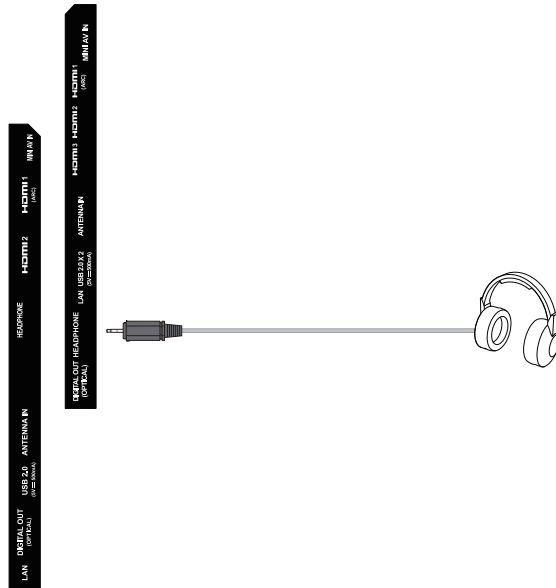

# 3 Completing the first time setup

## Remote

### Installing the Batteries

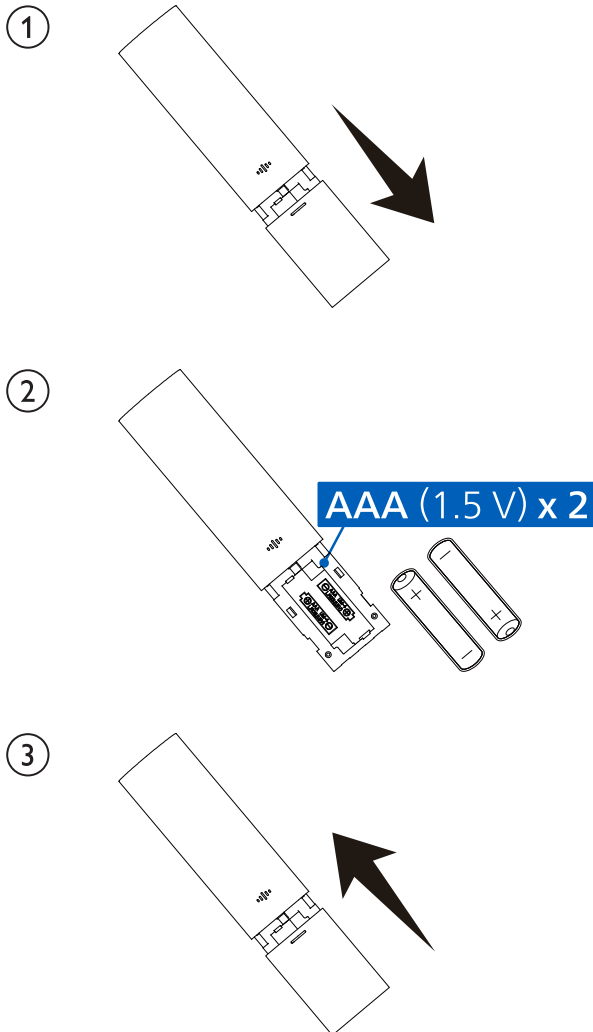

- 1 Open the battery cover by sliding down.
- 2 Insert 2 AAA (1.5 V) batteries matching the polarity indicated inside battery compartment of the remote.
- 3 Slide the cover back into position.

#### Note(s)

- Remove the batteries if not using the remote for an extended period of time.

## Buttons

### Bluetooth Remote

This TV comes with a Bluetooth remote control to operate your TV from anywhere in your room and have access to Google Assistant to do more on your TV with your voice.

#### Microphone & Bluetooth LED

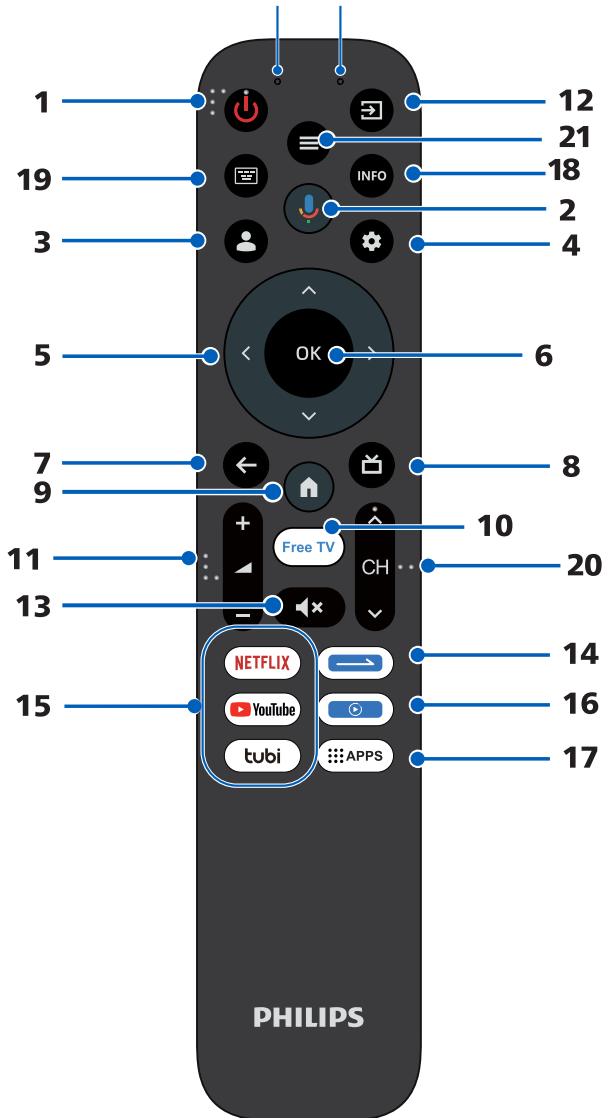

- 1. POWER (⏻):** Turn on or turn off the TV.
  - In working status:
    - Short press POWER button to turn the TV to fastboot mode.
    - Long press POWER button to turn the TV to standby mode.
  - In fastboot mode, which is less energy saving, press POWER button to turn on the TV in a short time.
  - In standby mode, which is more energy saving, press POWER button to turn on the TV in a standard time.
- 2. GOOGLE ASSISTANT (🗣️):** Start using the near field voice function.
  - Short press MIC button to wake up the voice assistant.
  - Long press MIC button to start receiving your voice command. After your speaking, release MIC button to run voice function
- 3. ACCOUNT (👤):** Sign in with your Google account to get the entertainment you love.
- 4. DASHBOARD (⚙️):** Access the dashboard of your Google TV.
- 5. NAVIGATION BUTTONS (UP/DOWN/LEFT/RIGHT):** Navigate the menu to select the content you need, or
  - Press UP/DOWN button to change channels.
- 6. OK:** Confirm, enter or execute the selected item, or access the channel list.
- 7. BACK (←):** Return to upper-level content, or exit the current screen or operation.
- 8. GUIDE (📺):** Access Live TV or access the Electronic Program Guide.
- 9. HOME (🏠):** Access the home screen.
- 10. FREE TV:** Access the Google TV Freeplay.
- 11. VOLUME UP/DOWN (🔊/🔇):** Adjust the sound volume.
- 12. SOURCE (📺):** Access the source menu.
- 13. MUTE (🔇):** Mute or restore the TV sound.
- 14. DAILY KEY (↔️):**
  - Press the button to start the shortcut function, or setup it for the first time.
- 15. APPLICATION BUTTONS**
  - Access specific applications quickly and directly.
- 16. MEDIA:** Access the media player.
- 17. APPS:** Show all applications.
- 18.INFO:** Display program information
- 19.Virtual keyboard:** Open virtual keyboard. (only under Live TV)
- 20.Program(CH ^/v):** Select programs in ascending or descending order.
- 21.MENU:** Display main menu.

## Talk to Google Assistant

On your Google TV remote, press and hold the Google Assistant button  and ask a question or say a command. To help Google Assistant understand your request, speak into the microphone on your remote.

 Note(s)

To do even more with your Assistant, download the Google Assistant app  on your phone.

## Privacy protection built-in

The Google Assistant is designed with your privacy in mind. You can delete any voice-command history by pressing Google Assistant button and simply saying “Delete what I just said”.

For more details on privacy, please visit: <https://safety.google/intl/en-US>

## Initial set-up

### Plug in and turn on TV

Connect the AC power cord to the AC outlet. Press the  (POWER) on your remote.

Make sure that AC power cord must be plugged to AC outlet after all the necessary connections are made.

### Follow the on-screen instructions

After you get your Google TV device, you'll need to set it up.

What you need

- The Google Home app on your phone (recommended)
- A Wi-Fi internet connection (needed to connect your TV to the Internet)
- A Google Account (needed to access entertainment across thousands of streaming channels)

\* To turn on TalkBack during setup, press  (DASHBOARD) > Accessibility > TalkBack > Enable > OK.

### Get started with setup

Follow this step by step process to help you complete your Google TV. Settings in initial setup may vary depending on the region, model or Google service availability.

- 1 Pair your remote control with TV.

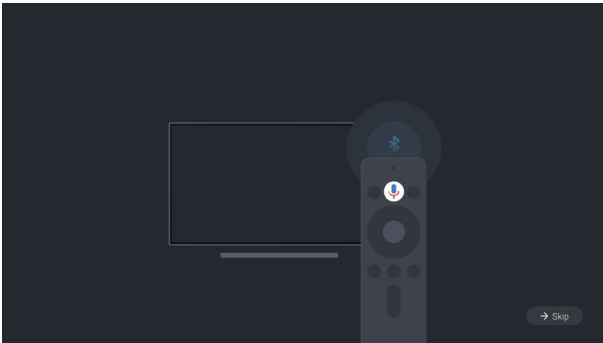

#### Note(s)

On any interface, you can press  (GOOGLE ASSISTANT) to quickly pair the Bluetooth remote control with your TV set.

- 2 Select your language and region or country.

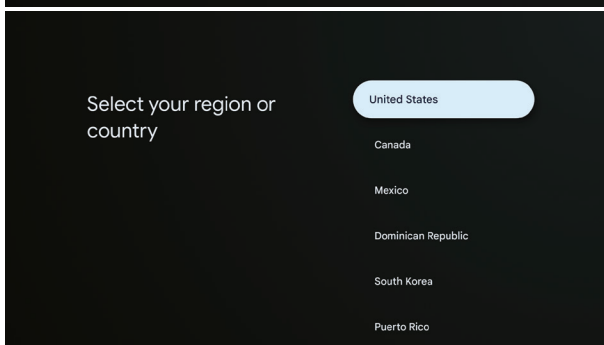
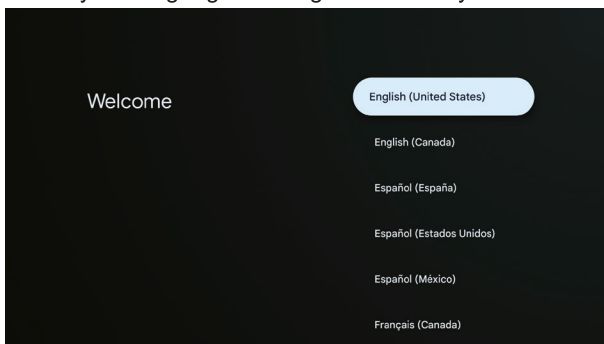

## 3 Setup your Google TV.

Finish setup with the Home app

- ① On your phone, open Google Home .
- ② At the top left, tap Add + > Set up device > Set up new devices in your home.
- ③ Choose or add a home.
- ④ Tap Scan code and allow the app to use your phone's camera.
- ⑤ Scan the QR code on your TV screen.

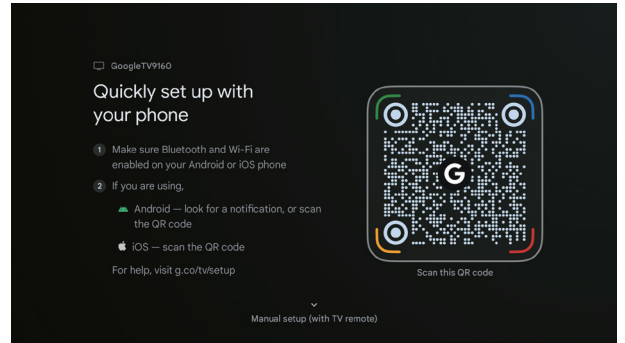

#### Note(s)

It may take a few minutes for your phone and TV to connect.

- ⑥ Follow the instructions in the Home app and on your TV screen.

### Fix problems with set up

You might need to set up your Google TV with your remote if:

- ① You get stuck when you set up with the Home app
- ② You can't update the Home app
- ③ Your device doesn't appear in the Home app

### Finish setup with your remote

Press **DOWN** navigation button to highlight "Manual setup (with TV remote)", then press **OK** button to start setup with your remote. It may take longer time and require typing with the remote.

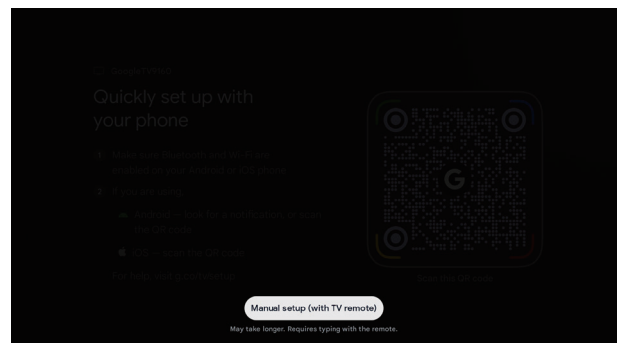

## 4 Select your TV mode.

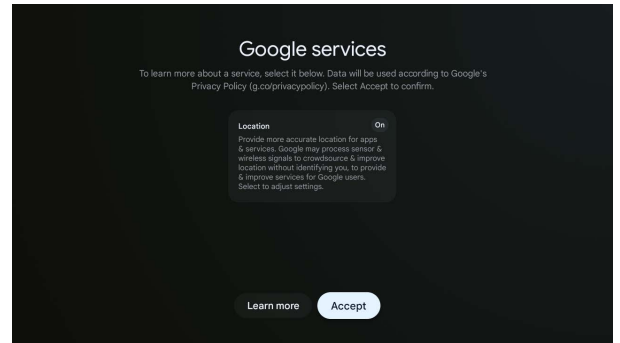
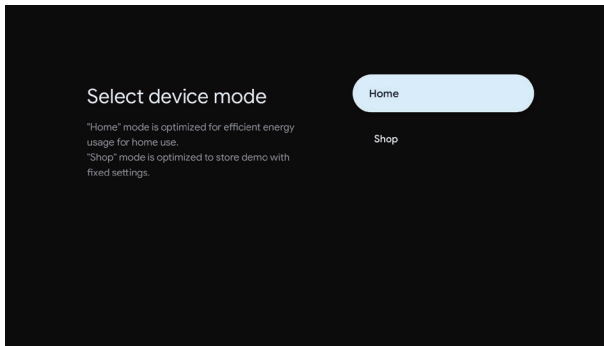

## 5 Connect your TV to a WiFi network.

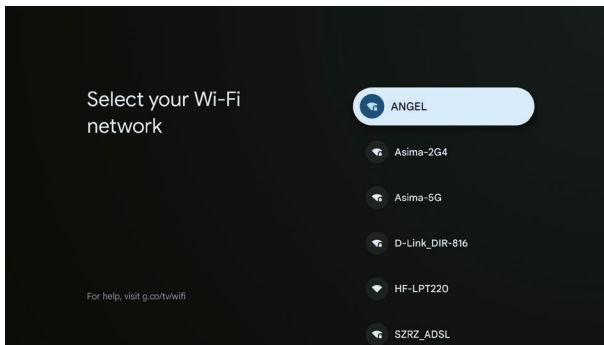

## 8 Select whether or not to allow Google Assistant to search across all your TV apps.

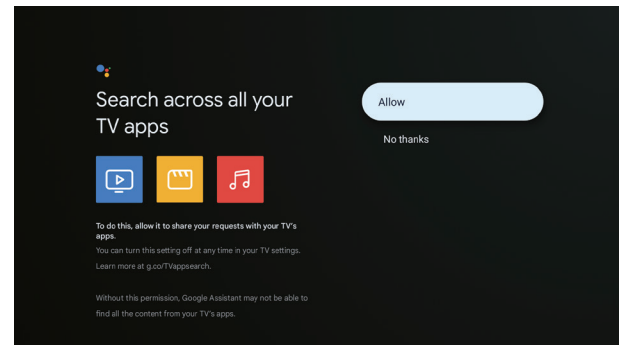

## 6 Enter your Google account and password.

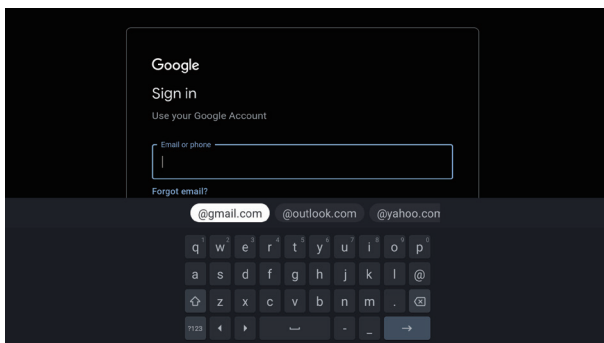

## 9 Select your services/apps.

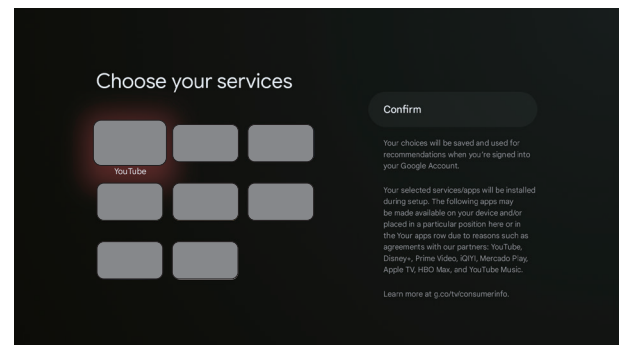

## 7 Read to accept the Google terms of service and privacy policy.

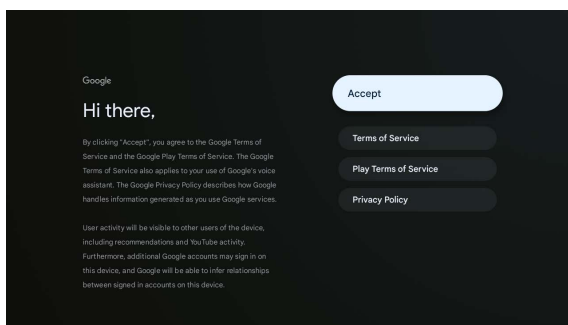

## 10 Read to accept the End User License Agreement.

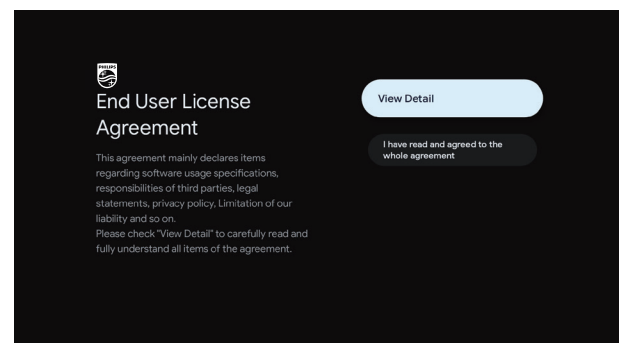

### 11 Select your time zone.

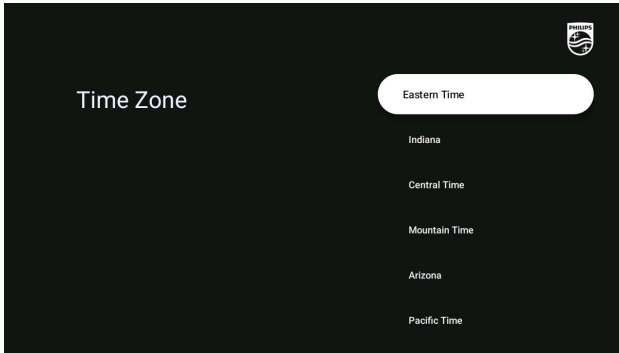

### 12 Select the tuner mode, then start channel tuning.

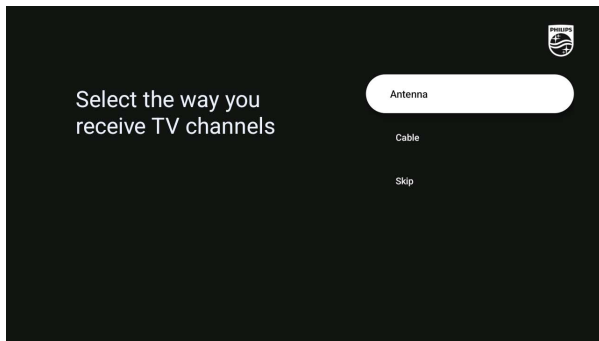

### 13 Install your apps.

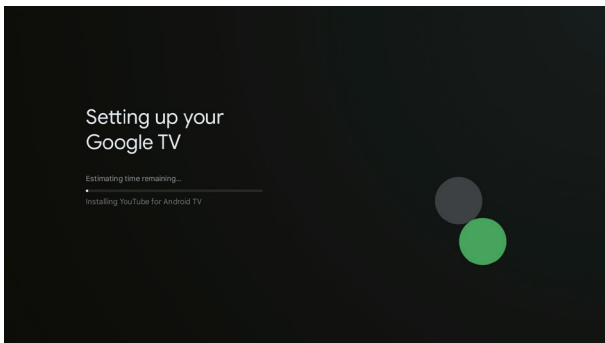

### 13 Setup optional features and then go to Google TV.



## Basic TV mode

### Use basic TV on a Google TV device

Important: You can only use basic TV on TVs that come with Google TV built in.

If you choose basic TV when you set up your Google TV device, you can:

- Finish setup faster
- Use your device without a Google Account
- Use your device without an internet connection
  - Without an internet connection, your device won't get important security updates.

\* Some features aren't available in basic TV.

### Switch from basic TV to Google TV

- ① From the home screen, scroll to the Google TV banner.
- ② Select Set up Google TV.
- ③ Follow the on-screen instructions to set up with the Home app or your remote.

Note(s)

If you already set up Google TV, you can't switch to basic TV. To start setup again, you can factory reset your device. Refer to Restart P.32.

What you CAN do in basic TV	What you CAN'T do in basic TV
<ul style="list-style-type: none"> <li>• Watch TV through your cable service, satellite, TV tuner, or antenna with the TV app</li> </ul>	<ul style="list-style-type: none"> <li>• Use services and features that require you to sign in to your Google Account</li> </ul>
<ul style="list-style-type: none"> <li>• Play media from other inputs plugged into the TV</li> </ul>	<ul style="list-style-type: none"> <li>• Access your Play Library</li> </ul>
<ul style="list-style-type: none"> <li>• Use a limited set of apps that come pre-installed on your device</li> </ul>	<ul style="list-style-type: none"> <li>• Install apps</li> </ul>
	<ul style="list-style-type: none"> <li>• Use the Assistant to search for content</li> </ul>
	<ul style="list-style-type: none"> <li>• Cast content from another device</li> </ul>

Basic TV - Home screen

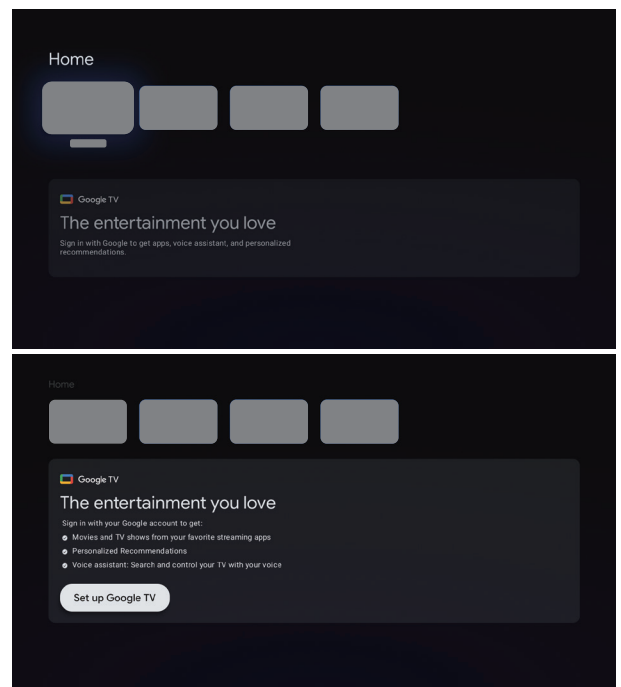

# 4 Using the On-Screen Menu

## Home menu

Google TV is TV personalized for you. Easily browse content from across your favorite apps and services, with specially curated recommendations based on your interests.

What you find on the Google TV home screen depends on where you live and the language you choose for your device.

- If you use a Google TV device in a country other than the one where you purchased it, your experience may vary.
- In some regions or territories, your experience may vary.

If you choose English, French, or Spanish as your language, you'll find these tabs:

- 1 Account**  
Switch to another account, add a new account or manage accounts.
  - 2 For you**  
Google TV home screen aggregates the best content from user's services.
  - 3 Live tab (U.S. only)**  
See what's live on TV across different service providers in one menu. To watch live TV, download an app from your TV service provider (if available). This service is available only in the U.S.
- Movies and Shows tab (Outside U.S.)**  
Discover new movies and shows with suggestions based on what you have watched and what interests you.
- 4 Apps tab**  
Access your installed apps library or find new ones based on what you use or download.
  - 5 Library tab**  
Find movies and TV shows you've added in your Watchlist or rented through the Google TV store or YouTube.
  - 6 Search**  
Search movies, shows, apps, and more.
  - 7 Dashboard**  
Google TV dashboard provides a single location for users to access settings, notifications, and kids mode.

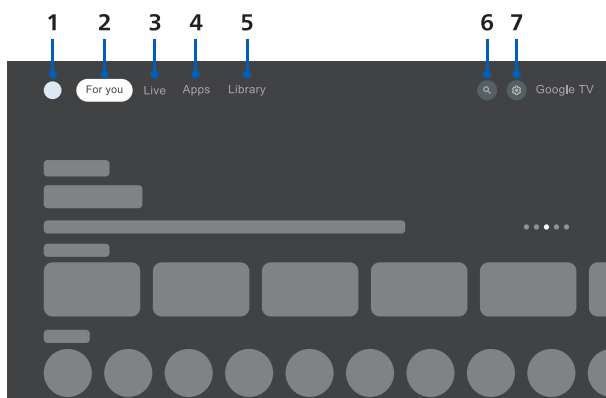

If you choose a different language or other countries, you'll find these tabs:

- Home
- Apps
- Library

## Dashboard

The Google TV dashboard provides a single location for users to access, settings, notifications, picture settings, and more.

To open the dashboard menu, press **⚙️ (DASHBOARD)** button on your remote.

- 1 Press **🏠 (HOME)** button to display the home screen.



- 2 From the Google TV home screen, at the top right, go to the icon **⚙️** of All settings, or press **⚙️ (DASHBOARD)** button.

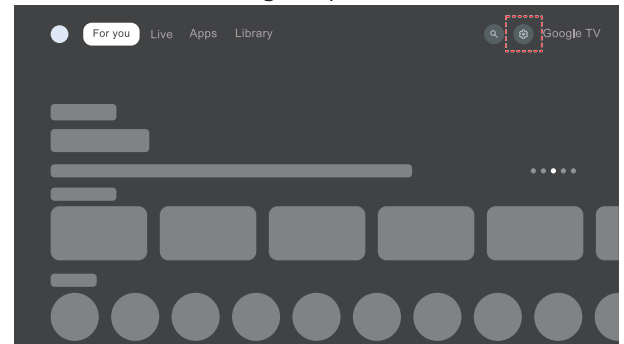

- 3 Use **▲▼◀▶** to select the desired menu and an item, then press **OK**.

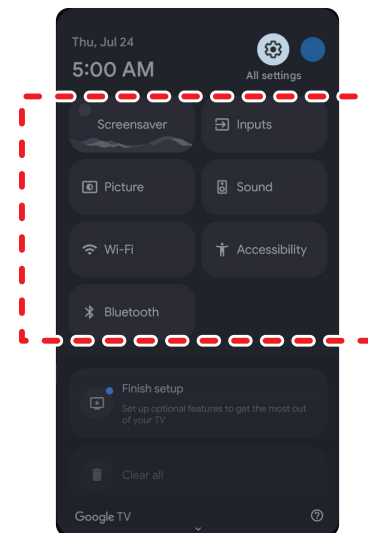

- **Screensaver**  
Screensaver will start.
- **Inputs**  
-> Select and change access to the attached devices such as Blu-ray player, gaming consoles, or cable box.
- **Picture** → p. 24
- **Sound** → p. 25
- **Wi-Fi** → p. 27
- **Accessibility** → p. 32
- **Bluetooth** → p. 34
- **Notification**  
-> Message regarding important device updates

## Channels & Inputs

To set Channels and Inputs,

- 1 Press **⚙️ (DASHBOARD)** button to open the Google TV dashboard menu, then select "All settings" and press **OK** button to enter it.
- 2 Go to Channels & Inputs

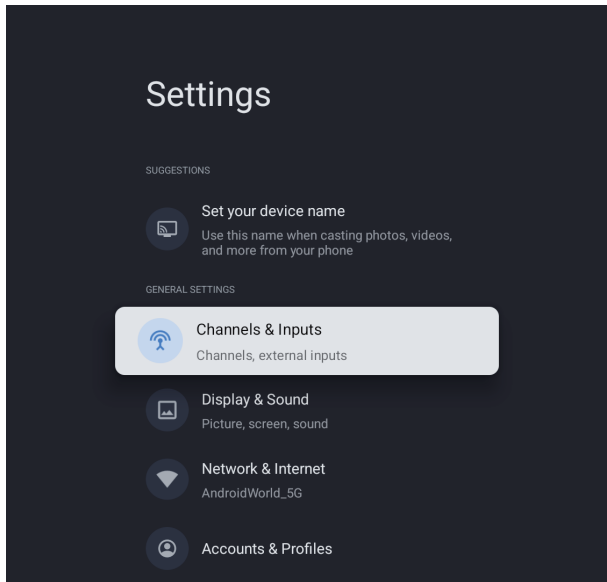

## Display & Sound

To set Picture and Sound,

- 1 Press **⚙️ (DASHBOARD)** button to open the Google TV dashboard menu, then select "All settings" and press **OK** button to enter it.
- 2 Go to Display & Sound

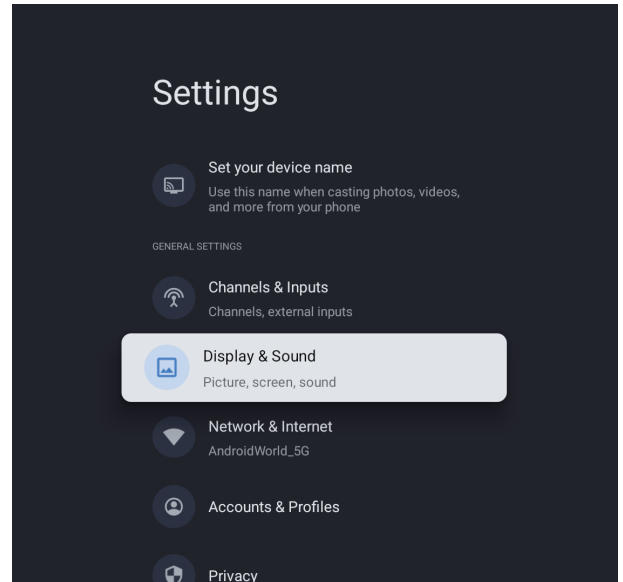

### Add channels

To add for the first time or additional channels, please follow the steps below:

- 1 Go to **Settings > Channels & Inputs > Channels**
- 2 Select your signal type **Antenna/Cable** in Channel Installation mode.
- 3 Start channel installation.

### Inputs

Switch or manage your TV inputs.

### HDMI LINK

**Consumer Electronic Control (CEC)** - This allows you to operate the linked functions between our brand devices with CEC feature and this unit. We do not guarantee 100% interoperability with other brands of CEC compliant devices.

- HDMI control
- Device auto power off
- TV auto power on

**HDMI EDID Version** - If there are issues with picture/color and/or sound when connecting an external device using the HDMI port, please try switching the HDMI EDID Version.

### Picture

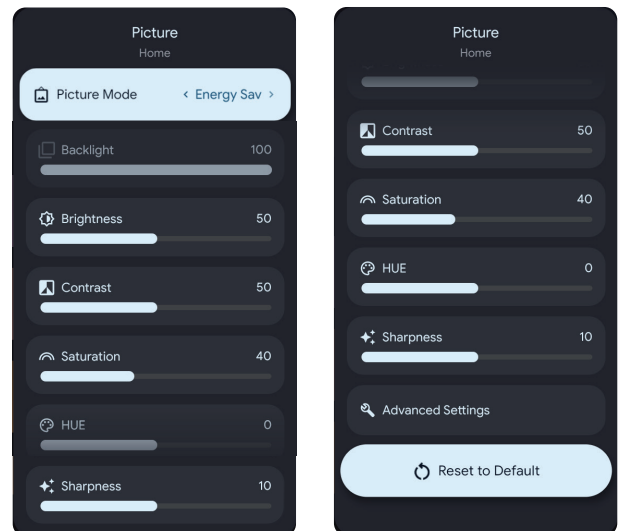

## Picture Mode

User	The customized settings you prefer.
Standard	For normal TV viewing.
Vivid	Make the color more vibrant.
Sports	Optimize the picture for a good sports viewing experience.
Movie	Deep picture settings for a cinematic experience.
Game	Optimized for PCs and game consoles.
Energy Saving	Settings for low power consumption.

## Backlight

Adjusts the LED brightness to affect the overall brilliant color.

## Brightness

Adjusts the black level of the picture.

## Contrast

Adjusts the white level of the picture. If the setting is too high or too low, detail may be difficult to distinguish in dark or bright areas of the picture.

## Saturation

Adjusts the intensity of the picture colors.

## HUE

Adjusts the tint of the picture. This setting is useful in adjusting the flesh tones in the picture.

## Sharpness

Adjusts the edge sharpness of picture elements. It can be used to sharpen non-HD (high definition) content; however, it will not produce detail that does not otherwise exist.

## Advanced Settings

For more detailed picture settings, go to Advanced Settings, where you find settings for Color Temperature, Noise Reduction, and etc.

## Reset to Default

Reset all picture settings to factory default values.

## Screen

Select the aspect ratio: Automatic / Super Zoom / 4:3 / Movie expand 14:9 / Movie expand 16:9 / Wide Screen / Full Screen / Unscaled.

## Sound

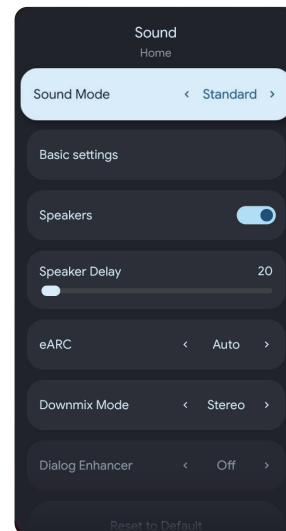

## Sound Mode

The following sound settings can be configured. Depending on the format of the broadcasting, some sound settings are not available.

User	The customized settings you prefer.
Standard	For normal TV viewing.
Vivid	Make the sound more vibrant.
Sports	Optimize the sound for a good sports hearing experience.
Movie	Powerful sound settings for a cinematic experience.
Music	Optimized for music playback.
News	Set the anchor's voice at a comfortable volume.

## Basic Settings

Adjust basic sound settings including: Balance, Bass, Treble, Surround Sound, Equalizer Detail, Auto Volume Control.

## Speakers

You can select the audio output from the unit's speakers or not. If your amplifier is HDMI link function compatible and connected by an HDMI cable to this unit, some sound operations such as volume up can be changed by using this unit's remote. Make sure **HDMI control** is set to **On**. **→ p.24**

Off	Output from the external audio system when an external device is connected.
On	Output from TV speakers when an external device is not connected.

## Speaker Delay

Adjust speaker output timing in the case video and sound on the TV speakers are not synchronized. For example, lip movements seem to have wrong timing.

## ARC

Turn on or turn off the HDMI-ARC function.

## Downmix Mode

- Stereo
- Surround

## Dialog Enhancer

- Off
- Low
- Medium
- High

## Reset to Default

Reset all sound settings to factory default values.

## Audio output

### Digital Output

- Auto
- Bypass
- PCM
- Dolby Digital Plus
- Dolby Digital
- MAT

### Digital Output Delay

The on-screen picture and the sound from an amplifier via the digital audio (SPDIF) output jack are synchronized by delaying the output from the connection.

Cursor ◀	Cursor ▶
The higher values will increase the digital audio (SPDIF) output delay.	

### Bluetooth Delay

The on-screen picture and the sound from an Bluetooth device are synchronized by delaying the output from the Bluetooth connection.

Cursor ◀	Cursor ▶
The higher values will increase the Bluetooth output delay.	

### Audio Output Device

Select the desired audio output device.

- Auto
- TV Speaker
- HDMI ARC
- HDMI eARC
- Bluetooth
- Headphone
- SPDIF
- TV Speaker and Bluetooth
- TV Speaker and Headphone
- TV Speaker and SPDIF

# Network & Internet

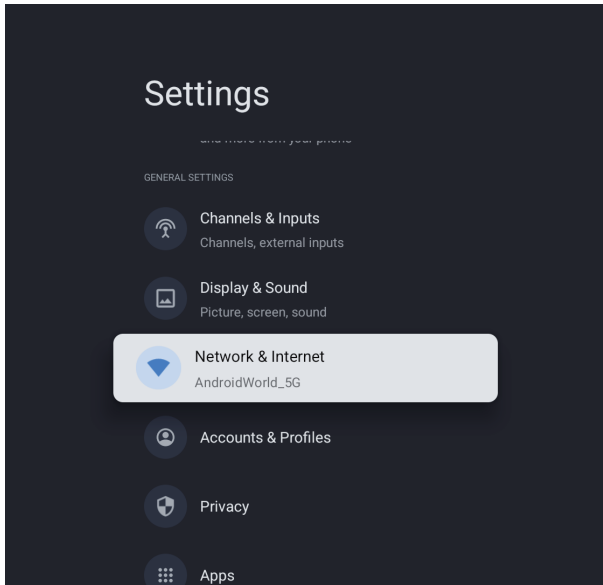

## Add new network

Enter name of the new WiFi network

## Scanning always available

Let Google's location service and other apps scan for networks, even when Wi-Fi is off.

Setup network connection settings in order to use apps or network upgrade functions.

To set Network & Internet,

- 1 Press **⚙️ (DASHBOARD)** button to open the Google TV dashboard menu, then select "All settings" and press **OK** button to enter it.
- 2 Go to Network & Internet

## Wi-Fi setting

- 1 Confirm that Wi-Fi is turned on and you're connected to the correct network.
- 2 If not, locate the network you'd like to connect to and select it to connect. Enter the password if required.
- 3 Open one of your apps.
- 4 Play your video, music, or game again.

### ☰ Note(s)

If you still have issues, turn the Wi-Fi option off and on again.

## Accounts & Profiles

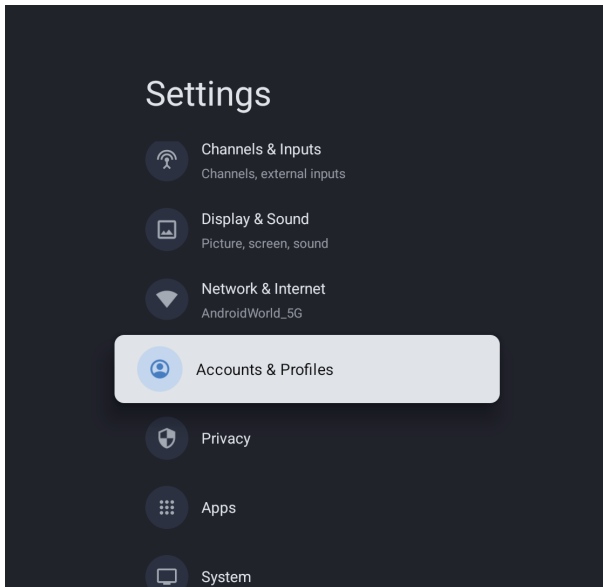

- 1 Press **⚙️ (DASHBOARD)** button to open the Google TV dashboard menu, then select "All settings" and press **OK** button to enter it.
- 2 Go to **Accounts & Profiles**  
You can manage to add or remove your Google account and kids profile account.

### Google Account

Google TV profiles let everyone in your home enjoy their own personalized space with their Google Account. With a personalized profile, you'll get TV show and movie recommendations just for you, easy access to your personal watchlist and help from your Google Assistant.

**Add Google account** ➡️ **p.36**

### Kids Accounts

**Kids profile (parental control)** ➡️ **p.42**

### Other Accounts

You can use other accounts within Google apps like YouTube, but you won't see recommendations for those accounts on the Google TV home screen. Privacy settings, such as location, that are applicable to the use of the device can be adjusted under Settings > Privacy.

## Google Account

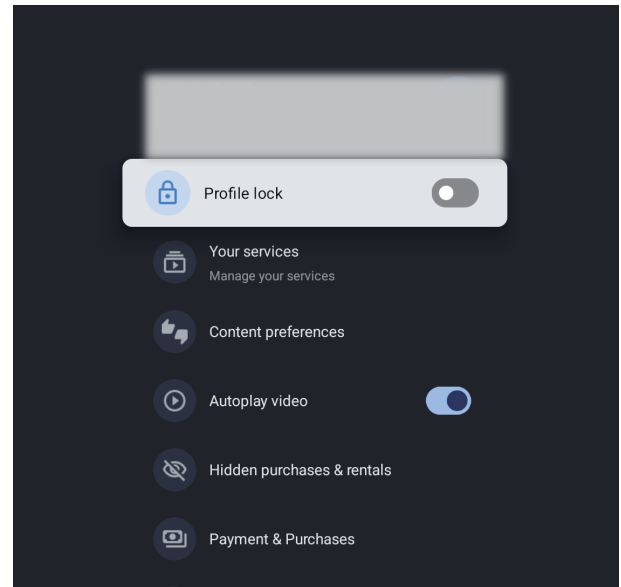

### Profile Lock

Turn this on to protect your settings. When on, you'll need to authenticate to view or change any account settings.

### Your services

If you subscribe to streaming services, you can add them to your Google TV device or app. When you add services to your account, you get more recommendations on what to watch for those services. If a service offers multiple subscription options, to get accurate recommendations, you'll need to link that service to your Google Account.

- 1 Scroll right and turn each service on or off.
- 2 To save the selection and exit the screen, scroll left.

### Content preferences

To get recommendations that are more relevant to you, there are a few things you can do.

**Important:** These options aren't available for all shows and movies on every streaming service.

- 1 Rate the suggestions.
- 2 To exit, on your remote, press **🏠 (HOME)** or **← (BACK)**.

### Autoplay video

Automatically play video trailers for shows and movies.

### Hidden purchases & rentals

Hide a specific movie or show in your library. Press and hold the title then select Hide.

---

## Payment & Purchases

Manage your account and purchases through the Play Store app on your mobile device, or by following these links in a Web browser.

---

## Google Assistant

**Personal results:** Some Google Assistant devices, like speakers, Smart Displays, Smart Clocks, TVs, and the Pixel Stand, can be shared with multiple people. For any shared device, you can turn on personal results to allow the Google Assistant to read or show results specific to you. For example, the Google Assistant may show:

- Results from your Gmail, Google Calendar, and Google Photos
- Recommendations for recipes based on your activity across other Google products
- YouTube Music personal playlists, liked songs, uploads, or library content

**Important:** The personal results setting doesn't control certain Assistant features provided by third parties like Spotify or Pandora.

On the Pixel Stand, some apps require you to unlock your phone even if you have personal results turned on.

**SafeSearch filter:** Whether you use Google Search at work, with children, or for yourself, SafeSearch can help you filter explicit content from your results. Explicit results include sexually explicit content like pornography, violence, and gore.

---

## Google Home

Provide a quick and easy access to smart home devices with Google Home. To use this feature, please add your TV and compatible devices to the Google Home app.

---

## Apps only mode

Want to remove content recommendations on your home screen to simplify your Google TV experience? Turn on "Apps Only Mode" to display only your favorite installed apps.

---

## Remove

Removing this account will delete all the related data from your device including associated kids accounts.

## Privacy

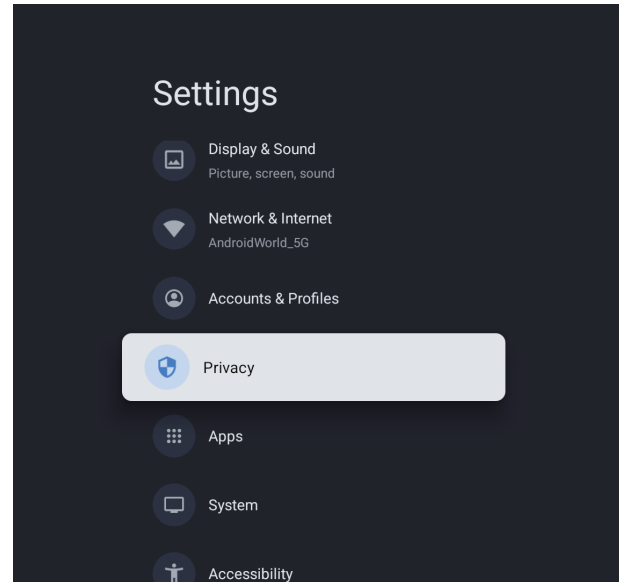

1 Press **⚙️ (DASHBOARD)** button to open the Google TV dashboard menu, then select "All settings" and press **OK** button to enter it.

2 Go to Privacy

This section is privacy settings of your TV, Google account and applications.

---

## Location

- Google may collect location data periodically and use this data in an anonymous way to improve location accuracy and location-based services.

---

## Microphone

- Turn on or turn off microphone access for **all** apps and services.
- Turn on or turn off microphone access on your remote control.
- Allow or deny apps and services to use the microphone.
- Show the apps that recently use the microphone.

---

## Camera

- Turn on or turn off camera access for **all** apps and services.
- Allow or deny apps and services to use the camera.
- Show the apps that recently use the camera.

---

## Usage & diagnostics

- Automatically send diagnostic information to Google, like crash reports and usage data from your device, apps, and Google Cast. You can adjust these permissions at any time from device settings.

---

## Ads

- Manage your ads settings, such as resetting your advertising ID.

---

## Google Assistant **➡** p. 46

---

## Payment & Purchases

- Manage your account and purchases through the Play Store app on your mobile device, or by following these links in a Web browser:
    - Payment methods [g.co/ManageWallet](https://g.co/ManageWallet)
    - Order history [g.co/Play/Orders](https://g.co/Play/Orders)
    - Subscriptions [g.co/Play/Subscriptions](https://g.co/Play/Subscriptions)
- 

## Manage Updates

- Turn on or turn off Auto-update apps.
  - Check and update all available updates.
- 

## App Permissions

Allow or deny apps to use basic functions.

---

## Special app access

Allow or deny apps to use special functions.

---

## Security

- Select whether or not to scan apps with Play Protect, which can scan this device and warn you about harmful apps.
  - Select whether or not to send unknown apps to Google for better detection.
- 

# Apps

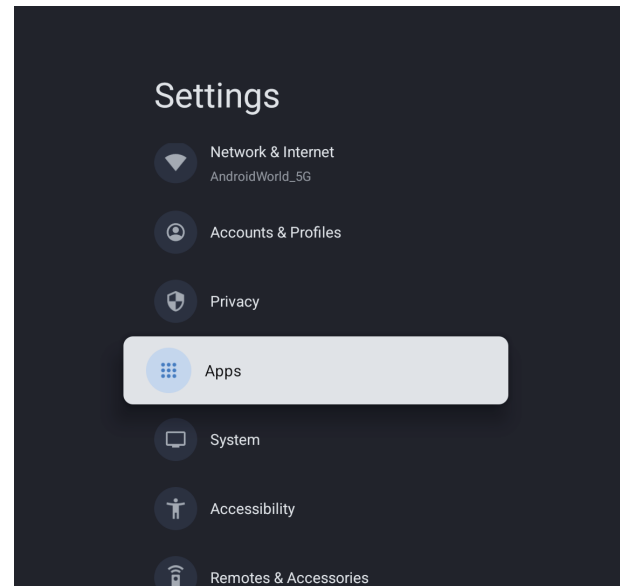

- 1 Press **⚙️ (DASHBOARD)** button to open the Google TV dashboard menu, then select "All settings" and press **OK** button to enter it.

- 2 Go to Apps

This section is apps settings, such as checking details and permissions.

---

## Add more apps

Search to install more apps in apps market.

---

## See all apps

Check all installed apps or system apps.

---

## Unused apps

Show unused apps. If an app is unused for long time, permissions are removed to protect your data, and temporary files are removed to free up space.

---

## Manage updates

- Turn on or turn off auto-update apps.
  - Check and update all available updates.
- 

## App Permissions

Allow or deny apps to use basic functions.

---

## Special app access

Allow or deny apps to use special functions.

---

## Security

- Select whether or not to scan apps with Play Protect, which can scan this device and warn you about harmful apps.
- Select whether or not to send unknown apps to Google for better detection.

## System

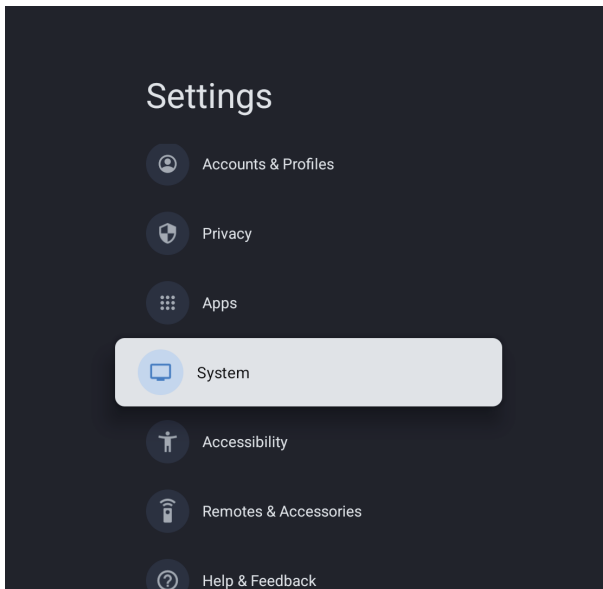

1 Press **⚙️ (DASHBOARD)** button to open the Google TV dashboard menu, then select "All settings" and press **OK** button to enter it.

2 Go to System

This section is system settings, such as setting language, date & time.

---

### Ambient Screensaver

Setup detailed settings to show ambient screensaver as you need.

---

### Power & Energy

Setup energy mode to save the power consumption.  
Setup the timers turn on or turn off the TV set automatically.

---

### About

You can check system update and TV registration information.

---

### System update

Check for update

---

### Device name

Naming your television will help you identify it and distinguish it from other devices for casting. Example: "Living Room TV"

---

### Reset

This will restore your device to default settings and erase all data, accounts, files, and downloaded apps.

---

### Status

Network, serial numbers and other information

---

### Legal information

Confirm legal information.

---

### Model

Confirm Model

---

### Android TV OS version

Smart TV operating system number

---

### Android TV OS security patch level

Confirm Android security patch level

---

### Kernel version

Confirm Kernel version

---

### Android TV OS Build

Show the OS build information.

---

### Netflix ESN

Confirm Netflix ESN

---

### Software Version

Show the software version of your Google TV set.

---

### TV Life Time

Show TV life time.

---

## Date & Time

### Automatic date & time

Use network-provided time or off

If it is set to off, please manually set the date and time.

### Set date

### Set time

### Set time zone

Select your time zone

### Use 24-hour format

Set the time to display in a 12 or 24-hour format

---

## Language

You can set the language for the on-screen display.

---

## Keyboard

Perform the keyboard setting.

## Storage

Internal shared storage  
Free up storage

## Cast

Cast to Google TV

You can cast content from phones, tablets, or laptops to your Google TV.

Cast to Google TV → p. 45

## System sounds

Turn on or turn off the system sounds.

## Restart

It just makes the TV turn off and again on. Your all settings will be kept. If you want to delete all settings of the TV, please do factory reset.

**Settings > System > About > Reset > Factory reset**

\* This will restore your device to default settings and erase all data, accounts, files, and downloaded apps.

## Accessibility

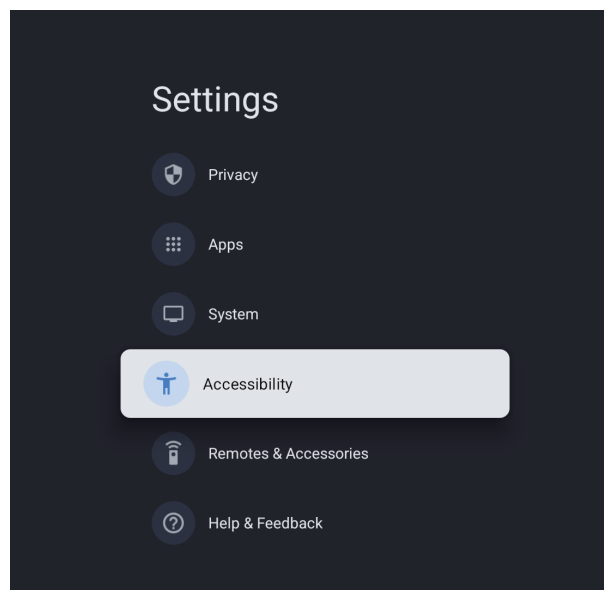

You can use a screen reader, closed captions, Switch Access, and more to make your Google TV device more accessible.

- 1 Press **⚙️ (DASHBOARD)** button to open the Google TV dashboard menu, then select "All settings" and press **OK** button to enter it.
- 2 Use **▲▼** to select **Accessibility**, then press **OK**.
- 3 Adjust the following items.

### TalkBack

TalkBack is the Google screen reader included on Android devices. TalkBack gives you spoken feedback so that you can use your device without looking at the screen.

#### Change screen reader settings

- 1 Press **⚙️ (DASHBOARD)** button to open the Google TV dashboard menu, then select "All settings" and press **OK** button to enter it.
- 2 Select **Accessibility**.
- 3 Select **Talkback(Screen reader) > Configuration**.
- 4 Change settings for speech volume, verbosity (such as keyboard echo and usage hints), and so on.

#### Use a screen reader

- 1 Press **⚙️ (DASHBOARD)** button to open the Google TV dashboard menu, then select "All settings" and press **OK** button to enter it.
- 2 Select **Accessibility**.
- 3 Select **Talkback(Screen reader) > Enable > OK**.

---

## Text to speech

Text to speech output settings.

---

## Text scaling

Select the text scaling ratio as you need.

---

## Bold text

Turn on or turn off the bold text.

---

## Color correction

Turn on or turn off the color correction function.  
Select the desired color mode.

---

## Use accessibility shortcut

Accessibility shortcuts are a quick way to turn on accessibility features. To use accessibility shortcuts, you first need to turn them on.

To turn on accessibility shortcuts:

- 1 Press **⚙️ (DASHBOARD)** button to open the Google TV dashboard menu, then select "All settings" and press **OK** button to enter it.
- 2 Select Accessibility.
- 3 Select Accessibility shortcut > Enable accessibility shortcut.
- 4 By default, the shortcut turns on TalkBack. To change what's included in the shortcut, choose Shortcut service.
- 5 Choose an option and select OK.

To use the shortcut:

On your remote, press and hold the back arrow and down buttons at the same time for 3 seconds.

---

## Keyboard accessibility

Setup time duration of messages that require action.  
Adjust the delay before key repeat.

---

## Turn on Switch Access

- 1 Press **⚙️ (DASHBOARD)** button to open the Google TV dashboard menu, then select "All settings" and press **OK** button to enter it.
  - 2 Select Accessibility.
  - 3 Select Switch Access > Enable > OK.
- 

## Audio Description

Turn on or turn off the function of audio description to help visually-impaired viewers understand and enjoy the TV program.

## How Switch Access works

Switch Access scans the items on your screen, highlighting each item in turn, until you make a selection.

To use Switch Access, you'll first need one or more switches. There are several kinds of switches:

- Use an external switch: A switch is a device that sends a keystroke signal to your Android device. Several companies sell these devices, such as AbleNet, Enabling Devices, RJ Cooper, and Tecla. These devices connect to your Android device via USB or Bluetooth. (Neither Google nor Philips nor Funai endorse these companies or their products.)
  - Use an external keyboard: You can configure a standard USB or Bluetooth keyboard to work as a switch device by assigning one or more of its keys to actions.
  - Use buttons on your Android device: Built-in buttons on your Android device, such as the volume up and volume down buttons, can also be assigned to actions. This option is intended for developers.
- 

## Turn on closed captions

Your caption preferences might not apply to certain apps.

- 1 Press **⚙️ (DASHBOARD)** button to open the Google TV dashboard menu, then select "All settings" and press **OK** button to enter it.
- 2 Select Accessibility > Captions.
- 3 Turn on Picture to show captions. Then choose your options.

<b>Picture</b>	Off	Closed caption is not displayed.
	On	Closed caption is always displayed.

You can choose the size, font, color, background, and other characteristics of the caption text.

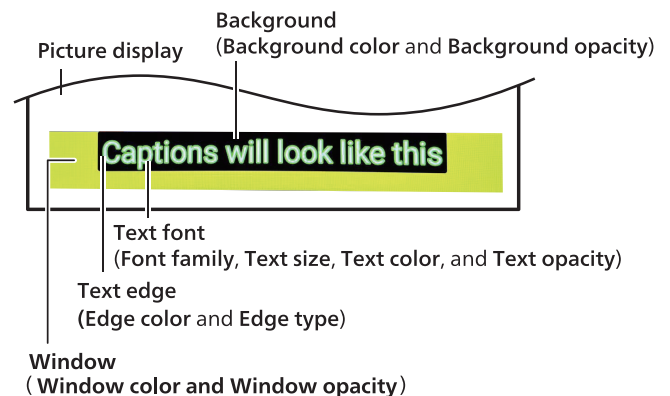



---

## Turn on high contrast text

- 1 Press **⚙️ (DASHBOARD)** button to open the Google TV dashboard menu, then select "All settings" and press **OK** button to enter it.
- 2 Select Accessibility.
- 3 Turn on High contrast text (Experimental).

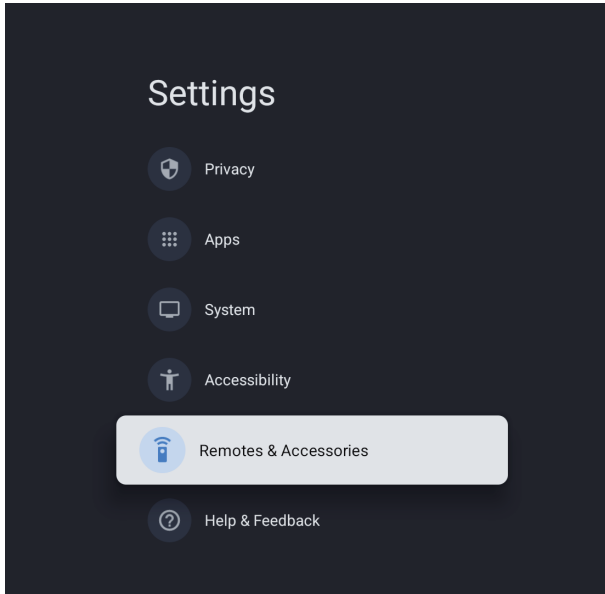
## Remotes & Accessories



You can connect several Bluetooth devices, like headphones or game controllers, to your Google TV. You can only connect one audio device at a time.

### Pair a Bluetooth device

- 1 Press **⚙️ (DASHBOARD)** button to open the Google TV dashboard menu, then select "All settings" and press **OK** button to enter it.
- 2 Select Remote & Accessories > Pair accessory.
- 3 Make sure your device is in pairing mode or is visible to other devices.
- 4 Identify the device you want to pair from the list and select it.
- 5 On the Bluetooth pairing request screen, select Pair.

#### ☰ Note(s)

Accessories that have been paired with your device appear in the Remote & Accessories section of Settings. You can also rename or forget devices.

### Reconnect a paired device

- 1 Press **⚙️ (DASHBOARD)** button to open the Google TV dashboard menu, then select "All settings" and press **OK** button to enter it.
- 2 Select Remote & Accessories.
- 3 Under "ACCESSORIES" choose your device.
- 4 Select Connect.

## Fix problems with connecting Bluetooth devices

If your Bluetooth device won't connect, it could be an issue with the Bluetooth device or your TV.

### Troubleshoot connection issues

- 1 Turn off your Bluetooth device and then turn it back on. After your device is reset, try to pair it again.
- 2 If you have multiple devices paired with your TV, disconnect the ones you're not using.
- 3 Unplug your TV for 10 seconds and then plug it back in. When your TV is on, try to pair it again.
- 4 Check if your Bluetooth device connects to other devices, such as a phone or tablet.
  - A. If your device connects to other devices: Reset your Google TV device to factory settings.
  - B. If your device doesn't connect to other devices: Check that your Bluetooth device has up-to-date software or get help from the device's manufacturer.

## Help & Feedback

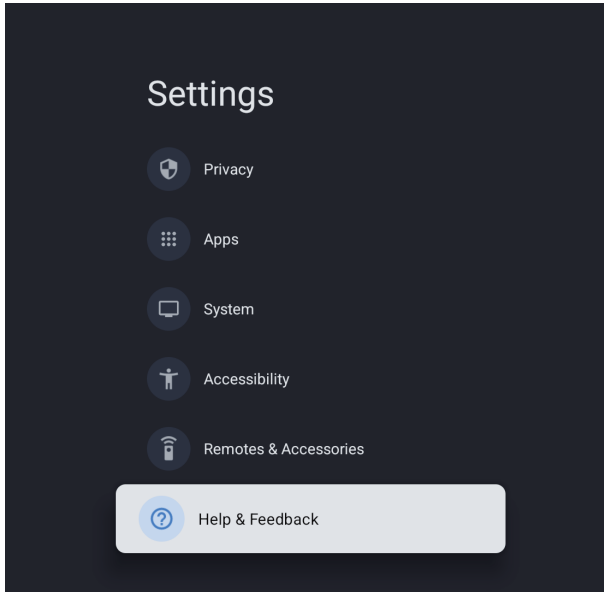

---

### Send feedback

Leave product feedback or share your ideas

---

### Help

Philips support app assisting you with trouble shooting.  
Visit Google TV Help at [g.co/tv/help](https://g.co/tv/help).

# 5 Enhance your Google TV

## Home menu

Google TV is TV personalized for you. Easily browse content from across your favorite apps and services, with specially curated recommendations based on your interests.

What you find on the Google TV home screen depends on where you live and the language you choose for your device.

- If you use a Google TV device in a country other than the one where you purchased it, your experience may vary.
- In some regions or territories, your experience may vary.

If you choose English, French, or Spanish as your language, you'll find these tabs:

- 1 Account**  
Switch to another account, add a new account or manage accounts.
  - 2 For you**  
Google TV home screen aggregates the best content from user's services.
  - 3 Live tab (U.S. only)**  
See what's live on TV across different service providers in one menu. To watch live TV, download an app from your TV service provider (if available). This service is available only in the U.S.
- Movies and Shows tab (Outside U.S.)**  
Discover new movies and shows with suggestions based on what you have watched and what interests you.
- 4 Apps tab**  
Access your installed apps library or find new ones based on what you use or download.
  - 5 Library tab**  
Find movies and TV shows you've added in your Watchlist or rented through the Google TV store or YouTube.
  - 6 Search**  
Search movies, shows, apps, and more.
  - 7 Dashboard**  
Google TV dashboard provides a single location for users to access settings, notifications, and kids mode.

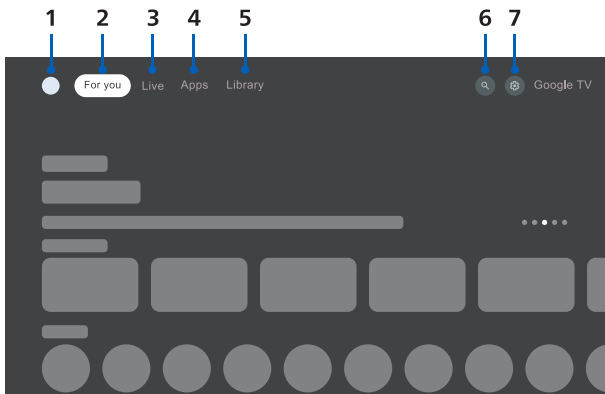

If you choose a different language or other countries, you'll find these tabs:

- Home
- Apps
- Library

## Add Google account

You can add more than one account on your Google TV so you can sign in to services with multiple accounts. Your media and activity sync across devices that your Google Account is signed in to.

## Sign in or add an account

Important: If you use an enterprise account, like one for work or school, some services might not work. For more information, contact your organization's administrator.

- 1 Press **⚙️ (DASHBOARD)** button to open the Google TV dashboard menu, then select "All settings" and press **OK** button to enter it.
- 2 Go to Accounts & Profiles and select Add an account.
- 3 Sign in to the Google Account you want to add.

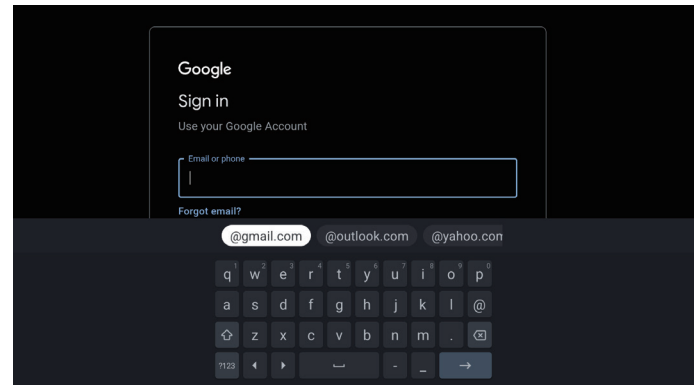
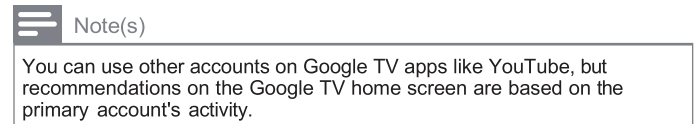

## Remove or manage accounts

- 1 Press **⚙️ (DASHBOARD)** button to open the Google TV dashboard menu, then select "All settings" and press **OK** button to enter it.
- 2 Go to Accounts & Profiles and select the profile you want to remove.
- 3 Select Remove > Remove account.



## Remove your account if you can't use your TV screen

- 1 On a phone or computer, go to your device in your Google Account.
- 2 Make sure you're signed in to the same account as on your Google TV device.
- 3 Choose the Google TV device you want to remove your account from.
- 4 Select Sign out.

## Installing apps

You can install apps on your Google TV for your streaming services and other entertainment providers.

### Search for an app

- 1 Press and hold the  Assistant button on your remote or select  Search on the home screen.
- 2 Say or type the name of the app you want to install.
- 3 If the app is available, a page will appear with the app.
- 4 Select Install.

### Browse for apps

- 1 From the Google TV home screen, at the top, scroll to Apps.
- 2 To browse for apps, move up or down to find different categories. When you find a category you're interested in, move to the right to find items. You can also select a category from the "App categories" section.
  - To find apps you already use, scroll down to "Apps from my other devices."
- 3 Select the app or game you want.
- 4 To install the app or complete your purchase, follow the on-screen instructions.

#### Note(s)

- If you have trouble with your purchase, try a different payment method, like a credit card or PayPal.

### Remove apps

- 1 From the Google TV home screen, scroll to Apps.
- 2 Scroll down to the "Your apps" section and find the app you want to uninstall.
- 3 Hold the "OK" button on your remote until a menu appears.
- 4 Select View details > Uninstall.

## Personalized recommendation

To get recommendations that are more relevant to you, there are a few things that you can do.

Important: These options aren't available for all shows and movies on every streaming service.



### Add your streaming services

Important: When you add streaming services on Google TV, you'll get more recommendations from those services. We recommend that you only select services that you subscribe to.

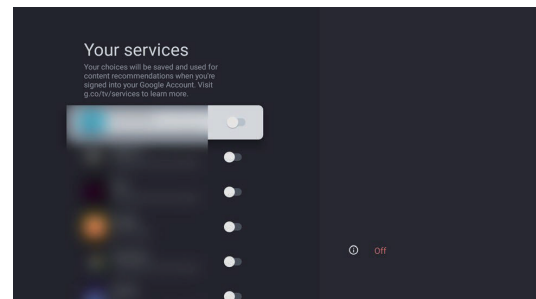
- 1 Press  (**DASHBOARD**) button to open the Google TV dashboard menu, then select "All settings" and press **OK** button to enter it.
- 2 Select **Accounts & sign-in**.
- 3 Select your account > Your services.
- 4 To add your services, scroll right and turn on each service.
- 5 To save the selection and exit the screen, scroll left.



### Tell us what you like to watch

- 1 Press  (**DASHBOARD**) button to open the Google TV dashboard menu, then select "All settings" and press **OK** button to enter it.
- 2 Select **Accounts & sign-in**.
- 3 Select your account > Content preferences.
- 4 Rate the suggestions.
- 5 To exit, on your remote, press  (**HOME**) or  (**BACK**).

## Manage your watchlist

**Important:** Google uses the shows and movies on your watchlist to learn what you like to watch. You'll get recommendations for content that's similar to the titles on your watchlist.

- 1 Search or browse for the title that you want to add to your watchlist.
- 2 Open the title's details page.
- 3 Select + Add to Watchlist.

### Note(s)

- When you add something to your watchlist, it's on the watchlist of all your devices logged in to the same account.

## Mark what you've watched

- 1 Search or browse for a movie or show that you've seen before.
- 2 Open the title's details page.
- 3 Select Watched it?  
For example, if you saw a movie in cinemas, you can mark 'Watched it'. Then, Google will recommend other movies and shows based on what you watched.

## Rate movies and shows

- 1 On your Google TV, search or browse for a movie or show.
- 2 Open the title's details page.
- 3 Scroll right and choose 'Like' 👍 or 'Dislike' 👎.

## Hide recommendations

If you want to hide personalized recommendations on Google TV, you can turn on Apps only mode. For example, when you have guests, you can use Apps only mode to hide your personalized recommendations.

## Turn on Apps only mode

- 1 Press **⚙️ (DASHBOARD)** button to open the Google TV dashboard menu, then select "All settings" and press **OK** button to enter it.
- 2 Select **Accounts & sign-in**.
- 3 Select the primary Google TV account.
- 4 Select **Apps only mode > (on/off toggle) > Turn on**.
- 5 To browse in Apps only mode, on your remote, select **🏠 (HOME)**.

## Exit Apps only mode

- 1 Press **⚙️ (DASHBOARD)** button to open the Google TV dashboard menu, then select "All settings" and press **OK** button to enter it.
- 2 Select **Accounts & sign-in**.
- 3 Select the primary Google TV account.
- 4 Turn off **Apps only mode**.

## Watch your movies & shows in Apps only mode

You won't find your Library on your TV's home screen, but you can find it in the YouTube app: 

- 1 On your TV, open the YouTube app.
- 2 Go to **Library > Purchases**.

### Note(s)

You can also cast content from your phone to your TV.

## What happens when Apps only mode is on

In Apps only mode, you don't get personalized recommendations on your home screen. You'll find a list of installed apps that you can open to find something to watch. You'll also find sponsored content and teasers for popular movies and shows.

If Web & App Activity is on, Google TV will continue to improve recommendations for you, even while Apps only mode is on. In addition, apps can still show you their personalized recommendations based on your history. This includes YouTube, YouTube TV, and other Google apps.

Some features aren't available in Apps only mode. For example:

- You can't use Search or the Google Assistant.
- You can't "like" or "dislike" content, add videos to your Watchlist, or mark videos as watched.

### Note(s)

Privacy settings such as location don't change. To change privacy settings, on your Google TV, go to **Settings > Privacy**.

## Basic TV mode

You can only use basic TV on TVs that come with Google TV built in.

If you choose basic TV when you set up your Google TV device, you can:

- Finish setup faster
- Use your device without a Google Account
- Use your device without an internet connection
- Without an internet connection, your device won't get important security updates.

\* Some features aren't available in basic TV.

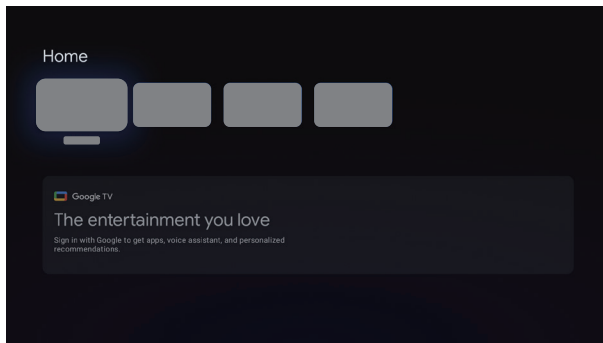

Basic mode

## Switch from basic TV to Google TV

- 1 From the home screen, scroll to the Google TV banner.
- 2 Select Set up Google TV.
- 3 Follow the on-screen instructions to set up with the Home app or your remote.

### Note(s)

- If you already set up Google TV, you can't switch to basic TV. To start setup again, you can factory reset your device.

## What you can do in basic TV

- Watch TV through your cable service, satellite, TV tuner, or antenna with the TV app
- Play media from other inputs plugged into the TV
- Use a limited set of apps that come pre-installed on your device

## What you can't do in basic TV

- Use services and features that require you to sign in to your Google Account
- Access your Play Library
- Install apps
- Use the Assistant to search for content
- Cast content from another device

## Live TV/EPG

You can watch not only the broadcasting programs through integrated TV tuner but also from internet based service providers like Pluto TV, YouTube TV, Sling TV, Philo.

The Favorite channels help reduce the option set based on your interest, leading to more rapid decision making. You can add your own favorite channels and show them on Program Guide section of Live TV tab.

To set up TV channels, go to **Add channels** → p.24

## Program Guide

To view the latest TV program schedule, press GUIDE on your remote.

## Live TV from broadcasting

On the Google TV home screen, select Live TV in your apps.

### Note(s)

- Broadcast in Live TV is only compatible with antenna. To watch your TV from cable set-top box, press (SOURCE) button to choose external device.

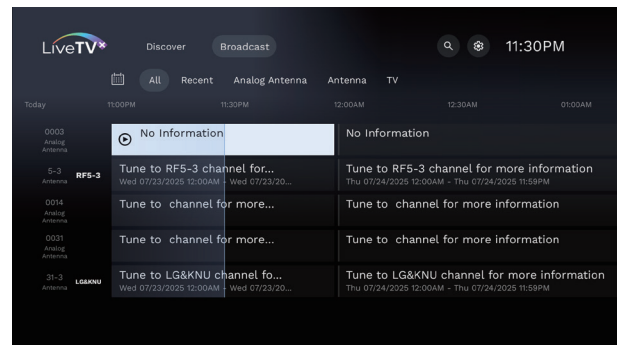

## Choose your favorite channels

- 1 In Live TV, go to the Broadcast.
- 2 In "All" channels view, find a program you want to set as one of your favorites.
- 3 Navigate to the program name and long press **OK** button for about 3 seconds, then release it, and options will show up. Select "Add to favorites".
- 4 To browse what is playing on your favorite channels, switch from "All" view to the "Favourite 1/2/3/4/5" view.

### Note(s)

To remove a channel from your favourite lists, navigate to the program name and long press **OK** button for about 3 seconds, then release it, and options will show up. Select "Edit favourites". Press **OK** button to enter it and select the highlighted favourite list then press **OK** button. The tick will disappear and the selected program will be removed from the favourite list.

## Program guide

To view the latest TV program schedule, press  **GUIDE** on your remote.

Program guide may contain 3rd party streaming program such as YouTube TV, Pluto TV.

## Live TV from streaming providers

On the Google TV home screen, select Live TV in your apps.

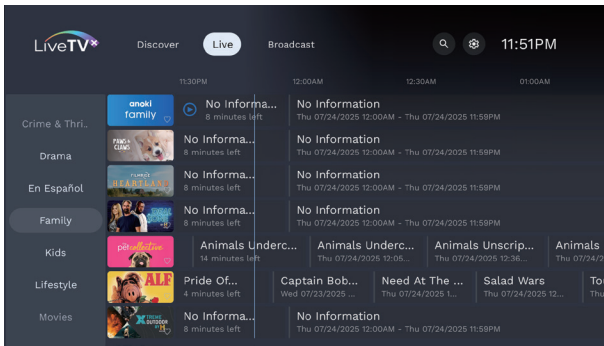

## Pluto TV

Live TV channels are available at no charge from Pluto TV. You can browse Pluto TV channels in the Live tab, your recommendations, and search results. To watch Pluto TV channels, you must install the Pluto TV app.

## YouTube TV

On your Google TV, make sure the primary account is the same one you use for your YouTube TV subscription. If they're not the same, you can:

- Change the primary account on Google TV.
- Change your YouTube TV subscription to use your primary account.
- Use Google Families to link the 2 accounts.

### Note(s)

- If you select YouTube TV as one of your streaming services, you may get YouTube TV recommendations in Google TV.

## Sling TV

- 1 Download the Sling TV app.
- 2 Link Sling TV to your Google Account.

## Philo

- 1 Download the Philo app.
- 2 Add Philo to your list of services.

## Live TV Settings --- Live

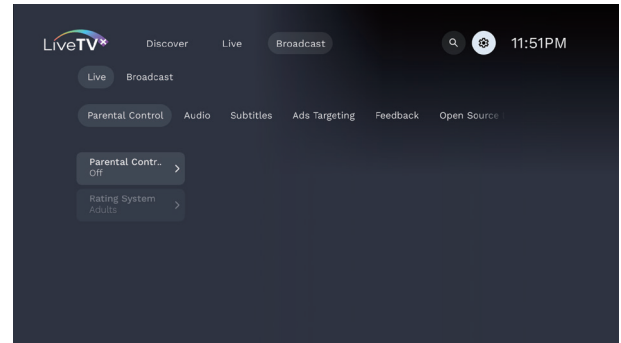

### Parental Control

- Enter Google PIN when you start parental settings.
- Turn on or turn off Parental Control system.
- Select rating system.

### Audio

Setup the audio language.

### Subtitles

Setup the subtitle language.

### Ads Targeting

Turn on or turn off the ads targeting function.

### Feedback

Send feedback about the Live TV experience.

### Open Source Licences

Show the list of open source licences.

### Terms of Sevice

Learn more about the Terms of Service and Privacy Policy that apply when you use the Live TV app.

## Live TV Settings --- Broadcast

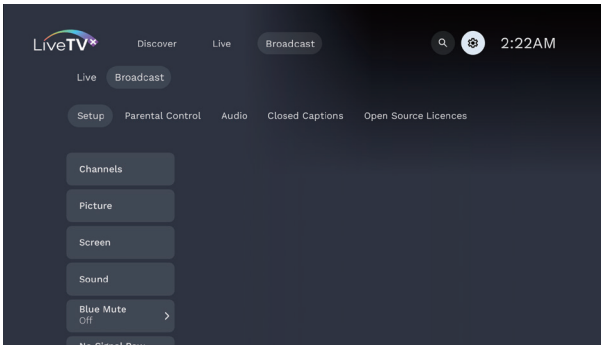

### Setup

- Search for available channels automatically.
- Adjust picture settings including brightness and so on.
- Select the aspect ratio.
- Adjust sound settings including sound mode and so on.
- Turn on or turn off blue mute function.
- Setup a timer to turn off the TV set automatically when there is no signal during the designated period of time.

### Parental Control

- Enter your Google PIN when you start parental settings.
- Turn on or turn off the parental control system.
- Setup a restriction on unauthorized access to specific channels.
- Setup a restriction on unauthorized access to specific programs by selecting the rating type in Rating System, Rating Lock or RRT5 Lock.

### Audio

- Setup the preferred audio language.
- Turn on or turn off the audio description function to help visually-impaired viewers understand and enjoy the program.
- Turn on or turn off the hearing impaired function to help hearing-impaired viewers understand and enjoy the program.

### Closed Captions

- Turn on or turn off CC tracks.
- Select the mode of caption service.
- Select advanced mode of caption service.
- Setup the text size of the closed caption.
- Select the text font.
- Setup the text colour.
- Setup the text opacity.
- Setup the edge type.
- Setup the edge colour.
- Setup the background colour.
- Setup the background opacity.

### Note(s)

- Caption service that you can switch differs depending on the broadcast description.
- Closed captioning service may not be controlled by this unit's menu options if you are watching television through an external cable or satellite set-top box. In which case you will need to use the menu options on the external set-top box to control closed captioning.
- The captions do not always use correct spelling and grammar.
- Not all TV programs and product commercials include closed caption information. Refer to your area TV program listings for the TV channels and times of closed caption shows. The captioned programs are usually noted in the TV listings with service marks such as CC.
- Not all captioning services are used by a TV channel during the transmission of a closed caption program.
- Closed caption will NOT be displayed when you are using an HDMI or a component connection.
- To show the closed caption on your TV screen, broadcast signal must contain the closed caption data.
- Not all TV programs and commercials have the closed caption or all types of the closed caption.
- Caption's and text may not exactly match the TV voice.
- Changing channels may delay the closed caption for a few seconds.
- Adjusting or muting the volume may delay the closed caption for a few seconds.
- Abbreviations, symbols, and other grammatical shortcuts may be used in order to keep pace with the on-screen action. This is not a malfunction.
- The caption or text characters will not be displayed while the Main menu or functions display is shown.
- If a black box appears on the TV screen, this means that the closed caption is set to the text mode. To clear the box, select CC-1, CC-2, CC-3, or CC-4.
- If the unit receives poor quality television signals, the captions may contain errors or there might be no captions at all. Some possible causes of poor quality signals are:
  - Automobile ignition noise
  - Electric motor noise
  - Weak signal reception
  - Multiplex signal reception (ghosts or screen flutter)
  - Data dropout and pixelation (for DTV only)
- The unit retains the closed caption setting if the power fails.
- When the unit receives special effects playback signal (e.g. search, slow and still) from a VCR's video output channel (ch3 or ch4), the unit may not display the correct caption or text.
- The EUT setting that satisfies § 79.102 (e) is as follows:
  - Font: Mono-font
  - Character size: Large

### Open Source Licences

Show the list of open source licences.

## Kids profile (parental control)

Set up a kids profile on Google TV to choose which apps your kids can use, and to set up bedtime reminders and screen time limits.

\* Kids profiles may not be available in some regions or on some devices.

### Add a kids profile

- 1 Press **⚙️ (DASHBOARD)** button to open the Google TV dashboard menu, then select "All settings" and press **OK** button to enter it.
- 2 Under "Accounts & sign-in" select Add a kid > Get started.
- 3 Under "Welcome parents" select Get started.
- 4 Select an option:
  - If your child has a Google Account or kids profile in your family group: Select the child you want to set up.
  - If you haven't set up a child in your family group: Select Add a kid and follow the on-screen instructions.
- 5 Choose the apps you want to include in the kid's home screen.
- 6 To set up parental controls, follow the on-screen instructions.

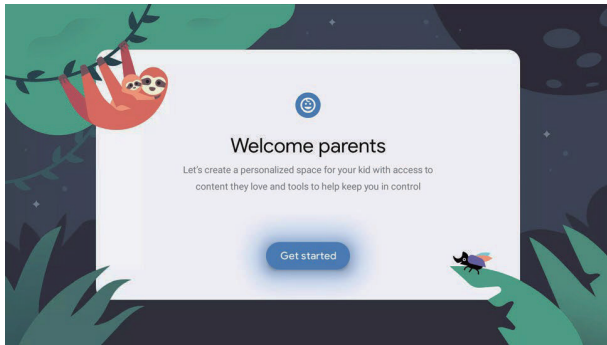

### Switch to a kids profile

- 1 Press **⚙️ (DASHBOARD)** button to open the Google TV dashboard menu, then select "All settings" and press **OK** button to enter it.
- 2 Select the kid's profile.

### Set up a profile lock

Important: With a profile lock, you have to enter the adult's Google Account PIN or password to exit a kids profile. This is the same PIN or password that you use for Google Pay and other Google services.

- 1 Press **⚙️ (DASHBOARD)** button to open the Google TV dashboard menu, then select "All settings" and press **OK** button to enter it.
- 2 Go to **Accounts & sign-in** and select your kid's profile.
- 3 Select Profile lock and enter your Google Account PIN or password.
- 4 To turn on "Profile lock".

## Allow or block content or apps

### Allow or hide apps

- 1 Press **⚙️ (DASHBOARD)** button to open the Google TV dashboard menu, then select "All settings" and press **OK** button to enter it.
- 2 Go to Accounts & Profiles and select your kid's profile.
- 3 Select Manage apps.
  - To allow apps: Next to the app, check the blue box. Apps are installed automatically.
  - To hide apps: Next to the app, uncheck the blue box.

### Allow or block content in your library based on rating

Important: This only works for content purchased from Google and shared with your kid. This setting doesn't apply in apps.

- 1 Press **⚙️ (DASHBOARD)** button to open the Google TV dashboard menu, then select "All settings" and press **OK** button to enter it.
- 2 Go to Accounts & Profiles and select your kid's profile.
- 3 Select Family Library.
- 4 Set the maximum allowed rating for Movies and TV.

### Set a daily screen time limit

- 1 Press **⚙️ (DASHBOARD)** button to open the Google TV dashboard menu, then select "All settings" and press **OK** button to enter it.
- 2 Go to **Accounts & sign-in** and select your kid's profile.
- 3 Select Screen time and then Daily limit.
- 4 Select the days you'd like to schedule a daily limit.
- 5 Choose how many hours your kid can watch TV each day.
  - You can set limits in intervals of 15 minutes, up to 8 hours.

### Set a daily bedtime

- 1 Press **⚙️ (DASHBOARD)** button to open the Google TV dashboard menu, then select "All settings" and press **OK** button to enter it.
- 2 To select the kid's profile, go to Accounts & Profiles.
- 3 Select Screen time and then Bedtime.
- 4 Select the days you'd like to schedule a bedtime.
- 5 Select when your kid's TV time should start and end.
  - Times are available in intervals of 30 minutes.

## Add bonus time

When the daily watch time for your kid ends, you can add bonus time:

- 1 From the timeout screen, select **More time** and enter your Google Account PIN or password.
- 2 Select how much bonus time to add.
  - You can add bonus time in intervals of 15 minutes, up to 8 hours.
- 3 To confirm the bonus time, enter your Google Account PIN or password.

## Report inaccurate content ratings

- 1 From your child's profile, highlight the content with the inaccurate rating.
- 2 On your remote, hold the select button.
- 3 Select Report inaccurate rating.

## Hide library content

- 1 From your child's profile, highlight the content you want to hide.
- 2 On your remote, hold the select button.
- 3 Select Hide.

## Unhide library content

- 1 Press **⚙️ (DASHBOARD)** button to open the Google TV dashboard menu, then select "All settings" and press **OK** button to enter it.
- 2 Select **Accounts & Profiles** and then your kid's profile.
- 3 Select **Hidden movies & TV shows**.
- 4 Find and select the content you want to unhide.
- 5 Select **Show** to unhide the content.

## Parental Controls

You can restrict your children from watching certain programs or channels by setting parental controls using the parental control system.

1. Press **HOME (🏠)** button on remote control to enter the home screen of your Google TV.
2. Select the **Live TV** app in the list of your apps. Then press **BACK (←)** button to enter the **TV GUIDE**.
3. Move the cursor to the icon of **Live TV Settings** ⚙️, then press **DOWN** navigation button to select **Live** or **Broadcast**.
4. Press **DOWN** navigation button to select **Parental Control**.
5. In **Live**, Enter your **Google PIN > Parental Control (On) > Rating System/Change PIN**.
6. In **Broadcast**, Enter your **Google PIN > Parental Control (On) > Channel Block/Rating System/Rating Lock/RRT5 Lock**.
7. In **Live**, Select the rating type as you need in **Rating System**.
8. In **Broadcast**, Select the rating type as you need in **Rating System & Rating Lock & RRT5 Lock**.

### < Parental Control in Live >

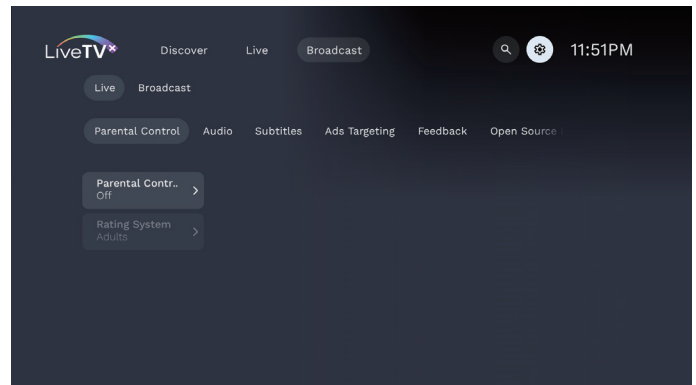

### < Parental Control in Broadcast >

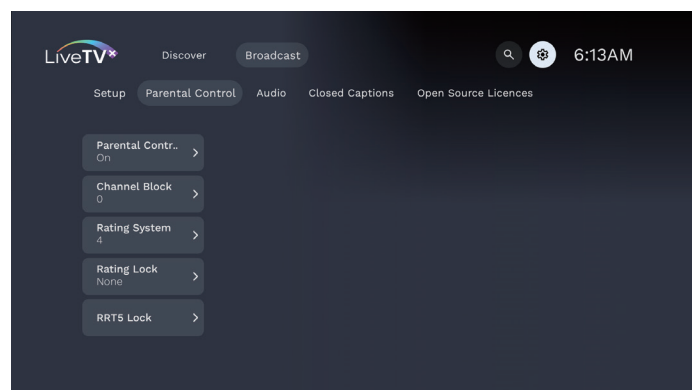

### ☰ Note(s)

When you enter the parental control system for the first time, you will be asked to setup your Google PIN. Your Google PIN will be needed every time when you enter the parental control system. If you forget your Google PIN, you can reset it by performing the factory reset by selecting **⚙️ (DASHBOARD)** button > **All settings > System > About > Reset > Factory reset**.

## Use Phone as remote/Watchlist

### Use your phone as your Google TV remote

You can use the Google TV app on your Android phone as the remote to navigate your Google TV.

The Google TV app is only available on Android phones in select countries.

With the virtual remote, you can:

- Navigate the TV screen
- Control media
- Turn the TV on or off
- Activate the Google Assistant
- Change the volume
- Enter text to perform searches or enter login information

### Set up your virtual remote

- 1 On your Android phone, open the Google TV app 
- 2 Near the bottom right, tap Remote
- 3 At the top, tap Scanning for devices.
- 4 Choose your device.
- 5 To complete pairing, follow the instructions on your phone and TV.
- 6 After pairing, you can use your phone or your remote.

### Fix problems with the Google TV virtual remote

Check your Wi-Fi connection

To use your phone as a remote, your phone and TV must be on the same Wi-Fi network.

To check or change the connection on your TV:

- 1 Press  (**DASHBOARD**) button to open the Google TV dashboard menu, then select "All settings" and press **OK** button to enter it.
- 2 Select Network & Internet.
- 3 Confirm that Wi-Fi is turned on and you're connected to the correct network.
  - If necessary, select the network you want to connect to.
  - If necessary, enter the password.

To check or change the connection on your phone:

- 1 On your phone, open the Settings app.
- 2 To find your network or choose a different network, tap Network & internet > Wi-Fi.

## Ambient mode (Digital Photo Frame)

### Change the screen saver

Google TV lets you set your TV to scroll through Google Photos when you're not watching anything.



You must be signed in to your Google account in order to set up and configure Ambient Mode.

With the ambient-mode cards, you can configure it to display information like sports scores, weather, and news based on your profile. The feature also provides on-screen shortcuts to let you launch photos or start playing music and podcasts with one click.

### Choose your screen saver

- 1 Press  (**DASHBOARD**) button to open the Google TV dashboard menu, then select "All settings" and press **OK** button to enter it.
- 2 Select System > Ambient Screensaver.
- 3 Choose what you want to show:
  - Google Photos: Choose photos or albums saved in your Google Photos account.
  - Art gallery: Choose featured photos, fine art, and more.
  - Custom AI Art: Use generative AI to create your own images.

### Choose which photos show

- 1 On your phone, open Google Home .
- 2 Select your TV.
- 3 On you Google TV, select  (**DASHBOARD**) button > All settings > System > Ambient Screensaver > Google Photos.

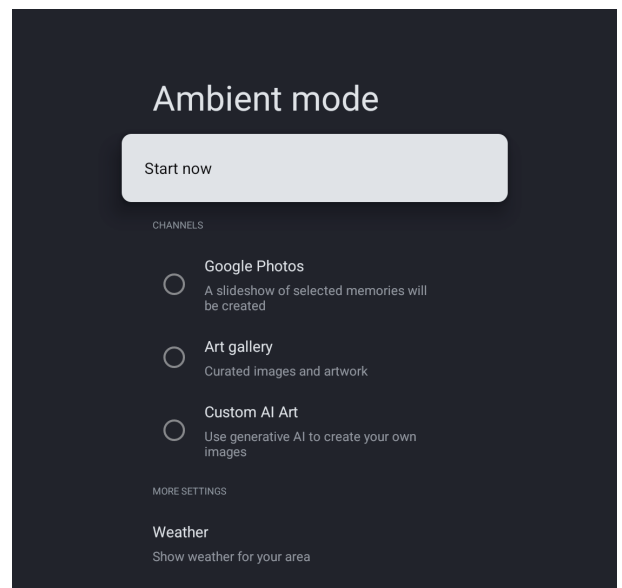

- 4 Select the photos or albums you want to show on your TV.

## Customise settings

- 1 Press **⚙️ (DASHBOARD)** button to open the Google TV dashboard menu, then select "All settings" and press **OK** button to enter it.
- 2 Select System > Ambient Screensaver.
- 3 Under "More settings", choose:
  - Personal photo data: Show or hide the owner's name and album name.
  - Portrait Google Photos: Choose if photos can show in portrait orientation.
  - Personal photo curation: Choose which albums are included.
  - Slideshow speed: Choose how long a photo stays on the screen.

## Show weather & time on your screen saver

- 1 Press **⚙️ (DASHBOARD)** button to open the Google TV dashboard menu, then select "All settings" and press **OK** button to enter it.
- 2 Select System > Ambient Screensaver.
- 3 Under "More settings", choose:
  - Weather: Choose °C, °F, or Both.
  - Time: Choose to show or hide the time.



## Cast to Google TV

### Cast to Google TV

You can cast content from phones, tablets, or laptops to your Google TV.

### Cast from a device to your TV

Important: You can only cast from the latest version of a Google Cast-enabled app or a Chrome browser on a device connected to the same Wi-Fi network as your Google TV.

- 1 Connect your device to the same Wi-Fi network as your Google TV.
- 2 Open the app that has the content you want to cast.
- 3 In the app, find and select Cast .
- 4 On your device, select the name of your TV.
- 5 When Cast  changes color, you're successfully connected.  
To stop casting, on your device, select Cast  > Disconnect.

### Fix problems with casting

If you can't cast on your Google TV, try the solutions below.

Make sure casting is enabled on your TV

- 1 Press **⚙️ (DASHBOARD)** button to open the Google TV dashboard menu, then select "All settings" and press **OK** button to enter it.
- 2 Select Apps > See all apps.
- 3 Find the app "Google Cast".  
If you can't find it, select Show system apps or check in the "Disabled apps" section.
- 4 Check that the app is enabled. If it's not, select Enable to turn it back on.
- 5 To reboot your device, select Settings > System > Restart.

### Connect your TV and device to the same Wi-Fi network

- 1 Press **⚙️ (DASHBOARD)** button to open the Google TV dashboard menu, then select "All settings" and press **OK** button to enter it.
- 2 Under Network & Internet, find the name of the Wi-Fi network your TV is connected to. Make sure it's the same as the network on the device you want to cast from.

### Update your TV

- 1 Press **⚙️ (DASHBOARD)** button to open the Google TV dashboard menu, then select "All settings" and press **OK** button to enter it.
- 2 Select System > About > System update.  
If an update is available, follow the on-screen instructions to install it.  
You need to connect to internet to update your TV.

## Google Assistant

### Do more with Google Assistant on Google TV

You can ask questions and complete tasks on your Google TV with Google Assistant. Google Assistant comes installed on your Google TV device. You can turn it on when you first set up your device, or you can turn it on later.

Google Assistant is not available in certain countries and languages.

### Talk to Google Assistant

Simply press and hold the Google Assistant button  on your remote as you ask a question or say a command to watch movies, open apps, set timer, check weather and more - using just your voice. To help Google Assistant understand your request, speak into the microphone on your remote.

### What you can ask Google Assistant

#### Watch videos

- ① Movies and TV shows: "Play The Mandalorian on Disney+."
- ② Video clips: "Play cat videos on YouTube."
- ③ Apps: "Open YouTube."
- ④ Search: "Search for sitcoms." "Find sci-fi movies."
- ⑤ Info: "Tell me about Game of Thrones."

#### Control media

- ① Playback: "Pause." "Stop." "Resume."
- ② Volume: "Louder." "Softer."

#### Control your smart home

- ① Lights: "Dim the living room lights."
- ② Thermostats: "Set the heat to 70." "Lower the temperature 2 degrees."

#### Plan your day

- ① Alarms: "Set an alarm for 7 AM."
- ② Reservations: "Make a reservation for 2 at [restaurant] on Friday."

### Ask Google

- ① Game updates: "Who won the Warriors game?"
- ② Calculations: "What's 20% of 80?"
- ③ Dictionary: "What does "gregarious" mean?"
- ④ Translations: "How do I say "Nice to meet you" in French?"
- ⑤ Finance: "How's the S&P 500 doing?"
- ⑥ Unit conversions: "How many kilometers in a mile?"
- ⑦ Search: "Search for summer vacation ideas."
- ⑧ Image search: "Find pictures of kittens."
- ⑨ Web answer: "How do you remove wine stains from a rug?"

### Have fun

- ① Get to know your Assistant: "Do you dream?" "What's your favorite color?"
- ② Games: "Let's play a game." "Give me a trivia question."
- ③ Entertainment: "Tell me a joke." "Tell me something interesting."



Note(s)

- For more ideas, ask Google Assistant, "What can you do?"

# USB camera for Google Meet

Google Meet is an app that provides simple, high-quality video calls right from your TV. To start calling with Google Meet, below items are required:

- 1 10 Mbps or faster internet access for video call.<sup>1</sup>
- 2 Google account<sup>2</sup>
- 3 External USB camera with a built-in mic which supports Android 11.0 and later.

For more details on how to get started, please visit <https://support.google.com/meet>

Google Meet is not pre-installed.



## How to connect USB camera

Connect a USB camera with a built-in mic directly into your Google TV before launching Google Meet. Below is an example of how to connect and place USB camera. After you launch Google Meet, follow onscreen instructions to setup and configure settings of Google Meet including access to camera and mic.

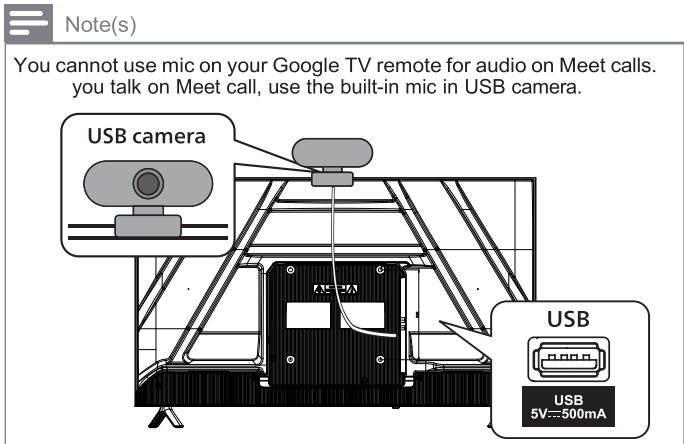

<p>Google Meet</p>	<p>USB camera does not work.</p>	<ul style="list-style-type: none"> <li>• Check if USB camera supports Android 11.0 or later. (May be listed on USB camera packaging or manufacturer's website)</li> <li>• Check if USB camera is connected to the TV.</li> <li>• Turn off the TV and disconnect/reconnect USB camera. Turn the TV back on and reopen the Meet app.</li> <li>• If issues remain, please visit the Meet support page and check the Troubleshoot section. (<a href="https://support.google.com/meet">https://support.google.com/meet</a>)</li> </ul>
	<p>Other party cannot hear anything. (My microphone does not work)</p>	<ul style="list-style-type: none"> <li>• Check if USB camera has a built-in mic and supports Android 11.0 or later. (May be listed on USB camera packaging or manufacturer's website)</li> <li>• Check if your microphone is muted. (Please unmute if so)</li> <li>• Check if USB camera is connected to the TV.</li> <li>• Turn off the TV and disconnect/reconnect USB camera. Turn the TV back on and reopen the Meet app.</li> <li>• If issues remain, please visit the Meet support page and check the Troubleshoot section. (<a href="https://support.google.com/meet">https://support.google.com/meet</a>)</li> </ul>
	<p>I cannot hear other party. (Speaker does not work)</p>	<ul style="list-style-type: none"> <li>• Check if the volume of the TV is muted or very low. (Please unmute or turn the volume up if so)</li> <li>• Check if USB camera is connected to the TV.</li> <li>• Turn off the TV and disconnect/reconnect USB camera. Turn the TV back on and reopen the Meet app.</li> <li>• If issues remain, please visit the Meet support page and check the Troubleshoot section. (<a href="https://support.google.com/meet">https://support.google.com/meet</a>)</li> </ul>

# 6 Troubleshooting tips

If you can't play videos on your Google TV or have other problems with your Google TV device, try the steps below.

## Basic issues

### Step 1. Check your Wi-Fi connection

- 1 Press **⚙️ (DASHBOARD)** button to open the Google TV dashboard menu, then select "All settings" and press **OK** button to enter it.
- 2 Select **Network & Internet**.
- 3 Confirm that **Wi-Fi** is turned on and you're connected to the correct network.
- 4 If not, locate the network you'd like to connect to and select it to connect. Enter the password if required.
- 5 Open one of your apps.
- 6 Play your video, music, or game again.

#### Note(s)

If you still have issues, turn the Wi-Fi option off and on again. If that doesn't work, go to the next step.

### Step 2. Check for system updates

- 1 Press **⚙️ (DASHBOARD)** button to open the Google TV dashboard menu, then select "All settings" and press **OK** button to enter it.
- 2 Select **System > About > System update > Check for update**
- 3 Install any available updates, then play your video, music, or game again. If that doesn't work, go to the next step.

### Step 3. Restart your device

- 1 Press **⚙️ (DASHBOARD)** button to open the Google TV dashboard menu, then select "All settings" and press **OK** button to enter it.
- 2 Select **System > Restart**.
- 3 Once the system restarts, play your video, music, or game again. If it still doesn't work, go to the next step.

### Step 4. Check which account you're signed in to

- 1 Press **⚙️ (DASHBOARD)** button to open the Google TV dashboard menu, then select "All settings" and press **OK** button to enter it.
- 2 Under **Accounts & Profiles**, check which account is signed in to Google TV.
- 3 Make sure it's the same account you used for your service.

### Step 5. Clear app data

- 1 Press **⚙️ (DASHBOARD)** button to open the Google TV dashboard menu, then select "All settings" and press **OK** button to enter it.
- 2 Select **Apps > See all apps**
- 3 Find and select the **app > Clear data > OK**
- 4 Play your video, music, or game again. If that doesn't work, go to the next step.

### Step 6. Reset the device to factory settings

**Important:** A factory reset erases all your data from your device. We recommend that you try to troubleshoot with other steps first.

- 1 Press **⚙️ (DASHBOARD)** button to open the Google TV dashboard menu, then select "All settings" and press **OK** button to enter it.
- 2 Select **System > About > Reset**

## Network connections

### Check your Wi-Fi connection

- 1 Press **⚙️ (DASHBOARD)** button to open the Google TV dashboard menu, then select "All settings" and press **OK** button to enter it.
- 2 Select **Network & Internet**.
- 3 Confirm that **Wi-Fi** is turned on and you're connected to the correct network.
- 4 If not, locate the network you'd like to connect to and select it to connect. Enter the password if required.
- 5 Open one of your apps.
- 6 Play your video, music, or game again.

#### Note(s)

If you still have issues, turn the Wi-Fi option off and on again.

## Connect Remote control

### Fix issues with your remote

**Important:** You might need to remove and reinsert the batteries on your remote.

On any interface of your Google TV, press **🗣️ (GOOGLE ASSISTANT)** button to quick pair the Bluetooth remote control with the TV set.

#### < Pairing >

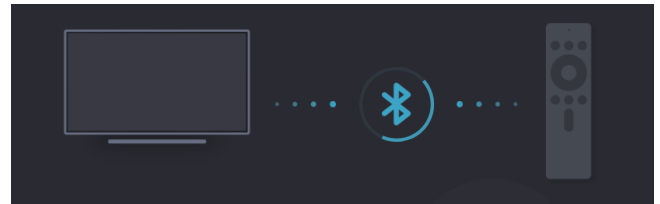

#### < Paired >

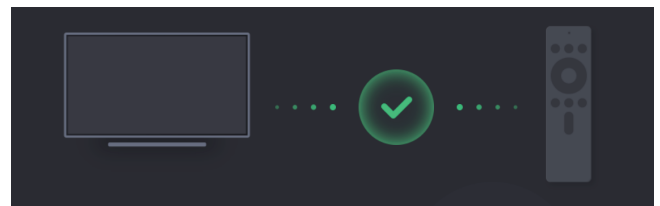

### LED states on voice remote

The voice remote has an LED light next to **⏻ (POWER)** button. It tells you about the status of your remote.

- Unlit---No press on any button.
- Lit in red---Press any button in infrared mode.
- Lit in green---Press any button in Bluetooth mode.
- Blink in green---Be in Bluetooth pairing mode.

## Pair a Bluetooth device

- 1 Press **⚙️ (DASHBOARD)** button to open the Google TV dashboard menu, then select "All settings" and press **OK** button to enter it.
- 2 Select Remote & Accessories > Pair accessory
- 3 Make sure your device is in pairing mode or is visible to other devices.
- 4 Identify the device you want to pair from the list and select it.
- 5 On the Bluetooth pairing request screen, select Pair.

### Note(s)

Accessories that have been paired with your device appear in the Remote & Accessories section of Settings. You can also rename or forget devices.

## Reconnect a paired device

- 1 Press **⚙️ (DASHBOARD)** button to open the Google TV dashboard menu, then select "All settings" and press **OK** button to enter it.
- 2 Select Remote & Accessories
- 3 Under "ACCESSORIES" choose your device.
- 4 Select Connect.

## Video

### Streaming movie often stops or starts buffering during playback.

- Contact your internet service provider to troubleshoot your internet connection for speed and line quality.
- Consistent line quality and speed are very important for internet video playback.

### Slow Data Connection or buffering.

- Check the settings between your router and ISP modem or gateway (if applicable).
- Connect to a stable wireless connection from home wireless or wired network, check your wifi connection quality in settings.

### Note(s)

The use of mobile hot spots or public wireless connections is not recommended.

### Power is on but screen image is off.

- Check if the connection for your source device is properly secured.
- Check if the correct input is selected by pressing **⏮ (SOURCE)** on your remote.
- Verify that your HDMI mode, for the input selected matches the resolution output of your source device.
- Change source input until you have picture and sound.

### Television has sound with no picture or abnormal picture.

- Change the resolution output of your source device.

### Why are captions not displayed entirely? Or why are captions delayed behind the dialog?

Closed captions that are delayed a few seconds behind the actual dialog are common for live broadcasts.

Most captioning production companies can display a dialog to maximum of 220 words per minute.

If a dialog exceeds that rate, selective editing is used to insure that the closed captions remain up-to date with the current TV screen dialog.

### Ghosts, lines, or streaks in picture.

Electrical interference from nearby appliances may affect picture quality.

View other TV channels. The problem might be limited to the broadcasting station or weak signal strength.

### Picture poor, sound intermittent, or no sound

View other TV channels. The problem might be limited to the broadcasting station or weak signal strength.

### How do I adjust the picture settings on my Television

For wired connection (HDMI)/Antenna cable/composites

- 1 Go Setting/Dashboard and select Picture
- 2 select Picture Mode and choose what you want

### Why not seeing a picture or not seeing a correct resolution when connected with HDMI

- Check the antenna/cable connection.
- Connect the 4K (50p/60p)\* playable device.
- Use a Premium High Speed HDMI™ Cable(s) that supports 18 Gbps.
- Select HDMI EDID Version by selecting Settings > Channels & Inputs > Inputs > HDMI1/2/3 > HDMI EDID Version > Auto/Compatibility/Standard/Enhance.

### The screen suddenly changes to a video you do not recognize while watching TV.

In this case, the TV might be in demo mode. Try exiting demo mode.

Choose "Shop/Retail" mode in initial setup by selecting **⚙️ (DASHBOARD)** button > All settings > System > About > Reset.

### Distorted picture./The screen flickers.

- Check the antenna/cable connection.
- Keep the antenna/cable away from other connecting cables.
- When installing an optional device, leave some space between the device and the TV.
- Make sure that the antenna is connected using a high quality 75-ohm coaxial cable.

## High resolution HDR pictures are not displayed.

The following are required to watch high resolution HDR pictures such as 4K.

- Connect the 4K playable device.
- Use a Premium High Speed HDMI™ Cable(s) that supports 18 Gbps.
- Set "HDMI EDID Version". Select Settings > Channels & Inputs > Inputs > HDMI1/2 > HDMI EDID Version, then choose the correct version.
- Check whether the connected device has the latest settings or firmware.

## Audio

### Television has no sound.

- Please check to be sure the device is connected to the HDMI-1 eARC/ARC input on the TV.
- Check if the power is on.
- Check whether all the cables to the unit are connected to the correct output jack on your separate device like Blu-ray Disc™ / DVD recorder
- Unplug the AC power cord and wait for about 1 minute, then plug the AC power cord and turn on the unit again.
- Check whether the connection of the antenna or cable/satellite set-top box is connected correctly.
- Make sure that the sound is not muted. Press **MUTE** so that the volume bar and current volume level will appear on the TV screen.
- Make sure that the volume is NOT, set to 0 or **MUTE**. If so, use +/- **VOL** to adjust to the desired volume.
- Make sure that the headphone is NOT connected to the headphone audio output jack.
- If there are issues with picture/color and/or sound when connecting an external device using the HDMI port, please try switching the HDMI EDID Version. (Refer to below)
- If headphones or Bluetooth audio devices are connected, sound is not output from the TV speakers or audio system connected via eARC/ARC. Remove the headphones or disconnect the Bluetooth audio device.

### Picture poor, sound intermittent, or no sound

View other TV channels. The problem might be limited to the broadcasting station or weak signal strength.

### Use Headphone/Bluetooth devices and audio system/TV speakers at the same time.

### To output sound from both the headphones/Bluetooth audio device and TV speakers

The TV cannot output sound from both the headphones or Bluetooth audio device and the TV speakers at the same time.

### To output sound from both an audio system connected via ARC and TV speakers

Sound can be output from both an audio system connected to the TV and the TV speakers at the same time by satisfying the following conditions.

- Connecting the TV and audio system using a digital optical cable
- Setting [Digital Output] to [PCM] in Audio Output of Display & Sound under Settings.

### How to connect Digital audio Optical

Use a digital audio optical cable to connect the unit to external digital audio devices.

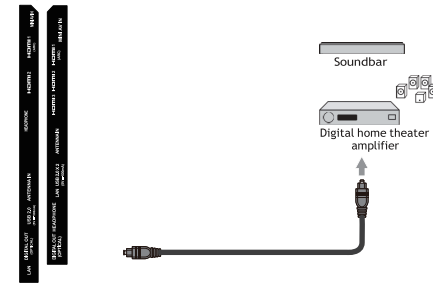

### HDMI- ARC connection (Digital home theater amplifier that supports HDMI- ARC)

HDMI-ARC allows you to use HDMI control to output TV audio directly to a connected audio device, without the need for an additional digital audio cable.

HDMI-ARC is only available on HDMI-1, so connect your device to this HDMI-1 if sound output from the TV through HDMI is needed.

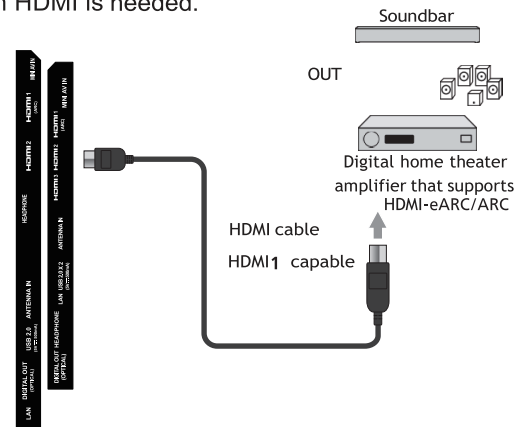

### Pair a Bluetooth device

- 1 Press **⚙️ (DASHBOARD)** button to open the Google TV dashboard menu, then select "All settings" and press **OK** button to enter it.
- 2 Select Remote & Accessories > Pair accessory
- 3 Make sure your device is in pairing mode or is visible to other devices.
- 4 Identify the device you want to pair from the list and select it.
- 5 On the Bluetooth pairing request screen, select Pair.

### Note(s)

Accessories that have been paired with your device appear in the Remote & Accessories section of Settings. You can also rename or forget devices.

## Cable/Satellite TV

I can not watch cable/satellite set-top box(STB) programs.

- Check that HDMI cable connection is secure on TV and connected device.
- Unplug and reconnect the cable to force a reconnection.
- If using 15 ft. or longer HDMI cable, try a shorter one.
- Try a different HDMI Input on the TV. Sometimes HDMI settings are set different.
- Verify that the connected device is outputting a resolution supported by your television
  - 640x480 (SD)
  - 1280x720 (HD)
  - 1920x1080 (FHD)
  - 3840x2160 (4K)
- If connected device is outputting 4K with HDR, change the TV HDMI settings to Enhance.
- If connected device is older and does not support 4K or HDR, change the TV HDMI settings to Standard/Compatibility.

## External devices

### HDMI digital connection (normal connection)

HDMI connection offers the highest picture quality. HDMI (High-Definition Multimedia Interface) transports highdefinition digital video and multi-channel digital audio through a single cable.

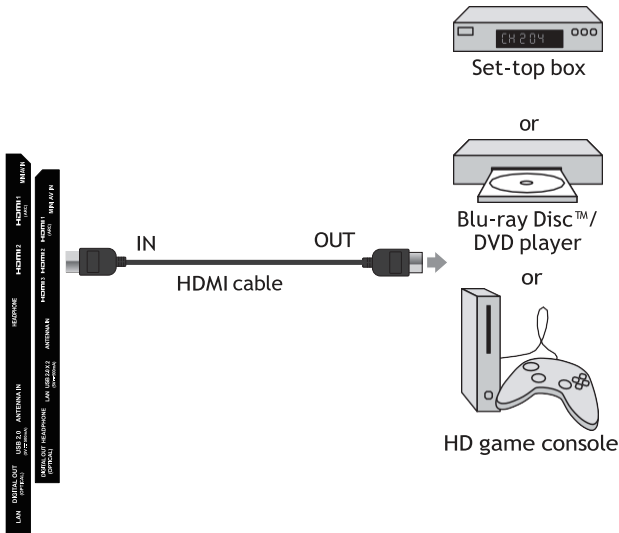

### HDMI-ARC connection (Digital home theater amplifier that supports HDMI-ARC)

HDMI-ARC allows you to use HDMI control to output TV audio directly to a connected audio device, without the need for an additional digital audio cable.

HDMI-ARC is only available on HDMI-1, so connect your device to this HDMI-1 if sound output from the TV through HDMI is needed.

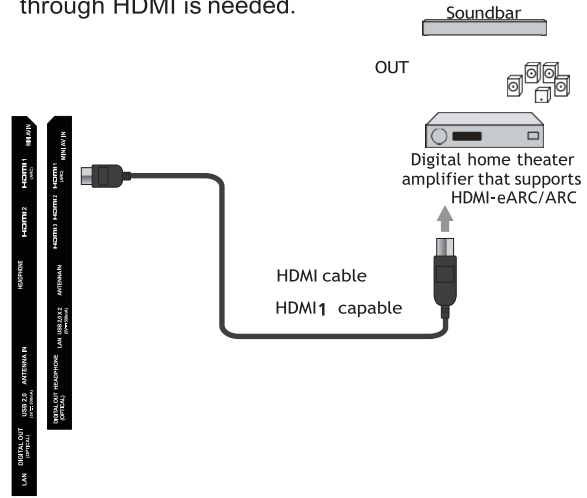

### If connecting cable/satellite/IPTV set-top box using an HDMI cable

If the TV is connected to a cable/satellite set-top box via an HDMI cable, make sure you select the correct source by using **(SOURCE)** on your remote control.

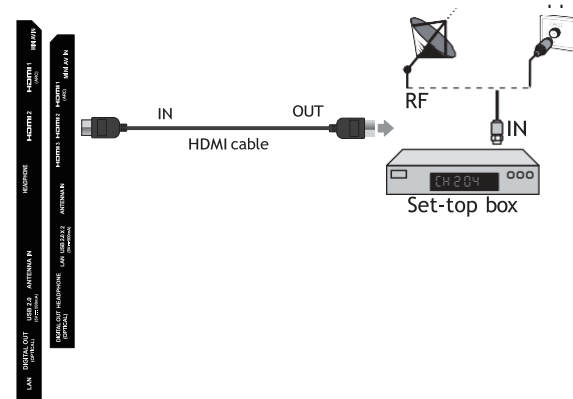

### If connecting cable/satellite/IPTV set-top box using an RF cable

If the TV is connected to a cable/satellite set-top box via a coaxial connection, set the TV to channel 3/4 or the channel specified by the service provider.

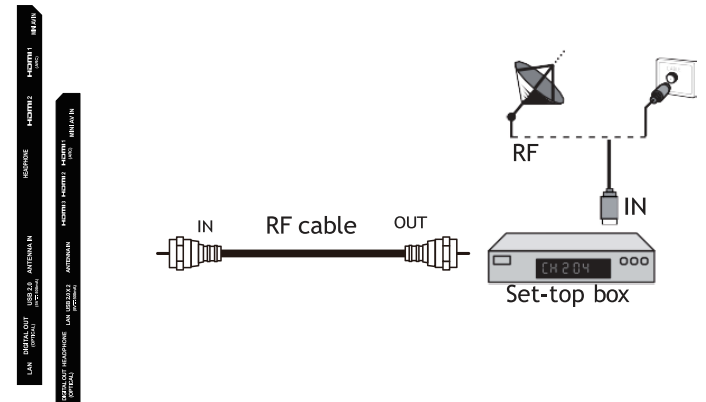

### Connecting a cable/satellite/IPTV set-top box, Blu-ray Disc/DVD recorder via composite or antenna port.

Do not place your recorder too close to the screen because some recorders can be susceptible to harmful interference from the TV.

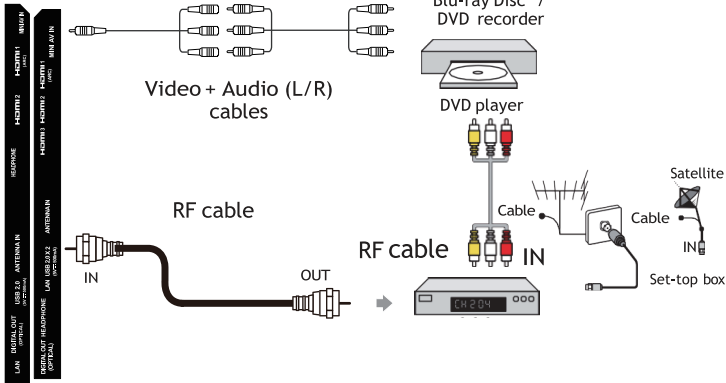

### Composite analog video connection

Composite analog video connection offers standard picture quality for video devices connected to the unit.

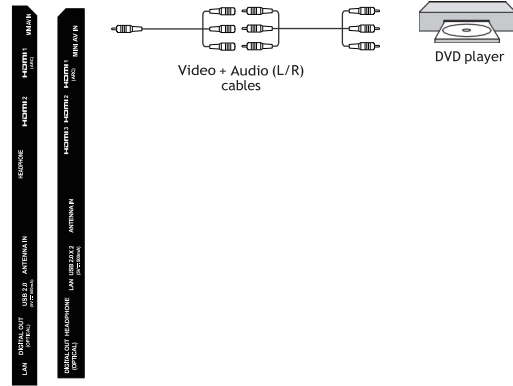

### Connecting the TV to the internet using an Ethernet cable

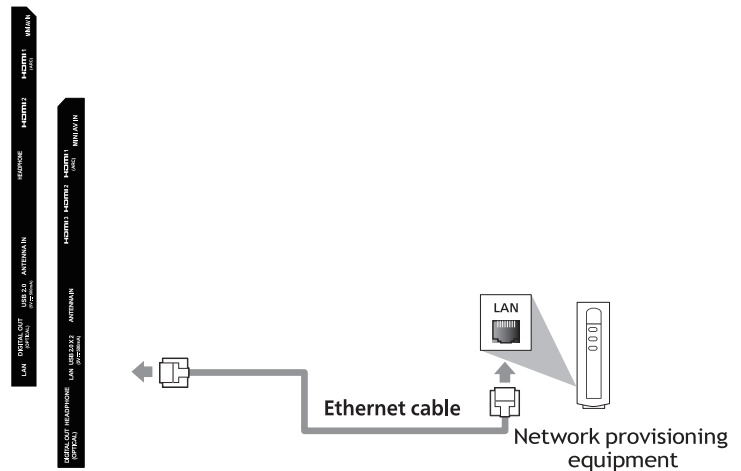

### Digital audio output connection

If you connect this unit to an external digital audio device, you can enjoy multi-channel audio like 5.1ch digital broadcasting sound.

Use a digital audio optical cable to connect the unit to external digital audio devices.

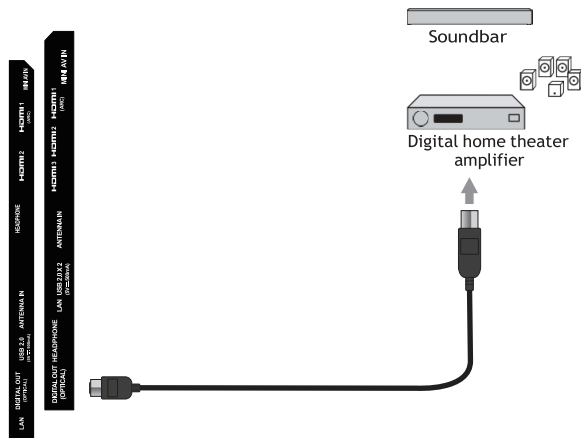

### Check your Wi-Fi connection

- 1 Press **⚙️ (DASHBOARD)** button to open the Google TV dashboard menu, then select "All settings" and press **OK** button to enter it.
- 2 Select Network & Internet.
- 3 Confirm that Wi-Fi is turned on and you're connected to the correct network.
- 4 If not, locate the network you'd like to connect to and select it to connect. Enter the password if required.
- 5 Open one of your apps.
- 6 Play your video, music, or game again.

**☰ Note(s)**  
If you still have issues, turn the Wi-Fi option off and on again.

---

## Pair a Bluetooth device

- 1 Press **⚙️ (DASHBOARD)** button to open the Google TV dashboard menu, then select "All settings" and press **OK** button to enter it.
- 2 Select Remote & Accessories > Pair accessory
- 3 Make sure your device is in pairing mode or is visible to other devices.
- 4 Identify the device you want to pair from the list and select it.
- 5 On the Bluetooth pairing request screen, select Pair.

 Note(s)

Accessories that have been paired with your device appear in the Remote & Accessories section of Settings. You can also rename or forget devices.

## Connect Bluetooth

You can connect several Bluetooth devices, like headphones or game controllers, to your Google TV. You can only connect one audio device at a time.

---

## Pair a Bluetooth device

- 1 Press **⚙️ (DASHBOARD)** button to open the Google TV dashboard menu, then select "All settings" and press **OK** button to enter it.
- 2 Select Remote & Accessories > Pair accessory
- 3 Make sure your device is in pairing mode or is visible to other devices.
- 4 Identify the device you want to pair from the list and select it.
- 5 On the Bluetooth pairing request screen, select Pair.

 Note(s)

Accessories that have been paired with your device appear in the Remote & Accessories section of Settings. You can also rename or forget devices.

---

## Reconnect a paired device

- 1 Press **⚙️ (DASHBOARD)** button to open the Google TV dashboard menu, then select "All settings" and press **OK** button to enter it.
- 2 Select Remote & Accessories.
- 3 Under "ACCESSORIES" choose your device.
- 4 Select Connect.

---

## Fix problems with connecting Bluetooth devices

If your Bluetooth device won't connect, it could be an issue with the Bluetooth device or your TV.

### Troubleshoot connection issues

- 1 Turn off your Bluetooth device and then turn it back on. After your device is reset, try to pair it again.
- 2 If you have multiple devices paired with your TV, disconnect the ones you're not using.
- 3 Unplug your TV for 10 seconds and then plug it back in. When your TV is on, try to pair it again.
- 4 Check if your Bluetooth device connects to other devices, such as a phone or tablet.
  - a. If your device connects to other devices: Reset your Google TV device to factory settings.
  - b. If your device doesn't connect to other devices: Check that your Bluetooth device has up-to-date software or get help from the device's manufacturer.

# 7 Information

## Glossary

### Analog TV (NTSC)

Acronym that stands for National Television Systems Committee and the name of analog broadcasting standards. Off the air analog TV signals are no longer being sent by major broadcasting stations in the U.S.

### ARC (Audio Return Channel) (HDMI 1 only)

HDMI-ARC allows you to use Philips HDMI control to output TV audio directly to a connected audio device, without the need for an additional digital audio cable. Be sure that the device is HDMI CEC and ARC compliant, and that the TV is connected to the device using an HDMI cable attached to both HDMI-ARC connectors.

### Aspect ratio

The width of a TV screen relative to its height. Conventional TVs are 4:3 (in other words, the TV screen is almost square); widescreen models are 16:9 (the TV screen is almost twice as wide as its height).

### CEC (Consumer Electronics Control)

This allows you to operate the linked functions between our brand devices with CEC feature and this unit. We do not guarantee 100 % interoperability with other brands of CEC compliant devices.

### Dolby Digital

The system developed by Dolby Laboratories to compress digital sound. It offers stereo sound (2ch) or multi-channel audio.

### DTV (ATSC)

Abbreviation that stands for Advanced Television Systems Committee and the name of the digital broadcasting standards.

### e-POP

e-POP is showing set features, technical information, etc on this TV set that is displayed on the TV screen mainly used by TV retailers. Previously the information was on a printed sticker that was put on the display.

### HDMI (High-Definition Multimedia Interface)

Interface that supports all uncompressed, digital audio/video formats including set-top box, Blu-ray Disc™/DVD recorder or digital television, over a single cable.

### HDR10

High Dynamic Range (HDR10) is a new video technology, which lets you experience more detail and captivating colors for an even more engaging television experience. More perceivable shades of blacks, whites, and all other colors.

### UHD

4K/UHD means the TV's screen has a minimum resolution of 3,840 pixels wide and 2,160 pixels high, making it the equivalent to two 1080p screens in height and two in length. This resolution was originally known as "Quad HD," and it's used by basically every 4K TV.

### PIN code

A stored 4-digit number that allows access to parental control features.

### SAP (Secondary Audio Program)

Second-audio channel delivered separately from the Main-audio channel. This audio channel is used as an alternate in bilingual broadcasting.

## Maintenance

### Cleaning

- Clean the front panel and other exterior surfaces of the unit with a soft microfiber cloth or lens brush. Before cleaning the panel, disconnect the AC power cord.
- Never use a solvent or alcohol. Do not spray insecticide liquid near the unit. Such chemicals may cause damage and discoloration to the exposed surfaces.
- Do not spray any liquids on the screen or other exterior surfaces of this unit. If liquids enter the unit, they could cause shorts, electric shocks, or fire damage.



### Servicing

Should your unit become inoperative, do not try to correct the problem yourself. There are no user serviceable parts inside. Call our toll free customer support line found on the cover of this user manual to locate an authorized service center.

## Specifications

Model #	32PFL6446/F7	40PQL7446/F7
Picture		
Type	HD (1366 x 768 pixels 60 Hz)	FHD(1920x1080 pixels 60 Hz)
Diagonal screen size/Aspect ratio	32 "/16:9	40 "/16:9
Viewing angles	178° (V) by 178° (H)	
Built-in digital/analog tuner	ATSC (digital)/NTSC (analog)	
Sound		
Mono/Stereo	Mono, Stereo	
Equalizer	5 band	
Ease of use		
Screen	Automatic/Super zoom/4:3/Movie expand 14:9/Movie expand 16:9/Wide screen/Full screen/Unscaled	
Channel		
Channel coverage	Over-the-Air DTV (ATSC)	VHF: 2~13 UHF: 14~69 (Each channel may have e.g. 2.1~2.9, 3.1~3.9, etc)
	Over-the-Air Analog (NTSC)	VHF: 2~13 UHF: 14~69
CATV (Analog NTSC)	2~13, A~W W+1~W+94 (Analog W+1~W+84), A-5~A-1, 5A	
Tuning system	Channel frequency synthesized tuning system	
Channel access	Channel scan, GUIDE, UP/DOWN	
Connectivity		
Composite input	1(Mini AV IN)	
HDMI input	2(selectable HDMI modes) PC input	3(selectable HDMI modes) PC input
	Supporting HDMI video signals: 480i/p, 720p, 1080i/p, 2160p @24/30 Hz	
	Supporting HDMI HDR signals: HDR10, HLG (Hybrid Log-Gamma)	
	Supporting HDMI digital audio signals: LPCM, AC3	
Supporting PC-input video signal up to 4096 x 2160		
USB	1	2
Wireless LAN	Wireless LAN Supporting wireless standards: IEEE 802.11a/b/g/n/ac (2.4 GHz/5 GHz)	
Ethernet port	1	1
Digital audio output	1 Supporting Dolby Audio	1 Supporting Dolby Audio
Headphone output	1 1/8" (3.5 mm)	1 1/8" (3.5 mm)
Bluetooth	Version 5.1	
Power		
Power requirements	120 V~ +/- 10 %, 60 Hz +/- 0.5 %	
Temperature		
Operating temperature	41 °F (5 °C) to 104 °F (40 °C)	

- Specifications are subject to change without prior notice.

# Warranty

## Limited warranty one (1) year

### Warranty coverage:

This warranty obligation is limited to the terms as set forth below.

### Who is covered:

This product warranty is issued to the original purchaser or the person receiving the product as a gift against defects in materials and workmanship as based on the date of original purchase ("Warranty Period") from an Authorized Dealer. The original sales receipt showing the product name and the purchase date from an authorized retailer is considered such proof.

### What is covered:

This warranty covers new products if a defect in material or workmanship occurs and a valid claim is received within the Warranty Period. At its option, the company will either (1) repair the product at no charge, using new or refurbished replacement parts, or (2) exchange the product with a product that is new or which has been manufactured from new, or serviceable used parts and is at least functionally equivalent or most comparable to the original product in current inventory, or (3) refund the original purchase price of the product.

Replacement products or parts provided under this warranty are covered against defects in materials and workmanship from the date of the replacement or repair for ninety (90) days or for the remaining portion of the original product's warranty, whichever provides longer coverage for you. When a product or part is exchanged, any replacement item becomes your property and the replaced item becomes company property. When a refund is given, your product becomes company property.

Note: Any product sold and identified as refurbished or renewed carries a ninety (90) day limited warranty.

Replacement product can only be sent if all warranty requirements are met. Failure to follow all requirements can result in delay.

### What is not covered – Exclusions and limitations:

This Limited Warranty applies only to new company manufactured products that can be identified by the trademark, trade name, or logo affixed to it. This Limited Warranty does not apply to any hardware product or any software, even if packaged or sold with the product, as manufacturers, suppliers, or publishers may provide a separate warranty for their own products packaged with the bundled product.

The company is not liable for any damage to or loss of any programs, data, or other information stored on any media contained within the product, or other additional product or part not covered by this warranty. Recovery or reinstallation of programs, data or other information is not covered under this Limited Warranty.

This warranty does not apply (a) to damage caused by accident, abuse, misuse, neglect, misapplication, or non-supplied product, (b) to damage caused by service performed by anyone other than company approved Authorized Service Location, (c) to a product or a part that has been modified without written company permission, or (d) if any serial number has been removed or defaced, or (e) product, accessories or consumables sold "AS IS" without warranty of any kind by including refurbished product sold "AS IS" by some retailers.

This Limited Warranty does not cover:

- Shipping charges to return defective product.
- Labor charges for installation or setup of the product, adjustment of customer controls on the product, and installation or repair of antenna/signal source systems outside of the product.
- Product repair and/or part replacement because of improper installation or maintenance, connections to improper voltage supply, power line surge, lightning damage, retained images or screen markings resulting from viewing fixed stationary content for extended periods, product cosmetic appearance items due to normal wear and tear, unauthorized repair or other cause not within the control of the company.
- Damage or claims for products not being available for use, or for lost data or lost software.
- Damage from mishandled shipments or transit accidents when returning product.
- A product that requires modification or adaptation to enable it to operate in any country other than the country for which it was designed, manufactured, approved and/or authorized, or repair of products damaged by these modifications.
- A product used for commercial or institutional purposes (including but not limited to rental purposes).
- Product lost in shipment and no signature verification receipt can be provided.
- Failure to operate per user manual.

To obtain assistance...

Contact the Customer Care Center at:

1 833 978 3323

Chat with us in English:

<https://tinyurl.com/y2e29xsq>

REPAIR OR REPLACEMENT AS PROVIDED UNDER THIS WARRANTY IS THE EXCLUSIVE REMEDY FOR THE CONSUMER, WITH THE ISSUING COMPANY NOT LIABLE FOR ANY INCIDENTAL OR CONSEQUENTIAL DAMAGES FOR BREACH OF ANY EXPRESS OR IMPLIED WARRANTY ON THIS PRODUCT. EXCEPT TO THE EXTENT PROHIBITED BY APPLICABLE LAW, ANY IMPLIED WARRANTY OF MERCHANTABILITY OR FITNESS FOR A PARTICULAR PURPOSE ON THIS PRODUCT IS LIMITED IN DURATION TO THE DURATION OF THIS WARRANTY.

Some states do not allow the exclusions or limitation of incidental or consequential damages, or allow limitations on how long an implied warranty lasts, so the above limitations or exclusions may not apply to you.

*This warranty gives you specific legal rights. You may have other rights which vary from state/province to state/province.*

Skyworth USA Corporation Service, 2950 Toy Road, Groveport, OH 43125, USA

## License

Skyworth USA Corporation hereby offers to deliver, upon request, a copy of the complete corresponding source code for the copyrighted open source code packages, on an "AS IS" basis, used in this product for which such offer is requested by the respective licenses. This offer is valid up to three years after the product purchase to anyone in receipt of this information. To obtain source code, please contact Skyworth USA Corporation. You should write to Skyworth USA Corporation Service, 2950 Toy Road, Groveport, OH 43125, USA.

Skyworth USA Corporation disclaims any and all warranties and representations with respect to such software and related source code including quality, reliability, usability, accuracy, and further disclaim all express, implied, statutory, or otherwise, including without limitation, any implied warranties of title, non-infringement, merchantability, or fitness for a particular purpose. Skyworth USA Corporation shall not be liable to make any corrections to the open source software or source code or to provide any support or assistance with respect to it.

Skyworth USA Corporation disclaims any and all liability arising out of or in connection with the use of this software and/or source code.



Skyworth USA Corporation  
10833 Valley View Street, Suite 415, Cypress, CA 90630, United States

The Philips trademarks are registered trademarks of Koninklijke Philips N.V. and are used under license. This product has been manufactured and is sold under the responsibility of Skyworth USA Corporation, and Skyworth USA Corporation is the warrantor in relation to this product.