

# PHILIPS

Adapter Ring D

For LED-HL (=H7)

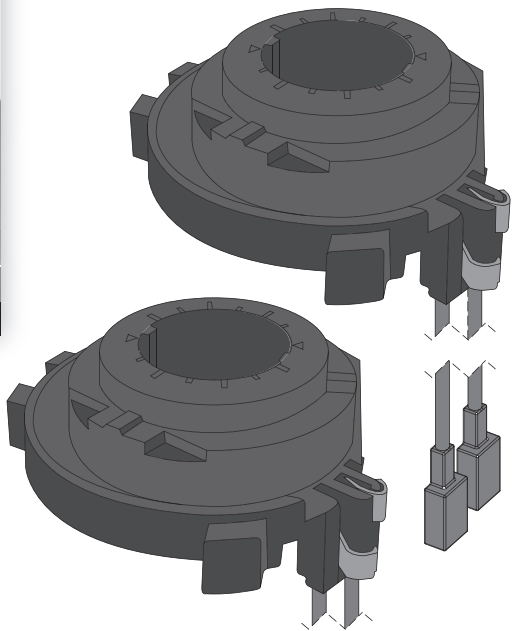

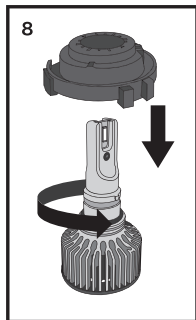
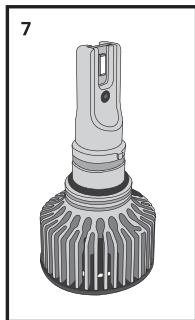
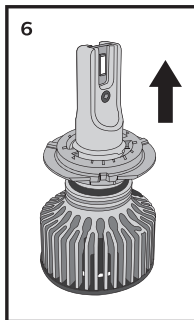
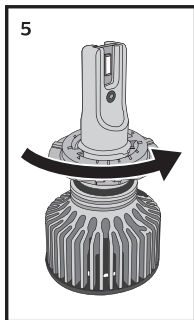
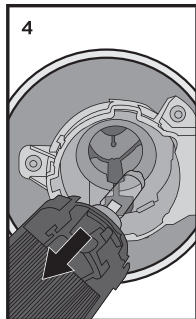
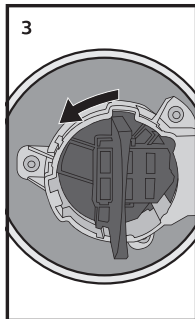
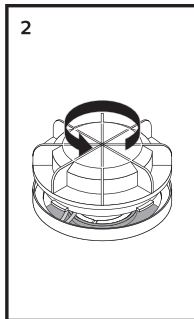
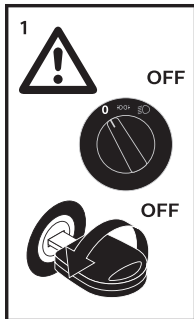

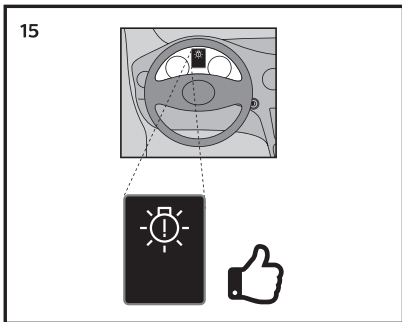
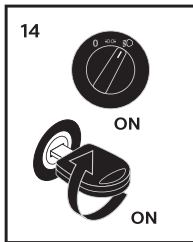
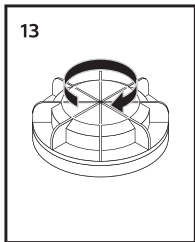
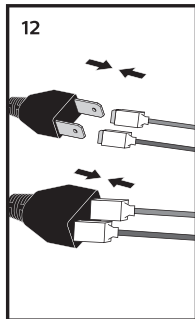
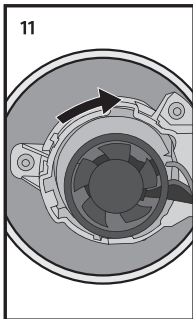
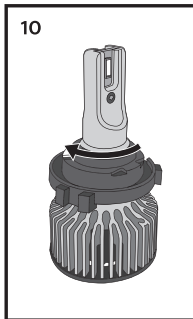
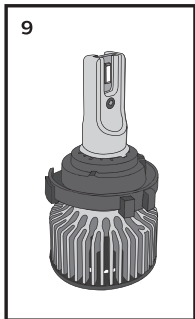



**Ultinon Motion est le garant de ce produit.**

**2022 - 2025 © Ultinon Motion Holding B.V. Tous droits réservés. La marque commerciale Philips et l'emblème du bouclier Philips sont la propriété de Koninklijke Philips N.V. et sont utilisés sous licence.**

**Ultinon Motion ist der Garantiegeber für dieses Produkt.**

**Philips und das Philips Wappen sind eingetragene Marken von Koninklijke Philips N.V. und werden unter Lizenz verwendet.**

**©2022 - 2025 Ultinon Motion Holding B.V. Alle Rechte vorbehalten.**

**Ultinon Motion is the warrantor of this product.**

**Philips and the Philips Shield Emblem are registered trademarks of Koninklijke Philips N.V. and are used under license.**

**© 2022 - 2025 Ultinon Motion Holding B.V. All rights reserved.**