

**PHILIPS**

Soundbar

5000 Series

# User Manual

TAB5109

Register your product and get support at  
[www.philips.com/support](http://www.philips.com/support)

# Contents

---

## 1 Important safety instructions 3

Safety	3
Care for your product	5
Care of the environment	5
Declaration of conformity	5
Help and support	5

---

## 2 Your Soundbar 6

What's in the box	6
Soundbar	6
Connectors	7
Remote control	8
Prepare the Remote Control	8
Placement	9
Wall mount	10

---

## 3 Connect 11

Connect to HDMI ARC	11
Connect to Optical	11
Connect to Audio in	11
Connect to power	12

---

## 4 Use your soundbar 13

App download	13
Turn on and off	13
Select modes	13
Adjust the Volume	14
Adjust bass/treble level	14
Select Equalizer (EQ) Effect	14
LEDs display On/Off Indicator	15
DTS Virtual X	15
Auto. volume leveling	15
Play from Bluetooth devices	15
Listen to an external device	16
Play audio through USB	17
Factory reset	17

---

## 5 Product specifications 18

---

## 6 Troubleshooting 19

---

## 7 Trademarks 20

# 1 Important safety instructions

Read and understand all instructions before you use your product. If damage is caused by failure to follow instructions, the warranty does not apply.

## Safety

### Know these safety symbols

The marking information is located at the bottom or back of product.



This is CLASS II apparatus with double insulation, and no protective earth provided.



AC voltage



The symbol indicates DC voltage.



Follow the instructions in the user manual!



**WARNING!**  
Warning: Risk of electric shock!



The exclamation mark is intended to alert the user to the presence of important operating instructions.

### Risk of electric shock or fire!

- Before you make or change any connections, make sure that all devices are disconnected from the power outlet.
- Never expose the product and accessories to rain or water. Never place liquid containers, such as vases, near the product. If liquids are spilt on or into the product, disconnect it from the power outlet immediately. Contact Consumer Care to have the product checked before use.
- Never place the product and accessories near naked flames or other heat sources, including direct sunlight.
- Never insert objects into the ventilation slots or other openings on the product.
- Where the mains plug or an appliance coupler is used as the disconnect device, the disconnect device shall remain readily operable.
- Battery (battery pack or batteries installed) shall not be exposed to excessive heat such as sunshine, fire or the like.
- Disconnect the product from the power outlet before lightning storms.
- When you disconnect the power cord, always pull the plug, never the cable.
- Use the product in tropical and/or moderate climates.

### Risk of short circuit or fire!

- For identification and supply ratings, see the type plate at the back or bottom of the product.
- Before you connect the product to the power outlet, ensure that the power voltage matches the value printed on the back or bottom of the product. Never connect the product to the power outlet if the voltage is different.

## Risk of injury or damage to this product!

- For wall mounting, this product must be securely attached to the wall in accordance with the installation instructions. Use only the supplied wall mount bracket (if available). Improper wall mounting may result in accident, injury or damage. If you have any query, contact Consumer Care in your country.
- Never place the product or any objects on power cords or on other electrical equipment.
- If the product is transported in temperatures below 5°C, unpack the product and wait until its temperature matches room temperature before connecting it to the power outlet.
- Parts of this product can be made of glass. Handle with care to avoid injury and damage.

## Risk of overheating!

- Never install this product in a confined space. Always leave a space of at least four inches around the product for ventilation. Ensure curtains or other objects never cover the ventilation slots on the product.

## Battery usage CAUTION

- CAUTION: Danger of explosion if batteries are incorrectly replaced. Replace only with the same or equivalent type.
- Remove batteries if they are exhausted or if the remote control is not to be used for a long time.
- Batteries contain chemical substances, they should be recycled or disposed of as per state and local guidelines.
- Install all batteries correctly, + and - as marked on the apparatus.

- Do not mix old and new batteries.
- Do not mix alkaline, standard (Carbon-Zinc) or rechargeable (Ni-Cd, Ni- MH, etc.) batteries.
- The battery (batteries or battery pack) shall not be exposed to excessive heat such as sunshine, fire or the like.
- Don't disposal of a battery into fire or a hot oven, or mechanically crushing or cutting of a Battery.
- To avoid battery subjected to extremely low air pressure.



### Note

- The rating label is pasted on the bottom or back of the equipment.

---

## Care for your product

Use only microfiber cloth to clean the product.

---

## Care of the environment

### Disposal of your old product and battery



Your product is designed and manufactured with high quality materials and components, which can be recycled and reused.



This symbol on a product means that the product is covered by European Directive 2012/19/EU.



This symbol means that the product contains batteries covered by European Directive 2013/56/EU which cannot be disposed of with normal household waste.

Inform yourself about the local separate collection system for electrical and electronic products and batteries. Follow local rules and never dispose of the product and batteries with normal household waste. Correct disposal of old products and batteries helps prevent negative consequences for the environment and human health.

### Removing the disposable batteries

To remove the disposable batteries, see battery installation section.

---

## Declaration of conformity

This product complies with the radio interference requirements of the European community.

Hereby, TP Vision Europe B.V. declares that the product is in compliance with the essential requirements and other relevant provisions of RED Directive 2014/53/EU and UK Radio Equipment Regulations SI 2017 No 1206. You can find the Declaration of Conformity on [www.philips.com/support](http://www.philips.com/support).

---

## Help and support

For extensive online support, visit [www.philips.com/support](http://www.philips.com/support) to:

- download the user manual and the quick start guide
- watch video tutorials (available only for selected models)
- find answers to frequently answered questions (FAQs)
- email us a question
- chat with our support representative.

Follow the instructions on the website to select your language, and then enter your product model number.

Alternatively, you can contact Consumer Care in your country. Before you contact, note down the model number and serial number of your product. You can find this information on the back or bottom of your product.

# 2 Your Soundbar

Congratulations on your purchase, and welcome to Philips! To fully benefit from the support that Philips offers, register your soundbar at [www.philips.com/support](http://www.philips.com/support).

## What's in the box

Check and identify the items in the package:

- Soundbar x 1
- Remote control x 1  
(AAA batteries x 2)
- Power cord \* x 1
- Wall mount kit x 1
- Quick start guide/  
Warranty card / Safety sheet x 1

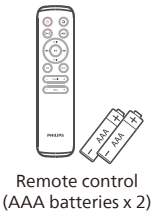
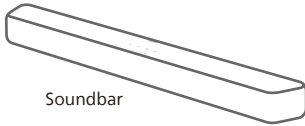

TAB5109/10		TAB5109/98	
TAB5109/67	TAB5109/61	TAB5109/96	TAB5109/77

- Power cord quantity and plug type vary by regions.
- Images, illustrations and drawings shown on this User Manual are for reference only, actual product may vary in appearance.

## Soundbar

This section includes an overview of the soundbar.

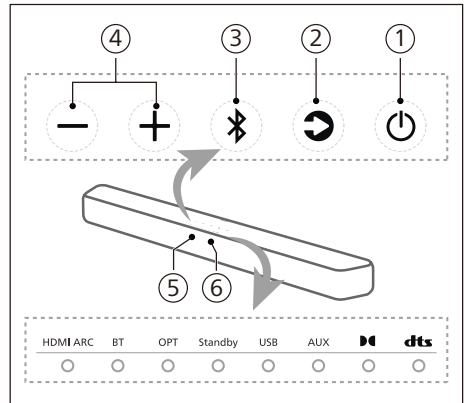

- ① **⏻ (Standby-On)**
  - Switch the soundbar On or to Standby.
  - Long press for 8 seconds in power on state to enable or disable Auto-Standby (15 minutes Auto-Standby).
- ② **⏻ (Source) button**  
Select an input source for the Soundbar.

- ③ **⌘ (Bluetooth) button**
  - Press to select the Bluetooth mode.
  - Long press for 3 seconds to enter the Bluetooth pairing mode.
  - Long press for 8 seconds to disconnect all devices and clear the BT connect history list, then enter pairing mode.
- ④ **+/- (Volume) button**  
Increase or decrease volume.
- ⑤ **Remote control sensor**
- ⑥ **Soundbar's LED indicator**

LED State	Status
<b>HDMI ARC</b>	Solid White HDMI ARC mode
<b>BT</b>	Solid Blue Bluetooth (Classic) mode Solid White Bluetooth (LE Audio) mode
<b>OPT</b>	Solid White Optical mode
<b>Standby</b>	Solid Red Standby mode
<b>USB</b>	Solid White USB mode
<b>AUX</b>	Solid White AUX mode
<b>Ⓛ</b>	Solid White Dolby Audio
<b>Ⓛ</b>	Solid White DTS Audio

## Connectors

This section includes an overview of the connectors available on your soundbar.

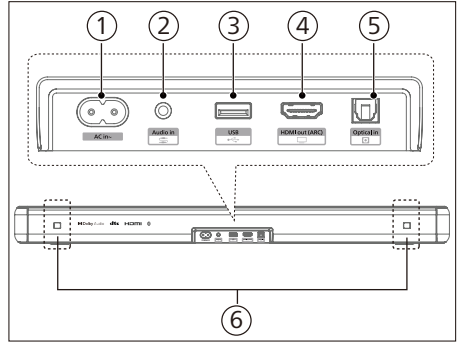

- ① **AC in ~ socket**  
Connect to the power supply.
- ② **Audio in**  
Audio input from, for example, an MP3 player (3.5mm jack).
- ③ **USB**
  - Connect to a USB storage device for audio media play.
  - Upgrade software of this product.
- ④ **HDMI ARC**  
The port supports the ARC HDMI feature, connect to the HDMI (ARC) input on the TV.
- ⑤ **Optical in**  
Connect to an optical audio output on the TV or a digital device.
- ⑥ **Wall bracket slot**

## Remote control

This section includes an overview of the remote control.

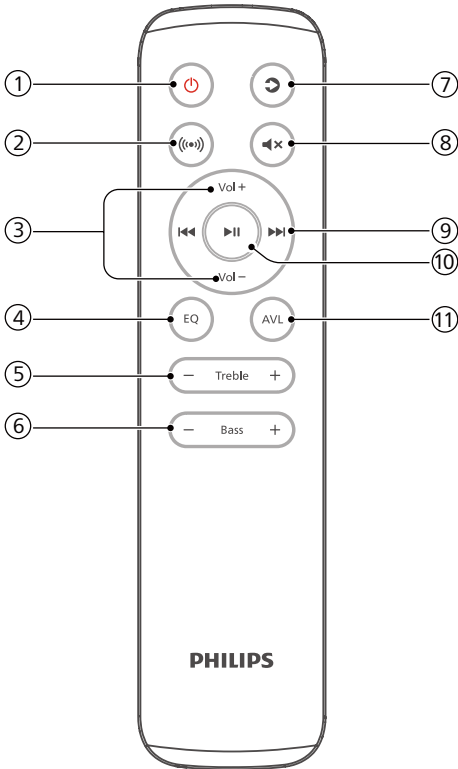

- ① **⏻ (Standby-On)**
  - Switch the soundbar on or to standby.
  - Long press for 8 seconds in power on state to enable or disable Auto-Standy (15 minutes Auto-Standy).
- ② **⦿ (Surround)**  
Virtualiser ON/OFF.
- ③ **Vol + / Vol - (Soundbar's Volume)**  
Increase / decrease the soundbar's volume.

- ④ **EQ**
  - Select Equalizer (EQ) effect.
  - Press and hold for 3 seconds to turn on/off dialogue enhancement.
- ⑤ **Treble +/-**  
Adjust treble level.
- ⑥ **Bass +/- (Subwoofer's Volume)**  
Adjust subwoofer's volume.
- ⑦ **↻ (Source)**  
Press to select an input source for soundbar.
- ⑧ **⏻ (Mute)**  
Mute or restore volume.
- ⑨ **⏮ / ⏭ (Previous/Next)**  
Skip to the previous or next track in USB / BT mode.
- ⑩ **▶⏪ (Play/Pause)**  
Start, pause or resume play in USB / BT mode.
- ⑪ **AVL**  
Auto volume leveling ON/OFF and night mode.

## Prepare the Remote Control

- The provided Remote Control allows the unit to be operated from a distance.
- Even if the Remote Control is operated within the effective range 19.7 feet (6m), remote control operation may be impossible if there are any obstacles between the unit and the remote control.
- If the Remote Control is operated near other products which generate infrared rays, or if other remote control devices using infra-red rays are used near the unit, it may operate incorrectly. Conversely, the other products may operate incorrectly.



---

## Replace the Remote Control Battery

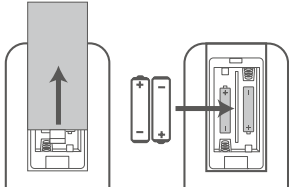

- 1 Press and slide the back cover to open the battery compartment of the remote control.
- 2 Insert two AAA size batteries (included). Make sure the (+) and (-) ends of the batteries match the (+) and (-) ends indicated in the battery compartment.
- 3 Close the battery compartment cover.

---

## Precautions Concerning Batteries

- Be sure to insert the batteries with correct positive “⊕” and negative “⊖” polarities.
- Use batteries of the same type. Never use different types of batteries together.
- Either rechargeable or non-rechargeable batteries can be used. Refer to the precautions on their labels.
- Be aware of your fingernails when removing the battery cover and the battery.
- Do not drop the remote control.
- Do not allow anything to impact the remote control.
- Do not spill water or any liquid on the remote control.
- Do not place the remote control on a wet object.
- Do not place the remote control under direct sunlight or near sources of excessive heat.

- Remove the battery from the remote control when not in use for a long period of time, as corrosion or battery leakage may occur and result in physical injury, and/or property damage, and/or fire.
- Do not use any batteries other than those specified.
- Do not mix new batteries with old ones.
- Never recharge a battery unless it is confirmed to be a rechargeable type.

---

## Placement

Place the subwoofer at least 1 meter (3 feet) away from your soundbar, and 10 centimeters away from the wall.

For best results, place your subwoofer as shown below.

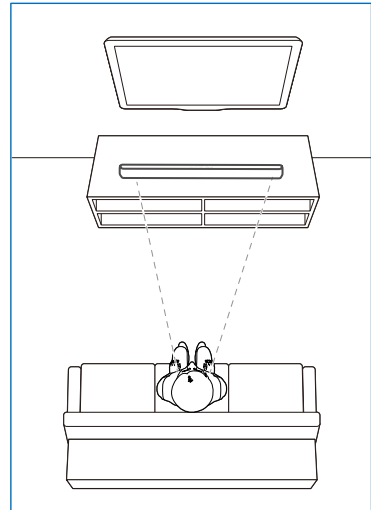

# Wall mount

## Note

- Improper wall mounting may result in accident, injury or damage. If you have any query, contact Consumer Care in your country.
- Before wall mounting, make sure the wall can support the weight of your soundbar.
- Before wall mounting, you need not remove the rubber feet at the bottom of the soundbar, otherwise the rubber feet cannot be fixed back.
- Depending on the type of wall mounting, make sure that you use screws of a suitable length and diameter.
- Please check whether the USB port on the back of the soundbar is connected to a USB device. If it is found that the connected USB device affects the wall-mount, you need to use another USB device of the appropriate size.

## Screw length/diameter

### Suggested wall mounting height

You are recommended to install the TV first before wall mounting the soundbar. With a TV preinstalled, wall mount the soundbar 50mm/2.0" in distance from the bottom of the TV.

## WARNING!

- To prevent injury, this apparatus must be securely attached to the floor/wall in accordance with the installation instructions.
- Suggested wall mounting height:  $\leq 1.5$  meters.

- 1 Drill 4 parallel holes (diameter 3-8mm each according to wall type) on the wall.
  - ↳ The distance between the holes are: 616mm / 18.9"
  - ↳ You can use the wall mount template provided for helping

the drilling holes position on the wall.

- 2 Tighten the wall mount brackets on the wall with screws (included) and screwdriver (not included). Make sure that they are securely installed.
- 3 Lift the unit onto the wall mount brackets and slot into place.

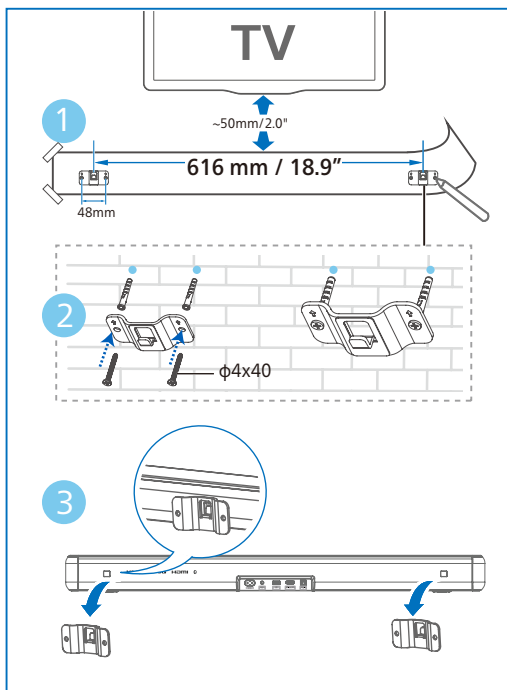

# 3 Connect

This section helps you connect your soundbar to a TV and other devices, and then set it up.

## Note

- For identification and supply ratings, see the type plate at the back or bottom of the product.
- Before you make or change any connections, make sure that all devices are disconnected from the power outlet.

## Connect to HDMI ARC

### HDMI ARC (Audio Return Channel)

Your soundbar supports HDMI with ARC (Audio Return Channel). If your TV is HDMI ARC compliant, you can hear the TV audio through your soundbar by using a single HDMI cable.

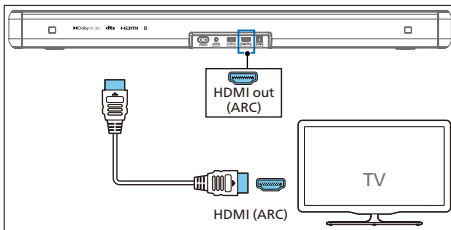

- 1 On your TV, turn on HDMI-CEC operations. For details, see the TV user manual.
  - The **HDMI ARC** connector on the TV might be labeled differently. For details, see the TV user manual.
- 2 Using a High Speed HDMI cable, connect the **HDMI ARC** connector on your soundbar to the **HDMI ARC** connector on the TV.

## Note

- Your TV must support the HDMI-CEC and ARC function. HDMI-CEC and ARC must be set to On.
- The setting method of HDMI-CEC and ARC may differ depending on the TV. For details about ARC function, please refer to your TV user manual.
- Make sure to use the HDMI cables can support the ARC function.

## Connect to Optical

- 1 Using an optical cable, connect the **Optical in** connector on your soundbar to the **Optical out** connector on the TV or other device.

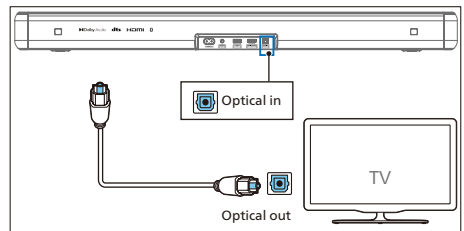

- The digital optical connector might be labeled **Spdif in** or **Spdif out**.

## Connect to Audio in

### Use 3.5mm audio cable

- Use a 3.5mm to 3.5mm audio cable to connect the TV's headphone socket to the **Audio in** socket on the soundbar.

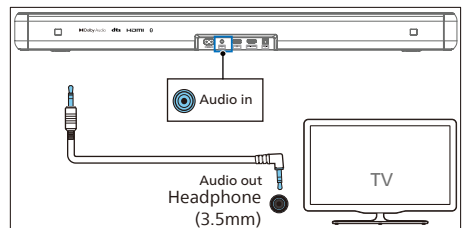

## Use 3.5mm-RCA audio cable

- Use a RCA to 3.5mm audio cable to connect the TV's audio output sockets to the **Audio in** socket on the soundbar.

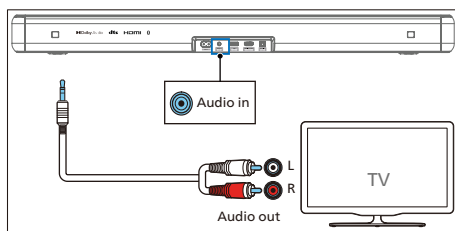

## Connect to power

- Before connecting the AC power cord, ensure you have completed all other connections.
  - Risk of product damage! Ensure that the power supply voltage corresponds to the voltage printed on the back or the underside of the unit.
- 1 Connect the mains cable to the **AC~** socket of the soundbar and then into a mains socket.

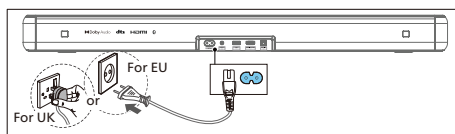

### Note

- Power cord quantity and plug type vary by regions.

## 4 Use your soundbar

This section helps you use the soundbar to play audio from connected devices.

### Before you start

- Make the necessary connections described in the quick start guide and the user manual.
- Switch the soundbar to the correct source for other devices.

## App download

Scan the QR code or search "Philips Entertainment" in the Apple App Store or Google Play to download and install the app.



With the Philips Entertainment app, you can set Volume level, Sound Style (EQ), Dialogue Enhancement, Surround Sound, Auto. volume leveling, AV sync, LED Light, Source selection etc.

## Turn on and off

- When you first connect the soundbar to the main socket, the unit will be in standby mode.
- Press the  $\cup$  button on the remote control or on the soundbar to switch the soundbar **ON** or **OFF**.
- Disconnect the mains plug from the mains socket if you want to switch the soundbar off completely.

## Auto Standby

- The soundbar automatically turns to Standby mode after about 15 minutes if the TV or the external soundbar is disconnected (or USB, BT function bit playback pause), or switched off.
- Long press the  $\cup$  button for 8 seconds in power on state to enable or disable Auto-Standby (15 minutes Auto-Standby).

### Note

- In HDMI (ARC) mode will enter network standby mode after approx. 15 minutes, if it has no audio playback.
- In Aux, USB, Optical and Bluetooth mode, the unit will automatically go to Standby mode approx. 15 minutes, if it has no audio playback.

## Select modes

Press the  $\odot$  (Source) button repeatedly on the soundbar or on the remote control to select the **HDMI ARC**, **BT**, **BT (LE Audio)**, **OPT**, **USB**, **AUX** mode.

- ↳ Switch the playback source and the front indicator lights up accordingly.

## Adjust the Volume

### Adjust the Soundbar's Volume

- Press **Vol+ / Vol-** (Volume) to increase or decrease a volume level.
  - ↳ When adjusting the volume, the indicator will increase / decrease the amount of light. According to the corresponding light display / blinking (Fig), determine the current volume level.

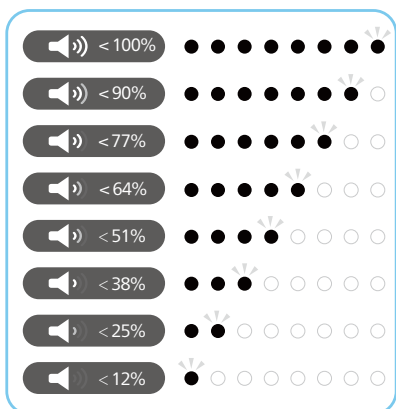

- To mute sound, press **Mute** (Mute).
- To restore the sound, press **Mute** (Mute) again or press **Vol+ / Vol-** (Volume).

## Adjust bass/treble level

- Press the **Bass +/-** button to change the low frequency (bass).
- Press the **Treble +/-** button to change the high frequency (treble).

Bass/ Treble	LED State
+5	○ ● ● ● ● ● ◎ ○ ○
+4	○ ● ● ● ● ◎ ○ ○ ○ ○
+3	○ ● ● ◎ ○ ○ ○ ○ ○ ○
+2	○ ● ◎ ○ ○ ○ ○ ○ ○ ○ ○
+1	○ ◎ ○ ○ ○ ○ ○ ○ ○ ○ ○ ○
0	● ○ ○ ○ ○ ○ ○ ○ ○ ○ ●

-1	○ ○ ○ ○ ○ ○ ◎ ○
-2	○ ○ ○ ○ ○ ◎ ● ○
-3	○ ○ ○ ○ ◎ ● ● ○
-4	○ ○ ○ ◎ ● ● ● ○
-5	○ ○ ◎ ● ● ● ● ○

## Select Equalizer (EQ) Effect

Select predefined sound modes to suit your video or music.

- Press the **EQ** button on the remote control to select your desired preset equalizer effects.
- Press the **EQ** button to switch among the modes.
  - ↳ Light up LEDs for 3 second to show current EQ mode according to the EQ mode definition.

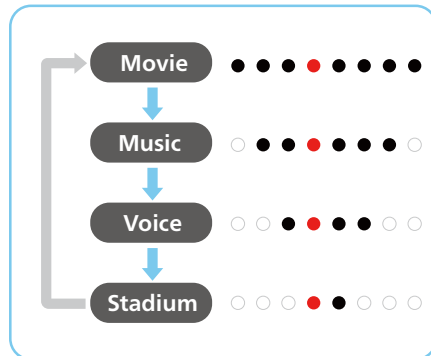

## LEDs display On/Off Indicator

Press and hold  (Mute) button on the remote control for 5 seconds will enable/disable LEDs display.

- ↳ **OFF:** The LEDs brightness will return normal once you press any button. LEDs should be turned off automatically after idling for 10 seconds.
- ↳ **ON:** The LEDs brightness will not self-extinguish.



### Tips



- During standby, the Standby LED shall turn on regardless LEDs display OFF setting.

## DTS Virtual X

**DTS Virtual:X** allows you to enjoy multi-dimensional sound regardless of room size, layout, or speaker configuration.

**DTS Virtual:X** technology features DTS's proprietary virtual height and virtual surround processing to deliver an immersive sound experience from any type of input source and speaker configuration.

- 1 Press the  button on the remote control to enable or disable virtual on.

Status	 LED State
ON	 (← →) (Two center LEDs spread out to right/left)
OFF	 (→ ←) (left / right LEDs close to the center)

- **ON:** This mode uses DTS Virtual:X with virtual height and virtual surround processing to realize a three-dimensional sound field





when the height speakers are not used.

- **OFF:** Do not use "DTS Virtual:X".

## Auto. volume leveling

Combine Auto volume with Night mode.



Press the **AVL** button to switch Auto volume leveling **ON/OFF** or night mode.

Status	 LED State
OFF	
ON	
NIGHT	

- **OFF:** Do not use "Auto volume".
- **ON:** Responds in real time to different sources and types of content to maintain consistent loudness.
- **NIGHT:** Maintain even loudness for all sources and types of content, and enhanced vocal and dialogue to make it easier to hear in a quiet listening environment.

## Play from Bluetooth devices

Through Bluetooth, connect the soundbar with your Bluetooth device (such as an iPad, iPhone, iPod touch, Android phone, or laptop), and then you can listen to the audio files stored on the device through your soundbar speakers.

- 1 Press the  button on the soundbar or  (Source) on the remote control to select the BT (Bluetooth) mode.
  - ↳ The BT indicator will blink blue.
- 2 On the Bluetooth device, switch on Bluetooth, search for and select **Philips TAB5109** to start connection (see the user manual of the Bluetooth device on how to enable Bluetooth).

- ↳ During connection, the BT indicator will blink blue.
- 3 Wait until you hear voice prompt from the soundbar.
    - ↳ If the successfully connected, the BT indicator will light up solidly blue.
  - 4 Select and play audio files or music on your Bluetooth device.
    - During play, if a call is coming, music play is paused. Play resumes when the call ends.
    - If your Bluetooth device supports AVRCP profile, on the remote control you can press **⏮ / ⏭** to skip to a track, or press **⏸** to pause/resume play.

### If your mobile phone supports LE Audio, you can experience and enjoy this new feature.

- 1 Press the **⌘** button on the soundbar or **⏵** (Source) on the remote control to select the **BT (LE Audio)** mode.
  - ↳ The BT indicator will blink white.
- 2 On the LE Audio device, open settings and switch on Bluetooth (Ensure the LE Audio function is activated on your LE Audio device), search for and select **Philips TAB5109-LEA** to start connection.

LED	Status	Name
Blue	BT	Philips TAB5109
White	BT (LE Audio)	Philips TAB5109-LEA

### To exit Bluetooth, you can:

- Switch the unit to another source.
- Disable the function from your Bluetooth device. Or place your Bluetooth device out of the maximum operational range. The

Bluetooth device will be disconnected from the unit after the voice prompt.

- Press and hold the **⌘** button on the soundbar.

#### Note

- In an open space without obstructions. The maximum operational range between the soundbar and a Bluetooth device is approximately 10 meters (30 feet).
- Compatibility with all Bluetooth devices is not guaranteed.
- The music streaming may be interrupted by obstacles between the device and soundbar, such as wall, metallic casing that covers the device, or other devices nearby that operate in the same frequency.

## Listen to an external device

Ensure that the soundbar is connected to the TV or audio device.

- 1 Press the **⏵** (Source) button repeatedly on the soundbar or on the remote control to select the **HDMI ARC, OPT, AUX** mode.
  - ↳ The indicator light on the soundbar will show which mode is currently in use.
- 2 Operate your audio device directly for playback features.
- 3 Press the **+/-** (Volume) buttons to adjust the volume to your desired level.

#### Note

- While in Optical/HDMI ARC mode, if there's no sound output from the unit, you may need to activate PCM or Dolby Digital Signal output on your source device (e.g. TV, DVD or Blu-ray player).





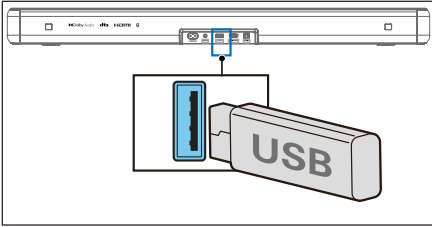

## Play audio through USB

Enjoy audio on a USB storage device, such as an MP3 player and USB flash memory, etc.

- 1 Insert the USB device.



- 2 Press the  (Source) button repeatedly on the soundbar or on the remote control to select the USB mode.
- 3 During playback:

Button	Action
	Start, pause or resume play
	Skip to the previous track
	Skip to the next track

### Note

- This product may not be compatible with certain types of USB storage devices.
- If you use a USB extension cable, USB hub, or USB multifunctional card reader, the USB storage device may not be recognized.
- Do not remove the USB storage device while reading files.
- The system can support USB devices with up to 128 GB of memory.
- This system can play MP3/WAV/FLAC.
- Support a USB port: 5V --- 500mA.

## Factory reset

Reset device to default setting.

- Turn on the soundbar, press and hold the **+** and **-** buttons at the same time for 8 seconds.
  - ↳ All LEDs light up for 5 seconds, standby LED in Red.

Item	Default settings
EQ	Movie
Master Volume	10
Bass	0
Treble	0
Surround	OFF
Auto Volume	OFF
Night	OFF
Source	HDMI-ARC
BT pairing info	Clear
AV SYNC	0
DISPLAY	ON
Auto Standby (Auto Power Down)	ON
Dialogue enhancement	OFF

# 5 Product specifications

## Note

- Specifications and design are subject to change without notice.

## Bluetooth

Bluetooth profiles	A2DP, AVRCP
Bluetooth version	V 5.4
Bluetooth frequency range / Transmitter power (EIRP)	2402 ~ 2480MHz < 10dBm

## Amplifier Section

Total	RMS 60W @THD <=10% Max. 120W
-------	---------------------------------

## Soundbar

Power supply	100-240V~ 50/60Hz
Power consumption	20 W
Standby power consumption	Standard standby mode < 0.50 W Networked standby mode < 2.0 W
Frequency response	60Hz - 20KHz
Speakers impedance	8Ω x 2
USB direct version	2.0 Full Speed
USB	5V --- 500mA
Dimension (WxHxD)	766 x 67.3 x 91 mm
Weight	1.93 kg
Operating temperature	0°C - 45°C

## Remote control

Distance/Angle	6m/30°
Battery type	AAA (1.5V X 2)

## Supported audio formats

HDMI ARC	LPCM 2ch, LPCM 5.1ch, Dolby Digital, Dolby Digital plus, DTS Digital surround 5.1
Optical	LPCM 2ch, LPCM 5.1ch, Dolby Digital, DTS Digital surround 5.1
Bluetooth	SBC
USB	MP3 / WAV / FLAC

# 6 Troubleshooting

## Warning

- Risk of electric shock. Never remove the casing of the product.

To keep the warranty valid, never try to repair the product yourself.

If you have problems using this product, check the following points before you request service. If you still have a problem, get support at [www.philips.com/support](http://www.philips.com/support).

---

## Main unit

### The buttons on the main unit do not work.

- Disconnect from the power supply for a few minutes, then connect again.

### No power

- Ensure that the AC cord is properly connected.
- Ensure that there is power at the AC outlet.
- Press  button on the remote control or soundbar to turn the soundbar on.

---

## Sound

### No sound from the soundbar speaker.

- Connect the audio cable from your soundbar to your TV or other devices. However, you do not need a separate audio connection when:
  - the soundbar and TV are connected through HDMI ARC connection, or
  - a device is connected to the HDMI in connector on your soundbar.
- On the remote control, select the correct audio input.

- Make sure that the soundbar is not muted.
- When using either of the digital input, if there is no audio:
  - Try setting the TV output to PCM or
  - Connect directly to your Blu-ray/ other sources.
  - Some TVs do not pass through digital audio.
- Your TV may be set to variable audio output. Confirm that the audio output setting is set to FIXED or STANDARD, not VARIABLE. Refer to your TV's user manual for more detailed information.
- If using Bluetooth, ensure that the volume on your source device is turned up and that the device is not muted.

### Distorted sound or echo.

- If you play audio from TV through this product, make sure that the TV is muted.

---

## Bluetooth

### A device cannot connect with the soundbar.

- The device does not support the compatible profiles required for the soundbar.
- You have not enabled the Bluetooth function of the device. See the user manual of the device on how to enable the function.
- The device is not correctly connected. Connect the device correctly.
- The soundbar is already connected with another Bluetooth device. Disconnect the connected device, and then try again.

## Quality of audio play from a connected Bluetooth device is poor.

- The Bluetooth reception is poor. Move the device closer to the soundbar, or remove any obstacle between the device and the soundbar.

## I can't find the Bluetooth name of this unit on my Bluetooth device.

- Ensure the Bluetooth function is activated on your Bluetooth device.
- Re-pair the unit with your Bluetooth device.

---

## Remote control does not work

- Before you press any playback control button, first select the correct source.
- Reduce the distance between the remote control and the unit.
- Insert the battery with its polarities (+/-) aligned as indicated.
- Replace the battery.
- Aim the remote control directly at the sensor on the front of the unit.

# 7 Trademarks



The Adopted Trademarks HDMI, HDMI High-Definition Multimedia Interface, HDMI trade dress and the HDMI Logos are trademarks or registered trademarks of HDMI Licensing Administrator, Inc. in the United States and other countries.

## Dolby Audio

Dolby, Dolby Audio and the double-D symbol are registered trademarks of Dolby Laboratories Licensing Corporation.

Manufactured under license from Dolby Laboratories.

## Bluetooth®

The Bluetooth® word mark and logos are registered trademarks owned by Bluetooth SIG, Inc. and any use of such marks by MMD Hong Kong Holding Limited is under license. Other trademarks and trade names are those of their respective owners.



For DTS patents, see <http://patents.dts.com>. Manufactured under license from DTS, Inc. or DTS Licensing Limited. DTS, Digital Surround, Virtual:X, and the DTS logo are registered trademarks or trademarks of DTS, Inc. in the United States and other countries. © 2021 DTS, Inc. ALL RIGHTS RESERVED.





Specifications are subject to change without notice.  
Please visit [www.Philips.com/support](http://www.Philips.com/support) for the latest updates and documents.  
Philips and the Philips Shield Emblem are registered trademarks of Koninklijke Philips N.V. and are used under license.  
This product has been manufactured by and is sold under the responsibility of MMD Hong Kong Holding Limited or one of its affiliates, and MMD Hong Kong Holding Limited is the warrantor in relation to this product.