

PHILIPS

Soundbar

4000 Series

TAB4208



User manual

Register your product and get support at
www.philips.com/support

Contents

1	Important safety instructions	3
	Safety	3
	Care for your product	4
	Care of the environment	4
	Compliance	4
	Help and support	4
	FCC information	5

2	Your soundbar	6
	What's in the box	6
	Main unit	6
	Connectors	7
	Remote control	7
	Prepare the remote control	8
	Placement	9
	Wall mount	9

3	Connect	11
	Connect to HDMI ARC socket	11
	Connect to Optical socket	11
	Connect to AUX socket	12
	Connect to power	12

4	Use your soundbar	13
	Turn ON and OFF	13
	Select equalizer (EQ) effect	13
	Adjust the volume	14
	Factory reset	14
	Bluetooth operation	15
	USB operation	16
	AUX / OPTICAL / HDMI ARC operation	16

5	Product specifications	17
----------	-------------------------------	-----------

6	Troubleshooting	18
----------	------------------------	-----------

7	Trademarks	20
----------	-------------------	-----------

1 Important safety instructions

Read and understand all instructions before you use your product. If damage is caused by failure to follow instructions, the warranty does not apply.

Safety

Risk of electric shock or fire!

- Before you make or change any connections, make sure that all devices are disconnected from the power outlet.
- Never expose the product and accessories to rain or water. Never place liquid containers, such as vases, near the product. If liquids are spilt on or into the product, disconnect it from the power outlet immediately. Contact Consumer Care to have the product checked before use.
- Never place the product and accessories near naked flames or other heat sources, including direct sunlight.
- Never insert objects into the ventilation slots or other openings on the product.
- Where the mains plug or an appliance coupler is used as the disconnect device, the disconnect device shall remain readily operable.
- Battery (battery pack or batteries installed) shall not be exposed to excessive heat such as sunshine, fire or the like. Avoid exposing the battery to extremely low air pressure
- Disconnect the product from the power outlet before lightning storms.
- When you disconnect the power cord, always pull the plug, never the cable.
- Use the product in tropical and/or moderate climates.

Risk of short circuit or fire!

- For identification and supply ratings, see the type plate at the back or bottom of the product.
- Before you connect the product to the power outlet, ensure that the power voltage matches the value printed on the back or bottom of the product. Never connect the product to the power outlet if the voltage is different.

Risk of injury or damage to this product!

- For wall mounting, this product must be securely attached to the wall in accordance with the installation instructions. Use only the supplied wall mount bracket (if available). Improper wall mounting may result in accident, injury or damage. If you have any query, contact Consumer Care in your country.
- Never place the product or any objects on power cords or on other electrical equipment.
- If the product is transported in temperatures below 5°C, unpack the product and wait until its temperature matches room temperature before connecting it to the power outlet.
- Parts of this product can be made of glass. Handle with care to avoid injury and damage.
- Please use the product safely in an environment with temperature between 0°C and 45°C.

Risk of overheating!

- Never install this product in a confined space. Always leave a space of at least four inches around the product for ventilation. Ensure curtains or other objects never cover the ventilation slots on the product.

Risk of contamination!

- Do not mix batteries (old and new or carbon and alkaline, etc.).

- **CAUTION:** Danger of explosion if batteries are incorrectly replaced. Replace only with the same or equivalent type.
- Remove batteries if they are exhausted or if the remote control is not to be used for a long time.
- Batteries contain chemical substances, they should be disposed of properly.



Follow the instructions in the user manual!



WARNING!
Warning: Risk of electric shock!



The exclamation mark is intended to alert the user to the presence of important operating instructions.



Note

- The rating label is pasted on the bottom or back of the equipment.

Care for your product

Use only microfiber cloth to clean the product.

Care of the environment

Disposal of your old product and battery



Your product is designed and manufactured with high quality materials and components, which can be recycled and reused.



This symbol on a product means that the product is covered by European Directive 2012/19/EU.



This symbol means that the product contains batteries covered by European Directive 2013/56/EU which cannot be disposed of with normal household waste.

Inform yourself about the local separate collection system for electrical and electronic products and batteries. Follow local rules and never dispose of the product and batteries with normal household waste. Correct disposal of old products and batteries helps prevent negative consequences for the environment and human health.

Removing the disposable batteries

To remove the disposable batteries, see battery installation section.

Declaration of conformity

This product complies with the radio interference requirements of the European community.

Hereby, TP Vision Europe B.V. declares that the product is in compliance with the essential requirements and other relevant provisions of RED Directive 2014/53/EU and UK Radio Equipment Regulations SI 2017 No 1206. You can find the Declaration of Conformity on www.philips.com/support.

Help and support

For extensive online support, visit www.philips.com/support to:

- download the user manual and the quick start guide
- watch video tutorials (available only for selected models)

- find answers to frequently answered questions (FAQs)
- email us a question
- chat with our support representative.

Follow the instructions on the website to select your language, and then enter your product model number.

Alternatively, you can contact Consumer Care in your country. Before you contact, note down the model number and serial number of your product. You can find this information on the back or bottom of your product.

FCC information

NOTE: This equipment has been tested and found to comply with the limits for a Class B digital device, pursuant to Part 15 of the FCC Rules. These limits are designed to provide reasonable protection against harmful interference in a residential installation. This equipment generates, uses and can radiate radio frequency energy and, if not installed and used in accordance with the instructions, may cause harmful interference to radio communications.

However, there is no guarantee that interference will not occur in a particular installation. If this equipment does cause harmful interference to radio or television reception, which can be determined by turning the equipment off and on, the user is encouraged to try to correct the interference by one or more of the following measures:

- Reorient or relocate the receiving antenna.
- Increase the separation between the equipment and receiver.
- Connect the equipment into an outlet on a circuit different from that to which the receiver is connected.
- Consult the dealer or an experienced radio / TV technician for help.

FCC&IC Warning:

- This equipment should be installed and operated with minimum distance 20cm between the radiator & your body.
- Changes or modifications to this unit not expressly approved by the party responsible for compliance could void the user's authority to operate the equipment.

IC-Canada: CAN ICES-003(B)/NMB-003(B)

This device contains licence-exempt transmitter(s) / receiver(s) that comply with Innovation, Science and Economic Development Canada's licence-exempt RSS(s). Operation is subject to the following two conditions:

1. This device may not cause interference.
2. This device must accept any interference, including interference that may cause undesired operation of the device.

Avis d'Industrie Canada: CAN ICES-003 (B)/NMB-003(B)

L'émetteur/récepteur exempt de licence contenu dans le présent appareil est conforme aux CNR d'Innovation, Sciences et Développement économique Canada applicables aux appareils radio exempts de licence. L'exploitation est autorisée aux deux conditions suivantes :

1. L'appareil ne doit pas produire de brouillage;
2. L'appareil doit accepter tout brouillage radioélectrique subi, même si le brouillage est susceptible d'en compromettre le fonctionnement.

2 Your soundbar

Congratulations on your purchase, and welcome to Philips! To fully benefit from the support that Philips offers, register your soundbar at www.philips.com/support.

What's in the box

Check and identify the items in the package:

- Soundbar x 1
- Remote control x 1
- Adapter x 1
- Wall mount kit x 1
- Quick start guide x 1
- Warranty card x 1
- Wall mount template x 1

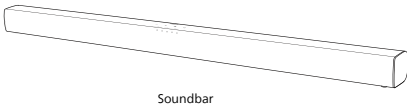

Soundbar

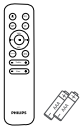

Remote control (AAA batteries x 2)



Wall mount kit (brackets x2 / wall mounting screws x2 / wall anchors x2)



Adapter: x1 pcs



Quick start guide



Warranty Card



Wall mount template

- Adapter and plug type vary by regions.
- Images, illustrations and drawings shown on this User Manual are for reference only, actual product may vary in appearance.

Main unit

This section includes an overview of the main unit.

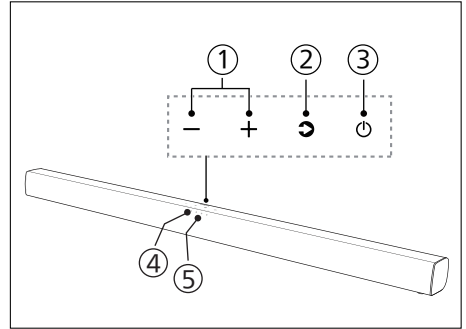

- ① **+/- (Volume) button**
Increase or decrease volume.
- ② **↻ (Source)**
Select an input source for the soundbar. Default source is HDMI ARC.
- ③ **⏻ (Standby-On) button**
Switch the soundbar On or to standby.
- ④ **Soundbar's LED indicator**
Switch the playback source and the front indicator lights up accordingly. The indicator light on the front of the main unit will show which mode is currently in use.

Status	LED state
AUX	[AUX/USB] Solid white
USB	[AUX/USB] Blinking white
Standby	[Standby] Solid red
BT(Bluetooth)	
• Connected	[BT] Solid white
• disconnected	[BT] Blinking white
OPTICAL	
• Supported	[OPT] Solid white
• Unsupported	[OPT] Blinking white
HDMI ARC	
• Supported	[HDMI ARC] Solid white
• Unsupported	[HDMI ARC] Blinking white

- ⑤ **Remote control sensor**

Connectors

This section includes an overview of the connectors available on your soundbar.

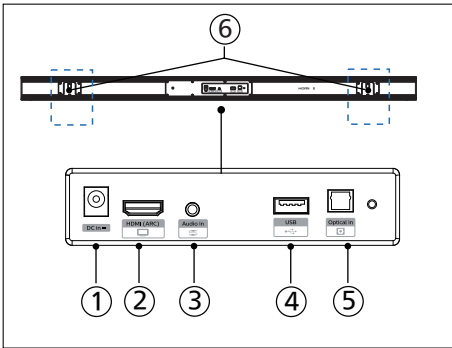

- ① **DC in**
Connect to the power supply.
- ② **HDMI out (ARC)**
Connect to the HDMI (ARC) input on the TV.
- ③ **Audio in**
Audio input from, for example, an MP3 player (3.5mm jack).
- ④ **USB**
 - Connect to a USB storage device for audio media play.
 - Upgrade software of this product.
- ⑤ **Optical in**
Connect to an optical audio output on the TV or a digital device.
- ⑥ **Wall bracket slot.**

Remote control

This section includes an overview of the remote control.

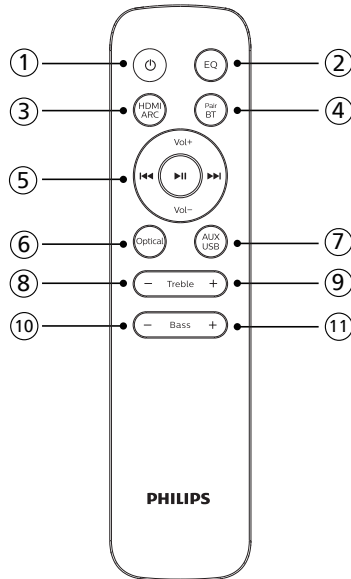

- ① **⏻ (Standby-On) button**
 - Switch the soundbar On or to standby.
- ② **EQ (Mode)**
Select from the four EQ modes: Movie/Music/Voice/Stadium.
- ③ **HDMI ARC**
Switch your source to HDMI ARC connection.
- ④ **Pair / BT**
Short press to switch to Bluetooth source. The soundbar will reconnect to the last paired device if it's available. Press and hold for 3 seconds to disconnect from all Bluetooth devices and enter pairing mode.

- ⑤ **⏮ / ⏭** (Previous / Next)
Skip to the previous or next track in USB/ BT mode.
▶|| (Play / Pause)
Start, pause or resume play in USB/ BT mode.
VOL+ / VOL- (System volume)
Increase /decrease system volume level.
- ⑥ **Optical**
Switch your audio source to the optical connection.
- ⑦ **AUX/USB :**
Switch your audio source to the AUX/USB connection.
- ⑧ **- Treble**
Decrease the soundbar's treble volume.
- ⑨ **+treble**
Increase the soundbar's treble volume.
- ⑩ **-Bass**
Decrease the soundbar's bass volume.
+Bass
- ⑪ Increase the soundbar's bass volume.

Prepare the remote control

- The provided remote control allows the unit to be operated from a distance.
- Even if the remote control is operated within the effective range 19.7 feet (6m), remote control operation may be impossible if there are any obstacles between the unit and the remote control.
- If the remote control is operated near other products which generate infrared rays, or if other remote control devices using infra-red rays are used near the unit, it may operate incorrectly. Conversely, the other products may operate incorrectly.

Replace the remote control battery

Slide to remove the battery compartment cover, insert 2 AAA batteries (1.5V) with correct polarity, then slide the battery compartment cover back into position.

- Make sure the (+) and (-) ends of the batteries match the (+) and (-) ends indicated in the battery compartment.

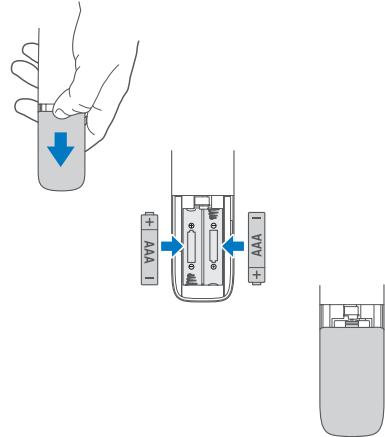

Precautions concerning batteries

- Be sure to insert the batteries with correct positive "⊕" and negative "⊖" polarities.
- Use batteries of the same type. Never use different types of batteries together.
- Either rechargeable or non-rechargeable batteries can be used. Refer to the precautions on their labels.
- Be aware of your fingernails when removing the battery cover and the battery.
- Do not drop the remote control.
- Do not allow anything to impact the remote control.
- Do not spill water or any liquid on the remote control.

- Do not place the remote control on a wet object.
- Do not place the remote control under direct sunlight or near sources of excessive heat.
- Remove the battery from the remote control when not in use for a long period of time, as corrosion or battery leakage may occur and result in physical injury, and/or property damage, and/or fire.
- Do not use any batteries other than those specified
- Do not mix new batteries with old ones.
- Never recharge a battery unless it is confirmed to be a rechargeable type.

Placement

Place your soundbar as shown below.

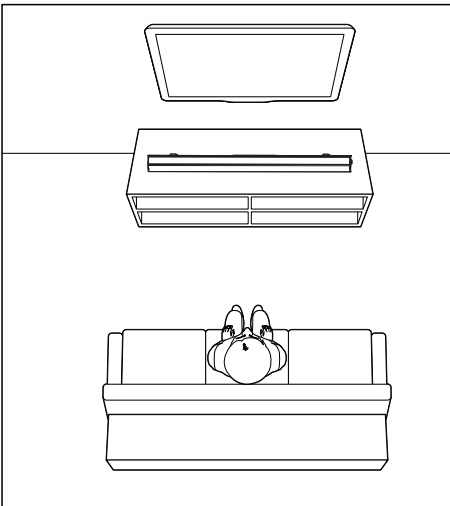

Wall mount

Note

- Improper wall mounting may result in accident, injury or damage. If you have any query, contact Consumer Care in your country.
- Before wall mounting, make sure the wall can support the weight of your soundbar.
- Before wall mounting, you need not remove the rubber feet at the bottom of the soundbar, otherwise the rubber feet cannot be fixed back.
- Depending on the type of wall mounting, make sure that you use screws of a suitable length and diameter.
- Please check whether the USB port on the back of the soundbar is connected to a USB device. If it is found that the connected USB device affects the wall-mount, you need to use another USB device of the appropriate size.

Screw length/diameter

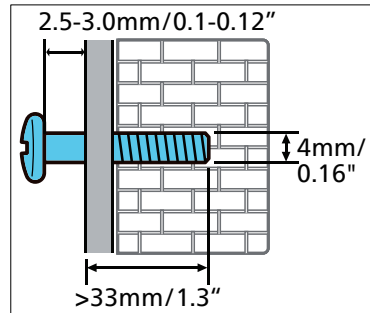

Suggested wall mounting height

You are recommended to install the TV first before wall mounting the soundbar. With a TV preinstalled, wall mount the soundbar 50mm/2.0" in distance from the bottom of the TV.

WARNING !

- To prevent injury, this apparatus must be securely attached to the floor/wall in accordance with the installation instructions.
- Suggested wall mounting height: ≤ 1.5 meters.

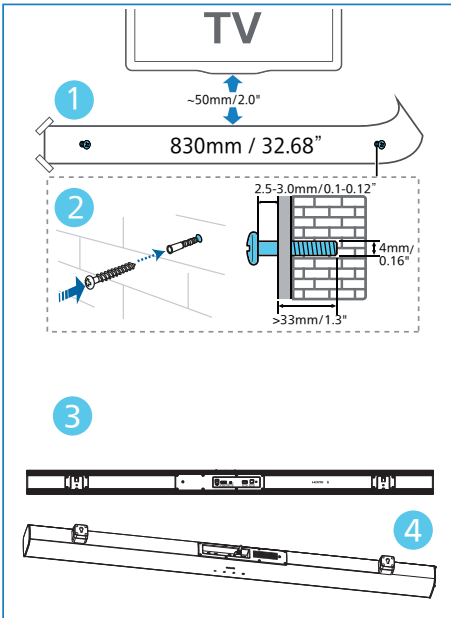

- 1 Drill 2 parallel holes (diameter 3-8mm each according to wall type) on the wall.
 - ↳ The distance between the holes are: **830mm / 32.68"**
 - ↳ You can use the wall mount template provided for helping the drilling holes position on the wall.
- 2 Secure the dowels and screws in the holes.
 - ↳ Be sure to leave a **2.5-3.0mm** gap between the wall and the screw's head.
- 3 Hang the soundbar on the fastening screws.

3 Connect

This section helps you connect your soundbar to a TV and other devices, and then set it up.

For information about the basic connections of your soundbar and accessories, see the quick start guide.

Note

- For identification and supply ratings, see the type plate at the back or bottom of the product.
- Before you make or change any connections, make sure that all devices are disconnected from the power outlet.

Connect to HDMI ARC

Your soundbar supports HDMI with audio return channel (ARC). If your TV is HDMI ARC compliant, you can hear the TV audio through your soundbar by using a single HDMI cable.

- 1 On your TV, turn on HDMI-CEC operations. For details, see the TV user manual

The **HDMI ARC** connector on the TV might be labeled differently. For details, see the TV user manual.

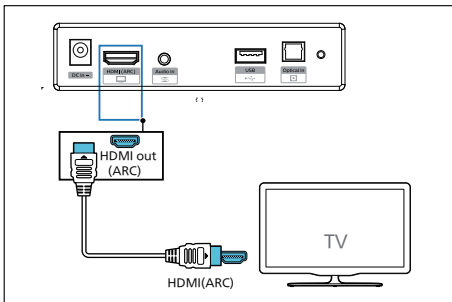

- 2 Using a High Speed HDMI cable, connect the **HDMI ARC** connector on your soundbar to the **HDMI ARC** connector on the TV.

Note

- Your TV must support the HDMI-CEC and ARC function. HDMI-CEC and ARC must be set to On.
- The setting method of HDMI-CEC and ARC may differ depending on the TV. For details about ARC function, please refer to your TV user manual.
- Make sure to use the HDMI cables that can support the ARC function.

Connect to Optical socket

- Using an optical cable, connect the **Optical** connector on your soundbar to the **Optical out** connector on the TV or other device.

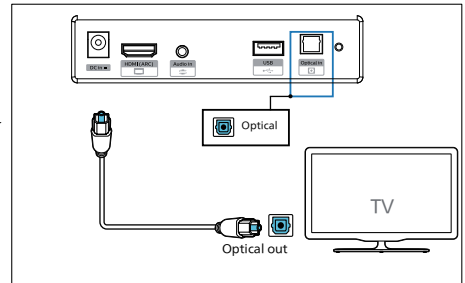

- The digital optical connector might be labeled **Spdif** or **Spdif out**.

Connect to AUX socket

- Use a 3.5mm to 3.5mm audio cable to connect the TV's headphone socket to the AUX socket on the unit.

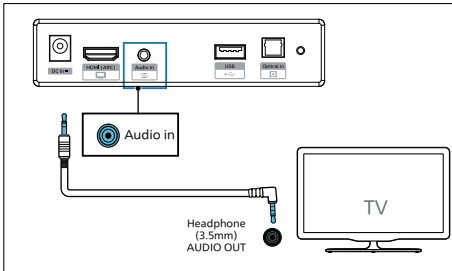

- Use an RCA to 3.5mm audio cable to connect the TV's audio output sockets to the AUX socket on the unit.

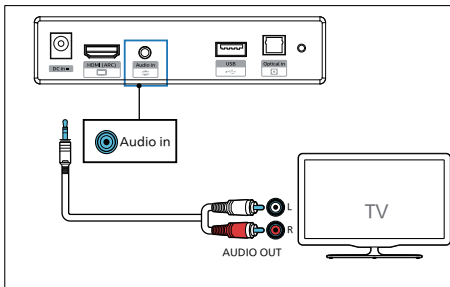

Connect to power

- Before connecting the AC power cord, ensure you have completed all other connections.
 - Risk of product damage! Ensure that the power supply voltage corresponds to the voltage printed on the back or the underside of the unit.
- 1 Connect the mains cable to the DC~ socket of the unit and then into a mains socket.

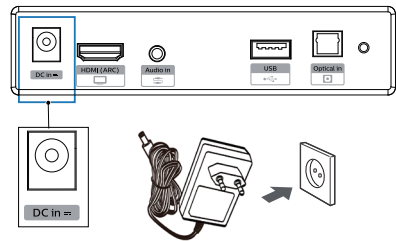

- * Adapter and plug type vary by regions.

4 Use your soundbar

This section helps you use the soundbar to play audio from connected devices.

Before you start

- Make the necessary connections described in the quick start guide and the user manual.
- Switch the soundbar to the correct source for other devices.

Turn ON and OFF

- When you first connect the unit to the main socket, the unit will be in STANDBY mode. The [Standby] indicator will light up.
- Press the  button on the remote control or on the main unit to switch the main unit ON or OFF.
- Disconnect the main plug from the main socket if you want to switch the unit off completely.

Auto standby

The unit automatically turns to standby mode after about 15 minutes if the TV or the external unit is disconnected or switched off.

- To switch the unit off completely, remove the mains plug from the mains socket.
- Please turn the unit off completely to save energy when not in use.

Select source

- 1 Press the  button repeatedly on the unit or press the **AUX/USB, Optical, HDMI ARC, Pair/BT,** buttons on the remote control to select the desired mode.

The indicator light on the soundbar will show which mode is currently in use.

Status	LED state
AUX	[AUX/USB] Solid white
USB	[AUX/USB] Blinking white
Standby	[Standby] Solid red
Pair/BT	
• Connected	[BT] Solid white
• disconnected	[BT] Blinking white
OPTICAL	
• Supported	[OPT] Solid white
• Unsupported	[OPT] Blinking white
HDMI ARC	
• Supported	[HDMI ARC] Solid white
• Unsupported	[HDMI ARC] Blinking white

Select equalizer (EQ) effect

Select predefined sound modes to suit you video or music.

- 1 Press the **EQ** button on the remote control to select your desired preset equalizer effects. Default mode is **Movie**
- **Movie** (5 LEDs ON): Create a surround listening experience. Ideal for watching movies.
 - **Music** (4 LEDs ON): Create two-channel or multichannel stereo sound. Ideal for listening to music.
 - **Voice** (3 LEDs ON): Create sound effect which makes human voice more clear and outstanding for listening.

- **Stadium (2 LEDs ON):** Create an atmosphere as if watching a sports game in a stadium.

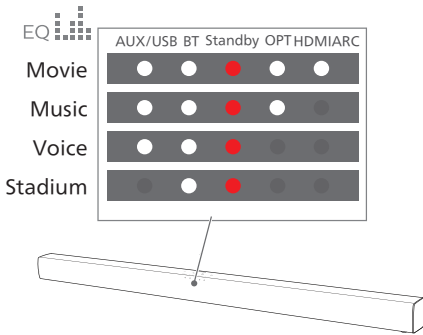

Adjust the volume

When adjusting the volume of the soundbar, the status indicator will increase / decrease the amount of light. According to the corresponding light display / blinking, determine the current volume level of the soundbar .

Adjust the volume

- 1 Press **+/-** on the soundbar or press **Vol+ /Vol-** on the remote control to increase /decrease the volume level.

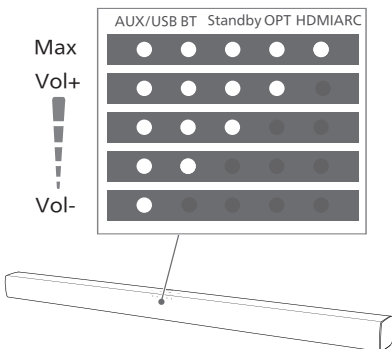

Adjust the treble and bass volume

- 2 Press - **Bass +**
Press **-Bass +** on the remote control to increase/decrease Bass's volume.

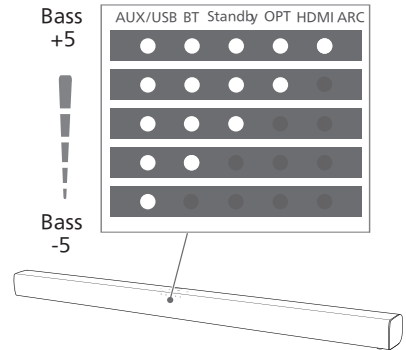

- 3 Press - **Treble +**
Press **-Treble +** on the remote control to increase/decrease Treble's volume.

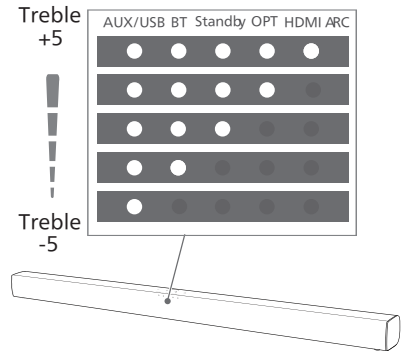

By default, the Bass/Treble is set to 0.

Factory reset

Reset device to default setting.

- 1 Turn on the soundbar.
- 2 Press and hold local keys **+** and **-** for 8 secs. After all LEDs light up for 5 seconds , the [Standby] LED is in solid red.
- 3 The soundbar reboots.

Bluetooth operation

Through Bluetooth, connect the soundbar with your Bluetooth device (such as an iPad, iPhone, iPod touch, Android phone, or laptop), and then you can listen to the audio files stored on the device through your soundbar.

What you need

- A Bluetooth device which supports Bluetooth profile A2DP, AVRCP and is with Bluetooth version 5.0 + EDR.
- The maximum operational range between the soundbar and a Bluetooth device is approximately 10 meters (30 feet).

- 1 Press the  button on the unit or press **Pair/BT** button on the remote control to switch the soundbar to Bluetooth mode.
→ The [BT] indicator will blink.
- 2 On the Bluetooth device, switch on Bluetooth, search for and select **Philips TAB4208** to start connection (see the user manual of the Bluetooth device on how to enable Bluetooth).
→ During connection, the [BT] indicator will blink.
- 3 Wait until you hear the voice prompt from the soundbar.
→ If successfully connected, the [BT] indicator will light up solidly.
- 4 Select and play audio files or music on your Bluetooth device.

- During play, if a call comes in, music play pauses. Play resumes when the call ends.
- If your Bluetooth device supports AVRCP profile, on the remote control you can press **⏮ / ⏭** to skip to a track, or press **⏸** to pause/resume play.

- 5 To disconnect Bluetooth connection and pair a new Bluetooth device:

- Long press the **Pair/BT** button on the remote control to disconnect Bluetooth connection and enter pairing mode.

Note

- In an open space without obstructions, the maximum operational range between the soundbar and a Bluetooth device is approximately 10 meters (30 feet).
- Compatibility with all Bluetooth devices is not guaranteed.
- The music streaming may be interrupted by obstacles between the device and soundbar, such as wall, metallic casing that covers the device, or other devices nearby that operate in the same frequency.

USB operation

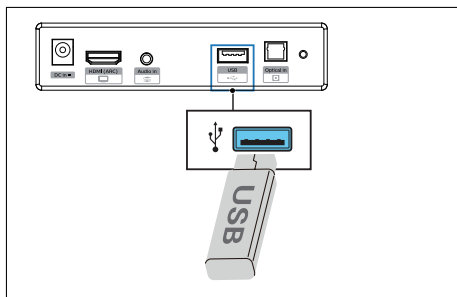

Enjoy audio on a USB storage device, such as an MP3 player and USB flash memory, etc.

- 1 Insert the USB device.



- 2 Press the  button repeatedly on the unit or press the **USB** button on the remote control to select **USB** mode.
↳ [AUX/USB] LED indicator blinks white.

- 3 During playback:

Button	Action
	Start, pause or resume play
	Skip to the previous track
	Skip to the next track

Tips

- This product may not be compatible with certain types of USB storage devices.
- If you use a USB extension cable, USB hub, or USB Multifunctional card reader, the USB storage device may not be recognized.
- Do not remove the USB storage device during file reading.
- This product can support USB devices with up to 128 GB of memory.
- This product can play MP3, WAV, FLAC.
- Support a USB port: 5V === 500mA.

AUX / Optical / HDMI ARC operation

Ensure that the unit is connected to the TV or audio device.

- 1 Press the  button repeatedly on the unit or press the **AUX/USB**, **Optical**, **HDMI ARC** buttons on the remote to select the desired mode.
↳ The indicator light on the soundbar will show which mode is currently in use.

Status	LED State
AUX	[AUX/USB] Solid white
OPTICAL	[OPTICAL] Solid white or blinking
HDMI ARC	[HDMI ARC] Solid white or blinking

- 2 Operate your audio device directly for playback features.
- 3 Press the +/- (volume) buttons to adjust the volume to your desired level.

Tip

- While in **Optical/HDMI ARC** mode, if there's no sound output from the unit and the status indicator flashes, you may need to activate **PCM** signal output on your source device (e.g. TV, DVD or Blu-ray player).

5 Product specifications

Note

- Specifications and design are subject to change without notice.

Bluetooth

Bluetooth profiles	A2DP, AVRCP
Bluetooth version	V 5.3
Bluetooth frequency band	2402-2480 MHz
Transmitter power	≤ 4dBm

Amplifier section

Output power	Max 60W / RMS 30W @THD≤10%;
--------------	--------------------------------

Soundbar

Adapter	Input: 100-240V, 50/60Hz, 1.0A Output: 24V \equiv 1.5A 
Power consumption	30 W
Standby consumption	< 0.5 W
USB	5V \equiv 500mA
Frequency response	50Hz - 18KHz
Impedance	8Ω
Dimension (W x H x D)	1100x67x88 mm
Weight	2.3kg
Operating temperature	0°C - 45°C

Remote control

Distance/Angle	6m/30°
Battery type	AAA (1.5V X 2)

Supported Audio formats

HDMI ARC

- PCM 2ch

Optical

- PCM 2ch

BLUETOOTH

- SBC

USB

- MP3, WAV, FLAC

6 Troubleshooting



Warning

- Risk of electric shock. Never remove the casing of the product.

To keep the warranty valid, never try to repair the product yourself.

If you have problems using this product, check the following points before you request service. If you still have a problem, get support at www.philips.com/support.

Main unit

The buttons on the main unit do not work.

- Disconnect from the power supply for a few minutes, and then connect again.

No power

- Ensure that the AC cord is properly connected.
- Ensure that there is power at the AC outlet.
- Press  button on the remote control or soundbar to turn the soundbar on.

Sound

No sound from the soundbar speaker.

- Connect the audio cable from your soundbar to your TV or other devices. However, you do not need a separate audio connection when:
 - the soundbar and TV are connected through HDMI ARC connection, or
 - a device is connected to the HDMI in connector on your soundbar.
- On the remote control, select the correct audio input.
- Make sure that the soundbar is not muted.

- Reset this product to its factory settings (see "Factory reset")

Distorted sound or echo.

- If you play audio from TV through this product, make sure that the TV is muted.

Bluetooth

A device cannot connect with the soundbar.

- The device does not support the compatible profiles required for the soundbar.
- You have not enabled the Bluetooth function of the device. See the user manual of the device on how to enable the function.
- The device is not correctly connected. Connect the device correctly.
- The soundbar is already connected with another Bluetooth device. Disconnect the connected device, and then try again.

Quality of audio play from a connected Bluetooth device is poor.

- The Bluetooth reception is poor. Move the device closer to the soundbar, or remove any obstacle between the device and the soundbar.

I can't find the Bluetooth name of this unit on my Bluetooth device.

- Ensure the Bluetooth function is activated on your Bluetooth device.
- Re-pair the unit with your Bluetooth device.

Remote control does not work.

- Before you press any playback control button, first select the correct source.
- Reduce the distance between the remote control and the unit.
- Insert the battery with its polarities (+/-) aligned as indicated.
- Replace the battery.
- Aim the remote control directly at the sensor on the front of the unit.

The soundbar turns off.

- When the unit's external input signal level is too low, the unit will turn off automatically in 15 minutes. Please increase the volume level of your external device.

Trademarks:



The Adopted Trademarks HDMI, HDMI High-Definition Multimedia Interface, HDMI trade dress and the HDMI Logos are trademarks or registered trademarks of HDMI Licensing Administrator, Inc. in the United States and other countries.



The Bluetooth® word mark and logos are registered trademarks owned by Bluetooth SIG, Inc. and any use of such marks by MMD Hong Kong Holding Limited is under license. Other trademarks and trade names are those of their respective owners.



Specifications are subject to change without notice. Please visit www.Philips.com/support for the latest updates and documents. Philips and the Philips Shield Emblem are registered trademarks of Koninklijke Philips N.V. and are used under license.

This product has been manufactured by and is sold under the responsibility of MMD Hong Kong Holding Limited. or one of its affiliates, and MMD Hong Kong Holding Limited. is the warrantor in relation to this product.