

**PHILIPS  
NORELCO**  
QP2630



BC

Manufactured for:  
Philips Personal Health  
a division of Philips North America LLC  
P.O. Box 10313, Stamford, CT 06904  
USA



This symbol on the product's nameplate means it is listed by Underwriters' Laboratories, Inc.

Norelco is a registered trademark of Philips North America LLC.

PHILIPS and Philips shield are registered trademarks of Koninklijke Philips N.V.

©2021 Philips North America LLC. All rights reserved.

4222.002.8907.3 (5/21/2021)

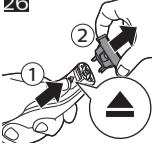
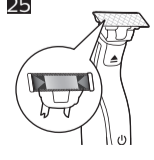
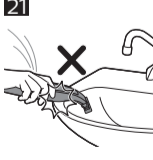
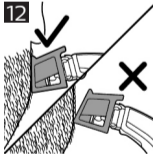
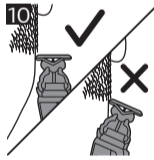
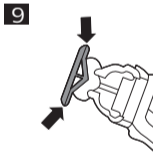
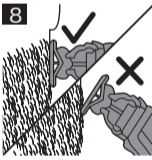
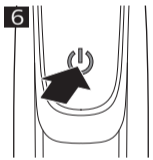
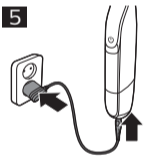
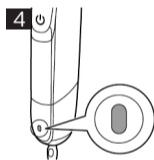
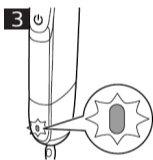
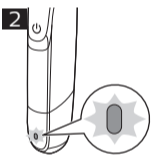

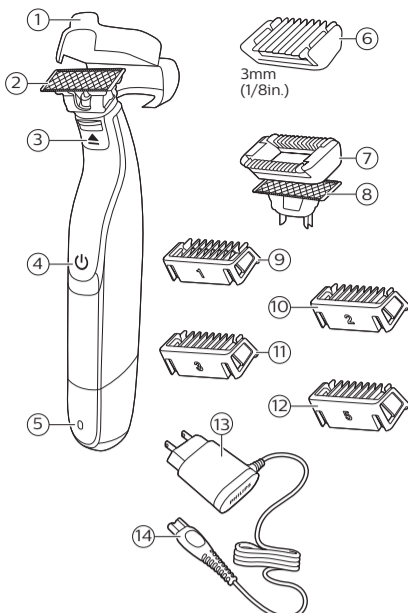
**1**

English

## IMPORTANT SAFETY INSTRUCTIONS

When using an electric product, basic precautions should always be followed, including the following:

**Read all instructions before using this product.**

### DANGER

**To reduce the risk of electric shock:**

- Do not reach for a corded product that has fallen into water. Unplug immediately from the power outlet.
- Keep the power cord dry.
- Do not place or store the product where it can fall or be pulled into a tub or sink. Do not place or drop the product into water or other liquid.
- Except when charging, always unplug this product from the power outlet immediately after use.
- Detach the hand-held part from the supply cord before cleaning it in water.
- Plug power cord directly into power outlet. Do not use an extension cord.

### WARNING

**To reduce the risk of burns, fire, electric shock, or injury to persons:**

- This appliance is not intended for use by persons (including children) with reduced physical, sensory or mental capabilities, or lack of experience and knowledge, unless they have been given supervision or instruction concerning use of the appliance by a person responsible for their safety.
- Children should be supervised to ensure that they do not play with the appliance.
- Use this product only for its intended household use as described in this manual. Do not use attachments not recommended by Philips North America LLC.
- Never operate this product if it has a damaged power cord, if it is not working properly, after it has been dropped or damaged, or after the product or power cord has been dropped into water. For assistance call 1-800-243-3050.
- Keep the product, cord, charging plug and any attachments away from heated surfaces.
- Never drop or insert any object into any opening.
- Do not use the power cord in or near a power outlet that contains an electric air freshener to prevent damage to the power cord.
- Do not use product outdoors or operate where aerosol (spray) products are being used or where oxygen is being administered.
- Always check cutters, cutting unit and guards before using the product. Do not use the product if cutters, cutting unit or guards are damaged, as injury may occur.

- Always attach power cord to product first, then to power outlet. To disconnect, set all controls to 'off' position. Then remove power cord from power outlet.
- Unplug power cord before plugging in or unplugging the product.
- Only use the power cord and other accessories supplied with the product.
- Do not attempt to open the product to remove or replace the built-in rechargeable battery.
- The batteries used in this product may present a fire or chemical burn hazard if mistreated. Do not disassemble, heat above 100 °C (212 °F) or incinerate.

**IMPORTANT:** The power plug contains a transformer. Do not cut off the power plug to replace it with another plug as this will cause a hazardous condition.

## SAVE THESE INSTRUCTIONS

### Introduction

Congratulations on your purchase and welcome to Philips Norelco!

To fully benefit from the support that Philips Norelco offers, register your product at [www.norelco.com/register](http://www.norelco.com/register).

### General description (Fig. 1)

- 1 Protective cap
- 2 OneBlade (for face)
- 3 Blade release slide switch
- 4 On/off button
- 5 Battery charge indicator
- 6 Click-on body comb 3mm (1/8in.)
- 7 Click-on skin guard
- 8 OneBlade (for body)
- 9 Click-on stubble comb 1mm (3/64in.)
- 10 Click-on stubble comb 2mm (5/64in.)
- 11 Click-on stubble comb 3mm (1/8in.)
- 12 Click-on stubble comb 5mm (3/16in.)
- 13 Power plug
- 14 Small plug



This symbol indicates that the product can be used in the bath or shower.

### Charging

Charging takes approx. 4 hours.

Charge the product before first use and when the display indicates that the battery is almost empty.

- Charging or using the product at temperatures below 40°F (4,5°C) or higher than 95°F (35°C) adversely affects the lifespan of the battery.
- If the product is subjected to a major change in temperature, pressure or humidity, let the product acclimatize for 30 minutes before use.

### Battery status indicator

- When the battery status indicator flashes orange, the battery is almost empty (Fig. 2).
- When the product is charging, the battery status indicator flashes green (Fig. 3).
- When the battery is fully charged, the battery status indicator lights up green continuously (Fig. 4).

Note: Approx. 30 minutes after the battery is fully charged or when you disconnect the product from the outlet, the battery status indicator switches off automatically.

### Charging with the power cord

- 1 Make sure the product is switched off.
- 2 Insert the small plug into the product and put the power plug in any 120V AC outlet (Fig. 5).
- 3 After charging, remove the power plug from the wall outlet and pull the small plug out of the product.

### Operating time

When the product is fully charged, it has a cordless operating time of up to 60 minutes.

Note: An adapter plug may be necessary for cord usage in some foreign countries. Use an attachment plug adapter of the proper configuration for the power outlet.

## Using the product

**Your product comes with 2 blades. Use one blade for your face only and the other blade for your body.**

**The face blade and the stubble combs are for use on facial hair. It is not intended for shaving, edging or trimming hairs on lower body parts or scalp hair.**

**The body blade and body comb are for use on body parts below the neck.**

**The body blade with the skin guard attached are for use on sensitive body areas.**

Note: This product is for cordless use only.

- Use this product for its intended household use as described in this manual.
- For hygienic reasons, the product should only be used by one person.
- Use the product with the face blade to trim, edge or shave facial hair (beard, moustache and sideburns). Trim with the stubble comb to obtain a certain length and edge to create perfect edges and sharp lines.
- Use the product with the body blade to trim and/or shave your body hair. Shave your chest without the skin guard or body comb, shave your sensitive areas (e.g. groin, armpits) with the skin guard, use the body comb to trim your body.
- Take your time and practice to give your skin time to adjust.

### Switching the product on and off

- 1 Press the on/off button once to switch the product on or off (Fig. 6).

### Face

#### Shaving

- Shave off any length of hair. The product does not shave as close as a traditional blade so your skin will stay comfortable.
- Make sure that the blade is in full contact with the skin by placing it flat on the skin.
- For the best result, move the product against the grain.
- Make long strokes while pressing lightly.
- Use the product dry or wet with gel or foam, even in the shower.
- Shaving a clean beard and face gives the best results.

- 1 Switch on the product (Fig. 6).
- 2 Place the blade on the skin and move the product upwards or against the grain in long strokes while pressing lightly (Fig. 7).

Note: Make sure you hold the surface of the blade flat against your skin (Fig. 8).

- 3 Switch off and clean the product after each use (see 'Cleaning').

#### Edging

- Use both edges of the blade to create sharp lines and perfect edges.
  - Hold the product in such a way that the blade is perpendicular to the skin and one of its edges touches the skin. This allows more precise detailing of sideburns and the area around the mouth and nose.
- 1 To create sharp edges and lines, you can use either edge of the blade (Fig. 9).
  - 2 Switch on the product (Fig. 6).
  - 3 Place the edge of the blade perpendicular onto the skin (Fig. 10).
  - 4 Make straight strokes while applying gentle pressure (Fig. 11).
  - 5 Switch off and clean the product after each use (see 'Cleaning').

#### Trimming with comb

- The click-on stubble combs allow you to trim hair to different lengths.
- This product comes with 4 click-on stubble combs: 5mm (3/16in.), 3mm (1/8in.), 2mm (5/64in.) and 1mm (3/64in.).
- Start with the 5mm (3/16in.) comb to acquire practice with this product.
- The indication on each comb corresponds to the remaining hair length in millimeters.
- Always make sure that the tips of the click-on stubble comb point in the direction in which you move the product.

- Make sure that the flat part of the comb is always in full contact with the skin to obtain an even trimming result (Fig. 12).
  - Since all hairs do not grow in the same direction, you may want to try different trimming positions (i.e. upwards, downwards, or across). Practice is best for optimum results.
  - Trimming is easier when the skin and hair are dry.
- 1 Place the comb onto the blade, with the teeth of the comb pointing upwards (Fig. 13).

Note: For best results, always trim in the direction of the teeth of the comb.

- 2 Switch on the product (Fig. 6).
- 3 Place the comb onto the skin and move the product upwards slowly, against the grain (Fig. 14).
- 4 Switch off and clean the product after each use (see 'Cleaning').
- 5 To remove the comb, hold it on both sides and pull it off the blade (Fig. 15).

### Body

- For hygienic reasons, only use the body blade for trimming and shaving your body.
- For body trimming and shaving, make sure the hair is clean and dry as wet hair tends to stick to the body.
- When shaving sensitive areas, always use the skin guard.
- Since all hairs do not grow in the same direction, you may want to try different trimming directions (i.e. upwards, downwards, or across). Practice is best for optimum results.
- For the best result, move the product against the grain.
- Make long strokes while pressing lightly.
- Use the product dry or wet with gel or foam, even in the shower.
- Shaving a clean body gives the best results.

### Shaving with skin guard

For optimal performance, use the skin guard only on sensitive areas (for example the groin and armpits).

- 1 Hold the skin guard on both sides and press it onto the blade (Fig. 16).
- 2 Switch on the product (Fig. 6).
- 3 Place the skin guard onto the skin and stretch the skin with your free hand. Move the product upwards slowly, against the grain (Fig. 17).
  - When using the product on your armpits, raise your arm and put your hand on the back of your head to stretch the skin.
  - Regularly remove cut hair from the guard. If a lot of hair has accumulated in the guard, remove it from the product and blow and/or shake out the hairs.
- 4 Switch off and clean the product after each use.
- 5 To remove the skin guard, put one finger under the edge of the guard and press on the blade with your thumb (Fig. 18).

### Shaving without skin guard

The body blade without the skin guard allows you to shave hair on your body below the neckline (for example the chest and armpits).

- 1 To remove the skin guard, put one finger under the edge of the guard and press on the blade with your thumb (Fig. 18).
- 2 Switch on the product (Fig. 6).
- 3 Place the blade on the skin and move the product against the grain in long strokes while pressing lightly. Stretch the skin with your free hand.

Note: Make sure you hold the surface of the blade flat against your skin (Fig. 8).

- When you use the product on your armpits, raise your arm and put your hand on the back of your head to stretch the skin.
- 4 Switch off and clean the product after each use (see 'Cleaning').

### Trimming with body comb

The 3mm (1.8in.) body comb allows you to trim hair on your body below the neckline (for example chest, armpits, groin).

- 1 Hold the body comb on both sides and press onto the blade (Fig. 19).
- 2 Switch the product on.

- 3 Place the comb onto the skin and stretch the skin with your free hand. Move the product upwards slowly, against the grain (Fig. 20).
  - Make sure that the flat part of the comb is always in full contact with the skin to obtain an even trimming result (Fig. 12).
  - When you use the product on your armpits, raise your arm and put your hand on the back of your head to stretch the skin.
  - Regularly remove cut hair from the guard. If a lot of hair has accumulated in the guard, remove it from the product and blow and/or shake out the hairs.
- 4 Switch off and clean the product after each use (see 'Cleaning').
- 5 To remove the comb, hold it on both sides and pull it off the blade (Fig. 15).

## Cleaning

Clean the product after every use.

**Never use scouring pads, abrasive cleaning agents or aggressive liquids such as gasoline or acetone to clean the product.**

**Do not tap the product or blade against a surface to remove hairs and water as this may cause damage to the product and blade (Fig. 21). If the blade is damaged, replace immediately.**

**Never dry the blade with a towel or tissue, as this may cause damage.**

### Cleaning the product

- 1 Switch the product off.
- 2 Remove any comb or skin guard from the blade (Fig. 15).
- 3 Blow off any hairs that have accumulated on the blade and/or combs.
- 4 Switch on the product for approx. 15 seconds while rinsing the blade with lukewarm water (Fig. 22).
- 5 Rinse the combs for approx. 15 seconds with lukewarm water.
- 6 Carefully shake off excess water and let all parts air dry completely.

Note: The blade is fragile. Handle it carefully. Replace the blade immediately if it is damaged.

This product has no other user-serviceable parts. For assistance call 1-800-243-3050.

## Storage

- Attach the body comb on the body blade to protect the blade from damage.

Always attach the protective cap on the blade to protect the blade from damage during traveling or storage.

Make sure the product and attachments are completely dry before you store them for the next use.

- 1 Place the protective cap onto the edge of the blade (Fig. 23).
  - 2 Close the protective cap (Fig. 24).
- Be sure the product is switched off. Remove the power cord from power outlet and the product before storing it in a safe, dry location where it will not be crushed, banged, or subject to damage.
  - Do not wrap cord around the product when storing.
  - Store cord and other accessories in a safe location where these will not be cut or damaged.
  - Do not place or store the product where it can fall or be pulled into a tub or sink, water or other liquid while plugged in.

## Replacement

### Blade wear indicator

For optimal cutting and gliding performance, replace the blade every 4 months or when it no longer provides the shaving or trimming results you expect. This advice is based on two full shaves a week and actual results may vary.

The blade is equipped with a blade wear indicator. A green bar will gradually appear on the blade as you use it (Fig. 25). When it is highly visible, it is recommended to replace your blade for the best OneBlade experience. Replace the blade when you are not satisfied with its performance.

Always replace with an original Philips Norelco blade (see 'Accessories').

Depending on your usage behavior, the exact lifetime of the blade could be longer or shorter. Similar to a manual blade, the blade becomes blunt over time, which results in increased hair pulling and reduced cutting performance.

### Replacing the blade

- 1 Make sure that the product is switched off.
- 2 Carefully push the blade release slide switch upwards while holding the blade on both sides (Fig. 26). This prevents the blade from being ejected from the handle.
- 3 Hold the new blade on both sides and press it onto the handle ('click') (Fig. 27).

Note: Be careful, the edges of the blade are sharp. When you hear a click, the new blade is placed correctly and ready for use.

### Accessories

Replacement parts and accessories may be purchased at a store near you or on our website [www.philips.com/store](http://www.philips.com/store).

The following accessories are available:

- Model QP210 Philips Norelco Replacement Blade, 1-Pack
- Model QP220 Philips Norelco Replacement Blade, 2-Pack
- Model QP230 Philips Norelco Replacement Blade, 3-Pack

### Assistance

For assistance, visit our website:

[www.philips.com/support](http://www.philips.com/support) or call toll free 1-800-243-3050.

Online information is available 24 hours a day, 7 days a week.

### Disposal

- This product contains a rechargeable lithium-ion battery which must be disposed of properly.
- Contact your local town or city officials for battery disposal information. You can also call 1-800-822-8837 or visit [www.call2recycle.org](http://www.call2recycle.org) for battery drop-off locations.
- For assistance, visit our website [www.philips.com/support](http://www.philips.com/support) or call 1-800-243-3050 toll free.
- Your product is designed and manufactured with high quality materials and components, which can be recycled and reused. For recycling information, please contact your local waste management facilities or visit [www.recycle.philips.com](http://www.recycle.philips.com).

### Full Two-Year Warranty

Philips North America LLC warrants this new product (except blade) against defects in materials or workmanship for a period of two years from the date of purchase, and agrees to repair or replace any defective product without charge.

**IMPORTANT:** This warranty does not cover damage resulting from accident, misuse or abuse, lack of reasonable care, the affixing of any attachment not provided with the product or loss of parts or subjecting the product to any but the specified voltage or batteries.\*

**NO RESPONSIBILITY IS ASSUMED FOR ANY SPECIAL, INCIDENTAL OR CONSEQUENTIAL DAMAGES.**

In order to obtain warranty service, simply go to [www.philips.com/support](http://www.philips.com/support) for assistance. It is suggested that for your protection you return shipments of product by insured mail, insurance prepaid. Damage occurring during shipment is not covered by this warranty.

NOTE: No other warranty, written or oral, is authorized by Philips North America LLC.

This warranty gives you specific legal rights, and you may also have other rights which vary from state to state. Some states do not allow the exclusion or limitation of incidental or consequential damages, so the above exclusion and limitations may not apply to you.

\*Read enclosed instructions carefully.

## **45-DAY MONEY-BACK GUARANTEE**

If you are not fully satisfied with your product send the product back and we'll refund you the full purchase price.

**The product must be shipped prepaid by insured mail, insurance prepaid, have the original sales receipt, indicating purchase price and date of purchase, and the money-back guarantee return authorization form enclosed.**

**We cannot be responsible for lost mail.**

The product must be postmarked no later than 45 days after the date of purchase. Philips reserves the right to verify the purchase price of the product and limit refunds not to exceed suggested retail price.

**To obtain the money-back guarantee service, please go to [www.PhilipsMoneyBack.com](http://www.PhilipsMoneyBack.com) and follow the simple 3-step process.**

**Delivery of refund check will occur 6–8 weeks after receipt of returned product.**