

PHILIPS

Xperion 3000 under bonnet

LED Work lights



User manual



English

Before you start

Thank you for buying the Philips LED work lights. Its high-quality LED lighting offers a powerful wide-angle light output that will let you work in your workshop, garage or any other professional environment under the best lighting conditions.



The Philips LED work lights bears the official

Philips Automotive Grade Quality seal. Philips Automotive Grade Quality products are designed and developed following strict quality-control processes (including applicable ISO norms), leading to consistently high production standards.





Important

Please read this user guide carefully before using your LED work lights. This guide contains important health and safety information.

If you need further assistance, **please visit us:**
www.philips.com/support
Or visit your local Philips Dealer

1



	✓		✓
	✓	 (5V 2A)	✗



3



i

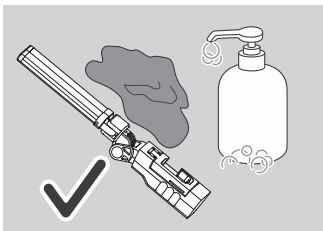
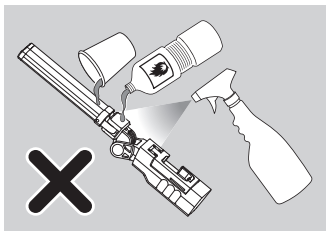
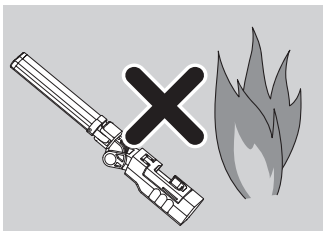
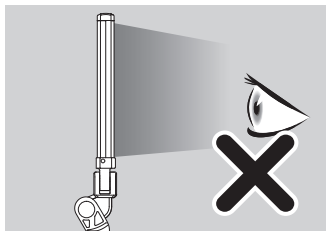

FR
Cet appareil,
ses accessoires,
et batterie
se recyclent

À DÉPOSER
EN MAGASIN



OU



À DÉPOSER
EN DÉCHÈTERIE

Points de collecte sur www.quefairedemesdechets.fr
Privilégiez la réparation ou le don de votre appareil !



CE

UK
CA

EN: Discarded electrical products must not be disposed of together with household waste. Please use recycling facilities. Contact your local authority or retailer for advice on recycling.

DK: Kasserede elektriske produkter må ikke bortskaffes sammen med husholdningsaffaldet. Anvend genbrugsstationer. Få råd fra de lokale myndigheder eller forhandleren om genanvendelse.

DE: Itgeräte dürfen nicht mit dem Hausmüll entsorgt werden, sondern müssen separat über Sondermüllannahmestellen entsorgt oder an den Handel zurückgegeben werden. Handel und Kommunen sind zur kostenlosen Rücknahme verpflichtet.

FR: Il est interdit de jeter les produits électriques mis au rebut avec les ordures ménagères. Il faut les retourner à un centre de recyclage. Consulter les autorités locales ou le revendeur pour conseils sur le recyclage.

ES: Los productos eléctricos no pueden desecharse junto con los residuos domésticos. Le rogamos que use los centros de reciclaje. Solicite asesoramiento sobre reciclaje al vendedor o a las autoridades locales.

PT: Os produtos elétricos rejeitados não devem ser eliminados juntamente com o lixo doméstico. Utilize os centros de reciclagem. Peça à autoridade local ou ao vendedor conselhos sobre reciclagem.

IT: I prodotti elettrici al termine del ciclo di vita non devono essere smaltiti insieme ai rifiuti domestici. Si raccomanda di utilizzare gli impianti di riciclaggio. Chiedere alle autorità locali o al proprio rivenditore per informazioni sul riciclaggio.

NL: Afgedankte elektrische producten mogen niet worden afgevoerd met het huishoudelijk afval. Lever in bij een afvalzamelstation. Vraag uw plaatselijke overheid of winkelier om advies inzake recycling.

PL: Nie wolno utylizować zużytych urządzeń elektrycznych wraz z odpadami domowymi. Należy skorzystać z placówek przetwarzania odpadów. Więcej informacji na temat przetwarzania odpadów udzielają lokalne władze lub sprzedawca.

BG: Излезлите от употреба електрически уреди не трябва да се изхвърлят заедно с битовите отпадъци. Моля, използвайте пунктове за рециклиране. Обърнете се към вашите местни власти или търговеца на дребно за съвет относно рециклирането.

TR: Atılacak elektrikli ürünler diğer ev atıkları ile birlikte bertaraf edilmemeli veya imha edilmemelidir.

Lütfen geri dönüşüm tesislerini kullanın. Daha fazla bilgi edinmek için yerel makamlara veya satıcınıza danışın.

SE: Kasserade elektriska produkter får inte slängas i hushållssoptorna. Ta med dem till en återvinningscentral.

Fråga din kommun eller återförsäljare om du vill ha råd om återvinning.

CZ: Odpadní elektronickí výrobci ne treba da se odlažu zajedno sa otpadom iz domaćinstva. Koristite postrojenja za reciklažu. Zatražite od svog lokalnog organa ili prodavca savet za način za recikliranje.

FI: Käytettyjä sähkölaitteita ei saa hävittää talousjätteen mukana. Toimita ne mieluummi kierrätyskeskukseen.

Kierrätysohjeita saat kunnan viranomaisilta tai jälleenmyyjiltä.

RO: Produsele electrice dezafectate nu trebuie eliminate împreună cu gunoii menajeri. Vă rugăm să apelați la centrele de reciclare. Cereți sfaturi referitoare la reciclare de la autoritățile locale sau de la magazin.

4

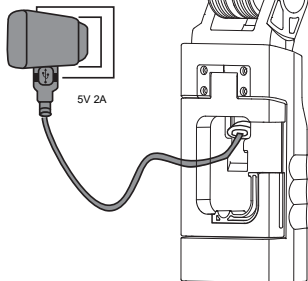

100%



4.0h

4

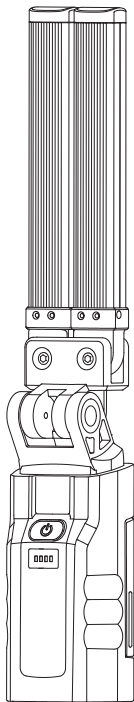

- 76-100%
- 50-75%
- 25-49%
- 10-24%
- * < 10%

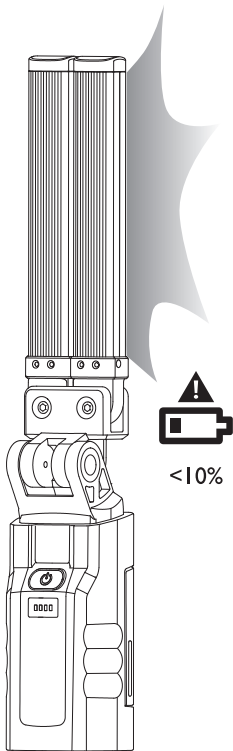

<10%

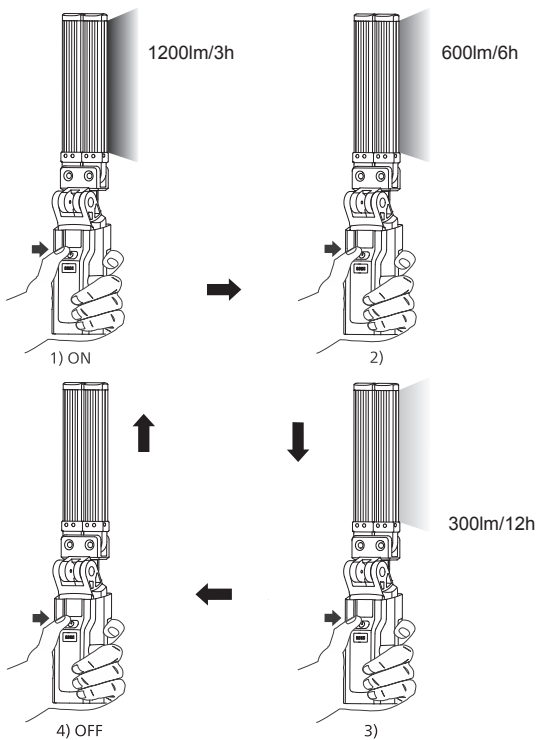



Description

Xperion 3000 under bonnet

	Light output-lm @25°C, 60RH	1200lm/600lm/300lm(Boost /eco /eco)
	Operation time (up to)-h @25°C, 60RH	3h/6h/12h (Boost /eco /eco)
	Battery	Rechargeable battery 3.7V, 5200mAh
	Charging (Via type C USB)	5V 2A
	Charging time(up to)-h @25°C, 60RH	Up to 4h
	IK	IK07
	IP	IP54
	Operating temperature	-10°C to 40°C
	Storage temperature	-10°C to 40°C
	lamp dimension(L*W*H)-mm	411*48*74mm
	Product weight	700g
	Magnet	Yes



2 years warranty

Warranty and service

Lumileds is the warrantor of this product. The Lumileds warranty applies, provided:

- The product is handled properly for its intended use only.
- The product is used in accordance with its operating instructions.
- You present the original invoice with the product.

The Lumileds warranty does not apply if the product is damaged due to accident, error, or misuse.

For more information and assistance, or if you have a problem with the product, you can visit the Philips website at www.philips.com/support, or contact the retail outlet where you purchased the product.

Garanzia e assistenza

La garanzia Lumileds si applica, a condizione che:

- Il prodotto venga maneggiato correttamente solo per l'uso previsto.
- Il prodotto venga utilizzato in conformità con le relative istruzioni per l'uso.
- Si presenti la fattura originale con il prodotto.

La garanzia Lumileds non si applica se il prodotto è danneggiato a causa di incidenti, errori o uso improprio.

Per ulteriori informazioni e assistenza, o in caso di problemi con il prodotto, è possibile visitare il sito Web Philips all'indirizzo www.philips.com/support o contattare il punto vendita presso il quale è stato acquistato il prodotto.

Garantía y servicio

Se aplica la garantía de Lumileds, siempre que:

- El producto se manipule correctamente para el uso previsto solamente.
- El producto se utilice de acuerdo con sus instrucciones de funcionamiento.
- Presente la factura original con el producto.

La garantía de Lumileds no se aplica si el producto se daña debido a un accidente, error o mal uso.

Para obtener más información y asistencia, o si tiene algún problema con el producto, puede visitar el sitio web de Philips en www.philips.com/support o ponerse en contacto con el punto de venta donde compró el producto.



2 years warranty

Garantie und Service

Es gilt die Lumileds Garantie, vorausgesetzt:

- Das Produkt wird ordnungsgemäß und nur für den vorgesehenen Zweck verwendet.
- Das Produkt wird gemäß seiner Bedienungsanleitung verwendet.
- Sie legen die Originalrechnung mit dem Produkt vor.

Die Lumileds Garantie gilt nicht, wenn das Produkt aufgrund eines Unfalls, eines Fehlers oder eines Missbrauchs beschädigt wurde.

Wenn Sie weitere Informationen und Unterstützung benötigen oder ein Problem mit dem Produkt haben, besuchen Sie die Philips Website unter www.philips.com/support oder wenden Sie sich an das Geschäft, in dem Sie das Produkt gekauft haben.

Garantie et service

La garantie Lumileds s'applique à condition que :

- Le produit est manipulé correctement pour l'usage auquel il est destiné.
- Le produit est utilisé conformément à son mode d'emploi.
- Vous présentez la facture originale avec le produit.

La garantie Lumileds ne s'applique pas si le produit est endommagé à la suite d'un accident, d'une erreur ou d'une mauvaise utilisation.

Pour plus d'informations et d'assistance, ou si vous rencontrez un problème avec le produit, vous pouvez visiter le site web de Philips à l'adresse www.philips.com/support, ou contacter le point de vente d'où vous avez acheté le produit.

Garantia e serviço

A garantia Lumileds está assegurada nas seguintes condições:

- produto é manuseado corretamente apenas para o uso pretendido.
- O produto é usado de acordo com suas instruções de operação.
- A garantia Lumileds não é aplicável caso o produto tenha sido danificado devido a um acidente, erro ou uso indevido. caso o produto tenha sido danificado devido a um acidente, erro ou uso indevido.

Para obter mais informações e assistência ou se tiver algum problema com o produto, visite o site da Philips em www.philips.com/support ou entre em contato com a loja onde comprou o produto.



2 years warranty

Gwarancja i obsługa

Gwarancja Lumileds obowiązuje pod warunkiem, że:

- Z produktem obchodzi się prawidłowo, wyłącznie zgodnie z jego przeznaczeniem.
- Produkt jest używany zgodnie z jego instrukcją obsługi.
- Oryginał faktury dołączasz do produktu.

Gwarancja Lumileds nie obowiązuje, jeśli produkt jest uszkodzony w wyniku wypadku, błędu lub niewłaściwego użytkowania.

Aby uzyskać więcej informacji i pomoc lub jeśli masz problem z produktem, odwiedź witrynę internetową Philips pod adresem www.philips.com/support, lub skontaktuj się z punktem sprzedaży, w którym produkt został zakupiony.

Garanti og service

Lumileds garanti gælder, forudsat:

- Produktet udelukkende håndteres korrekt til dets tilsigtede brug.
- Produktet bruges i overensstemmelse med dets betjeningsvejledning.
- Du fremviser den originale faktura sammen med produktet.

Lumileds garanti gælder ikke, hvis produktet er beskadiget på grund af uheld, fejl eller misbrug.

For mere information og assistance, eller hvis du har et problem med produktet, kan du besøge Philips' websted på www.philips.com/support eller kontakte forhandleren, hvor du købte produktet.

Takuu ja huolto

Lumiledsin takuu on voimassa seuraavissa tilanteissa:

- Tuotetta käsitellään asianmukaisesti vain sen aiottuun käyttöön.
- Tuotetta käytetään sen käyttöohjeiden mukaisesti.
- Esität tuotteen mukana alkuperäisen laskun.

Lumiledsin takuu ei ole voimassa, jos tuote on vaurioitunut onnettomuuden, virheen tai väärinkäytön vuoksi.

Saat lisätietoja ja apua tai jos sinulla on ongelmia tuotteen kanssa, vierailamalla Philipsin verkkosivustolla osoitteessa www.philips.com/support tai ottamalla yhteyttä jälleenmyyjään, josta ostit tuotteen.



2 years warranty

Garanti og service

Lumileds garanti gjelder, forutsatt:

- Produktet håndteres på riktig måte kun for den tiltenkte bruken.
- Produktet brukes i samsvar med bruksanvisningen.
- Du presenterer originalfakturaen sammen med produktet.

Lumileds garanti gjelder ikke hvis produktet er skadet på grunn av ulykke, feil eller misbruk.

Før mer informasjon og assistanse, eller hvis du har et problem med produktet, kan du besøke

Philips-nettstedet på www.philips.com/support, eller kontakte forhandleren der du kjøpte produktet.

Garanti och service

Lumileds garanti gäller under förutsättning att följande uppfylls:

- Produkten hanteras endast på rätt sätt för avsedd användning.
- Produkten används i enlighet med användningsinstruktionerna.
- Du uppvisar originalfakturan tillsammans med produkten.

Lumileds garanti gäller inte om produkten har skadats på grund av olycka, fel eller felaktig användning.

För mer information och hjälp, eller om du har problem med produkten, kan du besöka Philips webbplats på www.philips.com/support, eller kontakta återförsäljaren där du köpte produkten.

Garantía y servicio

Se aplica la garantía de Lumileds, siempre que:

- El producto se manipule correctamente para el uso previsto solamente.
- El producto se utilice de acuerdo con sus instrucciones de funcionamiento.
- Presente la factura original con el producto.

La garantía de Lumileds no se aplica si el producto se daña debido a un accidente, error o mal uso.

Para obtener más información y asistencia, o si tiene algún problema con el producto, puede visitar el sitio web de Philips en www.philips.com/support o ponerse en contacto con el punto de venta donde compró el producto.



**Lumileds Holding B.V. is the warrantor of this product.
2024 © Lumileds Holding B.V. All rights reserved.
Philips and the Philips Shield Emblem are registered
trademarks of Koninklijke Philips N.V.
and are used under license.**

3211.008.26951