

Register your product and get support at
www.philips.com/welcome

MCD122



EN	User manual	3
ZH-CN	用户手册	29

PHILIPS

Contents

1	Important	4	7	Tune to FM radio stations	21
	Safety	4		Program radio stations automatically	21
	Notice	6		Program radio stations manually	21
				Tune to a preset radio station	21
2	Your DVD Micro Theater	7	8	Adjust volume level and sound effect	22
	Introduction	7		Adjust volume level	22
	What's in the box	7		Select a sound effect	22
	Overview of the main unit	8		Mute sound	22
	Overview of the remote control	9		Listen through headphone	22
3	Connect	10	9	Other features	23
	Place the unit	10		Activate demonstration mode	23
	Connect speakers	10		Adjust brightness of display panel	23
	Connect FM antenna	11		Set the alarm timer	23
	Connect TV	11		Set the sleep timer	23
	Connect power	13		Connect other devices	23
4	Get started	13	10	Product information	24
	Prepare the remote control	13		Specifications	24
	Set clock	14		Supported disc formats	25
	Turn on	14		USB playability information	25
	Find the correct viewing channel	14	11	Troubleshooting	26
	Select the correct TV system	14			
	Change system menu language	14			
	Turn on Progressive Scan	15			
5	Play	15			
	Play a disc	15			
	Play from USB	16			
	Play DivX video	16			
	Play MP3/WMA/picture files	17			
	Play control	17			
	Play options	18			
	Picture view options	18			
6	Adjust settings	19			
	General setup	19			
	Audio setup	19			
	Video setup	19			
	Preferences	20			

1 Important

Safety

Know these safety symbols

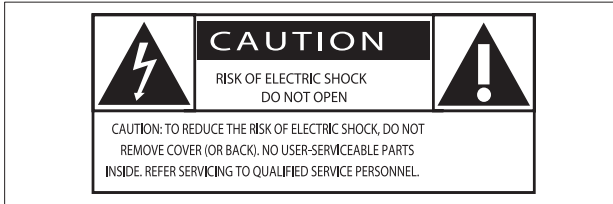

This 'bolt of lightning' indicates uninsulated material within your unit may cause an electrical shock. For the safety of everyone in your household, please do not remove product covering.

The 'exclamation point' calls attention to features for which you should read the enclosed literature closely to prevent operating and maintenance problems.

WARNING: To reduce the risk of fire or electric shock, this apparatus should not be exposed to rain or moisture and objects filled with liquids, such as vases, should not be placed on this apparatus.

CAUTION: To prevent electric shock, match wide blade of plug to wide slot, fully insert.

- ① Read these instructions.
- ② Keep these instructions.
- ③ Heed all warnings.
- ④ Follow all instructions.
- ⑤ Do not use this apparatus near water.
- ⑥ Clean only with dry cloth.

- ⑦ Do not block any ventilation openings. Install in accordance with the manufacturer's instructions.
- ⑧ Do not install near any heat sources such as radiators, heat registers, stoves, or other apparatus (including amplifiers) that produce heat.
- ⑨ For countries with a polarized mains, do not defeat the safety purpose of the polarized or grounding-type plug. A polarized plug has two blades with one wider than the other. A grounding type plug has two blades and a third grounding prong. The wide blade or the third prong is provided for your safety. If the provided plug does not fit into your outlet, consult an electrician for replacement of the obsolete outlet.
Caution: To prevent electric shock, match the wide blade of the plug to the wide slot, fully insert.

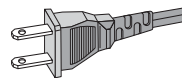

- ⑩ Protect the power cord from being walked on or pinched, particularly at plugs, convenience receptacles, and the point where they exit from the apparatus.
- ⑪ Only use attachments/accessories specified by the manufacturer.
- ⑫ Use only with the cart, stand, tripod, bracket, or table specified by the manufacturer or sold with the apparatus. When a cart is used, use caution when moving the cart/apparatus combination to avoid injury from tip-over.



- ⑬ Unplug this apparatus during lightning storms or when unused for long periods of time.
- ⑭ Refer all servicing to qualified service personnel. Servicing is required when the apparatus has been damaged in any way, such as power-supply cord or plug is damaged, liquid has been spilled or objects have fallen into the apparatus, the apparatus has been exposed to rain or moisture, does not operate normally, or has been dropped.
- ⑮ **Battery usage CAUTION – To prevent battery leakage which may result in bodily injury, property damage, or damage to the apparatus:**
- Install all batteries correctly, + and - as marked on the apparatus.
 - Do not mix batteries (old and new or carbon and alkaline, etc.).
 - Remove batteries when the unit is not used for a long time.
- ⑯ The batteries shall not be exposed to excessive heat such as sunshine, fire or the like.
- ⑰ Apparatus shall not be exposed to dripping or splashing.
- ⑱ Do not place any sources of danger on the apparatus (e.g. liquid filled objects, lighted candles).
- ⑲ This product may contain lead and mercury. Disposal of these materials may be regulated due to environmental considerations. For disposal or recycling information, please contact your local authorities or the Electronic Industries Alliance: www.eiae.org.



Caution

- Use of controls or adjustments or performance of procedures other than herein may result in hazardous radiation exposure or other unsafe operation.



Warning

- Where the MAINS plug or an appliance coupler is used as the disconnect device, the disconnect device shall remain readily operable.



Warning

- Never remove the casing of this unit.
- Never lubricate any part of this unit.
- Place this unit on a flat, hard and stable surface.
- Never place this unit on other electrical equipment.
- Only use this unit indoors. Keep this unit away from water, moisture and liquid-filled objects.
- Keep this unit away from direct sunlight, naked flames or heat.
- Never look into the laser beam inside the unit.

Hearing safety

Listen at a moderate volume.

- Using headphones at a high volume can impair your hearing. This product can produce sounds in decibel ranges that may cause hearing loss for a normal person, even for exposure less than a minute. The higher decibel ranges are offered for those that may have already experienced some hearing loss.
- Sound can be deceiving. Over time your hearing 'comfort level' adapts to higher volumes of sound. So after prolonged listening, what sounds 'normal' can actually be loud and harmful to your hearing. To guard against this, set your volume to a safe level before your hearing adapts and leave it there.

To establish a safe volume level:

- Set your volume control at a low setting.
- Slowly increase the sound until you can hear it comfortably and clearly, without distortion.

Listen for reasonable periods of time:

- Prolonged exposure to sound, even at normally 'safe' levels, can also cause hearing loss.

- Be sure to use your equipment reasonably and take appropriate breaks.

Be sure to observe the following guidelines when using your headphones.

- Listen at reasonable volumes for reasonable periods of time.
- Be careful not to adjust the volume as your hearing adapts.
- Do not turn up the volume so high that you can't hear what's around you.
- You should use caution or temporarily discontinue use in potentially hazardous situations. Do not use headphones while operating a motorized vehicle, cycling, skateboarding, etc.; it may create a traffic hazard and is illegal in many areas.

Notice

Any changes or modifications made to this device that are not expressly approved by Philips Consumer Lifestyle may void the user's authority to operate the equipment.

Environmental information

All unnecessary packaging has been omitted. We have tried to make the packaging easy to separate into three materials: cardboard (box), polystyrene foam (buffer) and polyethylene (bags, protective foam sheet.)

Your system consists of materials which can be recycled and reused if disassembled by a specialized company. Please observe the local regulations regarding the disposal of packaging materials, exhausted batteries and old equipment.



The making of unauthorized copies of copy-protected material, including computer programs, files, broadcasts and sound recordings, may be an infringement of copyrights and constitute a criminal offence. This equipment should not be used for such purposes.



'DVD Video' is a trademark of DVD Format/ Logo Licensing Corporation.



Manufactured under license from Dolby Laboratories. Dolby and the double-D symbol are trademarks of Dolby Laboratories.

This apparatus includes this label:



Note

- The type plate is located on the bottom of the apparatus.

2 Your DVD Micro Theater

Congratulations on your purchase, and welcome to Philips! To fully benefit from the support that Philips offers, register your product at www.Philips.com/welcome.

Introduction

With this unit, you can:

- watch video from DVD/VCD/SVCD or USB devices
 - enjoy audio from discs or USB devices
 - view pictures from discs or USB devices
 - Listen to FM radio
- You can enrich sound output with these sound effects:**
- Digital Sound Control (DSC)
 - Dynamic Bass Boost (DBB)
 - Bass/treble enhancement

The unit supports these media/disc formats:



You can play DVD discs with the following region codes:

DVD region code	Countries
 	China

What's in the box

Check and identify the contents of your package:

- Main unit
- 2 speakers
- Remote control with battery
- Composite video cable (yellow)
- Power cord
- FM wire antenna
- User manual
- Quick start guide

Overview of the main unit

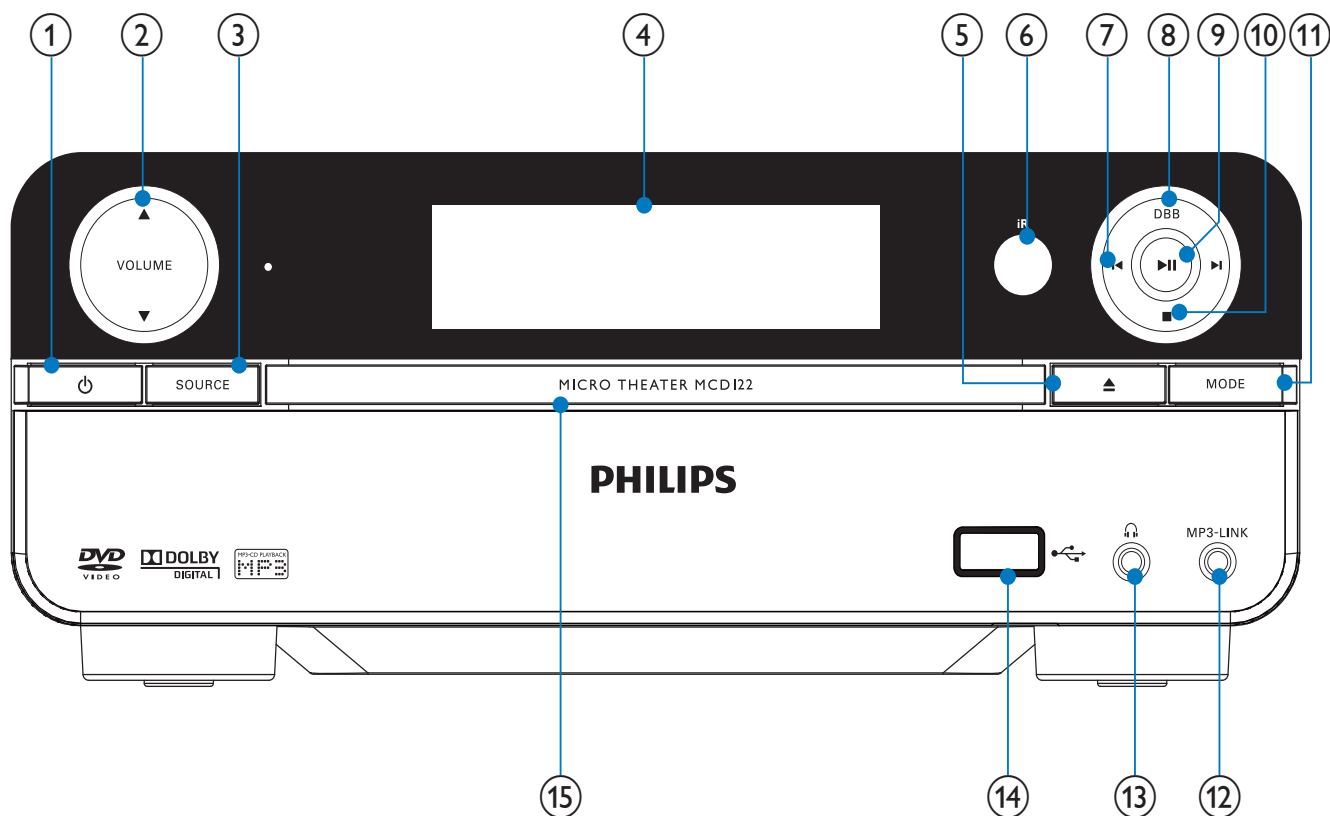

- ① **⏻**
 - Turn on the apparatus; switch to standby mode.
- ② **VOLUME ▲/▼**
 - Adjust volume.
 - Adjust time.
- ③ **SOURCE**
 - Select a source.
- ④ **Display panel**
 - Display current status.
- ⑤ **▲**
 - Open or close the disc compartment.
- ⑥ **Remote control sensor**
- ⑦ **⏮/⏭**
 - Skip to the previous/next track.
 - Skip to the previous/next title or chapter.
 - Select a preset radio station.
- ⑧ **DBB**
 - Turn on or off dynamic bass enhancement.
- ⑨ **▶||**
 - Start or pause play.
- ⑩ **■**
 - Stop play.
 - In demo mode, activate or deactivate demonstration.
- ⑪ **MODE**
 - Select repeat play modes.
 - Select shuffle play modes.
- ⑫ **MP3-LINK**
 - Jack for an external audio device.
- ⑬ **🎧**
 - Headphone socket.
- ⑭ **USB DIRECT**
 - USB socket.
- ⑮ **Disc compartment**

Overview of the remote control

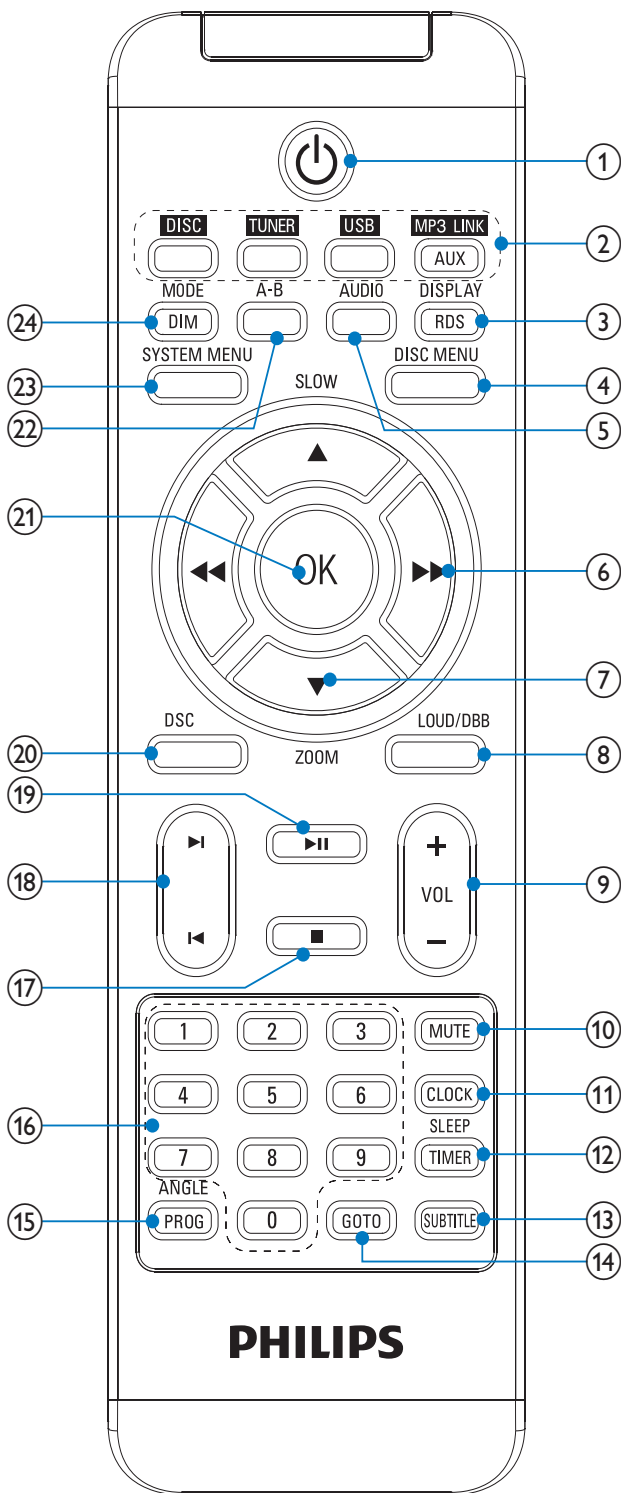

- ①  Turn on the apparatus; switch to standby mode.

- ② **Source selection keys**
- Select a source.
- ③ **DISPLAY/RDS (RDS function unavailable for this version)**
- Display play information on a connected TV.
- ④ **DISC MENU**
- For video discs: access or exit the disc menu.
 - For video discs with playback control (PBC): turn on/off PBC.
- ⑤ **AUDIO**
- For VCD, select stereo, mono-left or mono-right channel.
 - For DVD/DivX video, select an audio language.
- ⑥ 
- Search within a track.
 - Tune to a radio station.
 - For menus, navigate left/right.
 - Move an enlarged image left/right.
 - Rotate or invert pictures.
- ⑦ **▲SLOW/▼ZOOM**
- For menus, navigate up/down.
 - Rotate or invert pictures.
 - (▲SLOW) For video: select a slow play mode.
 - (▼ZOOM) For video: zoom in/out.
- ⑧ **LOUD/DBB**
- Turn on or off automatic loudness adjustment.
 - Turn on or off dynamic bass enhancement.
- ⑨ **VOL +/-**
- Adjust volume.
 - Adjust time.
- ⑩ **MUTE**
- Mute or restore volume.
- ⑪ **CLOCK**
- Set the clock.

- ⑫ **SLEEP/TIMER**
 - Set the sleep timer.
 - Set the alarm timer.
- ⑬ **SUBTITLE**
 - Select a subtitle language.
- ⑭ **GOTO**
 - During disc play, specify a position to start play.
- ⑮ **ANGLE/PROG**
 - Select a DVD camera angle.
 - Program radio stations.
- ⑯ **Numeric keypad**
 - Select a title/chapter/track directly.
- ⑰ **■**
 - Stop play.
- ⑱ **⏮/⏭**
 - Skip to the previous/next track.
 - Skip to the previous/next title or chapter.
 - Select a preset radio station.
- ⑲ **▶||**
 - Start or pause play.
- ⑳ **DSC**
 - Select a preset sound setting.
- ㉑ **OK**
 - Confirm a selection.
- ㉒ **A-B**
 - Repeat a specific section within a track/disc.
- ㉓ **SYSTEM MENU**
 - Access or exit the system setup menu.
- ㉔ **MODE/DIM**
 - Select repeat play modes.
 - Select shuffle play modes.
 - Select a brightness level for the display screen.

3 Connect

Place the unit

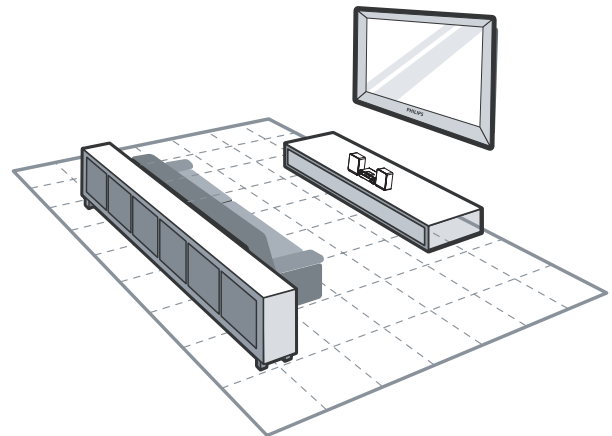

- 1 Place the unit near to the TV.
- 2 Place the left and right speakers at equal distance from the TV and at an angle of approximately 45 degrees from the listening position.

Note

- To avoid magnetic interference or unwanted noise, never place this apparatus and speakers too close to any radiation devices.
- Never place this unit in an enclosed cabinet.
- Install this unit near the AC outlet where the AC power plug can be easily reached.

Connect speakers

Note

- Ensure that the colors of the speaker wires and terminals are matched.
- For optimal sound, use the supplied speakers only.
- Connect only speakers with impedance that is the same or higher than the supplied speakers. Refer to the Specifications section of this manual.

- 1 Hold down the socket flap.
- 2 Insert the stripped part of the wire completely.
 - Insert the right speaker wires to "R", left speaker wires to "L".
 - Insert the red wires to "+", black wires to "-".
- 3 Release the socket flap.

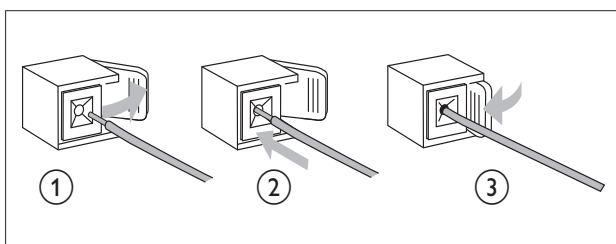

Connect FM antenna

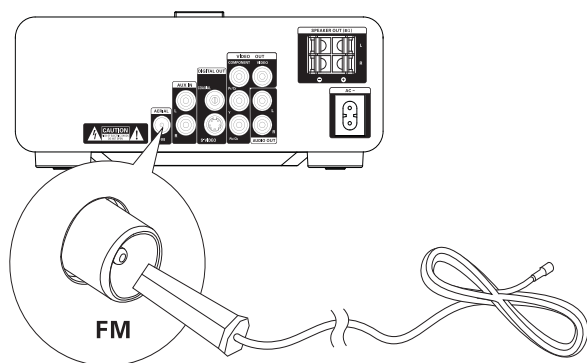

Tip

- For optimal reception, fully extend and adjust the position of the antenna.
- For better FM stereo reception, connect an outdoor FM antenna to the **FM AERIAL** jack.
- The unit does not support MW radio reception.

- 1 Connect the supplied FM wire antenna to the **FM AERIAL** socket on the unit.

Connect TV

Connect video cables

With this connection, you can watch video from the unit on the TV screen.

You can select the best video connection that your TV supports.

- Option 1: Connect through SCART (for a standard TV).
- Option 2: connect through component video (for a standard TV or Progressive Scan TV).
- Option 3: connect through S-Video (for a standard TV).
- Option 4: connect through composite video (CVBS) (for a standard TV).

Option 1: Connect through component video

Connect a progressive scan TV through component video for higher quality video.

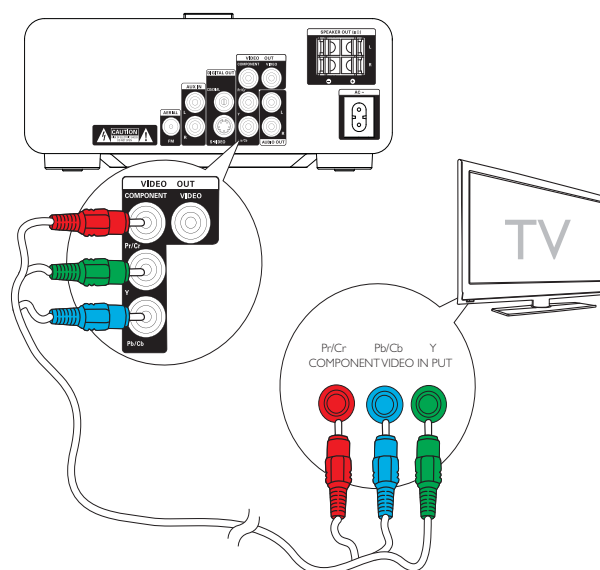

Note

- The progressive scan video quality is only available when a progressive scan TV is connected.
- If your TV does not support progressive scan, you cannot view the picture.
- For how to activate progressive scan on your TV, refer to the TV user manual.

Connect a progressive scan TV through component video for higher quality video.

- 1 Connect component video cables (red/blue/green - not supplied) to:
 - the **VIDEO OUT (Pr/Cr Pb/Cb Y)** sockets on this unit.
 - the component input sockets on the TV.

Option 2: Connect through S-Video

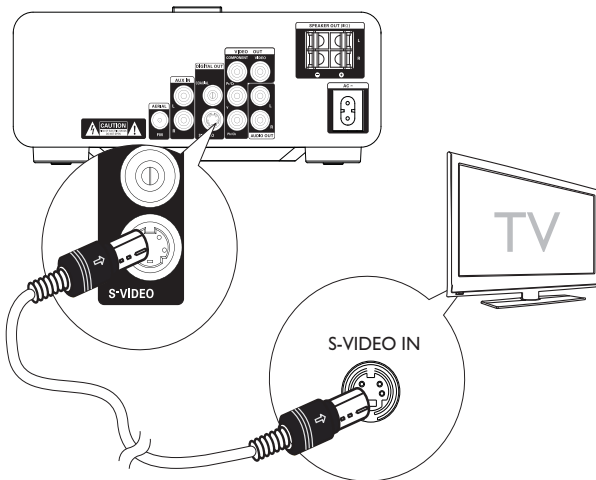

- 1 Connect an S-video cable (not supplied) to:
 - the **S-Video** socket on this unit.
 - the **S-Video** socket on the TV.

Option 3: Connect through composite video

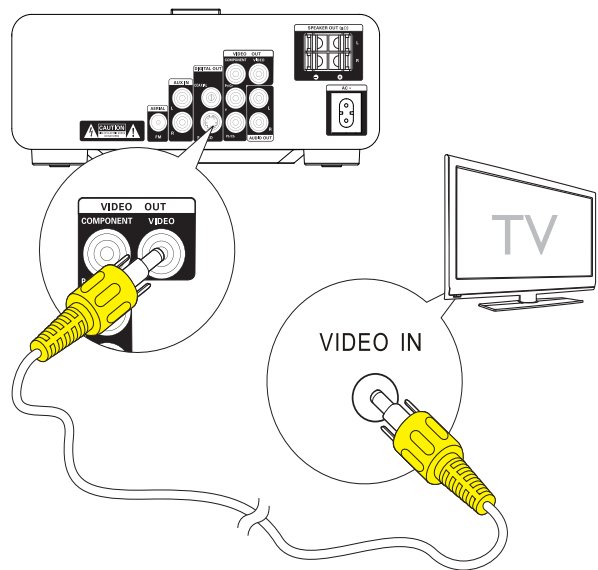

- 1 Connect the supplied composite video cable to:
 - the **VIDEO OUT** socket on this unit.
 - the video input socket on the TV.

Connect audio cables

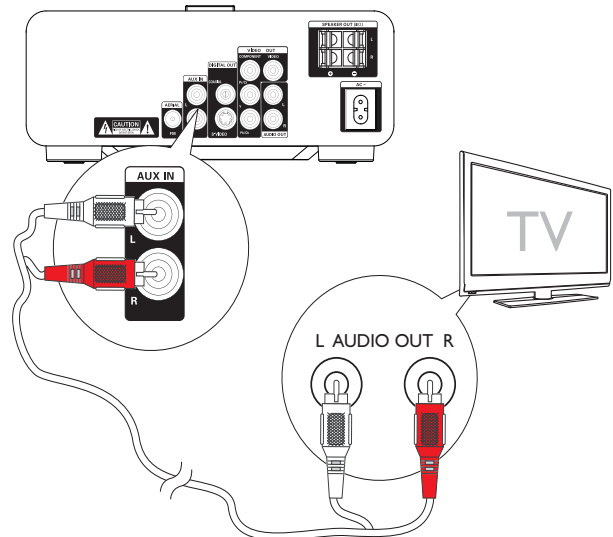

- 1 To play sound from the TV through this unit, connect audio cables (red/white - not supplied) to:
 - the **AUX IN L/R** sockets on this unit.
 - the audio output sockets on the TV.

Connect power

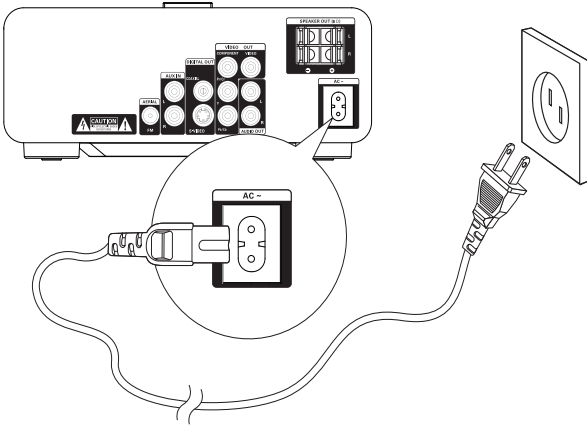

Caution

- Risk of product damage! Ensure that the power supply voltage corresponds to the voltage printed on the back or the underside of the unit.
- Before connecting the AC power cord, ensure you have completed all other connections.

- 1 Connect the AC power cord to the wall socket.

4 Get started



Caution

- Use of controls or adjustments or performance of procedures other than herein may result in hazardous radiation exposure or other unsafe operation.

Always follow the instructions in this chapter in sequence.

If you contact Philips, you will be asked for the model and serial number of this apparatus. The model number and serial number are on the bottom of the apparatus. Write the numbers here:

Model No. _____

Serial No. _____

Prepare the remote control



Caution

- Risk of explosion! Keep batteries away from heat, sunshine or fire. Never discard batteries in fire.

For first-time use:

- 1 Remove the protective tab to activate the remote control battery.

To replace the remote control batteries:

- 1 Open the battery compartment.
- 2 Insert one lithium CR2025 battery with correct polarity (+/-) as indicated.
- 3 Close the battery compartment.



Note

- Before you press any function button on the remote control, first select the correct source with the remote control.
- If you are not going to use the remote control for a long time, remove the battery.

Set clock

- 1 In the standby mode, press and hold **CLOCK** to activate the clock setting mode.
 - ↳ The hour digits are displayed and begin to blink.
- 2 Press **+VOL -** to set the hour; then press **CLOCK** again.
 - ↳ The minute digits are displayed and begin to blink.
- 3 Press **+VOL -** to set the minute.
- 4 Press **CLOCK** to confirm the clock setting.

Turn on

- 1 Press **⏻**.
 - ↳ The unit switches to the last selected source.

Switch to standby mode

- 1 Plug in AC power.
 - ↳ The unit will go to Eco Power Standby.
- 2 Long press **⏻**.
 - ↳ Switch the unit from Eco Power Standby mode to Standby mode.



Tip

- In the Eco Power mode, you can press **CLOCK** key to switch to the standby mode and view the clock (if set).

Find the correct viewing channel

- 1 Press **⏻** to turn on the unit.
- 2 Press **DISC** to switch to disc mode.
- 3 Turn on the TV and switch to the correct video-in channel in one of the following ways:

- Go to the lowest channel on your TV, then press the Channel Down button until you see the blue screen.
- Press the source button repeatedly on the remote control of your TV.



Tip

- The video-in channel is between the lowest and highest channels and may be called FRONT, A/V IN, VIDEO etc. See the TV user manual on how to select the correct input on the TV.

Select the correct TV system

Change this setting if the video does not appear correctly. By default, this setting matches the most common setting for TVs in your country.

- 1 Press **SYSTEM MENU**.
- 2 Select **[Video Setup]**.
- 3 Select **[TV System]** and then press **▶▶**.
- 4 Select a setting and then press **OK**.
 - **[NTSC]** - For TV with NTSC color system.
 - **[PAL]** - For TV with PAL color system.
 - **[Multi]** - For TV that is compatible with both PAL and NTSC.
- 5 To exit the menu, press **SYSTEM MENU**.

Change system menu language

- 1 Press **SYSTEM MENU**.
- 2 Select **[General Setup]**.
- 3 Select **[OSD language]** and then press **▶▶**.
- 4 Select a setting and then press **OK**.
- 5 To exit the menu, press **SYSTEM MENU**.

Turn on Progressive Scan

Progressive scan displays twice the number of frames per seconds than interlaced scanning (ordinary TV system). With nearly double the number of lines, progressive scan offers higher picture resolution and quality.

Before you turn on this feature, ensure that:

- The TV supports progressive scan signals.
- You have connected this unit with the TV through component video.

- 1 Turn on the TV.
- 2 Ensure that the TV progressive scan mode is deactivated (see the TV user manual).
- 3 Switch the TV to the correct viewing channel for this unit.
- 4 Press **DISC**.
- 5 Press **SYSTEM MENU**.
- 6 Press **▲/▼** to select **[Video Setup]** in the menu, then press **▶▶**.
- 7 Select **[Component Video]**, then press **▶▶**.
- 8 Select **[P-Scan]**, then press **OK**.
↳ The progressive setup is complete.

5 Play



Note

- With some disc/file types, play may differ.

Play a disc



Caution

- Never look at the laser beam inside the unit.
- Risk of product damage! Never play discs with accessories such as disc stabilizer rings or disc treatment sheets.
- Never put any objects other than discs into the disc compartment.

- 1 Press **DISC** to select the DISC source.
- 2 Press **▲** on the front panel.
↳ The disc tray opens.
- 3 Place a disc onto the tray and press **▲**.
↳ Ensure that the label faces up.
- 4 Play starts automatically.
 - To stop play, press **■**.
 - To pause or resume play, press **▶||**.
 - To skip to the previous/next title/ chapter/track, press **◀|▶**.

If play does not start automatically:

 - Select a title/chapter/track and then press **▶||**.



Tip

- To play a locked DVD, enter the 4-digit parental control password.

Use the disc menu

When you load a DVD/(S)VCD disc, a menu may be displayed on the TV screen.

To access or exit the menu manually:

- 1 Press **DISC MENU**.

For **VCD with PlayBack Control (PBC) feature (version 2.0 only)**:

With the PBC feature, you can play VCD interactively according to the menu screen.

- 1 During play, press **DISC MENU** to enable/disable PBC.
 - ↳ When PBC is enabled, the menu screen is displayed.
 - ↳ When PBC is disabled, normal play is resumed.

Select an audio language

You can select an audio language on DVDs or DivX video.

- 1 During disc play, press **AUDIO**.
 - ↳ The language options appear. If the selected audio channels is unavailable, the default disc audio channel is used.

Note

- For some DVDs, the language can only be changed from the disc menu. Press **DISC MENU** to access the menu.

Select a subtitle language

You can select a subtitle language on DVDs or DivX® Ultra discs.

- During play, press **SUBTITLE**.

Tip

- For some DVDs, the language can only be changed from the disc menu. Press **DISC MENU** to access the menu.

Play from USB

Note

- Ensure that the USB device contains playable music, pictures or video.

- 1 Insert the USB device.

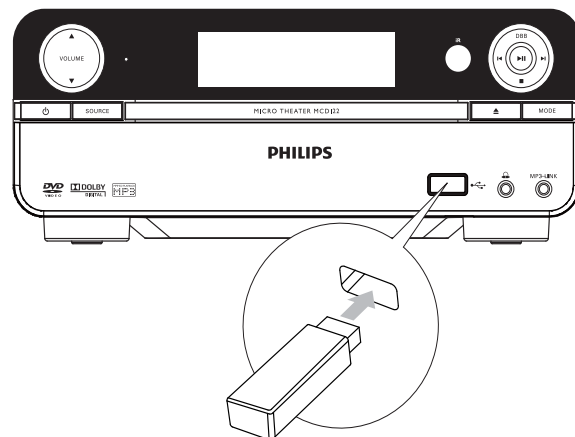

- 2 Press **USB** to select the USB source.
- 3 Press **▲/▼** to select a folder, then press **OK** to confirm.
- 4 Press **▲/▼** to select a file from the folder.
- 5 Press **▶||** to start play.
 - To stop play, press **■**.
 - To pause or resume play, press **▶||**.
 - To skip to the previous/next file, press **◀▶**.
 - To return to the upper-level menu, press **DISC MENU**, and then press **OK** to confirm.

Play DivX video

You can play DivX files copied onto a CD-R/W, recordable DVD or USB device.

- 1 Insert a disc or connect a USB device.
- 2 Select a source:
 - For discs, press **DISC**.
 - For USB devices, press **USB**.

- 3 Select a file to play and press ►||.
 - To stop play, press ■.
 - To pause or resume play, press ►||.
 - To change a subtitle language, press **SUBTITLE**.



Note

- You can only play DivX videos rented or purchased through the DivX registration code of this unit.
- Subtitle files with the following filename extensions (.srt, .smi, .sub, .ssa, .ass) are supported but do not appear on the file navigation menu.
- The subtitle filename has to be the same as the file name of the video.

Play MP3/WMA/picture files

You can play MP3/WMA/picture files copied onto a CD-R/RW, recordable DVD or USB device.

- 1 Insert a disc or connect a USB device.
- 2 Select a source:
 - For discs, press **DISC**.
 - For USB devices, press **USB**.
- 3 Press ▲/▼ to select a folder, then press **OK** to confirm.
- 4 Press ▲/▼ to select a file from the folder.
- 5 Press ►|| to start play.
 - To stop play, press ■.
 - To pause or resume play, press ►||.
 - To skip to the previous/next file, press ◀/▶.
 - To return to the upper-level menu, press **DISC MENU**, and then press **OK** to confirm.

Play control

Select repeat/shuffle play options

- 1 During play, press **MODE/DIM** repeatedly to select a repeat option or the shuffle play mode.
 - To resume normal play, press **MODE/DIM** repeatedly until no option is displayed.

Repeat A-B (DVD/VCD/CD/MP3/WMA)

- 1 During music or video play, press **A-B** at the start point.
- 2 Press **A-B** at the end point.
 - ↳ The selected section starts to play repeatedly.
 - To cancel repeat play, press **A-B** again.



Note

- The section A and B can be set only within the same track/title.

Search forward/backward

- 1 During play, press ◀◀/▶▶ repeatedly to select a search speed.
 - To resume play at normal speed, press ►||.

Search by time or chapter/track number

- 1 During video/audio play, press **GOTO** until a time field or chapter/track field is displayed.
 - For the time field, enter the play position in hours, minutes and seconds.
 - For the chapter/track field, enter the chapter/track.

- Play starts automatically at your selected point.

Resume video play from last stopped point

Note

- This feature is only available for DVD/VCD play.

- 1 In stop mode and when the disc has not been removed, press **▶II**.

To cancel resume mode and stop play completely:

- 1 In stop mode, press **■**.

Play options

Display play information

- 1 During play, press **DISPLAY/RDS** repeatedly to display play information.

Zoom in/out image

- 1 During video play, press **▼** (**ZOOM**) repeatedly to zoom in/out the image.
 - When the image is zoomed in, you can press **◀▶** to pan through the image.

Slow-motion play

- 1 During video play, press **▲** (**SLOW**) repeatedly to select a slow play option.
 - ↳ The sound is muted.
 - ↳ To resume play at normal speed, press **▶II**.

Change the audio channel

Note

- This feature is only available for VCD/DivX play.

- 1 During play, press **AUDIO** repeatedly to select an audio channel available on the disc:
 - Mono Left
 - Mono Right
 - Stereo

Select a camera angle

Note

- This feature is only available for DVDs recorded with multiple camera angles.

- 1 During play, press **ANGLE/PROG** repeatedly to select a camera angle.

Picture view options

Preview pictures

- 1 During play, press **■**.
 - ↳ The pictures in the current folder are displayed.
- 2 Press **▲/▼** to select a picture from the folder.
 - ↳ A thumbnail of the selected picture is displayed in the right pane.
- 3 Press **OK** to start slideshow from the selected picture.

Rotate picture

- 1 During play, press **◀▶/▲/▼** to rotate the picture anti-clockwise/clockwise.

6 Adjust settings

- 1 Press **SYSTEM MENU**.
- 2 Select a setup page.
- 3 Select an option and then press **▶▶**.
- 4 Select a setting and then press **OK**.
 - To return to the previous menu, press **◀◀**.
 - To exit the menu, press **SYSTEM MENU**.

General setup

On the **[General Setup]** page, you can set the following options:

[OSD language]

Select the preferred language for on-screen display.

[DivX® VOD Code]

Display the DivX® registration code.



Tip

- Enter this DivX registration code when you rent or purchase video from <http://vod.divx.com/>. The DivX videos rented or purchased through the DivX® VOD (Video On Demand) service can be played only on the device to which it is registered.

Audio setup

On the **[Audio Setup]** page, you can set the following options:

[Digital Output]

Select audio formats supported by the connected device.

- **[Off]** – Turn off the digital output.
- **[PCM]** – If the connected device cannot decode multichannel audio, select this option.

- **[All]** – If the connected device supports multi-channel audio formats, select this option.

[Night Mode]

Make loud sound level softer and soft sound level louder so that you can watch the DVD movies at a low volume, without disturbing others.

- **[On]** – enjoy quiet viewing at night (DVDs only).
- **[Off]** – enjoy surround sound with its full dynamic range.

Video setup

On the **[Video Setup]** page, you can set the following options:

[TV System]

Change this setting if the video does not appear correctly. By default, this setting matches the most common setting for TVs in your country.

- **[NTSC]** - For TV with NTSC color system.
- **[PAL]** - For TV with PAL color system.
- **[Multi]** - For TV that is compatible with both PAL and NTSC.

[TV Display]

The TV format determines the aspect ratio of display according to the type of TV you have connected.



4:3 Pan Scan (PS)



4:3 Letter Box (LB)



16:9 (Wide Screen)

- **[4:3 Pan Scan]** – For 4:3 screen TV: full-height display with the trimmed sides.
- **[4:3 Letter Box]** – For 4:3 screen TV: wide-screen display with black bars on the top and bottom of the screen.
- **[Wide Screen]** – For wide-screen TV: display ratio 16:9.

[Picture Setting]

Customize picture color settings.

[Component Video]

Set the video output according to the video connection. If the composite connection is used, this setting is not required.

- **[S-VIDEO]** – If the S-Video connection is used, select this option.
- **[Interlaced]** – For ordinary TV: turn on the interlace mode.
- **[P-Scan]** – For progressive scan TV: turn on the progressive scan mode.

Preferences

On the **[Preferences]** page, you can set the following options:

[Audio]

Select the preferred audio language for disc play.

[Subtitle]

Select the preferred subtitle language for disc play.

[Disc Menu]

Select the preferred disc menu language.

Note

- If the language you have set is not available on the disc, the disc uses its own default language.
- For some discs, the subtitle/audio language can only be changed from the disc menu.

[DivX Subtitle]

Select a character set that supports the DivX subtitle.

Note

- Ensure that the subtitle file has the exact same file name as the movie file. If for example the file name of the movie is 'Movie.avi', then you will need to name the text file 'Movie.sub' or 'Movie.srt'.

[Parental Control]

Restricts access to discs that are unsuitable for children. These types of discs must be recorded with ratings.

Press **OK**.

Select a rating level, then press **OK**.

Press the numeric keys to enter the password.

Note

- Rated discs above the level you set in **[Parental Control]** require a password to be played.
- The ratings are country-dependent. To allow all discs to play, select **[8.Adult]**.
- Some discs have ratings printed on them but are not recorded with ratings. This function has no effect on such discs.

[Password]

This setting allows you to change the password for parental control. The default password is 0000.

-
- 1) Press the numeric keys to enter '0000' or your last set password at **[Old Password]** field.
 - 2) Enter the new password at **[New Password]** field.
 - 3) Enter the new password again at **[Confirm new password]** field.
 - 4) Press **OK** to exit the menu.
-

Note

- If you forget the password, enter '0000' before you set a new password.

[Version Info]

Display the software version of this apparatus.

[Default]

Resets all the settings of this unit to factory default, except for the password and parental settings.

7 Tune to FM radio stations

- 1 Ensure that you have connected and fully extended the supplied FM antenna.
- 2 Press **TUNER**.
- 3 Press and hold **◀▶**.
- 4 When the frequency indication starts to change, release the button.
 - ↳ The FM tuner tunes to a station with strong reception automatically.
- 5 Repeat steps 3-4 to tune to more stations.

To tune to a weak station:

Press **◀▶** repeatedly until you find optimal reception.

Program radio stations automatically

Note

- You can program a maximum of 20 preset radio stations.

- 1 Press **◀▶** to select a preset number to start programming.
- 2 Press and hold **ANGLE/PROG** for 2 seconds to activate automatic programming.
 - ↳ **[AUTO]** (auto) is displayed briefly.
 - ↳ All available stations are programmed in the order of waveband reception strength.
 - ↳ The last programmed radio station is broadcast automatically.

Program radio stations manually

Note

- You can program a maximum of 20 preset radio stations.

- 1 Tune to a radio station.
- 2 Press **ANGLE/PROG** to activate programming.
- 3 Press **◀▶** to allocate a number from 1 to 20 to this radio station, then press **ANGLE/PROG** to confirm.
 - ↳ The preset number and the frequency of the preset station are displayed.
- 4 Repeat the above steps to program other stations.

Note

- To overwrite a programmed station, store another station in its place.

Tune to a preset radio station

- 1 Press **◀▶** to select a preset number that you want.

Tip

- You can also use the numerical keypad to select a preset station directly.

8 Adjust volume level and sound effect

Adjust volume level

- 1 During play, press **VOL +/-** to increase/decrease the volume level.

Select a sound effect



Note

- You cannot use different sound effects at the same time.

Select a preset sound effect

- 1 During play, press **DSC** repeatedly to select:
 - [Classic]
 - [Rock]
 - [Jazz]
 - [Pop]
 - [FLAT] (flat)

Enhance bass

- 1 To turn on bass enhancement, press **LOUD/DBB** repeatedly during play until the DBB logo is displayed.
 - To turn off bass enhancement, press **LOUD/DBB** repeatedly until the DBB logo disappears.

Select automatic loudness control

Automatic loudness control increases the treble and bass effect at low volume levels (the higher the volume, the lower the treble and bass levels).

- 1 To turn on automatic loudness control, press **LOUD/DBB** during play until the loudness icon is displayed.
 - To turn off automatic loudness control, press **LOUD/DBB** until the loudness icon disappears.

Mute sound

- 1 During play, press **MUTE** to mute/unmute sound.

Listen through headphone

- 1 Plug a headphone into the  socket on the unit.

9 Other features

Activate demonstration mode

You can see an overview of all features.

- 1 In standby mode, press **■** on the main unit to activate the demonstration mode.
 - ↳ A demonstration of major available features starts.

To deactivate the demonstration mode:

- 1 Press **■** on the main unit again.

Adjust brightness of display panel

- 1 In standby mode, press **MODE/DIM** repeatedly to select different levels of brightness for the display panel.

Set the alarm timer

- 1 Ensure that you have set the clock correctly.
- 2 In standby mode, press and hold **SLEEP/TIMER**.
 - ↳ The hour digits are displayed and begin to blink.
- 3 Press **+VOL -** to set the hour, then press **SLEEP/TIMER** again.
 - ↳ The minute digits are displayed and begin to blink.
- 4 Press **+VOL -** to set the minute.
- 5 Press **SLEEP/TIMER** to confirm.
 - ↳ **[OFF]** (off) begins to blink.
- 6 To activate the wake-up timer, press **+VOL -** to select **[ON]** (on) while **[OFF]** (off) is blinking.
 - ↳ A clock icon appears on the display.

- ↳ The unit turns on automatically at the set time and switches to the last selected source.
- ↳ To deactivate the alarm timer, select **[OFF]** (off) at step 6.

Set the sleep timer

- 1 When the unit is turned on, press **SLEEP/TIMER** repeatedly to select a set period of time (in minutes).
 - ↳ The unit turns off automatically after the set period of time.

Connect other devices

Listen to an audio player

You can listen to audio player through this unit.

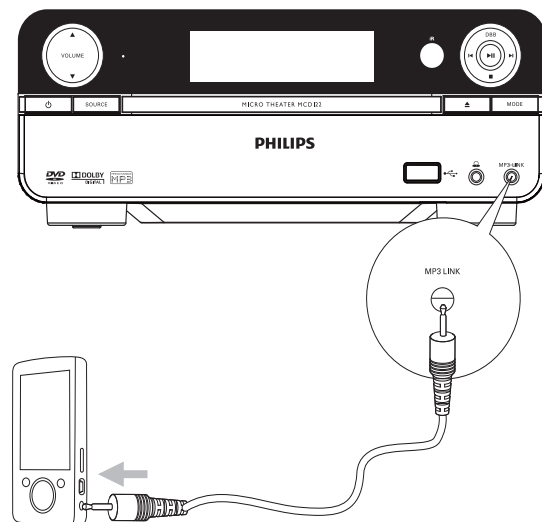

- 1 Connect the audio player:
 - For audio players with red/white audio output sockets: Connect a red/white audio cable (not supplied) to the **AUX IN L/R** sockets and to the audio output sockets on the audio player.

- For audio players with headphone sockets:
Connect a 3.5mm audio cable (not supplied) to the **MP3 LINK** socket and to the headphone socket on the audio player.

- Select the MP3 Link/AUX source.
- Start play on the audio player.

Record to a digital recorder

You can record audio from this unit to a digital recorder.

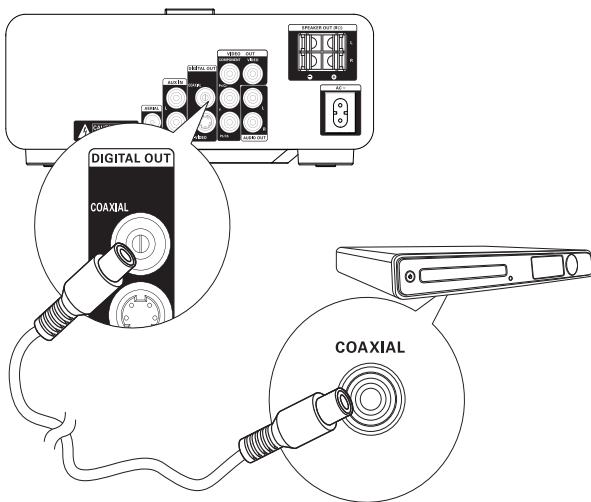

- Connect a coaxial cable (not supplied) to:
 - the **COAXIAL** socket
 - the digital input socket on the digital recorder
- Play audio to be recorded.
- Begin to record on the digital recorder (see the digital recorder user manual).

10 Product information

Note

- Product information is subject to change without prior notice.

Specifications

Amplifier

Rated Output Power	2X20W RMS
Frequency Response	20 -20000 Hz, ±3dB
Signal to Noise Ratio	>67dB
Aux Input	1 V RMS 20kohm

Disc

Laser Type	Semiconductor
Disc Diameter	12cm/8cm
Video Decoding	MPEG-1 / MPEG-2 / DivX
Video DAC	12Bits
Signal System	PAL / NTSC
Video Format	4:3 / 16:9
Video S/N	>48dB
Audio DAC	24Bits / 96kHz
Total Harmonic Distortion	<1% (1 kHz)
Frequency Response	4Hz - 20kHz (44.1kHz) 4Hz - 22kHz (48kHz) 4Hz - 24kHz (96kHz)
S/N Ratio	>67dBA

Tuner (FM)

Tuning Range	87.5 - 108MHz
Tuning grid	50KHz
Sensitivity - Mono, 26dB S/N Ratio	<22 dBf
Sensitivity - Stereo, 46dB S/N Ratio	>43 dBf
Search Selectivity	>28dBf
Total Harmonic Distortion	<3%
Signal to Noise Ratio	>50dB

Speakers

Speaker Impedance	8ohm
Speaker Driver	4" Full range
Sensitivity	>82dB/m/W

General information

AC power	220 V, 50 Hz
Operation Power Consumption	25W
Composite Video Output	1.0Vp-p, 75ohm
Coaxial Output	0.5Vpp ± 0.1Vpp 75ohm
Headphone Output	2X15mW 32ohm
USB Direct	Version 2.0
Dimensions - Main Unit (W x H x D)	220 x 90 x 240mm
- Speaker Box (W x H x D)	140 x 220 x 160 mm
Weight - With Packing	6 kg
- Main Unit	1.65 kg
- Speaker Box	2 x 1.5 kg

Supported disc formats

- Digital Video Discs (DVDs)

- Video CDs (VCDs)
- Super Video CDs (SVCDs)
- Digital Video Discs + Rewritable (DVD+RW)
- Compact Discs (CDs)
- Picture (Kodak, JPEG) files on CDR(W)
- DivX(R) disc on CD-R(W):
- DivX 3.11, 4.x and 5.x
- WMA

Supported MP3-CD formats:

- ISO 9660
- Max. title/album name: 12 characters
- Max. title number plus album: 255.
- Max. nested directory: 8 levels.
- Max. album number: 32.
- Max. MP3 track number: 999.
- Supported sampling frequencies for MP3 disc: 32 kHz, 44.1 kHz, 48 kHz.
- Supported Bit-rates of MP3 disc are: 32, 64, 96, 128, 192, 256 (kbps).
- The following formats are not supported:
 - Files like *.VMA, *.AAC, *.DLF, *.M3U,
 - *.PLS, *.WAV
 - Non-English Album/Title name
 - Discs recorded in Joliet format
 - MP3 Pro and MP3 with ID3 tag

USB playability information

Compatible USB devices:

- USB flash memory (USB 2.0 or USB1.1)
- USB flash players (USB 2.0 or USB1.1)
- memory cards (requires an additional card reader to work with this apparatus)

Supported formats:

- USB or memory file format FAT12, FAT16, FAT32 (sector size: 512 bytes)
- MP3 bit rate (data rate): 32-320 Kbps and variable bit rate
- WMA v9 or earlier
- Directory nesting up to a maximum of 8 levels
- Number of albums/ folders: maximum 99
- Number of tracks/titles: maximum 999
- ID3 tag v2.0 or later

- File name in Unicode UTF8 (maximum length: 128 bytes)

Unsupported formats:

- Empty albums: an empty album is an album that does not contain MP3/WMA files, and is not be shown in the display.
- Unsupported file formats are skipped. For example, Word documents (.doc) or MP3 files with extension .dlf are ignored and not played.
- AAC, WAV, PCM audio files
- DRM protected WMA files (.wav, .m4a, .m4p, .mp4, .aac)
- WMA files in Lossless format

11 Troubleshooting

Caution

- Never remove the casing of this unit.

To keep the warranty valid, never try to repair the system yourself.

If you encounter problems when using this unit, check the following points before requesting service. If the problem remains unsolved, go to the Philips web site (www.Philips.com/support). When you contact Philips, ensure that your unit is nearby and the model number and serial number are available.

No power

- Ensure that the AC cord of the apparatus is connected properly.
- Ensure that there is power at the AC outlet.
- As a power-saving feature, the system switches off automatically 15 minutes after track play reaches the end and no control is operated.

No disc detected

- Insert a disc.
- Check if the disc is inserted upside down.
- Wait until the moisture condensation at the lens has cleared.
- Replace or clean the disc.
- Use a finalized CD or correct format disc.

No picture

- Check the video connection.
- Turn on the TV to the correct Video-In channel.
- Progressive scan is activated but the TV does not support progressive scan.

Black and white or distorted picture

- The disc does not match the TV color system standard (PAL/NTSC).
- Sometimes a slight picture distortion may appear. This is not a malfunction.

- Clean the disc.
- A distorted picture may appear during progressive scan setup.

The aspect ratio of the TV screen cannot be changed even though you have set the TV display format.

- The aspect ratio is fixed on the loaded DVD disc.
- The aspect ratio may not be changed for some TV systems.

No sound or poor sound

- Adjust the volume.
- Disconnect the headphones.
- Check that the speakers are connected correctly.
- Check if the stripped speaker wires are clamped.

Remote control does not work

- Before you press any function button, first select the correct source with the remote control instead of the main unit.
- Reduce the distance between the remote control and the unit.
- Insert the battery with its polarities (+/– signs) aligned as indicated.
- Replace the battery.
- Aim the remote control directly at the sensor on the front of the unit.

Disc does not play

- Insert a readable disc and ensure that the label side faces up.
- Check the disc type, color system and regional code. Check for any scratches or smudges on the disc.
- Press **SYSTEM MENU** to exit the system setup menu.
- Disable the password for parental control or change the rating level.
- Moisture has condensed inside the system. Remove the disc and leave the system turned on for about an hour. Disconnect and reconnect the AC power plug, and then turn on the system again.
- As a power-saving feature, the system turns off automatically 15 minutes after

disc play reaches the end and no control is operated.

Poor radio reception

- Increase the distance between the unit and your TV or VCR.
- Fully extend the FM antenna.
- Connect an outdoor FM antenna instead.

Audio or subtitle languages cannot be set

- The disc is not recorded with sound or subtitles in multiple languages.
- The audio or subtitle language setting is prohibited on the disc.

Cannot display some files in USB device

- The number of folders or files in the USB device has exceeded a certain limit. This phenomenon is not a malfunction.
- The formats of these files are not supported.

USB device not supported

The USB device is incompatible with the unit. Try another one.

Timer does not work

- Set the clock correctly.
- Switch on the timer.

Clock/timer setting erased

- Power has been interrupted or the power cord has been disconnected.
- Reset the clock/timer.

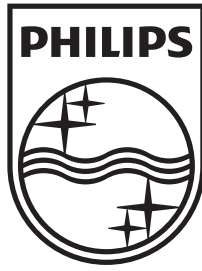

© 2011 Koninklijke Philips Electronics N.V.

All rights reserved.

MCD122_93_UM_V3.0