

Register your product and get support at
www.philips.com/welcome

PD7022
PD7022B



EN User manual 3

FR Mode d'emploi 89

DA Brugervejledning 23

IT Manuale utente 111

DE Benutzerhandbuch 45

NL Gebruiksaanwijzing 133

ES Manual del usuario 67

SV Användarhandbok 155

PHILIPS

Contents

1	Important	4
	Important Safety Instructions	4
	Notice	6
<hr/>		
2	Your portable DVD player	9
	Introduction	9
	What's in the box	9
	Overview of the main unit	10
	Overview of the second screen	12
<hr/>		
3	Get started	13
	Preparation	13
	Connect the second screen	14
	Connect power	15
<hr/>		
4	Use your player	16
	Turn on	16
	Select OSD language	16
	Play discs	16
	Play options	16
<hr/>		
5	Adjust settings	17
	Set the main unit	17
	Set the second screen	18
<hr/>		
6	Use more of your player	19
	Connect additional equipment	19
	Connect power from household source	19
<hr/>		
7	Product information	21
<hr/>		
8	Troubleshooting	22

1 Important

Important Safety Instructions

- ① Read these instructions.
- ② Keep these instructions.
- ③ Heed all warnings.
- ④ Follow all instructions.
- ⑤ Do not use this apparatus near water.
- ⑥ Clean only with dry cloth.
- ⑦ Do not install near any heat sources such as radiators, heat registers, stoves, or other apparatus (including amplifiers) that produce heat.
- ⑧ Protect the power cord from being walked on or pinched, particularly at plugs, convenience receptacles, and the point where they exit from the apparatus.
- ⑨ Only use attachments/accessories specified by the manufacturer.
- ⑩ Unplug this apparatus during lightning storms or when unused for long periods of time.
- ⑪ Refer all servicing to qualified service personnel. Servicing is required when the apparatus has been damaged in any way, such as power-supply cord or plug is damaged, liquid has been spilled or objects have fallen into the apparatus, the apparatus has been exposed to rain or moisture, does not operate normally, or has been dropped.
- ⑫ Apparatus shall not be exposed to dripping or splashing.
- ⑬ Do not place any sources of danger on the apparatus (e.g. liquid filled objects, lighted candles).
- ⑭ Where the MAINS plug or an appliance coupler is used as the disconnect device, the disconnect device shall remain readily operable.



Warning

- Never remove the casing of this apparatus.
- Never lubricate any part of this apparatus.
- Never place this apparatus on other electrical equipment.
- Keep this apparatus away from direct sunlight, naked flames or heat.
- Never look into the laser beam inside this apparatus.
- Ensure that you always have easy access to the power cord, plug or adaptor to disconnect this apparatus from the power.

Hearing safety

Listen at a moderate volume.

- Using headphones at a high volume can impair your hearing. This product can produce sounds in decibel ranges that may cause hearing loss for a normal person, even for exposure less than a minute. The higher decibel ranges are offered for those that may have already experienced some hearing loss.
- Sound can be deceiving. Over time your hearing 'comfort level' adapts to higher volumes of sound. So after prolonged listening, what sounds 'normal' can actually be loud and harmful to your hearing. To guard against this, set your volume to a safe level before your hearing adapts and leave it there.

To establish a safe volume level:

- Set your volume control at a low setting.
- Slowly increase the sound until you can hear it comfortably and clearly, without distortion.

Listen for reasonable periods of time:

- Prolonged exposure to sound, even at normally 'safe' levels, can also cause hearing loss.
- Be sure to use your equipment reasonably and take appropriate breaks.

Be sure to observe the following guidelines when using your headphones.

- Listen at reasonable volumes for reasonable periods of time.
- Be careful not to adjust the volume as your hearing adapts.

- Do not turn up the volume so high that you can't hear what's around you.
- You should use caution or temporarily discontinue use in potentially hazardous situations. Do not use headphones while operating a motorized vehicle, cycling, skateboarding, etc.; it may create a traffic hazard and is illegal in many areas.



Caution

- Use of controls or adjustments or performance of procedures other than herein may result in hazardous radiation exposure or other unsafe operation.

Notice

Any changes or modifications made to this device that are not expressly approved by Philips Consumer Lifestyle may void the user's authority to operate the equipment.



This product complies with the radio interference requirements of the European Community.

Environmental information

All unnecessary packaging has been omitted. We have tried to make the packaging easy to separate into three materials: cardboard (box), polystyrene foam (buffer) and polyethylene (bags, protective foam sheet.) Your system consists of materials which can be recycled and reused if disassembled by a specialized company. Please observe the local regulations regarding the disposal of packaging materials, exhausted batteries and old equipment.

Recycling



Your product is designed and manufactured with high quality materials and components, which can be recycled and reused.

When you see the crossed-out wheel bin symbol attached to a product, it means the product is covered by the European Directive 2002/96/EC:



Never dispose of your product with other household waste. Please inform yourself about the local rules on the separate collection of electrical and electronic products. The correct disposal of your old product helps prevent potentially negative consequences on the environment and human health.



Be responsible
Respect copyrights

The making of unauthorized copies of copy-protected material, including computer programs, files, broadcasts and sound recordings, may be an infringement of copyrights and constitute a criminal offence. This equipment should not be used for such purposes.

Recording and playback of material might require consent. See Copyright Act 1956 and The Performer's Protection Acts 1958 to 1972.

This product incorporates copyright protection technology that is protected by method claims of certain U.S. patents and other intellectual property rights owned by Macrovision Corporation and other rights owners. Use of this copyright protection technology must be authorized by Macrovision Corporation, and is intended for home and other limited viewing uses only unless otherwise authorized by Macrovision Corporation. Reverse engineering or disassembly is prohibited.



“DivX, DivX” Certified, and associated logos are trademarks of DivX, Inc. and are used under license.



Manufactured under license from Dolby Laboratories.

“Dolby” and the double-D symbol are trademarks of Dolby Laboratories.

This apparatus includes this label:



Norge

Typeskilt finnes på apparatens underside.

Observer: Nettbryteren er sekundært innkoplet. Den innebygde nettdelen er derfor ikke frakoplet nettet så lenge apparatet er tilsluttet nettkontakten.

For å redusere faren for brann eller elektrisk støt, skal apparatet ikke utsettes for regn eller fuktighet.

2 Your portable DVD player

Congratulations on your purchase, and welcome to Philips! To fully benefit from the support that Philips offers, register your product at www.philips.com/welcome.

Introduction

Your portable DVD player plays digital video discs that conform to the universal DVD Video standard. With it, you can play movies with true cinema picture quality and stereo or multi-channel sound (depending on disc and playback set-up).

You can also select sound track, subtitle languages, and different angle of view (again depending on DVD disc). Besides, you can restrict the play of discs that are not suitable for children.

You can play the following discs on the DVD player (including CD-R, CD-RW, DVD±R and DVD±RW):

- DVD-Video
- Video CD
- Audio CD
- MP3 CD
- DivX
- Discs with JPEG files

What's in the box

Check and identify the contents of your package:

- Main unit x 1
- Second screen x 1
- AC power adaptor x 1, ASUC12E-090080 (Philips)
- Car adaptor x 1
- AV cable x 2
- Fastening strap x 2
- User Manual x 1
- Quick Start Guide x 1

Overview of the main unit

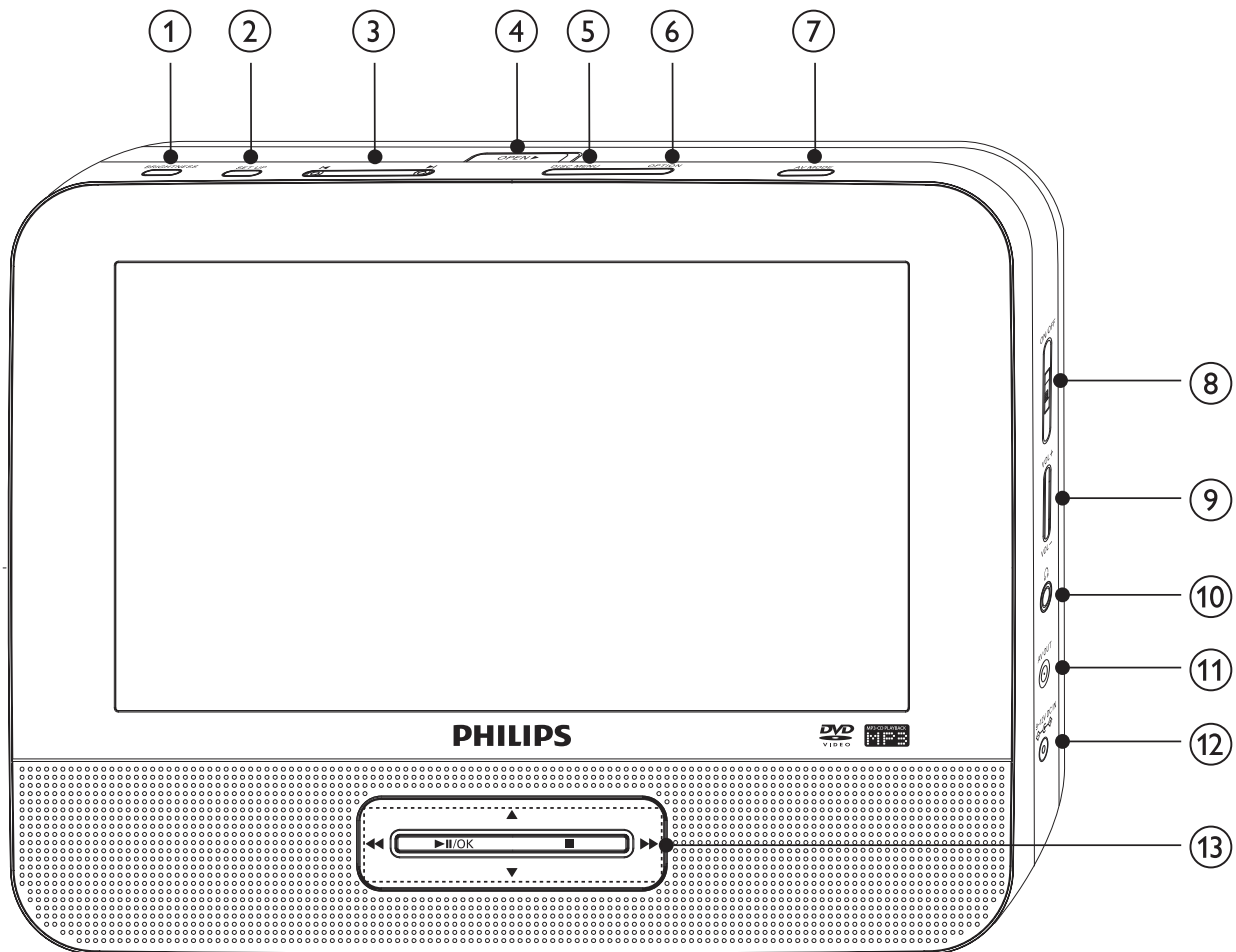

- ① **BRIGHTNESS**
 - Adjusts screen brightness.
- ② **SETUP**
 - Accesses or exits the setup menu.
- ③ **⏮, ⏭**
 - Skips to the previous or next title, chapter, or track.
- ④ **OPEN ▶**
 - Opens the disc compartment.
- ⑤ **DISC MENU**
 - For DVD, accesses or exits disc menu.
 - For VCD, turns on or off PBC (Playback Control) mode.
 - For VCD version 2.0 or SVCD with PBC turned on, returns to the menu.

- ⑥ **OPTIONS**
 - Accesses options relating to the current activity or selection.
- ⑦ **AV MODE**
 - Switches between PAL and NTSC mode.
- ⑧ **ON/OFF**
 - Turns on/off DVD player.
- ⑨ **VOL +/-**
 - Increases or decreases volume.
- ⑩ 
 - Headphone jack.
- ⑪ **AV OUT**
 - Audio/video output jack.
- ⑫ **DC IN**
 - Power supply socket.
- ⑬ **▲, ▼, ◀, ▶**
 - Navigates menus.
- ◀◀, ▶▶**
 - Searches backward/forward at different speeds.
- ▶||/OK**
 - Confirms an entry or selection.
 - Starts, pauses or resumes disc play.
- - Stops disc play.

Overview of the second screen

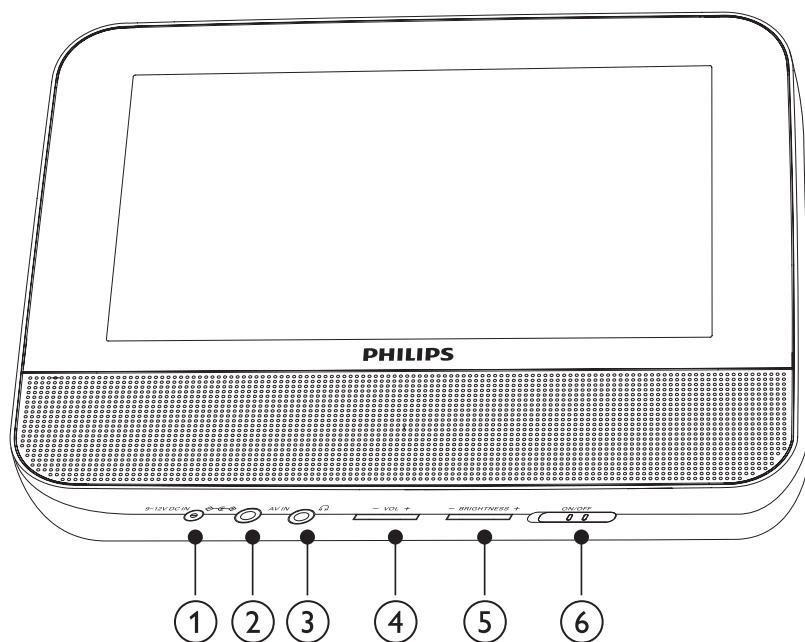

- ① **DC IN**
 - Power supply socket.
- ② **AV IN**
 - Audio/video input jack.
- ③ 
 - Headphone jack.
- ④ **VOL -/+**
 - Decreases or increases volume.
- ⑤ **BRIGHTNESS -/+**
 - Adjusts screen brightness.
- ⑥ **OFF/ON**
 - Turns off/on the second screen.

3 Get started



Caution

- Use the controls only as stated in this user manual.
- Always follow the instructions in this chapter in sequence.

If you contact Philips, you will be asked for the model and serial number of your player. The model number and serial number are on the bottom of your player. Write the numbers here:

Model No. _____

Serial No. _____

Preparation

To use the player in a car, attach the main unit and the second screen to the back of the front seat headrests.

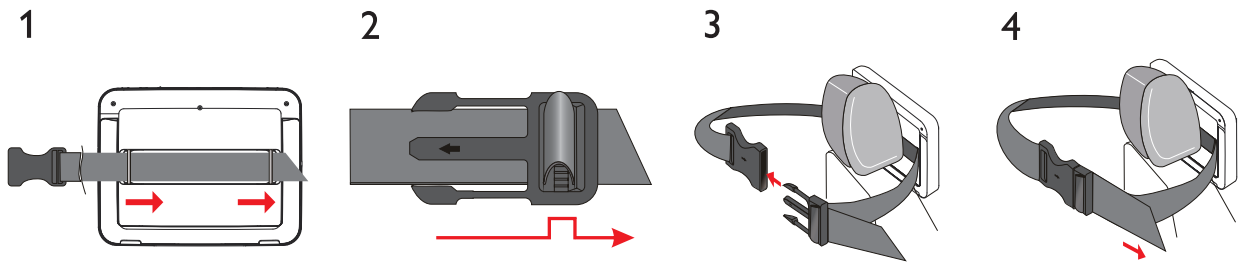

- 1 Pull the strap through the loops on the back of the main unit.
- 2 Hold the buckle with the marked arrow facing you, then attach the buckle to the strap.
- 3 Position the main unit at the back of the headrest, then fasten the buckle.
- 4 Pull the strap to secure the main unit to the headrest.
 - To attach the second screen, repeat the above steps.

Connect the second screen



Caution

- Turn off your player before you connect the second screen.

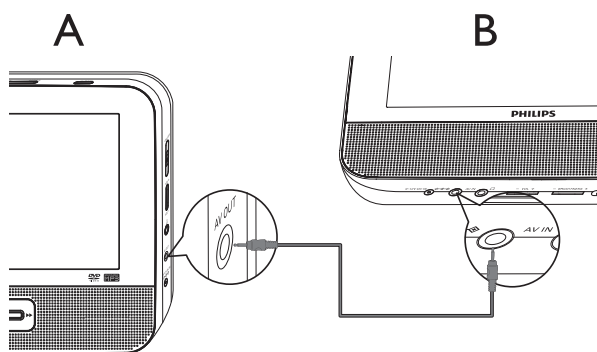

A: main unit; B: second screen

- 1 Connect the supplied AV cable to:
 - the **AV OUT** jack on the main unit.
 - the **AV IN** jack on the second screen.

Connect power



Caution

- Risk of product damage! Ensure that the power supply voltage corresponds to the voltage pointed on the back or the underside of the player.
- Risk of electric shock! When you unplug the AC adapter, always pull the plug from the socket. Never pull the cable.

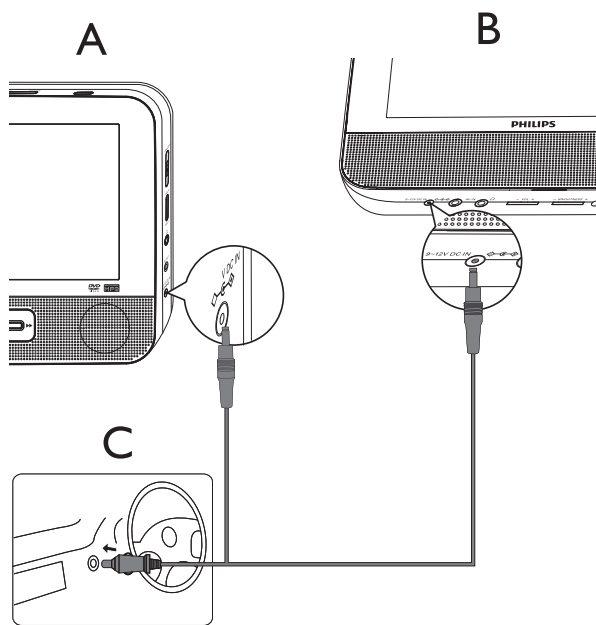

A: main unit; B: second screen; C: car cigarette lighter

- 1 Connect one end of the double-connector end of the AC cable to the **DC IN** jack on the main unit.
- 2 Connect the other end of the double-connector end of the AC cable to the **DC IN** jack on the second screen.
- 3 Connect the one-connector end to the car cigarette lighter socket.

4 Use your player

Turn on

- 1 Slide the **ON/OFF** switch on the main unit to the **ON** position.
 - To turn on the second screen, slide the **OFF/ON** switch on the second screen to the **ON** position.
-

Select OSD language

You can choose a different language for the on-screen display text.

- 1 Press **SETUP**.
 - ↳ The setup menu appears.
 - 2 Select **[General] > [Language]**.
 - 3 Press **▶** to select an option.
 - 4 Press **OK** to confirm.
 - 5 Press **SETUP** to exit.
-

Play discs

- 1 Slide **OPEN ▶** on the main unit.
 - 2 Insert the disc with label side facing up.
 - 3 Push down to close the disc compartment.
 - ↳ Play starts automatically. If not, press **▶||/OK**.
 - ↳ If a menu appears, select an item, then press **▶||/OK** to start play.
 - ↳ To pause, press **▶||/OK**. Press again to resume play.
 - ↳ To stop, press **■** twice.
 - ↳ To select the previous/next item, press **◀** or **▶**.
 - ↳ To start search within video/audio, press **◀◀** or **▶▶** once or more.
-

Play options

- 1 During play, press **OPTIONS** to select some play options.
- 2 Follow the on-screen instructions.

5 Adjust settings

Set the main unit

To maximize your play experience, use **SETUP** to fine tune your settings.

- 1 Press **SETUP**.
↳ The setup menu is displayed.
- 2 Use navigation keys to select an option and press **OK** to confirm.

[General]	
[Language]	Select on-screen display language
[PBC settings]	Set playback control function on/off.
[Power save]	Set power saving mode.
[DivX (VOD)]	Get DivX registration code.
[DivX subtitles]	Select DivX subtitle language.
[Parental(DVD)]	Select parental options.
[Set password]	Change existing password.
[Factory settings]	Restore factory settings.
[Video]	
[LCD Display]	Set screen display aspect ratio.
[TV standard]	Set video output format to TV system.
[Brightness]	Adjust screen brightness.
[Contrast]	Adjust screen contrast.
[Audio]	
[Dolby]	Set Dolby output.
[Version]	Check the version information.

- 3 Press ◀ to go back to the previous menu.
- 4 Press **SETUP** to exit.

Set the second screen

You can also set the second screen.

- To adjust volume level for the second screen, press **VOL -/+** on the second screen.
- To adjust the brightness of the second screen, press **BRIGHTNESS -/+** on the second screen.

6 Use more of your player

Connect additional equipment



Caution

- Turn off your player before connecting to any additional equipment.

You can connect the player to a TV or an amplifier to enjoy DVDs or Karaoke.

Match the color of the AV cables (the AV cable connected to TV is not supplied) with the jacks: the yellow cable is for the yellow video jack, the red/white cable is for the red/white audio jacks.

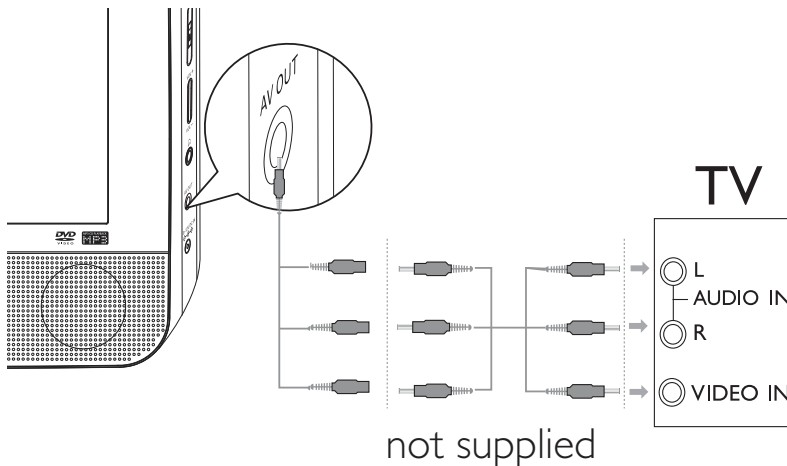

Connect power from household source



Caution

- Risk of product damage! Ensure that the power supply voltage corresponds to the voltage pointed on the back or the underside of the player.
- Risk of electric shock! When you unplug the AC adaptor, always pull the plug from the socket. Never pull the cable.

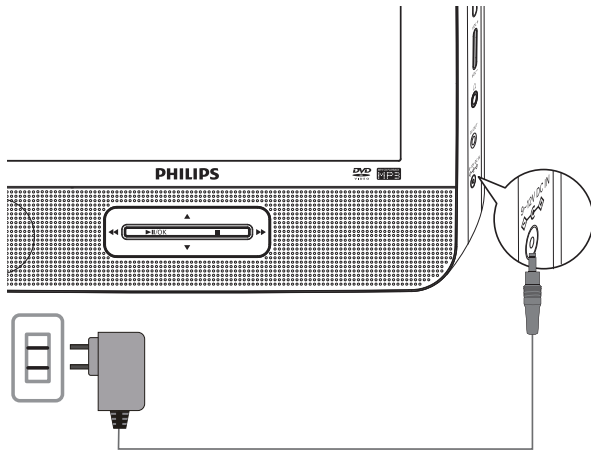

- 1 Connect the AC adaptor cable to:
 - the **DC IN** jack on the main unit.
 - the power outlet.

7 Product information



Note

- Product information is subject to change without prior notice.

Dimensions

- Main unit	200 × 155 × 39 mm
- Second screen	200 × 155 × 21 mm

Weight

- Main unit	0.7 kg
- Second screen	0.4 kg

Power supply

Input: 100-240V 50/60Hz 0.3A
Output: DC 9V 0.8A

Power consumption

9 W

Operating temperature range

0-45°C

Laser wavelength

650 nm

Video system

NTSC & PAL

Frequency response

20Hz-20KHz ± 1dB

Signal/noise ratio

≥ 80 dB

Audio distortion + noise

≤ -80 (1KHz)

Channel separation

≥ 80 dB

Dynamic range

≥ 80 dB

Audio out (analog audio)

Output level: 2V ± 10%

Load impedance

10 KΩ

Video out

Output level: 1V_p - p ± 20%

Load impedance

75 Ω

8 Troubleshooting



Warning

- Risk of electric shock. Never remove the casing of the player.

To keep the warranty valid, never try to repair the system yourself. If you encounter problems when using the player, check the following points before requesting service. If the problem remains unsolved, register your player and get support at www.philips.com/welcome.

No power

- Ensure that both plugs of the mains cord are properly connected.
- Ensure that there is power at the car cigarette lighter or AC outlet.

No sound

- Ensure that the AV cable is connected correctly.

Distorted picture

- Clean the disc. With a clean, soft, lint-free cloth, wipe the disc outwards from the center.
- Make sure that the video output format of the disc is compatible with the TV.
- Change the video output format to match your TV or program.
- The LCD is manufactured using high precision technology. You may, however, see tiny black points and/or bright points (red, blue, green) that continuously appear on the LCD. This is a normal result of the manufacturing process and does not indicate a malfunction.

Cannot play disc

- Ensure the disc label is upwards.
- Clean the disc. With a clean, soft, lint-free cloth, wipe the disc outwards from the center.
- Check if the disc is defective by trying another disc.

The player feels warm

- When the player is in use for a long period of time, its surface will be heated. This is normal.



© 2011 Koninklijke Philips Electronics N.V.

All rights reserved.

PD7022_12_UM_Sunplus_V5.0

