

Micro Hi-Fi System

MC157

Register your product and get support at
www.philips.com/welcome

User manual



PHILIPS

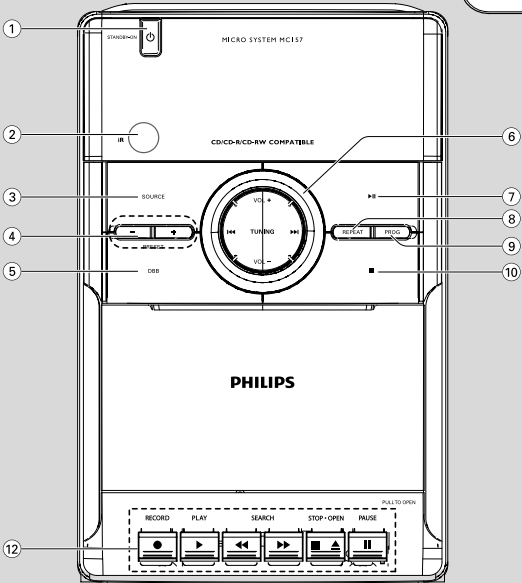
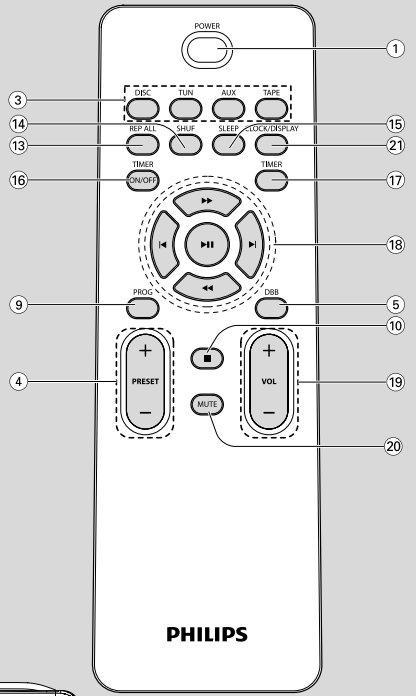
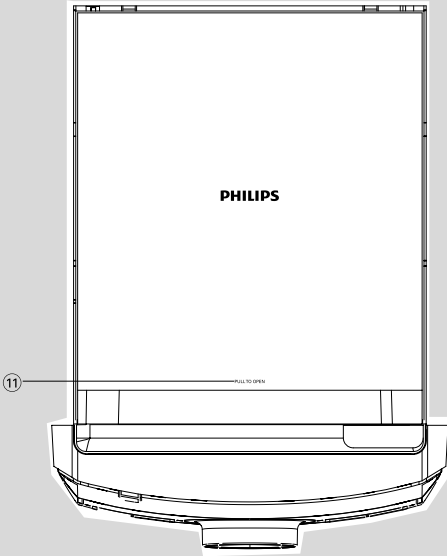

CAUTION

Use of controls or adjustments or performance of procedures other than herein may result in hazardous radiation exposure or other unsafe operation.

English 6

Contents

General Information

Supplied accessories	7
Environmental Information	7
Safety Information	7
Hearing Safety	8

Preparations

Rear connections	9
Inserting batteries into the Remote Control	10
Using the Remote Control to operate the system	10

Controls

Controls on the system and remote control	11
Controls available on the remote control only	11

Basic Functions

Switching the system on	12
Power-saving automatic standby	12
Adjusting volume and sound	12

CD Operation

Loading a disc	13
Basic playback controls	13
Different play modes: SHUFFLE and REPEAT	14
Programming track numbers	14
Reviewing the programme	14
Erasing the programme	14

Radio Reception

Tuning to radio stations	15
Programming radio stations	15
Automatic programming	15
Manual programming	15
Tuning to preset radio stations	15

Tape Operation / Recording

Tape playback	16
General information on recording	16
Synchro start CD recording	16
Recording from the radio	17

Other Connection

Listening to an external source	17
---------------------------------------	----

Maintenance

.....	18
-------	----

Clock/Timer

Setting the clock	19
Setting the timer	19
Activating and deactivating TIMER	19
Activating and deactivating SLEEP	19

Specifications

.....	20
-------	----

Troubleshooting

.....	21~22
-------	-------

Congratulations on your purchase and welcome to Philips!

To fully benefit from the support that Philips offers, register your product at www.philips.com/welcome.

Supplied accessories

- 2 speaker boxes
- remote control

Environmental Information

All unnecessary packaging has been omitted. We have tried to make the packaging easy to separate into three materials: cardboard (box), polystyrene foam (buffer) and polyethylene (bags, protective foam sheet).

Your system consists of materials which can be recycled and reused if disassembled by a specialized company. Please observe the local regulations regarding the disposal of packaging materials, exhausted batteries and old equipment.

Safety Information

- Before operating the system, check that the operating voltage indicated on the typeplate (or the voltage indication beside the voltage selector) of your system is identical with the voltage of your local power supply. If not, please consult your dealer.
 - Place the system on a flat, hard and stable surface.
 - Where the MAINS plug or an appliance coupler is used as the disconnet device, the disconnet device shall remain readily operable.
 - The apparatus shall not be exposed to dripping or splashing.
 - Install the unit near the AC outlet and where the AC power plug can be easily reached.
 - Place the system in a location with adequate ventilation to prevent internal heat build-up in your system. Allow at least 10 cm (4 inches) clearance from the rear and the top of the unit and 5 cm (2 inches) from each side.
- The ventilation should not be impeded by covering the ventilation openings with items, such as newspapers, table-cloths, curtains, etc.
 - Do not expose the system, batteries or discs to excessive moisture, rain, sand or heat sources caused by heating equipment or direct sunlight.
 - No naked flame sources, such as lighted candles, should be placed on the apparatus.
 - No objects filled with liquids, such as vases, shall be placed on the apparatus.
 - If the system is brought directly from a cold to a warm location, or is placed in a very damp room, moisture may condense on the lens of the disc unit inside the system. Should this occur, the CD player would not operate normally. Leave the power on for about one hour with no disc in the system until normal playback is possible.
 - The mechanical parts of the set contain self-lubricating bearings and must not be oiled or lubricated.
 - Batteries (battery pack or batteries installed) shall not be exposed to excessive heat such as sunshine, fire or the like.
 - **When the system is switched to Standby mode, it is still consuming some power. To disconnect the system from the power supply completely, remove the AC power plug from the wall socket.**

General Information

Hearing Safety

Listen at a moderate volume.

- Using headphones at a high volume can impair your hearing. This product can produce sounds in decibel ranges that may cause hearing loss for a normal person, even for exposure less than a minute. The higher decibel ranges are offered for those that may have already experienced some hearing loss.
- Sound can be deceiving. Over time your hearing "comfort level" adapts to higher volumes of sound. So after prolonged listening, what sounds "normal" can actually be loud and harmful to your hearing. To guard against this, set your volume to a safe level before your hearing adapts and leave it there.

To establish a safe volume level:

- Set your volume control at a low setting.
- Slowly increase the sound until you can hear it comfortably and clearly, without distortion.

Listen for reasonable periods of time:

- Prolonged exposure to sound, even at normally "safe" levels, can also cause hearing loss.
- Be sure to use your equipment reasonably and take appropriate breaks.

Be sure to observe the following guidelines when using your headphones.

- Listen at reasonable volumes for reasonable periods of time.
- Be careful not to adjust the volume as your hearing adapts.
- Do not turn up the volume so high that you can't hear what's around you.
- You should use caution or temporarily discontinue use in potentially hazardous situations.
- Do not use headphones while operating a motorized vehicle, cycling, skateboarding, etc.; it may create a traffic hazard and is illegal in many areas.

Disposal of your old product

Your product is designed and manufactured with high quality materials and components, which can be recycled and reused.



When this crossed-out wheeled bin symbol is attached to a product it means the product is covered by the European Directive 2002/96/EC

Please inform yourself about the local separate collection system for electrical and electronic products.

Please act according to your local rules and do not dispose of your old products with your normal household waste. The correct disposal of your old product will help prevent potential negative consequences for the environment and human health.

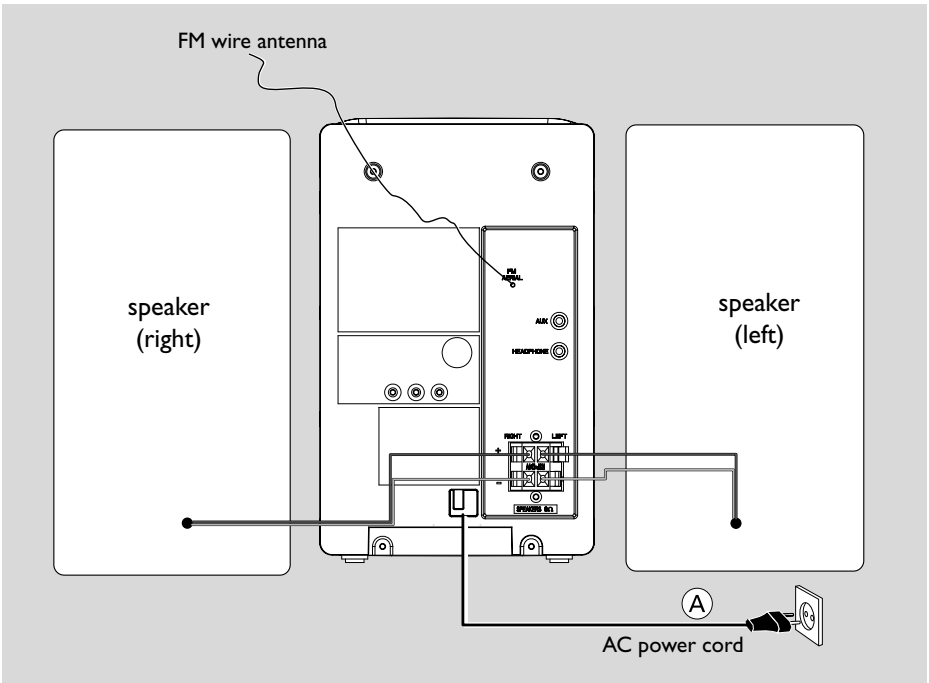

Rear connections

The type plate is located at the rear of the system.

(A) Power

- Before connecting the AC power cord to the wall outlet, ensure that all other connections have been made.

WARNING!

- For optimal performance, use only the original power cable.
- Never make or change any connections with the power switched on.

To avoid overheating of the system, a safety circuit has been built in. Therefore, your system may switch to Standby mode automatically under extreme conditions. If this happens, let the system cool down before reusing it (not available for all versions).

(B) Speakers Connection

Front Speakers

Connect the speaker wires to the SPEAKERS terminals, right speaker to "RIGHT" and left speaker to "LEFT", coloured (marked) wire to "+" and black (unmarked) wire to "–".

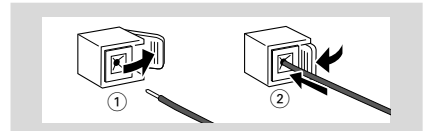

- Fully insert the stripped portion of the speaker wire into the terminal as shown.

Notes:

- For optimal sound performance, use the supplied speakers.
- Do not connect more than one speaker to any one pair of + / – speaker terminals.
- Do not connect speakers with an impedance lower than the speakers supplied. Please refer to the SPECIFICATIONS section of this manual.

Preparations

Inserting batteries into the Remote Control

- 1 Open the battery compartment.
- 2 Insert two R03 or AAA batteries following the indications (+/-) inside the compartment.
- 3 Close the cover.

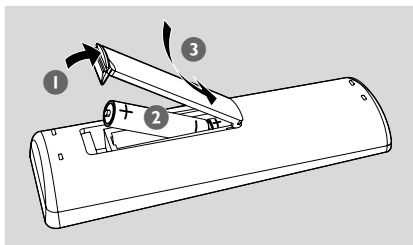









Using the Remote Control to operate the system

- 1 Aim the Remote Control directly at the remote sensor (IR) on the front panel.
- 2 Do not put any objects between the Remote Control and the system while operating the system.

CAUTION!

- Remove batteries if they are exhausted or if the Remote Control is not being used for a long time.
- Do not use old and new or different types of batteries in combination.
- Batteries contain chemical substances, so they should be disposed of properly.

Controls on the system and remote control

- ① **STANDBY-ON**  (**POWER**)
 - switches the system to standby or on.
 - ② **IR SENSOR**
 - infrared sensor for remote control.
 - ③ **SOURCE**
 - selects the respective sound source for CD/TUNER/TAPE/AUX.
 - switches on the system.
 - ④ **PRESET +/-**
 - for radio selects a preset radio station.
 - ⑤ **DBB (Dynamic Bass Boost)**
 - enhances the bass.
 - ⑥ **TUNING**  
 - for Tuner tunes to radio stations.
 - for CD skips to the beginning of the current/previous/subsequent track.
 - fast searches back and forward within a track/CD.
 - for clock/timer adjusts the hours and minutes for the clock/timer function
- VOL +/-**
- adjusts the volume level.
- ⑦ **II**
 - starts or interrupts CD playback.
 - ⑧ **REPEAT**
 - repeats a track/disc/all programmed tracks.
 - ⑨ **PROG**
 - for CD programmes tracks and reviews the programme.
 - for Tuner programmes tuner stations manually or automatically.
 - ⑩ **■**
 - stops CD playback or erases a CD programme.
 - ⑪ **PULL TO OPEN**
 - opens/closes the CD door.
 - ⑫ **Tape Deck Operation**
 - RECORD**  ... starts recording.
 - PLAY**  starts playback.
 - SEARCH**  /  fast rewinds/winds the tape.
 - STOP•OPEN**  
 - stops the tape; opens the tape compartment.
 - PAUSE II** interrupts recording or playback.





AUX jack (located on the back panel)

- connects an external source (3.5 mm socket)

HEADPHONE (located on the back panel)

- connects headphones

Controls available on the remote control only

- ⑬ **REP ALL**
 - selects Repeat All play mode.
 - ⑭ **SHUF**
 - plays CD tracks in random order.
 - ⑮ **SLEEP**
 - activates/deactivates or selects the sleeper time.
 - ⑯ **TIMER ON/OFF**
 - Turns on or off timer
 - ⑰ **TIMER**
 - sets the timer function.
 - ⑱ **II**
 - starts or interrupts CD playback.
-  / 
- for CD fast searches back and forward within a track/CD.
 - for Tuner tunes to radio stations.
 - for clock/timer adjusts the hours and minutes for the clock/timer function
-  / 
- for CD skips to the beginning of the current/previous/subsequent track.
- ⑲ **VOL +/-**
 - adjusts the volume level.
 - ⑳ **MUTE**
 - interrupts and resumes sound reproduction.
 - ㉑ **CLOCK/DISPLAY**
 - for CD displays the current track number during playback.
 - for clock sets the clock function

Basic Functions

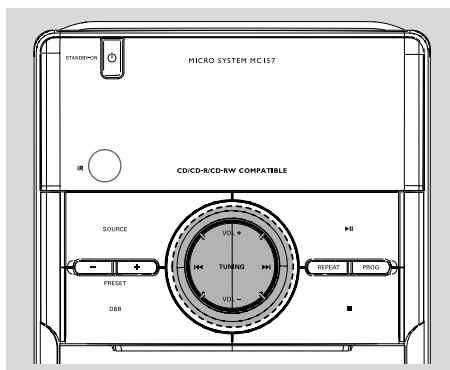

IMPORTANT:

Before you operate the system, complete the preparation procedures.

Switching the system on

- Press **STANDBY-ON**  or **SOURCE** (**POWER** on the remote control).
→ The system will switch to the last selected source.
- Press **DISC, TUN, TAPE** or **AUX** on the remote control.
→ The system will switch to the selected source.

To switch the system to standby mode

- Press **STANDBY-ON**  on the system (or **POWER** on the remote control).

Power-saving automatic standby

The power-saving feature automatically switches to standby 15 minutes after a CD playback has ended and no control is operated.

Adjusting volume and sound

- 1 Press **VOL + / -** to adjust volume.
→ Display shows the volume level  and a number from 0-32.
- 2 Press **DBB** to switch bass enhancement on or off.
→ Display shows: **DBB** if the DBB is activated.
- 3 Press **MUTE** on the remote control to interrupt sound reproduction instantly.
→ Playback will continue without sound.
- To activate sound reproduction you can:
 - press **MUTE** again;
 - adjust the volume controls;
 - change source.

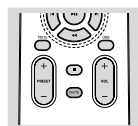

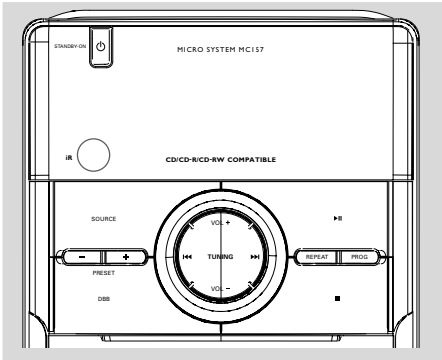

IMPORTANT:

The lens of the CD player should never be touched.

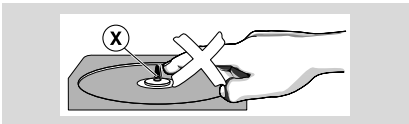

Loading a disc

This CD player plays Audio Discs including CD-Recordables and CD-Rewritables.

- CD-ROM, CD-I, CDV, MP3 CD, VCD, DVD or computer CDs, however, are not possible.

- 1 Select **CD** source.
- 2 Lift the CD door on the top of the system to open the CD compartment.
→ **OPEN** is displayed when you open the CD compartment.

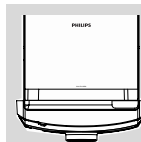

- 3 Insert a disc with the printed side facing up and press down on **PULL TO OPEN** to close the CD door.
→ "rEAD" is displayed as the CD player scans the contents of a disc, and then the total number of tracks is shown.

Basic playback controls

To play a disc

- Press **▶||** to start playback.
→ The current track number and the **PLAY** icon are displayed during disc playback.

To select a different track

- Press **TUNING** **◀◀ ▶▶** (on the remote control **◀◀ / ▶▶**) once or repeatedly until the desired track number appears in the display.

To find a passage within a track

- 1 Press and hold down on **TUNING** **◀◀ ▶▶** (on the remote control **◀◀ / ▶▶**).
→ The disc is played at high speed and low volume.
- 2 When you recognise the passage you want, release **TUNING** **◀◀ ▶▶** (on the remote control **◀◀ / ▶▶**).
→ Normal playback continues.

To interrupt playback

- Press **▶||** during playback.
→ The display freezes and the **PLAY** icon flashes when playback is interrupted.
→ To resume, press **▶||** again.

To stop playback

- Press **■**.

Notes: CD play will also stop when;

- the CD door is opened.
- the disc has reached the end.
- you select another source: **TUNER**, **TAPE** or **AUX**.
- you select standby.
- you press the tape deck **PLAY** **▶** key.

CD Operation

Different play modes: SHUFFLE and REPEAT

You can select and change the various play modes before or during playback. The play modes cannot be combined with PROGRAMME.

- SHUF** tracks of the entire disc are played in random order.
- REP ALL** repeats the entire disc/ programme.
- REP** plays the current track continuously.

- 1 To select Repeat play mode, press **REPEAT** on the main unit or **REP ALL** on the remote control.
- To select Shuffle play mode, press **SHUF** on the remote control.
- 2 Press **▶||** to start playback if in the STOP position.
- 3 To return to normal playback, press the respective **REPEAT** (on the main unit), **REP ALL** or **SHUF** (on the remote control) button until the various SHUFFLE/ REPEAT modes are no longer displayed.
- Press **■** once during playback to stop repeat/ shuffle playback.
- Press **■** again to cancel repeat/shuffle play mode.

Note:

–The **SHUFFLE** and **REPEAT** functions can be used simultaneously.

Programming track numbers

Programme in the STOP position to select and store your disc tracks in the desired sequence. If you like, store any track more than once. Up to 20 tracks can be stored in the memory.

- 1 In the stop position, use the **TUNING** **◀◀** **▶▶** (on the remote control **◀** / **▶**) to select your desired track number.
- 2 Press **PROG** to store.
→ Display: **PROG** flashes, and **□ 1** is displayed briefly, then the selected track number.
- 3 Repeat **steps 1-2** to select and store all desired tracks.
- 4 To start playback of your disc programme, press **▶||**

Reviewing the programme

- Stop playback and press **PROG**.

Erasing the programme

You can erase the programme by:

- pressing **■** once in the STOP mode;
- pressing **■** twice during playback;
- opening the CD compartment;
→ **PROG** disappears from the display.

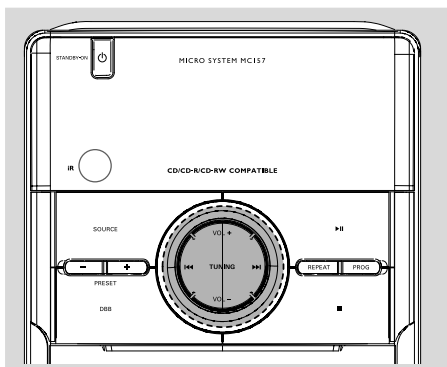

Tuning to radio stations

- 1 Press **SOURCE** on the set repeatedly or press **TUN** on the remote control repeatedly until the desired waveband (FM or MW) is displayed.
- 2 Press down on **TUNING** **◀◀ ▶▶** (**◀◀ / ▶▶** on the remote control) and release the button. → The radio automatically tunes to a station with sufficient reception. Display indication during automatic tuning: *57.5 H*.
- 3 Repeat step 2 if necessary until you find the desired station.
- To tune to a weak station, press **TUNING** **◀◀ ▶▶** (**◀◀ / ▶▶** on the remote control) briefly and repeatedly until you have found optimal reception.

Programming radio stations

You can store up to a total of 20 radio stations in the memory.

Automatic programming

Automatic programming will start with a chosen preset number. From this preset number upwards, former programmed radio stations will be overridden. The system will only programme stations which are not in the memory already.

- 1 Press **PRESET** **+/-** to select the preset number where programming should start.

Note:

– If no preset number is selected, default is preset (1) and all your presets will be overridden.

- 2 Press **PROG.** for more than 2 seconds to activate programming. → "Auto" is displayed and available stations are programmed in order of waveband reception strength. The first preset automatically stored will then be played.

Manual programming

- 1 Tune to your desired station (see Tuning to radio stations).
- 2 Press **PROG** to activate programming. → **PROG** flashes in the display.
- 3 Press **PRESET** **+/-** to allocate a number from 1 to 20 to this station.
- 4 Press **PROG** again to confirm the setting. → **PROG** disappears, the preset number and the frequency of the preset station are shown.
- 5 Repeat the above four steps to store other stations.
- You can override a preset station by storing another frequency in its place.

Tuning to preset radio stations

- Press **PRESET** **+/-** until the desired preset station is displayed.

Tape Operation / Recording

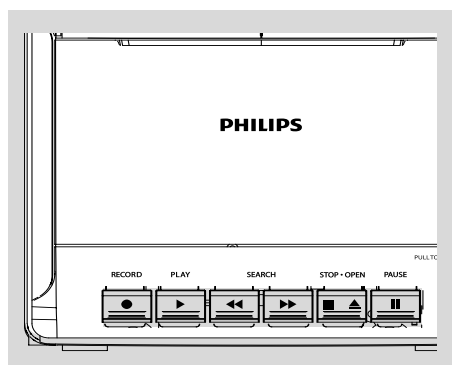

Tape playback

- 1 Select **TAPE** source.
→ Display: shows "tAPE" throughout tape operation.
- 2 Open the tape key flap marked "**PULL TO OPEN**" on the front panel.
- 3 Press **STOP•OPEN** ■ ▲ to open the tape door.
- 4 Insert a recorded tape and close the tape door.
- Load the tape with the open side downward and the full spool to the left.
- 5 Press **PLAY** ► to start playback.
- The key is automatically released at the end of a tape, except if **PAUSEII** has been activated.
- 6 To pause, press **PAUSEII**. Press again to resume.
- 7 By pressing ◀◀ or ▶▶ on the system fast winding of tape is possible in both directions.
- 8 To stop the tape, press **STOP•OPEN** ■ ▲.

Note:

– The source cannot be changed while playing or recording a tape.

General information on recording

- Recording is permissible insofar as copyright or other rights of third parties are not infringed.
- For recording, use only NORMAL (IEC type I) tapes on which the tabs have not yet been broken. This deck is not suited for recording on METAL (IEC IV) type tapes.

- The best recording level is set automatically. Altering the VOLUME or DBB controls will not affect the recording in progress.
- The recording sound quality might differ depending on the quality of your recording source and the recording tape.
- At the very beginning and end of the tape, no recording will take place during the 7 seconds when the leader tape passes the recorder heads.
- To protect a tape from accidental erasure, have the tape in front of you and break out the left tab. Recording on this side is no longer possible. If, however, you wish to record over this side again, cover the tabs with a piece of adhesive tape.

Synchro start CD recording

- 1 Select **CD** source.
- 2 Insert a disc and if desired, programme track numbers.
- 3 Press **STOP•OPEN** ■ ▲ to open the tape door.
- 4 Insert a suitable tape into the deck and close the tape door.
- 5 Press **RECORD** to start recording.
→ Playing of the CD programme starts automatically from the beginning of the CD after 7 seconds. It is not necessary to start the CD player separately.

To select and record a particular passage within a CD track:

- Press and hold down on I◀◀ ▶▶I. Release the control when you recognize the passage you want.
- To pause CD playback, press ►II.
- Recording starts from this exact point in the track when you press **RECORD** ●.
- 6 To pause, press **PAUSEII**. Press again to resume.
- 7 To stop recording, press **STOP•OPEN** ■ ▲.

Recording from the radio

- 1 Tune to the desired radio station (see Tuning to radio stations).
- 2 Press **STOP•OPEN** ■ ▲ to open the tape door.
- 3 Insert a suitable tape into the deck and close the tape door.
- 4 Press **RECORD** ● to start recording.
- 5 To interrupt playback press **PAUSE** II. To resume, press this key again.
- 6 To stop recording, press **STOP•OPEN** ■ ▲.

Listening to an external source

You can listen to the sound of the connected external device through your system's speakers.

- 1 Select **AUX** source by pressing **AUX** button.
- 2 Use a cinch cable (not supplied) to connect MC 157's AUX jack (3.5 mm, located on the back panel) to an AUDIO OUT or headphone jack on an external equipment (such as CD player, or VCR).

The making of unauthorized copies of copy-protected material, including computer programmes, files, broadcasts and sound recordings, may be an infringement of copyrights and constitute a criminal offence. This equipment should not be used for such purposes.



Be responsible
Respect copyrights

Maintenance

Cleaning the Cabinet

- Use a soft cloth slightly moistened with a mild detergent solution. Do not use a solution containing alcohol, spirits, ammonia or abrasives.

Cleaning Discs

- When a disc becomes dirty, clean it with a cleaning cloth. Wipe the disc from the centre out.
- Do not use solvents such as benzene, thinner, commercially available cleaners, or antistatic spray intended for analogue records.



Cleaning the disc lens

- After prolonged use, dirt or dust may accumulate at the disc lens. To ensure good playback quality, clean the disc lens with Philips CD Lens Cleaner or any commercially available cleaner. Follow the instructions supplied with cleaner.

Cleaning the Heads and the Tape Paths

- To ensure good recording and playback quality, clean the heads (A), the capstan(s) (B), and pressure roller(s) (C) after every 50 hours of tape operation.
- Use a cotton swab slightly moistened with cleaning fluid or alcohol.
- You can also clean the heads by playing a cleaning tape once.

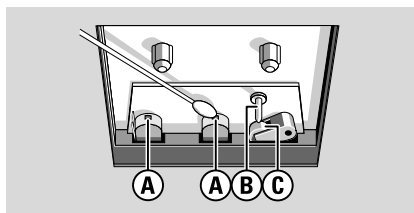

Demagnetising the heads

- Use a demagnetising tape available at your dealer.

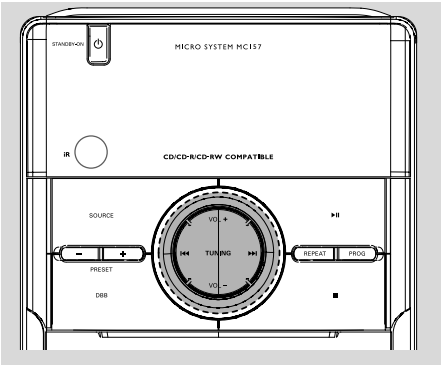

Setting the clock

- 1 In standby mode, press and hold **CLOCK/DISPLAY** on the remote control set for 2 seconds.
- 2 Press **PROG** to select 12-hour or 24-hour display.
- 3 Press **CLOCK/DISPLAY** to confirm.
→ The clock digits for the hours flash.
- 4 Press **TUNING** **◀◀ ▶▶** (**◀◀ / ▶▶** on the remote control) to set the hours.
- 5 Press **CLOCK/DISPLAY** again.
→ The clock digits for the minutes flash.
- 6 Press **TUNING** **◀◀ ▶▶** (**◀◀ / ▶▶** on the remote control) to set the minutes.
- 7 Press **CLOCK/DISPLAY** to confirm the time.

Note:

– The backlight for clock display is off in standby.

Setting the timer

- The system can be used as an alarm clock, whereby the CD or TUNER is switched on at a set time. The clock time needs to be set first before the timer can be used.
- 1 In standby mode, press and hold **TIMER** about 2 seconds on the remote control.
 - 2 Press **SOURCE** (or **DISC/TUN** on the remote control) to select sound source.
 - 3 Press **TIMER** to confirm your desired mode.
→ The clock digits for the hours flash.
 - 4 Press **TUNING** **◀◀ ▶▶** (**◀◀ / ▶▶** on the remote control) to set the hours.

- 5 Press **TIMER** again.
→ The clock digits for the minutes flash.
- 6 Press **TUNING** **◀◀ ▶▶** (**◀◀ / ▶▶** on the remote control) to set the minutes.
- 7 Press **TIMER** to confirm the time.
→ The timer is now set and activated.

Notes:

– If CD source is selected and no disc is in the CD tray or the disc has an error, TUNER will be selected automatically.

Activating and deactivating TIMER

- In standby or during playback, press **TIMER ON/OFF** once.
→ Display shows **⌚** if activated, and disappears if deactivated.

Activating and deactivating SLEEP

The sleep timer enables the system to switch off by itself after a set period of time.

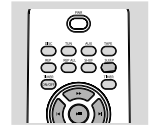

- Press **SLEEP** on the remote control once or more.
→ Display shows **zzz** and one of the sleep time options in sequence: **60, 45, 30, 15, 0, 60...** if you have selected a time.
- To deactivate, press **SLEEP** on the remote control once or more until **⌚** is shown, or press **STANDBY ON** (⏻) on the system (or **POWER** on the remote control).
→ **zzz** disappears from the display.

Specifications

AMPLIFIER

Output power 2 x 2W RMS
Signal-to-noise ratio \geq 60 dBA (IEC)
Frequency response 125 – 16000 Hz
Impedance loudspeakers 8 Ω

CD PLAYER

Frequency range 125 – 16000 Hz
Signal-to-noise ratio 65 dBA

TUNER

FM wave range 87.5 – 108 MHz
MW wave range 531 – 1602 kHz
Sensitivity
– FM 26 dB sensitivity 20 μ V
– MW 26 dB sensitivity 5 mV/m
Total harmonic distortion \leq 5%

TAPE DECK

Frequency response
Normal tape (type I) 125 – 8000 Hz (8 dB)
Signal-to-noise ratio
Normal tape (type I) 40 dBA
Wow and flutter \leq 0.4% JIS

SPEAKERS

Bass reflex system
Dimensions (w x h x d) .. 134 x 230 x 152 (mm)

GENERAL INFORMATION

AC Power 220 – 230V / 50 Hz
Dimensions (w x h x d) .. 148 x 233 x 216 (mm)
Weight (with/without speakers)
..... approx. 3.65 / 1.53 kg
Power consumption
Active 15 W
Standby < 4 W

Specifications and external appearance are subject to change without notice.

WARNING

Under no circumstances should you try to repair the system yourself, as this will invalidate the warranty. Do not open the system as there is a risk of electric shock.

If a fault occurs, first check the points listed below before taking the system for repair. If you are unable to remedy a problem by following these hints, consult your dealer or Philips for help.

Problem	Solution
<p>“NO CD” is displayed.</p>	<ul style="list-style-type: none"> ✓ Insert a disc. ✓ Check if the disc is inserted upside down. ✓ Wait until the moisture condensation at the lens has cleared. ✓ Replace or clean the disc, see “Maintenance”. ✓ Use a finalized CD-RW or CD-R.
<p>Radio reception is poor.</p>	<ul style="list-style-type: none"> ✓ If the signal is too weak, adjust the antenna for better reception. ✓ Increase the distance between the Mini HiFi System and your TV or VCR.
<p>Recording or playback cannot be made.</p>	<ul style="list-style-type: none"> ✓ Clean deck parts, see “Maintenance”. ✓ Use only NORMAL (IEC I) tape. ✓ Apply a piece of adhesive tape over the missing tab space.
<p>The system does not react when buttons are pressed.</p>	<ul style="list-style-type: none"> ✓ Remove and reconnect the AC power plug and switch on the system again.
<p>Sound cannot be heard or is of poor quality.</p>	<ul style="list-style-type: none"> ✓ Adjust the volume. ✓ Disconnect the headphones. ✓ Check that the speakers are connected correctly. ✓ Check if the stripped speaker wire is clamped.
<p>The left and right sound outputs are reversed.</p>	<ul style="list-style-type: none"> ✓ Check the speaker connections and location.

Troubleshooting

Problem	Solution
The remote control does not function properly.	<ul style="list-style-type: none">✓ Select the source (CD or TUNER, for example) before pressing the function button (▶, ◀, ▶).✓ Reduce the distance between the remote control and the system.✓ Insert the batteries with their polarities (+/- signs) aligned as indicated.✓ Replace the batteries.✓ Point the remote control directly towards the IR sensor:
The time is not working.	<ul style="list-style-type: none">✓ Set the clock correctly.✓ Press TIMER to switch on the timer.✓ If recording or tape dubbing is in progress, stop recording.
The Clock/Timer setting is erased.	<ul style="list-style-type: none">✓ Power has been interrupted or the power cord has been disconnected. Reset the clock/timer.

Meet Philips at the Internet
<http://www.philips.com>

English

