

## Alati seal, et teid aidata

Registreerige oma toode ja otsige abi koduleheküljelt  
[www.philips.com/welcome](http://www.philips.com/welcome)

AS860

Küsimus?  
Kontakteeruge  
Philipsiga



Eestikeelne kasutusjuhend

**PHILIPS**

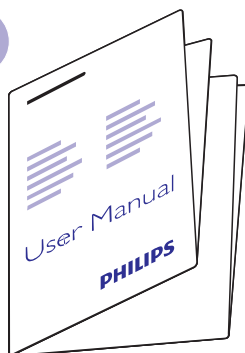
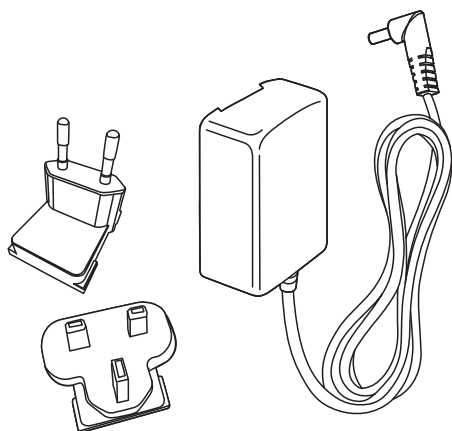
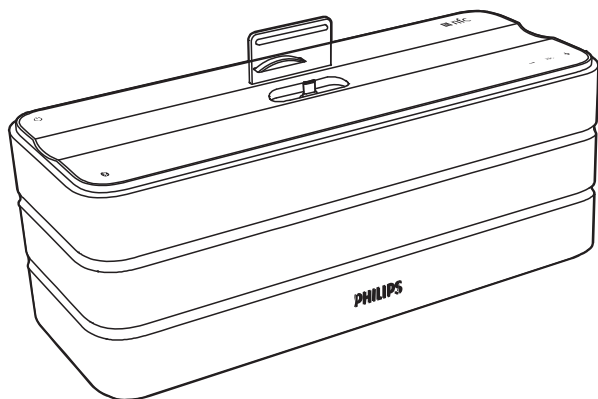

# Ettevalmistamine

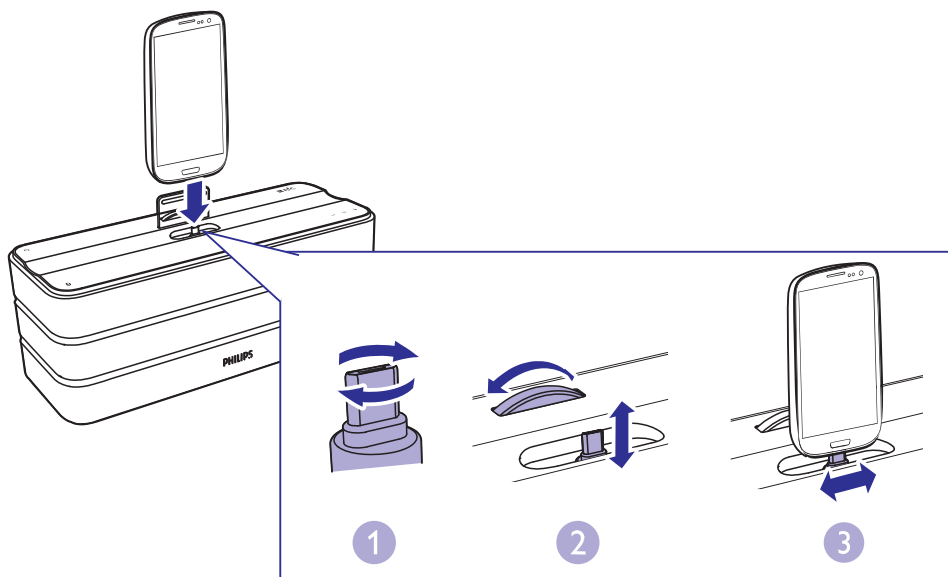

1. Kinnitage oma Android seade AS860 peale, joondades USB ühendused. Kui vaja, siis keerake AS860 peal olevat USB ühendust.
2. Keerake ratast, et kohandada kõrgust.
3. Liigutage alust, et paigutada oma Android seade täpselt nagu soovite.

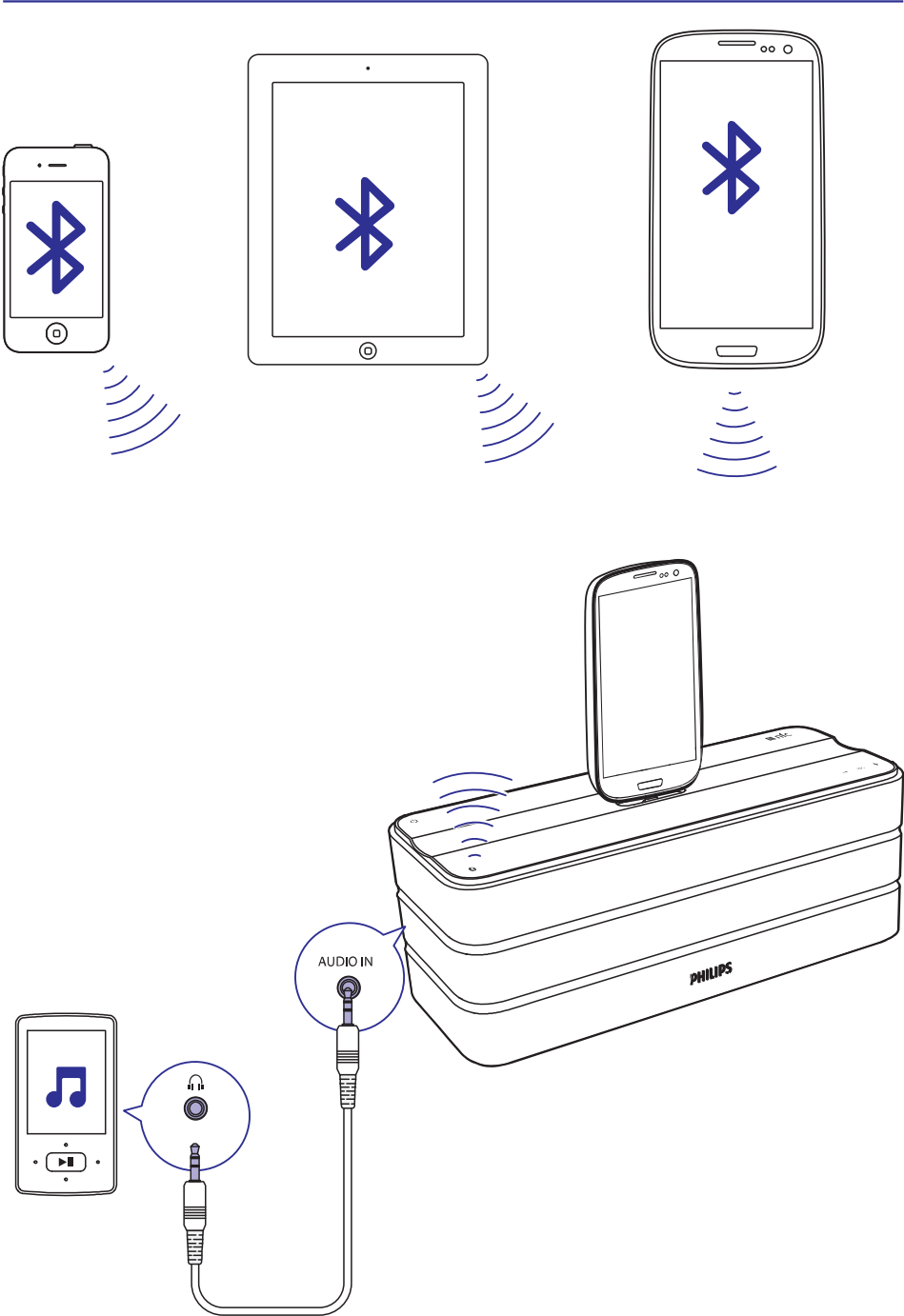

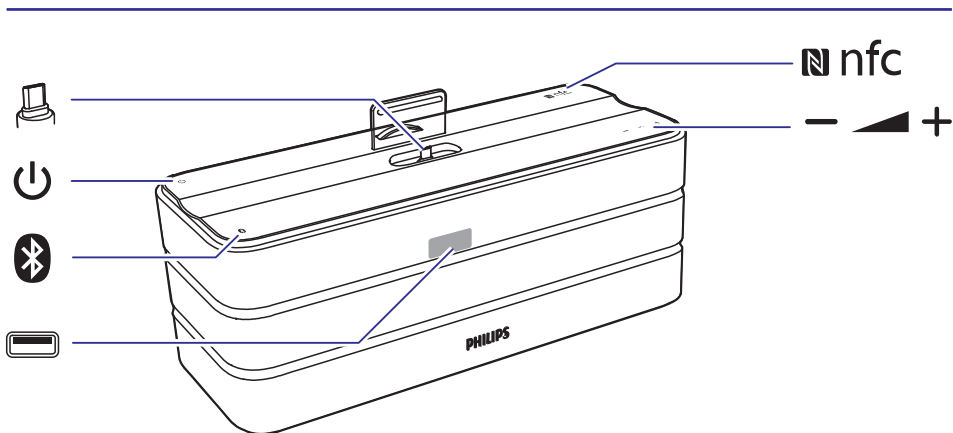

---

 USB alus

---

 Tagumine USB ühendus

---

 Vooluühenduse LED tuli

---

 Ühenduse staatuse LED tuli

---

 Kui jõuate maksimum/miinimum helitasemele, siis vooluühenduse LED vilgub

---

 NFC tag

---



## Laadimine

### Laadimine aluse kaudu

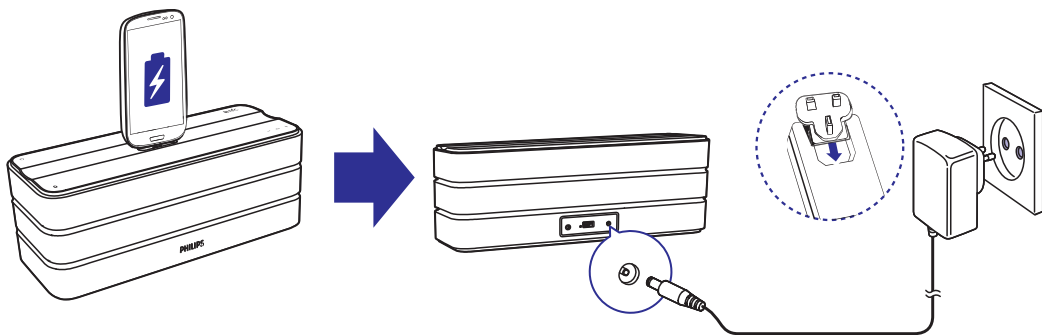

### Laadimine USB kaabli kaudu

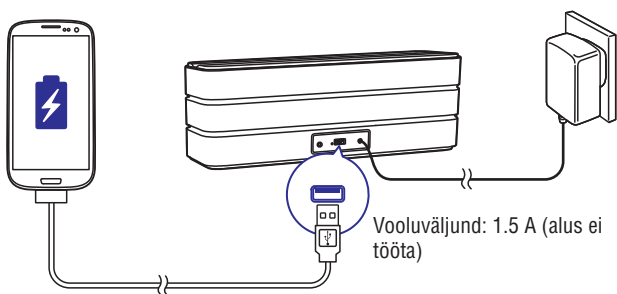

## Laadimine samal ajal aluse ja USB kaabli kaudu

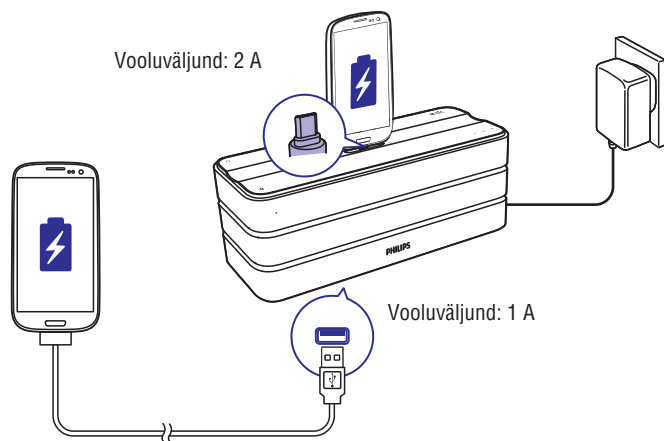

## AS860 laadimine

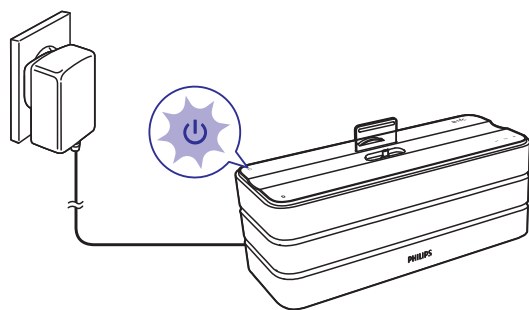

**Aku hakkab tühjaks saama:** punane tuli vilgub.

**Toimub laadimine:** punane tuli põleb (AS860 on puhkereziiimis); roheline tuli põleb (AS860 töötab).

**Laadimine on lõppenud:** tuli on kustus (AS860 on puhkereziiimis); roheline tuli põleb (AS860 töötab).

**Laadimisaeg:** kuni 5 tundi, et aku täielikult täis laadida.

**Taasesitusaeg:** kuni 8 tundi muusika taasesitamist läbi Bluetoothi.

**Märkus:** aku eluiga sõltub kasutamisest ning toote seadistustest.



## Sisse lülitamine ja ühendamine

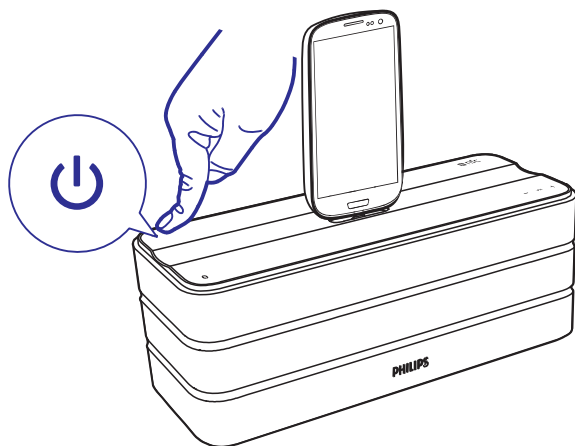

Vajutage ja hoidke all  nuppu, et lülitada kõlar sisse või puhkerežiimi. Süttib roheline LED tuli. Kui 15 minuti jooksul ei tehta AS860 peal ühtegi tegevust, lülitub see automaatselt puhkerežiimi.

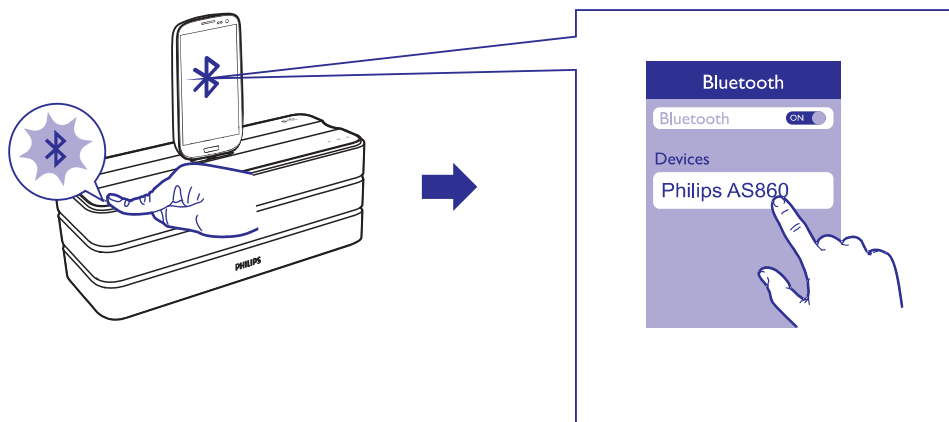

Vajutage nupule , et Bluetooth sisse lülitada.  
**Ühendamiseks valmis:** sinine tuli vilgub.

Aktiveerige oma Bluetooth seadmel  
Bluetooth ja otsige seadet **Philips AS860**.



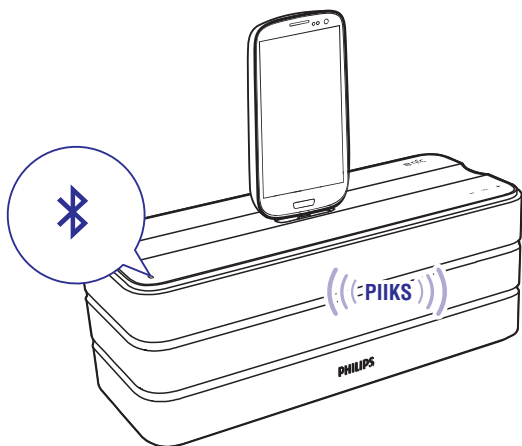

**Ühendus on loodud:** sinine tuli põleb.

Kui lülitate järgmisel korral seadmel AS860 Bluetoothi sisse, ühendab kõlar automaatselt viimasena seotud seadmega.



## Sisse lülitamine ja ühendamine

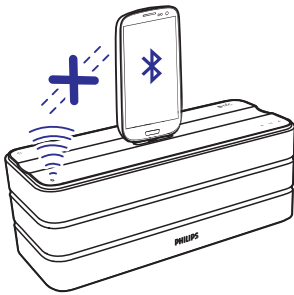

Mõne teise Bluetooth seadmega ühenduse loomiseks lülitage hetkel ühendatud Bluetooth seadmel Bluetooth välja.

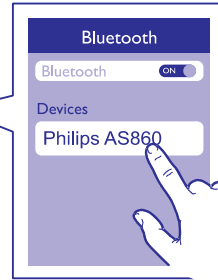
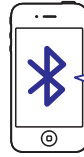
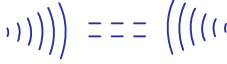

Aktiveerige oma Bluetooth seadmel Bluetooth ja otsige seadet **Philips AS860**.

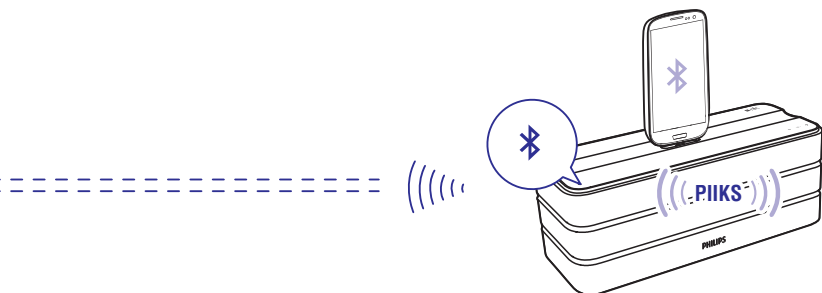

**Ühendus on loodud:** sinine tuli põleb.

Kui lülitate järgmisel korral seadmel AS860 Bluetoothi sisse, ühendab kõlar automaatselt viimasena seotud seadmega.

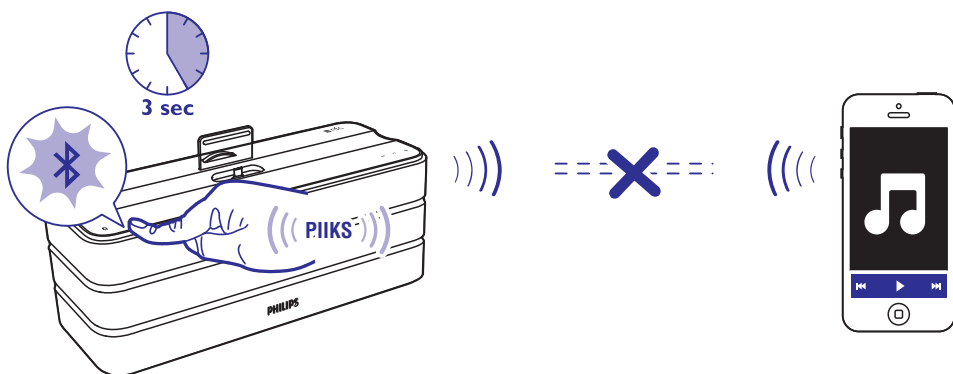

Hetkel ühendatud seadmega ühenduse katkestamiseks vajutage ja hoidke all  nuppu, et siseneda ühendamise režiimi.



## Ühendamine NFC kaudu

Kui teie Bluetooth seade toetab NFC (Near Field Communication) ühendust, siis:

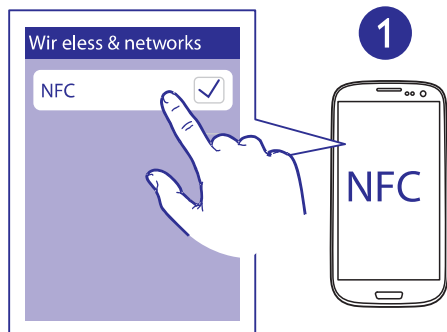

1. Lülitage oma Bluetooth seadmel sisse NFC.

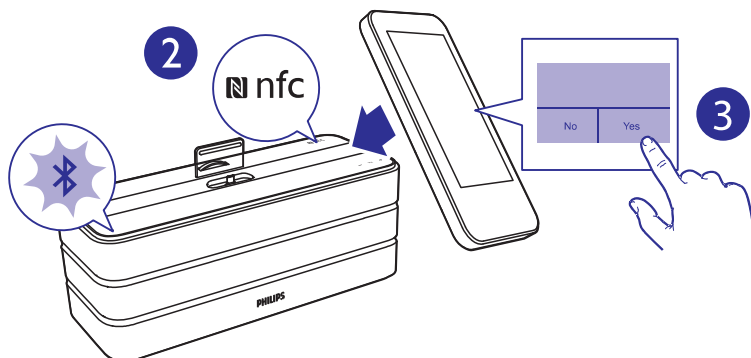

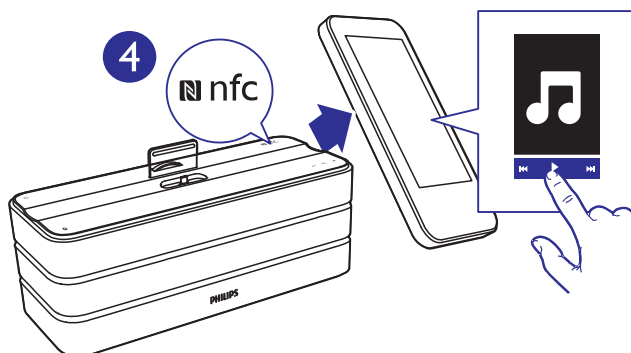

2. Puudutage Bluetooth seadme tagumise küljega NFC tagi seadmel AS860.
3. Järgige ekraanile ilmuvaid juhiseid, et siduda ja ühendada.



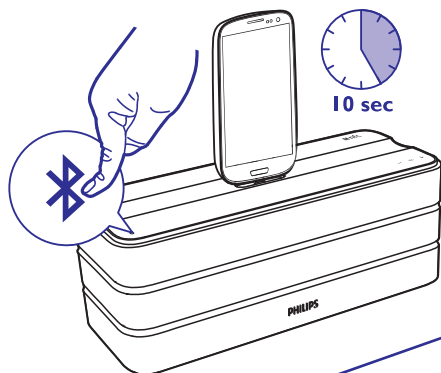

4. Pärast õnnestunud ühendust liigutage Bluetooth seade kaugemale seadmest AS860. Kui vaja, taaskäivitage muusika taaseistamine oma Bluetooth seadmel.

# Algseadistamine

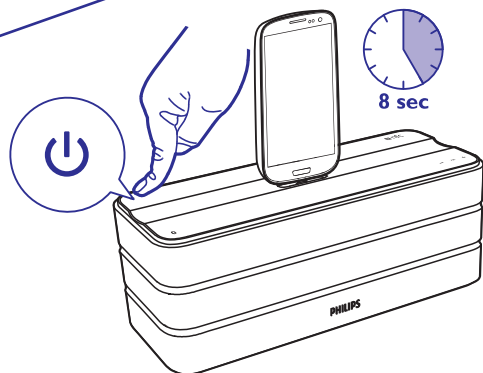

Ühendatud seadmete kustutamiseks AS860 mälust vajutage ja hoidke  nuppu all kauem kui 10 sekundit.



Tehaseseadete taastamiseks AS860 peal vajutage ja hoidke  nuppu all kauem kui 8 sekundit.

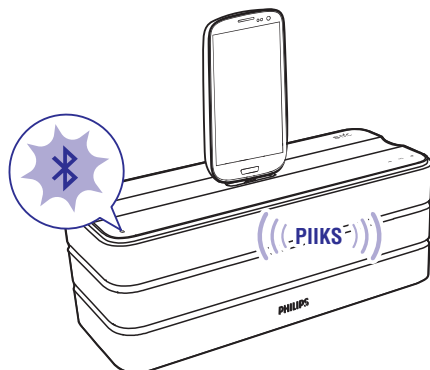

Te sisenete AS860 peal ühendamise režiimi. Ühendatud seadmel:

1. Eemaldage AS860 ühendus.
2. Otsige seadet **Philips AS860** ning ühendage see uuesti.



## Taasesitamine



Alustage ühendatud Android seadmel muusika taaseistamist.

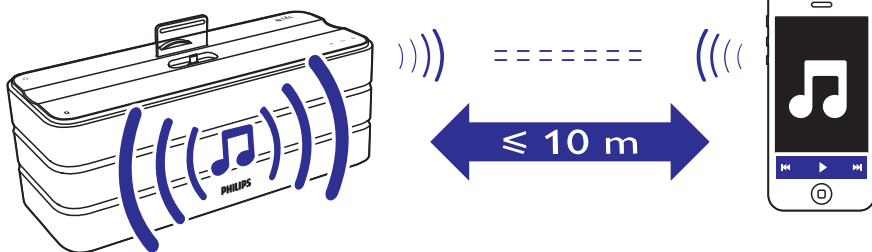

Lülitage ühendatud seadmel Bluetooth välja, et taasesitada muusikat mõnest teisest Bluetooth seadmest.

Muusika taasesitamine võib olla häiritud, kui seadme ja AS860 vahel on takistusi, nagu näiteks seinad või muud seadmed, mis töötavad samal sagedusel.

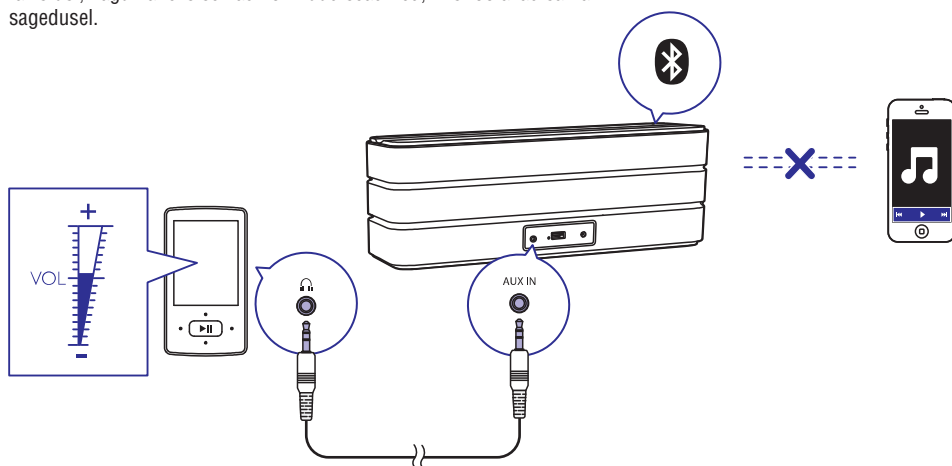

Kui soovite taasesitada läbi helikaabli, siis lülitage Bluetooth AS860 peal välja.

# Tehnilised andmed

---

## Võimendi

**Väljundvõimsus:** 2 x 10 W

**Signaali ja müra suhe:** > 65 dBA

**AUDIO-IN:** 0.6V RMS 22 kilo-oomi

**Kõlari takistus:** 8 oomi

## Bluetooth

**Sageduse vastuvõtt:** 2.402 ~ 2.480 GHz ISM Band

**Leviulatus:** 10m (vabas ruumis)

## Üldine informatsioon

### Vahelduvvool

Philips OH-1048E1503000U

Sisend: 100-240V~50/60 Hz, 1.5A MAX

Väljund: 15V DC, 3A

### Voolutarbimine

< 45 W (töörežiimis)

### Laadimine

USB alus: maksimaalselt 2000 mA

Tagumine USB ühendus: maksimaalselt 1000 mA (USB puhul töörežiimis);  
maksimaalselt 1500 mA (USB puhul väljalülitatult)

### Mõõtmed

Peaseade (L x K x S): 325 x 176 x 115 mm

### Kaal

Peaseade: 2 kg



[www.philips.com/support](http://www.philips.com/support)

Külastage veebilehekülge [www.philips.com/support](http://www.philips.com/support), et laadida alla kasutusjuhend ning leida vastused levinumatele probleemidele.

© 2013 WOOX Innovation Limited. Kõik õigused kaitstud.

Philips ja Philipsi kilp on äriühingule Koninklijke Philips Electronics N.V. registreeritud kaubamärgid ning WOOX Innovation Limited kasutab neid Koninklijke Philips Electronics N.V. poolt väljastatud litsentsi alusel.

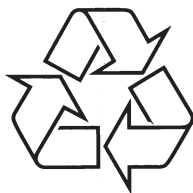

Külastage Philipsit internetis:  
<http://www.philips.com>