

## Supplied accessories

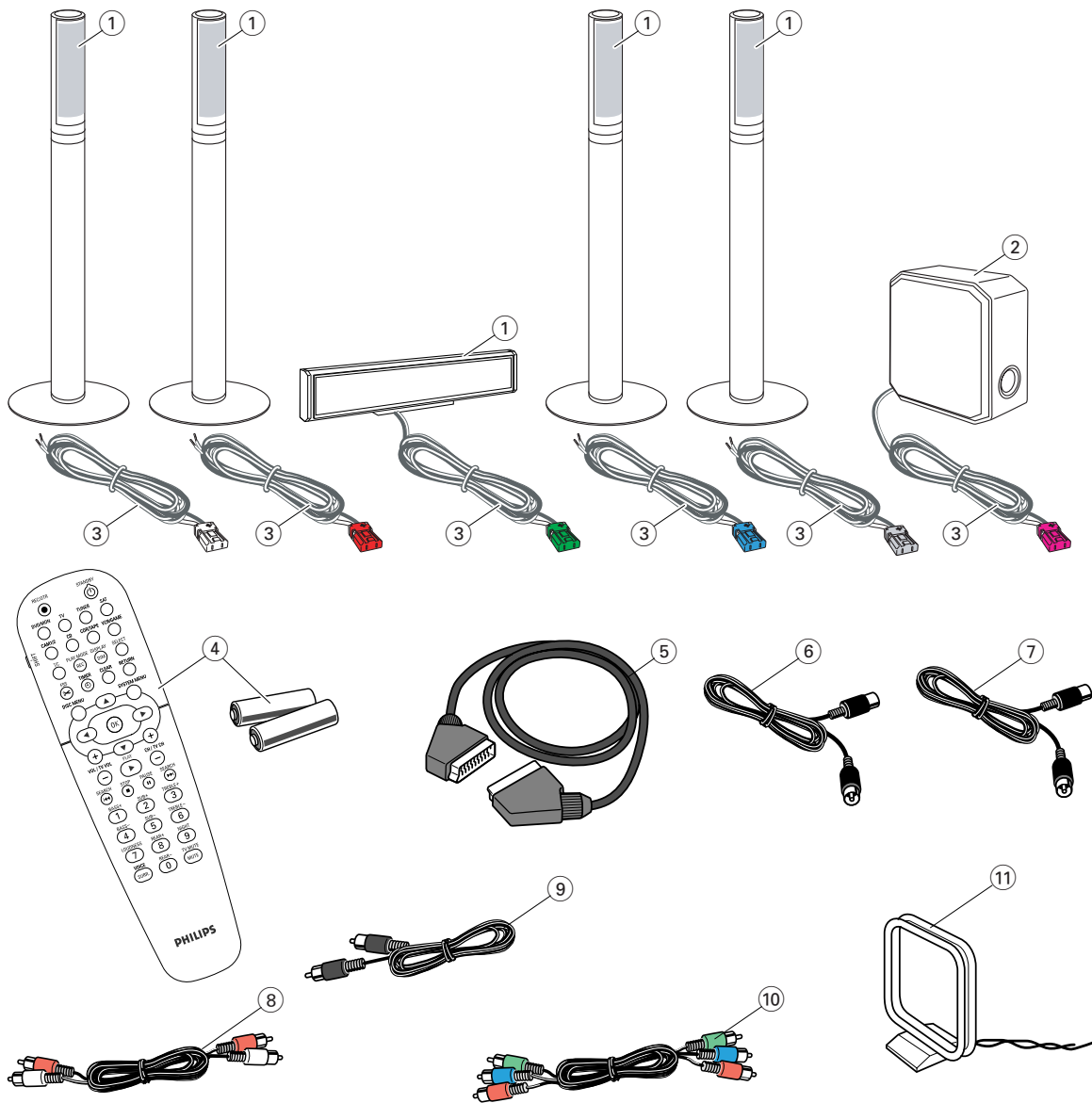

- Your DVD recorder system is delivered with
- ① 2 front, 1 centre and 2 rear speakers (see page 2)
  - ② 1 subwoofer
  - ③ 6 speaker cables
  - ④ 1 remote control with 2 AA batteries
  - ⑤ 1 Scart cable

- ⑥ 1 TV antenna cable
- ⑦ 1 FM antenna cable
- ⑧ 1 cinch audio cable (red and white plugs)
- ⑨ 1 digital audio cable (black plugs)
- ⑩ 1 Component Video cable (red, green and blue plugs)
- ⑪ 1 MW loop antenna

## Discs for recording



## Speakers

1

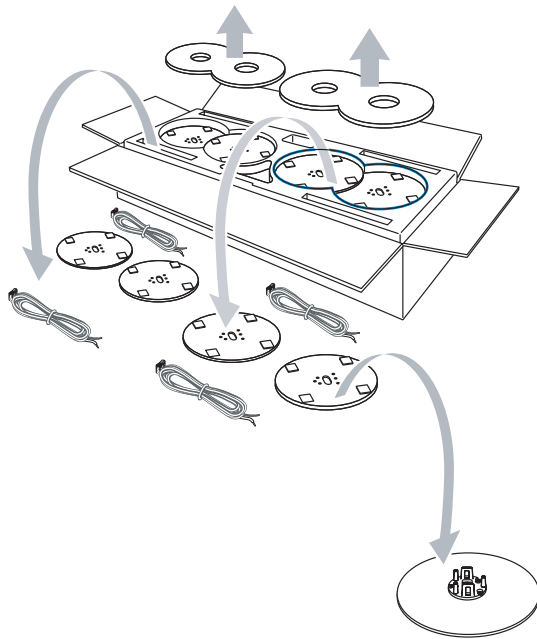

2

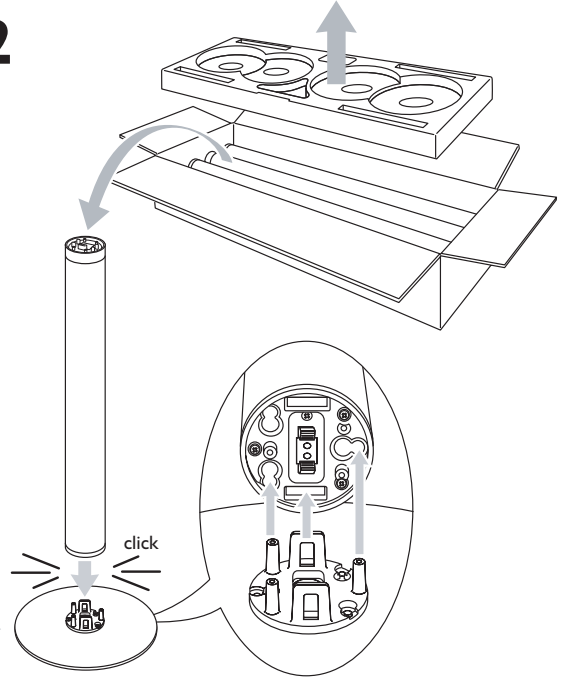

3

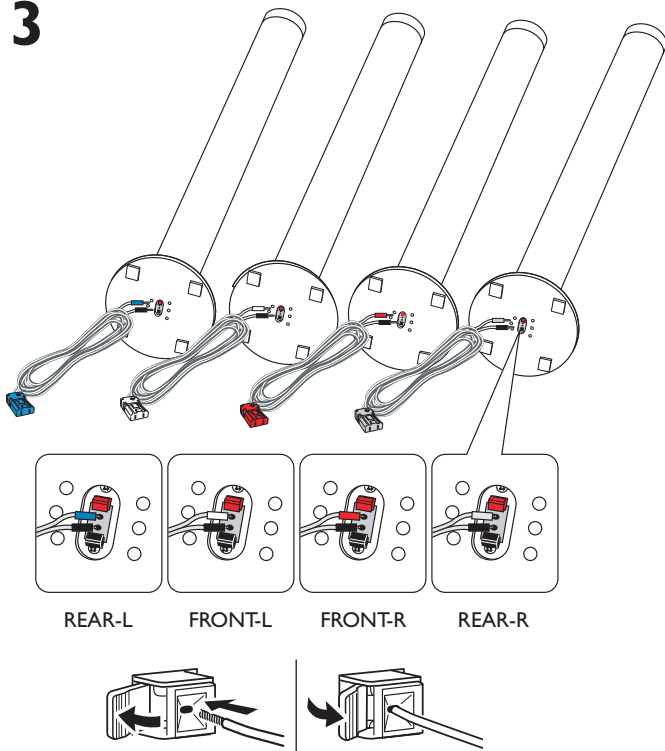

4

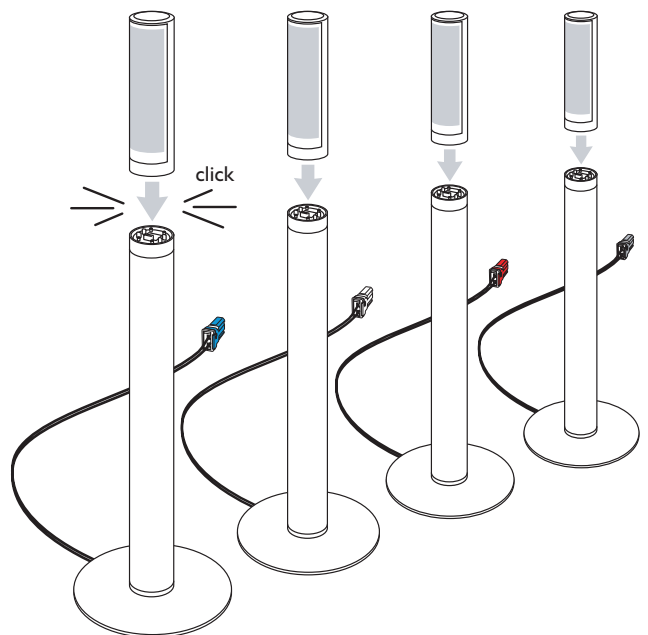

or

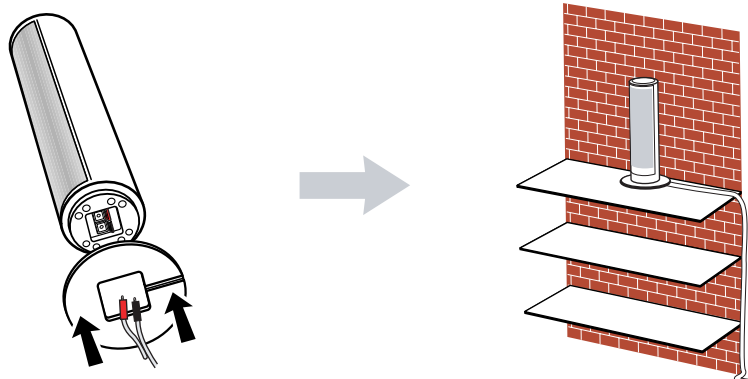

# Speakers

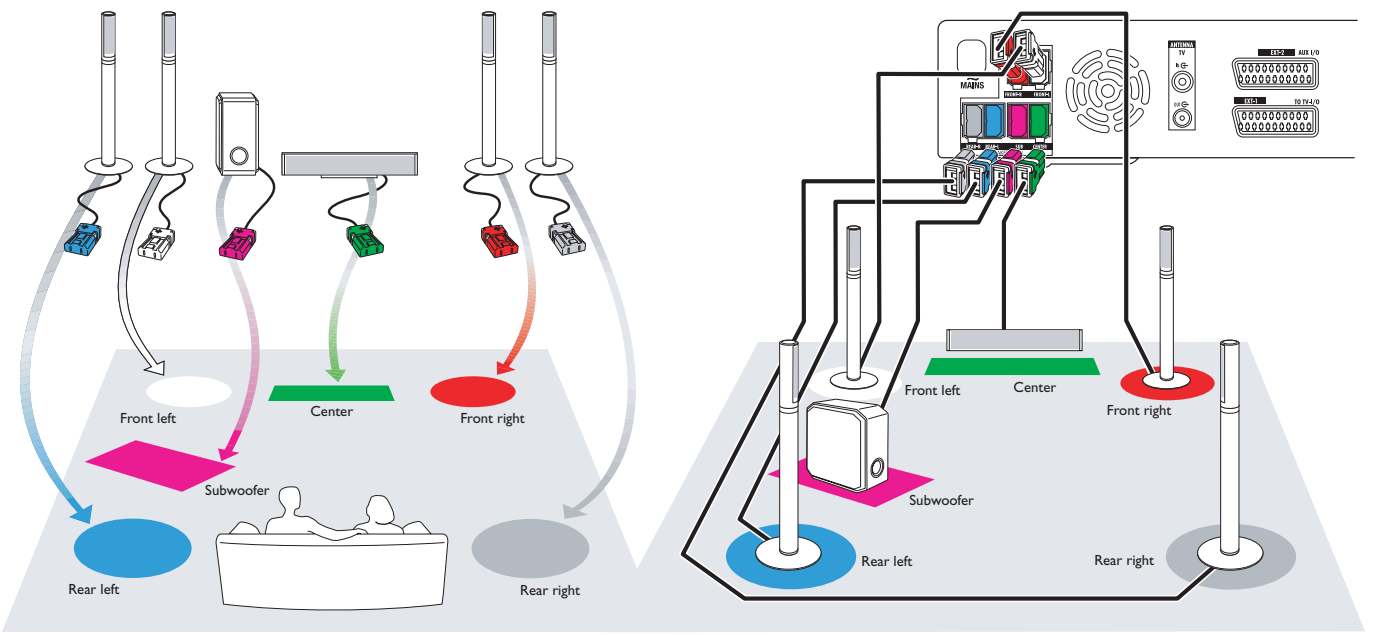

# Connections → User manual: see pages 12–16

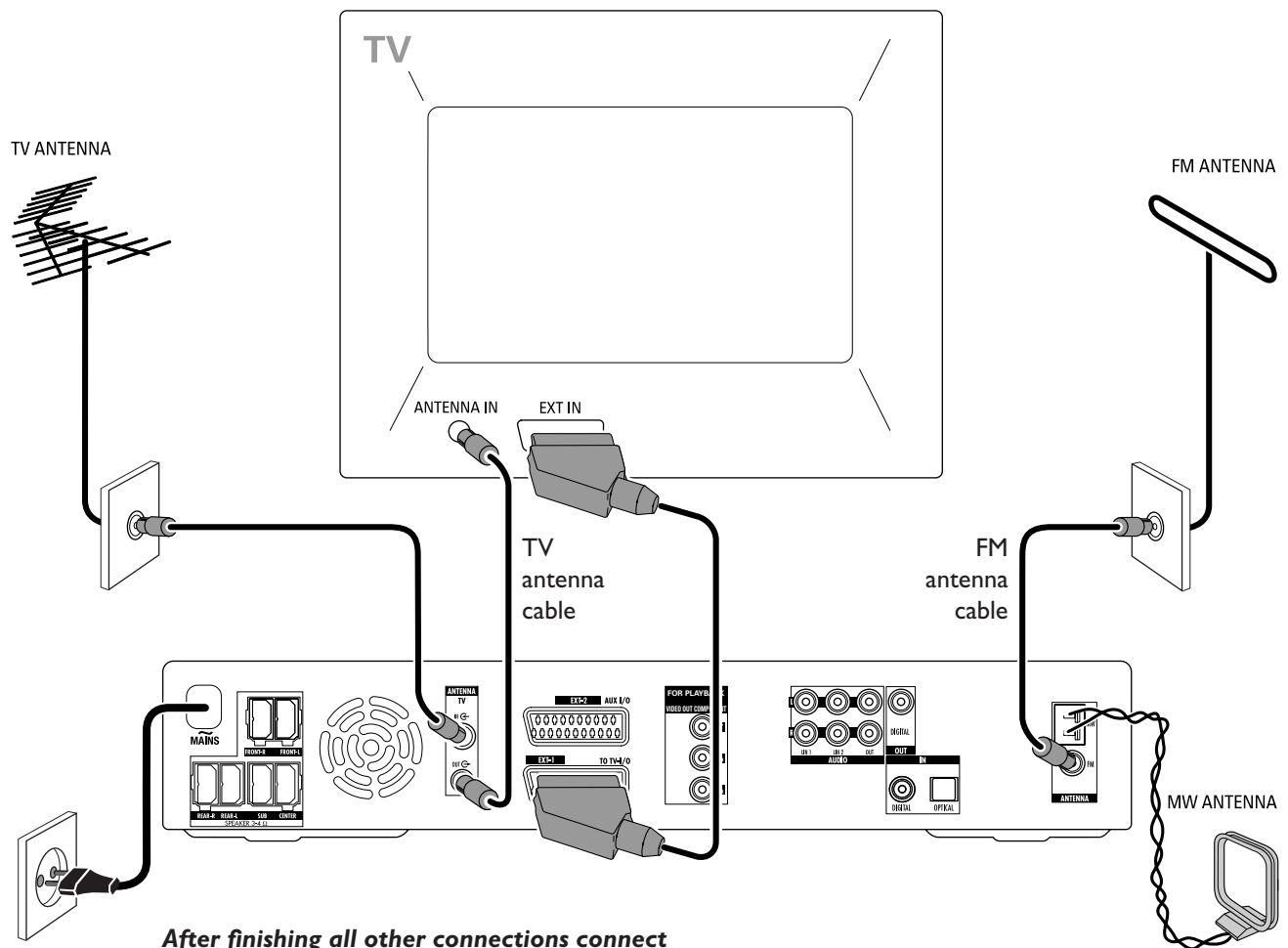

**After finishing all other connections connect the mains cable to the wall socket.**

# Initial installation

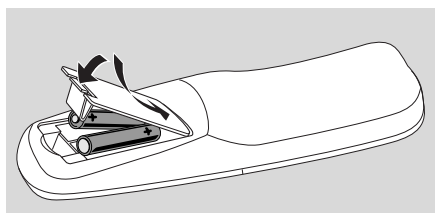

**1** Insert the batteries into the remote control.



**2** Switch on your TV.  
**3** Press DVD/MON to switch on the DVD recorder system. IS TV ON? will be displayed on the DVD recorder system.



**4** Press ▼, ▲ to select the language in which the display messages should appear on the TV screen. Next, press **OK**.

*If the previous menu does not appear, set the TV to the correct audio/video channel for the DVD recorder system. Such channels may be called AUX or AUXILIARY IN, AUDIO/VIDEO or A/V IN, EXT1, EXT2 or EXTERNAL IN, etc. These channels are often near channel 00.*



**5** Press ▼, ▲ to select the language in which a DVD should preferably be played. Next, press **OK**.



**6** Press ▼, ▲ to select the language in which subtitles should preferably be displayed. Next, press **OK**.

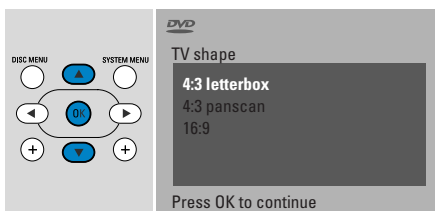

**7** Press ▼, ▲ to select the screen format. This setting will have an effect only with DVDs supporting different screen formats. Next, press **OK**.



**8** Press ▼, ▲ to select the country where you use the DVD recorder system. Next, press **OK**.

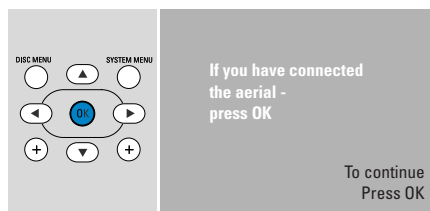

**9** Make sure the TV antenna or cable TV system is connected to the DVD recorder system. Next, press **OK**.

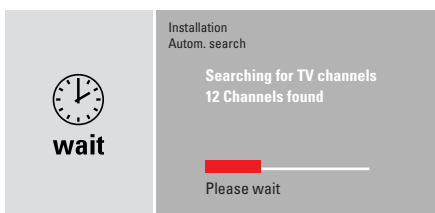

→ The DVD recorder system will search for available TV channels. This may take several minutes.

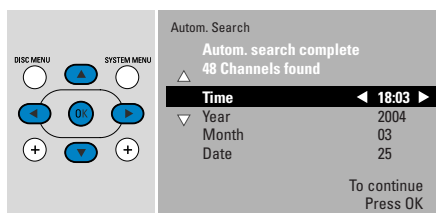

**10** Check the time and date. If necessary, use ▼, ▲, ◀, ▶ to set the time/date correctly. Next, press **OK**.

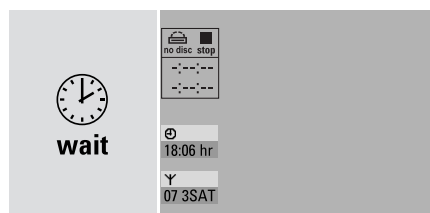

→ The TV screen will turn blank for about 1/2 minute. Next, the DVD screen will appear.  
**The DVD recorder system is ready for use!**

## Playing a disc

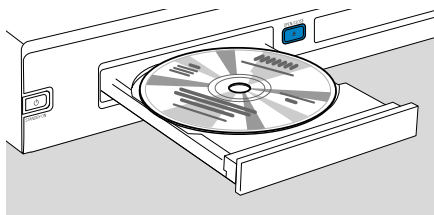

- 1 Press and hold DVD/MON for 1 second.
- 2 Press OPEN/CLOSE ▲ on the set to open the drawer.
- 3 Insert a disc (printed side up) in the tray.
- 4 Press OPEN/CLOSE ▲ on the set to close the drawer.

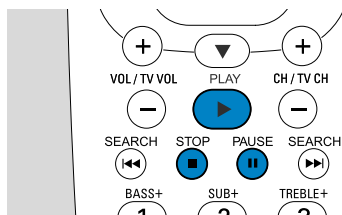

- 5 If playback does not start automatically, press PLAY ► to start playback.
- To interrupt playback press PAUSE ■.
- To resume playback press PLAY ►.
- 6 To stop playback, press STOP ■.

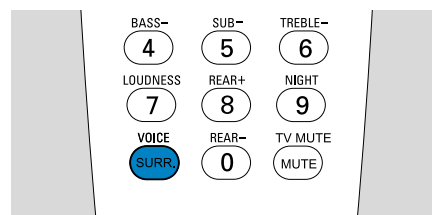

- To select one of the available surround modes, press SURR. repeatedly. The selected surround mode will be displayed on the DVD recorder system.

## Playing a radio station

Make sure the FM radio antenna is connected to the DVD recorder system.

When you press TUNER for the first time, the DVD recorder system will search for radio stations automatically. The search will take a couple of minutes.

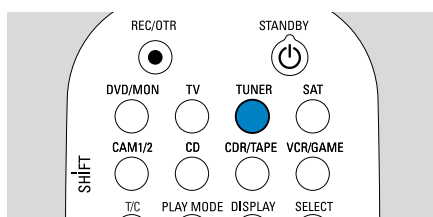

- 1 Press and hold TUNER for 1 second to select the radio tuner.

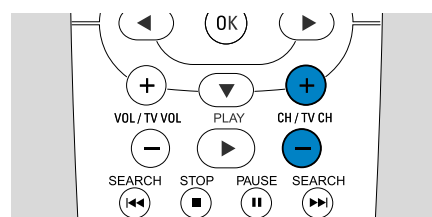

- 2 Press CH+ or CH- repeatedly to skip to a preset radio station.  
Or use 0-9 to enter the number of a preset radio station. To enter a preset number with two digits, press 0-9 twice within 2 seconds.

## Selecting a source

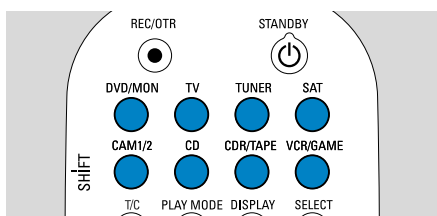

With the "source buttons" you select what you want to play and what to record.

Press and hold a source button for 1 second to select a source.

**DVD** selects the disc inserted into the DVD recorder system (DVD, DVD+RW, DVD+R, Video CD, SuperVideo CD, Audio CD, MP3-CD). Playback will start automatically or a menu/information screen will appear on the TV screen.

**MON** ("Monitor") shows the TV channels stored in the DVD recorder system. Press CH+ or CH- to select the TV channel which you wish to record.

**TV** plays the sound of your television set on the speakers of the DVD recorder system.

**SAT, CAM1/2, CD, CDR/TAPE, VCR/GAME** select connected equipment (satellite receiver, CD player or similar).

With **SAT, CAM1/2, VCR/GAME** select the video equipment from which you wish to record. E. g. To record a satellite programme, first select SAT, then press REC/OTR.

## Recording a TV programme



**1** Switch your TV set on. If necessary set the TV to the correct audio/video channel for the DVD recorder system. Such channels may be called AUX or AUXILIARY IN, AUDIO/VIDEO or AV IN, EXT1, EXT2 or EXTERNAL IN, etc. These channels are often near channel 00.

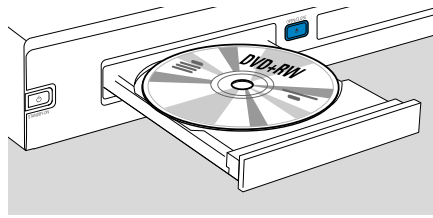

**2** Insert a DVD+RW or DVD+R disc on which you want to record into the tray.

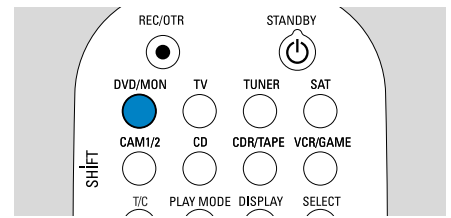

**3** Press DVD/MON to see the TV channel currently selected on the DVD recorder system.

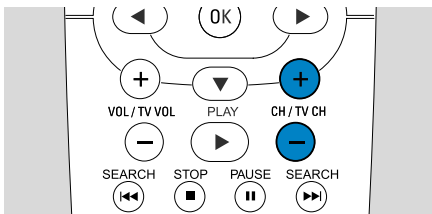

**4** Press CH+ or CH- to select the TV channel (programme number) which you wish to record.

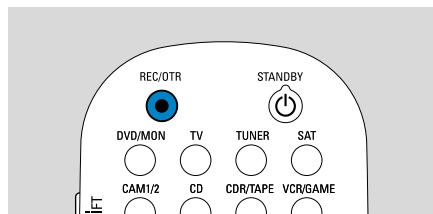

**5** Keep REC/OTR pressed until **SAFE RECD** is displayed on the DVD recorder system.  
→ Recording starts at the end of all existing recordings.

*Note for DVD+RWs: If you press REC/OTR briefly, the recording will start at the position where you stopped playback. Previous recordings may be overwritten.*

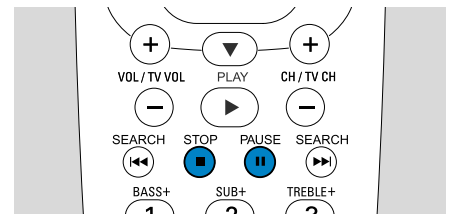

○ To interrupt recording press PAUSE **||**.  
○ To resume recording press PAUSE **||** again.  
**6** Press STOP **■** to stop recording.

## Selecting a recording mode

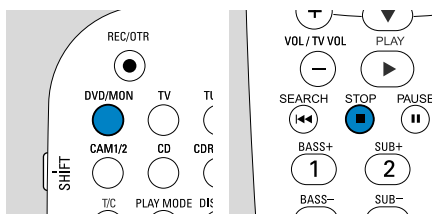

The recording mode determines the picture quality of a recording and the maximum time available for recording on a disc.

- 1 Press and hold DVD/MON for 1 second.
- 2 Press STOP **■** to stop playback or recording.

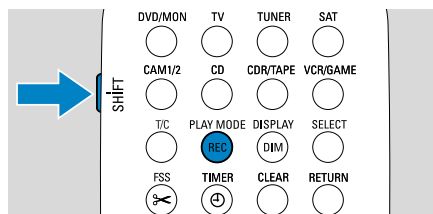

**3** While you press and hold SHIFT, press REC / PLAY MODE repeatedly to select the recording mode.

mode	quality	recording time
M1	better than DVD	1 hour
M2	DVD	2 hours
M2x	better than S-VHS	2½ hours
M3	S-VHS	3 hours
M4	better than VHS	4 hours
M6	VHS	6 hours
M8	VHS (longplay)	8 hours

