

User Manual	4
使用说明书	50

**Thank you for choosing Philips.**

**Need help fast?**

*Read your Quick-Use Guide and/or User Manual first for quick tips that make using your Philips product more enjoyable.*

*If you have read your instructions and still need assistance, you may access our online help at [www.philips.com/support](http://www.philips.com/support)*



**PHILIPS**

# Language Code

Abkhazian	6566	Inupiaq	7375	Pushto	8083
Afar	6565	Irish	7165	Russian	8285
Afrikaans	6570	Íslenska	7383	Quechua	8185
Amharic	6577	Italiano	7384	Raeto-Romance	8277
Arabic	6582	Ivrit	7269	Romanian	8279
Armenian	7289	Japanese	7465	Rundi	8278
Assamese	6583	Javanese	7486	Samoaan	8377
Avestan	6569	Kalaallisut	7576	Sango	8371
Aymara	6589	Kannada	7578	Sanskrit	8365
Azerhijani	6590	Kashmiri	7583	Sardinian	8367
Bahasa Melayu	7783	Kazakh	7575	Serbian	8382
Bashkir	6665	Kernewek	7587	Shona	8378
Belarusian	6669	Khmer	7577	Shqip	8381
Bengali	6678	Kinyarwanda	8287	Sindhi	8368
Bihari	6672	Kirghiz	7589	Sinhalese	8373
Bislama	6673	Komi	7586	Slovensky	8373
Bokmål, Norwegian	7866	Korean	7579	Slovenian	8376
Bosanski	6683	Kuanyama; Kwanyama	7574	Somali	8379
Brezhoneg	6682	Kurdish	7585	Sotho; Southern	8384
Bulgarian	6671	Lao	7679	South Ndebele	7882
Burmese	7789	Latina	7665	Sundanese	8385
Castellano, Español	6983	Latvian	7686	Suomi	7073
Catalán	6765	Letzeburgesch;	7666	Swahili	8387
Chamorro	6772	Limburgan; Limburger	7673	Swati	8383
Chechen	6769	Lingala	7678	Svenska	8386
Chewa; Chichewa; Nyanja	7889	Lithuanian	7684	Tagalog	8476
中文	9072	Luxembourgish;	7666	Tahitian	8489
Chuang; Zhuang	9065	Macedonian	7775	Tajik	8471
Church Slavik; Slavonic	6785	Malagasy	7771	Tamil	8465
Chuvash	6786	Magyar	7285	Tatar	8484
Corsican	6779	Malayalam	7776	Telugu	8469
Česky	6783	Maltese	7784	Thai	8472
Dansk	6865	Manx	7186	Tibetan	6679
Deutsch	6869	Maori	7773	Tigrinya	8473
Dzongkha	6890	Marathi	7782	Tonga (Tonga Islands)	8479
English	6978	Marshallese	7772	Tsonga	8483
Esperanto	6979	Moldavian	7779	Tswana	8478
Estonian	6984	Mongolian	7778	Türkçe	8482
Euskara	6985	Nauru	7865	Türkmen	8475
Ελληνικά	6976	Navaho; Navajo	7886	Twi	8487
Faroese	7079	Ndebele, North	7868	Uighur	8571
Français	7082	Ndebele, South	7882	Ukrainian	8575
Frysk	7089	Ndonga	7871	Urdu	8582
Fijian	7074	Nederlands	7876	Uzbek	8590
Gaelic; Scottish Gaelic	7168	Nepali	7869	Vietnamese	8673
Gallegan	7176	Norsk	7879	Volapuk	8679
Georgian	7565	Northern Sami	8369	Walloon	8765
Gikuyu; Kikuyu	7573	North Ndebele	7868	Welsh	6789
Guarani	7178	Norwegian Nynorsk;	7878	Wolof	8779
Gujarati	7185	Occitan; Provençal	7967	Xhosa	8872
Hausa	7265	Old Bulgarian; Old Slavonic	6785	Yiddish	8973
Herero	7290	Oriya	7982	Yoruba	8979
Hindi	7273	Oromo	7977	Zulu	9085
Hiri Motu	7279	Ossetian; Ossetic	7983		
Hrvatski	6779	Pali	8073		
Ido	7379	Panjabi	8065		
Interlingua (International)	7365	Persian	7065		
Interlingue	7365	Polski	8076		
Inuktitut	7385	Português	8084		

## LASER

Type	Semiconductor laser GaAlAs
Wave length	650~660 nm (DVD) 784~796 nm (CD)
Output Power	7 mW (DVD) 10 mW (VCD/CD)
Beam divergence	60 degree

English ..... 4

中文(简体) ..... 50

English

中文(简体)

Manufactured under license from Dolby Laboratories. “Dolby”, “Pro Logic” and the double-D symbol are trademarks of Dolby Laboratories.

Manufactured under license from Digital Theater Systems, Inc. U.S. Pat. Noís. 5,451,942; 5,956,674; 5,974,380; 5,978,762; 6,226,616; 6,487,535 and other U.S. and world-wide patents issued and pending. “DTS” and “DTS Digital Surround” are registered trademarks of Digital Theater Systems, Inc. Copyright 1996, 2003 Digital Inc. All Rights Reserved.

DivX®, DivX Certified, and associated logos are trademarks of DivX Networks, Inc and are used under license.



Microsoft, Windows Media, and the Windows logo are trademarks, or registered trademarks of Microsoft Corporation in the United States and/or other countries

## CAUTION

*Use of controls or adjustments or performance of procedures other than herein may result in hazardous radiation exposure or other unsafe operation.*



As an ENERGY STAR® partner; Philips has determined that this product meets the ENERGY STAR® guidelines for energy efficiency.

For Customer Use:

Read carefully the information located at the bottom of your DVD VIDEO player and enter below the Serial No. Retain this information for future reference.

Model No. DVD VIDEO HTS3500S  
Serial No. \_\_\_\_\_

‘CONSUMERS SHOULD NOTE THAT NOT ALL HIGH DEFINITION TELEVISION SETS ARE FULLY COMPATIBLE WITH THIS PRODUCT AND MAY CAUSE ARTIFACTS TO BE DISPLAYED IN THE PICTURE. IN CASE OF 525 OR 625 PROGRESSIVE SCAN PICTURE PROBLEMS, IT IS RECOMMENDED THAT THE USER SWITCH THE CONNECTION TO THE ‘STANDARD DEFINITION’ OUTPUT. IF THERE ARE QUESTIONS REGARDING OUR TV SET COMPATIBILITY WITH THIS MODEL 525p AND 625p DVD PLAYER, PLEASE CONTACT OUR CUSTOMER SERVICE CENTRE.’

# Contents

---

<b>Language Code</b> .....	2
----------------------------	---

---

## General Information

Supplied accessories .....	6
Cleaning discs .....	6
Setup .....	6

---

## Basic Connections

Step 1: Placing the speakers and subwoofer .....	7
Step 2: Connecting the speakers and subwoofer .....	8
Step 3: Connecting to TV .....	9
Option 1: Using S-Video socket .....	9
Option 2: Using Composite Video socket .....	9
Step 4: Connecting to a Progressive ScanTV (optional) .....	10
Step 5: Connecting FM/MW antennas ...	10
Step 6: Connecting the power cord ....	11

---

## Connections to External Devices

Connecting a VCR or Cable/Satellite Box .....	12
Viewing and listening to the playback .....	12
Using the VCR for recording DVD playback .....	12
Connecting digital audio equipment .....	13
Listening to the playback .....	13

---

<b>Remote Control</b> .....	14–15
-----------------------------	-------

---

<b>Main Unit</b> .....	16
------------------------	----

---

## Getting Started

Step 1: Inserting batteries into the remote control .....	17
Using the remote control to operate the system .....	17
Step 2: Switching on the DVD system ..	17
Switching to Eco Power standby mode .....	17
Step 3: Setting the TV .....	17
Setting up Progressive Scan feature (for Progressive Scan TV only) .....	18
Selecting the matching colour system .....	19
Setting the TV Display .....	19
Step 4: Setting language preferences ....	20
On-Screen Display (OSD) language .	20
Audio, Subtitle and Disc menu languages .....	20

---

## Disc Operations

Playable discs .....	21
Playing discs .....	21
Auto Eco Power standby mode .....	22
Basic playback controls .....	22
Selecting various repeat/shuffle functions .....	22
Other operations for video playback (DVD/VCD/SVCD) .....	23
Using the Disc Menu .....	23
Viewing playback information .....	23
Advancing by frame .....	24
Resuming playback from the last stopped point .....	24
Zooming in .....	24
Changing sound track language .....	24
Changing subtitle language (DVD only) .....	24
Preview Function (VCD only) .....	25
Playing MP3/Windows Media™ Audio/JPEG/MPEG-4 disc .....	26
Playing MP3 music and JPEG picture simultaneously .....	26

# Contents

Playing a picture disc (slide show) .....	27
Preview Function .....	27
Zoom picture .....	27
Rotating/Flipping the picture .....	27
Supported JPEG picture formats .....	27
Playing a Super Audio CD (SACD) .....	28
Playing a DivX disc .....	28
Playing a Karaoke disc .....	29
Microphone Setting .....	29

## DVD Setup Menu Options

Accessing General Setup Page .....	30
Locking/Unlocking the disc for viewing .....	30
Dimming system's display panel .....	30
Programming disc tracks (not for Picture CD/MP3/SACD) .....	31
OSD language .....	31
Screen Saver – turning on/off .....	32
DivX(R) VOD registration code .....	32
Accessing Audio Setup Page .....	33
Speakers Volume/Speakers Delay .....	33
Night mode – turning on/off .....	33
CD Upsampling .....	33
Accessing Video Setup Page .....	34
TV Type .....	34
TV Display .....	34
Progressive function-turning on/off .....	34
Picture Setting .....	35
Accessing Preference Setup Page .....	36
Audio, Subtitle, Disc Menu .....	36
Restricting playback by Parental Control .....	36–37
PBC (Playback Control) .....	37
MP3/JPEG menu– turning on/off .....	37
Changing the Password .....	38
Setting the DivX Subtitle font .....	38
Restoring to original settings .....	38

## Other Functions

Setting the Sleep timer .....	39
-------------------------------	----

## Tuner Operations

Tuning to radio stations .....	40
Presetting radio stations .....	40
Using the Plug and Play .....	40
Automatic presetting .....	41
Manual presetting .....	41
Selecting a preset radio station .....	41
Deleting a preset radio station .....	41
Changing tuning grid .....	41

## Sound and Volume Controls

Individual speakers volume adjustment .....	42
Selecting surround sound .....	43
Selecting digital sound effects .....	43
Volume Control .....	43

## Troubleshooting .....

## Glossary .....

## Specifications .....

# General Information

## Supplied accessories

Composite Video cable (Yellow)



Audio Cable

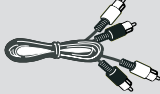

FM wire antenna



MW loop antenna

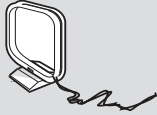

Remote control and two batteries (12nc: 3139 258 70101)

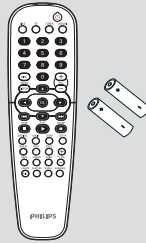

## Cleaning discs

To clean a disc, use a micro fibre cleaning cloth and wipe the disc from the center to the edge in a straight line.

### CAUTION!

Do not use solvents such as benzene, thinner, commercially available cleaners, or anti-static sprays intended for discs.

Since the optical unit (laser) of the DVD system operates at a higher power than regular DVD or CD players, cleaning CDs intended for DVD or CD players may damage the optical unit (laser). Therefore, refrain from using a cleaning CD.

## Setup

### Finding a suitable location

- Place the set on a flat, hard and stable surface. Do not place the set on a carpet.
- Do not position the set on top of other equipment that might heat it up (e.g., receiver or amplifier).
- Do not put anything under the set (e.g., CDs, magazines).

### Space for ventilation

- Place the apparatus in a location with adequate ventilation to prevent internal heat build up. Allow at least 10 cm (4.5") clearance from the rear and the top of the set and 5cm (2.3") from the left and right to prevent overheating.

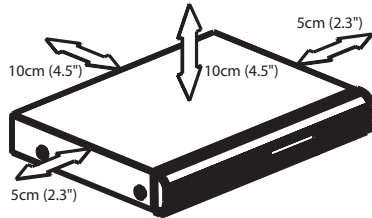

### Avoid high temperatures, moisture, water and dust

- Apparatus shall not be exposed to dripping or splashing.
- Do not place any sources of danger on the apparatus (e.g., liquid filled objects, lighted candles).

### Step 1: Placing the speakers and subwoofer

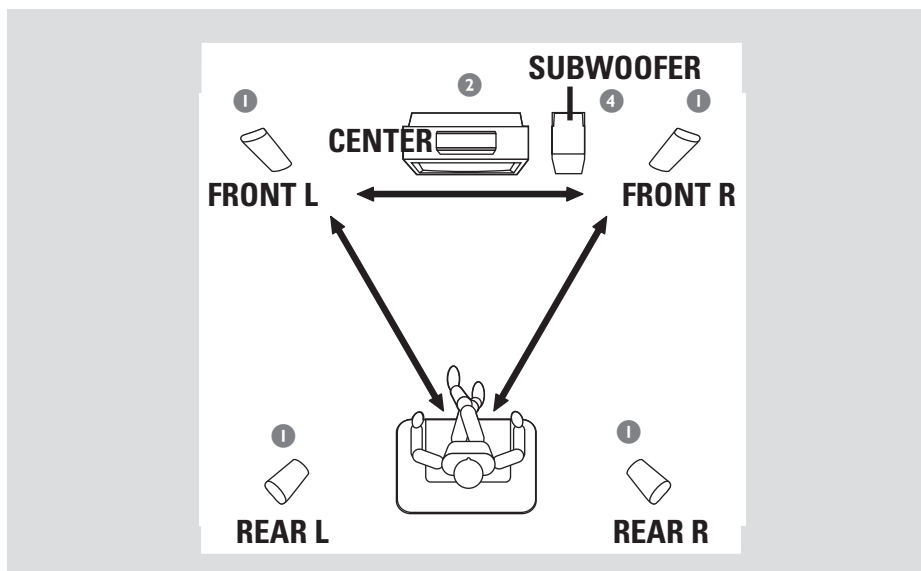

For best possible surround sound, all the speakers (except subwoofer) should be placed at the same distance from the listening position.

- 1 Place the front left and right speakers at equal distances from the TV and at an angle of approximately 45 degrees from the listening position.
- 2 Place the centre speaker above the TV or the DVD system so that the centre channel's sound is localised.
- 3 Place the rear speakers at normal listening ear level facing each other or hang on the wall.
- 4 Place the subwoofer on the floor near the TV.

#### Helpful Hints:

- To avoid magnetic interference, do not position the front speakers too close to your TV.
- Allow adequate ventilation around the DVD system.

## Basic Connections (continued)

English

### Step 2: Connecting the speakers and subwoofer

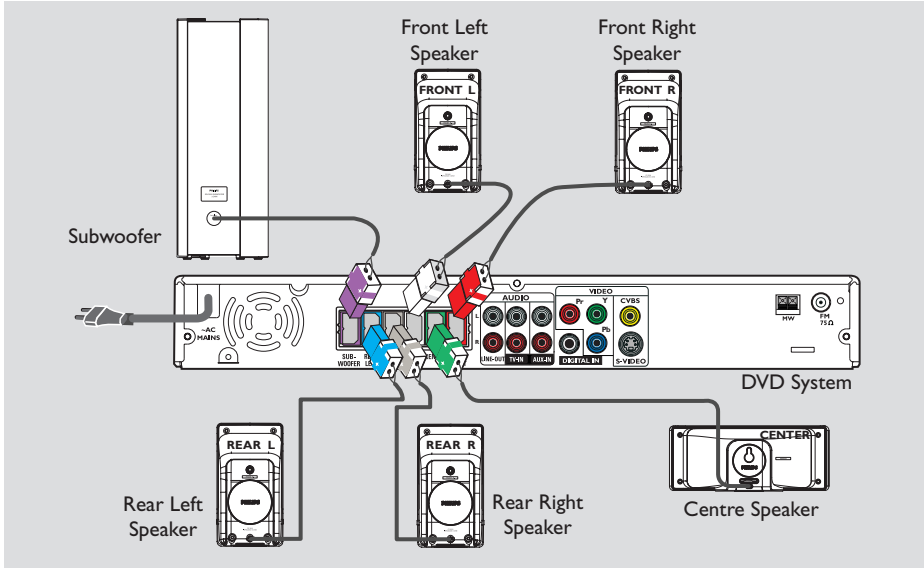

Connect the supplied speakers system using the fixed speaker cables by matching the colours of the sockets and speaker cables.

#### Helpful Hints:

- Ensure that the speaker cables are correctly connected. Improper connections may damage the system due to a short-circuit.
- To prevent unwanted noise, do not place the subwoofer too close to the DVD system, AC power adaptor, TV or any other radiation sources.



## Basic Connections (continued)

### Step 3: Connecting to TV

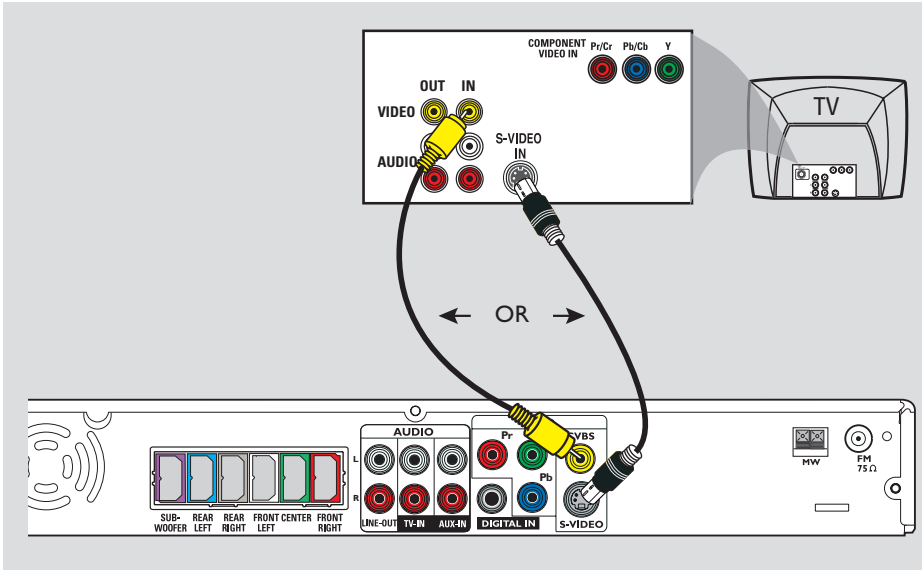

English

#### IMPORTANT!

- You only need to make one video connection from the following options, depending on the capabilities of your TV.
- Connect the DVD system directly to the TV.
- Proceed to page 17 for setting up the TV once you have completed the connections.

#### Helpful Hints:

- To hear the TV channels through this DVD system, use the audio cables (white/red - not supplied) to connect AUDIO-TV IN sockets to the corresponding AUDIO OUT sockets on the TV.

#### Option 1: Using S-Video socket

- Use an S-video cable (not supplied) to connect the DVD system's **S-VIDEO** socket to the S-Video input socket (or labelled as Y/C or S-VHS) on the TV.
- OR

#### Option 2: Using Composite Video socket

- Use the supplied composite video cable (yellow) to connect the DVD system's **CVBS** socket to the video input socket (or labelled as A/V In, Video In, Composite or Baseband) on the TV.

## Basic Connections (continued)

### Step 4: Connecting to a Progressive Scan TV (optional)

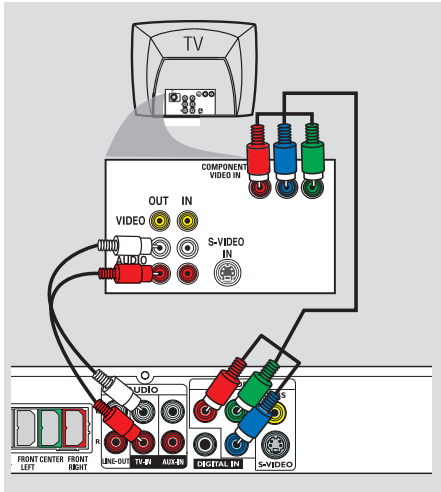

#### IMPORTANT!

The progressive scan video quality is only possible when using **Y Pb Pr** and a progressive scan TV is required.

- 1 Use the component video cables (red/blue/green - not supplied) to connect the DVD system's **Y Pb Pr** sockets to the corresponding component video input sockets (or labelled as Y Pb/Cb Pr/Cr or YUV) on the TV.
- 2 To hear the TV channels through this DVD system, use an audio cables (white/red - not supplied) to connect **AUDIO-TV IN** sockets to the corresponding AUDIO OUT sockets on the TV.
- 3 Proceed to page 18 for detailed Progressive Scan set up.

### Step 5: Connecting FM/MW antennas

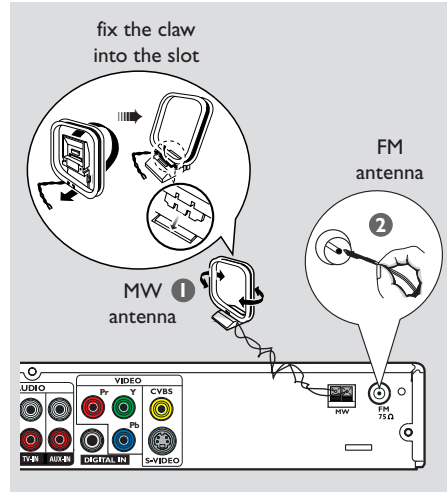

- 1 Connect the supplied MW loop antenna to the **MW** socket. Place the MW loop antenna on a shelf, or attach it to a stand or wall.
- 2 Connect the supplied FM antenna to the **FM** socket. Extend the FM antenna and fix its ends to the wall.

For better FM stereo reception, connect an external FM antenna (not supplied).

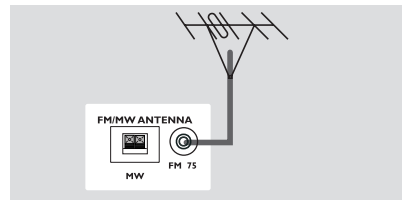

#### Helpful Hints:

- Adjust the position of the antennas for optimal reception.
- Position the antennas as far as possible from your TV, VCR or other radiation source to prevent unwanted interference.

### Step 6: Connecting the power cord

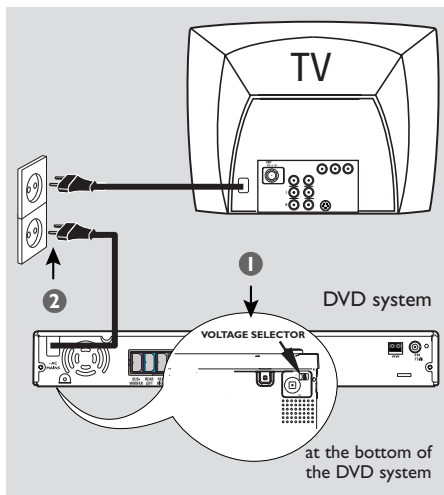

**After everything is connected properly,**

- 1 Set the **VOLTAGE SELECTOR** to the local power line voltage.
- 2 Plug in the AC power cord to the power outlet.

The red Eco Power LED on the DVD system will light up. Never make or change any connections with the power switched on.

*Helpful Hint:*

– Refer to the type plate on the rear or bottom of the system for identification and supply ratings.

# Connections to External Devices

## Connecting a VCR or Cable/Satellite Box

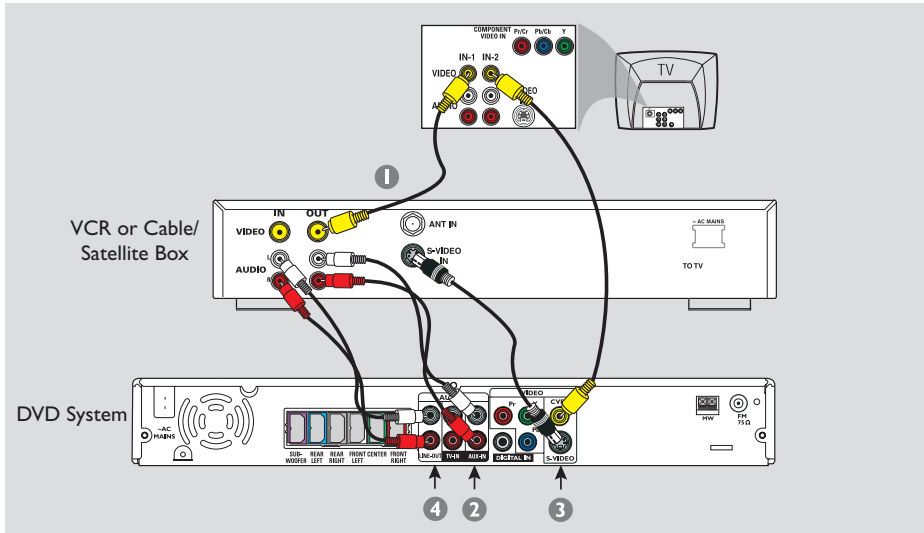

### Viewing and listening to the playback

- 1 Connect the VCR or Cable/Satellite Box to the TV as shown.
- 2 Connect the DVD system's **AUX IN (R/L)** sockets to the AUDIO OUT sockets on the VCR or cable/satellite box.

Press **AUX/DI** on the remote to select "AUX" in order to activate the input source.

### Using the VCR for recording DVD playback

Some DVDs are copy-protected. You cannot record or dub protected discs using a VCR.

- 3 Connect the DVD system's **S-VIDEO** socket to the S-VIDEO IN socket on the VCR.
- 4 Connect the DVD system's **LINE OUT (R/L)** sockets to the AUDIO IN sockets on the VCR.

This will allow you to make analogue stereo (two channel, right and left) recordings.

Before recording, set the volume level of the DVD system to level **1** and below, in order to enable sound output from the LINE OUT sockets.

**To view DVD playback while recording,** you must connect the DVD system to your TV using a CVBS (as shown above) connection.

## Connections to External Devices (continued)

### Connecting digital audio equipment

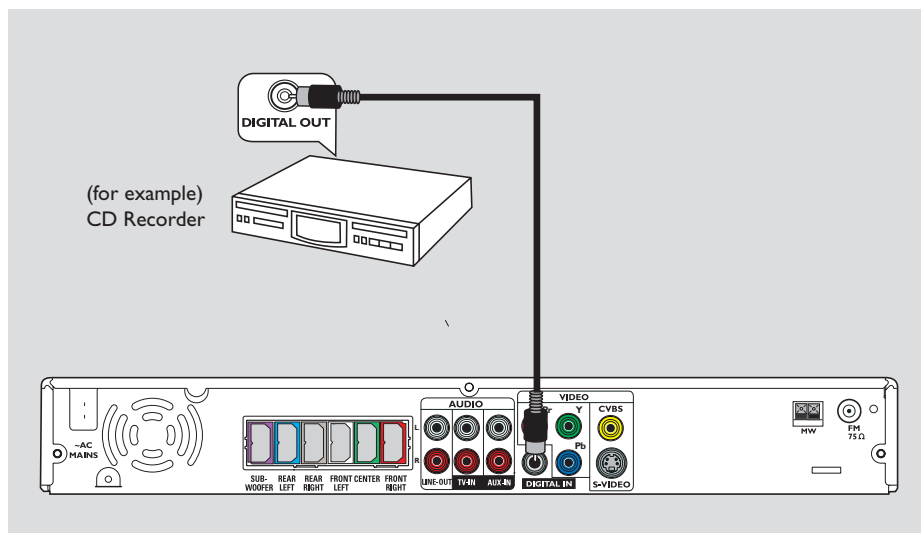

#### Listening to the playback

- Connect the DVD system's **DIGITAL IN** socket to the DIGITAL OUT socket on a digital audio device.

Press **AUX/DI** on the remote to select "DI" in order to activate the input source.

#### Helpful Hints:

- Some DVDs are copy-protected. You cannot record the disc through a VCR or digital recording device.
- You cannot hear or record the SACD or MP3-CD playback if you use the digital connection.
- For your playback through DIGITAL IN connection, set the digital output of that player to PCM format.
- Always refer to the user manual of the other equipment for complete connection and use details.

# Remote Control

English

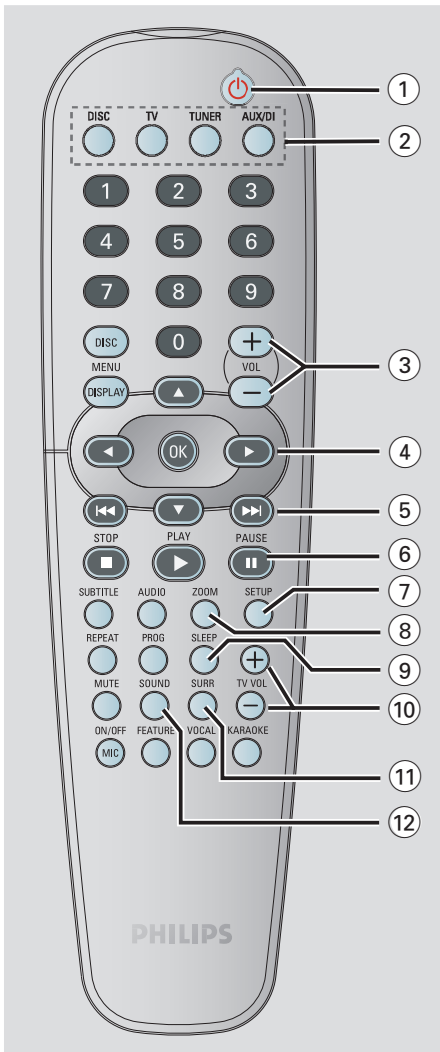

- ①
  - Switches to Eco Power standby mode, or turns on the system.
- ② **Source buttons**
  - DISC** : switches to DISC source mode.
  - TV**: switches to TV source mode. The sound from TV will come out through the DVD system.
  - TUNER**: toggles between FM and MW band.
  - AUX/DI**: toggles between AUX and DIGITAL IN external source mode.
- ③ **VOL + –**
  - Adjusts the volume level.
- ④
  - DISC: selects movement direction in the menu.
  - TUNER: use to start auto searching, use to tune the radio frequency up/down.
- ⑤
  - DISC: \*searches backward/forward or selects a track.
  - TUNER: selects a preset radio station.
- ⑥ **PAUSE II**
  - DISC: pauses playback.
- ⑦ **SETUP**
  - DISC: enters or exits system setup menu.
- ⑧ **ZOOM**
  - DISC: enlarges a picture on the TV screen.
- ⑨ **SLEEP**
  - Sets the sleep timer function.
- ⑩ **TVVOL + –**
  - Adjusts TV volume (Philips TV only).
- ⑪ **SURR**
  - Selects multichannel surround or stereo mode.
- ⑫ **SOUND**
  - Selects a predefined sound effect.

\* = Press and hold the button for more than two seconds.

## Remote Control (continued)

### 13 Numeric Keypad (0-9)

- DISC: enters a track/title number.
- TUNER: enters the preset radio station number.

### 14 DISC MENU

- DISC: enters or exits disc contents menu. For VCD, selects various preview function.

### 15 DISPLAY

- DISC: displays the current status or disc information.

### 16 OK

- Confirms a selection.

### 17 PLAY ►

- DISC: starts playback.

### 18 STOP ■

- Exits an operation.
- DISC: stops playback.
- DISC: holding down the button will open or close the disc tray.
- TUNER: \*erases a preset radio station.

### 19 AUDIO

- DISC: selects an audio language (DVD/ VCD) or an audio channel.

### 20 SUBTITLE

- DISC: selects a subtitle language.

### 21 REPEAT

- DISC: selects various repeat modes; switches repeat mode off.

### 22 PROG

- DISC: starts programming.
- TUNER: starts \*automatic/ manual preset programming.

### 23 MUTE

- Mutes or restores the volume.

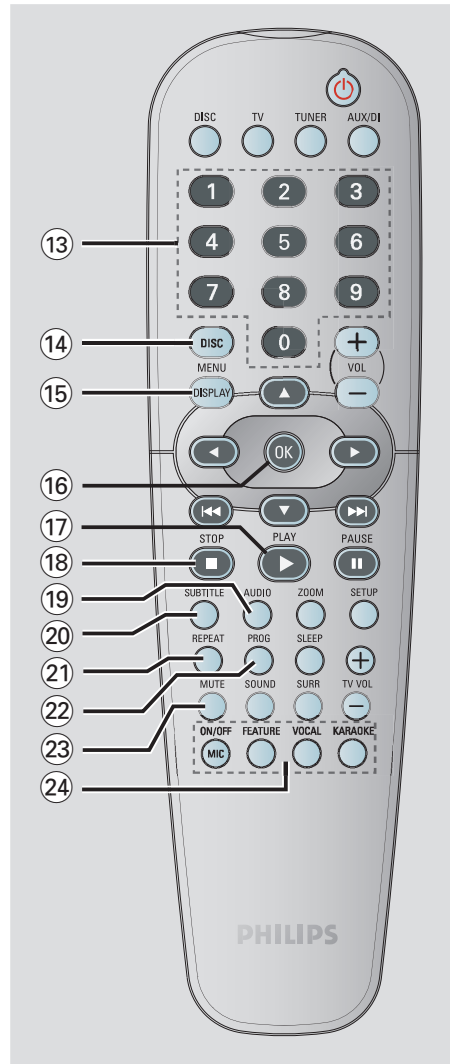

### 24 Karaoke buttons

**MIC ON/OFF:** turns on/off the microphone.

**FEATURE:** enters karaoke menu.

**VOCAL:** toggles between various audio mode options.

**KARAOKE:** enters microphone setup menu.

\* = Press and hold the button for more than two seconds.

# Main Unit

English

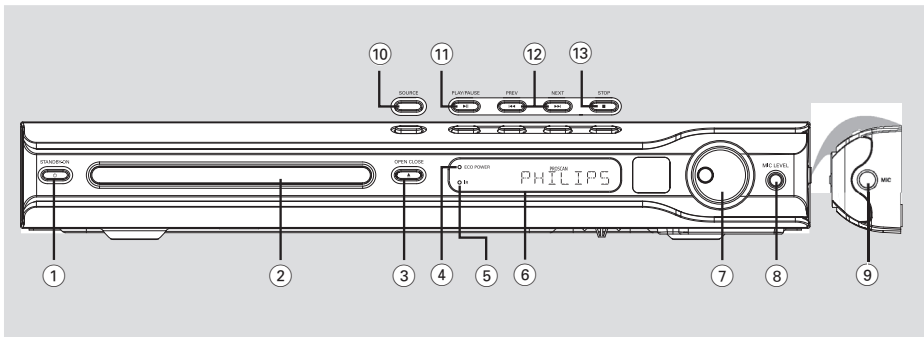

## ① STANDBY ON (⏻)

- Switches to Eco Power standby mode, or turns on the system.

## ② Disc tray

## ③ OPEN CLOSE ▲

- Opens/Closes the disc tray.

## ④ ECO POWER indicator

- Lights up when in Eco Power standby mode.

## ⑤ iR

- Point the remote control towards this sensor.

## ⑥ System display panel

## ⑦ VOLUME

- Adjusts the volume level.

## ⑧ MIC LEVEL

- Activates microphone level mode and use the VOLUME control to set the microphone volume level.

## ⑨ MIC

- For connecting the microphone socket.

## ⑩ SOURCE

- Selects the relevant active source mode: DISC, TUNER (FM/MW), TV or AUX/DI.

## ⑪ ► II PLAY/PAUSE

- DISC: starts/pauses playback.
- TUNER: starts preset radio station installation in Plug & Play mode.

## ⑫ ◀◀ PREV / NEXT ▶▶

- DISC: \*searches backward/forward or selects a track.
- TUNER: selects a preset radio station.

## ⑬ ■ STOP

- Exits an operation.
- DISC: stops playback.
- TUNER: hold down this button to erase the current preset radio station.



# Getting Started

## Step 1: Inserting batteries into the remote control

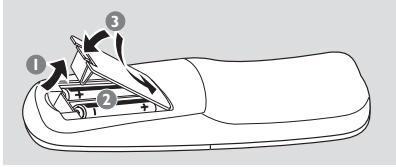

- 1 Open the battery compartment.
- 2 Insert two batteries type R06 or AA, following the indications (+ -) inside the compartment.
- 3 Close the cover.

### CAUTION!

- Remove batteries if they are exhausted or if the remote control is not to be used for a long time.
- Do not use old and new, or different types of batteries in combination.
- Batteries contain hazardous chemical substances, so they should be disposed of properly.

## Using the remote control to operate the system

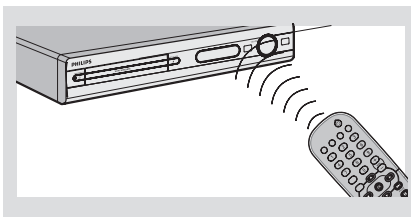

- 1 Aim the remote control directly at the remote sensor (iR) on the front panel.
- 2 Select the source you wish to control by pressing one of the source select buttons on the remote control (for example TV, TUNER).
- 3 Then select the desired function (for example ▶, |◀◀, ▶▶▶).

## Step 2: Switching on the DVD system

- Press the **SOURCE** control to select :  
DISC → FM → MW → TV → AUX  
→ DI → DISC ....

OR

Press **DISC**, **TV**, **TUNER** or **AUX/DI** on the remote.

## Switching to Eco Power standby mode

- Press **STANDBY ON** (⏻).  
→ The display screen will go blank.

## Step 3: Setting the TV

After connecting the DVD system to your TV, you have to switch the TV to the correct programme number for the input socket (e.g. 'EXT', '0', 'AV') in order to view the playback from the DVD system.

- 1 Press **SOURCE** control until "DISC" appears on the display panel.
- 2 Turn on the TV and set it to the correct video-in channel. You should see the blue DVD background screen on the TV.  
→ Usually this channel is between the lowest and highest channels and may be called FRONT, A/V IN, VIDEO. See your TV manual for more details.  
→ Or, you may go to channel 1 on your TV, then press the Channel down button repeatedly until you see the Video In channel.  
→ Or, the TV remote control may have a button or switch that chooses between different video modes.

# Getting Started (continued)

## Setting up Progressive Scan feature (for Progressive Scan TV only)

The progressive scan display twice the number of frames per seconds than interlaced scanning (ordinary normal TV system). With nearly double the number of lines, progressive scan offers higher picture resolution and quality.

### IMPORTANT!

**Before enabling the progressive scan feature, you must ensure :**

- 1) Your TV can accept progressive signals, a progressive scan TV is required.
- 2) You have connected the DVD system to your TV using Y Pb Pr (see page 10).

- 1 Turn off your TV progressive scan mode or turn on interlaced mode (refer to your TV user manual).
- 2 Press **DISC** on the remote to turn on the DVD system.
- 3 Turn on your TV and select the correct Video Input channel (see page 17).  
→ The blue DVD background screen will appear on the TV.
- 4 Press **SETUP** on the remote.
- 5 Press **▶** to select { Video Setup Page }.

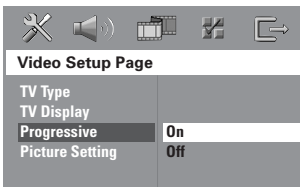

- 6 Select { **Progressive** } > { **On** }, then press **OK** to confirm.  
→ The below menu will appear on the TV.

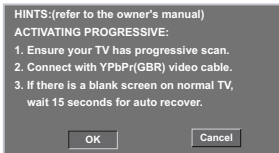

- 7 Press **◀** to highlight **OK** in the menu and press **OK** to confirm.

**There will be no picture on your TV at this state until you turn on the progressive scan mode on your TV.**

- 8 Turn on your TV progressive scan mode (refer to your TV user manual).  
→ The below menu will appear on the TV.

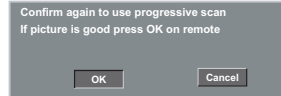

- 9 Press **◀** to highlight **OK** in the menu and press **OK** to confirm.  
→ The set up is complete now and you can start enjoy the high quality picture.

### If no picture:

- Wait for 15 seconds for auto recovery.  
OR
- 1 Deactivate Progressive Scan feature by pressing the **OPEN CLOSE ▲** on the DVD system to open the disc tray.
- 2 Press **◀** on the remote control.
- 3 Press **MUTE** on the remote.  
→ The blue DVD background screen will appear on the TV.

### Helpful Hint:

– There are some progressive scan TV and High-Definition TV sets that are not fully compatible with this DVD system, resulting in the unnatural picture when playing back a DVD VIDEO disc in the progressive scan mode. In such a case, turn off the progressive scan feature on both the DVD system and your TV set.

**TIPS:** The underlined option is the factory default setting.  
To return to the previous menu, press **◀**. To remove the menu, press **SETUP**.

## Selecting the matching colour system

The colour system of the DVD system, DVD and TV should match. Only then will it be possible to play a DVD on this system. Before changing the TV system, determine the colour system of your TV.

- 1 In disc mode, press **SETUP**.
- 2 Press **▶** repeatedly to select { Video Setup Page }.
- 3 Use **▲▼** keys to highlight { **TV Type** }, then press **▶**.

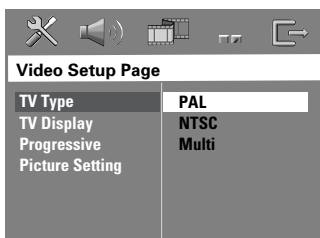

- 4 Use **▲▼** keys to highlight one of the options below:

### { PAL }

Select this if the connected TV has the PAL colour system. It will change the video signal of an NTSC disc and output it to PAL format.

### { NTSC }

Select this if the connected TV has the NTSC colour system. It will change the video signal of a PAL disc and output it to NTSC format.

### { Multi }

Select this if the connected TV is compatible with both NTSC and PAL (multi-system). The output format will be in accordance with the video signal of the disc.

- 5 Select a setting and press **OK**.  
 → Follow the instructions shown on the TV to confirm the selection (if any).  
 → If a blank/distorted TV screen appears, wait for 15 seconds for auto recovery.

## Setting the TV Display

Set the aspect ratio of the DVD system according to the TV you have connected. The format you select must be available on the disc. If it is not, the setting for TV display will not affect the picture during playback.

- 1 In disc mode, press **SETUP**.
- 2 Press **▶** repeatedly to select { Video Setup Page }.
- 3 Use **▲▼** keys to highlight { **TV Display** }, then press **▶**.

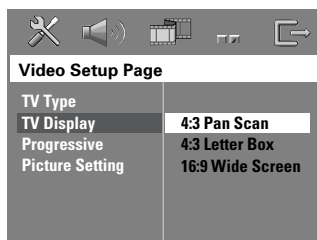

- 4 Use **▲▼** keys to highlight one of the options below:

### { 4:3 Pan Scan }

Select this if you have a conventional TV and want both sides of the picture to be trimmed or formatted to fit your TV screen.



### { 4:3 Letter Box }

Select this if you have a conventional TV. In this case, a wide picture with black bands on the upper and lower portions of the TV screen will be displayed.



### { 16:9 Wide Screen }

Select this if you have a wide-screen TV.



- 5 Select a setting and press **OK**.

**TIPS:** The underlined option is the factory default setting.  
 To return to the previous menu, press **◀**. To remove the menu, press **SETUP**.

# Getting Started (continued)

English

## Step 4: Setting language preferences

You can select your preferred language settings so that this DVD system will automatically switch to the language for you whenever you load a disc. If the language selected is not available on the disc, the disc's default language will be used instead.

The OSD (On-Screen Display) language for the system menu will remain as you set it, regardless of the default and optional disc languages.

### On-screen display (OSD) language

- 1 In disc mode, press **SETUP**.
- 2 Press **▶** to select { General Setup Page }.
- 3 Use **▲▼** keys to highlight { **OSD Language** }, then press **▶**.

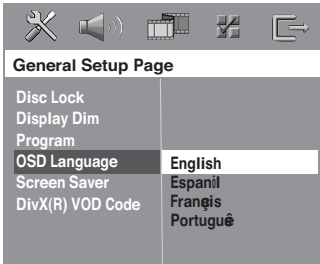

- 4 Use **▲▼** keys to select a language and press **OK** to confirm.

### Audio, Subtitle and Disc menu languages

- 1 Press **■** twice to stop playback (if any), then press **SETUP**.
- 2 Press **▶** repeatedly to select { Preference Page }.
- 3 Use **▲▼** keys to highlight one of the options below, then press **▶**.
  - { **Audio** } (disc's soundtrack)
  - { **Subtitle** } (disc's subtitles)
  - { **Disc Menu** } (disc's menu)

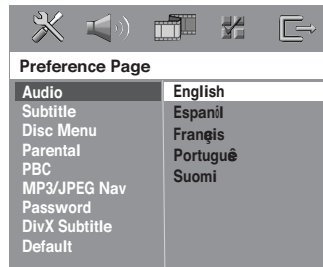

- 4 Use **▲▼** keys to select a language and press **OK** to confirm.

**If the language you want is not in the list, then select { Others }.**

Use the **numeric keypad (0-9)** on the remote to enter the 4-digit language code 'XXXX' (see page 2) and press **OK** to confirm.

- 5 Repeat steps 3~4 for other settings.

**TIPS:** The underlined option is the factory default setting. To return to the previous menu, press **◀**. To remove the menu, press **SETUP**.

## IMPORTANT!

- If the inhibit icon (Ø or X) appears on the TV screen when a button is pressed, it means the function is not available on the current disc or at the current time.
- DVD discs and players are designed with regional restrictions. Before playing a disc, make sure the disc is for the same zone as your player.
- Do not push on the disc tray or put any objects other than discs on the disc tray. Doing so may cause the disc player to malfunction.

## Region Codes

DVDs must be labelled for **ALL** regions or **Region 6** in order to play on this DVD system. You cannot play discs that are labelled for other regions.



### Helpful Hints:

- It may not be possible to play CD-R/RW or DVD-R/RW in all cases due to the type of disc or condition of the recording.
- If you are having trouble playing a certain disc, remove the disc and try a different one. Improperly formatted discs will not play on this DVD system.

## Playable discs



## Your DVD home theatre system will play:

- Digital Versatile Discs (DVDs)
- Video CDs (VCDs)
- Super Video CDs (SVCDs)
- Super Audio CDs (SACDs)
- Finalised DVD+Recordable[Rewritable] (DVD+R[W])
- Audio Compact Discs (CDs)
- MP3 discs, picture (Kodak, JPEG) files on CD-R(W).
  - JPEG/ISO 9660/UDF format
  - JPEG resolution support up to 3072 x 2048
  - Supported sampling frequencies : 32 kHz, 44.1 kHz, 48 kHz
  - Supported Bit-rates : 32~256 (kbps), variable bit rates
- Windows Media™ Audio discs
- MPEG-4 files on CD-R[W]:
  - Simple profile
  - Advanced simple profile (640-480)
- DivX disc on CD-R[W]/DVD+R[W]:
  - DivX 3.11, 4.x and 5.x
  - GMC (Global Motion Compensation) and QP (Quarter Pixel) not supported

## Playing discs

- 1 Press **SOURCE** control until “DISC” appears on the display panel (or press **DISC** on the remote).
- 2 Turn on the TV power and set to the correct Video In channel. (See page 17 “Setting the TV”).
  - You should see the blue DVD background screen on the TV.
- 3 Press **OPEN CLOSE** ▲ to open the disc tray and load a disc, then press the same button again to close the disc tray.
  - Make sure the disc label is facing up. For double-sided discs, load the side you want to play facing up.
- 4 Playback will start automatically.
  - If a disc menu shows on the TV, see page 23 “Using the Disc Menu”.
  - If the disc is locked by parental control, you must enter your six-digit password. (See pages 36~37).

**TIPS:** Some discs cannot be played on this DVD system due to the configuration and characteristics of the disc, or due to the condition of recording and authoring software that was used.

## Disc Operations (continued)

### Auto Eco Power standby mode

This is a power-saving feature, the system will automatically switch to Eco Power standby mode if you do not press any buttons within 30 minutes after a disc has stopped playing.

### Basic playback controls

#### Pausing playback

- During playback, press **▶II** (or **II** on the remote).  
→ To resume normal playback, press **▶II** (or **PLAY ▶** on the remote).

#### Selecting another track/chapter

- Press **|◀◀ / ▶▶|** or use the **numeric keypad (0-9)** to key in a track/chapter number.  
→ If repeat track mode is active, pressing **|◀◀ / ▶▶|** will replay the same track/chapter.

#### Searching backward/forward

- Press and hold **|◀◀ / ▶▶|**.  
To resume normal playback, press **▶II** (or **PLAY ▶** on the remote).  
→ While searching, pressing **|◀◀ / ▶▶|** again will decrease/increase the search speed.

#### Stopping playback

- Press **■**.

### Selecting various repeat/shuffle functions

- While playing a disc, press **REPEAT** on the remote repeatedly to choose a repeat play mode.

#### DVD

- RPT ONE (repeat chapter)
- RPT TT (repeat title)
- SHUFFLE (random play)
- RPT SHF (repeat random play)
- RPT OFF (exit repeat mode)

#### VCD/SVCD/CD

- RPT ONE (repeat track)
- RPT ALL (repeat disc)
- SHUFFLE (random play)
- RPT SHF (repeat random play)
- RPT OFF (exit repeat mode)

#### MP3/SACD/DivX/Windows Media™ Audio

- RPT ONE (repeat track)
- RPT ALL/FLD (repeat folder)
- SHUFFLE (random play)
- RPT OFF (exit repeat mode)

#### Helpful Hint:

– VCDs do not allow repeat playback as long as the PBC mode is switched on.

**TIPS:** The operating features described here might not be possible for certain discs. Always refer to the instructions supplied with the discs.

## Disc Operations (continued)

### Other operations for video playback (DVD/VCD/SVCD)

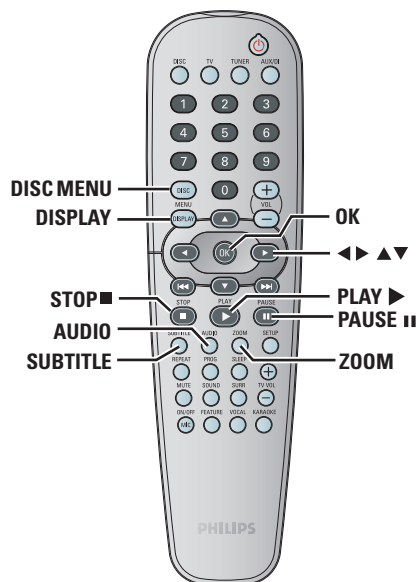

### Using the Disc Menu

A menu may appear on the TV screen once you load in the disc, depending on the disc format.

#### To select a playback feature or item

- Use **◀▶ ▲▼** keys or **numeric keypad (0-9)** on the remote, then press **OK** to start playback.

#### To access or remove the menu

- Press **DISC MENU** on the remote.

### Viewing playback information

It will show the disc playback information (for example, title or chapter number, elapsed playing time, audio/subtitle language), a number of operations can be done without interrupting disc playback.

- 1 During playback, press **DISPLAY**.  
→ A list of available disc information appears on the TV screen.

Menu ▶	
Title	02/02
Chapter	02/14
Audio	5.1CH
Subtitle	Off ▼
Bitrate	■■■■■■■■■■
Title Elapsed 0:29:17	

Menu ▶	
Track	01/02
Disc Time	0:49:17
Track Time	0:03:43
Repeat	Off ▼
Time Disp.	Total Elapsed
Bitrate	■■■■■■■■■■
Total Elapsed 0:29:17	

- 2 Press **▲▼** to view the information and press **OK** to access.
- 3 Use the **numeric keypad (0-9)** to input the number/time or use **▲▼** keys to make the selection, then press **OK** to confirm.  
→ Playback will change to the chosen time or to the selected title/chapter/track.

**TIPS:** The operating features described here might not be possible for certain discs. Always refer to the instructions supplied with the discs.

## Disc Operations (continued)

### Advancing by frame

- 1 During playback, press **II** on the remote.  
→ Play will pause and sound will be muted.
- 2 Press **II** repeatedly to view the next picture frame.
- 3 To resume normal playback, press **PLAY ►**.

### Resuming playback from the last stopped point

This DVD system able to resume disc playback from its last stopped point (only possible for the last 10 discs that recorded without a file/folder menu).

- 1 Load one of the last played 10 discs.
- 2 While "LOADING" appears on the display panel, press **PLAY ►** (or **►II**) to start playback from the last stop point.

#### To cancel the resume mode

- In stop mode, press **■** again.

### Zooming in

This function allows you to enlarge the picture on the TV screen and to pan through the enlarged picture.

- 1 During playback, press **ZOOM** repeatedly to select a different zoom factor.  
→ Use **◀▶ ▲ ▼** keys to move through the zoomed image.  
→ Playback will continue.
- 2 Press **ZOOM** repeatedly to return to the original size.

### Changing sound track language

This operation works only on DVDs with multiple soundtrack languages, you can change the language you want while playing a DVD.

- Press **AUDIO** repeatedly to select the available audio languages.

#### For VCD - changing the audio channel

- Press **AUDIO** repeatedly to select the available audio channels provided by the disc (STEREO, MONO LEFT, MONO RIGHT or MIX MONO).

### Changing subtitle language (DVD only)

This operation works only on DVDs with multiple subtitle languages, you can change the language you want while playing a DVD.

- Press **SUBTITLE** repeatedly to select different subtitle languages.

**TIPS:** The operating features described here might not be possible for certain discs. Always refer to the instructions supplied with the discs.



## Disc Operations (continued)

### Preview Function (VCD only)

- 1 Press **DISC MENU**.
- 2 Use **▲▼** keys to highlight { **Track Digest** }, { **Disc Interval** } or { **Track Interval** }.
- 3 Press **OK** to open one option.

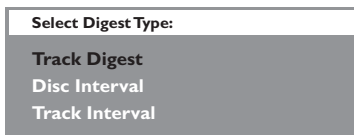

#### { **Track Digest** }

This function will minimise the picture of every track in order to display every six of these tracks on the screen to help you know the content of every track on the disc.

#### { **Disc Interval** }

This function is used to divide a disc into six parts by regular intervals and display them on one page to preview the whole disc.

#### { **Track Interval** }

This function is used to divide a single track into six parts by regular intervals and display them on one page to help you preview the selected track.

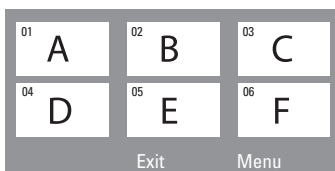

(example for 6 thumbnail pictures display)

- 4 Use **◀▶▲▼** keys to select a track.
- 5 Press **|◀◀ / ▶▶|** to open the previous or next page.
- 6 Press **OK** to confirm.

#### To quit preview function

- Use **◀▶▲▼** keys to highlight { **Exit** } and press **OK** to confirm.

#### To return to preview menu

- Use **◀▶▲▼** keys to highlight { **Menu** } and press **OK** to confirm.

**TIPS:** The operating features described here might not be possible for certain discs. Always refer to the instructions supplied with the discs.

## Disc Operations (continued)

### Playing an MP3/Windows Media™ Audio/JPEG/MPEG-4 disc

This DVD system can playback Windows Media™ Audio, MPEG-4, MP3, JPEG, VCD & SVCD files on a personally recorded CD-R/RW disc or commercial CD.

#### IMPORTANT!

You have to turn on your TV and set to the correct Video In channel. (See page 17 “Setting the TV”).

- 1 Load a disc.  
→ The disc reading time may exceed 30 seconds due to the complexity of the directory/file configuration.  
→ The disc menu appears on the TV screen.

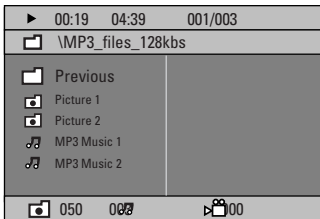

- 2 If the disc main menu contains various folders, use ▲▼ keys to select a desired folder and press **OK** to open the folder.
- 3 Use ▲▼ keys to select a track/file and press **OK** to start playback.  
→ Playback will start from the selected file and continue to the end of the folder.

During playback, you can;

- Press **◀◀ / ▶▶** to select another track/file in the current folder.
- Press **◀ / ▶** to fast reverse/forward search a music track.
- To select another folder from the current disc, press **▲** to return to the root menu, then use **▲▼** keys to make your selection and press **OK** to confirm.

**TIPS:** Some discs cannot be played on this DVD system due to the configuration and characteristics of the disc, or due to the condition of recording and authoring software that was used.

- Press **REPEAT** continuously to access various play mode.
- Press **II** to pause or **PLAY ▶** to resume playback.

### Playing MP3 music and JPEG picture simultaneously

- 1 Load a MP3 disc that contains music and pictures.  
→ The disc menu appears on the TV screen.
- 2 Select an MP3 track and press **▶II** (or **PLAY ▶** on the remote) to start playback.
- 3 During MP3 music playback, use **◀▶▲▼** keys to select a picture folder from the disc menu and press **▶II** (or **PLAY ▶**).  
→ The picture files will be played back until the end of the folder.
- 4 To quit simultaneous playback, press **DISC MENU** and followed by **■**.

#### Helpful Hints:

- It may not be possible to play certain MP3/JPEG/DivX/MPEG-4 disc due to the configuration and characteristics of the disc or condition of the recording.
- It is normal to experience an occasional “skip” while listening to your MP3 disc.
- It is normal to experience an occasional pixelation during MPEG-4/DivX playback due to poor clarity of digital contents during internet downloading.
- For multi-session discs with different formats, only the first session will be available.

## Disc Operations (continued)

### Playing a picture disc (slide show)

#### IMPORTANT!

You have to turn on your TV and set to the correct Video In channel. (See page 17 "Setting the TV").

- Load a Picture disc (Kodak Picture CD, JPEG).
  - For a Kodak disc, the slide show will begin automatically.
  - For a JPEG disc, the picture menu will appear on the TV screen. Press **▶II** (or **PLAY ▶**) to start the slide-show playback.

#### Preview Function

This function shows the content of the current folder or the whole disc.

- ① During playback, press **■**.
  - 12 thumbnail pictures will appear on the TV screen.



- ② Press **|◀◀ / ▶▶|** to display the other pictures on the previous/next page.
- ③ Use **◀▶ ▲ ▼** keys to highlight one of the picture and press **OK** to start playback.
- ④ Press **DISC MENU** to return to Picture CD menu.

#### Zoom picture

- ① During playback, press **ZOOM** repeatedly to select different zoom factor.
- ② Use **◀▶ ▲ ▼** keys to move through the zoomed image.

#### Rotating/Flipping the picture

- During playback, use **◀▶ ▲ ▼** keys to rotate/flip the picture on the TV screen.
  - ▲ : flip the picture vertically
  - ▼ : flip the picture horizontally
  - ◀ : rotate the picture anti-clockwise
  - ▶ : rotate the picture clockwise

#### Supported JPEG picture formats

##### File format:

- The file extension has to be **\*.JPG** and not **\*.JPEG**.
- It can only display DCF-standard still pictures or JPEG pictures e.g. TIFF. It cannot play back moving pictures, Motion JPEG, and other formats, or pictures in formats other than JPEG, or pictures associated with sound.
- It may require longer time for the DVD system to display the disc content on the TV due to the large number of songs/pictures compiled into one disc.

**TIPS:** Some discs cannot be played on this DVD system due to the configuration and characteristics of the disc, or due to the condition of recording and authoring software that was used.

## Disc Operations (continued)

### Playing a Super Audio CD (SACD)

There are three types of SACD discs : single layer, double layer or hybrid discs. The hybrid disc contains both Super Audio CD and standard audio CD layers, only the SACD layer can be played back on this DVD system.

- ① Load a SACD.  
→ The disc menu appears on the TV screen.
- ② Playback will start automatically.  
→ If the SACD consists of multi-channel and stereo tracks, multi-channel tracks will have the priority for playback.  
→ To playback stereo tracks, use ▲▼ keys to make your selection from the disc menu, then press **PLAY ►** (or **►II**).
- During playback, pressing ◀ / ▶ will perform fast reverse/forward search.

#### Helpful Hint

– It is not possible to programme SACD tracks.

### Playing a DivX disc

This DVD system supports the playback of DivX movie which you download from your computer onto a CD-R/RW (see page 32 for more information).

- ① Load a DivX disc.
- ② If the DivX movie contains external subtitles, the subtitle menu will appear on the TV for your selection.
- In this case, pressing **SUBTITLE** on the remote control will turn on or off the subtitle display.
- ③ Press **►II** (or **PLAY ►**) to start playback.
- If multilingual subtitles are embedded on the DivX disc, you can press **SUBTITLE** to change the subtitle language while playing.
- During playback, pressing ◀ / ▶ will perform fast reverse/forward search.

#### Helpful Hints:

- Subtitle files with the following filename extensions (.srt, .smi, .sub, .ssa, .ass) are supported but do not appear on the file navigation menu.
- The subtitle filename has to be the same as the filename of the movie.
- The subtitle can only be displayed up to maximum of 45 characters.

**TIPS:** Some discs cannot be played on this DVD system due to the configuration and characteristics of the disc, or due to the condition of recording and authoring software that was used.

## Disc Operations (continued)

### Playing a Karaoke disc

#### IMPORTANT!

You have to turn on your TV and set to the correct Video In channel. (See page 17 "Setting the TV").

- 1 Connect a microphone (not supplied) to the **MIC** socket on the side panel of the DVD main unit (as shown below).

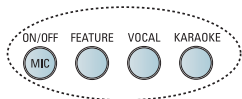
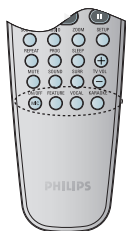
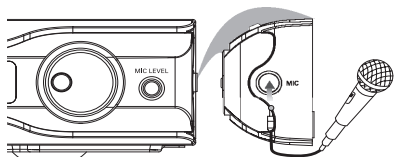

- 2 Load a karaoke disc.  
→ If the disc menu appears, use ▲▼ keys to make your selection and press **OK** to start playback.
- 3 To turn off the vocal or change the sound channel of a karaoke disc, press **VOCAL** on the remote repeatedly to toggle between various audio modes.
- 4 Press **MIC ON/OFF** on the remote to turn on the microphone and start enjoying the karaoke.
- While singing, you can set the microphone volume level by pressing the **MIC LEVEL** on the front panel and followed by adjusting the Volume control.

### Microphone Setting

- 1 Press **KARAOKE** on the remote to access 'Microphone Setup' page.

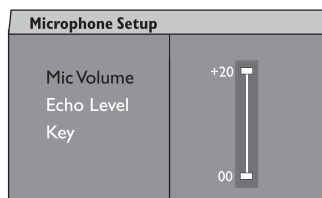

- 2 In 'Microphone Setup' page, use ▲▼ keys to select the option for microphone settings and press **OK** to confirm.

#### { Mic Volume }

– Use ▲▼ keys to set the microphone volume level (00 ~ +20). Choose '00' for minimum microphone volume setting.

#### { Echo Level }

– Use ▲▼ keys to set the Echo Level (00 ~ +20). Choose '00' for minimum echo level setting.

#### { Key }

– Use ▲▼ keys to set the pitch level (-10~ +10) that matching your voice. Select '-10' for lowest possible tone and '+10' for highest tone. To return to original tone, select '00'.

**TIPS:** Some discs cannot be played on this DVD system due to the configuration and characteristics of the disc, or due to the condition of recording and authoring software that was used.

# DVD Setup Menu Options

This DVD system setup is carried out via the TV, enabling you to customise the DVD system to suit your particular requirements.

## Accessing General Setup Page

- 1 Press **DISC** and followed by **SETUP** on the remote.
- 2 Use **◀▶** keys to select 'General Setup Page'.
- 3 Press **OK** to confirm.

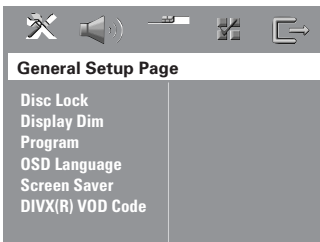

## Locking/Unlocking the disc for viewing

Not all discs are rated or coded by the disc maker. You can prevent a specific disc from playing by locking the disc. Up to 40 discs can be locked.

- 1 In 'General Setup Page', use **▲▼** keys to highlight { **Disc Lock** }, then press **▶**.

{ **Lock** }

Select this to block the playback of the current disc. Subsequent access to a locked disc requires six-digit password. The default password is '136900' (see page 38 "Changing the password").

{ **Unlock** }

Select this to unlock the disc and allow future playback.

- 2 Use **▲▼** keys to select a setting and press **OK** to confirm.

## Dimming system's display panel

You can select different levels of brightness for the DVD system display screen.

- 1 In 'General Setup Page', use **▲▼** keys to highlight { **Display Dim** }, then press **▶**.

{ **100%** }

Select this for full brightness.

{ **70%** }

Select this for medium brightness.

{ **40%** }

Select this for the dimmest display.

- 2 Use **▲▼** keys to select a setting and press **OK** to confirm.

**TIPS:** The underlined option is the factory default setting.  
To return to the previous menu, press **◀**. To remove the menu, press **SETUP**.

## DVD Setup Menu Options (continued)

### Programming disc tracks (not for Picture CD/MP3/SACD)

You can play the contents of the disc in the order you want by programming the playing order of the tracks. Up to 20 tracks can be stored.

- 1 Press **PROG** on the remote.  
OR  
In 'General Setup Page', use **▲▼** keys to highlight { **Program** }, then press **▶** to select { **Input Menu** }.
- 2 Press **OK** to confirm.

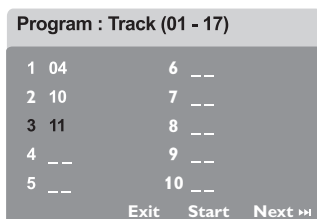

### To programme your favourite tracks/ chapter

- 3 Use the **numeric keypad (0-9)** to enter a valid track/chapter number.
- 4 Use **◀▶▲▼** keys to move the cursor to the next position.  
→ If the total programme tracks are more than ten, press **▶▶** to open the next page and proceed with programming or,  
→ Use **◀▶▲▼** keys to highlight { **Next** } on the programme menu, then press **OK**.
- 5 Repeat steps 3~4 to input another track/chapter number.

### If you want to remove a track

- 6 Use **◀▶▲▼** keys to move the cursor to the track you want to remove.
- 7 Press **OK** to remove this track from the programme menu.

### To start programme playback

- 8 Use **◀▶▲▼** keys to highlight { **Start** } on the programme menu, then press **OK**.  
→ Playback will start with the selected tracks under the programmed sequence.

### To exit programme playback

- 9 Use **◀▶▲▼** keys to highlight { **Exit** } on the programme menu, then press **OK**.

### OSD Language

This menu contains various language options for the language displayed on the screen. For details, see page 20.

**TIPS:** The underlined option is the factory default setting.  
To return to the previous menu, press **◀**. To remove the menu, press **SETUP**.

## DVD Setup Menu Options (continued)

### Screen Saver - turning on/off

The screen saver will help to prevent your TV display device from getting damaged.

- 1 In 'General Setup Page', use ▲▼ keys to highlight { **Screen Saver** }, then press ►.

{ **On** }

Select this if you wish to turn off the TV screen when play is stopped or paused for more than 15 minutes.

{ **Off** }

Select this to disable the screen saver function.

- 2 Use ▲▼ keys to select a setting and press **OK** to confirm.

### DivX® VOD registration code

Philips provide you the DivX® VOD (Video On Demand) registration code that allows you to rent and purchase videos using the DivX® VOD service. For more information, visit us at [www.divx.com/vod](http://www.divx.com/vod).

- 1 In 'General Setup Page', use ▲▼ keys to highlight { **DIVX(R) VOD Code** }, then press ►.  
→ The registration code will appear.
- 2 Press **OK** to exit.
- 3 Use the registration code to purchase or rent the videos from DivX® VOD service at [www.divx.com/vod](http://www.divx.com/vod). Follow the instructions and download the video from your computer onto a CD-R/RW for playback on this DVD system.

*Helpful Hint:*

– All the downloaded videos from DivX® VOD can only be played back on this DVD system.

**TIPS:** The underlined option is the factory default setting.  
To return to the previous menu, press ◀. To remove the menu, press **SETUP**.



# DVD Setup Menu Options (continued)

## Accessing Audio Setup Page

- 1 Press **DISC** and followed by **SETUP** on the remote.
- 2 Use **◀▶** keys to select 'Audio Setup Page'.
- 3 Press **OK** to confirm.

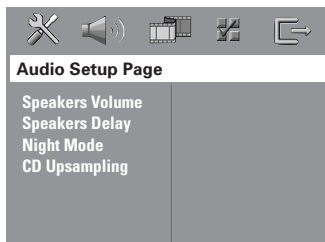

## Speakers Volume/Speakers Delay

These menus contain speaker setup options that allow you to adjust the individual speakers volume and distance. For details, see page 42.

## Night Mode - turning on/off

When the night mode is activated, the high volume outputs are softened and low volume outputs are brought upward to an audible level. It is useful for watching action movies without disturbing others at night.

- 1 In 'Audio Setup Page', use **▲▼** keys to highlight { **Night Mode** }, then press **▶**.  
**{ On }**  
Select this to level out the volume.  
**{ Off }**  
Select this when you want to enjoy the surround sound with its full dynamic range.
- 2 Use **▲▼** keys to select a setting and press **OK** to confirm.

## CD Upsampling

This feature allows you to convert your music CD to a higher sampling rate using sophisticated digital signal processing for better sound quality.

**Make sure that the DVD system is in Stereo mode in order to access the CD upsampling option.**

- 1 In 'Audio Setup Page', use **▲▼** keys to highlight { **CD Upsampling** }, then press **▶**.  
**{ Off }**  
Select this to disable CD-upsampling.  
**{ 88.2 kHz (X2) }**  
Select this to convert the sampling rate of the CDs twice higher than the original.
- 2 Use **▲▼** keys to select a setting and press **OK** to confirm.

*Helpful Hint:*

– If you press **SURR** button on the remote control to select "Multi-Channel" mode, it will disable the CD upsampling feature.

**TIPS:** The underlined option is the factory default setting.  
To return to the previous menu, press **◀**. To remove the menu, press **SETUP**.

# DVD Setup Menu Options (continued)

## Accessing Video Setup Page

- 1 Press **DISC** and followed by **SETUP** on the remote.
- 2 Use **◀▶** keys to select 'Video Setup Page'.
- 3 Press **OK** to confirm.

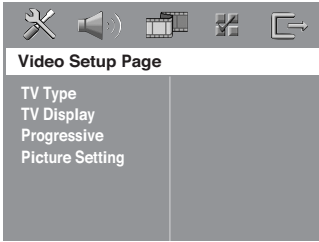

### TV Type

This menu contains the options for selecting the colour system that matches the connected TV. For details, see page 19.

### TV Display

This menu contains the options for setting the aspect ratio of the DVD system according to the connected TV. For details, see page 19.

## Progressive function - turning on/off

In the progressive scan mode, you can enjoy the high quality picture with less flickers. It only works when you have connected the DVD system's Y Pb Pr sockets to your TV that supports the progressive video input. Otherwise, the image may not appear or will be distorted. For proper progressive scan set up, see page 18.

- 1 In 'Video Setup Page', use **▲▼** keys to highlight { **Progressive** }, then press **▶**.  
{ **Off** }  
Select this to disable progressive scan function.  
{ **On** }  
Select this to enable progressive scan function.
- 2 Use **▲▼** keys to select a setting and press **OK** to confirm.  
→ Follow the instructions shown on the TV to confirm the selection (if any).  
→ If a blank/distorted TV screen appears, wait for 15 seconds for auto recovery.

**TIPS:** The underlined option is the factory default setting.  
To return to the previous menu, press **◀**. To remove the menu, press **SETUP**.

## DVD Setup Menu Options (continued)

### Picture Setting

This DVD system provides three predefined sets of picture colour settings and one personal setting which you can define yourself.

- In 'Video Setup Page', use ▲▼ keys to highlight { **Picture Setting** }, then press ►.
  - { **Standard** }
  - Select this for original colour setting.
  - { **Bright** }
  - Select this for vibrant colour setting.
  - { **Soft** }
  - Select this for warm colour setting.
  - { **Personal** }
  - Select this to personalise your picture colour by adjusting the brightness, contrast, tint and colour (saturation).
- Use ▲▼ keys to select a setting and press **OK** to confirm.
- If you select { **Personal** }, then proceed to steps 4~7.  
→ The 'Personal picture setup' menu appears.

Personal Picture Setup	
Brightness	0
Contrast	0
Tint	0
Color	0

- Use ▲▼ keys to highlight one of the following options.
  - { **Brightness** }
  - Increase this value to brighten the picture colour or vice versa. Choose zero (0) for the average setting.
  - { **Contrast** }
  - Increase this value to sharpen the picture colour or vice versa. Choose zero (0) to balance the contrast.
  - { **Tint** }
  - Increase or decrease this value to change the colour phase of the picture. Choose zero (0) for the average setting.
  - { **Color** }
  - Increase this value to enhance the picture colour or vice versa. Choose zero (0) to balance the colour.
- Use ◀▶ keys to adjust the setting that best suit your personal preference.
- Repeat steps 4~5 to adjust other settings.
- Press **OK** to confirm.

**TIPS:** The underlined option is the factory default setting.  
To return to the previous menu, press ◀. To remove the menu, press **SETUP**.

# DVD Setup Menu Options (continued)

English

## Accessing Preference Setup Page

- 1 Press **■** twice to stop playback (if any), then press **SETUP**.
- 2 Use **◀▶** keys to select the 'Preference Page'.
- 3 Press **OK** to confirm.

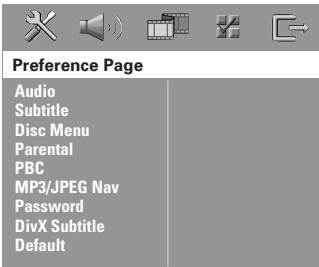

## Audio, Subtitle, Disc Menu

These menus contain various language options for audio, subtitle and disc menu that may be recorded on the DVD. For details, see page 20.

## Restricting playback by Parental Control

Some DVDs may have a parental level assigned to the complete disc or to certain scenes on the disc. This feature lets you set a playback limitation level. The rating levels are from 1 to 8 and are country dependent. You can prohibit the playback of certain discs that are not suitable for your children, or have certain discs played with alternative scenes.

- 1 In 'Preference Page', use **▲▼** keys to highlight { **Parental** }, then press **▶**.

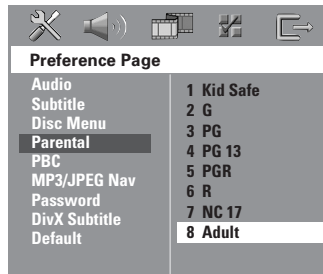

- 2 Use **▲▼** keys to highlight a rating level for the disc inserted and press **OK**.
- 3 Use the **numeric keypad (0-9)** to enter the six-digit password (see page 38 "Changing the password").  
→ DVDs that are rated above the level you selected will not play unless you enter your six-digit password.

**TIPS:** The underlined option is the factory default setting. To return to the previous menu, press **◀**. To remove the menu, press **SETUP**.

# DVD Setup Menu Options (continued)

## Rating explanations

### 1 Kid Safe – 2 G

– General Audience; recommended as acceptable for viewers of all ages.

### 3 PG

– Parental Guidance suggested.

### 4 PG13

– Material is unsuitable for children under the age of 13.

### 5 PGR – 6 R

– Parental Guidance - Restricted; recommended that parents restrict children under the age of 17 from viewing or allow them to view only when supervised by a parent or adult guardian.

### 7 NC-17

– No children under the age of 17; not recommended viewing for children under the age of 17.

### 8 Adult

– Mature material; should be viewed only by adults due to graphic sexual material, violence or language.

#### Helpful Hints:

– VCD, SVCD, CD have no level indication, so parental control has no effect on these type of discs. This also applies to most illegal DVDs.

– Some DVDs are not encoded with a rating though the movie rating may be printed on the Disc cover. The rating level feature does not prohibit playback of such Discs.

## PBC (Playback Control)

PBC (Playback Control) allows you to play Video CDs interactively, following the menu on the display. This feature is available only on Video CD 2.0 with playback control (PBC) feature.

- 1 In 'Preference Page', use ▲▼ keys to highlight { **PBC** }, then press ►.

#### { **On** }

Select this if you wish to display the index menu once you load in the VCD.

#### { **Off** }

Select this to skip the index menu and start playback directly.

- 2 Use ▲▼ keys to select a setting and press **OK** to confirm.

## MP3/JPEG Menu - turning on/off

MP3/JPEG Navigator can be set only if the disc is recorded with a menu. It allows you to select different display menus for easy navigation.

- 1 In 'Preference Page', use ▲▼ keys to highlight { **MP3/JPEG Nav** }, then press ►.

#### { **Without Menu** }

Select this to display all the files contained in the MP3/Picture CD.

#### { **With Menu** }

Select this to display only the folder menu of the MP3/Picture CD.

- 2 Use ▲▼ keys to select a setting and press **OK** to confirm.

#### Helpful Hint:

– When you load in an SACD disc, this feature will automatically disable.

**TIPS:** The underlined option is the factory default setting.  
To return to the previous menu, press ◀. To remove the menu, press **SETUP**.

# DVD Setup Menu Options (continued)

## Changing the Password

The same password is used for both Parental Control and Disc Lock. Enter your six-digit password to play a prohibited disc or if prompted for a password. The default password is 136900.

- 1 In 'Preference Page', use ▲▼ keys to highlight { **Password** }, then press ► to select { **Change** }.

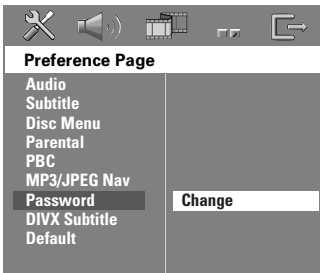

- 2 Press **OK** to enter the 'Password Change Page'.

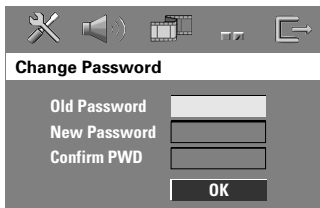

- 3 Use the **numeric keypad (0-9)** to enter your old six-digit password.  
→ When doing this for the first time, key in '136900'.  
→ If you forget your old six-digit password, key in '136900'.
- 4 Enter the new six-digit password.
- 5 Enter the new six-digit password a second time to confirm.  
→ The new six-digit password will now take effect.
- 6 Press **OK** to confirm.

## Setting the DivX Subtitle font

You can set the font type that supports the recorded DivX subtitle.

- 1 In 'Preference Page', use ▲▼ keys to highlight { **DIVX Subtitle** }, then press ►.

### { **Standard** }

Select this to display a standard list of Roman subtitle fonts provided by this DVD system.

### { **Others** }

Select this to display other subtitle fonts.

- 2 Use ▲▼ keys to select a setting and press **OK** to confirm.

## Restoring to original settings

You can reset all the system menu options and your personal settings to the factory defaults, except your password for Parental Control and Disc Lock.

- 1 In 'Preference Page', use ▲▼ keys to highlight { **Default** }, then press ► to select { **Reset** }.
- 2 Press **OK** to confirm.  
→ All settings will now reset to factory defaults.

**TIPS:** The underlined option is the factory default setting.  
To return to the previous menu, press ◀. To remove the menu, press **SETUP**.

### Setting the Sleep timer

The sleep timer enables the system to switch to Eco Power standby mode automatically at a preset time.

- Press **SLEEP** on the remote repeatedly until it reaches the desired preset turn-off time.
  - The selections are as follows (time in minutes):  
15 → 30 → 45 → 60 → OFF → 15...
  - 'SLEEP' icon will be showed on the display panel if sleep mode is active.
  - Before the system switches to Eco Power standby mode, a countdown of 10 seconds is displayed.  
"SLEEP 10" → "SLEEP 9".... →  
"SLEEP 1" → "STANDBY"

### To cancel the sleep timer

- Press **SLEEP** repeatedly until "OFF" appears or press the **STANDBY ON** (⏻) button.

## Tuner Operations

### IMPORTANT!

Make sure the **FM** and **MW** antennas are connected.

### Tuning to radio stations

- 1 Press **TUNER** on the remote (or press **SOURCE** control at the front panel) to select "FM" or "MW".
- 2 Press **▲ / ▼** briefly on the remote.  
→ The display panel will show "SEARCH" until a radio station with sufficient signal strength is found.
- 3 Repeat step 2 if necessary until you find the desired radio station.
- 4 To tune to a weak station, press **◀ / ▶** briefly and repeatedly until an optimal reception is found.

### Presetting radio stations

You can store up to 40 FM and 20 MW preset radio stations in the memory.

#### Helpful Hints:

- The system will exit presetting mode if no button is pressed within 20 seconds.
- If no valid frequency is detected during Plug and Play, "PLEASE CHECK FM/MW ANTENNA" appears.

### Using the Plug and Play

Plug and Play allows you to store all available radio stations automatically.

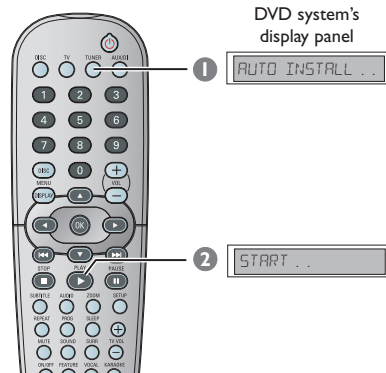

- 1 For first time setup, press **TUNER**.  
→ "AUTO INSTALL PRESS PLAY" appears.
- 2 Press **PLAY ▶** until "START ..." appears on the display panel.  
→ The system will start searching from FM band and followed by MW band. All the available radio stations with strong signal strength will be stored automatically.  
→ Once complete, the last tuned radio station will play.



## Tuner Operations (continued)

### Automatic presetting

Use automatic presetting to store or reinstall all the preset radio stations.

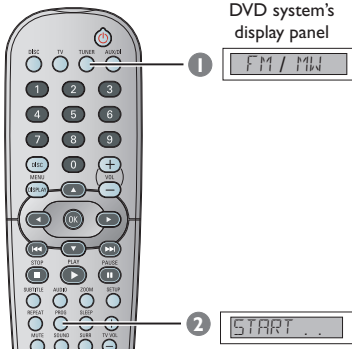

- 1 Press **TUNER** on the remote to select "FM" or "MW".
- 2 Press and hold **PROG** until "START ..." appears.  
→ All the former presets will be overwritten.

### Manual presetting

Use manual presetting to store only your favourite radio stations.

- 1 Tune to your desired radio station (see "Tuning to radio stations").
- 2 Press **PROG**.
- 3 Press **◀▶** to select a preset number that you want to store the current radio station.
- 4 Press **PROG** again to store.

### Selecting a preset radio station

- Press **TUNER** on the remote, then press **◀▶** to select a preset number (or use the numeric keypad on the remote).  
→ The waveband, preset number followed by radio frequency will appear.

### Deleting a preset radio station

- 1 In tuner mode, press **◀▶** on the remote to select a preset radio station.
- 2 Press and hold **■** until "FM/MW X DELETED" appears.  
→ "X" is the preset number.  
→ The radio station continues to play but has been deleted from the preset list.  
→ The rest of the preset radio station number remain unchanged.

### Changing tuning grid *(not available for all versions)*

*for all versions)*

In some countries, the frequency step between adjacent channels in the MW/FM band is 9 kHz/50 kHz (10 kHz/100 kHz in some areas). The preset frequency step in the factory is 9 kHz/50 kHz.

### IMPORTANT!

**Changing the tuning grid will erase all previously stored preset radio stations.**

- 1 Press **SOURCE** to select "FM" or "MW".
- 2 Press **STANDBY ON** to switch the DVD system to standby mode.
- 3 Press **STANDBY ON** again to turn on the DVD system and hold down **◀▶** button on the front panel.  
→ The display will show "GRID 9" or "GRID 10".

*Helpful Hint:*

– GRID 9 and GRID 10 indicate that the tuning grid is in step of 9 kHz and 10 kHz respectively.

# Sound and Volume Controls

## Individual speakers volume adjustment

You can adjust the delay times (centre, rear speakers and subwoofer only) and volume level for individual speakers. These adjustments let you optimise the sound according to your surroundings and setup.

### IMPORTANT!

Press **SURR** button on the remote to select **Multi-channel surround mode** before adjusting the speaker settings.

- 1 Press **■** twice to stop playback, then press **SETUP**.
- 2 Press **▶** repeatedly to select { Audio Setup Page }.
- 3 Use **▲▼** keys to highlight { **Speakers Volume** }, then press **▶**.

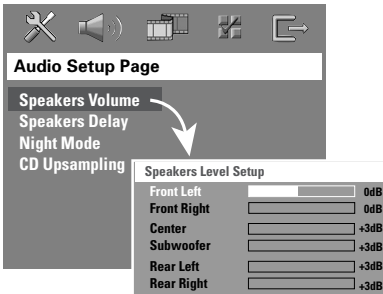

- 4 Use **◀▶** keys to set the volume level for each speaker (-6dB ~ +6dB).
- 5 Press **OK** to confirm.

- 6 Use **▲▼** keys to highlight { **Speakers Delay** }, then press **▶**.

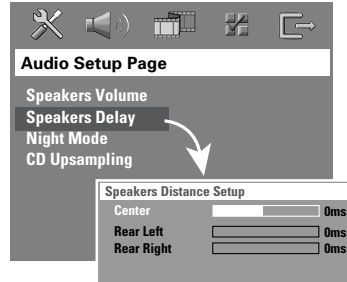

- 7 Use **◀▶** keys to set the delay times for centre and rear speakers that best suit your surround sound needs.
- 8 Press **OK** to confirm.

### Helpful Hints:

- A 1ms increase/decrease of delay time is equivalent to 30cm change in distance.
- Use the longer delay time settings when the rear speakers are closer to the listener than the front speakers.
- The test tone will be automatically generated to help you judge the sound level of each speaker.

**TIPS:** The underlined option is the factory default setting.  
To return to the previous menu, press **◀**. To remove the menu, press **SETUP**.

## Sound and Volume Controls (continued)

### Selecting surround sound

- Press **SURR** on the remote to select :  
MULTI-CHANNEL or STEREO.
  - The availability of the various surround sound modes depends on the number of speakers used and the sound available on the disc.
  - The centre and surround speakers operate only in Multi-channel surround mode.
  - The available output modes for Multi-channel include: Dolby Digital, DTS (Digital Theatre Systems) Surround and Dolby Pro Logic II.
  - Stereo broadcasts or recordings will produce some surround channel effects when played in a surround mode. However, mono (single channel sound) sources will not produce any sound from the surround speakers.

#### *Helpful Hint:*

– You are not able to select the surround sound mode if the system setup menu is turned on.

### Selecting digital sound effects

Select a preset digital sound effects that matches your disc's content or that optimises the sound of the musical style you are playing.

- Press **SOUND** to select the available sound effect.

When playing movie discs or in TV mode, you can select :  
CONCERT, DRAMA, ACTION or SCI-FI.

When playing music discs or while in TUNER or AUX/DI mode, you can select :  
ROCK, DIGITAL, CLASSIC or JAZZ.

#### *Helpful Hint:*

– For flat sound output, select **CONCERT** or **CLASSIC**.

### Volume control

- Adjust **VOLUME** control (or press **VOL +/–** on the remote) to increase or decrease the volume level.
  - "VOL MIN" is the minimum volume level and "VOL MAX" is the maximum volume level.

#### **To turn off the volume temporarily**

- Press **MUTE** on the remote.
  - Playback will continue without sound and "MUTE" appears.
  - To restore the volume, press **MUTE** again, or increase the volume level.

# Troubleshooting

## WARNING

Under no circumstances should you try to repair the system yourself, as this will invalidate the warranty. Do not open the system as there is a risk of electric shock.

If a fault occurs, first check the points listed below before taking the system for repair. If you are unable to remedy a problem by following these hints, consult your dealer or Philips for help.

Problem	Solution
<b>No power.</b>	<ul style="list-style-type: none"><li>– Check if the AC power cord is properly connected.</li><li>– Press the STANDBY ON on the front of the DVD system to turn on the power.</li></ul>
<b>No picture.</b>	<ul style="list-style-type: none"><li>– Refer to your TV's manual for correct Video In channel selection. Change the TV channel until you see the DVD screen.</li><li>– Press DISC on the remote control.</li><li>– If the progressive scan feature is activated but the connected TV does not support progressive signals or the cables are not connected accordingly, see page 18 for proper progressive scan set up or deactivate the progressive scan feature as below:<ol style="list-style-type: none"><li>1) Turn off your TV progressive scan mode or turn on to interlaced mode.</li><li>2) Press OPEN CLOSE to open the disc tray.</li><li>3) Press ◀ on the remote control.</li><li>4) Press MUTE on the remote control.</li></ol></li></ul>
<b>Completely distorted picture or black/white picture.</b>	<ul style="list-style-type: none"><li>– If this happens when you are changing the setting of the 'TV TYPE', wait for 15 seconds for the auto recovery.</li><li>– If this happens when you are turning on the progressive scan feature, wait for 15 seconds for the auto recovery.</li><li>– Check the video connection.</li><li>– Sometimes a small amount of picture distortion may appear. This is not a malfunction.</li><li>– Clean the disc.</li></ul>
<b>The aspect ratio of the screen cannot be changed even though you have set the TV display.</b>	<ul style="list-style-type: none"><li>– The aspect ratio is fixed on the DVD disc.</li><li>– Depending on the TV, it may not be possible to change the aspect ratio.</li></ul>
<b>No sound or distorted sound.</b>	<ul style="list-style-type: none"><li>– Adjust the volume.</li><li>– Check the speaker connections and settings.</li><li>– Make sure that the audio cables are connected and press the SOURCE button to select the correct input source (TV or AUX/DI, for example) to choose the equipment that you want to hear through the DVD system.</li><li>– To listen to the sound using your TV speakers via LINE OUT, lower the volume of the DVD system to level 1 and below.</li></ul>
<b>Cannot activate some features such as Angles, Subtitles, or multi-language Audio.</b>	<ul style="list-style-type: none"><li>– The features may not be available on the DVD.</li><li>– Changing the language for the sound or subtitle is prohibited on this DVD.</li></ul>

Need Help? Visit us at [www.philips.com/support](http://www.philips.com/support)

## Troubleshooting (continued)

Problem	Solution
<b>Not able to select some items in the setup/system menu.</b>	<ul style="list-style-type: none"><li>– Press STOP button twice before selecting the setup/system menu.</li><li>– Depending on the disc availability, some menu items cannot be selected.</li></ul>
<b>The DVD system does not start playback.</b>	<ul style="list-style-type: none"><li>– Insert a readable disc with the playback side facing down. The DVD+R/CD-R must be finalised.</li><li>– Check the disc type, colour system (PAL or NTSC) and region code.</li><li>– Check for any scratches or smudges on the disc.</li><li>– Press SETUP to turn off the setup menu screen.</li><li>– You may need to enter the password in order to change the parental control rating level or to unlock the disc for playback.</li><li>– Moisture may have condensed inside the system. Remove the disc and leave the system turned on for about an hour.</li></ul>
<b>There is no sound from the centre and surround speakers.</b>	<ul style="list-style-type: none"><li>– Make sure the centre and surround speakers are connected correctly.</li><li>– Press SURR button to select a correct surround sound setting.</li><li>– Make sure the source you are playing is recorded or broadcast in surround sound (DTS, Dolby Digital, etc.).</li></ul>
<b>Radio reception is poor.</b>	<ul style="list-style-type: none"><li>– If the signal is too weak, adjust the antenna or connect an external antenna for better reception.</li><li>– Increase the distance between the system and your TV or VCR.</li><li>– Tune in to the correct frequency.</li><li>– Place the antenna further away from any equipment that may be causing the interference.</li></ul>
<b>The remote control does not function properly.</b>	<ul style="list-style-type: none"><li>– Select the source (DISC or TUNER, for example) before pressing the function button (▶, ◀◀, ▶▶).</li><li>– Reduce the distance between the remote control and the system.</li><li>– Replace the batteries with new ones.</li><li>– Point the remote control directly toward the IR sensor.</li><li>– Check that the batteries are loaded correctly.</li></ul>
<b>Unable to play DivX movies.</b>	<ul style="list-style-type: none"><li>– Check that the DivX file is encoded in 'Home Theatre' mode with DivX 5.x encoder.</li></ul>
<b>The DVD system does not work.</b>	<ul style="list-style-type: none"><li>– Disconnect the power cord from the power outlet for a few minutes. Reconnect the power cord and try to operate again as usual.</li></ul>

Need Help? Visit us at [www.philips.com/support](http://www.philips.com/support)

# Glossary

**Analogue:** Sound that has not been turned into numbers. Analogue sound varies, while digital sound has specific numerical values. These sockets send audio through two channels, the left and right.

**Aspect ratio:** The ratio of vertical and horizontal sizes of a displayed image. The horizontal vs. vertical ratio of conventional TVs is 4:3, and that of wide-screens is 16:9.

**AUDIO OUT Sockets:** Red and white sockets on the back of the DVD System that send audio to another system (TV, Stereo, etc.).

**Bit Rate:** The amount of data used to hold a given length of music; measured in kilobits per second, or kbps. Or, the speed at which you record. Generally, the higher the bit rate, or the higher the recording speed, the better the sound quality. However, higher bit rates use more space on a Disc.

**Chapter:** Sections of a picture or a music piece on a DVD that are smaller than titles. A title is composed of several chapters. Each chapter is assigned a chapter number enabling you to locate the chapter you want.

**Component Video Out Sockets:** Sockets on the back of the DVD System that send high-quality video to a TV that has Component Video In sockets (R/G/B, Y/Pb/Pr, etc.).

**Disc menu:** A screen display prepared for allowing selection of images, sounds, subtitles, multi-angles, etc recorded on a DVD.

**DivX 3.11/4.x/5.x:** The DivX code is a patent-pending, MPEG-4 based video compression technology, developed by DivX Networks, Inc., that can shrink digital video to sizes small enough to be transported over the internet, while maintaining high visual quality.

**Dolby Digital:** A surround sound system developed by Dolby Laboratories containing up to six channels of digital audio (front left and right, surround left and right, centre and subwoofer).

**Dolby Surround Pro Logic II:** It is an improved matrix decoding technology that provides better spatiality and directionality on Dolby Surround programme material; provides a convincing three-dimensional soundfield on conventional stereo music recordings; and is ideally suited to bring the surround experience to automotive sound. While conventional surround programming is fully compatible with Dolby Surround Pro Logic II decoders, soundtracks will be able to be encoded specifically to take full advantage of Pro Logic II playback, including separate left and right surround channels. (Such material also compatible with conventional Pro Logic decoders).

**DTS:** Digital Theatre Systems. This is a surround sound system, but it is different from Dolby Digital. The formats were developed by different companies.

**JPEG:** A very common digital still picture format. A still-picture data compression system proposed by the Joint Photographic Expert Group, which features small decrease in image quality in spite of its high compression ratio.

**MP3:** A file format with a sound data compression system. "MP3" is the abbreviation of Motion Picture Experts Group 1 (or MPEG-1) Audio Layer 3. By using the MP3 format. One CD-R or CD-RW can contain about 10 times more data than a regular CD.

**Multichannel:** DVDs are formatted to have each sound track constitute one sound field. Multichannel refers to a structure of sound tracks having three or more channels.

**Parental control:** Limits Disc play according to the age of the users or the limitation level in each country. The limitation varies from disc to disc; when it is activated, playback will be prohibited if the software's level is higher than the user-set level.

**Playback control (PBC):** Refers to the signal recorded on video CDs or SVCDs for controlling playback. By using menu screens recorded on a Video CD or SVCD that supports PBC, you can enjoy interactive playback and searching.

**Progressive Scan:** It displays all the horizontal lines of a picture at one time, as a signal frame. This system can convert the interlaced video from DVD into progressive format for connection to a progressive display. It dramatically increases the vertical resolution.

**Region code:** A system allowing discs to be played only in the region designated. This unit will only play discs that have compatible region codes. You can find the region code of your unit by looking on the product label. Some discs are compatible with more than one region (or ALL regions).

**S-Video:** Produces a clear picture by sending separate signals for the luminance and the colour. You can use S-Video only if your TV has an S-Video In socket.

**Super Audio CD (SACD):** This audio format is based upon the current CD standards but includes a greater amount of information that provides higher quality sound. There are three types of discs: single layer, double layer and hybrid discs. The hybrid disc contains both standard audio CD and Super Audio CD information.

**Surround:** A system for creating realistic three-dimensional sound fields full of realism by arranging multiple speakers around the listener.

**Title:** The longest section of a movie or music feature on DVD. Each title is assigned a title number, enabling you to locate the title you want.

**VIDEO OUT socket:** Yellow socket on the back of the DVD system that sends the DVD picture video to a TV.

# Specifications

## AMPLIFIER SECTION

Output power	500 W
- Front	75 W RMS / channel
- Rear	75 W RMS / channel
- Centre	100 W RMS
- Subwoofer	100W RMS
Frequency Response	20 Hz – 20 kHz / –3 dB
Signal-to-Noise Ratio	> 62 dB (CCIR)
Input Sensitivity	
- AUX In	1000 mV
- DIGITAL In	1 Vpp

## TUNER SECTION

Tuning Range	FM 87.5 – 108 MHz (50 kHz) MW 531 – 1602 kHz (9 kHz) MW 530 – 1700 kHz (10 kHz)
26 dB Quieting Sensitivity	FM 20 dB MW 4 $\mu$ V/m
Image Rejection Ratio	FM 25 dB MW 28 dB
IF Rejection Ratio	FM 60 dB MW 45 dB
Signal-to-Noise Ratio	FM 60 dB MW 40 dB
AM Suppression Ratio	FM 30 dB
Harmonic Distortion	FM Mono 3% FM Stereo 3% MW 5%
Frequency Response	FM 180 Hz – 10 kHz / $\pm$ 6 dB
Stereo Separation	FM 26 dB (1 kHz)
Stereo Threshold	FM 23.5 dB

## DISC SECTION

Laser Type	Semiconductor
Disc Diameter	12cm / 8cm
Video Decoding	MPEG-1 / MPEG-2 / MPEG-4 / DivX 3.11, 4.x & 5.x
Video DAC	12 Bit
Signal System	PAL / NTSC
Video Format	4:3 / 16:9
Video S/N	74 dB
Composite Video Output	1.0Vp-p, 75 $\Omega$
S-Video Output	Y - 1.0Vp-p, 75 $\Omega$ C - 0.286Vp-p, 75 $\Omega$
Audio DAC	24 Bits / 192 kHz
Frequency Response	4 Hz – 20 kHz (44.1 kHz) 4 Hz – 22 kHz (48 kHz) 4 Hz – 44 kHz (96 kHz)
PCM	IEC 60958
Dolby Digital	IEC 60958, IEC 61937
DTS	IEC 60958, IEC 61937

## MAIN UNIT

Power Supply Rating	110 – 127V / 220 – 240V; 50 / 60 Hz Switchable
Power Consumption	100 W
Eco Standby power	< 0.5 W
Dimensions (w x h x d)	360 mm x 54 mm x 324 mm
Weight	2.7 kg

## FRONT AND REAR SPEAKERS

System	2-way, closed box system
Impedance	6 $\Omega$
Speaker drivers	1 x 76mm (3") woofer + 1 x 18mm dome tweeter
Frequency response	120 Hz – 12.5 kHz
Dimensions (w x h x d)	94 mm x 175 mm x 65 mm
Weight	0.58 kg/each

## CENTRE SPEAKER

System	2-way, closed box system
Impedance	3 $\Omega$
Speaker drivers	1 x 76mm (3") woofer + 1 x 18mm dome tweeter
Frequency response	120 Hz – 12.5 kHz
Dimensions (w x h x d)	225 mm x 94 mm x 75 mm
Weight	0.78 kg

## SUBWOOFER

Impedance	3 $\Omega$
Speaker drivers	152mm (6") woofer
Frequency response	30 Hz – 120 Hz
Dimensions (w x h x d)	360 mm x 340 mm x 130 mm
Weight	3.92 kg

*Specifications subject to change without prior notice*



