

Register your product and get support at
www.philips.com/welcome

PET717



EN User manual

PHILIPS

Contents

1 Important	5
Important safety instructions	5
Notice	7

2 Your portable DVD player	10
Introduction	10
What's in the box	11
Overview of the main unit	11
Overview of the remote control	14

3 Get started	17
Charge the built-in battery	17
Install the remote control battery	18
Connect additional equipment	19
Connect a TV	19
Connect an amplifier	20
Connect a stereo system	20
Turn on	21
Select an OSD language	22

4 Use your DVD player	23
Play discs	23
Play options	24
Activate PBC	24
Program	25
Repeat	25
Repeat a section	26
Rotate pictures	26

Skip to a title/track/chapter	27
Search	27
Select an audio language	27
Select an audio mode	27
Select a subtitle	27
Select a view angle	28
View disc information	28
Zoom	28
<hr/>	
5 Adjust settings	29
Select language options	29
Get the DivX® registration code	29
Select video options	30
Select display ratio	30
Select a view mode	31
Select picture contrast	32
Select audio options	33
Select play preferences	34
Restore original settings	34
Activate screen saver	34
Restrict access	35
Change a password	36
Select JPEG play options	38
<hr/>	
6 Troubleshooting	39
<hr/>	
7 Product information	41
<hr/>	
8 Glossary	42

1 Important

Important safety instructions

- ① Read these instructions.
- ② Keep these instructions.
- ③ Heed all warnings.
- ④ Follow all instructions.
- ⑤ Do not use this apparatus near water.
- ⑥ Clean only with dry cloth.
- ⑦ Do not block any ventilation openings. Install in accordance with the manufacturer's instructions.
- ⑧ Do not install near any heat sources such as radiators, heat registers, stoves, or other apparatus (including amplifiers) that produce heat.
- ⑨ Protect the power cord from being walked on or pinched, particularly at plugs, convenience receptacles, and the point where they exit from the apparatus.
- ⑩ Only use attachments/accessories specified by the manufacturer.
- ⑪ Use only with the cart, stand, tripod, bracket, or table specified by the manufacturer or sold with the apparatus. When a cart is used, use caution when moving the cart/apparatus combination to avoid injury from tip-over. 
- ⑫ Unplug this apparatus during lightning storms or when unused for long periods of time.
- ⑬ Refer all servicing to qualified service personnel. Servicing is required when the apparatus has been damaged in any way, such as power-supply cord or plug is damaged, liquid has been spilled or objects have fallen into the apparatus, the apparatus has been exposed to rain or moisture, does not operate normally, or has been dropped.
- ⑭ Battery usage CAUTION – To prevent battery leakage which may result in bodily injury, property damage, or damage to the unit:

- Install all batteries correctly, + and - as marked on the unit.
- Do not mix batteries (old and new or carbon and alkaline, etc.).
- Remove batteries when the unit is not used for a long time.

- ⑮ Apparatus shall not be exposed to dripping or splashing.
- ⑯ Do not place any sources of danger on the apparatus (e.g. liquid filled objects, lighted candles).
- ⑰ This product may contain lead and mercury. Disposal of these materials may be regulated due to environmental considerations. For disposal or recycling information, please contact your local authorities or the Electronic Industries Alliance: www.eiae.org.



Warning

- Never remove the casing of this DVD player.
- Never lubricate any part of this DVD player.
- Never place this DVD player on other electrical equipment.
- Keep this DVD player away from direct sunlight, naked flames or heat.
- Never look into the laser beam inside the DVD player.
- Ensure that you always have easy access to the power cord, plug or adaptor to disconnect the DVD player from the power.

Hearing safety

Listen at a moderate volume.

- Using headphones at a high volume can impair your hearing. This product can produce sounds in decibel ranges that may cause hearing loss for a normal person, even for exposure less than a minute. The higher decibel ranges are offered for those that may have already experienced some hearing loss.
- Sound can be deceiving. Over time your hearing 'comfort level' adapts to higher volumes of sound. So after prolonged listening, what sounds 'normal' can actually be loud and harmful to your hearing. To guard against this, set your volume to a safe level before your hearing adapts and leave it there.

To establish a safe volume level:

- Set your volume control at a low setting.
- Slowly increase the sound until you can hear it comfortably and clearly, without distortion.

Listen for reasonable periods of time:

- Prolonged exposure to sound, even at normally 'safe' levels, can also cause hearing loss.
- Be sure to use your equipment reasonably and take appropriate breaks.

Be sure to observe the following guidelines when using your headphones.

- Listen at reasonable volumes for reasonable periods of time.
- Be careful not to adjust the volume as your hearing adapts.
- Do not turn up the volume so high that you can't hear what's around you.
- You should use caution or temporarily discontinue use in potentially hazardous situations. Do not use headphones while operating a motorized vehicle, cycling, skateboarding, etc.; it may create a traffic hazard and is illegal in many areas.

**Caution**

- Use of controls or adjustments or performance of procedures other than herein may result in hazardous radiation exposure or other unsafe operation.

Notice

Any changes or modifications made to this device that are not expressly approved by Philips Consumer Lifestyle may void the user's authority to operate the equipment.

Environmental information

All unnecessary packaging has been omitted. We have tried to make the packaging easy to separate into three materials: cardboard (box), polystyrene foam (buffer) and polyethylene (bags, protective foam sheet.)

Your system consists of materials which can be recycled and reused if disassembled by a specialized company. Please observe the local regulations regarding the disposal of packaging materials, exhausted batteries and old equipment.

Recycling



Your product is designed and manufactured with high quality materials and components, which can be recycled and reused. When you see the crossed-out wheel bin symbol attached to a product, it means the product is covered by the European Directive 2002/96/EC:



Never dispose of your product with other household waste. Please inform yourself about the local rules on the separate collection of electrical and electronic products. The correct disposal of your old product helps prevent potentially negative consequences on the environment and human health.

Your product contains batteries covered by the European Directive 2006/66 /EC, which cannot be disposed of with normal household waste.

When you see the crossed-out wheel bin symbol with the chemical symbol 'Pb', it means that the batteries comply with the requirement set by the directive for lead:



Please inform yourself about the local rules on separate collection of batteries. The correct disposal of batteries helps prevent potentially negative consequences on the environment and human health.

Always bring your product to a professional to remove/replace the battery.

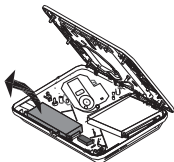

Be responsible
Respect copyrights

The making of unauthorized copies of copy-protected material, including computer programs, files, broadcasts and sound recordings, may be an infringement of copyrights and constitute a criminal offence. This equipment should not be used for such purposes.

Recording and playback of material might require consent. See Copyright Act 1956 and The Performer's Protection Acts 1958 to 1972.



Manufactured under license from Dolby Laboratories. 'Dolby' and the double D symbol are trademarks of Dolby Laboratories.



"DivX, DivX" Certified, and associated logos are trademarks of DivX, Inc. and are used under license.

This DVD player includes this label:









2 Your portable DVD player

Introduction

Your portable DVD player plays digital video discs conforming to the universal DVD Video standard. With it, you can play movies with cinema-like picture and stereo (depending on the disc and your playback set-up).

You can also select sound track, subtitle languages, and different angle of view (again depending on DVD disc). Besides, you can set parental control to prevent your children to see certain discs.

You can play the following discs on the DVD player (including CD-R, CD-RW, DVD±R, DVD±RW, and DivX):

	DVD-Video
	Video CD
	Super video CD
	Audio CD
	DivX® CD
	MP3 CD
	Discs with JPEG files

What's in the box

Check and identify the contents of your package:

- Portable DVD player
- Remote control
- Battery for remote control
- AC power adaptor (ADS-18C-12N 12012GPG)
- AV cable
- User Manual
- Quick Start Guide

Overview of the main unit

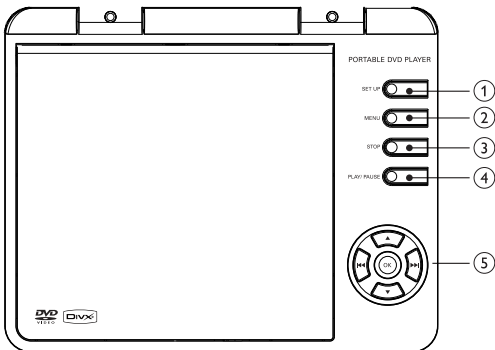

① SETUP

- Access or exit the setup menu

② MENU

- For DVD, access or exit the root menu
- For VCD and SVCD, turn PBC (playback control) on or off in PBC mode

③ STOP

- Stop disc play

④ PLAY/PAUSE

- Start, pause or resume disc play

⑤ Navigation keys

- ▲ / ▼ / ◀◀ / ▶▶

Select the up/down/left/right item

- ◀◀ / ▶▶

Press to skip to the previous or next title/chapter/track
Press and hold for fast-backward or fast-forward search

- OK

Confirm an entry or selection

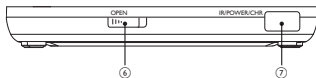

⑥ OPEN

- Open the disc compartment

⑦ IR/POWER/CHR

- Remote sensor, power indicator, or charge indicator

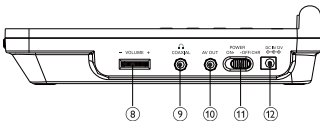

⑧ VOLUME + / -

- Adjust volume level

- ⑨ **COAXIAL**
 - Connect headphones
 - Socket for coaxial output
- ⑩ **AV OUT**
 - Socket for audio/video output
- ⑪ **POWER ON / OFF/CHR**
 - Turn on/off the DVD player
- ⑫ **DC IN 12V**
 - Socket for the AC-DC power adaptor

Overview of the remote control

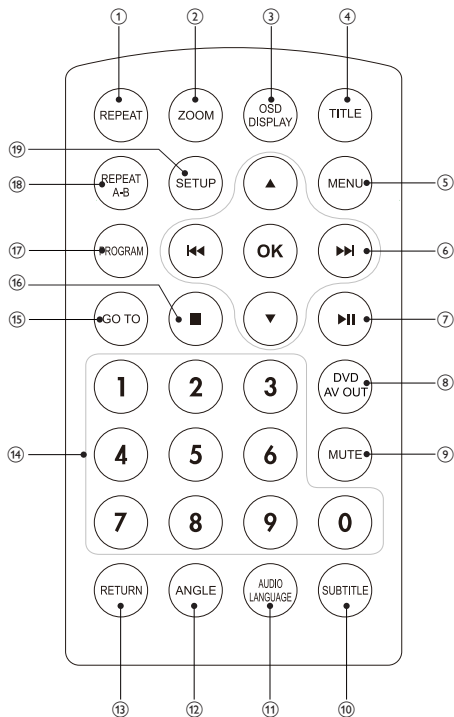

- ① **REPEAT**
 - Select a repeat mode
- ② **ZOOM**
 - Zoom into or out of an image

- ③ **OSD DISPLAY**
 - Display the current play status or disc information
- ④ **TITLE**
 - Access or exit the title menu of a disc
- ⑤ **MENU**
 - For DVD, access or exit the root menu
 - For VCD and SVCD, turn PBC (playback control) on or off in PBC mode
- ⑥ **▲ / ▼ / ◀▶ / ▶▶**

Select the up/down/left/right item

 - ◀▶ / ▶▶
Press to skip to the previous or next title/chapter/track
Press and hold for fast-backward or fast-forward search
 - **OK**
Confirm an entry or selection
- ⑦ **▶▶**
 - Start, pause or resume disc play
- ⑧ **DVD AV OUT**
 - Switch between [TV Mode (PAL)], [Dual Screen (NTSC)] and [AV OUT OFF]
- ⑨ **MUTE**
 - Mute or restore the volume
- ⑩ **SUBTITLE**
 - Select a subtitle language
- ⑪ **AUDIO LANGUAGE**
 - Select an audio language or an audio channel
- ⑫ **ANGLE**
 - Select a viewing angle of a DVD
- ⑬ **RETURN**
 - (For VCD, PBC on) Return to the previous menu

- ⑭ **Numeric Keypad 0 - 9**
 - Select an item to play
- ⑮ **GO TO**
 - Skip to a chapter/track/title or a play time
- ⑯ **■**
 - Stop disc play
- ⑰ **PROGRAM**
 - Access or exit the program menu
- ⑱ **REPEAT A-B**
 - Mark the section for repeat play
- ⑲ **SETUP**
 - Access or exit the setup menu

3 Get started



Caution

- Use the controls only as stated in this user manual.

Always follow the instructions in this chapter in sequence.

If you contact Philips, you will be asked for the model and serial number of your DVD player. The model number and serial number are on the bottom of your DVD player. Write the numbers here:

Model No. _____

Serial No. _____

Charge the built-in battery



Caution

- Risk of product damage! Ensure that the power supply voltage corresponds to the voltage printed on the back or the underside of the DVD player.
- Use only the supplied AC adaptor to charge the battery.



Note

- You can only charge the DVD player when it is in power-off mode.

- 1 Switch the **POWER ON / OFF/CHR** slide selector to the **OFF/CHR** position.

- 2 Connect the supplied AC adaptor to the **DC IN 12V** socket on the DVD player and to the AC outlet.

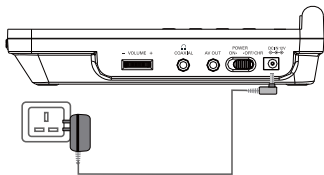

- ↳ The red charge indicator turns on. It takes about 4 hours to fully charge the battery.
- ↳ When the battery is fully charged, the red charge indicator turns off.



Tip

- You can only charge the battery when the temperature is between 0°C and 35°C.
- When headphones are connected to the DVD player; the fully charged battery lasts about 2.5 hours.
- To maximize battery life, recharge the battery immediately after the battery is fully discharged.
- When the DVD player is not in use, turn it off.

Install the remote control battery



Caution

- Risk of product damage! Risk of explosion! Keep batteries away from heat, sunshine or fire. Never discard batteries in fire.
- Risk of decreased battery life! Never mix different brands or types of batteries.
- Risk of product damage! When the remote control is not used for long periods, remove the batteries.
- Perchlorate Material - special handling may apply; See www.dtsc.ca.gov/hazardouswaste/perchlorate..

- 1 Open the battery compartment.
- 2 Insert 1 CR2025 battery with correct polarity (+/-) as indicated.
- 3 Close the battery compartment.

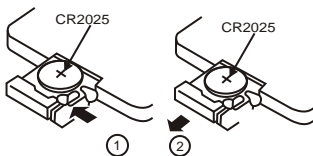

Connect additional equipment



Caution

- Before you connect your DVD player to any additional equipment, turn it off.

You can connect the DVD player to a TV or an amplifier to enjoy DVDs or Karaoke.

Connect a TV

On the DVD player;

- 1 Connect the black end of the supplied AV cable to the **AV OUT** socket.

On the TV,

- 1 Connect the white end to the left audio input socket and the red end to the right audio input socket.
- 2 Connect the yellow end to the video input socket.

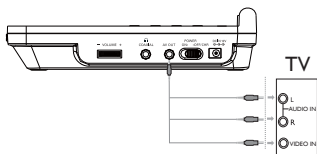

Connect an amplifier

- 1 On the DVD player, connect the black end of the supplied AV cable to the **COAXIAL** socket.
- 2 On the amplifier with a Dolby Pro-Logic Decoder, connect the yellow end of the AV cable to the audio or coaxial input socket.

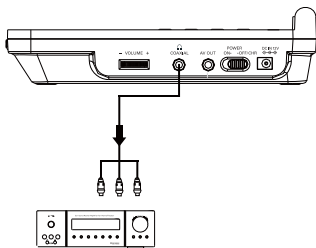

Connect a stereo system

- 1 On the DVD Player, connect the black end of the supplied AV cable to the **AV OUT** socket.
- 2 On the TV, connect the yellow end to the video input socket.
- 3 On the amplifier with a Dolby Pro-Logic Decoder, connect the white end to the left audio input socket and the red end to the right audio input socket.

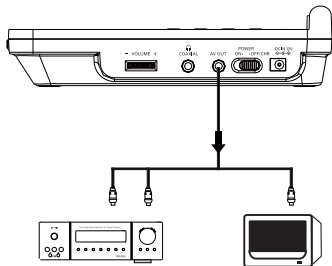

Turn on

- 1 Switch the **POWER ON / OFF/CHR** slide selector to the **ON** position.
↳ The green power indicator turns on.

Select an OSD language

You can select an OSD language for the on-screen display.

- 1 Press **SETUP**.
↳ The setup menu is displayed.



- 2 Select **[Language]**, and then press **▶▶**.
- 3 Select **[OSD language]**, and then press **▶▶**.
- 4 Select an option, and then press **OK** to confirm.
- 5 Press **SETUP** to exit.

4 Use your DVD player

Play discs

Before you play a DivX disc, use a DivX® registration code (see 'Get the DivX® registration code' on page 35) to download DivX® movies from the Internet, and then copy them to a recordable disc.



Note

- Ensure that the DVD player is connected to an AC power socket or the built-in battery is charged fully.

- 1 Lift the display panel.
- 2 Switch the **OPEN** slide selector to the right to open the disc compartment.
 - (For the first time) Remove the protective card.
- 3 Insert a disc with the printed side facing up.
- 4 Push the lid down to close the disc compartment.
 - ↳ Disc starts to play automatically. If not, press **OK** or **▶II**.
 - ↳ If a menu appears, select an item and then press **OK** to start play.

During play,

- To pause, press **PLAY/PAUSE / ▶II**.
- To resume, press **PLAY/PAUSE / ▶II** again.
- To stop, press **STOP / ■**.



Tip

- With the DVD player, you can play subtitle files in the following formats: .srt, .smi, .sub, .ssa, and .txt.
- Ensure that you save the subtitle file (.sub) with the same movie file (.avi) in the same folder.

Play options

Activate PBC

For VCDs with Playback Control (PBC) feature (version 2.0 only) and SVCDs,

- 1 Press **MENU**.
- 2 Select **[PBC On]**.
↳ The disc menu (if available) appears.

During play,

- Press **⏮** after the first 5 seconds, play starts from the beginning of the current track.
- Press **⏮** within the first 5 seconds, play goes to the previous track.
- If PBC on, press **RETURN** to return to the menu screen.



Tip

- If PBC is on, you cannot use numeric keypad (0-9) to select a track.

Program

For VCD/SVCD/DVD discs,

- 1 During play, press **PROGRAM** on the remote control.
↳ The program menu is displayed.
- 2 Select a title, and then press **OK** to confirm.
- 3 Select a chapter, and then press **OK** to confirm.
 - Select a track, and then press **OK** to confirm.
- 4 Press **PROGRAM** twice, and then repeat steps 2 and 3 to program other title/chapter/track.
- 5 To play the program, select **[Play]** and then press **OK** to confirm.
In the Program menu,
 - To exit the program menu, press **PROGRAM** once.
 - To clear the latest program, select **[Clear]** and then press **OK** to confirm.
 - To clear all the program, select **[Clear All]** and then press **OK** to confirm.



Tip

- For VCD and SVCD discs, program is only available when PBC is set to **[PBC Off]**.

Repeat

- 1 During play, press **REPEAT** repeatedly to select the following repeat options:
For DVD
 - **[Repeat Chapter]** (current chapter)
 - **[Repeat Title]** (current title)
 - **[Off]**

For CD/VCD/SVCD

- [Repeat Single] (current track)
- [Repeat All] (entire disc)
- [Off]

For JPEG/MP3

- [Repeat Single] (current file)
- [Repeat All] (current folder)
- [Off]



Tip

- For VCD/SVCD, if PBC is on, you cannot repeat items.

Repeat a section

You can repeat a specific section of audio/video within a title/chapter/track (repeat A-B).

- 1 During play, at the chosen start point, press **REPEAT A-B**.
- 2 At the chosen end point, press **REPEAT A-B** again.
↳ The selected section plays repeatedly.
- 3 Press **REPEAT A-B** to cancel.

Rotate pictures

During play,

- 1 Press ▲ to rotate a JPEG picture anti-clockwise.
- 2 Press ▼ to rotate a JPEG picture clockwise.

Skip to a title/track/chapter

To select the previous or next title/track/chapter,

1 During play, press **⏮** or **⏭**.

To skip directly to any title/track/chapter,

- During play, enter the corresponding number with the numerical keys (0-9), and then press **OK** to confirm.
- Press **GO TO**, enter a number, and then press **OK** to confirm.

Search

1 To search a section within a disc, press and hold **⏭** or **⏮**.

- During search, press and hold **⏮** or **⏭** to select a search speed.

2 Press **⏸** or **OK** to resume normal play.

Select an audio language

For DVDs with two or more audio languages,

1 During play, press **AUDIO LANGUAGE** repeatedly to select a language.

Select an audio mode

For VCDs with two or more audio tracks,

1 Press **AUDIO LANGUAGE** repeatedly to select an audio channel: **[Left]**, **[Right]**, **[Mix]**, or **[Stereo]**.

Select a subtitle

For discs with multilingual subtitles,

- During play, press **SUBTITLE** to select a subtitle.

Select a view angle

To select a view angle for DVD,

- During play, press **ANGLE** repeatedly on the remote control.

View disc information

To view information on a DVD/VCD,

- During play, press **OSD DISPLAY** on the remote control.

Zoom

For DVD, VCD and JPEG CDs, you can zoom into or out of an image.

- 1 Press **ZOOM** repeatedly to zoom into or out of an image.
- 2 When the image is enlarged, press **▲ / ▼ / ►► / ◀◀** to pan through it.

5 Adjust settings

Select language options

- 1 Press **SETUP**.
- 2 Select [**Language**], and then press **▶▶**.

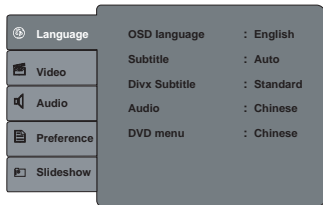

- 3 Select an option, and then press **OK** to confirm.
 - [**OSD language**]: Select an on-screen display language.
 - [**Subtitle**]: Select a disc subtitle language.
 - [**DivX Subtitle**]: Select a subtitle for a DivX disc.
 - [**Audio**]: Select a disc audio language.
 - [**DVD menu**]: Select a DVD menu language.
- 4 Select an option, and then press **OK** to confirm.
- 5 Press **SETUP** to exit.

Get the DivX® registration code

With the DivX® registration code, you can rent or purchase movies using the DivXVOD (Video on Demand) service on the Internet. For details, visit the website: <http://www.divx.com/vod>.

- 1 On the DVD player, press **SETUP**.
- 2 Select [**Preference**], and then press **▶▶**.

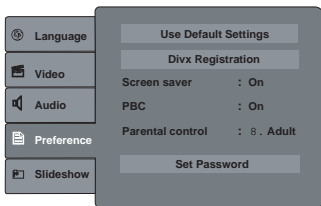

- 3 Select [**DivX Registration**], and then press **OK** to confirm.
↳ The registration code is displayed.
- 4 Write down the code.
 - Press **OK** to exit the code message.
- 5 Press **SETUP** to exit the setup menu.

Select video options

Select display ratio

- 1 Press **SETUP**.
- 2 Select [**Video**], and then press **▶▶**.

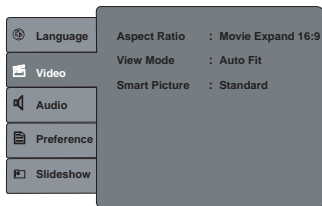

- 3 Select **[Aspect Ratio]**, and then press **OK** to confirm.
- 4 Select an option, and press **OK** to confirm.
 - **[4:3]**:The picture is reproduced in 4:3 format. A black band is displayed on either side of the picture.
 - **[Movie Expand 16:9]**: (Default) (letterbox format) The picture is enlarged to 16:9 format. A large part of the top and bottom of the picture is trimmed. Select this to play pictures which have black band at the top and bottom.
 - **[Widescreen]**:The picture is displayed in the original proportion of images transmitted in 16:9 format.
- 5 Press **SETUP** to exit.



Tip

- If you play a 4:3 picture in **Widescreen** mode, it stretches horizontally.

Select a view mode

- 1 Press **SETUP**.
- 2 Select **[Video]**, and then press **▶▶**.

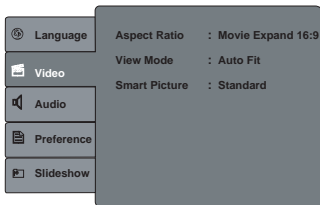

- 3 Select **[View Mode]**, and then press **OK** to confirm.

- 4 Select an option, and then press **OK** to confirm.
 - **[Original]**: Fit the original screen size (for JPEG only).
 - **[Auto Fit]**: (Default) Take the minimum value of horizontal and vertical fit scale ratio (like letter box).
 - **[Pan Scan]**: Take the maximum value of horizontal and vertical fit scale ratio.
- 5 Press **SETUP** to exit.

Select picture contrast

- 1 Press **SETUP**.
- 2 Select **[Video]**, and then press **▶▶**.

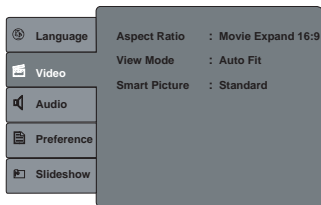

- 3 Select **[Smart Picture]**, and then press **OK** to confirm.
- 4 Select an option, and then press **OK** to confirm.
 - **[Standard]**: (Default) Select the preset picture setting.
 - **[Vivid]**: Make the picture brighter.
 - **[Cool]**: Make the picture softer.
 - **[Personal]**: Personalize your picture color by adjusting brightness, contrast and color.
- 5 Press **SETUP** to exit.

Select audio options

- 1 Press **SETUP**.
- 2 Select **[Audio]**, and then press **▶▶**.

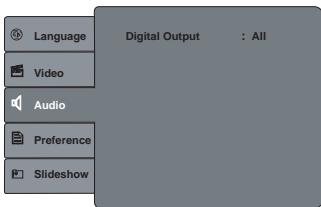

- 3 Select **[Digital Output]**, and then press **OK** to confirm.
- 4 Select an option, and then press **OK** to confirm.
 - **[Off]**: Deactivate the digital audio output.
 - **[PCM]**: For the connected device that cannot decode multichannel audio. The DVD player converts the Dolby digital and DTS multichannel signals to PCM.
 - **[All]**: (Default) For the connected device that has a built-in multichannel decoder that supports Dolby digital or DTS.
- 5 Press **SETUP** to exit.



Tip

- If you select **[All]**, all audio settings except MUTE are invalid.
- If you select **[All]** for an MPEG/MP3 disc, the DVD player outputs PCM signals.

Select play preferences

Restore original settings

- 1 Press **SETUP**.
- 2 Select [**Preference**], and then press **▶▶**.

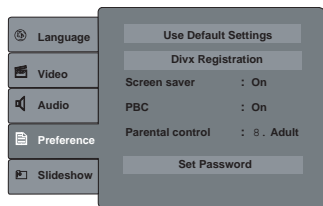

- 3 Select [**Use Default Settings**], and press **OK** to confirm.
↳ A confirmation message is displayed.
- 4 Press **◀◀ / ▶▶** to select an option, and then press **OK** to confirm.
- 5 Press **SETUP** to exit.

Activate screen saver

- 1 Press **SETUP**.
- 2 Select [**Preference**], and then press **▶▶**.

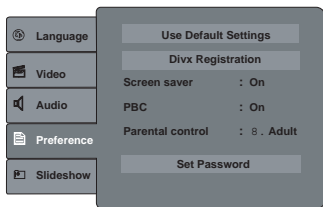

- 3 Select **[Screen saver]**, and then press **OK** to confirm.
- 4 Select an option, and then press **OK** to confirm.
 - **[Off]**: Deactivate screen saver.
 - **[On]**: (Default) Activate screen saver.
- 5 Press **SETUP** to exit.



Tip

- For VCD/DVD, if you do not press any button five minutes after the play is stopped, screen saver starts automatically.

Restrict access

With the Parental Control function, you can restrict access to DVDs that are not suitable for your children. The rating levels are country dependent. To view DVDs that are rated higher than the set level, you should enter a 4-digit password.

- 1 Press **SETUP**.
- 2 Select **[Preference]**, and then press **▶▶**.

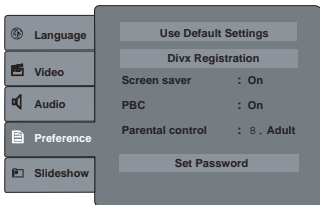

- 3 Select **[Parental control]**, and then press **OK** to confirm.

4 Enter the 4-digit password.

5 Select an option, and then press **OK** to confirm.

- **[1. Kid Safe]**: Childsafe; acceptable for viewers of all ages.
- **[2. G]**: General Audience; acceptable for viewers of all ages.
- **[3. PG]**: Parental Guidance suggested.
- **[4. PG-13]**: Unsuitable for children under age 13.
- **[5. PG-R]**: Recommend that parents restrict children under 17 from viewing.
- **[6. R]**: Recommend that parents guide children under 17 to view.
- **[7. NC-17]**: Unsuitable for children under 17.
- **[8. Adult]**: (Default) acceptable for adults only.

6 Press **SETUP** to exit.



Tip

- This function is only available for DVDs that are coded with rating levels.

Change a password

1 Press **SETUP**.

2 Select **[Preference]**, and then press **▶▶**.

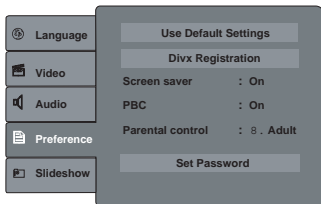

- 3 Select [**Set Password**], and then press **OK** to confirm.
- 4 Enter the current password, and then press **OK** to confirm.
 - The default password is 0000.
- 5 Enter a new 4-digit password, and then press **OK** to confirm.
- 6 Press **SETUP** to exit.

**Tip**

- If you forget the current password, you can enter the default password and then press **OK** to confirm. Then, you can enter the new password.

Select JPEG play options

You can display JPEG images as a slideshow and select a display effect.

- 1 Press **SETUP**.
- 2 Select **[Slideshow]**, and then press **▶▶**.

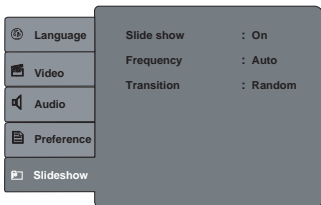

- 3 Select an item, and then press **OK** to confirm.
 - **[Slideshow]**: Activate/deactivate slideshow.
 - **[Frequency]**: Select a display interval for JPEG images.
 - **[Transition]**: Select a display mode for JPEG images.
- 4 Select an option, and then press **OK** to confirm.
- 5 Press **SETUP** to exit.

6 Troubleshooting



Warning

- Never remove the casing of this DVD player.

To keep the warranty valid, never try to repair the system yourself. If you encounter problems when using this DVD player, check the following points before requesting service. If the problem remains unsolved, go to the Philips web site www.philips.com/welcome. When you contact Philips, ensure that your DVD player is nearby and the model number and serial number are available (see 'Get started' on page 21).

No power

- Ensure that both plugs of the mains cord are properly connected.
- Ensure that there is power at the AC outlet.
- Check if the built-in battery is drained.

Distorted picture

- Clean the disc. With a clean, soft, lint-free cloth, wipe the disc outwards from the center.
- Make sure that the video output format of the disc is compatible with the TV.
- Change the video output format with **DVD AV OUT** to match your TV or program.
- The LCD is manufactured using high precision technology. You may, however, see tiny black points and/or bright points (red, blue, green) that continuously appear on the LCD. This is a normal result of the manufacturing process and does not indicate a malfunction.

No sound

- Ensure that the AV cable is connected correctly.

Cannot play disc

- Ensure the disc label is upwards.
- Clean the disc. With a clean, soft, lint-free cloth, wipe the disc outwards from the center.
- Check if the disc is defective by trying another disc.

No response to the remote control

- Ensure that the path between the remote control and the DVD player is clear from obstacles.
- From a close distance, point the remote control directly at the DVD player.
- Replace the remote control battery.
- The function does not work for this disc. Refer to the disc instructions.

The DVD player feels warm

- When the DVD player is in use for a long period of time, its surface will be heated. This is normal.

7 Product information



Note

- Product information is subject to change without prior notice.

Dimensions (player)	199 × 159 × 40 mm
Weight (player)	0.66 kg
Power supply	DC 12V 1A
Power consumption	15 W
Operating temperature	5 - 35°C
Laser wavelength	650 nm
Playable DivX discs	DivX® 5 and earlier
Frequency response	20Hz - 20KHz ± 1 dB
Signal/noise ratio	> 85 dB
Audio distortion	< 0.1%
Load impedance	75 Ω
Humidity	15% - 75%

8 Glossary

A

Aspect ratio

Aspect ratio refers to the length to height ratio of TV screens. The ratio of a standard TV is 4:3, while the ratio of a high-definition or wide TV is 16:9. The letter box allows you to enjoy a picture with a wider perspective on a standard 4:3 screen.

D

DivX®

The DivX® codec is a patent-pending, MPEG-4 based video compression technology developed by DivX®, Inc. It can shrink the file size of digital video and still maintain the high visual quality.

J

JPEG

A very common digital still picture format. A still-picture data compression system proposed by the Joint Photographic Expert Group, which features small decrease in image quality in spite of its high compression ratio. Files are recognized by their file extension '.jpg' or '.jpeg'.

M

MP3

A file format with a sound data compression system. MP3 is the abbreviation of Motion Picture Experts Group 1 (or MPEG-1) Audio Layer 3. With the MP3 format, one CD-R or CD-RW can contain about 10 times more data than a regular CD.

MPEG

Motion Picture Experts Group. A collection of compression systems for digital audio and video.

P**PBC**

Playback Control. A system where you navigate through a Video CD/Super VCD with on-screen menus that are recorded onto the disc. You can enjoy interactive playback and search.

PCM

Pulse Code Modulation. A digital audio encoding system.

R**Region code**

A system that allows discs to be played only in the region designated. This unit only plays discs that have compatible region codes. You can find the region code of your unit on the product label. Some discs are compatible with more than one region (or ALL regions.)

T**Title**

On commercial DVDs, this is the longest section of a movie or music feature on DVD. Each title is assigned a title number, so that you can locate the title you want.

When you record programs, they are stored as titles. Depending on the recording settings, recorded titles may automatically contain several chapters.

