

Registre su producto y obtenga asistencia en  
[www.philips.com/welcome](http://www.philips.com/welcome)

FWM211X



---

EN

User manual

**PHILIPS**

# Contents

<b>1 Important</b>	2	<b>8 Product information</b>	14
Safety	2	Specifications	14
		USB playability information	15
<b>2 Your Mini Hi-Fi System</b>	4	Supported MP3 disc formats	15
Introduction	4	Maintenance	15
What's in the box	4		
Overview of the main unit	5	<b>9 Troubleshooting</b>	16
Overview of the remote control	6		
		<b>10 Notice</b>	17
<b>3 Get started</b>	8		
Connect MW (AM) antenna	8		
Connect speakers	8		
Prepare the remote control	9		
Connect power	9		
Turn on	9		
Set clock	9		
<b>4 Play</b>	10		
Basic play operations	10		
Play disc	10		
Play from USB	10		
Play audio from an external device	10		
<b>5 Play options</b>	11		
Adjust sound	11		
Repeat and shuffle play	11		
Program tracks	11		
Display different information	11		
<b>6 Listen to radio</b>	12		
Tune to radio stations	12		
Store radio stations automatically	12		
Store radio stations manually	12		
Select a preset radio station	12		
<b>7 Other features</b>	13		
Set alarm timer	13		
Set sleep timer	13		

# 1 Important

## Safety

### Know these safety symbols

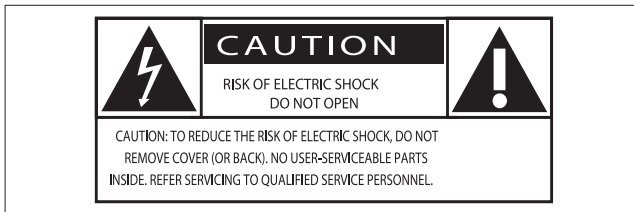

This 'exclamation point' indicates that the material within your unit may cause an electrical shock. For the safety of everyone in your household, please do not remove product covering.

The 'exclamation point' calls attention to features for which you should read the enclosed literature closely to prevent operating and maintenance problems. **WARNING:** To reduce the risk of fire or electric shock, this apparatus should not be exposed to rain or moisture and objects filled with liquids, such as vases, should not be placed on this apparatus.

**CAUTION:** To prevent electric shock, match wide blade of plug to wide slot, fully insert.

### Important Safety Instructions

- Read these instructions.
- Heed all warnings.
- Follow all instructions.
- Do not block any ventilation openings. Install in accordance with the manufacturer's instructions.

- Do not install near any heat sources such as radiators, heat registers, stoves, or other unit (including amplifiers) that produce heat.
- Protect the power cord from being walked on or pinched, particularly at plugs, convenience receptacles, and the point where they exit from the clock radio.
- Only use attachments/accessories specified by the manufacturer.
- Use only with the cart, stand, tripod, bracket, or table specified by the manufacturer or sold with the Hi-Fi system. When a cart is used, use caution when moving the cart/unit combination to avoid injury from tip-over.



- Unplug this Hi-Fi system during lightning storms or when unused for long periods of time.
- Refer all servicing to qualified service personnel. Servicing is required when the Hi-Fi system has been damaged in any way, such as power-supply cord or plug is damaged, liquid has been spilled or objects have fallen into the Hi-Fi system, the Hi-Fi system has been exposed to rain or moisture, does not operate normally, or has been dropped.
- This Hi-Fi system shall not be exposed to dripping or splashing.
- Do not place any sources of danger on the Hi-Fi system (e.g. liquid filled objects, lighted candles).
- Battery usage **CAUTION** – To prevent battery leakage which may result in bodily injury, property

amage, or damage to the remote control:

- Install all batteries correctly, + and - as marked on the remote control.
- Remove batteries when the remote control is not used for a long time.
- Where the MAINS plug or an appliance coupler is used as the disconnect device, the disconnect device shall remain readily operable.



### Warning

- Never remove the casing of this apparatus.
- Never lubricate any part of this apparatus.
- Never place this apparatus on other electrical equipment.
- Keep this apparatus away from direct sunlight, naked flames or heat.
- Never look into the laser beam inside this apparatus.
- Ensure that you always have easy access to the power cord, plug or adaptor to disconnect this apparatus from the power.

# 2 Your Mini Hi-Fi System

- Speaker box (x 2)
- AM loop antenna
- MP3 link cable
- User manual
- Quick start guide

Congratulations on your purchase, and welcome to Philips! To fully benefit from the support that Philips offers, register your product at [www.philips.com/welcome](http://www.philips.com/welcome).

---

## Introduction

**With this Hi-Fi system, you can:**

- enjoy audio from discs, USB device, or other external devices; and
- listen to FM/AM radio stations

**To enrich sound, this Hi-Fi system offers you these sound effects:**

- Digital Sound Control (DSC)
- Dynamic Bass Boost (DBB)
- Max Sound for instant power boost

**The Hi-Fi system supports these media formats:**



---

## What's in the box

Check and identify the contents of your package:

- Main unit
- Remote control (with batteries)

## Overview of the main unit

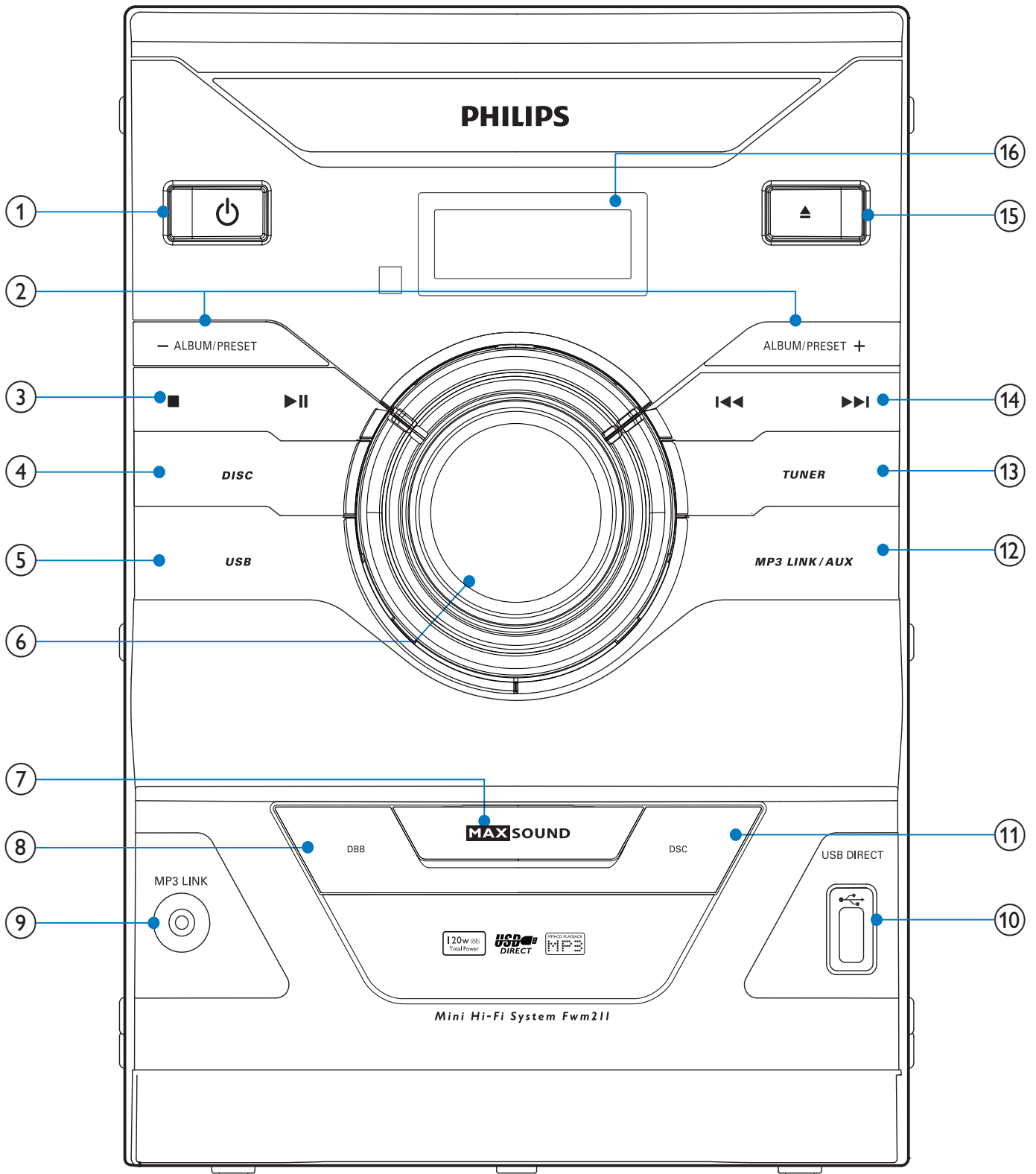

① 

- Turn on the Hi-Fi system.
- Switch to standby mode.

② **ALBUM/PRESET +/-**

- Select a preset radio station.
- Skip to previous/next album.

③ 

- Stop play or erase a program.
- Start or pause play.

④ **DISC**

- Select disc source.

## Overview of the remote control

- ⑤ **USB**
  - Select USB source.
- ⑥ **Volume controller**
  - Adjust volume.
- ⑦ **MAX SOUND**
  - Turn on/off instant power boost.
- ⑧ **DBB**
  - Turn on/off dynamic bass enhancement.
- ⑨ **MP3 LINK**
  - Connect external audio device.
- ⑩ **USB DIRECT**
  - Connect USB device.
- ⑪ **DSC**
  - Select a preset sound setting.
- ⑫ **MP3 LINK/AUX**
  - Select MP3 link/AUX source.
- ⑬ **TUNER**
  - Select tuner source.
- ⑭ **⏮/⏭**
  - Skip to previous/next track.
  - Search within a track/disc.
  - Tune to a radio station.
  - Adjust time.
- ⑮ **▲**
  - Open/close the disc tray.
- ⑯ **Display panel**
  - Show current status.

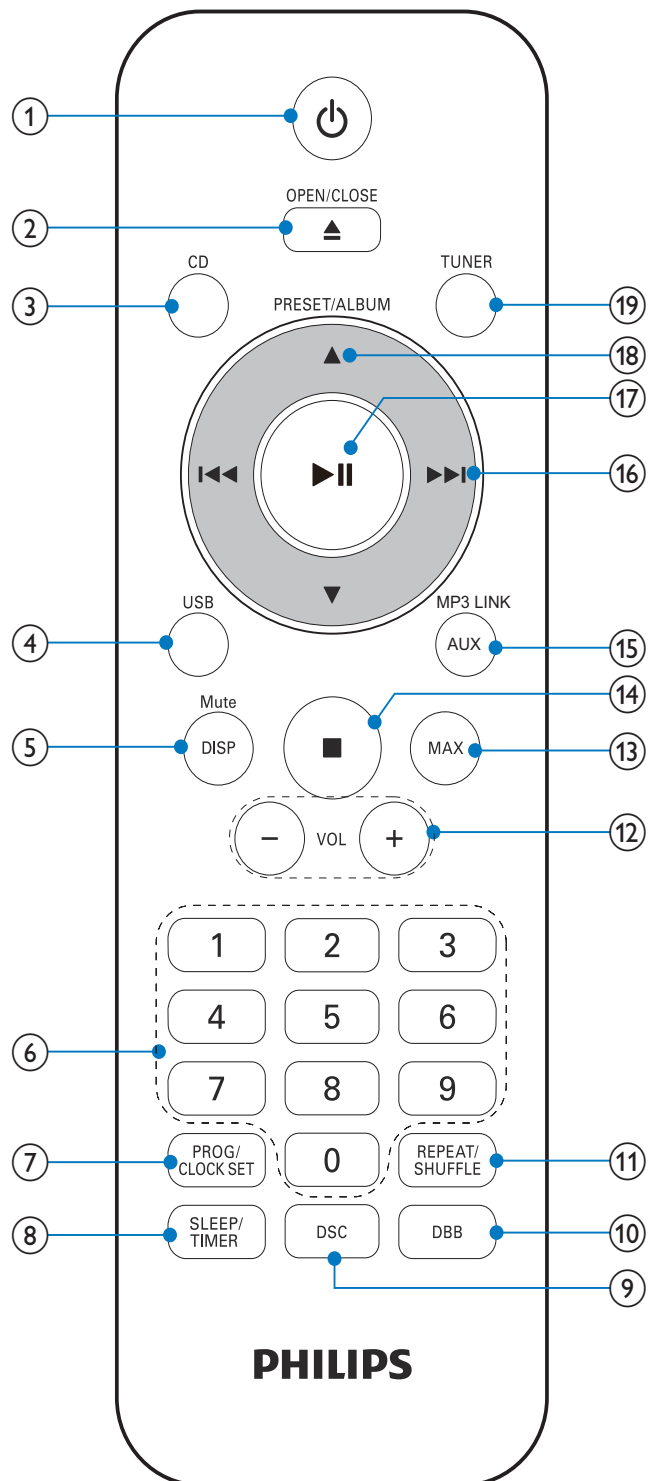

- ① **⏻**
  - Turn on the Hi-Fi system.
  - Switch to standby mode.
- ② **OPEN/CLOSE▲**
  - Open/close the disc tray.

- ③ **CD**
  - Select disk source.
- ④ **USB**
  - Select USB source.
- ⑤ **DISP/MUTE**
  - Mute/unmute sound.
  - Display clock and play information.
- ⑥ **Numeric keypad**
  - Select a track from a disc directly.
- ⑦ **PROG/CLOCK SET**
  - Set time.
  - Program tracks and radio stations.
- ⑧ **SLEEP/TIMER**
  - Set alarm/sleep timer.
- ⑨ **DSC**
  - Select a preset sound setting.
- ⑩ **DBB**
  - Turn on/off dynamic bass enhancement.
- ⑪ **REPEAT/SHUFFLE**
  - Play tracks repeatedly/randomly.
- ⑫ **VOL +/-**
  - Adjust volume.
- ⑬ **MAX**
  - Turn on/off instant power boost.
- ⑭ **■**
  - Stop play.
  - Erase a program.
- ⑮ **MP3 LINK/AUX**
  - Select MP3 Link/AUX source.
- ⑯ **◀◀▶▶**
  - Search within a track/disc.
  - Tune to a radio station.
  - Skip to the previous/next track.
  - Adjust time.
- ⑰ **▶||**
  - Start or pause play.
- ⑱ **PRESET/ALBUM▲▼**
  - Select a preset radio station.
  - Skip to previous/next album.
- ⑲ **TUNER**
  - Select tuner source.



# 3 Get started

## ! Caution

- Use of controls or adjustments or performance of procedures other than herein may result in hazardous radiation exposure or other unsafe operation.

Always follow the instructions in this chapter in sequence.

## Connect MW (AM) antenna

1 Assemble the MW (AM) loop antenna.

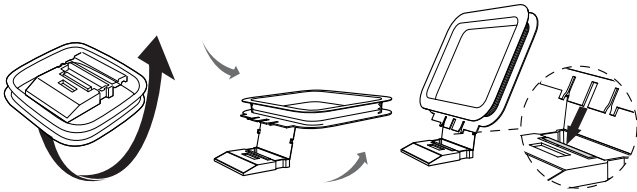

2 Connect the MW (AM) loop antenna to the **AM ANT** socket at the back of the Hi-Fi system.

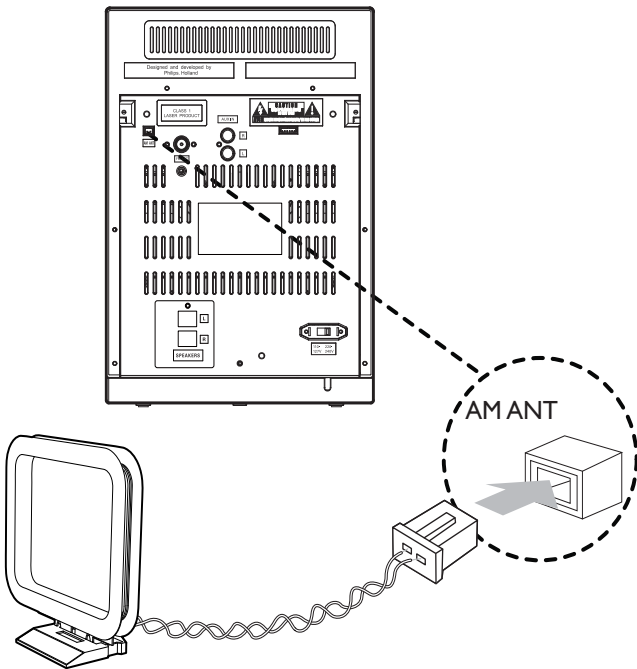

## Connect speakers

### ≡ Note

- For better sound effect, use the supplied speakers only.
- Connect only speakers with impedance that is the same or higher than the supplied speakers. Refer to the Specifications section of this manual.

Insert speaker wires completely into the speaker sockets at the back of the Hi-Fi system.

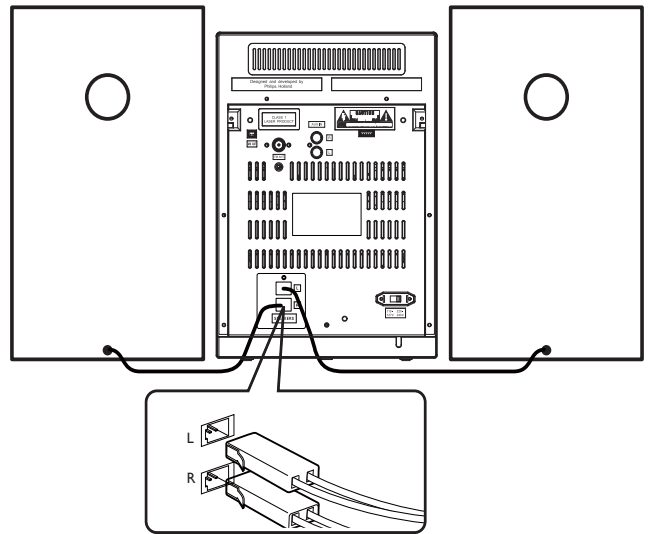

## Prepare the remote control

### ! Caution

- Risk of explosion! Keep batteries away from heat, sunshine or fire. Never discard batteries in fire.
- Risk of decreased battery life! Never mix different brands or types of batteries.

Before using the remote control, install two AAA batteries with correct polarity (+/-) as indicated.

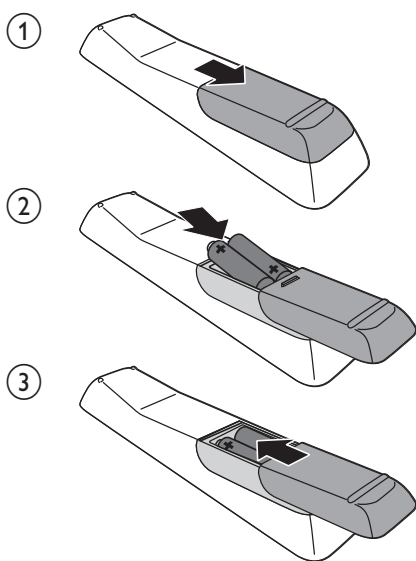

## Connect power

### ! Caution

- Risk of product damage! Make sure that the power supply voltage corresponds to the voltage printed on the head of the AC power cord.
- Risk of electric shock! When you unplug the power cord, always pull the plug from the socket. Never pull the cord.

### ≡ Note

- Before connecting the AC power cord, make sure that you have completed all other connections.

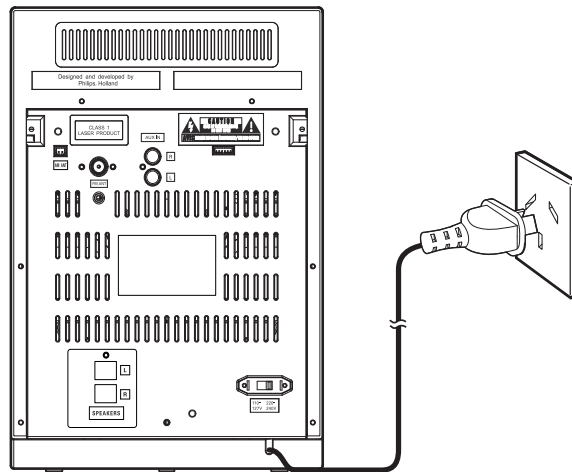

## Turn on

Press .

- ↳ The Hi-Fi system switches to the last selected source.

## Switch to standby mode

Press  to switch the Hi-Fi system to standby mode.

- ↳ The clock (if set) appears on the display panel.

## Set clock

- 1 In standby mode, press and hold **CLOCK SET** for two seconds.
  - ↳ **[SET CLOCK]** (set clock) scrolls on the display, then **[24H]** or **[12H]** appears.
- 2 Press  to select 12/24 hour format.
- 3 Press **CLOCK SET** to confirm.
  - ↳ The hour digits begin to blink.
- 4 Repeat Steps 2 to 3 to set the hour and minute.

### ≡ Note

- To exit clock setting mode, press .

# 4 Play

## Basic play operations

You can control play through following operations.

Function	Action
To stop play	press ■.
To pause/resume play	press ►  .
To skip to a track	press  ◀◀/▶▶ .
To search during play	press and hold  ◀◀/▶▶ , then release to resume normal play.
To select an album (for MP3/WMA)	press ▲/▼.
To select a track directly	press the numeric buttons.

## Play disc

### Note

- Make sure that the disk contains playable audio content.

- 1 Press **CD** to select the disk source.
- 2 Press ▲.  
↳ The disc tray opens.
- 3 Insert a disc with the printed side facing up, then press ▲ to close the disc tray.  
↳ **[Read]** (read) blinks for about 10 seconds, then play starts automatically.

## Play from USB

### Note

- Make sure that the USB device contains playable audio content.

- 1 Insert the USB device into the  socket.
- 2 Press **USB** to select the USB source.  
↳ Play starts automatically.

## Play audio from an external device

With this Hi-Fi system, you can play audio from an external audio device.

**For audio device with headphone sockets:**

- 1 Press **MP3 LINK/AUX** to select MP3 link source.
- 2 Connect the supplied MP3 Link cable to
  - the **MP3 LINK** socket.
  - the headphone socket on an external device.
- 3 Play the external device (see the user manual of this device).

**For other audio devices:**

- 1 Press **MP3 LINK/AUX** repeatedly to select AUX source.
- 2 Connect the audio cables to:
  - the **AUX IN** sockets.
  - the **AUDIO OUT** sockets on an external device.
- 3 Play the device (see the user manual of this device).

# 5 Play options

## Adjust sound

During play, you can adjust volume and select sound effects:

Function	Action
To increase/decrease volume	Press <b>VOL +/-</b> .
To mute/unmute sound	Press and hold <b>MUTE</b> for two seconds.
To turn on/off instant power boost	Press <b>MAX.</b>
To turn on/off dynamic bass enhancement	Press <b>DBB.</b>
To select a preset sound effect ( <b>FLAT</b> , <b>OPTIMAL</b> , <b>JAZZ</b> , <b>ROCK</b> , and <b>TECHNO</b> )	Press <b>DSC</b> repeatedly.

## Repeat and shuffle play

- Press **REPEAT** repeatedly to select:
  - : play current track repeatedly.
  - (repeat all): play all tracks repeatedly.
  - (for MP3/WMA only): play current album repeatedly.
  - : play all tracks randomly.
- To return to normal play, press **REPEAT** repeatedly until **[TRK]** (track) is displayed.

## Program tracks

You can program a maximum of 20 tracks.

- In CD/USB mode, when no track is played, press **PROG**.

↳ **[PROG]** (program) and the preset number blinks on the display panel.

- For MP3/WMA tracks, press **▲/▼** to select an album.
- Press **◀/▶** to select a track number, then press **PROG** to confirm.
- Repeat steps 2 to 3 to program more tracks.
- Press **▶||** to play the programmed tracks.
  - ↳ During play, **[PROG]** (program) is displayed.
    - To erase the program, in the stop position, press **■**.

## Display different information

During play, press **DISPLAY** repeatedly to view time and different play information.

# 6 Listen to radio

---

## Tune to radio stations

### Note

- To improve FM reception, fully extend and adjust the position of FM antenna.

- 1 Press **TUNER** repeatedly to select FM/MW(AM) tuner source.
- 2 Press and hold **◀▶** for 2 seconds.
  - ↳ The Hi-Fi system tunes to a station with strong reception automatically.
- 3 Repeat step 2 to tune to more stations.

### To tune to a weak station:

- 1 Press **◀▶** repeatedly until you find optimal reception.

---

## Store radio stations automatically

### Note

- You can store a maximum of 30 FM radio stations and 10 MW(AM) radio stations.

In tuner mode, press and hold **PROG** for 2 seconds.

- ↳ **[AUTO]** (auto) is displayed.
- ↳ The system stores all the available stations and broadcasts the first available station automatically.

---

## Store radio stations manually

- 1 Tune to a FM/MW(AM) radio station.
- 2 Press **PROG**.
  - ↳ The preset number begins to blink.
- 3 Press **▲/▼** repeatedly to select a number.

- 4 Press **PROG** again to confirm.
- 5 Repeat Steps 1 to 4 to store other stations.

### Note

- To remove a pre-stored station, store another station in its place.

---

## Select a preset radio station

In tuner mode, press **▲/▼** repeatedly to select a preset radio station.

# 7 Other features

---

## Set alarm timer

This Hi-Fi system can be used as an alarm clock. For alarm source, you can select disc, tuner, or USB.

### Note

- Make sure that you have set the clock correctly.

- 1 In standby mode, press and hold **TIMER** until **[SET TIMER]** (set timer) appears. Then **[SELECT SOURCE]** (select source) scrolls on the display.
- 2 Press source selection keys to select an alarm source: **DISC**, **TUNER**, or **USB**.
- 3 Press **TIMER** to confirm.
  - ↳ The hour digits begin to blink.
- 4 Press **◀◀▶▶** to set hour.
- 5 Press **TIMER** to confirm.
  - ↳ The minute digits begin to blink.
- 6 Repeat steps 4-5 to set minute.
  - ↳ The alarm icon appears.

---

## Set sleep timer

This Hi-Fi system can switch to standby mode automatically after a preset time period. Press **SLEEP** repeatedly to select a period (in minutes).

- ↳ When sleep timer is activated, **zzz** appears.

### To deactivate sleep timer:

Press **SLEEP** repeatedly until **[SLP OFF]** (sleep off) is displayed.

- ↳ **zzz** disappears.

# 8 Product information



## Note

- Product information is subject to change without prior notice.

## Specifications

### Amplifier

Rated Output Power	2X60W RMS
Frequency Response	63 - 16000 Hz, $\pm 3$ dB
Signal to Noise Ratio	>55dB

### Disc

Laser Type	Semiconductor
Disc Diameter	12cm/8cm
Support Disc	CD-DA, CD-R, CD-RW, MP3-CD, WMA-CD
Audio DAC	24Bits / 44.1kHz
Total Harmonic Distortion	<1%
Frequency Response	63Hz - 16kHz
S/N Ratio	>65dBA

### Tuner

Tuning Range	FM:87.5 - 108 MHz MW: 530 - 1710 kHz
Tuning grid	FM: 50 KHz MW: 10KHz
Sensitivity	- Mono, 26dB S/N Ratio <22 dBu - Stereo, 46dB S/N Ratio <45 dBu
Search Selectivity	<28 dBu
Total Harmonic Distortion	<3%
Signal to Noise Ratio	>45 dB

### Speakers

Speaker Impedance	4ohm
-------------------	------

### General information

AC power	110 - 127V/220 - 240V ~, 50/60Hz
Operation power consumption	45 W
Standby power consumption	<10 W
USB direct	Version 2.0/1.1
Dimensions	220 x 312 x 248 - Main Unit (W x H x D) mm - Speaker Box (W x H x D) mm
Weight	- With Packing 9.5 kg - Main Unit 3.4 kg - Speaker Box 2 x 2.1 kg

## USB playability information

### Compatible USB devices:

- USB flash memory (USB 2.0 or USB1.1)
- USB flash players (USB 2.0 or USB1.1)
- memory cards (requires an additional card reader to work with this unit)

### Supported formats:

- USB or memory file format FAT16, FAT32 (sector size: 512 bytes)
- MP3 bit rate (data rate): 32-320 Kbps and variable bit rate
- WMA v9 or earlier
- Directory nesting up to a maximum of 8 levels
- Number of albums/ folders: maximum 99
- Number of tracks/titles: maximum 999
- ID3 tag v2.0 or later
- File name in Unicode UTF8 (maximum length: 128 bytes)

### Unsupported formats:

- Empty albums: an empty album is an album that does not contain MP3/ WMA files, and will not be shown in the display.
- Unsupported file formats are skipped. For example, Word documents (.doc) or MP3 files with extension .dlf are ignored and not played.
- AAC, WAV, PCM audio files
- DRM protected WMA files (.wav, .m4a, .m4p, .mp4, .aac)
- WMA files in Lossless format

- Supported sampling frequencies: 32 kHz, 44.1kHz, 48 kHz
- Supported Bit-rates: 32~320 (kbps), variable bit rates
- ID3 tag v2.0 or later

## Maintenance

### Clean the cabinet

- Use a soft cloth slightly moistened with a mild detergent solution. Do not use a solution containing alcohol, spirits, ammonia or abrasives.

### Clean discs

- When a disc becomes dirty, clean it with a cleaning cloth. Wipe the disc from the centre out.

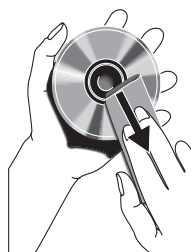

- Do not use solvents such as benzene, thinner, commercially available cleaners, or antistatic spray intended for analogue records.

### Clean the disc lens

- After prolonged use, dirt or dust may accumulate at the disc lens. To ensure good play quality, clean the disc lens with Philips CD lens cleaner or any commercially available cleaner. Follow the instructions supplied with cleaner.

## Supported MP3 disc formats

- ISO9660, Joliet
- Maximum title number: 511 (depending on file name length)
- Maximum album number: 511



# 9 Troubleshooting



## Warning

- Never remove the casing of this apparatus.

To keep the warranty valid, never try to repair the system yourself.

If you encounter problems when using this apparatus, check the following points before requesting service. If the problem remains unsolved, go to the Philips web site ([www.philips.com/welcome](http://www.philips.com/welcome)). When you contact Philips, ensure that the apparatus is nearby and the model number and serial number are available.

### No power

- Ensure that the AC power plug of the unit is connected properly.
- Ensure that there is power at the AC outlet.
- To save power, the system switches off automatically 15 minutes after track play reaches the end and no control is operated.

### No sound or poor sound

- Adjust the volume.
- Check that the speakers are connected correctly.
- Check if the stripped speaker wires are clamped.

### No response from the Hi-Fi system

- Disconnect and reconnect the AC power plug, then turn on the system again.
- As a power-saving feature, the unit switches off automatically 15 minutes after track play reaches the end and no control is operated.

### Remote control does not work

- Before you press any function button, first select the correct source with the remote control instead of the main unit.
- Reduce the distance between the remote control and the unit.

- Insert the battery with its polarities (+/- signs) aligned as indicated.
- Replace the battery.
- Aim the remote control directly at the sensor on the front of the unit.

### No disc detected

- Insert a disc.
- Check if the disc is inserted upside down.
- Wait until the moisture condensation at the lens has cleared.
- Replace or clean the disc.
- Use a finalized CD or correct format disc.

### Poor radio reception

- Increase the distance between the unit and your TV or VCR.
- Fully extend the FM antenna.

### Alarm does not work

- Set the clock/alarm correctly.

### Clock/alarm setting erased

- Power has been interrupted or the power plug has been disconnected.
- Reset the clock/alarm.

### USB device not supported

- The USB device is incompatible with the unit. Try another one.

# 10 Notice

Any changes or modifications made to this device that are not expressly approved by Philips Consumer Lifestyle may void the user's authority to operate the equipment.

## Note

- The type plate is located on the bottom of the apparatus.

## Be responsible Respect copyrights

The making of unauthorized copies of copy-protected material, including computer programs, files, broadcasts and sound recordings, may be an infringement of copyrights and constitute a criminal offence. This equipment should not be used for such purposes.



Your product is designed and manufactured with high quality materials and components, which can be recycled and reused.



When this crossed-out wheeled bin symbol is attached to a product it means that the product is covered by the European Directive 2002/96/EC.

Please inform yourself about the local separate collection system for electrical and electronic products.

Please act according to your local rules and do not dispose of your old products with your normal household waste. Correct disposal of your old product helps to prevent potential

negative consequences for the environment and human health.



Your product contains batteries covered by the European Directive 2006/66/EC, which cannot be disposed with normal household waste. Please inform yourself about the local rules on separate collection of batteries because correct disposal helps to prevent negative consequences for the environmental and human health.

### Environmental information

All unnecessary packaging has been omitted. We have tried to make the packaging easy to separate into three materials: cardboard (box), polystyrene foam (buffer) and polyethylene (bags, protective foam sheet.) Your system consists of materials which can be recycled and reused if disassembled by a specialized company. Please observe the local regulations regarding the disposal of packaging materials, exhausted batteries and old equipment.



Windows Media and the Windows logo are trademarks, or registered trademarks of Microsoft Corporation in the United States and/or other countries.

**This apparatus includes this label:**



2011 © Koninklijke Philips Electronics N.V. All rights reserved.

Specifications are subject to change without notice. Trademarks are the property of Koninklijke Philips Electronics N.V. or their respective owners. Philips reserves the right

to change products at any time without being obliged to adjust earlier supplies accordingly.

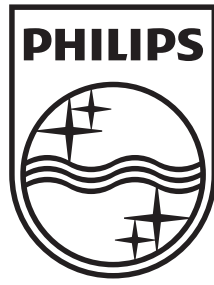

© 2011 Koninklijke Philips Electronics N.V.

All rights reserved.

FWM211X\_77\_UM\_V1.0