

Register your product and get support at  
[www.philips.com/welcome](http://www.philips.com/welcome)

MCM7000



---

EN	User manual	3
FR	Mode d'emploi	21
ES	Manual del usuario	41
DE	Benutzerhandbuch	61

---

---

NL	Gebruiksaanwijzing	81
IT	Manuale utente	101
PT	Manual do utilizador	121
SV	Användarhandbok	141

---

# PHILIPS

# DEMO MODE

To turn ON

Press



button

(in standby mode)

To turn OFF

Press



button

(in standby mode)

# Contents

<b>1</b>	<b>Important</b>	4	<b>6</b>	<b>Other features</b>	16
	Safety	4		Set alarm timer	16
	Notice	6		Set the sleep timer	16
				Listen to external audio device	16
				Listen through headphone	16
<b>2</b>	<b>Your Micro Hi-Fi System</b>	7	<b>7</b>	<b>Product information</b>	17
	Introduction	7		Specifications	17
	What's in the box	7		USB playability information	18
	Product overview	8		Supported MP3 disc formats	18
<b>3</b>	<b>Get started</b>	10	<b>8</b>	<b>Troubleshooting</b>	18
	Connect speakers	10			
	Connect FM antenna	11			
	Connect power	11			
	Prepare the remote control	11			
	Set clock	12			
	Demonstrate the unit's features	12			
	Adjust brightness of display panel	12			
	Turn on or off LED light	12			
	Turn on	12			
	Switch to standby mode	12			
<b>4</b>	<b>Play</b>	13			
	Basic play operations	13			
	Play from disc	13			
	Play from USB	13			
	Adjust sound	14			
<b>5</b>	<b>Listen to FM radio</b>	14			
	Plug and play installation	14			
	Tune to FM radio stations	14			
	Program radio stations automatically	15			
	Program radio stations manually	15			
	Tune to a preset radio station	15			
	Show RDS information	15			

# 1 Important

## Safety

Know these safety symbols

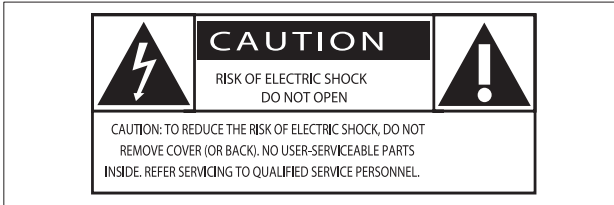

This 'bolt of lightning' indicates uninsulated material within your unit may cause an electrical shock. For the safety of everyone in your household, please do not remove product covering.

The 'exclamation mark' calls attention to features for which you should read the enclosed literature closely to prevent operating and maintenance problems.

**WARNING:** To reduce the risk of fire or electric shock, this apparatus should not be exposed to rain or moisture and objects filled with liquids, such as vases, should not be placed on this apparatus.

**CAUTION:** To prevent electric shock, fully insert the plug. (For regions with polarized plugs: To prevent electric shock, match wide blade to wide slot.)

## Important Safety Instructions

- ① Read these instructions.
- ② Keep these instructions.
- ③ Heed all warnings.
- ④ Follow all instructions.
- ⑤ Do not use this apparatus near water.
- ⑥ Clean only with dry cloth.
- ⑦ Do not block any ventilation openings. Install in accordance with the manufacturer's instructions.

- ⑧ Do not install near any heat sources such as radiators, heat registers, stoves, or other apparatus (including amplifiers) that produce heat.
- ⑨ Protect the power cord from being walked on or pinched, particularly at plugs, convenience receptacles, and the point where they exit from the apparatus.
- ⑩ Only use attachments/accessories specified by the manufacturer.
- ⑪ Use only with the cart, stand, tripod, bracket, or table specified by the manufacturer or sold with the apparatus. When a cart is used, use caution when moving the cart/apparatus combination to avoid injury from tip-over.



- ⑫ Unplug this apparatus during lightning storms or when unused for long periods of time.
- ⑬ Refer all servicing to qualified service personnel. Servicing is required when the apparatus has been damaged in any way, such as power-supply cord or plug is damaged, liquid has been spilled or objects have fallen into the apparatus, the apparatus has been exposed to rain or moisture, does not operate normally, or has been dropped.
- ⑭ Battery usage **CAUTION** – To prevent battery leakage which may result in bodily injury, property damage, or damage to the unit:
  - Install all batteries correctly, + and - as marked on the unit.
  - Do not mix batteries (old and new or carbon and alkaline, etc.).

- Remove batteries when the unit is not used for a long time.
- Batteries (battery pack or batteries installed) shall not be exposed to excessive heat such as sunshine, fire or the like.

- ⑮ **Apparatus shall not be exposed to dripping or splashing.**
- ⑯ **Do not place any sources of danger on the apparatus (e.g. liquid filled objects, lighted candles).**
- ⑰ **Where the MAINS plug or an appliance coupler is used as the disconnect device, the disconnect device shall remain readily operable.**



### Warning

- Never remove the casing of this apparatus.
- Never lubricate any part of this apparatus.
- Never place this apparatus on other electrical equipment.
- Keep this apparatus away from direct sunlight, naked flames or heat.
- Never look into the laser beam inside the apparatus.
- Ensure that you always have easy access to the power cord, plug or adaptor to disconnect the apparatus from the power.



### Caution

- Use of controls or adjustments or performance of procedures other than herein may result in hazardous radiation exposure or other unsafe operation.

## Hearing safety

### Listen at a moderate volume.

- Using headphones at a high volume can impair your hearing. This product can produce sounds in decibel ranges that may cause hearing loss for a normal person, even for exposure less than a minute. The higher decibel ranges are offered for those that may have already experienced some hearing loss.
- Sound can be deceiving. Over time your hearing 'comfort level' adapts to higher volumes of sound. So after prolonged listening, what sounds 'normal' can actually be loud and harmful to your hearing. To guard against this, set your volume to a safe level before your hearing adapts and leave it there.

### To establish a safe volume level:

- Set your volume control at a low setting.
- Slowly increase the sound until you can hear it comfortably and clearly, without distortion.

### Listen for reasonable periods of time:

- Prolonged exposure to sound, even at normally 'safe' levels, can also cause hearing loss.
- Be sure to use your equipment reasonably and take appropriate breaks.

### Be sure to observe the following guidelines when using your headphones.

- Listen at reasonable volumes for reasonable periods of time.
- Be careful not to adjust the volume as your hearing adapts.
- Do not turn up the volume so high that you can't hear what's around you.
- You should use caution or temporarily discontinue use in potentially hazardous situations. Do not use headphones while operating a motorized vehicle, cycling, skateboarding, etc.; it may create a traffic hazard and is illegal in many areas.

---

## Notice

Any changes or modifications made to this device that are not expressly approved by Philips Consumer Lifestyle may void the user's authority to operate the equipment.



This product complies with the radio interference requirements of the European Community.



Your product is designed and manufactured with high quality materials and components, which can be recycled and reused.



When this crossed-out wheeled bin symbol is attached to a product it means that the product is covered by the European Directive 2002/96/EC.

Please inform yourself about the local separate collection system for electrical and electronic products.

Please act according to your local rules and do not dispose of your old products with your normal household waste. Correct disposal of your old product helps to prevent potential negative consequences for the environment and human health.



Your product contains batteries covered by the European Directive 2006/66/EC, which cannot be disposed with normal household waste. Please inform yourself about the local rules on separate collection of batteries because correct disposal helps to prevent negative consequences for the environmental and human health.

## Environmental information

All unnecessary packaging has been omitted. We have tried to make the packaging easy to separate into three materials: cardboard (box), polystyrene foam (buffer) and polyethylene (bags, protective foam sheet.)

Your system consists of materials which can be recycled and reused if disassembled by a specialized company. Please observe the local regulations regarding the disposal of packaging materials, exhausted batteries and old equipment.



**Be responsible  
Respect copyrights**

The making of unauthorized copies of copy-protected material, including computer programs, files, broadcasts and sound recordings, may be an infringement of copyrights and constitute a criminal offence. This equipment should not be used for such purposes.

**This apparatus includes this label:**



**Class II equipment symbol**



This symbol indicates that the unit has a double insulation system.



### Note

- The type plate is located at the rear of the apparatus.

## 2 Your Micro Hi-Fi System

Congratulations on your purchase, and welcome to Philips! To fully benefit from the support that Philips offers, register your product at [www.Philips.com/welcome](http://www.Philips.com/welcome).

### Introduction

**With this unit, you can:**

- enjoy audio from discs, USB storage devices, and other external devices
- listen to radio stations

**You can enrich sound output with these sound effects:**

- treble & bass control
- loudness control

**The unit supports these media formats:**



### What's in the box

Check and identify the contents of your package:

- Main unit
- 2 speakers
- Remote control
- 2 AAA batteries
- AC power cord
- 2 speaker wires
- MP3-LINK cable
- FM antenna
- User manual

# Product overview

## Main unit

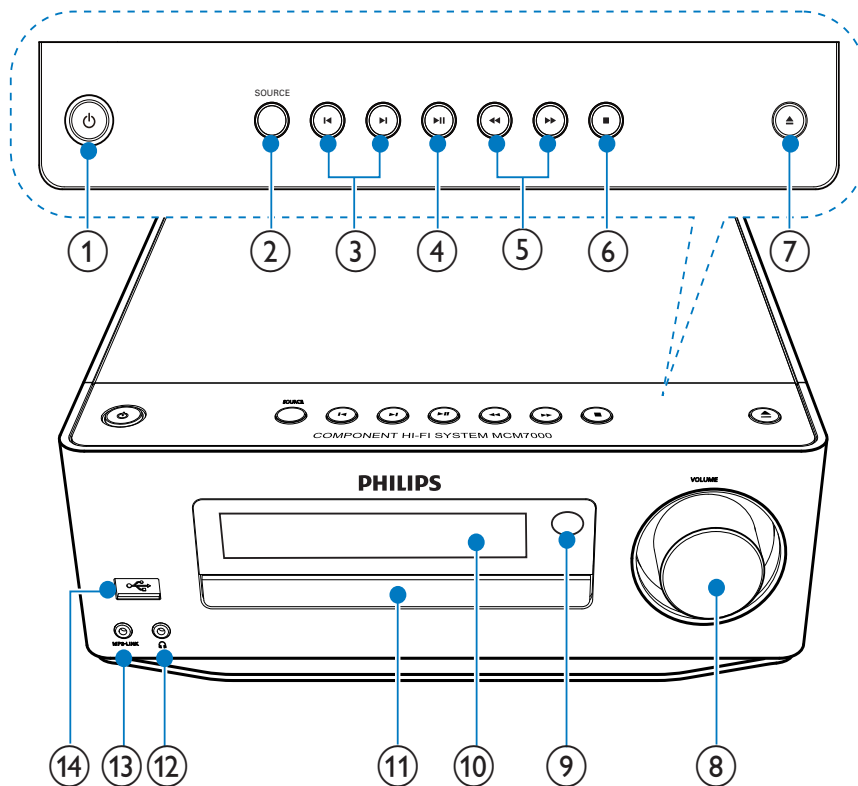



- ① **Power**
  - Switch to ECO Power or standby mode.
- ② **SOURCE**
  - Select a source.
- ③ **Previous track**
  - Skip to the previous/next track.
  - Skip to a preset station.
- ④ **Play/Pause**
  - Start or pause play.
- ⑤ **Next track**
  - Search backward or forward.
  - Search to a radio station.
- ⑥ **Stop**
  - Stop play.
  - Erase a program.
  - (In standby mode) Turn on/off Demo mode.
- ⑦ **Disc compartment**
  - Open or close the disc compartment.
- ⑧ **VOLUME**
  - Adjust volume.
  - Adjust time.
- ⑨ **IR sensor**
  - Detect signals from the remote control. Always point the remote control at the IR sensor.
- ⑩ **Display panel**
  - Display information about current source.
- ⑪ **Disc compartment**
  - Hold the disc.
- ⑫ **Headphone socket**
  - Headphone socket.





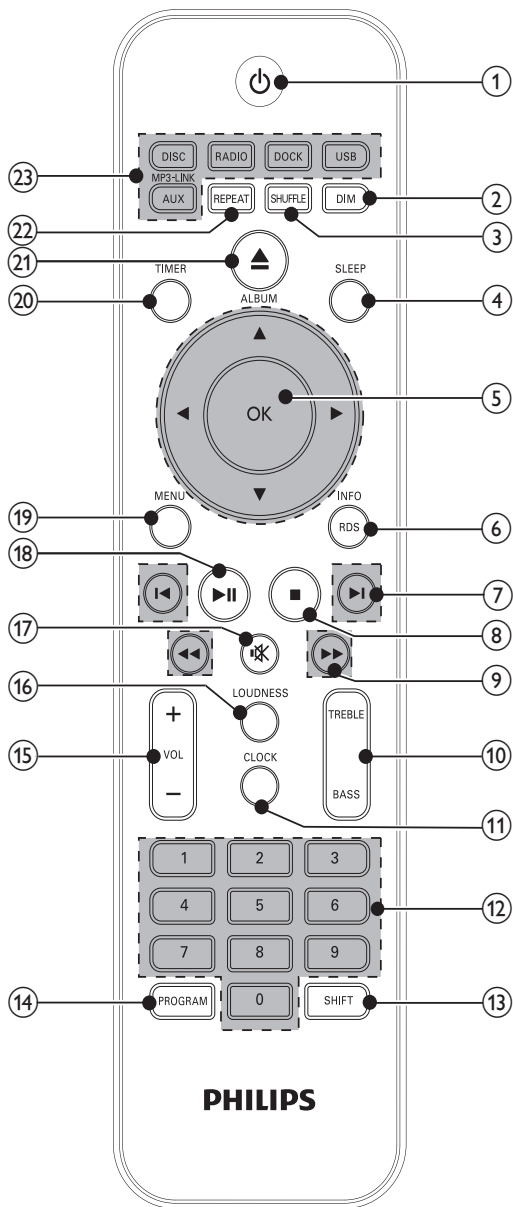

- ⑬ **MP3 LINK**
  - Connect to an external audio device.
- ⑭ 
  - Connect to a USB flash drive.

## Remote control



- ① 
  - Switch to ECO Power or standby mode.
- ② **DIM**
  - Adjust brightness of display panel.
  - (Press and hold) Turn on or off the LED light at the bottom of the unit and at the volume knob.

- ③ **SHUFFLE**
  - Play tracks randomly.
- ④ **SLEEP**
  - Set the sleep timer.
- ⑤ 
  - Navigate through menu.
  - **ALBUM/▲▼**: Skip to previous/next album.
- OK**
  - Confirm an entry or selection.
  - Select FM stereo or mono.
- ⑥ **RDS/INFO**
  - For selected FM radio stations: display RDS information.
  - Display the current status or the disc information.
  - Display the ID3 information (if available) of MP3 tracks.
- ⑦ 
  - Skip to the previous next track or radio station.
- ⑧ 
  - Stop play.
  - Erase a program.
  - (In standby mode) Turn on/off Demo mode.
- ⑨ 
  - search backwards or forward.
  - Search to a radio station.
- ⑩ **TREBLE / BASS**
  - Activate treble/bass adjustment.
- ⑪ **CLOCK**
  - Set the clock.
  - Display the set clock.
- ⑫ **Numeric keypad.**
  - Select a track directly.
- ⑬ **SHIFT**
  - Enter a two or three-digit number (with the numeric keypad).

- ⑭ **PROGRAM**
  - Program radio stations.
  - Program tracks.
- ⑮ **VOL +/-**
  - Adjust volume.
  - Adjust time.
- ⑯ **LOUDNESS**
  - Turn on or off automatic loudness adjustment.
- ⑰ **⊘**
  - Mute or restore volume.
- ⑱ **▶||**
  - Start or pause play.
- ⑲ **MENU**
  - Access menu.
  - This button is not workable for this model.
- ⑳ **TIMER**
  - Set alarm timer.
- ㉑ **▲**
  - Open or close the disc compartment.
- ㉒ **REPEAT**
  - Select a repeat play mode.
- ㉓ **Source buttons**
  - Select a source.
  - DOCK source is not available for this unit.

## 3 Get started

### ! Caution

- Use of controls or adjustments or performance of procedures other than herein may result in hazardous radiation exposure or other unsafe operation.

Always follow the instructions in this chapter in sequence.

If you contact Philips, you will be asked for the model and serial number of this apparatus. The model number and serial number are on the back of the apparatus. Write the numbers here:

Model No. \_\_\_\_\_

Serial No. \_\_\_\_\_

## Connect speakers

### ≡ Note

- Ensure that the colors of the speaker wires and terminals are matched.
- For optimal sound, use the supplied speakers only.
- Connect only speakers with impedance that is the same or higher than the supplied speakers. Refer to the Specifications section of this manual.

### For the main unit side:

Connect the speaker wires and the main unit as the following graphic indicates:

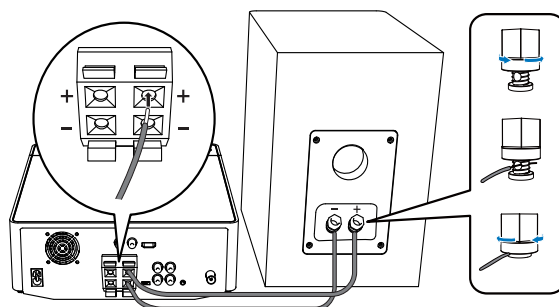

**For the speaker side:**

- 1 Unscrew the speaker connectors.
- 2 For the left speaker, identify the speaker cable that is connected to the left connectors on the main unit.
- 3 Insert fully the red end of the speaker cable into the red (+) connector.
- 4 Screw the red (+) connector to secure the cable.
- 5 Insert fully the silver end of the speaker cable into the black (-) connector.
- 6 Screw the black (-) connector to secure the cable.
- 7 Repeat steps 2-6 for the right speaker.

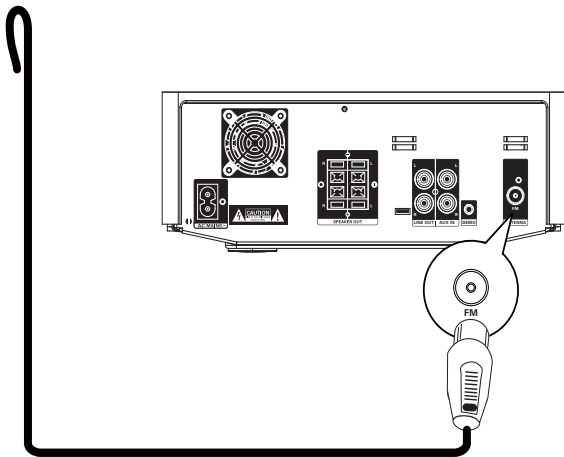
**Connect FM antenna**
 **Tip**

- For optimal reception, fully extend and adjust the position of the antenna.
- For better FM stereo reception, connect an outdoor FM antenna to the **FM ANTENNA** socket.
- The unit does not support MW radio reception.

- 1 Connect the supplied FM antenna to the **FM ANTENNA** socket on the main unit.

**Connect power**
 **Caution**

- Risk of product damage! Ensure that the power supply voltage corresponds to the voltage printed on the back or the underside of the unit.
- Risk of electric shock! When you unplug the AC power cord, always pull the plug from the socket. Never pull the power cord.
- Before you connect the AC power cord, ensure that you have completed all other connections.

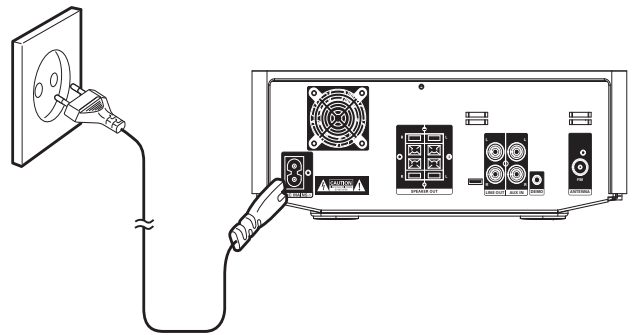

- 1 Connect the power cord to:
  - the **AC~** socket on the main unit.
  - the power outlet.

**Prepare the remote control**
 **Caution**

- Risk of explosion! Keep batteries away from heat, sunshine, or fire. Never discard batteries in fire.

**To insert the remote control battery:**

- 1 Open the battery compartment.
- 2 Insert 2 AAA batteries with correct polarity (+/-) as indicated.
- 3 Close the battery compartment.

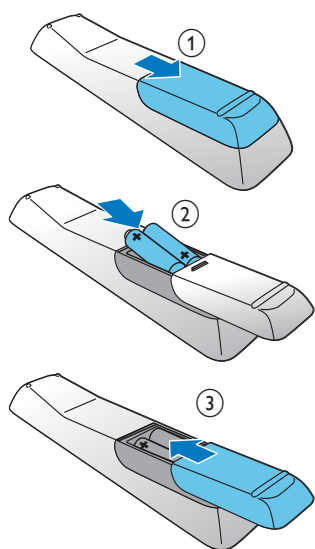

### Note

- If you are not going to use the remote control for a long time, remove the batteries.
- Do not use old and new or different types of batteries in combination.
- Batteries contain chemical substances, so they should be disposed of properly.

## Set clock

- 1 In standby mode, press **CLOCK** for three seconds to activate clock setting mode.
  - ↳ **[CLOCK SET]** scrolls on the display, then the time format **[24H]** or **[12H]** is displayed.
- 2 Press **VOL +/-** to select 24H or 12H, then press **CLOCK** to confirm.
  - ↳ The hour digits begin to blink.
- 3 Press **VOL +/-** to set hour, then press **CLOCK** again.
  - ↳ The minute digits begin to blink.
- 4 Press **VOL +/-** to set minute.
- 5 Press **CLOCK** to confirm the clock setting.

### Note

- If no button is pressed in 90 seconds, the system exits clock setting mode automatically.

## Demonstrate the unit's features

- 1 In the standby mode, press **■** until "DEMO ON" is displayed.
  - ↳ Available features are displayed one by one.
  - To turn off the demonstration, press **■** again.

## Adjust brightness of display panel

Press **DIM** repeatedly to select different brightness levels.

## Turn on or off LED light

- 1 In power-on mode, press and hold **DIM** to turn on or off the LED light at the bottom of the unit and at the volume knob.

## Turn on

- 1 Press **⏻**.
  - ↳ The unit switches to the last selected source.

## Switch to standby mode

To switch the system to Eco Power Standby mode:

- In standby mode, press and hold **⏻** for 2 seconds.
- ↳ **[ECO POWER]** (Eco power) scrolls on the display, then the backlight turns off.

# 4 Play

## Basic play operations

You can control play through following operations.

Key	Function
◀◀/▶▶	Press and hold to fast-forward/fast-reverse the track during playback, then release to resume play.
▶	To pause/resume play during playback.
INFO	Select different play information.
REPEAT	To select a repeat play mode: [REP] (repeat): play current track repeatedly. [REP ALL] (repeat all): play all tracks repeatedly. Press again to return to normal play.
SHUFFLE	To play tracks randomly. Press again to return to normal play.

## Play from disc

- 1 Press **DISC** to select the CD source.
- 2 Press **▲**.  
↳ The disc compartment opens.
- 3 Place a disc with the printed side facing up, then press **▲**.
- 4 The unit starts to play automatically.
  - If the play does not start, press **◀◀/▶▶** to select a track, then press **▶||**.

## Play from USB

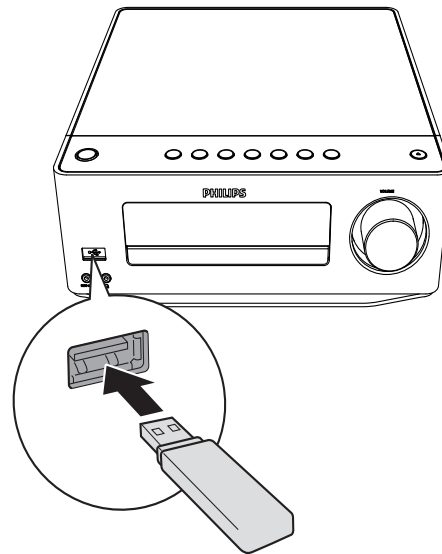

### Warning

- Make sure that the USB storage device contains playable audio contents for supported formats.

- 1 Flip open the cover marked **↔** on the front panel.
- 2 Insert the USB storage device into the USB socket.
- 3 Press **USB** to select the USB source.  
↳ Play starts automatically. If not, press **ALBUM/▲▼** to select a folder and **◀◀/▶▶** to select a file. System starts to play automatically.

---

## Adjust sound

During play, you can change volume through following operations.

Key	Function
<b>VOL +/-</b>	To increase/decrease the volume.
<b>⊘</b>	To mute/restore sound.
<b>LOUDNESS</b>	To turn on/off automatic loudness control.
<b>BASS</b>	To activate bass, press <b>BASS</b> and then change the bass level with <b>VOL +/-</b> .
<b>TREBLE</b>	To activate treble, press <b>TREBLE</b> and then change the treble level with <b>VOL +/-</b> .

---

## 5 Listen to FM radio

---

### Plug and play installation

When the unit turn to radio mode, and no radio stations are stored, [**AUTO INSTALL -- PRESS PLAY -- STOP CANCEL**] (to auto install, press **▶||**; to cancel, press **■**) displays.

- 1 Press **▶||** on the main unit to start installation.
  - ↳ The unit automatically stores radio stations with sufficient signal strength.
  - ↳ When all the available radio stations are stored, the first preset radio station broadcasts automatically.
- 2 To exit plug and play installation mode, press source keys or **⏻** on the remote control.
  - ↳ The system switches to the designated source mode or standby mode.

---

### Tune to FM radio stations



#### Warning

- Make sure that you have connected and fully extended the supplied FM antenna.

- 1 Press **RADIO**.
- 2 Press and hold **◀◀/▶▶** to search a radio station.
- 3 When the frequency starts to change, release the button.
  - ↳ The unit automatically stores radio stations with sufficient signal strength.
- 4 Repeat steps 2-3 to tune to more stations.

#### To tune to a weak station:

Press **◀◀/▶▶** repeatedly until you find the optimal reception.

 Note

- **[STEREO]** is default setting for tuner mode.

 Tip

- Under tuner mode, you can press **OK** repeatedly to toggle between **[STEREO]** and **[MONO]**, and the unit memorizes your setting even if you turn off the unit or turn to other sources.

## Program radio stations automatically

 Note

- You can program a maximum of 20 preset radio stations.

- 1 In tuner mode, press and hold **PROGRAM** for two seconds to activate automatic program mode.
  - ↳ **[AUTO]** (auto) is displayed and begins to blink.
  - ↳ The unit automatically stores radio stations with sufficient signal strength.
  - ↳ The first programmed radio station broadcasts automatically.

## Program radio stations manually

 Note

- You can program a maximum of 20 preset radio stations.

- 1 Tune to a radio station.
- 2 Press **PROGRAM** to activate programming.
- 3 Press **◀▶** to allocate a number from 1 to 20 to this radio station, then press **PROGRAM** to confirm.
  - ↳ The preset number and the frequency of the preset station are displayed.

- 4 Repeat the previous steps to program other stations.

 Note

- To overwrite a programmed station, store another station in its place.

## Tune to a preset radio station

- 1 Press **◀▶** to select a preset number that you want.

## Show RDS information

RDS (Radio Data System) is a service that allows FM stations to show additional information. If you tune to a RDS station, a RDS icon and the station name are displayed.

- 1 Tune to a RDS station.
- 2 Press repeatedly to scroll through the following information (if available):
  - ↳ Station name
  - ↳ Program type such as **[NEWS]** (news), **[SPORT]** (sport), **[POP M]** (pop music)...
  - ↳ RDS clock
  - ↳ Frequency

## Synchronize clock with RDS

You can synchronize time shown on the unit with that on the RDS station.

- 1 Tune to a RDS radio station that transmits time signals.
- 2 Press **RDS** for over 2 seconds.
  - ↳ **[CT SYNC]** is displayed and the unit reads RDS time automatically.
  - ↳ If no time signal is received, **[NO CT]** is displayed.

 Note

- The accuracy of the transmitted time depends on the RDS station that transmits the time signal.

# 6 Other features

## Set alarm timer

This unit can be used as an alarm clock. You can select CD, FM or USB as alarm source.

### Note

- Make sure that you have set the clock correctly.

- 1 In standby mode, press and hold **TIMER** until **[TIMER SET]** scrolls on the display.
- 2 Press source buttons on the remote control to select a source: CD/MP3, TUNER, USB.
- 3 Press **TIMER** to confirm.  
↳ The hour digits are displayed and begin to blink.
- 4 Press **VOL +/-** repeatedly to set hour, then press **TIMER** again to confirm.  
↳ The minute digits are displayed and begin to blink.
- 5 Press **VOL +/-** to set minute, then press **TIMER** to confirm.  
↳ **VOL** (volume) is displayed and begins to blink.
- 6 Press **VOL +/-** to adjust volume, then press **TIMER** to confirm.

## Activate/deactivate alarm timer

- 1 In standby mode, press **TIMER** repeatedly to activate or deactivate timer.  
↳ If timer is activated,  is displayed.

### Tip

- Alarm timer is not available in MP3 LINK mode.
- If CD/USB source is selected, yet no disc is placed or no USB connected, the system switches to the tuner source automatically.

## Set the sleep timer

This unit can switch to standby automatically after a set period of time.

- 1 When the unit is turned on, press **SLEEP** repeatedly to select a set period of time (in minutes).  
↳ When sleep timer is activated, the display shows **zzz**.

### To deactivate sleep timer

- 1 Press **SLEEP** repeatedly until "SLEEP OFF" is displayed.  
↳ When sleep timer is deactivated, **zzz** disappears on the display.

## Listen to external audio device

You can listen to an external audio device such as MP3 player through this unit.

- 1 Connect the audio device.
  - For audio device with red/white audio output sockets: Connect a red/white audio cable (not supplied) to the **AUX IN** sockets and to the audio output sockets on the audio device.
  - For audio device with headphone sockets: Connect the supplied MP3 Link cable to the **MP3 LINK** socket and to the headphone socket on the audio device.
- 2 Select **MP3 LINK/AUX** source.
- 3 Play the device.

## Listen through headphone

- 1 Plug a headphone into the  socket on the unit.



# 7 Product information

## Note

- Product information is subject to change without prior notice.

## Specifications

### Amplifier

Rated Output Power	2 X 30 W RMS
Frequency Response	20-20000 Hz, $\pm 3$ dB
Signal to Noise Ratio	>82 dBA
Aux Input	1000 mV RMS 22k ohm

### Disc

Laser Type	Semiconductor
Disc Diameter	12 cm/8 cm
Support Disc	CD-DA, CD-R, CD-RW, MP3-CD, WMA-CD
Audio DAC	24Bits / 44.1 kHz
Total Harmonic Distortion	<0.8% (1 kHz)
Frequency Response	4 Hz - 20 kHz (44.1 kHz)
S/N Ratio	>82 dBA

## Tuner-Specs

Tuning Range	FM: 87.5 - 108 MHz
Tuning grid	50KHz
- Mono, 26 dB S/N Ratio	<22 dBf
- Stereo, 46 dB S/N Ratio	<43 dBf
Search Sensitivity	<28 dBf
Total Harmonic Distortion	<2%
Signal to Noise Ratio	>55 dB

## Speakers

Speaker Impedance	4 ohm
Speaker Driver	13 cm woofer + 2.5 cm Dome tweeter
Sensitivity	>86 dB/m/W $\pm$ 4dB/m/W

## General information

AC power	220-240 V, 50/60 Hz
Operation Power Consumption	30 W
Headphone output	2X15 mW 32 ohm
USB Direct	version 2.0 FS
Dimensions	
- Main Unit (W x H x D)	250 x 92 x 285 mm
- Speaker Box (W x H x D)	174 x 260 x 240 mm
Weight	
- With Packaging	10 kg
- Main Unit	2.5 kg
- Speaker Box	6.1 kg

---

## USB playability information

### Supported USB storage devices:

- USB flash memory (USB 2.0)

### Supported formats

- MP3 (bit rates 32-320 kbps)
- WMA (bit rates 32-320 kbps)
- MP3 ID3 tag (Ver 2.0)
- WMA ID3 tag

### Unsupported formats:

- Empty albums: an empty album is an album that does not contain MP3/WMA files, and is not shown in the display.
- Unsupported file formats are skipped. For example, Word documents (.doc) or MP3 files with extension .dlf are ignored and not played.
- Video and photo files.
- AAC, WAV, PCM audio files
- DRM protected WMA files (.wav, .m4a, .m4p, .mp4, .aac)
- WMA files in Lossless format

---

## Supported MP3 disc formats

- ISO9660, Joliet
- Maximum title number: 512 (depending on file name length)
- Maximum album number: 255
- Supported sampling frequencies: 32 kHz, 44.1kHz, 48 kHz
- Supported Bit-rates: 32~320 (kbps), variable bit rates

# 8 Troubleshooting



### Warning

- Never remove the casing of this apparatus.

To keep the warranty valid, never try to repair the system yourself.

If you encounter problems when using this apparatus, check the following points before requesting service. If the problem remains unsolved, go to the Philips web site ([www.philips.com/welcome](http://www.philips.com/welcome)). When you contact Philips, ensure that the apparatus is nearby and the model number and serial number are available.

### No power

- Ensure that the AC power cord of the unit is connected properly.
- Ensure that there is power at the AC outlet.
- As a power-saving feature, the system switches off automatically 15 minutes after track play reaches the end and no control is operated.

### No sound or poor sound

- Adjust the volume.
- Disconnect the headphones.
- Check that the speakers are connected correctly.
- Check if the stripped speaker wires are clamped.

### No response from the unit

- Disconnect and reconnect the AC power plug, then turn on the unit again.
- As a power-saving feature, the system switches off automatically 15 minutes after track play reaches the end and no control is operated.

### Remote control does not work

- Before you press any function button, first select the correct source with the remote control instead of the main unit.

- Reduce the distance between the remote control and the unit.
- Insert the battery with its polarities (+/– signs) aligned as indicated.
- Replace the battery.
- Aim the remote control directly at the sensor on the front of the unit.

**No disc detected**

- Insert a disc.
- Check if the disc is inserted upside down.
- Wait until the moisture condensation at the lens has cleared.
- Replace or clean the disc.
- Use a finalized CD or correct format disc.

**Cannot display some files in USB device**

- The number of folders or files in the USB device has exceeded a certain limit. This phenomenon is not a malfunction.
- The formats of these files are not supported.

**USB device not supported**

- The USB device is incompatible with the unit. Try another one.

**Poor radio reception**

- Increase the distance between the unit and your TV or VCR.
- Fully extend the FM antenna.
- Connect an outdoor FM antenna instead.

**Timer does not work**

- Set the clock correctly.
- Switch on the timer.

**Clock/timer setting erased**

- Power has been interrupted or the power cord has been disconnected.
- Reset the clock/timer.

