

PHILIPS

Party Speaker

5000 Series

TAX5708



User manual

Register your product and get support at:
www.philips.com/support

Contents

1	Important Safety instructions	2
	Safety	2
2	Your party speaker system	4
	What's in the box	4
	Overview of the main unit	5
3	Get started	6
	Connect power	6
	Turn on	6
4	Play audio through Bluetooth	7
	Play from Bluetooth device	7
5	Play from USB or TF card	7
	Play from a USB or TF card storage device	7
	Control play	7
6	FM radio	8
	Turn on FM radio	8
	Automatically scan	8
	Manually scan	8
7	DBB effect	8
8	Record function	8
9	TWS Function	9
	Pairing for stereo mode (TWS)	9
	TWS operation	9
10	Other features	10
	Play music from an external device	10
	Change the speaker light effect	10
11	Sing through microphone	11
	Adjust microphone volume	11
	Adjust echo	11
	Vocal fader	11
	Voice changer	11
12	Guitar in	11
	Adjust guitar volume	11
13	Product information	12
	Specifications	12
	USB and TF card playability information	12
	Maintenance	12
14	Troubleshooting	13
	About Bluetooth device	13
15	Notice	14
	Care of the environment	14
	Trademark notice	14

1 Important Safety instructions

Read and understand all instructions before you use your product. If damage is caused by failure to follow instructions, the warranty does not apply.

Safety

Know these safety symbols



This 'bolt of lightning' indicates uninsulated material within your unit may cause an electrical shock. For the safety of everyone in your household, please do not remove product covering. The 'exclamation point' calls attention to features for which you should read the enclosed literature closely to prevent operating and maintenance problems. **WARNING:** To reduce the risk of fire or electric shock, this apparatus should not be exposed to rain or moisture and objects filled with liquids, such as vases, should not be placed on this apparatus. **CAUTION:** To prevent electric shock, match wide blade of plug to wide slot, fully insert.

Warning

- Never remove the casing of this device.
- Never lubricate any part of this device.
- Never place this device on other electrical equipment.
- Keep this device away from direct sunlight, naked flames or heat.
- Never look into the laser beam inside this device.
- Ensure that you always have easy access to the power cord, plug, or adaptor to disconnect this device from the power.

- Do not use this apparatus near water.
- Install in accordance with the manufacturer's instructions.
- Do not install near any heat sources such as radiators, heat registers, stoves, or other apparatus (including amplifiers) that produce heat.

- Protect the power cord from being walked on or pinched, particularly at plugs, convenience receptacles, and the point where they exit from the apparatus.
- Only use attachments/accessories specified by the manufacturer.
- Use only with the cart, stand, tripod, bracket, or table specified by the manufacturer or sold with the apparatus.
- When a cart is used, use with caution when moving the cart/apparatus combination to avoid injury from tip-over.



- Unplug this apparatus during lightning storms or when unused for long periods of time.
- Refer all servicing to qualified service personnel. Servicing is required when the apparatus has been damaged in any way, such as power-supply cord or plug is damaged, liquid has been spilled or objects have fallen into the apparatus, the apparatus has been exposed to rain or moisture, does not operate normally, or has been dropped.
- Battery usage caution—To prevent battery leakage which may result in bodily injury, property damage, or damage to the remote control:
 - Install the battery correctly, + and - as marked on the remote control.
 - Do not mix batteries (old and new or carbon and alkaline, etc.).
 - Remove the battery when the remote control is not used for a long time.
- The battery shall not be exposed to excessive heat such as sunshine, fire or the like.
- Apparatus shall not be exposed to dripping or splashing.
- Do not place any sources of danger on apparatus (e.g. liquid filled objects, lighted candles).
- Where the mains plug or an appliance coupler is used as the disconnect device, the disconnect device shall remain readily operable.

Caution

- Use of controls or adjustments or performance of procedures other than herein may result in hazardous laser exposure or other unsafe operation.

English

FCC Information

This device complies with part 15 of the FCC Rules. Operation is subject to the following two conditions:

- This device may not cause harmful interference, and
- This device must accept any interference received, including interference that may cause undesired operation.

NOTE: This equipment has been tested and found to comply with the limits for a Class B digital device, pursuant to Part 15 of the FCC Rules. These limits are designed to provide reasonable protection against harmful interference in a residential installation. This equipment generates, uses and can radiate radio frequency energy and, if not installed and used in accordance with the instructions, may cause harmful interference to radio communications.

However, there is no guarantee that interference will not occur in a particular installation. If this equipment does cause harmful interference to radio or television reception, which can be determined by turning the equipment off and on, the user is encouraged to try to correct the interference by one or more of the following measures:

- Reorient or relocate the receiving antenna.
 - Increase the separation between the equipment and receiver.
- Connect the equipment into an outlet on a circuit different from that to which the receiver is connected.
- Consult the dealer or an experienced radio / TV technician for help.

IC-Canada: CAN ICES-003(B)/NMB-003(B)

This device contains license-exempt transmitter(s)/ receiver(s) that comply with Innovation, Science and Economic Development Canada's license-exempt RSS(s). Operation is subject to the following two conditions:

- This device may not cause interference.
- This device must accept any interference, including interference that may cause undesired operation of the device.

FCC & IC Radiation Exposure Statement

- This equipment complies with FCC and Canada radiation exposure limits set forth for an uncontrolled environment.
- This equipment should be installed and operated with minimum distance 20cm between the radiator and your body.
- This transmitter must not be co-located or operated in conjunction with any other antenna or transmitter.

WARNING

Changes or modifications to this unit not expressly approved by the party responsible for compliance could void the user's authority to operate the equipment.

Français

Informations de la FCC

Cet appareil est conforme à la partie 15 des règles de la FCC. Son fonctionnement est soumis aux deux conditions suivantes :

- ce dispositif ne peut pas causer d'interférences nuisibles et
- cet appareil doit accepter toute interférence reçue, y compris les interférences qui peuvent causer un mauvais fonctionnement.

Remarque : cet équipement a été soumis à des essais et a été déclaré conforme aux limites stipulées pour un appareil numérique de classe B, conformément aux spécifications de la partie 15 du règlement de la FCC. Ces limites ont pour but d'assurer une protection raisonnable contre le brouillage nuisible dans une installation résidentielle. Cet équipement produit, utilise et peut émettre de l'énergie en radio fréquence et, s'il n'est pas installé et utilisé conformément aux directives, il peut causer un brouillage nuisible dans les communications radio.

Cependant, il est impossible de garantir qu'aucun brouillage ne se produira dans une installation particulière. Si cet équipement cause un brouillage de la réception de radio ou de télévision, ce qu'il est possible de déterminer en éteignant puis en rallumant l'équipement, l'utilisateur est prié d'essayer de corriger le brouillage au moyen de l'une ou de plusieurs des mesures suivantes :

- Réorienter ou déplacer l'antenne de réception.
- Augmenter la distance entre l'appareil et le récepteur.
- Brancher l'appareil à une prise sur un circuit différent de celui sur lequel le récepteur est branché.
- Consulter le revendeur ou un technicien radio/TV expérimenté.

IC-Canada : CAN ICES-003(B)/NMB-003(B)

L'émetteur/récepteur exempt de licence contenu dans le présent appareil est conforme aux CNR d'Innovation, Sciences et Développement économique Canada applicables aux appareils radio exempts de licence. L'exploitation est autorisée aux deux conditions suivantes :

- L'appareil ne doit pas produire de brouillage;
- L'appareil doit accepter tout brouillage radioélectrique subi, même si le brouillage est susceptible d'en compromettre le fonctionnement.

Déclaration de la FCC et IC sur l'exposition aux rayonnements :

- Cet équipement est conforme aux limites d'exposition aux rayonnements de la FCC et du Canada établies pour un environnement non contrôlé.
- Pour rester en conformité avec les signes d'exposition aux RF, placez le produit à au moins 20 cm des personnes proches.
- Cet émetteur ne doit pas coexister ou fonctionner avec une autre antenne ou un autre émetteur.

AVERTISSEMENT

Les changements ou modifications de cet appareil non expressément approuvés par la partie responsable de la conformité pourraient annuler l'autorisation de l'utilisateur à utiliser l'équipement.

2 Your party speaker

Congratulations on your purchase, and welcome to Philips! To fully benefit from the support that Philips offers, register your product at www.philips.com/support.

What's in the box

Check and identify the contents of your package:

- Main unit x 1
- AC power cord x 1
- Quick start guide x 1
- Safety sheet x 1
- Warranty card x 1

Overview of the main unit

Top panel:

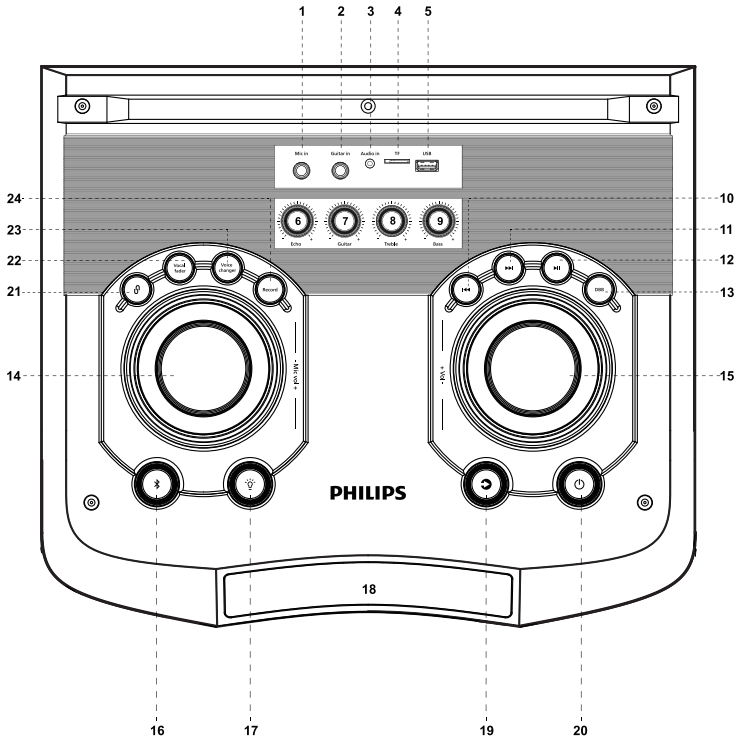

1 **MIC in:** Microphone input.

2 **Guitar in:** Guitar input.

3 **Audio in:** Connect an external device in AUX mode.

4 **TF:** TF card slot.

5 **USB:** USB port.

6 **Echo:** Adjust the amount of echo.

7 **Guitar:** Adjust the guitar volume.

8 **Treble:** Adjust the treble level.

9 **Bass:** Adjust the bass level.

10 ◀◀: In USB/TF/Bluetooth mode, press to skip to the previous track; in FM mode, press to search FM channel manually.

11 ▶▶: In USB/TF/Bluetooth mode, press to skip to the next track; in FM mode, press to search FM channel manually.

- 12 **▶||**: In USB/ TF/ Bluetooth mode, press to pause or resume play; in FM mode, long press to search and save FM channels automatically; press to select the saved channel. During recording, press to pause or resume record.
- 13 **DBB**: Press to switch between DBB1, DBB2 and DBB off.
- 14 **Mic vol**: Adjust the microphone volume in any mode.
- 15 **Vol**: Adjust the speaker volume.
- 16 **✖**: Press to switch to BT mode. Long press to disconnect from the current BT connection.
- 17 **☼**: Press to change speaker light mode 1/ 2/ 3/ 4/ 5/ Off. Long press to turn on/off strobe light.
- 18 **LED display** : Show the current status.
- 19 **🔊**: Press to select the input source between Bluetooth/ FM radio/ Aux/ USB/ TF .
- 20 **🔊**: Long press to turn on or turn off the speaker.
- 21 **🔊**: In the Bluetooth mode, long press both speakers to enter/ exit TWS mode.
- 22 **Voice fader** : Eliminate the human voice.
- 23 **Voice changer** : Change the MIC tone.
- 24 **Record** : Short press to record the microphone audio to USB or TF card; short press again to stop the recording and return to the current source. Long press to play the record content. When playing the record content, long press to delete the record content.

Overview of the main unit

Rear panel:

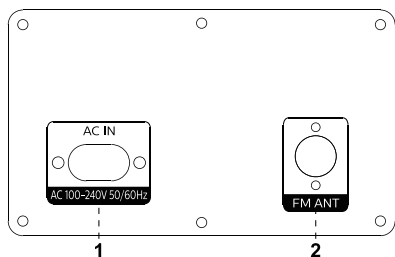

- 1 **AC IN**: Connect the AC cable to get power supply.
- 2 **FM ANT**: For FM radio.

3 Get started



Caution

- Use of controls or adjustments or performance of procedures other than herein may result in hazardous laser exposure or other unsafe operation.

Always follow the instructions in this chapter in sequence.

If you contact Philips, you will be asked for the model and serial number of this apparatus. The model number and serial number are on the back of the apparatus. Write the numbers here:

Model No. _____

Serial No. _____

Connect power



Caution

- Risk of product damage! Make sure that the power supply voltage corresponds to the voltage printed on the back or the underside of the product.
- Risk of electric shock! When you unplug the power cord, always pull the plug from the socket. Never pull the cord.



Note

- Before connecting to AC power, make sure that you have completed all other connections.

Connect the AC power cord to the AC in socket on the rear panel of the unit.

Then plug the other end of the AC power cord into a power outlet.

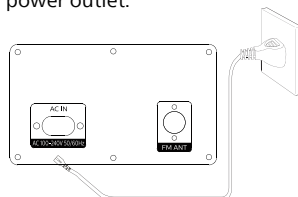





Power outlet socket and plug of power cord vary by regions.

Turn on

Long press the **🔊** button on top panel to turn on/off the speaker.

4 Play audio through Bluetooth

Play from Bluetooth device

- 1 Press  or  button on the unit to switch to Bluetooth mode. You can see "bLUE" text display on the screen and the Bluetooth logo blinks.
- 2 On the Bluetooth device, switch on Bluetooth, search for and select **[Philips TAX5708]** to start connection. You will hear the prompt sound when the connection is successful. The Bluetooth indicator keeps solid, and the speaker light constant for 2 seconds in blue.
- 3 After successful connection, play audio on the Bluetooth device.
- 4 Long press  button, the speaker will disconnect with the Bluetooth device, you can see the Bluetooth logo blinks on the screen and hear the prompt sound, and the speaker light blinks three times in blue.
- 5 To exit Bluetooth, press  to switch to another source.

Note



- Before pairing a device with this product, read it's user manual for Bluetooth compatibility.
- Any obstacle between this product and a Bluetooth device can reduce the operational range. Keep away from any other electronic device that may cause interference.
- The operational range between this product and a Bluetooth device is approximately 10 meters (30 feet).
- Before connecting another Bluetooth device, disconnect the current device firstly.
- Press and hold  button on the unit for 8 seconds to clear out the Bluetooth pairing information.
- When the Bluetooth device is beyond the valid Bluetooth distance after 3 minutes, the unit will disconnect automatically from the device and enter Bluetooth pairing mode.

5 Play from USB or TF card

Play from a USB or TF card storage device

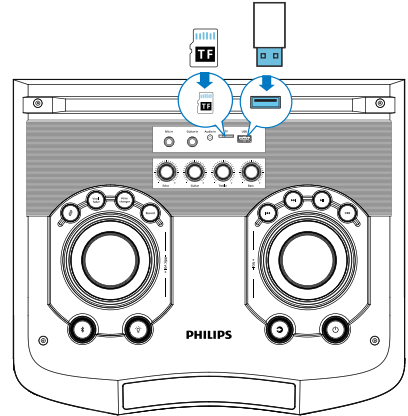

- 1 Insert the USB or TF device into the USB or TF socket, and the unit switches automatically to USB or TF play mode.



- 2 Press  /  to select an audio track.

Control play

In USB or TF mode, follow the instructions below to control play.

Button & Operate	Action
Press  / 	Skip to the previous or next track
Press 	Pause or resume play

Note



- Make sure that the USB or TF device contains playable audio contents in supported formats.
- USB supported audio formats: MP3, WAV
- TF supported audio format: MP3, WAV

6 FM radio



Turn on FM radio

Press  button to select FM mode until the display shows the FM frequency. Be sure to extend the antenna on the back of the unit to strengthen the reception effect.

Automatically scan

Long pressing  button will automatically search for FM channels. After searching finished, the searched channels will be saved automatically and the first saved channel will be broadcast. Then press the  button to select scanned channel.

Manually scan

Press the  /  button to choose the channel by manually.

7 DBB effect

Turn the speaker on and play audio, press the **DBB** button on top panel to change the speaker bass effect: DBB1/ DBB2/ DBB off.

Note

- The speaker bass effect is set to DBB2 by default.

8 Record function

The speaker can record your Microphone or Guitar audio to USB or TF device. Please note that recording is only enabled when a USB or TF device and a microphone or Guitar is attached. To begin recording, the speaker can be in either AUX, USB, TF or FM mode.

Record operation

Button & Operate	Action
Press Record	Start to record or stop recording and return to the current source
Press 	Pause or resume the recording
Long press Record	Play the record content, or delete the record content when playing the record content

Note



- In AUX mode, audio from Mic/ Guitar and AUX input will be recorded.
- In FM mode, audio from Mic/ Guitar and FM radio audio will be recorded.
- In USB or TF mode, only Mic/ Guitar input will be recorded.
- Insert your USB or TF device. The speaker will create a directory called "Rec" in which your recordings will be put.
- The record function is not available in BT mode.

9 TWS Function

Note



- TWS works only if there are two identical party speakers (Philips TAX5708).

Pairing for stereo mode (TWS)

- 1 Turn the two speakers on and they will enter Bluetooth mode automatically.
 - ↳ You can see "bLUE" text display on the screen and the Bluetooth logo blinks.
- 2 Select one speaker as master and connect it to Bluetooth.
 - ↳ You will hear the prompt sound when the connection is successful.
- 3 Long press the  button on the master speaker firstly, and then long press the  button on the other (slave) speaker. Then both speakers enter stereo pairing mode (TWS).
 - ↳ You can see both speakers display "b ON" on the screen and hear the prompt sound from both speakers, and the speaker lights blink 3 times in purple.
- 4 When TWS is connected, the master displays "bLUE" and the slave speaker displays "btbt".
 - ↳ You will hear the prompt sound from both speakers, and the speaker lights are constant for 2 seconds in purple.
- 5 To exit TWS, long press  on either speaker, then the speaker screen displays "b OF".
 - ↳ You will hear the prompt sound from both speakers, and the speaker lights blink 3 times in purple. Then both speakers exit TWS mode and return to Bluetooth mode.

TWS operation

Operation	Action
Press  button on master speaker	Change light mode on both speakers



Operation	Action
Rotate Vol knob on master speaker	Adjust volume on both speakers
Press  button on master speaker	Pause or resume play on both speakers
Press DBB button on master speaker	Change DBB setting on both speakers
Press  button on master speaker	Skip to the previous or next track on both speakers
Rotate Treble knob on master speaker	Adjust the treble level on both speakers
Rotate Bass knob on master speaker	Adjust the bass level on both speakers
Plug MIC on master speaker socket, and rotate MIC vol knob on master speaker	Adjust the MIC volume level on master speaker, the function is not available on slave speaker
Plug MIC on master speaker socket, and rotate Echo knob on master speaker	Adjust the echo level on master speaker, the function is not available on slave speaker
Plug Guitar on master speaker socket and rotate Guitar knob on master speaker	Adjust the Guitar volume level on master speaker, the function is not available on slave speaker

Note: The above operations should be conducted on the master speaker only.

When TWS is connected, the slave speaker will synchronize from master speaker of below functions.

- Light mode
- Volume
- Play/ pause
- DBB
- Previous/ next
- Treble
- Bass

Note

- In TWS connection, buttons on the slave speaker will not work except  or  button.
- Press the  button on master speaker, and the master speaker will change to another source and disconnect from TWS, while the slave speaker is still in Bluetooth mode.
- In TWS connection, the **Vocal fader/ Voice changer/ Record** functions are not available on either speaker.
- During TWS pairing mode, both speakers will return to previous state automatically after 1 minute without user operations or TWS pairing is not successful.



10 Other features

Play music from an external device

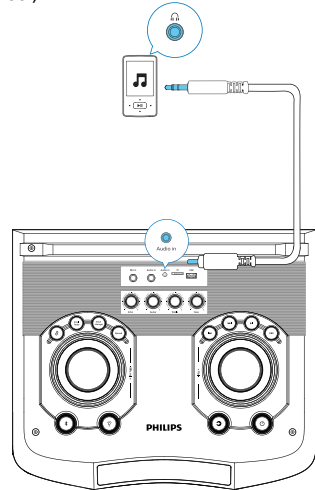
- 1 Select AUX mode: Press  button until the screen displays "AUX" text.
- 2 Connect an audio cable (not supplied) with the connector on the device:
 - The "Audio in" socket on the speaker.
 - The headphone jack on the device (MP3 player, cellphone, iPad, or other audio players).
- 3 Play audio on the device (refer to its user manual).



Change the speaker light effect

Press the  button on the top panel to change the speaker light mode: Light mode 1/ Light mode 2/ Light mode 3/ Light mode 4/ Light mode 5/ Light off. Long press the  button to turn off/ on the strobe light.

11 Sing through microphone

Adjust microphone volume

Connect a microphone (not supplied) into the **Mic in** jack of the unit, and adjust the microphone volume by rotating the **Mic vol** knob.

Adjust echo

Adjust the microphone echo level to your desired level by rotating the **Echo** knob on the top panel.

Vocal fader

Press the **Vocal fader** button on the top panel to turn the vocal fader on or off.

Voice changer

Press the **Voice changer** button on the panel to switch among different voice tones: Voice 1 / Voice 2 / Voice 3 / Voice 4 / Voice off.

12 Guitar in

Adjust guitar volume

Connect a guitar to this party speaker directly through the **Guitar in** jack on the top panel.

- 1 Use a 6.3mm (1/4") guitar connector (not supplied) to connect your guitar to the Guitar in jack.
- 2 The volume of your connected guitar can be controlled by the **Guitar** knob on the top panel.

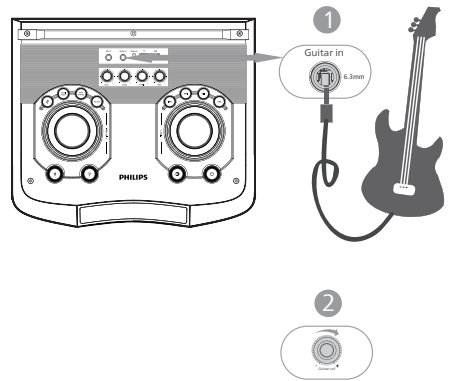

13 Product information

Specifications

Amplifier

AC output max	400W
Signal to noise ratio	≥ 80dB
Frequency response	20Hz-20KHz, -12dB
Total harmonic distortion	≤10%

Speaker

Speaker impedance	Bass 3Ω Mid 8Ω Tweeter 8Ω
Sensitivity	Bass 89 dB±3dB/m/W Mid 103 dB±3dB/m/W Tweeter 107 dB±3dB/m/W

USB

USB direct version	2.0 Full Speed
Charging support	5V 1.0A

Bluetooth

Bluetooth version	V5.0
Bluetooth frequency band	2.402 GHz ~2.480 GHz ISM Band
Bluetooth range	10m (free space)

General information

AC power	100-240V ~, 50/60 Hz
Eco standby fewer consumption	≤ 0.5W

Dimensions

Main unit (W x H x D)	420x1212x405mm
-----------------------	----------------

Weight

Main unit	27.7kg
-----------	--------

USB and TF card playability information

Compatible devices:

- USB flash memory (USB 2.0)
- USB flash players (USB 2.0)
- TF card

Supported formats:

- File formats: FAT, FAT12, FAT16, FAT32, exFAT
- Audio formats: MP3, WAV
- Maximum support 128G USB and TF Card.
(If USB or TF card is larger than 128G, the playback and record function can not be worked normally).

Maintenance

Clean the cabinet

- Use a soft cloth slightly moistened with a mild detergent solution. Do not use a solution containing alcohol, spirits, ammonia or abrasives.

14 Troubleshooting

Caution

- Never remove the casing of this unit.

To keep the Warranty valid, never try to repair the system yourself.

If you encounter problems when using this unit, check the following points before requesting service. If the problem remains unsolved, go to the Philips website (www.philips.com/support).

When you contact Philips, ensure that your unit is nearby and the model number and serial number are available.

No power

- Make sure that the AC power plug of the unit is connected properly.
 - Make sure that there is power at the AC outlet.
 - To save power, the unit switches to standby automatically 15 minutes after a play reaches the end and no control is operated.
-

No sound

- Adjust the volume.
-

No response from the unit

- Disconnect and reconnect the AC power plug, then turn on the unit again.
-

Cannot display some files in USB device

- The number of folders or files in the USB device has exceeded a certain limit. This phenomenon is not a malfunction.
 - The formats of these files are not supported.
-

USB device not supported

- The USB device is incompatible with the unit. Try another one.

About Bluetooth device

The audio quality is poor after connection with a Bluetooth-enabled device

- The Bluetooth reception is poor. Move the device closer to this product or remove any obstacle between them.

Cannot connect with the device

- The Bluetooth function of the device is not enabled. Refer to the user manual of the device for how to enable the function.
- This product is already connected with another Bluetooth-enabled device. Disconnect that device and then try again.

The paired device connects and disconnects constantly

- The Bluetooth reception is poor. Move the device closer to this product or remove any obstacle between them.
- For some devices, Bluetooth connection may be deactivated automatically as a power-saving feature. This does not indicate any malfunction of this product.

15 Notice

Any changes or modifications made to this device that are not expressly approved by MMD Hong Kong Holding Limited may void the user's authority to operate the equipment.

Care of the environment

Disposal of your old product and battery



Your product is designed and manufactured with high quality materials and components which can be recycled and reused.



This symbol on a product means that the product is covered by European Directive 2012/19/EU.



This symbol means that the product contains batteries covered by European Directive 2013/56/EU which cannot be disposed of with normal household waste. Inform yourself about the local separate collection system for electrical and electronic products and batteries. Follow local rules and never dispose of the product and batteries with normal household waste. Correct disposal of old products and batteries helps prevent negative consequences for the environment and human health.

Removing the disposable batteries

To remove the disposable batteries, see battery installation section.

Environmental information

All unnecessary packaging has been omitted. We have tried to make the packaging easy to separate into three materials: cardboard (box), polystyrene foam (buffer) and polyethylene (bags, protective foam sheet.) Your system consists of materials which can be recycled and reused if disassembled by a specialized company. Please observe the local regulations regarding the disposal of packaging materials, exhausted batteries and old equipment.

Trademark notice



The Bluetooth® word mark and logos are registered trademarks owned by Bluetooth SIG, Inc. and any use of such marks by **MMD Hong Kong Holding Limited** is under license. Other trademarks and trade names are those of their respective owners.



This is CLASS II apparatus with double insulation, and no protective earth provided.



Specifications are subject to change without notice. Please visit www.Philips.com/support for the latest updates and documents.

Philips and the Philips Shield Emblem are registered trademarks of Koninklijke Philips N.V. and are used under license.

This product has been manufactured by and is sold under the responsibility of MMD Hong Kong Holding Limited or one of its affiliates, and MMD Hong Kong Holding Limited is the warrantor in relation to this product.

