

Always there to help you

Register your product and get support at
www.philips.com/welcome



CED1900BT



User manual

PHILIPS

Contents

1	Safety	2
2	Your car entertainment system	3
	Introduction	3
	What's in the box	3
	Overview of the main unit	4
	Overview of the remote control	5
3	Install the car entertainment system	6
	Connect wires	7
	About the GPS antenna	10
	Connect the GPS antenna	10
	Install the GPS antenna	10
	Mount into the dashboard	11
4	Get started	12
	Prepare the remote control	12
	Turn on	12
	Use the home menu	13
	Set the date and time	14
	Adjust the screen brightness	14
	Switch display designs	14
5	Play from hard media	15
	Load a disc	15
	Connect a USB storage device	16
	Insert an SD/SDHC card	16
	Control play	16
	Browse recorded files	18
	About DivX® videos	18
6	Listen to radio	19
	Switch to radio mode	19
	Set up	19
	Tune to a radio station	20
	Store radio stations in memory	20
	Tune to a preset radio station	20
	Use RDS related features	21
7	Use the navigation system	22
	Insert the map data card	22
	Navigate your road trip	22
8	Use Bluetooth devices	23
	Activate the Bluetooth function	23
	Pair a device	23
	Play audio from a connected device	25
	Make a call	25
9	Play from an iPod/iPhone	28
	Compatible iPod/iPhone models	28
	Connect your iPod/iPhone	28
	Control play	28
	Charge your iPod/iPhone	29
10	Adjust sound	29
	Adjust the volume level	29
	Mute sound	29
	Enable the maximum sound	29
	Enable the DBB sound effect	29
	Enable the FullSound effect	30
	Select a preset sound equalizer	30
	Others	30
11	Adjust settings	31
	Access system setup menus	31
	Adjust general settings	32
	View system information	32
	Adjust Navigation settings	33
	Adjust Bluetooth settings	33
12	Others	34
	Play external audio/video input	34
	Use rear monitors	34
	Use buttons on the steering wheel	35
	Set the rear view camera	36
	Reset the system	36
	Replace the fuse	36
	Upgrade the firmware	36
13	Product information	37
14	Troubleshooting	39
	General	39
	About the Bluetooth device	40
15	Notice	41
	Compliance	41
	Care of the environment	41
	Trademark notice	41
	Copyright	42

1 Safety

Read and understand all instructions before you use the device. If damage is caused by failure to follow instructions, the warranty does not apply.

- Use of controls or adjustments or performance of procedures other than herein may result in hazardous radiation exposure or other unsafe operation.
- The device is designed for negative ground (earth) 12V DC operation only.
- To reduce the risk of traffic accidents, do not watch video when driving.
- To ensure safe driving, adjust the volume to a safe and comfortable level.
- Improper fuses can cause damage or fire. When you need to change the fuse, consult a professional.
- Use only the supplied mounting hardware for a safe and secure installation.
- To avoid short circuits, do not expose the device, remote control or remote control batteries to rain or water.
- The device shall not be exposed to dripping or splashing.
- Do not place any sources of danger on the device (e.g. liquid filled objects, lighted candles).
- Never insert objects into the ventilation slots or other openings on the device.
- Never place any objects other than discs into the disc tray/slot.
- To avoid exposure to laser radiation, do not disassemble the device.
- Risk of damage to the screen! Never push, rub, or strike the screen with any object.
- Never use solvents such as benzene, thinner, cleaners available commercially, or anti-static sprays intended for discs.
- Clean the device with soft, damp cloth. Never use substances such as alcohol, chemicals or household cleaners on the device.

- Risk of swallowing batteries! A coin type battery is bundled, which can be swallowed. Keep the battery out of reach of children at all times!

2 Your car entertainment system

Congratulations on your purchase, and welcome to Philips! To fully benefit from the support that Philips offers, register your product at www.philips.com/welcome.

Introduction

With the car entertainment system, you can

- listen to music,
- watch videos,
- view pictures,
- listen to FM (RDS included) and AM/MW radio,
- make phone calls via Bluetooth, and
- navigate your road trip.

What's in the box



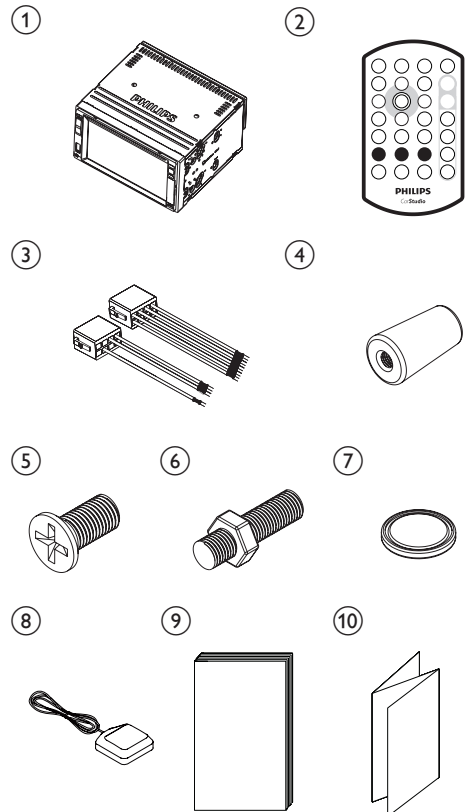

Check and identify the contents of the package:

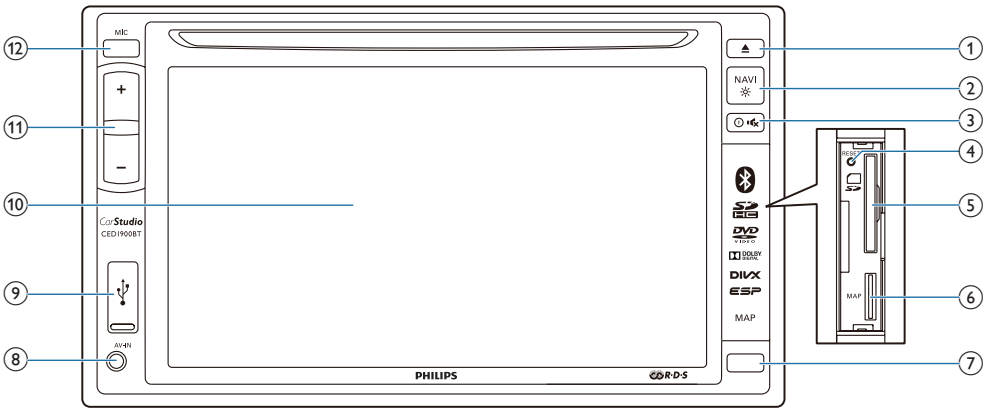

1	Main unit	2	Remote control
3	ISO male connector X 2	4	Rubber cushion
5	Screw X 4 (M5x8mm)	6	Hexagon head screw
7	Remote control battery	8	GPS smart antenna
9	User manual	10	Quick start guide

Overview of the main unit



- ① 
 - Press to eject the disc.
- ② **NAVI** 
 - Press to access the navigation system.
 - Press and hold to adjust the brightness of LCD screen.
- ③ ① 
 - Press to turn on the unit.
 - Press and hold to turn off the unit.
 - Press to mute the speakers or release them from mute status.
- ④ **RESET**
 - Press to reset the system.
- ⑤ 
 - Insert an SD/SDHC card.
- ⑥ **MAP**
 - Insert a microSD card that stores the digital map data.
- ⑦ **iR sensor**
 - The sensor that receives infra-red signals from the remote control.
- ⑧ **AV-IN**
 - Connect to the audio and video output sockets of an external player by a composite AV cable.
- ⑨ 
 - Connect to a USB storage device or iPod/iPhone.
- ⑩ **LCD screen**
- ⑪ **+/-**
 - Press to increase or decrease the volume.
- ⑫ **MIC**
 - The built-in microphone for phone calls.

Overview of the remote control

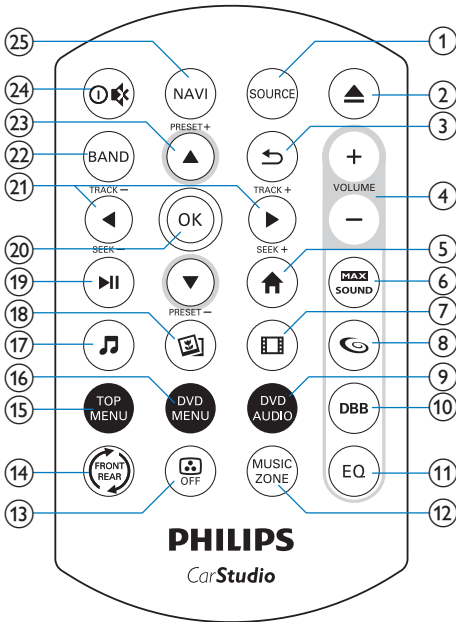

① SOURCE

- Press repeatedly to select a source.

② ▲

- Press to eject the disc.

③ ↶

- Return to the previous menu or mode.

④ VOLUME + / -

- Press to increase or decrease the volume.

⑤ ⬆

- Access the home menu.

⑥ MAX SOUND

- Enable or disable the maximum sound.

⑦ 🎬

- Switch to video playback mode.

⑧ 🌀

- Enable or disable the FullSound effect.

⑨ DVD AUDIO

- Select an audio language or audio channel.

⑩ DBB

- Enable or disable the DBB (Dynamic Bass Boost) sound effect.

⑪ EQ

- Select a preset sound equalizer.

⑫ MUSIC ZONE

- Select a music listening zone.

⑬ OFF

- Turn on or off the screen.

⑭ FRONT/REAR

- Switch to the control interface for front source or rear source.

⑮ TOP MENU

- Return to top menu.

⑯ DVD MENU

- Access the DVD menu.

⑰ 🎵

- Switch to music playback mode.

⑱ 🖼️

- Switch to picture slideshow mode.

⑲ ▶⏸

- Start, pause, or resume the play.

⑳ OK

- Confirm an option.

㉑ ◀/▶ / TRACK - / TRACK +

- Skip to the previous or next track, chapter, or file.
- For DVD, press and hold to select a speed for fast backward or forward search.

㉒ BAND

- Select a tuner band.

- ②③ ▲ / ▼ /PRESET +/PRESET -
- Tune to the previous or next preset radio station.
 - Skip to the previous or next folder.
- ②④ ① 
- Press to turn on the system.
 - Press and hold to turn off the system.
 - Press to mute the speakers or release them from mute status.
- ②⑤ NAVI
- Press to access the navigation system.

3 Install the car entertainment system

Always follow the instructions in this chapter in sequence.

These instructions are for a typical installation. However, if your car has different requirements, make the adjustment accordingly. If you have any question regarding installation kits, consult your local retailer.



Note

- This system is designed for negative ground (earth) 12V DC operation only.
- Always install this system in the car dashboard. Other locations can be dangerous as the rear of the system heats up during use.
- To avoid short-circuit: before you connect, make sure that the ignition is off.
- Make sure that you connect the yellow and red power supply leads after all other leads are connected.
- Make sure that all loose leads are insulated with electrical tape.
- Make sure that the leads do not get caught under screws iron parts that will move (e.g. seat rail).
- Make sure that all ground (earth) leads are run to a common ground (earth) point.
- Use only the supplied mounting hardware for a safe and secure installation.
- Improper fuses can cause damage or fire. When you need to change the fuse, consult a professional.
- When you connect other devices to this system, make sure that the rating of the car circuit is higher than the total fuse value of all the connected devices.
- Never connect speaker wires to the metal body or chassis of the car.
- Never connect speaker wires with stripes to one another.

Connect wires

Note

- Make sure that all loose leads are insulated with electrical tape.
- Consult a professional to connect wires as instructed below.
- Before connection, check the car's wiring carefully.

1 Connect the ISO male connectors.

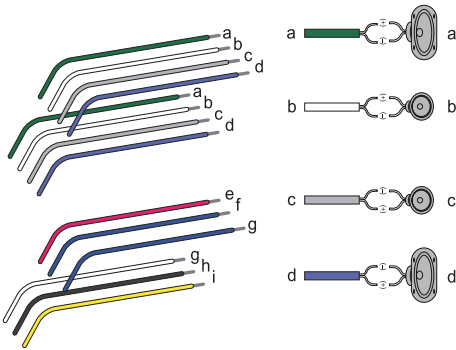

ISO male connectors	Connect to
a Green strip, black-edged green strip	Rear left speaker
b White strip, black-edged white strip	Front left speaker
c Gray strip, black-edged gray strip	Front right speaker
d Purple strip, black-edged purple strip	Rear right speaker
e Red strip	Ignition key +12V DC when ON/ ACC
f Blue strip	Motor/electric antenna relay control lead
g Blue strip, white strip	Amplifier relay control lead
h Black strip	Ground

i Yellow strip The +12V car battery which is energized at all times

2 Connect other wires if necessary.

! Caution

- To avoid an accident, the driver must not watch video while driving. By design, this system disallows watching video during drive. Park your car in a safe place and engage the parking brake before watching video.

Note

- When the parking brake of your vehicle is not engaged, the video blocking system is activated. It blocks the display of front video source only.
- If the system is not properly connected with the parking brake control module of your vehicle, video signals will be blocked by the system, with the below message displayed on the TFT.

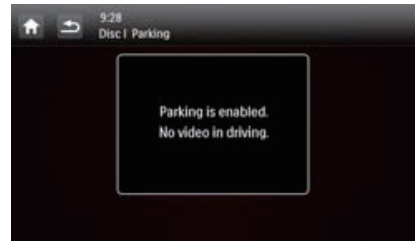

Connectors and sockets on rear panel	External sockets or connectors
1 For ISO male connectors	As indicated above
2 REAR OUT L (White socket)	Rear left speaker
3 REAR OUT R (Red socket)	Rear right speaker
4 AV-IN R (Red socket)	Right audio channel output socket of an external player

	Connectors and sockets on rear panel	External sockets or connectors
5	AV-IN L (White socket)	Left audio channel output socket of an external player
6	VIDEO IN (Yellow socket)	Video output socket of an external player
7	VIDEO OUT 1 (Yellow socket)	Video input socket of an external display device
8	VIDEO OUT 2 (Yellow socket)	Video input socket of an external display device
9	RADIO ANTENNA (Black socket)	Radio antenna
10	CAMERA IN (Purple socket)	Video output socket of an external camera
11	SUB-W OUT (Blue socket)	Sub-woofer
12	REVERSE CAMERA (Purple wire)	Reverse camera (B+)
13	PARKING BRAKE (Pink wire)	Parking brake (-)
14	OE SWC IR REMOTE IN (Brown wire)	OE SWC remote in
15	OE SWC IR REMOTE IN (Black wire)	Ground
16	OE SWC AD LEARN (White wire)	OE SWC AD Learn line 1
17	OE SWC AD LEARN (White wire)	OE SWC AD Learn line 2
18	OE SWC AD LEARN (Black wire)	Ground
19	External Mic (Black wire)	External microphone
20	GPS AERIAL (Black connector)	GPS smart antenna

21	FRONT OUT R (Red connector)	Front right speaker
22	FRONT OUT L (White connector)	Front left speaker
23	Rear Monitor Audio Out 1 (White connector)	Left audio channel input socket of one rear monitor
24	Rear Monitor Audio Out 1 (Red connector)	Right audio channel input socket of one rear monitor
25	Rear Monitor Audio Out 2 (White connector)	Left audio channel input socket of one rear monitor
26	Rear Monitor Audio Out 2 (Red connector)	Right audio channel input socket of one rear monitor



Tip

- The pin arrangement for the ISO connectors depends on the type of your vehicle. To avoid damage to the system, connect properly.

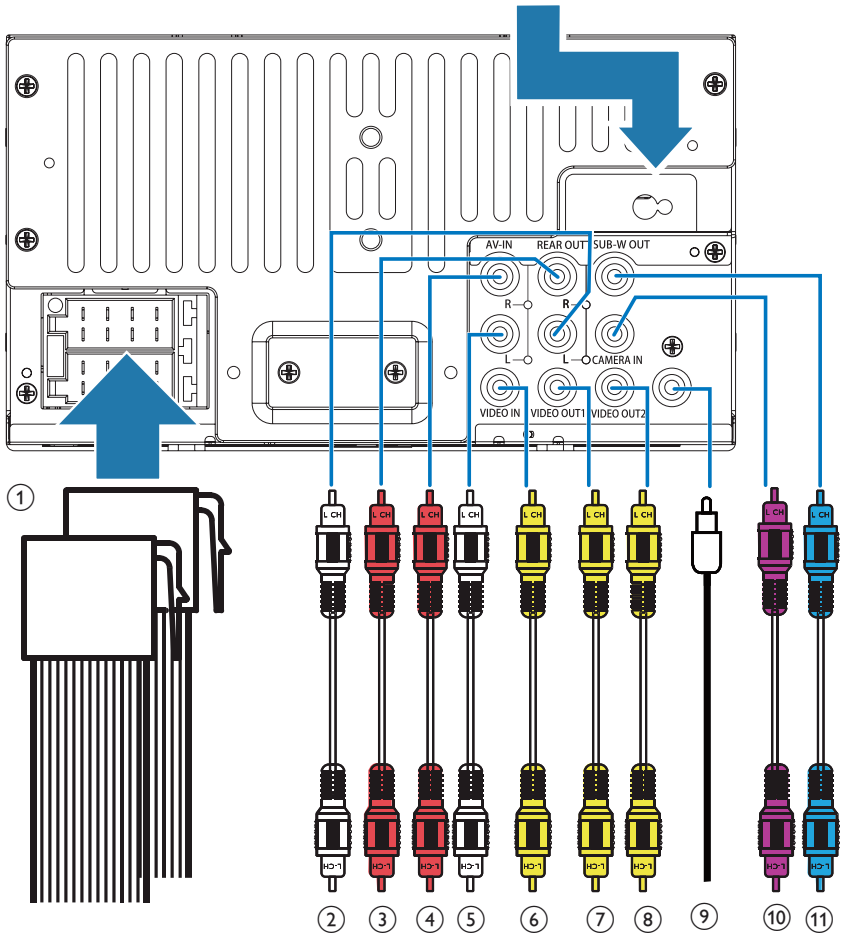
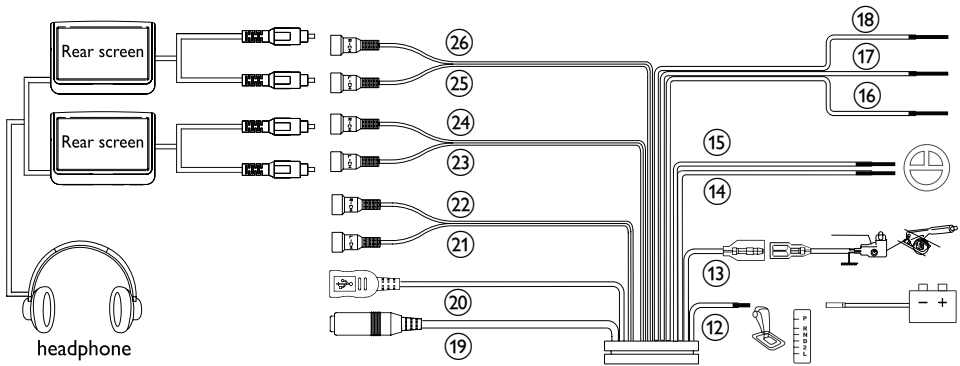

About the GPS antenna

Warning

- Risk of injury: Never install the antenna and its accessories on the airbag cover.
- Risk of swallowing parts: Keep the antenna and accessories out of the reach of children.

Caution

- Risk of electromagnetic interference: Do not install the GPS antenna over any sensors or vents.
- Risk of short circuit, malfunction, or damage to your car navigation system: Do not alter the GPS antenna cable or dismantle the antenna box.
- Risk of poor reception: Use the supplied metal sheet only, and never cut or distort it; do not paint the GPS antenna.
- Risk of damage to the GPS antenna cable: Never pull the antenna cable when you remove the antenna.
- Risk of scratching your car: The GPS antenna box has a magnet. When you install or remove it, do not drag it on any metal surface.

Install the GPS antenna

You can install the signal receptor of GPS antenna:

- On the dashboard cover
- On the back panel of rear-view mirror

Note

- Make sure that the contact surface that contacts with the metal sheet is free of moisture, dust, grime, oil, and any other dirt.
- If you remove the metal sheet, some adhesive may be left on the contact surface.

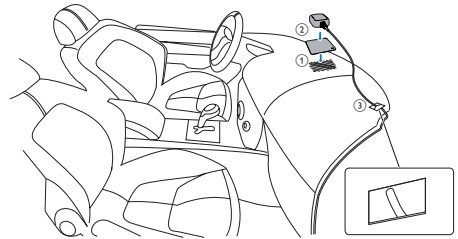

Connect the GPS antenna

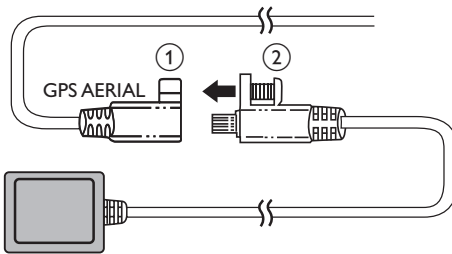

- 1 Connect the GPS antenna to your car navigation system.
- 2 Use the supplied screw to fasten the connectors.

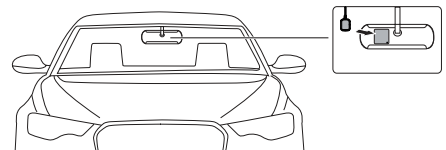

- 1 Remove the protective cover of the metal sheet, and then affix it.
- 2 Affix the antenna box onto the metal sheet.
- 3 Use clamps to secure the antenna cable.

Mount into the dashboard

Note

- Make sure that wires are correctly connected before you mount the main unit into a car.
- If preset radio stations are lost when the ignition key is turned OFF and then back ON, reconnect the red leads crosswise to the yellow ones.

- 1 If the car does not have an on-board drive or navigation computer, disconnect the negative terminal of the car battery.
 - If you disconnect the car battery in a car that has an on-board drive or navigation computer, the computer may lose its memory.
 - If the car battery is not disconnected, to avoid short-circuit, make sure that bare wires do not touch each other.
- 2 Make sure that the car dashboard opening is within these measurements:

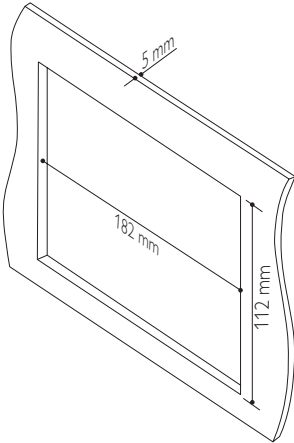

- Since the unit cannot be used if the dashboard opening's slant angle is above 20 degrees, make sure that the horizontal slant of the car dashboard opening is between 0 and 20 degrees.

- 3 Slide the unit into the dashboard until a click sound is heard.

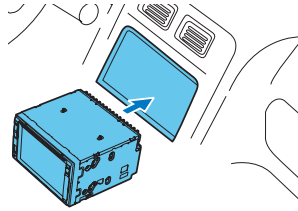

- 4 Reconnect the negative terminal of the car battery.

4 Get started

! Caution

- Risk of car accidents! Never watch video or operate this system while driving.

Prepare the remote control

For the first time use

Pull the protective sheet out.

↳ The remote control is ready for use.

Replace the battery

! Caution

- Risk of explosion! Keep batteries away from heat, sunshine or fire. Never discard batteries in fire.

☰ Note

- Remove the battery if it is exhausted or if the remote control is not to be used for a long time.
- Batteries contain chemical substances, they should be disposed of properly.
- Perchlorate Material - special handling may apply. See www.dtsc.ca.gov/hazardouswaste/perchlorate.

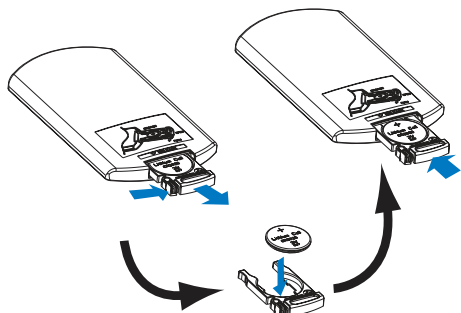

- 1 Pull out the battery tray.
- 2 Insert one CR2025 battery with correct polarity (+/-) as indicated.
- 3 Insert the battery tray.

Turn on

Press .

↳ PHILIPS logo and a progress bar are displayed while boot-up.

- To turn off the system, press and hold  for 3 seconds.

For the first time use

After successful boot-up, the following interface is displayed.



- 1 Tap to select a language for on-screen display.
↳ The following interface is displayed.

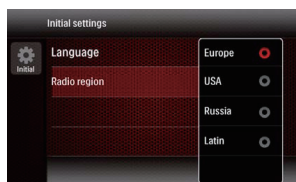

- 2 Tap to select a radio region that matches your location.
 ↳ The following interface is displayed.



- 3 Tap **[Finish]** to complete the initial setup.
 ↳ The device switches to radio mode automatically.

Use the home menu

Note

- If  is displayed when you touch an icon, it indicates that the selected media or feature is unavailable at the current time.





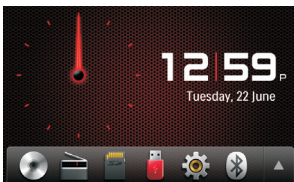





Access the home menu

- Tap  to access the home menu.
 ↳ The clock, date, and the bar for popular icons are displayed.



- To access the full menu with all feature icons displayed, tap .
- To return to the home menu, tap .



-  **[Radio]**: Switch the source to FM/AM radio.
-  **[Disc]**: Switch the source to disc.
-  **[USB]**: Switch the source to USB storage device.
-  **[SDHC]**: Switch the source to SD/SDHC card.
-  : Once your iPod/iPhone is connected and recognized, this icon is displayed in the bar of favorite icons. Tap it to switch the source back to iPod/iPhone.
-  **[Navigation]**: Access the navigation system.
-  **[Bluetooth]**: Use the Bluetooth feature.
-  **[AV-IN 1]/[AV-IN 2]**: Switch the source to the audio and video input that is transferred from an external video player.
-  **[Rear zone]**: Access the settings for rear monitors.
-  **[SWC]**: Access the interface to assign functions to buttons on the steering wheel.
-  **[Settings]**: Access the system menu.

Customize the home menu



- 1 Tap and hold an icon until it is movable.
- 2 Drag it to the target place, and then release your finger.
 - When you move an icon from the bar for popular icons to the lower area, release your finger when the icon's name is displayed.
 - When you move an icon from the lower area to the bar for popular icons, release your finger when the icon's name disappears.
- 3 Tap to return to the home menu.
↳ The bar for popular icons is refreshed.

Set the date and time

- 1 Tap > to access the full menu with all feature icons displayed.
- 2 Tap [Settings].
↳ The [General] menu is displayed.

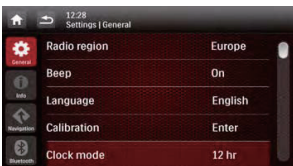

- 3 Tap [Clock Mode] to select a time format.
 - [24Hr]: 24-hour time format
 - [12Hr]: 12-hour time format

- 4 Tap [Date] to display the interface for setting the date.



- 5 Tap to set the year, month, and date.
- 6 Tap [Time] to display the interface for setting the time.



- 7 Tap to set the hour and minute.
- 8 Tap to return to the home menu.

Adjust the screen brightness

Press and hold on the front panel to select a brightness level of the screen.

- [Level 1], [Level 2], or [Level 3]

Switch display designs

Select a preset display design.

- 1 In any mode, tap , and then [Display Design].
↳ The [Display Design] interface is displayed.



- 2 Tap a setting to display the options.
 - **[Wallpaper]:** Select a wallpaper.
 - **[Visualizer]:** Select a motional visualization effect.
 - **[Skin]:** Select a background color for on-screen icons.
- 3 Tap an option to select it.
- 4 Tap ↩ to return to the previous mode.

5 Play from hard media

You can use this system to listen to audio, watch videos, and view photos that are stored on a disc, USB storage device, or SD/SDHC card.

Note

- Before use, check for compatible media.

Load a disc

Caution

- Never insert any object other than a disc of 12-cm diameter into the disc slot.

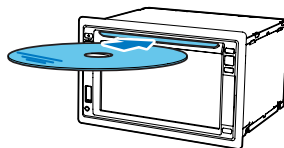

- 1 Insert the disc into the disc slot with the label side facing up.
 - ↳ Play starts automatically.
 - If play does not start automatically, tap the screen to display the ▶ icon, and then tap ▶ to start play.
- 2 To eject the disc, press ▲.
 - ↳ When the disc is ejected, the system switches to the previous source or radio mode.

Region Code

You can play DVD discs marked with the following region code.

DVD region code	Countries
	Russia

Connect a USB storage device

Note

- Make sure that the USB storage device contains compatible files.
- NTFS (New Technology File System) file system is not supported.

- 1 Push the USB socket cover upwards to open it.
- 2 Connect the USB storage device to the USB socket.
↳ Play starts automatically.

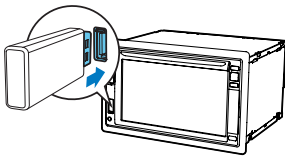

- To remove the USB storage device, switch the system to another source first.

Insert an SD/SDHC card

Note

- Make sure that the SD/SDHC card contains compatible files.
- NTFS (New Technology File System) file system is not supported.

- 1 Flip up the protective cover.
- 2 Insert the SD/SDHC card into the  slot until you hear a "click".
↳ Play starts automatically.

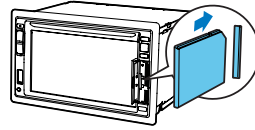





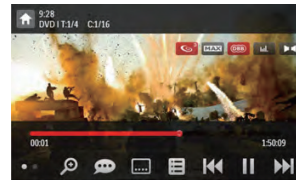

Remove the SD/SDHC card

- 1 Switch system to another source.
- 2 Press the card inwards until you hear a "click".
↳ The card is disengaged.
- 3 Pull out the SD/SDHC card.

Control play

Videos



-  : Return to the home menu.
-  : Zoom in or out of the image.
-  : Select an available audio channel or audio language.
-  : Select an available subtitle.
- 
 - For DVD, return to the disc menu or root menu.
 - For recorded files, return to the list of files or folders. (see 'Browse recorded files' on page 18)

- **PBC:** For VCD/SVCD only, enable or disable the PBC (Playback Control) feature.
- **⏮️/⏭️:** Skip to the previous or next title, chapter, track, or file.
 - To search forward fast or rewind the track, tap on the progress bar.
- **⏸️/▶️:** Start, pause, or resume play.
- **⦿:** Display control icons on the second page.



- **↺:** Select a repeat mode.
 - DVD: **[Rep: chapter]** (repeat the current chapter), **[Rep: title]** (repeat the current title), **[Rep:all]** (repeat all chapters and titles), or **[Rep:off]** (cancel repeat play).
 - VCD/SVCD: **[Rep: one]** (repeat the current track) or **[Rep:all]** (repeat all tracks).
 - Recorded files: **[Rep: one]** (repeat the current video file), **[Repeat folder]** (repeat all video files in the current folder), or **[Rep:all]** (repeat all video files).
- **[16:9]/[4:3]:** Select an aspect ratio.
- **☀️:** Tap to display the brightness bar, and then tap on the bar to adjust the screen brightness.
- **🗨️:** Tap to display the contrast bar, and then tap on the bar to adjust the image contrast.
- **🌈:** Tap to display the saturation bar, and then tap on the bar to adjust the image saturation.
- **⦿:** Display control icons on the first page.

Audios

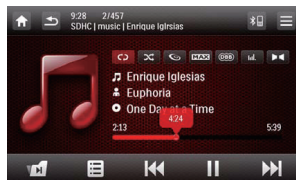





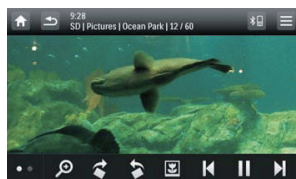

- **🏠:** Return to the home menu.
- **↺:**
 - Press once to access the track list.
 - Press twice to access the folder list.
 - Press repeatedly to return to the playback interface.
- **📁:** For recorded files only, skip to the next audio folder.
- **☰:** Return to the list of tracks or folders (see 'Browse recorded files' on page 18).
- **⏮️/⏭️:** Skip to the previous or next track.
 - To search forward fast or rewind the track, tap on the progress bar.
- **⏸️/▶️:** Start, pause, or resume play.
- **↺ / ⏮️ / ↻:** Select a repeat mode.
 - **⏮️:** Repeat the current track.
 - **↻:** For recorded files, repeat all tracks in the current folder.
 - **↺** (highlighted): Repeat all tracks.
- **🎲:** Select random play (**🎲** highlighted) or sequential play (**⏮️** in gray).





Pictures



- **🏠:** Return to the home menu.
- **🔍:** Zoom in or out of the picture.
- **🔄/↺:** Rotate the picture clockwise or anti-clockwise by 90 degrees.

-  /  : Return to the list of files or folders (see 'Browse recorded files' on page 18).
-  /  : Select the previous or next picture.
-  /  : Pause or resume the slideshow.
-  : Display control icons on the second page.







- **[16:9]/[4:3]**: Select an aspect ratio.
-  : Tap to display the brightness bar, and then tap on the bar to adjust the screen brightness.
-  : Tap to display the contrast bar, and then tap on the bar to adjust the image contrast.
-  : Tap to display the saturation bar, and tap on the bar to adjust the image saturation.
-  : Display control icons on the first page.

Browse recorded files

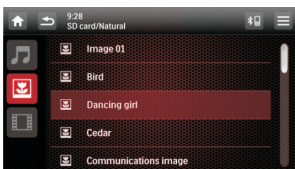
During playing recorded files, you can access the file list and select files from the list.

- 1 Tap  to access the list of files or folders.



- 2 Tap an icon to select a file category.
 -  : Display the list of audio tracks or folders.
 -  : Display the list of picture files or folders.
 -  : Display the list of video files or folders.
- 3 Tap the name of a file to start play.





About DivX® videos

DivX® video is a digital media format that retains high quality despite of a high compression rate. You can play DivX® VOD (Video-on-Demand) videos that are rented or purchased from online stores. You can also play non-VOD DivX videos.

Play DivX VOD videos

To play DivX® VOD videos on this product, you need the DivX® VOD code on this product, the DivX Player installed on your computer, and a free DivX Account.

Find the DivX® VOD code on your product.

- 1 Tap  >  to access the full menu with all feature icons displayed.
- 2 Tap  **[Settings]** to access the system setup menus.
- 3 Tap  **[Info]** to access the **[Info]** menu.
- 4 Tap **[DivX(R) VOD]** to display the registration code.

Note

- If no DivX Player is installed on your computer, download it from www.divx.com for free.
- If you have no DivX Account, create one for free through DivX Player that is installed on your computer.

On your computer through DivX Player

- 1 With the DivX® VOD code, register this product under your DivX Account.
 - After the registration, previous videos that you rented or purchased with the same DivX Account can be played on this product.
- 2 Rent or purchase DivX® VOD videos with your DivX Account.
- 3 Transfer the DivX® VOD videos to a supported recordable disc.

On your product

Play the DivX® VOD videos from the disc.

Note

- Go to www.divx.com to learn more about downloading and playing DivX videos.

Play non-VOD DivX videos

- 1 Transfer the videos and subtitle files onto a supported recordable disc, USB storage device, or SD/SDHC card.
- 2 Play the video files from the disc, USB storage device, or SD/SDHC card.

Note

- To play a DivX DRM protected file, transfer it to a compatible disc first.
- The subtitle filename has to be the same as the filename of the DivX video (the file extension excluded).
- The DivX video file and its subtitle file must be saved under the same directory.
- This product supports subtitle files in the following formats: .srt and .sub.

6 Listen to radio

Switch to radio mode

After the boot-up at the first time, the system switches to radio mode automatically.

To switch the source back to radio afterwards, tap  **[Radio]** on the home menu.

↳ The interface for radio is displayed.



Set up

Before you search for radio stations, make prior setup.

Tap  to display the setup menus.

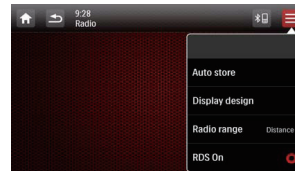

Select a radio range

- 1 Tap **[Radio Range]**.

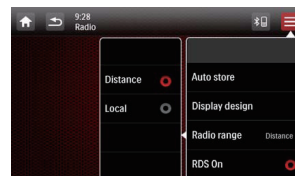

- 2 Tap **[Distance]** or **[Local]** to select a tuner sensitivity.
 - **[Distance]**: Stations with strong and weak signals can be tuned to.
 - **[Local]**: Only stations with strong signals can be tuned to.

Enable the RDS feature

Note

- RDS feature is enabled by default.
- Only after the RDS feature is enabled, the option of **[PTY list]** is displayed.

Tap **[RDS Off]** (RDS disabled) to enable the RDS feature.

- ↳ The option of **[PTY list]** is displayed.
- To disable the RDS feature, tap **[RDS On]** (RDS enabled).

Tune to a radio station



- 1 Tap **FM** or **AM** to select a band.
 - FM bands: **FM1, FM2, FM3**
 - AM bands: **AM1, AM2**
- 2 Tap **<** or **>** repeatedly until the frequency of target radio station is displayed.
 - To tune to a radio station automatically, tap and hold **<** or **>** until the frequency digits start change.

Tip

- You can also press **BAND** on the remote control repeatedly to select a band.

Store radio stations in memory

You can store up to 6 stations in each band.

Store radio stations manually

- 1 Select a band.
- 2 Tune to the target radio station.
- 3 Tap and hold one of the channels (**1 to 6**) over two seconds.
 - ↳ The radio station is saved under the selected channel.

Store radio stations automatically

You can search for a radio station with intro search, which broadcasts a 10-second preview of each detected radio station.

- 1 Select a band.
- 2 Tap **≡**.
- 3 Tap **[Auto Store]**.
 - ↳ Auto search starts. The six strongest stations of the selected band are saved in preset channels automatically.

Tune to a preset radio station

- 1 Select a band.
- 2 Tap one of the preset channels (**1 to 6**) to select a preset radio station.



Use RDS related features

Note

- Only after RDS feature is enabled, you can use RDS related features.

Search for RDS programs of a specific type



- 1 Tap > [PTY list] to display the list of program types.
- 2 Tap the name of a program type to start search.
 - ↳ Once an RDS station that transmits programs of the selected type is found, the RDS station is broadcast automatically.
 - To save the RDS station, tap and hold one of the preset channels.
 - To search for another RDS station, repeat steps 1 and 2.

RDS program types

Item	Program type	Description
1	NEWS	News services
2	AFFAIRS	Politics and current affairs
3	INFO	Special information programs
4	SPORT	Sports
5	EDUCATE	Education and advanced training
6	DRAMA	Radio plays and literature

7	CULTURE	Culture, religion and society
8	SCIENCE	Science
9	VARIED	Entertainment programs
10	POP M	Pop music
11	ROCK M	Rock music
12	MOR M	Light music
13	LIGHT M	Light classical music
14	CLASSICS	Classical music
15	OTHER M	Special music programs
16	WEATHER	Weather
17	FINANCE	Finance
18	CHILDREN	Children's programs
19	SOCIAL	Social Affairs
20	RELIGION	Religion
21	PHONE IN	Phone In
22	TRAVEL	Travel
23	LEISURE	Leisure
24	JAZZ	Jazz Music
25	COUNTRY	Country Music
26	NATION M	National Music
27	OLDIES	Oldies Music
28	FOLK M	Folk Music
29	DOCUMENT	Documentary
30	TEST	Alarm Test
31	ALARM	Alarm

Use alternate frequencies

If the signal of an RDS station is poor, enable the AF (Alternate Frequency) function. The system searches for a strong station that broadcasts the same program.

Tap **AF** to enable or disable the AF function.

- **AF** (highlighted): The function is enabled.
- **AF** (in gray): The function is disabled.

Receive traffic announcement

If you want to receive traffic announcement, enable the TA (Traffic Announcement) function. Tap **TA** to enable or disable the TA function.

- **TA** (highlighted): The function is enabled. When a traffic announcement is on air, the system automatically switches to radio mode and begins to broadcast the traffic announcement. When the traffic announcement is over, the system returns to the previous mode.
- **TA** (in gray): The function is disabled.

7 Use the navigation system

Insert the map data card

Note

- The map data card is not included in the packaging.
- Before using the map data card, update the map data if necessary.

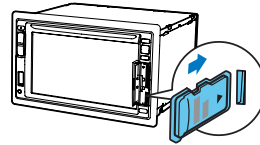

- 1 Flip up the protective cover.
- 2 Insert the map data card into the **MAP** slot until you hear a "click".
- 3 Close the protective cover.

Navigate your road trip

Note



- Risk of traffic accident! Never operate the navigation system during drive. Complete the setting of your destination and other navigation specifications before you drive.

- 1 Press **NAVI**.
 - You can also tap  on the home menu to access the navigation system.
 - ↳ The navigation interface is displayed in a few seconds.
- 2 Follow the user manual of the navigation map to set navigation specifications.

8 Use Bluetooth devices

With this system, you can listen to audio from a player and make a call through Bluetooth.

Activate the Bluetooth function

- On the home menu, tap .
- In any other mode, tap  on top of the screen.

Pair a device

Note

- WOOX Innovations does not guarantee the compatibility with all Bluetooth devices.
- Before pairing a device with this system, read its user manual for Bluetooth compatibility.
- Make sure that Bluetooth function is enabled on your device, and your device is set as visible to all other Bluetooth devices.
- The operational range between this system and a Bluetooth device is approximately 8 meters (24 feet).
- Any obstacle between this system and a Bluetooth device can reduce the operational range.
- Keep away from any other electronic device that may cause interference.

Pair the first device

- 1 Activate the Bluetooth function on this system.
↳ The following interface is displayed.



- 2 Tap  on this system to search for other Bluetooth devices.

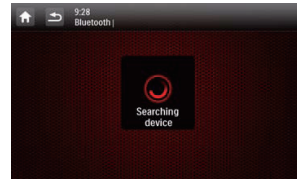

- 3 In the device list, tap the name of your Bluetooth device, and then tap  behind the name.





- ↳ The pairing starts, and then a pairing request from CED1900 is displayed on your device.
- 4 On your device, accept the pairing request from CED1900, enter the default password '0000', and then confirm the password entry.
↳ [Paired OK!] flashes, and then [Connecting] is displayed on this system.

- 5 On your device, enable or permit the connection with CED1900.
- If a player is connected, the music playback interface is displayed on this system.



 : Tap it to return to the music playback interface.

 : Tap it to display the list of paired mobile phones.

 : Tap it to display the list of paired mobile phones.

 : Tap it to display the list of paired mobile phones.

- If a mobile phone is connected, the keypad is displayed on this system.

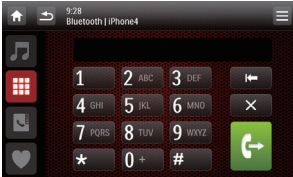

 : Tap it to display the list of paired players.

 : Tap it to display the on-screen keypad for phone calls.

 : Tap it to display the phone book that is synchronized with your mobile phone and keypad.

 : Tap it to display the list of favorite contacts.

Pair more devices

- 1 Activate the Bluetooth function on this system.
 - ↳ One of the following interfaces is displayed.

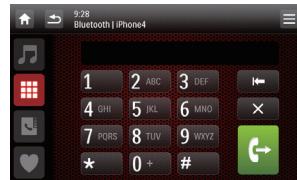

- 2 Tap  on the top right corner.

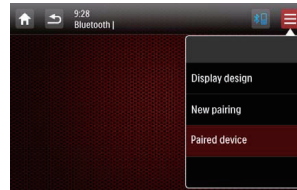





- 3 Tap **[New Pairing]** to start searching for Bluetooth devices.
- 4 Repeat steps 3 to 5 that are indicated in the above section "Pair the first device" (see "Pair the first device" on page 23)" to complete the connection.

Note

- You can connect a music player and a mobile phone simultaneously.





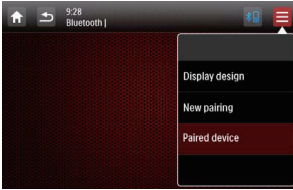

Manage paired devices

- 1 Activate the Bluetooth function.
- 2 Tap  or 
 - To manage paired players, tap .
 - To manage paired mobile phones, tap .
- 3 Tap  on the top right corner.



- 4 Tap [Paired Device].
↳ The list of paired devices is displayed.



- 5 Tap the name of the paired device that you want to reconnect, disconnect, or delete.
 -  : Tap to reconnect the device.
 -  : Tap to disconnect the device.
 -  : Tap to delete the device from the list of paired devices.
- 6 Tap , , or .

Tip



- If you want to manually reconnect a device after the connection is interrupted, disable the function of automatic connection (see 'Adjust Bluetooth settings' on page 33).

Play audio from a connected device

If the connected Bluetooth device supports Advanced Audio Distribution Profile (A2DP), you can listen to tracks that are stored on the device through the system. If the device also supports Audio Video Remote Control Profile (AVRCP) profile, you can control play on the system or with its remote control.

- 1 Play a track on the connected device.
- 2 On this system, tap  to display the music playback interface.



- 3 Tap icons on the interface to control play.
 -  : Pause or resume play.
 -  : Select the previous or next track.

Note

- If the connected device does not support the AVRCP profile, control play on the connected device.

Make a call

Note

- Keep the Bluetooth connection active between the system and your mobile phone.

Locate the external microphone

You can connect an external microphone for better communication quality.

Note

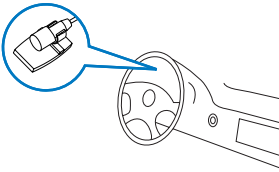

- The external microphone is not included in the packaging of this system.

- 1 Make sure that the microphone is connected to this system (see 'Connect wires' on page 7).
- 2 Place the microphone at a proper location, such as, stick it onto the dashboard, or clip it on the sun-shield.







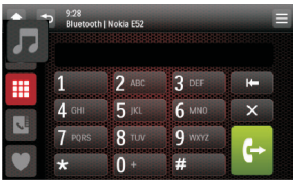

Call a number

You can make phone calls with the system.



- 1 Tap  on top of the screen.
 - ↳ The keypad is displayed.
 - If the keypad is not displayed, tap .



- 2 Tap number icons to enter the phone number:
 - To clear the last digit, tap .
 - To clear all digits, tap .
 - To return to the previous screen, tap .

- 3 Tap  to send the call.
 - To end the call, tap .
 - To enter numbers during the call, tap  to display the keypad first.

Redial the last called number

- 1 Tap .
 - ↳ The last called number is displayed.
- 2 Tap  again to send the call.



Answer a call

Note

- By default, all incoming calls are picked up automatically. You can disable the function of automatic answer (see 'Adjust Bluetooth settings' on page 33).

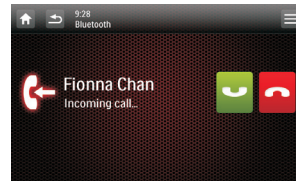
- 1 When there is an incoming call, **[Incoming call...]** is displayed on the screen.



- 2 Tap  to answer the call.
 - To reject or end the call, tap .

Transfer a phone call to mobile phone

By default, the voice comes from the loudspeakers during a call.

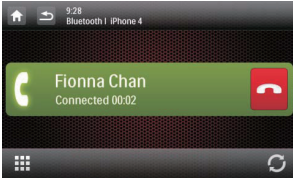

- 1 Tap  to transfer the phone call to your mobile phone.
 - ↳ The loudspeakers are muted, and the voice comes from the mobile phone only.
- 2 Take up your mobile phone for the conversation.

Use the on-screen phone book

- 1 Tap  to display the phone book interface.
- 2 Tap **[Sync]** to start synchronizing the phone book with your mobile phone.
 - ↳ **[Synchronizing...]** is displayed.
 - ↳ After the synchronization is complete, the contact list is displayed.



- 3 Tap the name of a contact from the list, and then tap  to send a call.

Manage the phone book

- 1 Tap the name of a contact from the list.
- 2 Tap **X**.
 - ↳ The following options are displayed.
 - **[Delete One]**: Delete the selected contact.

- **[Delete All]**: Delete all contacts.
- **[Cancel]**: Return to the phone book interface.

- 3 Tap one of the options and confirm.

Search for a contact

Tap the alphanumeric icons to enter the keyword.

- To enter the first letter displayed on the icon, tap it once.
- To switch between letters and the digit, tap an icon briefly and repeatedly.
- To delete the last input, tap .
 - ↳ The system searches for contacts whose name include the keyword.
 - ↳ If no contact is found, **[No Match]** is displayed.





Note

- Up to 5 characters can be entered as the keyword.

Edit the favorite call list

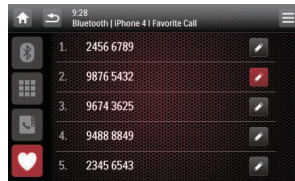
Save the number of a contact into the favorite call list, and then you can send a call quickly.



- 1 Tap  to display the favorite call list.
- 2 Tap  behind a sequence number.
- 3 Enter the number and then tap **OK** to confirm.
 - ↳ The number is saved.
 - To send a call, tap the number from the list.

9 Play from an iPod/iPhone

Note

- During play, no audio signals are transferred through the headphone socket of your iPod/iPhone.

Compatible iPod/iPhone models

This system supports the following iPod and iPhone models.

- iPhone 4, iPhone 3GS, iPhone 3G, and iPhone
- iPod touch (1st, 2nd, 3rd, and 4th generations)
- iPod nano (1st, 2nd, 3rd, 4th, 5th, and 6th generations)
- iPod classic

Connect your iPod/iPhone

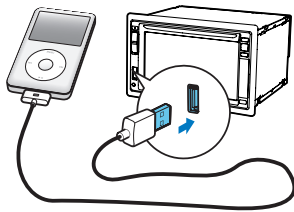

Connect an Apple 30-pin USB cable to:

- the USB socket on the front panel of this system, and
- your iPod/iPhone.
↳ The system starts playing tracks that are stored on your iPod/iPhone.















- Once your iPod/iPhone is connected and recognized,  is displayed in the bar of popular icons on the home menu. You can tap it to switch back to this playback interface.

Note

- Before you disconnect your iPod/iPhone, switch the system to another source.

Control play

By default, use the on-screen playback interface of this system to control play.

- : Tap to pause play.
- : Tap to resume play.
- : Tap to play the previous or next track.
- : Tap to select a repeat mode.
 - : Repeat the current track.
 -  (highlighted): Repeat all tracks.
 -  (in gray): Cancel repeat play.
- : Tap to select a play mode.
 -  (highlighted): Play tracks randomly.
 -  (in gray): Play tracks in sequence.
- : Tap to switch to the iPod control mode, and then you can control play on your iPod/iPhone.
- : Tap to switch back to the on-screen control mode, and then you can control play on this system.
- : Tap to access the music menu.

Search for a track

You can select a track quickly through the music menu.

1 Tap  to access the music menu.

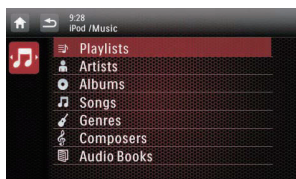

2 Tap to select a category.
↳ Tracks under the selected category are listed.

3 Tap a track name to start play.
• If one or more subcategories are under the selected category, select a category first.

Charge your iPod/iPhone

Once the iPod/iPhone is connected and recognized, the iPod/iPhone begins to charge.

10 Adjust sound

When you listen to radio, enjoy music, or watch video, follow the instructions below to adjust sound.

Adjust the volume level

Press +/- repeatedly on the front panel.

- +: Increase the volume level.
- -: Decrease the volume level.

Mute sound

Press  on the front panel.

- To release the speakers from mute status, press  again.

Enable the maximum sound



Tap **MAX** on the playback interface.

- **MAX** (highlighted): The maximum sound is enabled.
- **MAX** (in gray): The maximum sound is disabled.

Enable the DBB sound effect

When DBB (Dynamic Bass Boost) is enabled, low tones are enhanced electronically.

Tap  on the playback interface.

-  (highlighted): DBB sound effect is enabled.
-  (in gray): DBB sound effect is disabled.

Enable the FullSound effect

Note



- This feature is unavailable when you listen to radio.

Philips FullSound restores the audio details that are lost due to compression. It enriches the music signals so that what you hear is the full sound with every nuance of emotion and every detail of musical genius.

Philips FullSound can:

- bring out CD sound quality from an MP3 track,
- achieve richer bass with greater depth and impact,
- restore the sense of spaciousness that lacks in a compressed audio, and
- enhance sound precision and details.



Tap  on the playback interface.



-  (highlighted): The FullSound effect is enabled.
-  (in gray): The FullSound effect is disabled.

Select a preset sound equalizer

- Tap  on the playback interface.
 - The current equalizer settings are displayed.





- Tap  or  to select a preset sound equalizer:
 - [Custom]**, **[Techno]**, **[Rock]**, **[Classic]**, **[Jazz]**, **[Optimal]**, **[Flat]**, or **[Pop]**
 - The selected sound equalizer is highlighted.

- Tap on the circle or bar to adjust the settings.
 - [Bass]**: bass range (-14 to +14)
 - [Middle]**: middle range (-14 to +14)
 - [Treble]**: treble range (-14 to +14)
 - [LPF]**: low pass filter range (60 Hz, 80 Hz, 100 Hz, or 160 Hz)
 - [MPF]**: middle pass filter range (0.5 kHz, 1.0 kHz, 1.5 kHz, or 2.5 kHz)
 - [HPF]**: high pass filter range (10.0 kHz, 12.5 kHz, 15.0 kHz, or 17.5 kHz)
 -  : Tap and hold to restore the settings.
- Tap  to exit.

Others

- Tap  on the playback interface.
 - The setup interface is displayed.



-  : Tap to display the **[Music Zone]** interface for selecting a listening zone.
-  : Tap to display the **[Fader]** / **[Balance]** interface for adjusting the fader and balance.
-  : Tap to display the **[Subwoofer]** interface for setting the sub-woofer.

Adjust the fader and balance

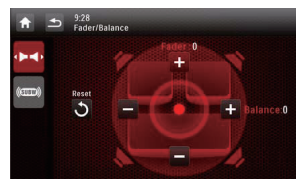

Tap **+** or **-** to adjust fader or balance value.

- **[Fader]**: fader range (+16 to -16).
- **[Balance]**: balance range (-16 to +16).

Set the sub-woofer



- **[On]/[Off]**: Tap to turn on or off the sub-woofer.
- **+** / **-**: Tap to set the volume of sub-woofer (0 dB to 14 dB).
- **[80 Hz]/[120 Hz]/[160 Hz]**: Tap to select a low pass filter range for the sub-woofer.

Select a listening zone

Philips' innovative Zone technology enables the driver or passengers to enjoy music with the best speakers balance and experience more vivid spacial effect as the artist is intended to create. You can switch the music listening zone from the driver to passengers for the best speaker sound settings in car.

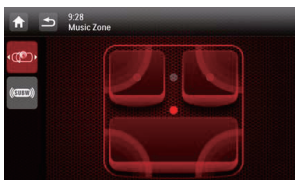

Tap a gray point to switch the listening zone.

- ↳ The highlighted area indicates the current listening zone.

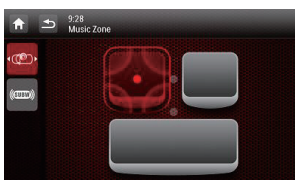

11 Adjust settings

Access system setup menus

- 1 Tap **Home** > **Navigation** to display all feature icons.



- 2 Tap **Settings**.
↳ The **[General]** menu is displayed.



- 3 Tap an icon on the left.
 - **Settings**: Access the **[General]** menu to adjust general settings.
 - **Info**: Access the **[Info]** menu to view system information.
 - **Navigation**: Access the **[Navigation]** menu to adjust navigation settings.
 - **Bluetooth**: Access the **[Bluetooth]** menu to adjust Bluetooth settings.
- 4 Swipe your finger up or down to view more settings.
- 5 Tap an option to view details or change the setting.
 - To exit the menu, tap **Back**.

Adjust general settings



Settings	Options	Description
[Radio Region]		Select a radio region that matches your location.
[Beep]	[On]	Turn the beep sound on. Each time you press a button or tap an icon, the unit beeps.
	[Off]	Turn off the beep sound.
[Language]		Select an OSD (on-screen display) language.
[Calibration]		Follow the on-screen instructions to calibrate the touch screen.
[Clock Mode]	[12Hr] / [24Hr]	Select a time format.
[Date]		Set the date.
[Time]		Set the time.
[Parking]	[On] / [Off]	Enable or disable the video blocking system.
[Demo] (Auto start after power off)	[On] / [Off]	Enable it to demonstrate features after the system is power off.

View system information



Settings	Options
[ARM Version]	View firmware versions.
[Servo version]	
[MCU Version]	
[Bluetooth version]	View the version of Bluetooth.
[DVD regions]	View the DVD region code that the system supports.
[DivX(R) VOD]	View the DivX registration code.
[Restore factory defaults]	Tap to display the dialog box for restoring the system. <ul style="list-style-type: none"> Tap [Yes] to restore the system to factory default status. Tap [No] to return to the previous menu.

Adjust Navigation settings

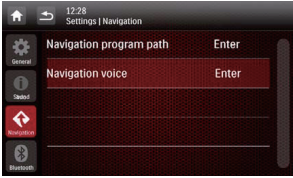

- **[Navigation Program Path]:** Tap **[Enter]** to access the Navigation Program Path mode.
- **[Navigation Voice]:** Tap **[Enter]** to display the **[Navigation Voice]** interface.



- **[All]/[Front left]/[Front right]:** Select a zone for navigation voice.
- **[Off]:** Mute the navigation voice.
- **[Voice level]:** Tap +/- to adjust the volume of navigation voice.

Adjust Bluetooth settings

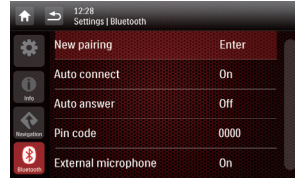

Bluetooth settings	Options	Description
[New Pairing]		Search for new devices.
[Auto Connect]	[On]	When a paired device is within effective range, the system reconnects with the device automatically.
	[Off]	Reconnect manually.
[Auto Answer]	[On]	Answer phone calls automatically when the paired mobile phone receives an incoming call.
	[Off]	Answer phone calls manually.
[Pin Code]		Set the password for pairing the car entertainment system with another Bluetooth device. The default password is 0000 .
[External microphone]	[On]	Turn on the external microphone.
	[Off]	Use the integrated microphone.

12 Others

Play external audio/video input

You can connect an external audio/video player to this system.

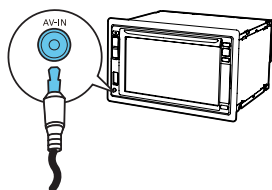

- 1 Connect a composite AV cable to
 - the **AV-IN** socket on the front panel, and
 - the audio and video output sockets of the external player.
- 2 Tap **Home** > **Up** to access the full menu with all feature icons displayed.
- 3 Tap **AV-IN 1** to display the playback interface.
- 4 Operate on the external player to start play (see the user manual of the external device).

Tip

- If you connect this system to an external player through the **VIDEO IN**, **AV-IN L**, and **AV-IN R** sockets on the rear panel, tap **AV-IN 2** to switch the source instead of **AV-IN 1**.

Use rear monitors

If one or two monitors are connected for backseat passengers, you can select different sources for front and backseat passengers.

Note

- Make sure that rear monitors are correctly connected to this system.
- Only when the multi-zone display mode is activated, rear monitors can receive signals from the system.
- By default, the same signals are transferred to the front and rear monitors.
- When a disc, USB storage device, SD/SDHC card, or iPod/iPhone connected through the USB socket is selected as the source for front zone, you cannot select another source for rear zone.
- Only when the system is in radio mode, navigation mode, or Bluetooth mode, you can select a source for rear zone from disc, SD/SDHC card, USB storage device, or iPod/iPhone connected through the USB socket.

- 1 Tap **Home** > **Up** to access the full menu with all feature icons displayed.
- 2 Tap **AV-IN**.
 - ↳ The **[Rear zone]** menu is displayed.

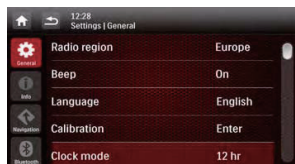

- 3 Tap **[Mode]** to enable or disable the signal transferring to rear monitors.
 - **[On]**: Enable the signal transferring to rear monitors.
 - **[Off]**: Disable the signal transferring to rear monitors.
 - ↳ When it is enabled, the following interface is displayed.



- 4 Tap to select an available source to start play.
- 5 Tap **[Rear speaker]** to enable or disable the audio output to rear speakers.
 - **[On]**: Enable the audio output to rear speakers.
 - **[Off]**: Mute rear speakers.

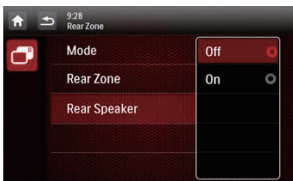

- 6 Tap ↶ to return to the previous mode.

Switch the control interfaces

When different sources are selected for front passengers and backseat passengers, you can tap **[R]** to switch the control interface for front source or rear source.

- ↳ When **[R]** is solidly displayed, the current control interface is for the front source.
- ↳ When **[R]** blinks with **[Settings icon]** and **[Rear zone]** displayed, the current control interface is for the rear source.

Use buttons on the steering wheel

You can assign a function to a button on the steering wheel, and then control the system with that button.

- 1 Tap **Home** > **Up** to access the full menu with all feature icons displayed.
- 2 Tap **Steering Wheel Remote Control Learning**.
 - ↳ The **[Steering Wheel Remote Control Learning]** interface is displayed.



- 3 Tap an icon, for example, **Fast Forward**, of which you want to assign the function to a button on the steering wheel.





- To cancel the assignment, tap **[Cancel]**.
- 4 Press and hold the button on the steering wheel for one second.
 - ↳ The following interface is displayed.



- 5 Repeat steps 3 and 4 to assign more functions to buttons on the steering wheel.
 - To clear the assignment, tap **[Clear all]**.

Set the rear view camera

If a rear view camera is connected, you can view on the screen what the camera takes.

- 1 Tap  >  to access the full menu with all feature icons displayed.
- 2 Tap  (the icon is displayed only when a compatible camera is correctly connected).
↳ Picture from rear camera is displayed.



Reset the system

If the system hangs up, reset it.

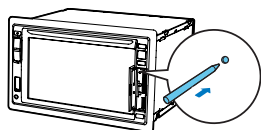

- 1 Flip up the protective cover.
- 2 Press **RESET** with the tip of a ball-point pen or toothpick.

Replace the fuse

If there is no power, check the fuse and replace it if it is damaged.

- 1 Detach the main unit from dashboard.
- 2 Check the electric connection.
- 3 Remove the damaged fuse from the rear panel.

- 4 Insert a new fuse with the same specifications (15 A).

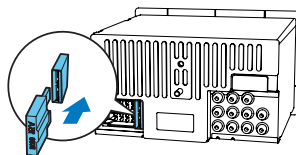

Tip

- If the fuse gets damaged immediately after it is replaced, an internal malfunction may occur. In this case, consult your WOOX Innovations retailer.

Upgrade the firmware

Note

- Power supply must not be interrupted during the upgrade.
- When the firmware upgrade succeeds, all settings are restored to the factory default status.

Perform the upgrade

Register your product

- 1 Go to www.philips.com/welcome.
- 2 Click the link of "**Register my product**" (the exact wording of this link name may vary in different languages).
- 3 Log in with your account on the prompt Web page.
 - If you have no account for Club Philips, create one first on this Web page.
- 4 Search your product with "**CED1900BT/51**" as the keyword.
- 5 Click the link of search result to access the Web page for registering your product.

- 6 Fill in necessary information about this product to complete the registration.
 - ↳ With the registration, you can get information about software update and product support at this Web page or via your mailbox that is registered as the account for Club Philips.
- 1 Check the current firmware version of this system (see 'View system information' on page 32).
- 2 Go to www.philips.com/support.
- 3 Login with your account for Club Philips.
 - ↳ Support information about your registered product is displayed.
- 4 Click the link of "**Firmware Upgrade Readme File**" (the exact wording of this link name may vary in different languages).
- 5 Read and understand the instructions on firmware upgrade.
- 6 Follow the instructions to download the upgrade packet and complete the upgrade.
 - If the upgrade fails, reboot this system, and then perform the upgrade again.

13 Product information



Note

- Product information is subject to change without prior notice.

General

Power supply	12 V DC (11 V - 16 V), negative ground
Fuse	15 A
Suitable speaker impedance	4 - 8 Ω
Maximum power output	50 W \times 4 channels
Continuous power output	24 W \times 4 channels (4 Ω 10% T.H.D.)
Pre-Amp output voltage	4.0 V (CD play mode; 1 kHz, 0 dB, 10 k Ω load)
Sub-woofer output voltage	4.0 V (CD play mode, 61 Hz, 0 dB, 10 k Ω load)
Aux-in level	\geq 800 mV
Dimensions (W \times H \times D)	178 \times 101.5 \times 160 mm
Weight (main unit)	3.1 kg

Disc player

System	DVD / CD audio / MP3 system
Disc diameter	12 cm
Frequency response	20 Hz - 20 kHz
Signal/noise ratio	> 75 dB
Total harmonic distortion	Less than 0.3%
Channel separation	> 55 dB
Video signal format	NTSC/PAL
Video output	1 +/- 0.2 V p-p

Radio

Frequency range	
- FM	87.5 - 108.0 MHz (100 kHz per step in auto search and 50 kHz per step in manual search)
- ORIT	65.0 - 74.0 MHz (30 kHz per step)

Frequency range	522 - 1620 kHz
- AM(MW)	(9 kHz per step)

Usable sensitivity	
- FM	2 uV

Usable sensitivity	
- AM (MW)	25 uV

LCD

Screen size	6.2 inches
-------------	------------

Display resolution	800 × 480 dots
--------------------	----------------

Contrast ratio	500
----------------	-----

Brightness	450 cd/m ²
------------	-----------------------

Bluetooth

Communication system	Bluetooth Standard version 2.0
----------------------	--------------------------------

Output	Bluetooth Standard Power Class 2
--------	----------------------------------

Maximum communication range	Line of sight approx. 8m
-----------------------------	--------------------------

Frequency band	2.4 GHz band (2.4000 GHz - 2.4835 GHz)
----------------	--

Compatible Bluetooth profiles	Hands-Free Profile (HFP) Handset Profile (HSP) Advanced Audio Distribution Profile (A2DP) Audio Video Remote Control Profile (AVRCP)
-------------------------------	---

Supported codecs	
Receive	SBC (Sub Band Codec)
Transmit	SBC (Sub Band Codec)

USB playability information

Compatible USB devices:

- USB flash memory (USB 2.0 or USB1.1)
- USB flash players (USB 2.0 or USB1.1)
- Memory cards (SD/SDHC)
- Maximum capacity: 32 G

Supported USB formats:

- USB or memory file format: FAT16, FAT32
- MP3 bit rate (data rate): 32-320 Kbps and variable bit rate
- WMA v9 or earlier
- Directory nesting up to a maximum of 8 levels
- Number of albums/folders: maximum 99
- Number of tracks/titles: maximum 999
- ID3 tag v2.0 or later
- File name in Unicode UTF8 (maximum length: 128 bytes)

Supported MP3 disc format:

- ISO9660, Joliet
- Maximum title number: 512 (depending on file name length)
- Maximum album number: 255
- Supported sampling frequencies: 32 kHz, 44.1kHz, 48 kHz
- Supported Bit-rates: 32-320 Kbps and variable bit rate

Supported video formats:

- DVD
- Divx



Note

- To ensure a better playback, it is recommended that file image size is no higher than 640 x 480, frame rate is 20 fps, data rate is no higher than 500 kbps.

14 Troubleshooting



Warning

- Never remove the casing of this product.

To keep the warranty valid, never try to repair the product yourself.

If you encounter problems when using this product, check the following points before requesting service. If the problem remains unsolved, go to the Philips Web page (www.philips.com/support). When you contact Philips, make sure that the product is nearby and the model number and serial number are available.

General

No power

- Car engine has not been started. Start the car engine.
- Connections are incorrect.
- The fuse has been damaged. Replace the fuse.

No sound

- Volume is too low. adjust the volume.
- Speaker connections are incorrect.

No response to the remote control

- Make sure that the path between the remote control and the unit is clear from obstacles.
- Move the remote control close to the unit, and point it at the iR sensor:
- Press  to switch to the control interface for front source or rear source.
- The function is not applicable to the current media.
- Replace the remote control battery.

The disc does not play.

- The disc is upside down. Make sure that the printed side is upwards.
- The disc is dirty. Clean the disc with a clean, soft, lint-free cloth. Wipe the disc outwards from the center.
- The disc is defective. Try another disc.
- The disc is incompatible. Try another disc.
- The recordable disc is not finalized.
- The region code of DVD disc is not supported. Use a disc with proper region code.

Cannot play DivX file from an SD/SDHC card or USB storage device

- DivX DRM protected files cannot be played if they are saved on an SD/SDHC card or USB storage device. Transfer it to a compatible disc instead.

No image

- Parking wire connection is incorrect. Check the wiring.

No image on rear monitor

- Enable the signal transferring to rear monitors (see 'Use rear monitors' on page 34).
- A DivX video can be played for front passengers only.

Image flashes or is distorted.

- Video connection is improper. Check the connections.

Noise in broadcasts

- Signals are too weak. Select another station with stronger signals.
- Check the connection of the car antenna.

Preset stations are lost.

- Battery cable is not correctly connected. Connect the battery cable to the terminal that is always live.

The fuse is broken.

- The fuse type is incorrect. Replace it with a 15 A fuse.
- Speaker wire or power wire is grounded. Check the connections.

About the Bluetooth device

Music playback is unavailable on the system even after successful Bluetooth connection.

- The device cannot be used with the system to play music.

The audio quality is poor after connection with a Bluetooth-enabled device.

- The Bluetooth reception is poor. Move the device closer to the system or remove any obstacle between the device and the system.

Cannot connect with the system.

- The device does not support the profiles required for the system.
- The Bluetooth function of the device is not enabled. Refer to the user manual of the device to find out how to enable the function.
- The system is not in the pairing mode.
- The system is already connected with another Bluetooth-enabled device. Disconnect that device or all other connected devices and then try again.

The paired mobile phone connects and disconnects constantly.

- The Bluetooth reception is poor. Move the mobile phone closer to the system or remove any obstacle between the mobile phone and the system.
- Some mobile phones may connect and disconnect constantly when you make or end calls. This does not indicate any malfunction of the system.
- For some mobile phones, the Bluetooth connection may be deactivated automatically as a power-saving feature. This does not indicate any malfunction of the system.

15 Notice

Any changes or modifications made to this device that are not expressly approved by WOOX Innovations may void the user's authority to operate the equipment.

Compliance

CE 0890

This product complies with the radio interference requirements of the European Community.

This apparatus includes this label:

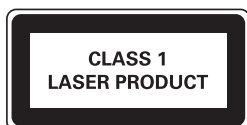

Care of the environment



Your product is designed and manufactured with high quality materials and components, which can be recycled and reused.



When this crossed-out wheeled bin symbol is attached to a product it means that the product is covered by the European Directive 2002/96/EC.

Please inform yourself about the local separate collection system for electrical and electronic products.

Please act according to your local rules and do not dispose of your old products with your normal household waste. Correct disposal of your old product helps to prevent potential negative consequences for the environment and human health.



Your product contains batteries covered by the European Directive 2006/66/EC, which cannot be disposed with normal household waste. Please inform yourself about the local rules on separate collection of batteries because correct disposal helps to prevent negative consequences for the environmental and human health.

Environmental information

All unnecessary packaging has been omitted. We have tried to make the packaging easy to separate into three materials: cardboard (box), polystyrene foam (buffer) and polyethylene (bags, protective foam sheet.)

Your system consists of materials which can be recycled and reused if disassembled by a specialized company. Please observe the local regulations regarding the disposal of packaging materials, exhausted batteries and old equipment.

Trademark notice

The Bluetooth® word mark and logos are registered trademarks owned by Bluetooth SIG, Inc. and any use of such marks by WOOX Innovations is under license.



Windows Media and the Windows logo are trademarks, or registered trademarks of Microsoft Corporation in the United States and/or other countries.



"Made for iPod" and "Made for iPhone" mean that an electronic accessory has been designed to connect specifically to iPod or iPhone respectively, and has been certified by the developer to meet Apple performance standards. Apple is not responsible for the operation of this device or its compliance with safety and regulatory standards. Please note that the use of this accessory with iPod or iPhone may affect wireless performance. iPod and iPhone are trademarks of Apple Inc., registered in the U.S. and other countries.



DivX®, DivX Certified® and associated logos are trademarks of Rovi Corporation or its subsidiaries and are used under license. ABOUT DIVX VIDEO: DivX® is a digital video format created by DivX, LLC, a subsidiary of Rovi Corporation. This is an official DivX Certified® device that plays DivX video. Visit divx.com for more information and software tools to convert your files into DivX videos. ABOUT DIVX VIDEO-ON-DEMAND: This DivX Certified® device must be registered in order to play purchased DivX Video-on-Demand (VOD) movies. To obtain your registration code, locate the DivX VOD section in your device setup menu. Go to vod.divx.com for more information on how to complete your registration.



Manufactured under license from Dolby Laboratories. Dolby and the double-D symbol are trademarks of Dolby Laboratories.



'DVD Video' is a trademark of DVD Format/Logo Licensing Corporation. Other trademarks and trade names are those of their respective owners.

Copyright



This item incorporates copy protection technology that is protected by U.S. patents and other intellectual property rights of Rovi Corporation. Reverse engineering and disassembly are prohibited. 2013 © WOOX Innovations Limited. All rights reserved.

Specifications are subject to change without notice. Philips and the Philips' Shield Emblem are registered trademarks of Koninklijke Philips N.V. and are used by WOOX Innovations Limited under license from Koninklijke Philips N.V.. WOOX Innovations reserves the right to change products at any time without being obliged to adjust earlier supplies accordingly.



Specifications are subject to change without notice.

2013 © WOOX Innovations Limited. All rights reserved.

This product was brought to the market by WOOX Innovations Limited or one of its affiliates, further referred to in this document as WOOX Innovations, and is the manufacturer of the product. WOOX Innovations is the warrantor in relation to the product with which this booklet was packaged. Philips and the Philips Shield Emblem are registered trademarks of Koninklijke Philips N.V.

CED1900BT_51_UM_V2.0

