

PHILIPS

Soundbar 7.1.2

Fidelio B97

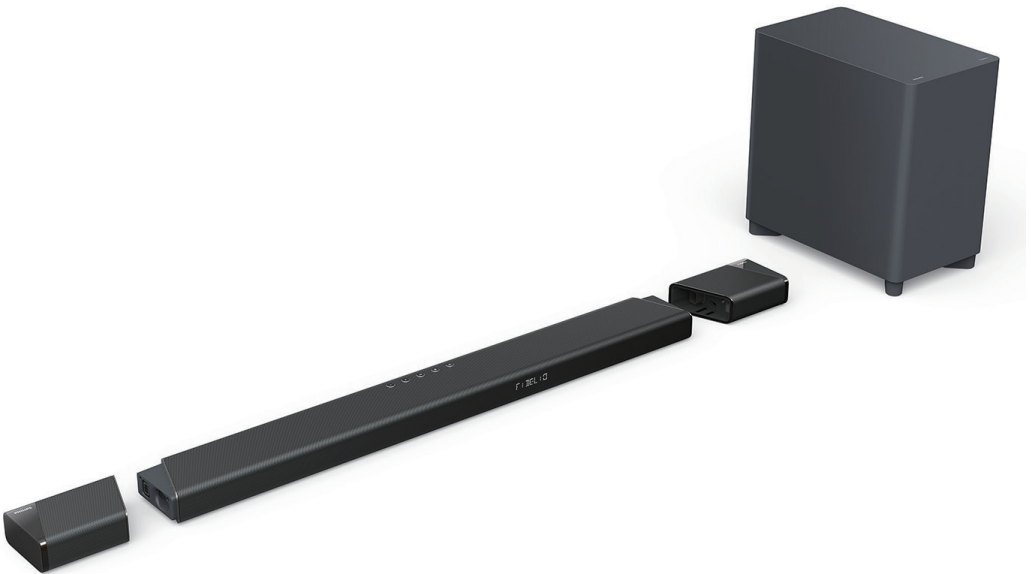

User manual

Register your product and get support at
www.philips.com/support

Contents

1 Important	2		
Safety	2		
Care for your product	3		
Care of the environment	3		
Compliance	3		
Help and support	3		
2 Your product	4		
What's in the box	4		
Main unit	4		
Remote control	5		
Detachable wireless surround speakers	6		
Wireless subwoofer	6		
Connectors	7		
3 Connect and set up	8		
Placement	8		
Connect to TV	9		
Connect TV or digital devices through HDMI	9		
Connect audio from TV or other devices	10		
Connect to power	10		
Pair up with the subwoofer	10		
Pair up with detachable wireless surround speakers	11		
Charge the detachable wireless surround speakers	11		
Connect to Wi-Fi (Wireless Operation)	12		
4 Use your product	14		
Insert batteries before using the remote control	14		
Adjust the volume	14		
Choose your sound	14		
Dolby Atmos®	15		
Play audio through Bluetooth MP3 player	17		
Play-Fi multi-room	17		
		Chromecast(audio) / AirPlay2 / Alexa 3PDA	17
		Listen to Spotify	17
5 Settings	18		
Adjust speaker level	18		
Set display brightness	18		
Auto standby	18		
Apply factory settings	18		
6 Update software	19		
Update software via Wi-Fi	19		
Update via USB	19		
7 Wall mount your product	20		
Wall mount the main unit	20		
8 Product specifications	21		
9 Troubleshooting	22		

1 Important

Read and understand all instructions before you use your product. If damage is caused by failure to follow instructions, the warranty does not apply.

Safety

Risk of electric shock or fire!

- Before you make or change any connections, make sure that all devices are disconnected from the power outlet.
- Never expose the product and accessories to rain or water. Never place liquid containers, such as vases, near the product. If liquids are spilled on or into the product, disconnect it from the power outlet immediately. Contact Consumer Care to have the product checked before use.
- Never place the product and accessories near naked flames or other heat sources, including direct sunlight.
- Never insert objects into the ventilation slots or other openings on the product.
- Where the mains plug or an appliance coupler is used as the disconnect device, the disconnect device shall remain readily operable.
- Batteries (battery pack or batteries installed) shall not be exposed to excessive heat such as sunshine, fire or the like.
- Disconnect the product from the power outlet before lightning storms.
- When you disconnect the power cord, always pull the plug, never the cable.
- Use the product in tropical and/or moderate climates.

Risk of short circuit or fire!

- For identification and supply ratings, see the type plate at the back or bottom of the product.
- Before you connect the product to the power outlet, ensure that the power voltage matches the value printed on the back or bottom of the product. Never connect the product to the power outlet if the voltage is different.

Risk of injury or damage to this product!

- For wall mounting, this product must be securely attached to the wall in accordance with the installation instructions. Use only the supplied wall mount bracket (if available). Improper wall mounting may result in accident, injury or damage. If you have any query, contact Consumer Care in your country.
- Never place the product or any objects on power cords or on other electrical equipment.
- If the product is transported in temperatures below 5°C, unpack the product and wait until its temperature matches room temperature before connecting it to the power outlet.
- Parts of this product can be made of glass. Handle with care to avoid injury and damage.

Risk of overheating!

- Never install this product in a confined space. Always leave a space of at least four inches around the product for ventilation. Ensure curtains or other objects never cover the ventilation slots on the product.

Risk of contamination!

- Do not mix batteries (old and new or carbon and alkaline, etc.).
- Danger of explosion if batteries are incorrectly replaced. Replace only with the same or equivalent type.
- Remove batteries if they are exhausted or if the remote control is not to be used for a long time.
- Batteries contain chemical substances, they should be disposed of properly.

Risk of swallowing batteries!

- The product/remote control may contain an AAA battery, which can be swallowed. Keep the battery out of reach of children at all times! If swallowed, the battery can cause serious injury or death. Severe internal burns can occur within two hours of ingestion.
- If you suspect that a battery has been swallowed or placed inside any part of the body, seek immediate medical attention.
- When you change the batteries, always keep all new and used batteries out of reach of children. Ensure that the battery compartment is completely secure after you replace the battery.

- If the battery compartment cannot be completely secured, discontinue use of the product. Keep out of reach of children and contact the manufacturer.



This is CLASS II apparatus with double insulation, and no protective earth provided.

~

AC voltage



Use only the power supplies listed in the user manual.

Care for your product

Use only microfiber cloth to clean the product.

Care of the environment

Disposal of your old product and battery



Your product is designed and manufactured with high quality materials and components, which can be recycled and reused.



This symbol on a product means that the product is covered by European Directive 2012/19/EU.



This symbol means that the product contains batteries covered by European Directive

2013/56/EU which cannot be disposed of with normal household waste. Inform yourself about the local separate collection system for electrical and electronic products and batteries. Follow local rules and never dispose of the product and batteries with normal household waste. Correct disposal of old products and batteries helps prevent negative consequences for the environment and human health.

Removing the disposable batteries

To remove the disposable batteries, see battery installation section.

Compliance

This product complies with the radio interference requirements of the European Community.

Hereby, TP Vision Europe B.V. declares that this product is in compliance with the essential requirements and other relevant provisions of Directive 2014/53/EU. You can find the Declaration of Conformity on www.p4c.philips.com.

Help and support

For extensive online support, visit www.philips.com/support to:

- download the user manual and the quick start guide
- watch video tutorials (available only for selected models)
- find answers to frequently answered questions (FAQs)
- email us a question
- chat with our support representative.

Follow the instructions on the website to select your language, and then enter your product model number. Alternatively, you can contact Consumer Care in your country. Before you contact, note down the model number and serial number of your product. You can find this information on the back or bottom of your product.

2 Your product

Congratulations on your purchase, and welcome to Philips! To fully benefit from the support that Philips offers (e.g. notification of product software upgrade), register your product at www.philips.com/support.

What's in the box

Check and identify the items in the package:

- Soundbar x1
- Detachable wireless surround speaker x2
- Wireless subwoofer x1
- Remote control x1
- AAA battery x2
- Power cord* x2
- Power adapter x1
- Wall mount kit (wall bracket x4, screw x10, dowel x6)
- Quick start guide
- Warranty card
- Safety sheet
- Mounting guide

*Power cord quantity and plug type vary by regions.

Main unit

This section includes an overview of the main unit.

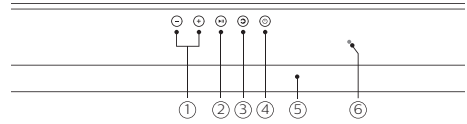

- ➊ **+/- (Volume)**
Increase or decrease volume.
- ➋ **▶|| (Play/Pause)**
Play, pause or resume in Bluetooth playback.
- ➌ **⌂ (Source)**
 - Press to select an input source for this product.
- ➍ **⏻ (Standby-On)**
 - Short press: Switch On / Off (Semi-standby)
 - Long press(5 sec): Switch Off (Eco standby)
- ➎ **Display panel**

⑥ Power and Wi-Fi LED indicator

LED indicator Color	Display Panel	Power state	Wi-Fi network	Sources available to use
White	Off	Eco standby	Disconnected	All sources are shut down.
Amber	Off	Semi-standby	Connected	Play-Fi, Chromecast(Audio), AirPlay2, Alexa 3PDA & Spotify Connect (These sources are running in background.)
Amber (flashing)	On	Power on	Connecting	HDMI1, HDMI2, E-ARC(ARC), OPTICAL & BT
Amber	On	Power on	Connected	All sources are ready.

Remote control

This section includes an overview of the remote control.

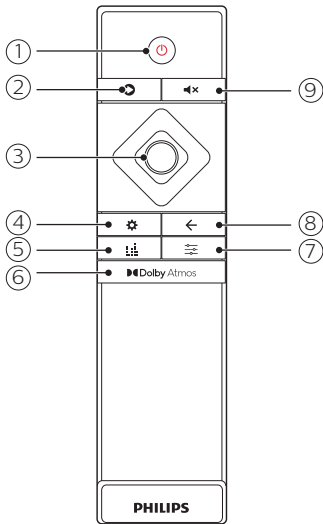

① ⏻ (Standby-On)

- Short press: Switch On / Off (Semi-standby)
- Long press(5 sec): Switch Off (Eco standby)

② ↻ (Source)

Select an input source for this product.

- **HDMI 1:** Switch your source to the HDMI IN 1 connection.
- **HDMI 2:** Switch your source to the HDMI IN 2 connection.
- **E-ARC:** Switch your source to HDMI E-ARC or ARC connection.
- **OPTICAL:** Switch your audio source to the optical connection.
- **AUDIO IN:** Switch your audio source to AUDIO IN connection (3.5mm jack).
- **BT:** Switch to Bluetooth mode.

≡ Note

Play-Fi multi-room, Chromecast(Audio), AirPlay2, Alexa 3PDA & Spotify Connect are running in background when Wi-Fi is connected. They are selected and controlled by respective casting device/APP.

③ Navigation buttons

- Up: Increase volume or select the previous item in the menu.
- Down: Decrease volume or select the next item in the menu.
- Left: Skip to the previous track in playback mode or select level down in the menu mode.
- Right: Skip to the next track in playback mode or select level up in the menu mode.
- Center: Play, pause or resume in playback mode. Confirm a selection.

④ ⚙ (Menu)

Enter the general settings menu.

SUB	Subwoofer gain control
CTR	Center speakers relative volume level
SIDE L	Left side firing speaker relative volume level
SIDE R	Right side firing speaker relative volume level
DIM	Display brightness level
DISP	Display auto off
BT PAIR	Start BT pairing (BT source only)
UPGRADE	Firmware upgrade via USB

⑤ 🎛 (Equalizer)

Select surround sound modes (Movie/Music/Voice/Sport/Custom).

MOVIE	Preset EQ for movie
MUSIC	Preset EQ for music
VOICE	Preset EQ for news or talk show
SPORT	Preset EQ for sport programme
CUSTOM	User custom EQ (controlled in Philips Sound app)

⑥ 🎧 Dolby Atmos

Select a height effect level for Dolby Atmos.

⑦ (Sound)

Select sound settings (Surround/DRC/IMAX/Dialogue/Bass/Treble/Sync).

SUR	Surround sound options
DRC	Dynamic Range control
IMAX	IMAX mode options
DLG	Adjust dialogue level (for DTS-X only)
CTRL	
BASS	Adjust bass level for preset EQ
TREBLE	Adjust treble level for preset EQ
SYNC	Adjust audio and video sync delay (HDMI only)

⑧ ←
Exit settings.

⑨  ×
Mute or restore volume.

Detachable wireless surround speakers

This product comes with two detachable wireless surround on demand speakers (left and right).

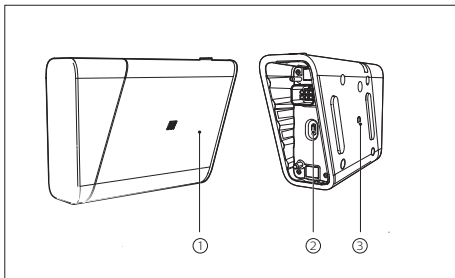

① Speaker LED

- Blinks white if the wireless speaker is not wirelessly connected to the main unit.
- Lights up white when the wireless speaker is wirelessly connected to the main unit, or when the battery capacity is full or more than 20% remaining.
- Blinks red when the battery capacity is less than 20% remaining.
- Blinks red for 5 seconds and then lights off when the battery capacity is less than 10% remaining.

- Lights up red when the wireless speaker is being charged (only for the wireless speakers docked into the main unit).

② USB-C charging port

Connect to external USB-C power adapter (not provided) for longer detachable use..

③ Power button

- Press to turn on the wireless speaker if it automatically goes to standby.
- Press and hold to switch the wireless speaker to standby.

Wireless subwoofer

This product comes with a wireless subwoofer.

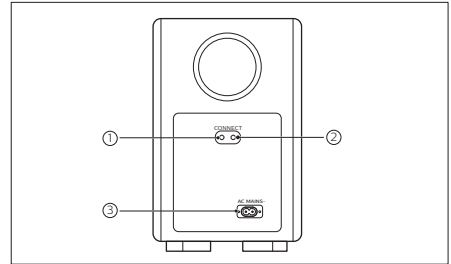

① CONNECT (Connect)

Press and hold for 5 seconds to enter the pairing mode between the main unit and the subwoofer.

② Subwoofer indicator

- When the power is turned on, the indicator lights up.
- During wireless pairing between the subwoofer and the main unit, the indicator blinks white quickly.
- When the pairing succeeds, the indicator lights up white.
- When the pairing fails, the indicator blinks white slowly.
- When the wireless connection is disconnected for 1 minute, the indicator turns off.

③ AC MAINS-

Connect to the power supply.

Connectors

This section includes an overview of the connectors available on the main unit.

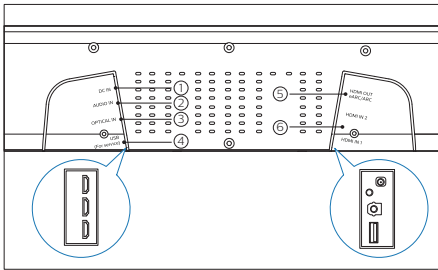

- ① **DC IN**
Connect to the power supply.
- ② **AUDIO IN**
Connect to an audio output (3.5mm jack) on a device.
- ③ **OPTICAL IN**
Connect to an optical audio output on the TV or a digital device.
- ④ **USB (For service)**
Connect to a USB flash drive to upgrade software of this product.
- ⑤ **HDMI OUT (eARC/ARC)**
Connect to the HDMI (eARC/ARC) input on the TV.
- ⑥ **HDMI IN 1 / HDMI IN 2**
Connect to the HDMI output on a digital device.

3 Connect and set up

This section helps you connect this product to a TV and other devices, and then set it up. For information about the basic connections of this product and accessories, see the quick start guide.

! Caution

- For identification and supply ratings, see the type plate at the back or bottom of the product.
- Before you make or change any connections, make sure that all devices are disconnected from the power outlet.

Placement

Place the subwoofer at least 1 meter (3 feet) away from the main unit, and 10 centimeters (4 inches) away from the wall.

For best sound effect, position all the speakers towards the seating position and place them close to your ear level (seated).

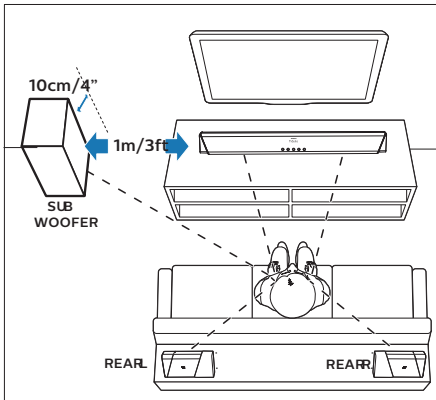

≡ Note

Surround sound depends on factors such as room shape and size, type of wall and ceiling, windows and reflective surfaces, and speaker acoustics. Experiment with the speaker positions to find the optimum setting for you.

Follow these general guidelines for speakers placement.

- 1 Seating position: This is the center of your listening area.
- 2 Place the main unit in front of the seating position.
- 3 **REAR L** (rear left) and **REAR R** (rear right): Place the detachable wireless surround speakers to the left and right side of your seating position, either in line with it or slightly behind it.
- 4 **SUBWOOFER** (subwoofer): Place the subwoofer at least 1 meter to the left or right of the TV. Leave about 10-centimeter clearance from the wall.

Dock the detachable wireless surround speakers

You can also dock the detachable wireless left and right speakers into the main unit to listen to audio, for example, watching TV shows and news.

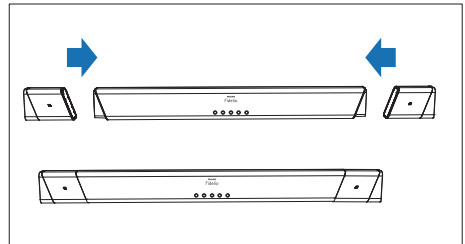

Connect to TV

Connect this product to your TV. You can enjoy audio from TV programs through the soundbar speaker. Use the best quality connection available on your soundbar speaker and TV.

Connect to TV through HDMI (ARC/eARC)

This product supports HDMI with eARC (Enhance Audio Return Channel). eARC is a new function standardized by HDMI 2.1 and supports the latest audio formats in addition to audio formats that are supported with existing ARC (Audio Return Channel). If your TV is HDMI eARC compliant, you can enjoy the TV audio that ARC cannot transfer, such as Dolby Atmos-Dolby TrueHD and DTS:X, or multi-channel LPCM contents, by using a single HDMI cable.

What you need

- A High-Speed HDMI cable.
- Your TV supports both HDMI ARC and HDMI-CEC (see the TV user manual for details).
- For some TV models, enable the external speaker output from the TV setting menu (see the TV user manual for details).

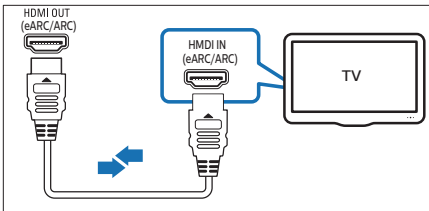

- 1 Using a High Speed HDMI cable, connect the **HDMI OUT** connector on this product to the **HDMI ARC** connector on your TV.
 - The **HDMI ARC** connector on the TV might be labeled differently. For details, see the TV user manual.
- 2 On your TV, turn on the HDMI-CEC operations. For details, see the TV use manual.

- 3 Repeatedly press the source button until **E-ARC** displays on the display panel.

Note

- Your TV must support the HDMI-CEC and ARC function and you must enable them.
- 100% interoperability with all HDMI-CEC devices is not guaranteed.
- Only HDMI 2.1 compatible cables can support the eARC function.
- If your TV is not HDMI ARC compliant, connect an audio cable then enjoy the TV audio through this product.

Connect TV or digital devices through HDMI

If your TV is not HDMI ARC-compliant, connect your soundbar to the TV through a standard HDMI connection. You can also connect a digital device such as a set-top box, DVD/Blu-ray player, or games console to this product through a single HDMI connection. When you connect the devices in this way and play a file or game, the

- video is automatically displayed on your TV, and
- audio is automatically played on this product.

- 1 Using a High-Speed HDMI cable, connect the **HDMI OUT** connector on your digital device to the **HDMI IN/1/2** on this product.
- 2 Connect this product to TV through **HDMI OUT**.
If the TV is not HDMI CEC compliant, select the correct video input on your TV.
- 3 On the connected device, turn on HDMI-CEC operations. For details, see the user manual of the device.

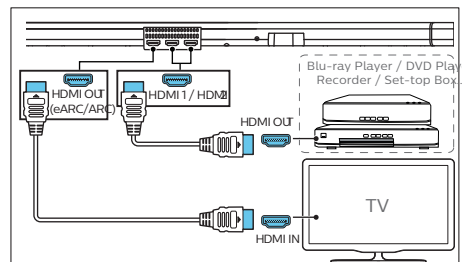

Connect audio from TV or other devices

Play audio from TV or other devices through this product.

Use the best quality connection available on your TV, soundbar, and other devices.

Note

- When this product and TV are connected through HDMI ARC, an audio connection is not required.

Option 1: Connect audio through a digital optical cable

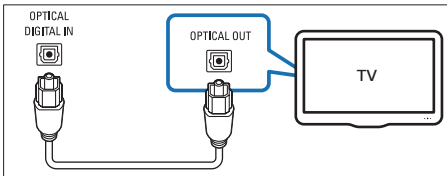

- 1 Using an optical cable, connect the **OPTICAL IN** connector on this product to the **OPTICAL OUT** connector on the TV or other devices.
 - The digital optical connector might be labeled **OPTICAL OUT**, **SPDIF** or **SPDIF OUT**.
- 2 Repeatedly press the source button until **OPTICAL** displays on the display panel.

Option 2: Connect audio through an analog audio cable

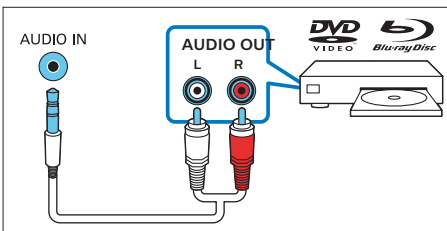

- 1 Using an analog cable, connect the **AUDIO IN** connector on this product to the **AUDIO OUT** connector or analog audio output connectors (red and white) on TV or other devices.
- 2 Repeatedly press the source button until **AUDIO IN** displays on the display panel.

Connect to power

- Before connecting to the AC power cord, make sure that you have completed all other connections.
- Risk of product damage! Make sure that the power supply voltage corresponds to the voltage printed on the back or the underside of the main unit.
- Connect the mains cable to the DC socket of the main unit and then into a mains socket.
- Connect the mains cable to the AC- socket of the subwoofer and then into a mains socket.

Pair up with the subwoofer

Automatic pairing

The wireless subwoofer automatically pairs up with the main unit for wireless connection when you turn on the main unit and the subwoofer.

Determine the status based on the wireless subwoofer indicator.

LED behavior	Status
Fast blink	Subwoofer in pairing mode
Constant on	Connected / Pairing successfully
Slow blink	Connecting / Pairing failed

Note

- Do not press the **CONNECT** (Connect) button on the rear of the subwoofer, except for manual pairing.

Manual pairing

If no audio from the subwoofer can be heard, manually pair up the subwoofer.

- 1 Unplug both the main unit and the subwoofer from the mains sockets, then plug them in again after 3 minutes.
- 2 Press and hold the **CONNECT** (Connect) button on the rear of the subwoofer for 5 seconds.
- 3 Press and hold ⏻ on the main unit or remote control for 5 seconds to switch the main unit to Eco standby.
- 4 Press ⏻ on the main unit or remote control to switch the main unit on.
 - » The indicator on the subwoofer blinks white quickly and **SBW PAIRING** displays on the display panel.
 - » If the pairing succeeds, the indicator on the subwoofer lights up white and **SBW PAIRED** displays on the display panel.
- 5 If the pairing fails, **CHK SBW** displays on the display panel. Repeat the steps above.

Note

- The subwoofer should be within 6 meters from the main unit in an open area (the closer the better).
- Remove any obstacles between the subwoofer and the main unit.
- If the wireless connection fails again, check if there is a conflict or strong interference (e.g. interference from an electronic device) around the location. Remove them and try again.
- If the wireless dis-connection or pairing lasts for 1 minute, the subwoofer automatically switches to standby and the LED on the subwoofer turns off.

Pair up with detachable wireless surround speakers

The detachable wireless surround speakers automatically pair up with the main unit for

wireless connection when you turn on the main unit and the wireless speakers.

Manual pairing

If no audio from the detachable wireless surround speakers can be heard, manually pair up the wireless speakers.

- 1 Turn on the main unit and the wireless speakers.
 - » If the connection to the main unit is lost, the LED on the wireless speaker blinks red.
- 2 Dock the wireless left and right speakers into the main unit to pair up automatically.
 - » If the pairing succeeds, **SL PAIRED** (surround left speaker) and **SR PAIRED** (surround right speaker) display on the display panel.
- 3 If the pairing fails, re-dock the wireless speakers into the main unit.

Charge the detachable wireless surround speakers

If the wireless surround left/right speaker is undocked from the main unit, its battery level is indicated by the LED on the speaker.

- Light up white: full battery or more than 20% capacity remaining
- Flash red: low battery level, less than 20% capacity remaining
- Flash red and turn off: near empty, less than 10% capacity remaining

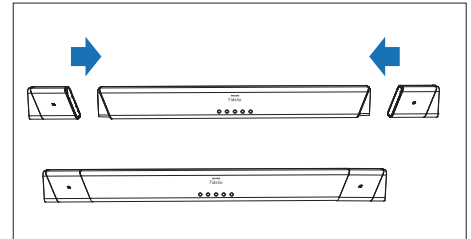

- 1 Dock your wireless speakers into the main unit to charge.
- 2 Turn on the main unit.
 - » During charging, the LED on the wireless speaker lights up red.
 - » When fully charged, the LED on the wireless speaker turns off.

 Note

- You can also charge the wireless speakers through the USB-C charging port by using a USB-C charging cable.
- It may take around 2 hours to fully charge the wireless speakers.
- Battery performance varies due to many factors including volume, sound setting and media played.

Connect to Wi-Fi (Wireless Operation)

(For iOS and Android version)

By connecting this unit and mobile devices (such as iPad, iPhone, iPod touch, Android phones, etc.) to the same Wi-Fi network, you can then use the Philips Sound app powered by DTS Play-Fi to control the soundbar to listen to audio files.

- 1 Connect your phone or tablet to the same Wi-Fi network that you want to connect your soundbar.
- 2 Download and install the Philips Sound app powered by DTS Play-Fi on your device.
 - * Make sure your router is turned on and working properly.
- 3 Press and hold the (Wi-Fi) button located on the back cabinet for 8 seconds to trigger the Wi-Fi connection.
 - » Until the speaker makes a second tone and then release the button.
- 4 Wait until the Wi-Fi LED indicator on the front cabinet goes from a fast blink to a slow pulse. When it begins to slow

pulsing indicating that the speaker is entering the Wi-Fi setup mode.

- 5 Launch the Philips Sound app powered by DTS Play-Fi. Follow the instructions in the app to connect this product to your Wi-Fi network.
 - » If the connection succeeds, PLAY-Fi displays on the display panel.

 Note

For iOS version only

Wi-Fi network used by iPhone should be switched temporarily to Play-Fi device AP and restart Philips Sound app to complete the product's Wi-Fi setup. See the steps below:

- Go to Settings.
- Select Wi-Fi setting.



- Select the Play-Fi device in the Wi-Fi setup.
- Return to Philips Sound app to continue the setup.



- 6 After successful Wi-Fi connection, the Wi-Fi LED indicator on the front cabinet will stop pulsing and turn solid. Once you set up this product on your Wi-Fi network, you can control it from any smartphone or tablet on the same network.
 - » When using the app to play music, the display panel will show PLAY-Fi.

- 7 After connection, you can change the device name. There are several names to choose from or create your own by choosing Custom Name at the bottom of the name list. Otherwise, it follows the default name.
- 8 After connection, this product may perform a software update.
 - » Upgrade to the latest software when it is set up for the first time. The software upgrade may take several minutes. Do not unplug your speaker, turn off your device, or break the network during the update.

AirPlay setup

Use AirPlay to set up the Wi-Fi connection between iOS device (iOS7 or later) and soundbar.

- 1 iOS device: Settings > Wi-Fi > select home network [Play-Fi device (xxxxxx)].
- 2 Launch the Philips Sound app powered by DTS Play-Fi. Follow the instructions in the app to connect this product to your Wi-Fi network.
 - » After successful Wi-Fi connection, the Wi-Fi LED indicator on the front cabinet will stop pulsing and turn solid. Once you set up this product on your Wi-Fi network, you can control it from any smartphone or tablet on the same network.
 - » When using the app to play music, the display panel will show PLAY-FI.
- 3 After connection, you can change the device name. There are several names to choose from or create your own by choosing Custom Name at the bottom of the name list. Otherwise, it follows the default name.
- 4 After connection, this product may perform a software update.
 - » Upgrade to the latest software when it is set up for the first time. The software upgrade may take several minutes. Do not unplug your speaker, turn off your device, or break the network during the update.

Note

- After connection, the product may perform a software update. Upgrade is required after initial setup. Without the upgrade, not all product features can be available.
- When the first-time setup is not successful, press and hold the Wi-Fi button on the soundbar for 8 seconds until the second tone can be heard and the Wi-Fi LED is changed to slow pulse. Reset the Wi-Fi connection, restart the app and start the setup again.
- If you want to change from one network to another, you need to set up the connection again. Press and hold the Wi-Fi button the soundbar for 8 seconds to reset the Wi-Fi connection..

WPS mode

If your router has Wi-Fi Protected Setup (WPS), you can set up the connection without entering a password.

- 1 Press and hold the Wi-Fi button for 4 seconds. You will hear a tone and the Wi-Fi LED will begin in double blink.
- 2 Press the WPS button on your router. The button is normally marked with this WPS logo.
 
- 3 Follow the instruction in Philips Sound app powered by DTS Play-Fi to start the pairing.

Note

- WPS is not a standard feature on all routers. If your router does not have WPS then use the standard Wi-Fi setup.
- Press the Wi-Fi button once if you want to exit the WPS mode or it will automatically exit after 2 minutes..

4 Use your product

This section helps you use this product to play media contents from all sources.

Before you start

- Make the necessary connections described in the quick start guide and the user manual.
- Switch this product to the correct source for other devices.

Insert batteries before using the remote control

Slide to remove the battery compartment cover, insert 2 AAA batteries (1.5V) with correct polarity, then slide the battery compartment cover back into position.

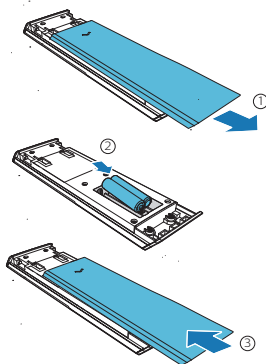

Adjust the volume

Press +/- (Volume) to increase or decrease a volume level.

- To mute sound, press **⏏**.
- To restore the sound, press **⏏** again or press +/- (Volume).

Choose your sound

This section helps you choose the ideal sound for your video or music.

Preset EQ modes

Select predefined sound modes to suit your video or music.

Press **EQ** on the remote control to select a preset EQ mode.

- **MOVIE**: Create a surround listening experience. Ideal for watching movies.
- **MUSIC**: Create two-channel or multi-channel stereo sound. Ideal for listening to music.
- **VOICE**: Create sound effect which makes human voice more clear and outstanding for listening.
- **SPORT**: Create an atmosphere as if watching a sports game in a stadium.
- **CUSTOM**: Customize the sound based on your preferences (controlled in Philips Sound app: Settings > Fine Tune).

Bass/Treble levels adjustment

Change the low frequency (bass) and high frequency (treble) settings of this product.

Repeatedly press **EQ** to select **BASS** or **TREBLE**, then press the left and right navigation buttons to change the bass or treble level.

The changes are effective in MOVIE, MUSIC, VOICE and SPORT EQ modes.

IMAX Enhanced mode

Repeatedly press **EQ** to select **IMAX**, then press the left and right navigation buttons to set IMAX mode on or off.

Mode	Function
Auto	IMAX Enhanced mode is detected and engaged automatically.
On	IMAX Enhanced mode is engaged even for DTS 5.1 bitstreams.
Off	Disable IMAX Enhanced mode for all bitstreams.

Surround mode (SURR)

Repeatedly press  to select **SURR**, then press the left and right navigation buttons to select surround mode options.

- **UPMX**: Up-mixing mode for driving output to all speakers even when content with audio channels lesser than the 5.1.2 (B95) or 7.1.2 (B97) speaker configuration. Up-mixing technology from Dolby or DTS is applied according to content type.
- **STD**: Standard mode for delivering original sound. The speaker outputs will follow the audio channels in content. (Note: If the audio content is 2.0 channel, only the left & right channel speakers and the subwoofer will output sound. Use UPMIX if virtual surround is desired.)
- **A-I**: The media intelligence function of Dolby Atmos for home audio is utilized to drive the vocal enhancement or surround effects.

Dynamic Range Control (DRC)

You can apply dynamic range control to Dolby or DTS bitstreams.

Repeatedly press  to select **DRC**, then press the left and right navigation buttons to turn DRC on, off or auto.



Note

- DRC is not available in BT/AUDIO IN/Play-Fi mode.

Dialogue Control (DLG CTRL)

Dialogue mode improves the clarity of dialogue and vocals in movies, TV programs and podcasts by adjusting the tonal balance of this product.

Repeatedly press  to select **DLG CTRL**, then press the left and right navigation buttons to adjust dialogue level. This control is supported in DTS:X stream only.

Synchronize video and sound (SYNC)

If the audio and video are not synchronized, delay the audio to match the video.

Repeatedly press  to select **SYNC**, then press the left and right navigation buttons to synchronize the audio with the video.

Dolby Atmos®

In addition to horizontal distribution of 5-channel audio, this product also has built-in Dolby Atmos enabled speakers as additional audio channels to generate overhead distribution of audio for powerful delivery of 3D sound immersion and greater reality.

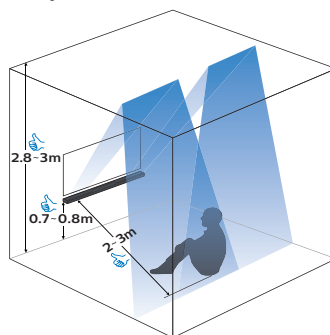

Optimal setup for Dolby Atmos sound

- Place this product at a height of 0.7m-0.8m.
- Ceiling height is 2.8m-3m.
- Listening distance from this product is 2m-3m.
- Ceiling is not made of sound absorbent material.
- Preferably no protrusive objects (such as lighting and decorations) are on the ceiling.

Dolby Atmos® is available only in HDMI mode. For the details of the connection, please refer to “Connect to TV”. Best Dolby Atmos effects may be achieved through the following two use cases.

From your Blu-ray disc player:

- Movie with Dolby Atmos.
- Your Blu-ray disc player is connected to this product via **HDMI IN 1/2** connector.
- On your Blu-ray disc player, enable bitstream/raw audio format for HDMI sound output.
- A high-speed HDMI cable.

From your TV:

- Movie with Dolby Atmos.
- Your TV supports Dolby Atmos bitstream/raw output.
- Your TV is connected to this product via **HDMI OUT** connector.
- A high-speed HDMI cable.



Note

- The full Dolby Atmos experience is only available when the soundbar is connected to the source via a HDMI 2.0 cable.
- The soundbar will still work when connected via other methods (such as a digital optical cable) but these are unable to support all the Dolby features. To ensure full Dolby support, you are strongly recommended to connect via HDMI.

Enjoy Dolby Atmos sound

Press **Dolby Atmos** to select a height surround effects level to best suit your personal taste according to your environment.

- **ATMOS 00**: minimal height effect.
- **ATMOS 01**: small height effect.
- **ATMOS 02**: medium height effect.
- **ATMOS 03**: big height effect.



Note

- For non-HDMI connections (such as use of Bluetooth, OPTICAL or AUDIO IN), only limited height surround effects are generated.

Play audio through Bluetooth

Through Bluetooth, connect this product with your Bluetooth device (such as an iPhone, iPad, Android phone, or Android pad), and then you can enjoy the audio files stored on the device through the speakers of this product.



Note

- The maximum operational range between this product and a Bluetooth device is approximately 10 meters (30 feet).
- The music streaming may be interrupted by obstacles between the device and this product, such as wall, metallic casing that covers the device, or other devices nearby that operate in the same frequency.
- If you want to connect this product with another Bluetooth device, break the current Bluetooth connection first.

- 1 Repeatedly press the source button to switch the main unit to Bluetooth mode, and wait until the display to show **BT PAIR** for starting the pairing operation.
- 2 On the Bluetooth device, turn on Bluetooth, search for and select "**Play-Fi Device (XXXXXX)-BT**" to start connection.
 - » When the Bluetooth connection succeeds, **BT CONNECTED** displays on the display panel.
 - » If the connection fails, **BT PAIR** displays on the display panel.
- 3 Select and play audio files or music on your Bluetooth device.
- 4 To exit Bluetooth, select another source.

MP3 player

Connect your MP3 player to play your audio files or music.

What you need

- An MP3 player.
- A 3.5mm stereo audio cable.

- 1 Using the 3.5mm stereo audio cable, connect the MP3 player to the **AUDIO IN** connector on this product.
- 2 Repeatedly press the source button until **AUDIO IN** displays on the display panel.
- 3 Press the buttons on your MP3 player to select and play audio files or music.

Play-Fi multi-room

With Play-Fi built-in, your soundbar can sync or group with multiple Play-Fi enabled speakers for multi-room music which allows you to listen to the same song in every room of your house or different songs in different defined zones. All these are controlled by Philips Sound app. Source will be switched to Play-Fi as long as your soundbar is selected in the app.

To download Philips Sound app, please refer to “Wi-Fi (Wireless operation)” section.

To learn more about Play-Fi operation, please visit play-fi.com.

Chromecast(audio) / AirPlay2 / Alexa 3PDA

Your soundbar is built-in with services running in background which support Chromecast(audio), AirPlay2 or Alexa 3PDA. When Wi-Fi is connected, you can cast audio from corresponding devices/apps at any time. Source will be switched automatically when respective streaming is detected.

Listen to Spotify

Use your phone, tablet or computer as a remote control for Spotify, go to spotify.com/ connect to learn how.

5 Settings

Adjust speaker level

Repeatedly press **⚙** to enter the settings menu, select the speakers below and press the left and right navigation buttons to adjust the speaker level

- **SUB** (subwoofer)
- **CTR XX** (center speaker)
- **SIDE L XX** (side left speaker)
- **SIDE R XX** (side right speaker)

Set display brightness

Repeatedly press **⚙** to enter the settings menu, select **DIM** and press the left and right navigation buttons to adjust the brightness level of the display panel on this product.

- **HIGH** (high)
- **MID** (medium)
- **LOW** (low)

Display auto off

Repeatedly press **⚙** to enter the settings menu, select **DISP** and press the left and right navigation buttons to select **DISP ON** or **DISP OFF**.

Auto standby

When playing media from a connected device, this product automatically switches to standby if:

- no source button is pressed for 15 minutes, and
- no audio/video playback is detected from a connected device.

Apply factory settings

In case of no response from this product, you can reset this product to the default settings programmed at the factory.

Power on, press and hold **VOL +/-** buttons on the main unit simultaneously for 8 seconds until **RESET** displays on the display panel.

When the factory settings restore is complete, the product automatically turns off and restarts.

6 Update software

To get the best features and support, update your product with the latest software.

Update software via Wi-Fi

Two parts in this product can be updated via Wi-Fi & Philips Sound App.

- 1 Play-Fi system
- 2 Audio system (Firmware) – handles all control and sound features

Play-Fi system

This part can be updated directly by Philips Sound app. Once the product is connected with the app, It will check and prompt for update if a newer version software is available. Follow the steps on screen to complete the update. It is done over the air and the update time requires less than 10 minutes in normal network condition.

Audio system (Firmware)

This part can be updated via the special tool (PS Fine Tune) provided in setting menu of Philips Sound App (settings>Fine Tune/Update Firmware). When the update is available, the download icon will be shown (see the 2nd App screen capture below). Follow the steps provided on screen to complete the update.

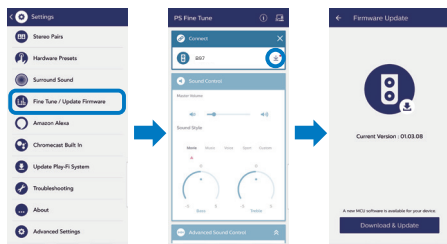

Caution

- During update, smartphone is required to turn on and stay in the update screen until the whole process is finished.
- It may take 10-30minutes and please arrange update to be done in product unused time.

Update via USB



Caution

- Do not turn off the power or remove the USB flash drive when the software update is in progress because you might damage this product.
- The upgrade time may take around 8 minutes.

- 1 Check if there is the latest software version on www.philips.com/support.
 - » Search for your model and click on “Software and drivers”.
- 2 Download the software into a USB flash drive.
 - » Unzip the downloaded file and make sure that the unzipped folder is named “update.zip”.
 - » Put the “update.zip” folder in the root directory.
- 3 When turned on, plug the USB flash drive into the **USB** port of this product.
- 4 Press and hold  and **VOL+** buttons simultaneously for 3 seconds or select **UPGRADE** in setting menu.
 - » “**FW UPG**” (firmware upgrade) displays on the display panel.
- 5 Wait until the upgrade is completed.
 - » If the upgrade is complete, this product automatically turns off and on again.

7 Wall mount your product

Before you mount your product on the wall, read all safety precautions. (see 'Safety')

Wall mount the main unit

Note

- Improper wall mounting may result in accident, injury or damage. If you have any query, contact Consumer Care in your country.
- Secure the wall mount to a wall that can support the combined weight of the product and the wall mount.
- Before wall mount, you need not remove the four rubber feet at the bottom of the main unit, otherwise the rubber feet cannot be fixed back.

Screw length/diameter

Depending on the type of wall mounting this product, make sure that you use screws of a suitable length and diameter.

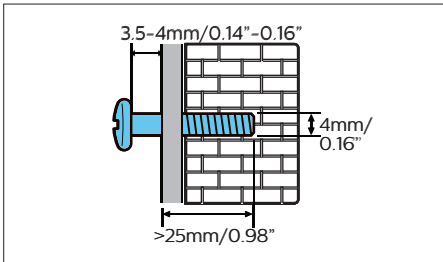

See the illustrations below on how to wall mount this product.

- 1 Drill 2 holes on the wall. Use the supplied paper template to mark 2 holes on the wall, then secure 2 suitable screws in the holes.
- 2 Secure the wall bracket on the wall with the dowels and screws.
- 3 Hook this product on the wall bracket.

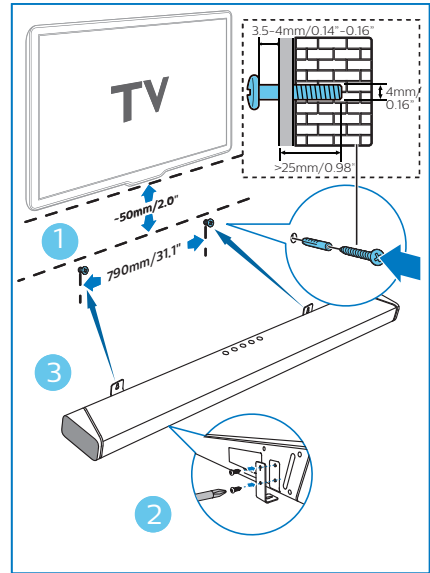

Mount the detachable wireless surround speakers (Optional)

The detachable wireless surround speakers can be mounted on the wall with the provided mounting bracket or be raised by using stands (not provided).

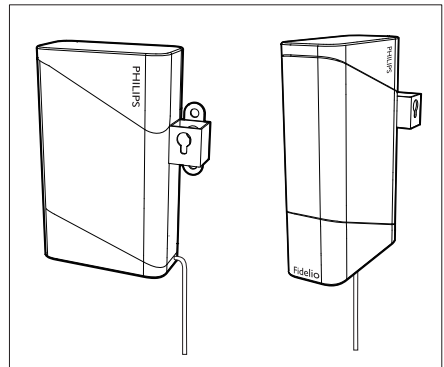

8 Product specifications



Note

- Specifications and design are subject to change without notice.

Amplifier

- Total output power: 888W MAX / 450W RMS (1%THD)
- Frequency response (main unit): 150Hz-20kHz
- Frequency response (Subwoofer): 35Hz-150Hz
- Signal-to-noise ratio: >65 db(CCIR) / (A-weighted)

Audio

- S/PDIF Digital audio input:
- Optical: TOSLINK

Bluetooth

- Bluetooth profile: A2DP,
- Bluetooth version: 4.2
- Frequency band/Output power: 2402 MHz ~ 2480 MHz / ≤ 2 dBm

Wi-Fi

- Wi-Fi IEEE 802.11 a/b/g/n
- Frequency band: 2.412 - 2.472 GHz, 5.18 - 5.32GHz, 5.50 - 5.70GHz, 5.745 - 5.825GHz
- Radio frequency power transmitted: WiFi 2.4G: 17.6dBm; WiFi 5G: 16.38dBm; WiFi 5.8G: 8.07dBm

Main unit

- Power supply: Model (Philips branded AC power adapter): NSA120EC-19063200
- Input: 100-240 V~, 50/60 Hz, 2.0 A
- Output: 19 V $\overline{\text{---}}$ 6.32 A
- Power consumption: 25 W
- Standby power consumption: <0.5 W

- Audio channel: 7.1.2
- Built-in speakers:
- Central: 2 racetracks full range drivers
- Front speaker: 4 full range drivers + 2 tweeters
- Up-firing: 2 full range drivers
- Side-firing: 2 tweeters
- Rear: 2 racetrack full range drivers (wireless) + 2 tweeters
- Dimensions (W x H x D): 1312 x 55.6 x 120 mm
- Weight: 5.97 kg
- Operating temperature: 0°C - 45°C

Subwoofer

- Power supply: 220-240 V~, 50/60 Hz
- Power consumption: 20 W
- Standby power consumption: <0.5 W
- Speaker driver: 1 x 8" subwoofer
- Impedance: 3 ohm
- Dimensions (W x H x D): 230 x 400 x 407 mm
- Weight: 9.6 kg
- Operating temperature: 0°C - 45°C

Audio codec format

- HDMI: Dolby Digital, Dolby Digital plus, Dolby Digital EX, Dolby TrueHD, Dolby Atmos, DTS, DTS 96/24, DTS-ES, DTS Digital Surround (5.1-ch), DTS-HD High Resolution Audio, DTS-HD Master Audio, DTS ES, DTS: X, IMAX Enhanced
- HDMI eARC: Dolby Digital, Dolby Digital plus, Dolby Digital EX, Dolby TrueHD, Dolby Atmos, DTS, DTS 96/24, DTS-ES, DTS Digital Surround (5.1-ch), DTS-HD High Resolution Audio, DTS-HD Master Audio, DTS ES, DTS: X
- Optical: Dolby Digital, Dolby Digital plus, LPCM 2ch
- Bluetooth: SBC
- Play-Fi: MPEG4 AAC, MPEG4 M4A, MP3, WAV, FLAC, AIFF

9 Troubleshooting



Warning

- Risk of electric shock. Never remove the casing of the product.

To keep the warranty valid, never try to repair the product yourself.

If you have problems using this product, check the following points before you request service. If you still have a problem, get support at www.philips.com/support

Main unit

The buttons on the main unit do not work.

- Disconnect from the power supply for a few minutes, then connect again.

Sound

No sound from the soundbar speaker.

- Connect the audio cable from your soundbar to your TV or other devices. However, you do not need a separate audio connection when:
 - the soundbar and TV are connected through HDMI ARC connection, or
 - a device is connected to the HDMI IN connector on your soundbar.
- On the remote control, select the correct audio input.
- Make sure that the soundbar is not muted.
- Reset this product to its factory settings (see “Apply factory settings”).

No sound from the wireless subwoofer.

- Manually connect the subwoofer to the main unit (see “Pair up with the subwoofer”).

Distorted sound or echo.

- If you play audio from TV through this product, make sure that the TV is muted.

Audio and video are not synchronized.

- Press  to synchronize the audio with the video.

Bluetooth

A device cannot connect with the soundbar.

- The device does not support the compatible profiles required for the soundbar.
- You have not enabled the Bluetooth function of the device. See the user manual of the device on how to enable the function.
- The device is not correctly connected. Connect the device correctly.
- The soundbar is already connected with another Bluetooth device. Disconnect the connected device, then try again.

Quality of audio play from a connected Bluetooth device is poor.

- The Bluetooth reception is poor. Move the device closer to the soundbar, or remove any obstacle between the device and the soundbar.

Wi-Fi

Wi-Fi connection cannot be established.

- Check the availability of the WLAN network on the router.
- Place the Wi-Fi router closer to this product.
- Make sure the password is correct.
- Check the WLAN function or reboot the modem and Wi-Fi router.

Dolby Atmos

Cannot achieve outstanding Dolby Atmos effects.

- For non-HDMI connections (such as use of Bluetooth, OPTICAL or AUDIO IN), limited height surround effects are generated. See the section of ‘Dolby Atmos’ about how to achieve best Dolby Atmos effects.

Play-Fi

Cannot discover the Play-Fi supported devices from the app.

- Make sure the device is connected to the Wi-Fi.

Cannot play Play-Fi music.

- Certain network service or contents available through the device may not be accessible in case the service provider terminates its service.

COMPATIBLE WITH



Dolby, Dolby Vision, Dolby Atmos, and the double-D symbol are registered trademarks of Dolby Laboratories Licensing Corporation. Manufactured under license from Dolby Laboratories. Confidential unpublished works.

Copyright © 2012-2020 Dolby Laboratories. All rights reserved.



Manufactured under license from IMAX Corporation. IMAX[®] is a registered trademark of IMAX Corporation in the United States and/or other countries. Manufactured under license from DTS Licensing Limited. DTS, the Symbol, DTS and the Symbol together are registered trademarks or trademarks of DTS, Inc. in the United States and/or other countries.

© DTS, Inc. All Rights Reserved.



Manufactured under license from DTS Licensing Limited. DTS, the Symbol, & DTS and the Symbol together, DTS:X, and the DTS:X logo are registered trademarks or trademarks of DTS, Inc. in the United States and/or other countries.

© DTS, Inc. All Rights Reserved.



For DTS patents, see <http://patents.dts.com>. Manufactured under license from DTS, Inc. (for companies headquartered in the U.S./ Japan/Taiwan) or under license from DTS Licensing Limited (for all other companies). DTS, Play-Fi, and the DTS Play-Fi logo are registered trademarks or trademarks of DTS, Inc. in the United States and other countries.

© 2020 DTS, Inc. ALL RIGHTS RESERVED.

23 EN



To control this AirPlay 2–enabled speaker, iOS 11.4 or later is required.

Use of the Works with Apple badge means that an accessory has been designed to work specifically with the technology identified in the badge and has been certified by the developer to meet Apple performance standards.

Apple[®] and AirPlay[®] are trademarks of Apple Inc., registered in the U.S. and other countries.



The Adopted Trademarks HDMI, HDMI High-Definition Multimedia Interface, and the HDMI Logo are trademarks or registered trademarks of HDMI Licensing Administrator, Inc. in the United States and other countries.



The Wi-Fi CERTIFIED[™] Logo is a registered trademark of Wi-Fi Alliance[®].



The Bluetooth[®] word mark and logos are registered trademarks owned by Bluetooth SIG, Inc. and any use of such marks by MMD Hong Kong Holding Limited is under license. Other trademarks and trade names are those of their respective owners.



Chromecast is a trademark of Google Inc. Google Play, and the Google Play logo are trademarks of Google Inc.



Specifications are subject to change without notice.
2020 © Philips and the Philips Shield Emblem are registered trademarks of Koninklijke Philips N.V. and are used under license. This product has been manufactured by and is sold under the responsibility of MMD Hong Kong Holding Limited or one of its affiliates, and MMD Hong Kong Holding Limited is the warrantor in relation to this product.

