

Register your product and get support at

www.philips.com/welcome

HTS5563

HTS5593

User manual

Manual del usuario

Manual do Usuário

PHILIPS

Contents

1 Help and support	2
Use onscreen Help (user manual)	2
Navigate onscreen Help	2

2 Important	3
Safety	3
Care for your product	4
Care of the environment	4
3D health warning	4

3 Your home theater	5
Remote control	5
Main unit	7
Connectors	7

4 Connect and set up	9
Connect speakers	9
Connect to TV	10
Connect digital devices through HDMI	12
Connect audio from TV and other devices	12
Set up speakers	13
Set up EasyLink (HDMI-CEC control)	13
Connect and set up a home network	14

5 Use your home theater	16
Access the home menu	16
Discs	16
Data files	18
USB storage devices	19
Audio, video, and picture options	19
Radio	20
MP3 player	21
iPod or iPhone	21
Smartphone control	22
Browse Online TV	23
Browse PC through DLNA	24
Karaoke	25
Choose sound	25

6 Change settings	26
Language settings	26
Picture and video settings	27
Audio settings	27
Parental control settings	27
Display settings	27
Energy saving settings	28
Speaker settings	28
Restore default settings	28

7 Update software	29
Check software version	29
Update software through USB	29
Update software through the Internet	30
Update the onscreen help	30

8 Product specifications	31
---------------------------------	----

9 Troubleshooting	34
--------------------------	----

10 Notice	36
Open source software	36
RMVB end user agreement (Asia Pacific and China only)	37
Trademarks	37

11 Language code	39
-------------------------	----

12 Index	40
-----------------	----

1 Help and support

Philips provides extensive online support. Visit our website at www.philips.com/support to:

- download the complete user manual
- print the quick start guide
- watch video tutorials (available only for selected models)
- find answers to frequently answered questions (FAQs)
- email us a question
- chat with our support representative.

Follow the instructions on the website to select your language, and then enter your product model number.

Alternatively, you can contact Philips Consumer Care in your country. Before you contact Philips, note down the model number and serial number of your product. You can find this information on the back or bottom of your product.

Use onscreen Help (user manual)

For easy access, the onscreen help (user manual) is stored on your home theater.

The onscreen help has two panels.

- The left panel contains two tabs - **Contents** and **Index**. Navigate the **Contents** or **Index** to select a topic. The legends used to display the **Contents** are as follows:
 - **▶**: Press **OK** to expand the subtopics.
 - **▼**: Press **OK** to collapse the subtopics, or press **Navigation buttons** (up/down) to select a topic.
- The right panel contains the content of the selected topic. For additional help on the content, scroll down the page to see **Related topics**.

Use the home theater remote control to select and navigate the onscreen help (see 'Navigate onscreen Help' on page 2).

Navigate onscreen Help

Press a button on your remote control to use onscreen help.

Button	Action
HELP	Access or exit onscreen help.
OK	Display the selected page, or expand subtopics in Contents .
Navigation buttons	Up: Scroll up or move to the previous page. Down: Scroll down or move to the next page. Right: Navigate to the right panel or next index entry. Left: Navigate to the left panel or previous index entry.
↶ BACK	Move up in the Contents or Index . From the right panel, move to the Contents on the left panel.
◀ (Previous)	Display the last viewed page in history.
▶ (Next)	Display the next page from history.

2 Important

Read and understand all instructions before you use your product. If damage is caused by failure to follow instructions, the warranty does not apply.

Safety

Risk of electric shock or fire!

- Never expose the product and accessories to rain or water. Never place liquid containers, such as vases, near the product. If liquids are spilled on or into the product, disconnect it from the power outlet immediately. Contact Philips Consumer Care to have the product checked before use.
- Never place the product and accessories near naked flames or other heat sources, including direct sunlight.
- Never insert objects into the ventilation slots or other openings on the product.
- Where the mains plug or an appliance coupler is used as the disconnect device, the disconnect device shall remain readily operable.
- Disconnect the product from the power outlet before lightning storms.
- When you disconnect the power cord, always pull the plug, never the cable.

Risk of short circuit or fire!

- Before you connect the product to the power outlet, ensure that the power voltage matches the value printed on the back or bottom of the product. Never connect the product to the power outlet if the voltage is different.

Risk of injury or damage to the home theater!

- For wall-mountable products, use only the supplied wall mount bracket. Secure the wall mount to a wall that can support the combined weight of the product and the wall mount. Koninklijke Philips Electronics N.V. bears no responsibility for improper wall mounting that results in accident, injury or damage.
- For speakers with stands, use only the supplied stands. Secure the stands to the speakers tightly. Place the assembled stands on flat, level surfaces that can support the combined weight of the speaker and stand.

- Never place the product or any objects on power cords or on other electrical equipment.
- If the product is transported in temperatures below 5°C, unpack the product and wait until its temperature matches room temperature before connecting it to the power outlet.
- Visible and invisible laser radiation when open. Avoid exposure to beam.
- Do not touch the disc optical lens inside the disc compartment.
- Parts of this product can be made of glass. Handle with care to avoid injury and damage.

Risk of overheating!

- Never install this product in a confined space. Always leave a space of at least four inches around the product for ventilation. Ensure curtains or other objects never cover the ventilation slots on the product.

Risk of contamination!

- Do not mix batteries (old and new or carbon and alkaline, etc.).
- Danger of explosion if batteries are incorrectly replaced. Replace only with the same or equivalent type.
- Remove batteries if they are exhausted or if the remote control is not to be used for a long time.
- Batteries contain chemical substances, they should be disposed of properly.

Risk of swallowing batteries!

- The product/remote control may contain a coin/button type battery, which can be swallowed. Keep the battery out of reach of children at all times! If swallowed, the battery can cause serious injury or death. Severe internal burns can occur within two hours of ingestion.
- If you suspect that a battery has been swallowed or placed inside any part of the body, seek immediate medical attention.
- When you change the batteries, always keep all new and used batteries out of reach of children. Ensure that the battery compartment is completely secure after you replace the battery.
- If the battery compartment cannot be completely secured, discontinue use of the product. Keep out of reach of children and contact the manufacturer.

Care for your product

- Do not insert any objects other than discs into the disc compartment.
- Do not insert warped or cracked discs into the disc compartment.
- Remove discs from the disc compartment if you are not using the product for an extended period of time.
- Use only microfiber cloth to clean the product.

Care of the environment



Your product is designed and manufactured with high quality materials and components, which can be recycled and reused.



When this crossed-out wheeled bin symbol is attached to a product it means that the product is covered by the European Directive 2002/96/EC. Please inform yourself about the local separate collection system for electrical and electronic products.

Please act according to your local rules and do not dispose of your old products with your normal household waste.

Correct disposal of your old product helps to prevent potential negative consequences for the environment and human health.



Your product contains batteries covered by the European Directive 2006/66/EC, which cannot be disposed with normal household waste.

Please inform yourself about the local rules on separate collection of batteries because correct disposal helps to prevent negative consequences for the environmental and human health.

3D health warning

If you or your family has a history of epilepsy or photosensitive seizures, consult a medical professional before exposing yourself to flashing light sources, rapid image sequences or 3D viewing.

To avoid discomfort such as dizziness, headache or disorientation, we recommend not watching 3D for extended periods of time. If you experience any discomfort, stop watching 3D and do not immediately engage in any potentially hazardous activity (for example driving a car) until your symptoms have disappeared. If symptoms persist, do not resume watching 3D without consulting a medical professional first.

Parents should monitor their children during 3D viewing and ensure they do not experience any discomfort as mentioned above. Watching 3D is not recommended for children under six years of age as their visual system is not fully developed yet.

3 Your home theater

Congratulations on your purchase, and welcome to Philips! To fully benefit from the support that Philips offers, register your product at www.philips.com/welcome.

Remote control

This section includes an overview of the remote control.

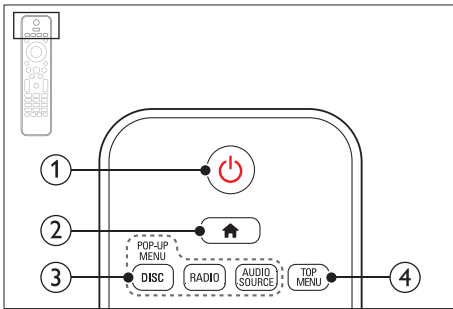

- ① **⏻ (Standby-On)**
 - Switch the home theater on or to standby.
 - When EasyLink is enabled, press and hold for at least three seconds to switch all connected HDMI CEC compliant devices to standby.
- ② **🏠 (Home)**

Access the home menu.
- ③ **Source buttons**
 - **DISC/POP-UP MENU:** Access or exit the disc menu when you play a disc.
 - **RADIO:** Switch to FM radio.
 - **AUDIO SOURCE:** Select an audio input source.
- ④ **TOP MENU**

Access the main menu of a video disc.

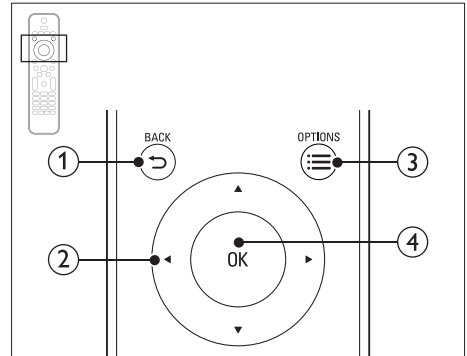

- ① **↶ BACK**
 - Return to a previous menu screen.
 - In radio mode, press and hold to erase the current preset radio stations.
- ② **Navigation buttons**
 - Navigate menus.
 - In radio mode, press left or right to start auto search.
 - In radio mode, press up or down to tune the radio frequency.
- ③ **☰ OPTIONS**
 - Access more play options while playing a disc or a USB storage device.
 - In radio mode, set a radio station.
- ④ **OK**

Confirm an entry or selection.

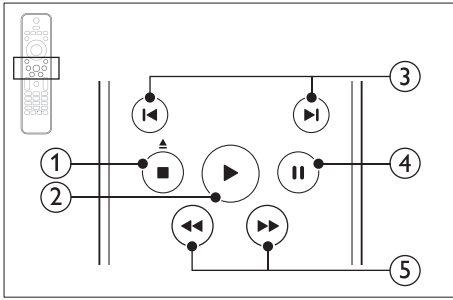

- ① **■ (Stop) / ▲ (Eject/Open/Close)**
 - Stop play.
 - Press and hold for three seconds to open or close the disc compartment, or eject the disc.
- ② **▶ (Play)**
Start or resume play.
- ③ **◀ / ▶ (Previous/Next)**
 - Skip to the previous or next track, chapter or file.
 - In radio mode, select a preset radio station.
- ④ **⏸ (Pause)**
Pause play.
- ⑤ **⏮ / ⏭ (Fast Backward/Fast Forward)**
Search backwards or forward. Press repeatedly to change the search speed.

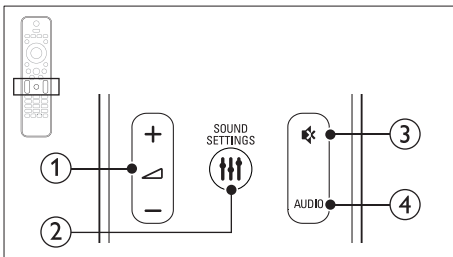

- ① **▲ +/- (Volume)**
Increase or decrease volume.
- ② **≡ SOUND SETTINGS**
Access or exit sound options.
- ③ **🔇 (Mute)**
Mute or restore volume.
- ④ **AUDIO**
Select an audio language or channel.

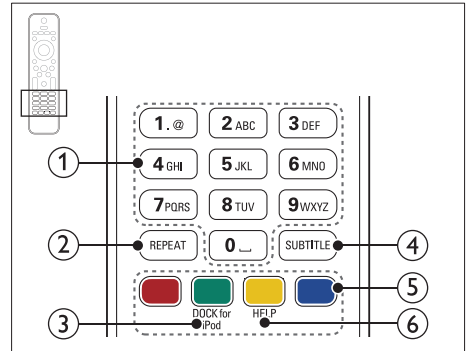

- ① **Alphanumeric buttons**
Enter values or letters (using SMS style entry).
- ② **REPEAT**
Select or turn off repeat mode.
- ③ **DOCK for iPod**
Switch to Philips dock for iPod or iPhone.
- ④ **SUBTITLE**
Select subtitle language for video.
- ⑤ **Color buttons**
Select tasks or options for Blu-ray discs.
- ⑥ **HELP**
Access the onscreen help.

Main unit

This section includes an overview of the main unit.

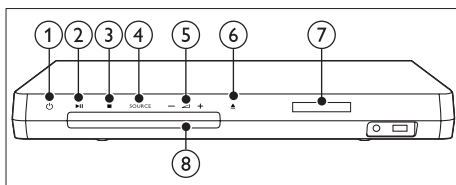

- ① **⏻ (Standby-On)**
Switch the home theater on or to standby.
- ② **▶|| (Play/Pause)**
Start, pause or resume play.
- ③ **■ (Stop)**
 - Stop play.
 - In radio mode, press and hold to erase the current preset radio stations.
- ④ **SOURCE**
Select an audio or video source for the home theater.
- ⑤ **+/-**
Increase or decrease volume.
- ⑥ **▲ (Open/Close)**
Open or close the disc compartment, or eject the disc.
- ⑦ **Display panel**
- ⑧ **Disc compartment**

Connectors

This section includes an overview of the connectors available on your home theater.

Front connectors

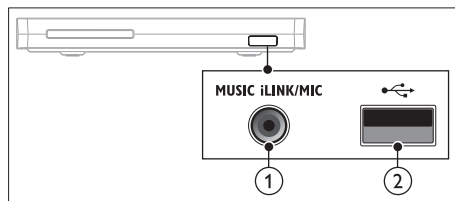

- ① **MUSIC iLINK / MIC (MIC is available only in selected models)**
Audio input from an MP3 player or a microphone.
Audio input from a microphone. (Available only in selected models)
- ② **↔ (USB)**
Audio, video or picture input from a USB storage device.

Rear left

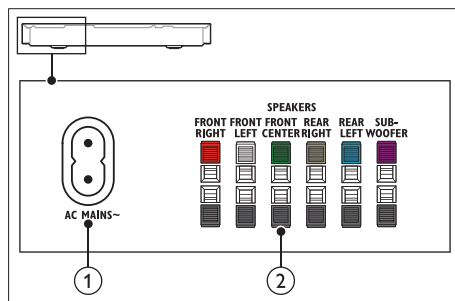

- ① **AC MAINS~**
Connect to the power supply.
- ② **SPEAKERS**
Connect to the supplied speakers and subwoofer.

Rear center

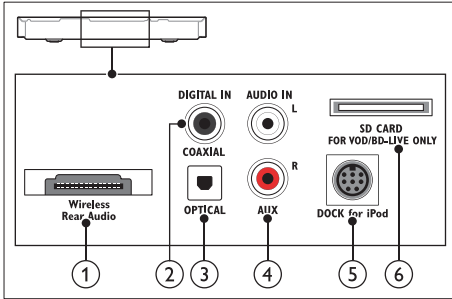

- ① **Wireless Rear Audio**
Connect to a Philips wireless module.(Model: Philips RWSS5512, sold separately)
- ② **DIGITAL IN-COAXIAL**
Connect to a coaxial audio output on the TV or a digital device.
- ③ **DIGITAL IN-OPTICAL**
Connect to an optical audio output on the TV or a digital device.
- ④ **AUDIO IN-AUX**
Connect to an analog audio output on the TV or an analog device.
- ⑤ **DOCK for iPod**
Connect to a Philips dock for iPod or iPhone. (Model: Philips DCK306x)
- ⑥ **SD CARD FOR VOD/BD-LIVE ONLY (Not available in China)**
Slot for SD card. The SD card is used to rent online videos and access BD-Live.

Rear right

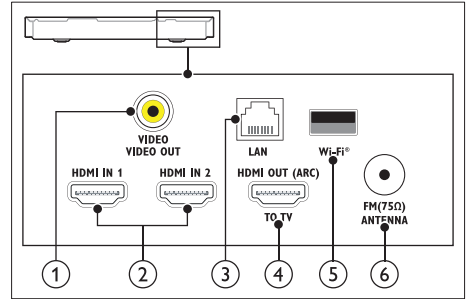

- ① **VIDEO-VIDEO OUT**
Connect to the composite video input on the TV.
- ② **HDMI IN1 / HDMI IN2**
Connect to the HDMI output on a digital device.
- ③ **LAN**
Connect to the LAN input on a broadband modem or router.
- ④ **HDMI OUT (ARC) TO TV**
Connect to the HDMI input on the TV.
- ⑤ **Wi-Fi**
Connect to a Wi-Fi dongle (Model: Philips WUB1110, sold separately).
- ⑥ **ANTENNA FM 75 Ω**
Signal input from an antenna, cable or satellite.

4 Connect and set up

This section helps you connect your home theater to a TV and other devices, and then set it up. For information about the basic connections of your home theater and accessories, see the quick start guide. For a comprehensive interactive guide, visit www.connectivityguide.philips.com.

Note

- For identification and supply ratings, see the type plate at the back or bottom of the product.
- Before you make or change any connections, make sure that all devices are disconnected from the power outlet.

Connect speakers

The speaker cables are color-coded for easy connection. To connect a speaker to your home theater, match the color on the speaker cable to the color on the connector:

Speaker position plays a critical role in setting up a surround sound effect. For best effect, position all the speakers towards the seating position and place them close to your ear level (seated).

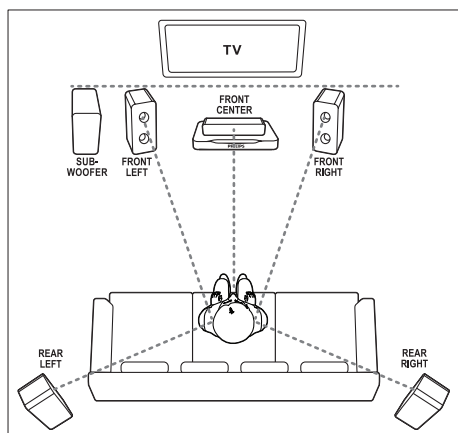

Note

- Surround sound depends on factors such as room shape and size, type of wall and ceiling, windows and reflective surfaces, and speaker acoustics. Experiment with the speaker positions to find the optimum setting for you.

Follow these general guidelines for speakers placement.

- 1 Seating position:**
This is the center of your listening area.
- 2 FRONT CENTER** (front center) speaker:
Place the center speaker directly in front of the seating position, either above or below your TV.
- 3 FRONT LEFT** (front left) and **FRONT RIGHT** (front right) speakers:
Place the left and right speakers in the front, and at equal distance from the center speaker. Make sure that the left, right, and the center speakers are at equal distance from your seating position.
- 4 REAR LEFT** (rear left) and **REAR RIGHT** (rear right) speakers:
Place the rear surround speakers to the left and right side of your seating position, either in line with it or slightly behind it.
- 5 SUBWOOFER** (subwoofer):
Place the subwoofer at least one meter to the left or right of the TV. Leave about 10-centimeter clearance from the wall.

Make your rear speakers wireless

Connect the rear speakers to your home theater wirelessly using a wireless module accessory. For details, see the wireless module user manual.

What you need

- A Philips wireless module. (Model: Philips RWSS5512, sold separately)

- 1 Connect the wireless transmitter to the **Wireless Rear Audio** connector on your home theater.

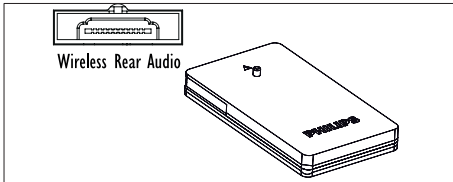

- 2 Connect the rear speakers to the wireless receiver.
- 3 Connect the wireless receiver to the power supply.

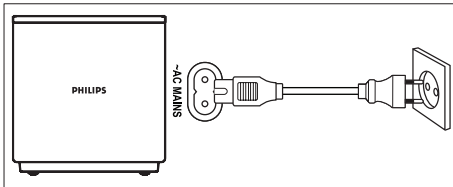

Connect to TV

Connect your home theater to a TV to watch videos. You can listen to the TV audio through your home theater speakers.

Use the best quality connection available on your home theater and TV.

Option 1: Connect to TV through HDMI (ARC)

Best quality video

Your home theater supports HDMI version 1.4 - Audio Return Channel (ARC). If your TV is HDMI ARC compliant, you can hear the TV audio through your home theater by using a single HDMI cable.

- 1 Using a High Speed HDMI cable, connect the **HDMI OUT (ARC)** connector on your home theater to the **HDMI ARC** connector on the TV.
 - The **HDMI ARC** connector on the TV might be labeled differently. For details, see the TV user manual.
- 2 On your TV, turn on HDMI-CEC operations. For details, see the TV user manual.
 - If you cannot hear the TV audio through your home theater, set up the audio manually (see 'Set up the audio' on page 14).

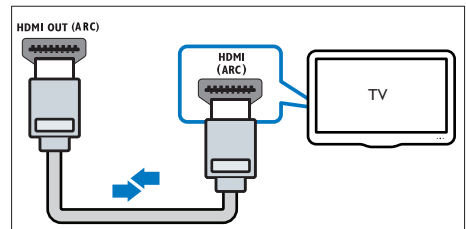

Option 2: Connect to TV through standard HDMI

Best quality video

If your TV is not HDMI ARC compliant, connect your home theater to the TV through a standard HDMI connection.

- 1 Using a High Speed HDMI cable, connect the **HDMI OUT (ARC)** connector on your home theater to the **HDMI** connector on the TV.
- 2 Connect an audio cable to hear the TV audio through your home theater (see 'Connect audio from TV and other devices' on page 12).
- 3 On your TV, turn on HDMI-CEC operations. For details, see the TV user manual.
 - If you cannot hear the TV audio through your home theater, set up the audio manually (see 'Set up the audio' on page 14).

Note

- If your TV has a DVI connector, you can use an HDMI/DVI adapter to connect to TV. However, some of the features may not be available.

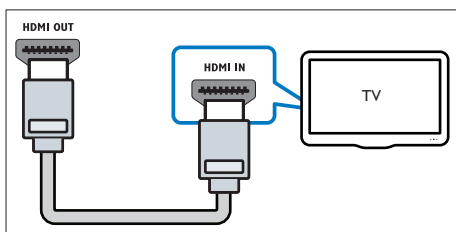

Option 3: Connect to the TV through composite video

Basic quality video

If your TV does not have HDMI connectors, use a composite video connection. A composite connection does not support high-definition video.

- 1 Using a composite video cable, connect the **VIDEO** connector on your home theater to the **VIDEO IN** connector on the TV.
 - The composite video connector might be labeled **AV IN**, **COMPOSITE**, or **BASEBAND**.
- 2 Connect an audio cable to hear the TV audio through your home theater (see 'Connect audio from TV and other devices' on page 12).
- 3 When you watch TV programs, press **SOURCE** on your home theater repeatedly to select the correct audio input.
- 4 When you watch videos, switch your TV to the correct video input. For details, see the TV user manual.

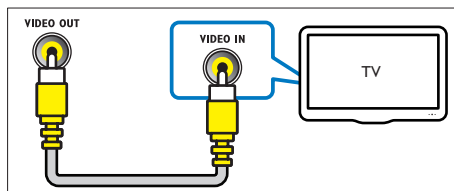

Connect digital devices through HDMI

Connect a digital device such as a set-top box, games console, or camcorder to your home theater through a single HDMI connection. When you connect the devices in this way and play a file or game, the

- video is automatically displayed on your TV, and
- audio is automatically played on your home theater.

- 1 Using a High Speed HDMI cable, connect the **HDMI OUT** connector on your digital device to the **HDMI IN 1/2** on your home theater.
- 2 Connect your home theater to TV through **HDMI OUT (ARC)**.
 - If the TV is not HDMI CEC compliant, select the correct video input on your TV.
- 3 On the connected device, turn on HDMI-CEC operations. For details, see the user manual of the device.
 - If you cannot hear the digital device audio through your home theater, set up the audio manually (see 'Set up the audio' on page 14).
 - You can also press **SOURCE** on your home theater repeatedly to select the correct HDMI input.

Connect audio from TV and other devices

Play audio from TV or other devices through your home theater speakers.

Use the best quality connection available on your TV, home theater, and other devices.

Note

- The audio connections in this user manual are only recommendations. You can use other connections too.
- When your home theater and TV are connected through **HDMI ARC**, an audio connection is not required.

Option 1: Connect audio through a digital optical cable

Best quality audio

- 1 Using an optical cable, connect the **OPTICAL** connector on your home theater to the **OPTICAL OUT** connector on the TV or other device.
 - The digital optical connector might be labeled **SPDIF** or **SPDIF OUT**.

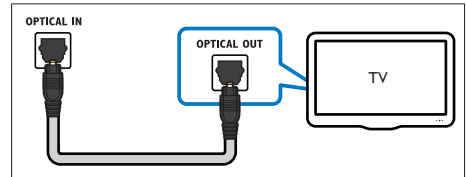

Option 2: Connect audio through a digital coaxial cable

Good quality audio

- 1 Using a coaxial cable, connect the **COAXIAL** connector on your home theater to the **COAXIAL/DIGITAL OUT** connector on the TV or other device.
 - The digital coaxial connector might be labeled **DIGITAL AUDIO OUT**.

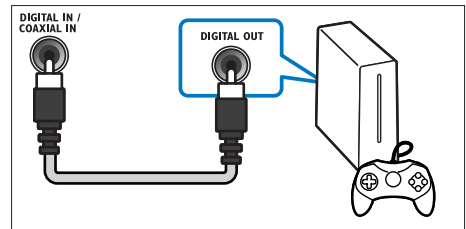

Option 3: Connect audio through analog audio cables

Basic quality audio

- Using an analog cable, connect the **AUX** connectors on your home theater to the **AUDIO OUT** connectors on the TV or other device.

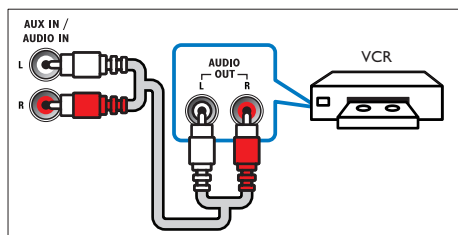

Set up speakers

Set up the speakers manually to experience customized surround sound.

Before you start

Make the necessary connections described in the quick start guide, and then switch the TV to the correct source for your home theater.

- Press **⬆** (Home).
- Select **[Setup]**, and then press **OK**.
- Select **[Audio] > [Speaker setup]**
- Enter the distance for each speaker, and then listen to the test tones and change the volume. Experiment with the speaker positions to find the ideal setting.

Set up EasyLink (HDMI-CEC control)

This home theater supports Philips EasyLink, which uses the HDMI-CEC (Consumer Electronics Control) protocol. EasyLink-compliant devices that are connected through HDMI can be controlled by a single remote control.

Note

- Depending on the manufacturer, HDMI-CEC is known by many names. For information on your device, see the user manual of the device.
- Philips does not guarantee 100% interoperability with all HDMI-CEC devices.

Before you start

- Connect your home theater to the HDMI-CEC compliant device through HDMI connection.
- Make the necessary connections described in the quick start guide, and then switch the TV to the correct source for your home theater.

Enable EasyLink

- Press **⬆** (Home).
- Select **[Setup]**, and then press **OK**.
- Select **[EasyLink] > [EasyLink] > [On]**.
- On your TV and other connected devices, turn on HDMI-CEC control. For details, see the user manual of the TV or other devices.
 - On your TV, set the audio output to 'Amplifier' (instead of TV speakers). For details, see the TV user manual.

EasyLink controls

With EasyLink, you can control your home theater, TV, and other connected HDMI-CEC compliant devices with a single remote control.

- **[One Touch Play]** (One-touch play): When a video disc is in the disc compartment, press **[Play]** to wake up the TV from standby, and then play a disc.
- **[One Touch Standby]** (One-touch standby): If one-touch standby is enabled, your home theater can switch to standby with the remote control of the TV or other HDMI-CEC devices.
- **[System Audio Control]** (System audio control): If system audio control is enabled, the audio of the connected device is output through your home theater speakers automatically when you play the device.
- **[Audio Input Mapping]** (Audio input mapping): If system audio control does not work, map the connected device to the correct audio input connector on your home theater (see 'Set up the audio' on page 14).

Note

- To change the EasyLink control settings, press **[Home]**, select **[Setup]** > **[EasyLink]**.

Set up the audio

If you cannot hear the audio output of a connected device through your home theater speakers, check that you have enabled Easylink on all the devices (see 'Enable EasyLink' on page 13). Then, set up the EasyLink audio control.

- 1 Press **[Home]**.
- 2 Select **[Setup]**, and then press **OK**.
- 3 Select **[EasyLink]** > **[System Audio Control]** > **[On]**.
 - To play the audio from the TV speakers, select **[Off]**, and skip the following steps.
- 4 Select **[EasyLink]** > **[Audio Input Mapping]**.
- 5 Follow the onscreen instructions to map the connected device to the audio inputs on your home theater.
 - If you connect your home theater to the TV through an HDMI ARC connection, make sure that the TV audio is mapped to the ARC input on your home theater.

Connect and set up a home network

Connect your home theater to a network router through wired or wireless network connection, and enjoy:

- Streamed multimedia content (see 'Browse PC through DLNA' on page 24)
- Smartphone control
- Online TV (see 'Browse Online TV' on page 23)
- Software update (see 'Update software through the Internet' on page 30)

Caution

- Familiarize yourself with the network router, media server software and networking principles. If necessary, read documentation that accompanies the network components. Philips is not responsible for lost, damaged, or corrupt data.

Before you start

- For Online TV and software updates, make sure that the network router has access to the Internet with high-speed connection and is not restricted by firewalls or other security systems.
- Make the necessary connections described in the quick start guide, and then switch the TV to the correct source for your home theater.

Set up the wired network

What you need

- A network cable (RJ45 straight cable).
- A network router (with DHCP enabled).

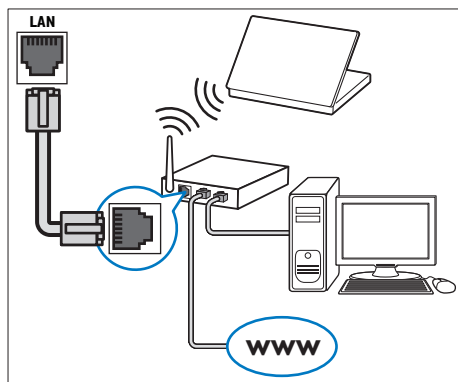

- 1 Using a network cable, connect the **LAN** connector on your home theater to the network router.
- 2 Press **⬆** (Home).
- 3 Select **[Setup]**, and then press **OK**.
- 4 Select **[Network]** > **[Network installation]** > **[Wired (Ethernet)]**.
- 5 Follow the onscreen instructions to complete the setup.
 - If connection fails, select **[Retry]**, and then press **OK**.
- 6 Select **[Finish]**, and then press **OK** to exit.
 - To view the network settings, select **[Setup]** > **[Network]** > **[View network settings]**.

Set up the wireless network

Your home theater is Wi-Fi ready. Connect a Wi-Fi dongle for easy access to a wireless network.

What you need

- A network router (with DHCP enabled). For best wireless performance, coverage, and compatibility, use 802.11n router;
- A Wi-Fi dongle (Model: Philips WUB1110)

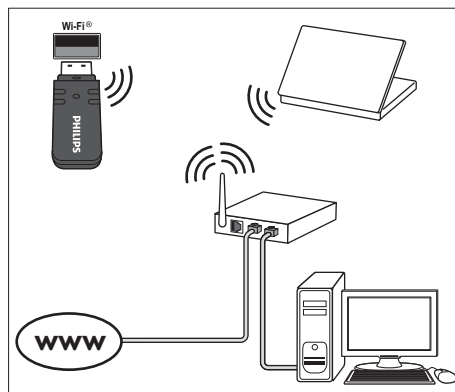

- 1 Press **⬆** (Home).
- 2 Select **[Setup]**, and then press **OK**.
- 3 Select **[Network]** > **[Network installation]** > **[Wireless (Wi-Fi)]**, and then press **OK**.
- 4 Follow the onscreen instructions to select and set up the wireless network.
 - If connection fails, select **[Retry]**, and then press **OK**.
- 5 Select **[Finish]**, and then press **OK** to exit.
 - To view the network settings, select **[Setup]** > **[Network]** > **[View wireless settings]**.

Personalize the network name

Name your home theater to easily identify it on your home network.

- 1 Press **⬆** (Home).
- 2 Select **[Setup]**, and then press **OK**.
- 3 Select **[Network]** > **[Name your Product:]**.
- 4 Press the **Alphanumeric buttons** to enter the name.
- 5 Select **[Done]**, and then press **OK** to exit.

5 Use your home theater

This section helps you use the home theater to play media from a wide range of sources.

Before you start

- Make the necessary connections described in the quick start guide and the user manual.
- Complete the first-time setup. First-time setup appears when you turn on your home theater or if you do not complete the setup.
- Switch the TV to the correct source for your home theater (for example, HDMI, AV IN).

Access the home menu

The home menu provides easy access to connected devices, setup and other useful features in your home theater.

- 1 Press **⬆️ (Home)**.
↳ The home menu is displayed.
- 2 Press the **Navigation buttons** and **OK** to select the following:
 - **[play Disc]**: Start disc play.
 - **[browse USB]**: Access the USB content browser
 - **[browse iPod]**: Access the iPod or iPhone content browser.
 - **[browse Online TV]**: Access Online TV.
 - **[browse PC]**: Access the computer content browser.
 - **[HDMI 1]**: Select the digital device connected to **HDMI IN 1** on your home theater.
 - **[HDMI 2]**: Select the digital device connected to **HDMI IN 2** on your home theater.
 - **[Setup]**: Access menus to change video, audio and other settings.
 - **[Help]**: Access onscreen user manual.
- 3 Press **⬆️ (Home)** to exit.

Discs

Your home theater can play DVDs, VCDs, CDs, and Blu-ray discs. It can also play discs that you've made at home, such as CD-R discs of photos and music.

- 1 Insert a disc into the home theater.
- 2 If the disc does not play automatically, press **DISC** or select **[play Disc]** from the home menu.
- 3 Use the remote control to control play (see 'Remote control' on page 5).

Note

- To avoid flickering, change the brightness of the display.

Play buttons

Button	Action
Navigation buttons	Navigate menus. Up/Down: Rotate the picture clockwise or counter-clockwise.
OK	Confirm an entry or selection.
▶ (Play)	Start or resume play.
⏸	Pause play.
■	Stop play.
⏮ / ⏭	Skip to the previous or next track, chapter or file.
⏪ / ⏩	When a video is paused, search backwards or forward.
SUBTITLE	Select subtitle language for video.
DISC/ POP-UP MENU	Access or exit the disc menu.
☰ OPTIONS	Access the advanced options when you play your audio, video, or media files (see 'Audio, video, and picture options' on page 19).

Synchronize picture and sound

If the audio and video are not synchronized, delay the audio to match the video.

- 1 Press **III SOUND SETTINGS**.
- 2 Select **AUD SYNC**, and then press **OK**.
- 3 Press the **Navigation buttons** (up/down) to synchronize the audio with the video.
- 4 Press **OK** to confirm.

Play Blu-ray 3D disc

Your home theater can play Blu-ray 3D video. Read the 3D health warning before playing a 3D disc.

What you need

- A 3D TV.
- A pair of 3D glasses that are compatible with your 3D TV.
- A 3D Blu-ray video
- A high speed HDMI cable (preferably version 1.4)

- 1 Using the high speed HDMI cable, connect your home theater to a 3D compatible TV.
- 2 Make sure that the 3D video setting is enabled. Press **▲ (Home)**, select **[Setup] > [Video] > [Watch 3D video] > [Auto]**.
 - To play 3D discs in 2D mode, select **[Off]**.
- 3 Play a Blu-ray 3D disc and put on the 3D glasses.
 - During video search and in certain play modes, the video is displayed in 2D. The video display returns to 3D when you resume play.

Bonus View on Blu-ray

On Blu-ray discs that support the Bonus View, enjoy extra content such as commentaries in a small screen window. Bonus View is also known as picture-in-picture.

- 1 Enable Bonus View in the Blu-ray disc menu.
- 2 While you play the movie, press **≡ OPTIONS**.
 - ↳ The options menu is displayed.
- 3 Select **[PIP selection] > [PIP]**.
 - Depending on the video, PIP menu [1] or [2] is displayed.
 - To disable Bonus View, select **[Off]**.
- 4 Select **[2nd audio language]** or **[2nd Subtitle Language]**.
- 5 Select the language, and then press **OK**.

BD-Live on Blu-ray

Access additional features on the Blu-ray discs with BD-Live content, such as internet chats with the director, the latest movie trailers, games, wallpaper, and ringtones.

BD-Live services and content vary from disc to disc.

What you need

- Blu-ray disc with BD-Live content.
- Storage device:
 - a USB storage device, with at least 1 GB of memory, or
 - an SD memory card of type SDHC Class 6, with at least 8 GB of memory.

- 1 Connect your home theater to a home network with Internet access (see 'Connect and set up a home network' on page 14).
- 2 Connect a USB storage device or insert a SD memory card to your home theater.
 - If prompted, follow the onscreen instructions to format the SD memory card.
- 3 Press **▲ (Home)** and select **[Setup]**.
- 4 Select **[Advanced] > [Local storage]**.
- 5 Select **[USB]** or **[SD card]**.
 - Use either a USB storage device or SD memory card to store the downloaded BD-Live content.

- 6 Select **[Advanced]** > **[BD-Live security]** > **[Off]** to enable BD-Live.
 - To disable BD-Live, select **[On]**.
- 7 Select the BD-Live icon in the disc menu, and then press **OK**.
 - ↳ BD-Live starts to load. The loading time depends on the disc and your internet connection.
- 8 Press the **Navigation buttons** to navigate BD-Live, and then press **OK** to select an option.

Note

- To clear the memory on the storage device, press **▲ (Home)**, select **[Setup]** > **[Advanced]** > **[Clear memory]**.

Data files

Your home theater can play pictures, audio and video files contained in a disc or a USB storage device. Before you play a file, check that the file format is supported by your home theater (see 'File formats' on page 31).

- 1 Play the files from a disc or USB storage device.
- 2 To stop play, press **■**.
 - To resume the video from where you stopped, press **▶ (Play)**.
 - To play the video from the start, press **◀**.

Note

- To play DivX DRM protected files, connect your home theater to a TV through an HDMI cable.

Subtitles

If your video has subtitles in multiple languages, select a subtitle language.

Note

- Make sure that the subtitle file has the exact same name as the video file. For example, if the video file is named 'movie.avi', name the subtitle file as 'movie.srt' or 'movie.sub'.
- Your home theater supports the following file formats: .srt, .sub, .txt, .ssa, .ass, .smi, and .sami. If the subtitles do not appear correctly, change the character set.

- 1 While playing video, press **SUBTITLE** to select a language.
- 2 For DivX or RMVB/RM videos, if the subtitles do not appear correctly, continue the following steps to change the character set.
- 3 Press **☰ OPTIONS**.
 - ↳ The options menu is displayed.
- 4 Select **[Character set]**, and then select a character set that supports the subtitle.

Europe, India, LATAM, and Russia

Character Set	Language
[Standard]	English, Albanian, Danish, Dutch, Finnish, French, Gaelic, German, Italian, Kurdish (Latin), Norwegian, Portuguese, Spanish, Swedish and Turkish
[Central Europe]	Albanian, Croat, Czech, Dutch, English, German, Hungarian, Irish, Polish, Romanian, Slovak, Slovene and Sorbian
[Cyrillic]	Bulgarian, Belorussian, English, Macedonian, Moldavian, Russian, Serbian and Ukrainian
[Greek]	Greek

Asia Pacific and China

Character Set	Language
[Standard]	Albanian, Danish, Dutch, English, Finnish, French, Gaelic, German, Italian, Kurdish (Latin), Norwegian, Portuguese, Spanish, Swedish, Turkish
[Chinese]	Simplified Chinese
[Chinese-Traditional]	Traditional Chinese
[Korean]	English and Korean

VOD code for DivX

Before you purchase DivX videos and play them on your home theater, register the home theater on www.divx.com using the DivX VOD code.

- 1 Press **⬆** (Home).
- 2 Select **[Setup]**, and then press **OK**.
- 3 Select **[Advanced] > [DivX@VOD Code]**.
↳ The DivX VOD registration code for your home theater is displayed.

USB storage devices

Enjoy pictures, audio, and video stored on a USB storage device such as an MP4 player or digital camera.

What you need

- A USB storage device that is formatted for FAT or NTFS file systems, and complies with the Mass Storage Class.

Note

- If you use a USB extension cable, USB HUB, or USB multi-reader, the USB storage device may not be recognized.

- 1 Connect a USB storage device to the  (USB) connector on your home theater.
- 2 Press **⬆** (Home).
- 3 Select **[browse USB]**, and then press **OK**.
↳ A content browser is displayed.
- 4 Select a file, and then press **OK**.
- 5 Press the play buttons to control play (see 'Play buttons' on page 16).

Audio, video, and picture options

Use advanced features when you play pictures, audio and video files from a disc or a USB storage device.

Audio options

While playing audio, repeat an audio track, a disc, or a folder:

- 1 Press **≡ OPTIONS** repeatedly to cycle through the following functions:
 - **RPT TRAC / RPT FILE**: Repeat the current track or file.
 - **RPT DISC / RPT FOLD**: Repeat all the tracks on the disc or the folder.
 - **RPT RAND**: Play audio tracks in random order.
 - **RPT OFF**: Turn off the repeat mode.

Video options

While watching video, select options such as subtitles, audio language, time search, and picture settings. Depending on the video source, some options are not available.

- 1 Press **≡ OPTIONS**.
↳ The video options menu is displayed.
- 2 Press the **Navigation buttons** and **OK** to select and change:
 - **[Audio language]**: Select audio language for video.
 - **[Subtitle Language]**: Select subtitle language for video.
 - **[Subtitle shift]**: Change the subtitle position on the screen.
 - **[Info]**: Display information about what is playing.
 - **[Character set]**: Select a character set that supports the DivX subtitle.
 - **[Time search]**: Skip to a specific part of the video by entering the time of the scene.
 - **[2nd audio language]**: Select the second audio language for Blu-ray video.
 - **[2nd Subtitle Language]**: Select the second subtitle language for Blu-ray video.
 - **[Titles]**: Select a specific title.
 - **[Chapters]**: Select a specific chapter.
 - **[Angle list]**: Select a different camera angle.
 - **[Menus]**: Display the disc menu.

- **[PIP selection]:** Display Picture-in-Picture window when playing a Blu-ray disc that supports the Bonus View.
- **[Zoom]:** Zoom into a video scene or picture. Press the **Navigation buttons** (left/right) to select a zoom factor.
- **[Repeat]:** Repeat a chapter or title.
- **[Repeat A-B]:** Mark two points within a chapter or track to repeat play, or turn off the repeat mode.
- **[Picture settings]:** Select a predefined color setting.
- **[Karaoke]** (Available only in Asia Pacific and China): Change the karaoke settings.

Picture options

While viewing a picture, zoom into the picture, rotate it, add animation to a slideshow, and change the picture settings.

- 1 Press **≡** **OPTIONS**.
↳ The picture options menu appears.
- 2 Press the **Navigation buttons** and **OK** to select and change the following settings:
 - **[Rotate +90]:** Rotate the picture 90 degree clockwise.
 - **[Rotate -90]:** Rotate the picture 90 degree counter-clockwise.
 - **[Zoom]:** Zoom into a video scene or picture. Press the **Navigation buttons** (left/right) to select a zoom factor.
 - **[Info]:** Display picture information.
 - **[Duration per slide]:** Select the display speed for each picture in a slide show.
 - **[Slide animation]:** Select animation for the slide show.
 - **[Picture settings]:** Select a predefined color setting.
 - **[Repeat]:** Repeat a selected folder.

Musical slideshow

If the picture and audio files are from the same disc or USB storage device, you can create a musical slideshow.

- 1 Select an audio track, and then press **OK**.
- 2 Press **↩** **BACK**, and go to the picture folder.
- 3 Select a picture, and then press **▶** (**Play**) to start the slideshow.
- 4 Press **■** to stop slideshow.
- 5 Press **■** again to stop music.

Radio

Listen to FM radio on your home theater, and store up to 40 radio stations.

Note

- AM and digital radio are not supported.
- If no stereo signal is detected, or if fewer than five stations are found, you are prompted to install the radio stations again.

- 1 Connect the FM antenna to the **ANTENNA FM 75 Ω** on your home theater.
 - For the best reception, place the antenna away from the TV or other sources of radiation.
- 2 Press **Source buttons** repeatedly until **RADIO** appears on the display panel.
 - ↳ If you have already installed the radio stations, the last channel that you listened to is played.
 - ↳ If you have not installed any radio stations, the message **AUTO INSTALL...PRESS PLAY** appears on the display panel. Press **▶** (**Play**).
- 3 Use the remote control to listen or to change radio stations.

Play buttons

Button	Action
◀/▶ or Alphanumeric buttons	Select a preset radio station.
Navigation buttons	Left/Right: Search for a radio station. Up/Down: Fine tune a radio frequency.
■	Press to stop the installation of radio stations.
↶ BACK	Press and hold to erase the preset radio station.
☰ OPTIONS	Manual: Press once to access program mode, and press again to store the radio station. Automatic: Press and hold for three seconds to reinstall the radio stations.
SUBTITLE	Toggle between the stereo and mono sounds.

Tuning grid

In some countries, you can toggle the FM tuning grid between 50 kHz and 100 kHz. Switching the tuning grid erases all preset radio stations.

- 1 Press **Source buttons** repeatedly until **RADIO** appears on the display panel.
- 2 Press ■.
- 3 Press and hold ▶ (**Play**) to toggle between 50 kHz or 100 kHz.

MP3 player

Connect a MP3 player to play audio files.

What you need

- An MP3 player.
- A 3.5mm or 6.5mm stereo audio cable.

- 1 Using the 3.5mm or 6.5mm stereo audio cable, connect the MP3 player to the **MUSIC iLINK** connector on your home theater.
 - If you use 6.5mm stereo audio cable, connect the MP3 player to your home theater using a 3.5mm - 6.5mm converter jack.
 - 2 Press **AUDIO SOURCE** repeatedly until **MUSIC I-LINK** appears on the display panel.
 - 3 Press the buttons on the MP3 player to select and play audio files.
-

iPod or iPhone

Connect a Philips dock to play music, photos, and videos from your iPod or iPhone.

What you need

- A Philips dock (model: Philips DCK306x).
- A yellow composite video cable.

- 1 Connect the Philips dock to the **DOCK for iPod** connector on your home theater.
- 2 To view slideshow from your iPod or iPhone on your TV, connect the dock to the TV by using the yellow composite cable.
- 3 Switch on the iPod or iPhone, and place it on the dock.
 - Charge your iPod/iPhone on the dock while the home theater is in iPod mode.

Play music

- 1 Dock your iPod or iPhone.
- 2 Press **DOCK for iPod** on the home theater remote control.
- 3 Browse your iPod or iPhone screen to select the music.
- 4 Play the music on your iPod or iPhone.
 - ↳ The music is heard on your home theater.

Browse the audio content from your TV (extended mode):

- 1 Press **⬆ (Home)**.
- 2 Select **[browse iPod]**, and then press **OK**.
 - ↳ A content browser is displayed.
- 3 Press **DOCK for iPod** to browse the audio content.
- 4 Press the play buttons to control play (see 'Play buttons' on page 16).
 - The local keys on your iPod or iPhone are disabled.
- 5 Press **DOCK for iPod** to exit the extended mode.

Play video and slideshow

- 1 Dock your iPod or iPhone (see 'iPod or iPhone' on page 21).
- 2 Press **DOCK for iPod** on the home theater remote control.
- 3 Switch the TV to the **AV/VIDEO** source (corresponding to the yellow composite cable).
 - ↳ The TV screen goes blank.
- 4 From the iPod or iPhone screen, browse and play a video or photo slideshow.
 - ↳ The video or photo slideshow is displayed on your TV.

Smartphone control

Use your mobile device such as iPhone (iOS 3.1.3 and above), Android phone (2.1 and above), iPad, or tablet to:

- Control your home theater
- Browse a data disc or USB storage device

Before you start

- Connect your home theater, mobile device, and other DLNA-compatible devices to the same home network.
 - For better video quality, use wired connection whenever possible.
- Personalize the network name for your home theater (see 'Personalize the network name' on page 15).
- Download Philips **MyRemote** application on your mobile device.
 - For iPhone or iPad, search for the app in **App Store** (App Store).
 - For Android based phone or tablet, search for the app in **Market** (Market).

Control your home theater

Control your home theater from the mobile device.

- 1 On the mobile device, access **MyRemote** (MyRemote) application.
- 2 Select your home theater (by its network name) from the home screen.
 - ↳ A browsing bar is displayed at the bottom of the screen.
 - If your home theater is not found, check the network connection or tap the **Devices** (Devices) tab on your mobile device to search again.
- 3 Select one of the following tabs to access more options.
 - To return to the previous screen, press back button.

Option	Action
App Home (App Home)	Return to your home screen.
Media (Media)	DISC: Browse and play a file stored on a data disc. USB: Browse and play a file stored on a USB storage device.
Remote (Remote)	Access the remote control on your mobile device. Swipe the screen to the left or right to access more buttons. Only the relevant buttons are enabled on your mobile device. Some functions such as standby and long press, are not available on the mobile device.

- 4 Follow the onscreen instructions to select an option or complete the set up.

Browse Online TV

Use Online TV to access variety of internet applications and specially adapted internet websites.

For interactive discussions on Online TV services, visit the Online TV forum at www.supportforum.philips.com

Note

- Koninklijke Philips Electronics N.V. bears no responsibility for content provided by Online TV service providers.

- 1 Connect your home theater to a home network with high-speed Internet access (see 'Connect and set up a home network' on page 14).
- 2 Press **⬆** (Home).
- 3 Select **[browse Online TV]**, and then press **OK**.
- 4 Follow the onscreen instructions to confirm the onscreen message.
↳ The Online TV home page is displayed.
- 5 Use the remote control to select and navigate the applications.

Navigate Online TV

Button	Action
Navigation buttons	Select an application or navigate.
OK	Confirm an entry or selection.
↶ BACK	Return to the previous page or clear text.
☰ OPTIONS	Access options related to current activity.
Alphanumeric buttons	Enter text (for example in email address, web URL, passwords, etc).
DISC/ POP-UP MENU	Exit Online TV portal and return to home menu.

Use a USB-HID keyboard or mouse

What you need

- A wired or wireless USB hub, keyboard, or mouse that complies with the Human Interface Design (USB-HID) class.

- 1 Connect a USB keyboard or mouse to the **⚡ (USB)** connector on your home theater.
 - To connect a wireless USB device, connect the wireless receiver to the USB connector on your home theater. Refer to the user manual of the wireless USB device for details.
- 2 Press **⬆** (Home).
- 3 Select **[Setup]**, and then press **OK**.
- 4 Select **[Preference] > [Keyboard layout]**.
- 5 Select a language.
↳ The standard keyboard for that language is enabled.
- 6 Use the keyboard to type the characters, or mouse to navigate the web page.
 - USB-HID mouse cursor does not work on Online TV and open internet pages.
 - The multimedia keys on some keyboards are not supported.

Clear browsing history

Clear the browsing history to remove passwords, cookies, and browsing data from your home theater.

- 1 Press **⬆** (Home).
- 2 Select **[Setup]**, and then press **OK**.
- 3 Select **[Network]** > **[Clear Online TV Memory]**.
- 4 Press **OK** to confirm.

Rent online video

Not available in China

Rent videos from online stores, through your home theater. You can watch them right away or later.

Many online video stores offer a huge choice of video, with different rental prices, periods, and conditions. For some stores, you must create an account before you can rent.

What you need

- An SD memory card of type SDHC Class 6, with at least 8GB of memory.

- 1 Connect your home theater to a home network with high-speed Internet access (see 'Connect and set up a home network' on page 14).
- 2 Insert a blank SD memory card into the **SD CARD** slot on your home theater, and follow the onscreen instructions to format the card.
 - After formatting, leave the card in the **SD CARD** slot.
- 3 Press **⬆** (Home).
- 4 Select **[browse Online TV]**, and then press **OK**.
 - ↳ The online services available in your country are displayed.
- 5 Select a video store, and then press **OK**.
- 6 Follow the onscreen instructions to rent or watch a video. If prompted, enter the necessary information to register or log in to the store's account.
 - ↳ The video is downloaded to your **SD** memory card. You can watch it only on your home theater.
- 7 Press the playback buttons to control play (see 'Play buttons' on page 16).

Browse PC through DLNA

Access and play the pictures, audio and video files from a computer or media server on the home network through your home theater.

Before you start

- Install a DLNA-compliant media server application on your device. Make sure that you download an application that works best for you. For example,
 - Windows Media Player 11 or higher for PC
 - Twonky Media Server for Mac or PC
- Enable media sharing of files. For details, check the user manual of the media server software.

- 1 Connect your home theater to a home network. For better video quality, use wired connection whenever possible.
- 2 Connect the computer and other DLNA-compatible devices to the same home network.
- 3 Press **⬆** (Home).
- 4 Select **[browse PC]**, and then press **OK**.
 - ↳ A content browser is displayed.
- 5 Select a device on the network.
 - ↳ The folders in the selected device are displayed. Depending on the media server, the folder names may vary.
 - If you cannot see the folders, make sure that you enable media sharing on the selected device so that the content is available for sharing.
- 6 Select a file, and then press **OK**.
 - Some media files may not play due to compatibility issues. Check the file formats supported by your home theater.
- 7 Press the play buttons to control play (see 'Play buttons' on page 16).

Karaoke

Available only in selected model and region

Play a Karaoke disc on your home theater and sing along with the music.

What you need

- A Karaoke microphone.
- Karaoke discs.



Caution

- To prevent loud feedback or unexpected noise, turn the microphone volume to the minimum before you connect the microphone to your home theater.

- 1 Connect a karaoke microphone to the **MIC** connector on your home theater.
- 2 Switch your TV to the correct source for your home theater.
- 3 Make sure that audio post processing is enabled on your home theater (see 'Speaker settings' on page 28).
- 4 While playing a karaoke disc, press **≡**
OPTIONS.
↳ The options menu is displayed.
- 5 Select **[Karaoke]**, and then press **OK**.
↳ The karaoke setup menu is displayed.
- 6 Press the **Navigation buttons** (up/down) and **OK** to change the following settings:
 - **[Microphone]**: Turn the microphone on or off.
 - **[Microphone volume]**: Change the microphone volume.
 - **[Echo]**: Change the echo level.
 - **[Key]**: Change the pitch to match your voice.

Choose sound

This section helps you choose the ideal sound for your video or music.

- 1 Press **≡** **SOUND SETTINGS**.
- 2 Press the **Navigation buttons** (left/right) to access the sound options on the display.

Sound options	Description
SURROUND	Select surround sound or stereo sound.
SOUND	Select a sound mode.
BASS	Change the low frequency output.
MID	Change the middle frequency output.
TREBLE	Change the high frequency output.
AUTOVOL	Reduce sudden changes in volume, for example, during TV commercials.
AUD SYNC	Delay the audio to match the video.

- 3 Select an option, and then press **OK**.
- 4 Press **↶** **BACK** to exit.
 - If you do not press a button within a minute, the menu exits automatically.

Surround sound mode

Experience an immersive audio experience with surround sound modes.

- 1 Press **≡** **SOUND SETTINGS**.
- 2 Select **SURROUND**, and then press **OK**.
- 3 Press the **Navigation buttons** (up/down) to select a setting from your display:
 - **AUTO**: Surround sound based on the audio stream.
 - **SURROUND PLUS**: Enhanced surround mode with 5.1 channels for best cinematic experience.
 - **MULTI-CH**: Immersive multi-channel sound for an enhanced movie experience.
 - **STEREO**: Two-channel stereo sound. Ideal for listening to music.
- 4 Press **OK** to confirm.

Sound mode

Select predefined sound modes to suit your video or music.

- 1 Make sure that audio post processing is enabled at the speakers (see 'Speaker settings' on page 28).
- 2 Press **≡** **SOUND SETTINGS**.
- 3 Select **SOUND**, and then press **OK**.
- 4 Press the **Navigation buttons** (up/down) to select a setting on the display:
 - **AUTO**: Automatically select **MOVIE** or **MUSIC** based on the sound stream.
 - **MOVIE**: Enjoy a cinematic audio experience, specially enhanced for movies.
 - **MUSIC**: Recreate the original recording environment of your music, in the studio or at a concert.
 - **ORIGINAL**: Experience the original sound of your movies and music, without added sound effects.
 - **NEWS**: Hear every word with optimized speech and clear vocals.
 - **GAMING**: Enjoy thrilling arcade sounds, ideal for action-packed video games or loud parties.
- 5 Press **OK** to confirm.

Equalizer

Change the high frequency (treble), mid frequency (mid), and low frequency (bass) settings of the home theater.

- 1 Press **≡** **SOUND SETTINGS**.
- 2 Select **TREBLE**, **MID** or **BASS**, and then press **OK**.
- 3 Press the **Navigation buttons** (up/down) to change the frequency.
- 4 Press **OK** to confirm.

Auto volume

Turn on auto volume to reduce sudden changes in volume, for example, during TV commercials.

- 1 Press **≡** **SOUND SETTINGS**.
- 2 Select **AUTOVOL**, and then press **OK**.
- 3 Press the **Navigation buttons** (up/down) to select **ON** or **OFF**.
- 4 Press **OK** to confirm.

6 Change settings

The home theater settings are already configured for optimal performance. Unless you have a reason to change a setting, we recommend that you keep the default setting.

Note

- You cannot change a setting that is grayed out.
- To return to the previous menu, press **↶** **BACK**. To exit the menu, press **⬆** **(Home)**.

Language settings

- 1 Press **⬆** **(Home)**.
- 2 Select **[Setup]**, and then press **OK**.
- 3 Select **[Preference]**, and then press **OK**.
- 4 Press the **Navigation buttons** and **OK** to select and change:
 - **[Menu language]**: Select a display language for menu.
 - **[Audio]**: Select an audio language for discs.
 - **[Keyboard layout]**: Select a keyboard in your language.
 - **[Subtitle]**: Select a subtitle language for discs.
 - **[Disc menu]**: Select a menu language for discs.

Note

- If your preferred disc language is not available, select **[Others]** from the list, and enter the 4-digit language code found at the end of this user manual (see 'Language code' on page 39).
- If you select a language that is not available on a disc, the home theater uses the default language of the disc.

Picture and video settings

- 1 Press **▲** (Home).
- 2 Select **[Setup]**, and then press **OK**.
- 3 Select **[Video]**, and then press **OK**.
- 4 Press the **Navigation buttons** and **OK** to select and change:
 - **[TV display]**: Select a picture format to fit the TV screen.
 - **[HDMI video]**: Select the resolution of video signal that is output from **HDMI OUT (ARC)** on your home theater. To enjoy the selected resolution, make sure that your TV supports the selected resolution.
 - **[HDMI Deep Color]**: Recreate the natural world on your TV screen by displaying vivid images using billion colors. Your home theater must be connected to a Deep Color enabled TV through an HDMI cable.
 - **[Picture settings]**: Select pre defined color settings for the video display. Select **[User]** to create your own setting.
 - **[Watch 3D video]**: Set HDMI video to support 3D or 2D video.
 - **[User]**: Select advanced settings for the video. Available only after you create a preset called 'User' under picture settings.



Note

- If you change a setting, make sure that the TV supports the new setting.

Audio settings

- 1 Press **▲** (Home).
- 2 Select **[Setup]**, and then press **OK**.
- 3 Select **[Audio]**, and then press **OK**.
- 4 Press the **Navigation buttons** and **OK** to select and change:
 - **[Night mode]**: For quiet listening, decrease the volume of loud sounds on your home theater. Night mode is only available for Dolby-encoded DVD and Blu-ray discs.
 - **[HDMI Audio]**: Set the HDMI audio output from your TV, or disable HDMI audio output from the TV.

Parental control settings

- 1 Press **▲** (Home).
- 2 Select **[Setup]**, and then press **OK**.
- 3 Select **[Preference]**, and then press **OK**.
- 4 Press the **Navigation buttons** and **OK** to select and change:
 - **[Change Password]**: Set or change your password for parental control access. If you do not have a password or have forgotten your password, enter **0000**.
 - **[Parental control]**: Restrict access to discs that are recorded with age ratings. To play all discs, irrespective of the ratings, select **8** or **[Off]**.

Display settings

- 1 Press **▲** (Home).
- 2 Select **[Setup]**, and then press **OK**.
- 3 Select **[Preference]**, and then press **OK**.
- 4 Press the **Navigation buttons** and **OK** to select and change:
 - **[Auto subtitle shift]**: Enable or disable automatic repositioning of subtitles on TVs that support this feature.
 - **[Display panel]**: Set the brightness of the home theater front panel display.
 - **[VCD PBC]**: Enable or disable the content menu navigation of VCD and SVCD discs with Play Back Control feature.

Energy saving settings

- 1 Press **⬆** (Home).
- 2 Select **[Setup]**, and then press **OK**.
- 3 Select **[Preference]**, and then press **OK**.
- 4 Press the **Navigation buttons** and **OK** to select and change:
 - **[Screen saver]**: Switch the home theater to screen saver mode after 10 minutes of inactivity.
 - **[Auto standby]**: Switch the home theater to standby after 30 minutes of inactivity. This timer works only when a disc or USB play is paused or stopped.
 - **[Sleep timer]**: Set the duration of the sleep timer so that the home theater is switched to standby after the specified period.

Speaker settings

- 1 Press **⬆** (Home).
- 2 Select **[Setup]**, and then press **OK**.
- 3 Select **[Advanced]**, and then press **OK**.
- 4 Press the **Navigation buttons** and **OK** to select and change:
 - **[Enhanced audio]**: Select **[On]** to enable audio post processing at the speaker and enable karaoke settings (if your product supports Karaoke). To play the original audio of the disc, select **[Off]**.



- Enable audio post processing before you select a predefined sound mode (see 'Sound mode' on page 26).

Restore default settings

- 1 Press **⬆** (Home).
- 2 Select **[Setup]**, and then press **OK**.
- 3 Select **[Advanced]** > **[Restore default settings]**, and then press **OK**.
- 4 Select **[OK]**, and then press **OK** to confirm.
 - ↳ Your home theater is reset to its default settings except for some settings such as parental control and DivX VOD registration code.

7 Update software

Philips continually tries to improve its products. To get the best features and support, update your home theater with the latest software.

Compare the version of your current software with the latest version on www.philips.com/support. If the current version is lower than the latest version available on the Philips support website, upgrade your home theater with the latest software.



Caution

- Do not install a lower version of software than the current version installed on your product. Philips is not liable for problems caused due to software downgrade.

Check software version

Check the version of the current software installed on your home theater.

- Press **▲ (Home)**.
- Select **[Setup]**, and then press **OK**.
- Select **[Advanced] > [Version information]**.
 - The software version is displayed.
 - The last two digits indicate the current version of the onscreen help installed on your home theater. For example, if the current version of the software is 'Subsystem SVV: 35-00-00-05', '05' represents the current version of onscreen help installed on your home theater.

Update software through USB

What you need

- A USB flash drive that is FAT or NTFS-formatted, with at least 75MB of memory. Do not use a USB hard drive.
- A computer with Internet access.
- An archive utility that supports the ZIP file format.

Step 1: Download the latest software

- Connect a USB flash drive to your computer.
- In your web browser, go to www.philips.com/support.
- At the Philips Support website, find your product and locate the **Software and drivers**.
 - The software update is available as a zip file.
- Save the zip file in the root directory of your USB flash drive.
- Use the archive utility to extract the software update file in the root directory.
 - The files are extracted under the **UPG_ALL** folder of your USB flash drive.
- Disconnect the USB flash drive from your computer.

Step 2: Update the software



Caution

- Do not switch off the home theater or remove the USB flash drive during the update.

- Connect the USB flash drive containing the downloaded file to your home theater.
 - Make sure that the disc compartment is closed and no disc inside.
- Press **▲ (Home)**.
- Select **[Setup]**, and then press **OK**.
- Select **[Advanced] > [Software update] > [USB]**.
- Follow the onscreen instructions to confirm the update.
 - Once complete, the home theater automatically switches off and restarts. If it does not, disconnect the power cord for a few seconds and then reconnect it.

Update software through the Internet

- 1 Connect your home theater to a home network with a high-speed Internet access (see 'Connect and set up a home network' on page 14).
- 2 Press **⬆** (Home).
- 3 Select **[Setup]**, and then press **OK**.
- 4 Select **[Advanced] > [Software update] > [Network]**.
 - ↳ If an upgrade media is detected, you are prompted to start or cancel the update.
- 5 Follow the onscreen instructions to confirm the update.
 - ↳ Once complete, the home theater automatically switches off and restarts. If it does not, disconnect the power cord for a few seconds and then reconnect it.

Update the onscreen help

If the current version of the onscreen help is lower than the latest version available on www.philips.com/support, download and install the latest onscreen help (see 'Check software version' on page 29).

What you need

- A USB flash drive that is FAT or NTFS-formatted, with at least 35MB of memory. Do not use a USB hard drive.
- A computer with internet access.
- An archive utility that supports the ZIP file format.

Step 1: Download the latest onscreen help

- 1 Connect a USB flash drive to your computer.
- 2 In your web browser, go to www.philips.com/support.
- 3 At the Philips support website, find your product and click on **User manuals**, and then locate the **User Manual Upgrade Software**.
 - ↳ The help update is available as a zip file.
- 4 Save the zip file in the root directory of your USB flash drive.
- 5 Use the archive utility to extract the help update file in the root directory.
 - ↳ A file named 'HTSxxxxeDFU.zip' is extracted under the **UPG_ALL** folder of your USB flash drive, 'xxxx' being the model number of your home theater.
- 6 Disconnect the USB flash drive from your computer.

Step 2: Update onscreen help

Caution

- Do not switch off the home theater or remove the USB flash drive during the update.

- 1 Connect the USB flash drive containing the downloaded file to your home theater.
 - Make sure that the disc compartment is closed and there is no disc inside.
- 2 Press **⬆** (Home).
- 3 Enter **338** on the remote control.
- 4 Follow the onscreen instructions to confirm the update.
- 5 Disconnect the USB flash drive from the home theater.

8 Product specifications



Note

- Specifications and design are subject to change without notice.

Region codes

The type plate on the back or bottom of the home theater shows which regions it supports.

Country	DVD	BD
Europe, United Kingdom		
Asia Pacific, Taiwan, Korea		
Latin America		
Australia, New Zealand		
Russia, India		
China		

Media formats

- AVCHD, BD, BD-R/ BD-RE, BD-Video, DVD-Video, DVD+R/+RW, DVD-R/-RW, DVD+R/-R DL, CD-R/CD-RW, Audio CD, Video CD/SVCD, Picture files, MP3 media, WMA media, DivX Plus HD media, USB storage device

File formats

- Audio: .aac, .mka, .mp3, .wma, .wav, .mp4, .m4a
- Video:
 - .avi, .divx, .mp4, .mkv, .asf, .wmv, .mpg, .mpeg,
 - .rmvb, .rm (Available only in Asia Pacific and China)
- Picture: .jpg, .jpeg, .gif, .png

Audio formats

Your home theater supports the following audio files.

Extension	Container	Audio codec	Bit rate
.mp3	MP3	MP3	32 kbps ~ 320 kbps
.wma	ASF	WMA	64 kbps ~ 160 kbps
.aac	AAC	AAC, HE-AAC	192 kbps
.wav	WAV	PCM	1.4 Mbps
.m4a	MKV	AAC	192 kbps
.mka	MKA	PCM	27.648 Mbps
.mka	MKA	Dolby Digital	640 kbps
.mka	MKA	DTS core	1.54 Mbps
.mka	MKA	MPEG	912 kbps
.mka	MKA	MP3	32 kbps ~ 320 kbps
.mka	MKA	WMA	64 kbps ~ 160 kbps
.mka	MKA	AAC, HE-AAC	192 kbps

Video formats

If you have a high definition TV, your home theater allows you to play your video files with:

- Resolution: 1920 × 1080 pixels at
- Frame rate: 6 ~ 30 frames per second.

.avi files in AVI container

Audio codec	Video codec	Bit rate
PCM, Dolby Digital, DTS core, MP3, WMA	DivX 3.11, DivX 4.x, DivX 5.x, DivX 6.x	10 Mbps max
	MPEG 1, MPEG 2	20 Mbps (peak 40 Mbps)
	MPEG 4 ASP	10 Mbps max
	H.264/AVC HP@4.1/4.0; MP@3.2/3.1/3.0	20 Mbps (peak 40 Mbps)
	WMV9	20 Mbps

.divx files in AVI container

Audio codec	Video codec	Bit rate
PCM, Dolby Digital, MP3, WMA	DivX 3.11, DivX 4.x, DivX 5.x, DivX 6.x	10 Mbps max
	MPEG 1, MPEG 2	20 Mbps (peak 40 Mbps)
	MPEG 4 ASP	10 Mbps max

.mp4 or .m4v files in MP4 container

Audio codec	Video codec	Bit rate
Dolby Digital, MPEG, MP3, AAC, HE-AAC	MPEG 1, MPEG 2	20 Mbps (peak 40 Mbps)
	MPEG 4 ASP	10 Mbps max
	H.264/AVC HP@4.1/4.0; MP@3.2/3.1/3.0	20 Mbps (peak 40 Mbps)

.mkv files in MKV container

Audio codec	Video codec	Bit rate
PCM, Dolby Digital, DTS core, MPEG, MP3, WMA, AAC, HE-AAC	MPEG 1, MPEG 2	20 Mbps (peak 40 Mbps)
	MPEG 4 ASP	10 Mbps max
	H.264/AVC HP@4.1/4.0; MP@3.2/3.1/3.0	20 Mbps (peak 40 Mbps)
	WMV9	20 Mbps

.asf and .wmv files in ASF container

Audio codec	Video codec	Bit rate
PCM, Dolby Digital, MP3, WMA	MPEG 4 ASP	10 Mbps max
	H.264/AVC HP@4.1/4.0; MP@3.2/3.1/3.0	20 Mbps (peak 40 Mbps)
	WMV9	20 Mbps

.mpg and .mpeg files in PS container

Audio codec	Video codec	Bit rate
PCM, DTS core, MPEG, MP3	MPEG 1, MPEG 2	20 Mbps (peak 40 Mbps)
	MPEG 1, MPEG 2	20 Mbps (peak 40 Mbps)

.rm and .rmvb files in RM container (Available only in Asia Pacific and China)

Audio codec	Video codec	Bit rate
AAC, COOK	RV30, RV40	20 Mbps (peak 40 Mbps)

Amplifier

- Total output power:
 - 1000W RMS (+/- 0.5 dB, 30% THD) / 800W RMS (+/- 0.5 dB, 10% THD)
- Frequency response: 20 Hz-20 kHz / ± 3 dB
- Signal-to-noise ratio: > 65 dB (CCIR) / (A-weighted)
- Input sensitivity:
 - AUX: 1000 mV
 - Music iLink: 350 mV

Video

- Signal system: PAL / NTSC
- HDMI output: 480i/576i, 480p/576p, 720p, 1080i, 1080p, 1080p24

Audio

- S/PDIF Digital audio input:
 - Coaxial: IEC 60958-3
 - Optical: TOSLINK
- Sampling frequency:
 - MP3: 32 kHz, 44.1 kHz, 48 kHz
 - WMA: 44.1 kHz, 48 kHz
- Constant bit rate:
 - MP3: 32 kbps - 320 kbps
 - WMA: 48 kbps - 192 kbps

Radio

- Tuning range:
 - Europe/Russia/China: FM 87.5-108 MHz (50 kHz)
 - Asia Pacific/Latin America: FM 87.5-108 MHz (50/100 kHz)
- Signal-to-noise ratio: FM 50 dB
- Frequency response: FM 180 Hz-12.5 kHz / ± 3 dB

USB

- Compatibility: Hi-Speed USB (2.0)
- Class support: USB Mass Storage Class (MSC)
- File system: FAT16, FAT32, NTFS

Main unit

- Power supply:
 - Europe/China: 220-240 V~, 50 Hz
 - Latin America/Asia Pacific: 110-127 V/220-240 V~, 50-60 Hz
 - Russia/India: 220-240 V~, 50 Hz
- Power consumption: 105 W
- Standby power consumption: ≤ 0.5 W
- Dimensions (WxHxD): 435 x 56 x 344 mm
- Weight: 3.3 kg

Subwoofer

- Impedance: 4 ohm
- Speaker drivers: 165 mm (6.5") woofer
- Dimensions (WxHxD):
 - HTS55x3 and HTS65x3/93: 178 x 303 x 343 mm
 - HTS65x3/94: 196 x 395 x 342 mm
- Weight:
 - HTS55x3 and HTS65x3/93: 3.84 kg
 - HTS65x3/94: 5.2 Kg

Speakers

Center speaker:

- Speaker impedance: 4 ohm
- Speaker drivers:
 - HTS55x3: 1 × 76.2 mm (3") woofer
 - HTS65x3: 2 × 76.2 mm (3") woofer
- Dimensions (WxHxD):
 - HTS55x3: 223 × 101.5 × 93.5 mm
 - HTS65x3: 280 × 95 × 92 mm
- Weight:
 - HTS55x3: 0.61 kg
 - HTS65x3: 0.97 kg

Front / rear speakers:

- Speaker impedance: 4 ohm
- Speaker drivers:
 - HTS55x3: 1 × 76.2 mm (3") woofer
 - HTS65x3: 2 × 76.2 mm (3") woofer
- Dimensions HTS55x3 (WxHxD):
 - Satellite (small) speakers: 90 × 185 × 105.5 mm
 - Tallboy (tall) speakers: 247 × 1091 × 242 mm
- Dimensions HTS65x3 (WxHxD):
 - Satellite (small) speakers: 101 × 280 × 104 mm
 - Tallboy (tall) speakers: 260 × 1101 × 260 mm
- Weight HTS55x3:
 - Satellite (small) speakers: 0.54 kg each
 - Tallboy (tall) speakers: 2.19 kg each
- Weight HTS65x3:
 - Satellite (small) speakers: 0.87 kg each
 - Tallboy (tall) speakers: 3.83 kg each

Remote control batteries

- 2 × AAA-R03-1.5V

Laser

- Laser Type (Diode): InGaN/AlGaIn (BD), AlGaInP (DVD/CD)
- Wave length: 405 +7 nm/-7 nm (BD), 655 +10 nm/-10 nm (DVD), 790 +10 nm/-20 nm (CD)
- Output power (Max. ratings): 20 mW (BD), 6 mW (DVD), 7 mW (CD)

9 Troubleshooting



Warning

- Risk of electric shock. Never remove the casing of the product.

To keep the warranty valid, never try to repair the product yourself.

If you have problems using this product, check the following points before you request service. If you still have a problem, get support at www.philips.com/support.

Main unit

The buttons on the home theater do not work.

- Disconnect the home theater from the power supply for a few minutes, then reconnect.

Picture

No picture.

- Make sure that the TV is switched to the correct source for the home theater.

No picture on a TV connected through HDMI.

- Make sure that you use a High Speed HDMI cable to connect the home theater and TV. Some Standard HDMI cables do not display properly for some images, 3D video, or Deep Color.
- Make sure that the HDMI cable is not faulty. If it is faulty, replace it with a new cable.
- Press **⬆️ (Home)** and then **731** on the remote control to restore the default picture resolution.
- Change the HDMI video setting, or wait for 10 seconds for auto recovery.

Disc does not play high-definition video.

- Make sure that the disc contains high-definition video.
- Make sure that the TV supports high-definition video.
- Use an HDMI cable to connect to the TV.

Sound

No sound from home theater speakers.

- Connect the audio cable from your home theater to your TV or other devices. However, you do not need a separate audio connection when:
 - the home theater and TV are connected through an **HDMI ARC** connection, or
 - a device is connected to the **HDMI IN** connector on your home theater.
- Set up the audio for the connected device.
- Reset your home theater to its factory settings, and then switch it off and switch on again.
- On your home theater, press **SOURCE** repeatedly to select the correct audio input.

Distorted sound or echo.

- If you play audio from the TV through the home theater, make sure that the TV is muted.

Audio and video are not synchronized.

- 1) Press **≡ SOUND SETTINGS**. 2) Press the **Navigation buttons** (left/right) to select **AUD SYNC**, and then press **OK**. 3) Press the **Navigation buttons** (up/down) to synchronize the audio with the video.

Play

Cannot play a disc.

- Clean the disc.
- Make sure that the home theater supports the type of disc (see 'Media formats' on page 31).
- Make sure that the home theater supports the region code of the disc.
- If the disc is a DVD±RW or DVD±R disc, make sure that it is finalized.

Cannot play a DivX file.

- Make sure that the DivX file is encoded according to the 'Home Theater Profile' with the DivX encoder.
- Make sure that the DivX file is complete.

DivX or RMVB/RM subtitles do not display correctly.

- Make sure that the subtitle file name is the same as the movie file name.
- Select the correct character set: 1) Press **≡ OPTIONS**. 2) Select **[Character set]**. 3) Select the supported character set. 4) Press **OK**.

Cannot read the contents of a USB storage device.

- Make sure that the format of the USB storage device is compatible with the home theater.
- Make sure that the file system on the USB storage device is supported by the home theater.

'No entry' or 'x' sign appears on the TV.

- The operation is not possible.

EasyLink does not work.

- Make sure that the home theater is connected to a Philips brand EasyLink TV, and the EasyLink option is turned on (see 'Set up EasyLink (HDMI-CEC control)' on page 13).

When you switch on the TV, the home theater automatically switches on.

- This behavior is normal when you are using Philips EasyLink (HDMI-CEC). To make the home theater work independently, switch off EasyLink.

Cannot access BD-Live features.

- Make sure that the home theater is connected to the network. Use a wired network connection or wireless network connection.
- Make sure that the network is set up. Use a wired network installation or wireless network installation.
- Make sure that the Blu-ray disc supports BD-Live features.
- Clear memory storage.

Cannot play video or photos from an iPod or iPhone on the TV.

- Browse and select videos and photos from the iPod or iPhone screen, and play them on your TV.
- Make sure that the iPod or iPhone software has not been tampered with or illegally modified.

Cannot view pictures from an iPod or iPhone on the TV.

- Connect a yellow composite cable to the iPod dock and the TV.
- Switch the TV to the **AV/VIDEO** source (corresponding to the yellow composite cable).
- Press the play button on the iPod or iPhone to start a slideshow.
- Make sure that the iPod or iPhone software has not been tampered with or illegally modified.

My 3D video played in 2D mode.

- Make sure that your home theater is connected to a 3D TV through an HDMI cable.
- Make sure that the disc is a Blu-ray 3D disc, and the Blu-ray 3D video option is on.

TV screen is black when you play a Blu-ray 3D video or a DivX copy protected video.

- Make sure that the home theater is connected to the TV through an HDMI cable.
- Switch to the correct HDMI source on the TV.

Cannot download video from an online video store.

- Make sure that your home theater is connected to the TV through an HDMI cable.
- Make sure that the SD card is formatted, has enough memory to download the video, and is of type SDHC Class 6.
- Make sure that you have paid for the video, and it is within the rental period.
- Make sure that the network connection is good. Use a wired network connection or a wireless network connection.
- Visit the video store website for more information.

Network

Wireless network distorted or not found.

- Make sure that the wireless network is not disturbed by microwave ovens, DECT phones, or other neighboring Wi-Fi devices.
- Place the wireless router and the home theater within five meters of each other.
- Use a USB extension cable to connect the Wi-Fi dongle to the home theater.
- If the wireless network does not work properly, try a wired network installation.

10 Notice

This section contains the legal and trademark notices.

Open source software

Philips Electronics Singapore Pte Ltd hereby offers to deliver, upon request, a copy of the complete corresponding source code for the copyrighted open source software packages used in this product for which such offer is requested by the respective licenses. This offer is valid up to three years after product purchase to anyone in receipt of this information. To obtain source code, please contact open.source@philips.com. If you prefer not to use email or if you do not receive confirmation receipt within a week after mailing to this email address, please write to "Open Source Team, Philips Intellectual Property & Standards, P.O. Box 220, 5600 AE Eindhoven, The Netherlands". If you do not receive timely confirmation of your letter, please email to the email address above. The texts of the licenses and acknowledgements for open source software used in this product are included in the user manual.

RMVB end user agreement (Asia Pacific and China only)

Notes to End User:

By using this product with RealNetworks software and services, the end user agrees to the following terms of REALNETWORKS, INC:

- End User may only use the software for private, non-commercial use in accordance with the terms of RealNetworks EULA .
- End User is not allowed to modify, translate, reverse engineer, decompile, disassemble or use other means to discover the source code or otherwise replicate the functionality of the Real Format Client Code, except to the extent that this restriction is expressly prohibited by applicable law.
- RealNetworks Inc. disclaims all warranties and conditions other than those set forth in this Agreement which are in lieu of all other warranties, whether express and implied, including but not limited to any implied warranties or conditions of merchantability and fitness for a particular purpose; and effectively exclude all liability for indirect, special, incidental and consequential damages, such as but not limited to lost profits.

Trademarks



"Blu-ray 3D" and "Blu-ray 3D" logo are trademarks of Blu-ray Disc Association.



'AVCHD' and 'AVCHD' logo are trademarks of Matsushita Electric Industrial Co., Ltd and Sony Corporation.



BONUSVIEW™

'BD LIVE' and 'BONUSVIEW' are trademarks of Blu-ray Disc Association.



'DVD Video' is a trademark of DVD Format/Logo Licensing Corporation.



Java and all other Java trademarks and logos are trademarks or registered trademarks of Sun Microsystems, Inc. in the United States and/or other countries.

x.v.Colour

'x.v.Colour' is a trademark of Sony Corporation.



Manufactured under license under U.S. Patent Nos: 5,956,674; 5,974,380; 6,226,616; 6,487,535; 7,392,195; 7,272,567; 7,333,929; 7,212,872 & other U.S. and worldwide patents issued & pending. DTS-HD, the Symbol, & DTS-HD and the Symbol together are registered trademarks & DTS-HD Master Audio | Essential is a trademark of DTS, Inc. Product includes software. © DTS, Inc. All Rights Reserved.



Manufactured under license from Dolby Laboratories. Dolby, Pro Logic, and the double-D symbol are trademarks of Dolby Laboratories.



DivX[®], DivX Certified[®], DivX Plus[®] HD and associated logos are trademarks of Rovi Corporation or its subsidiaries and are used under license.

ABOUT DIVX VIDEO: DivX[®] is a digital video format created by DivX, LLC, a subsidiary of Rovi Corporation. This is an official DivX Certified[®] device that plays DivX video. Visit divx.com for more information and software tools to convert your files into DivX videos.

ABOUT DIVX VIDEO-ON-DEMAND: This DivX Certified[®] device must be registered in order to play purchased DivX Video-on-Demand (VOD) movies. To obtain your registration code, locate the DivX VOD section in your device setup menu. Go to vod.divx.com for more information on how to complete your registration.



HDMI, the HDMI logo, and High-Definition Multimedia Interface are trademarks or registered trademarks of HDMI Licensing LLC in the United States and other countries.



SDHC Logo is a trademark of SD-3C, LLC.



11 Language code

Abkhazian	6566	Inupiaq	7375	Pushto	8083
Afar	6565	Irish	7165	Russian	8285
Afrikaans	6570	Íslenska	7383	Quechua	8185
Amharic	6577	Italiano	7384	Raeto-Romance	8277
Arabic	6582	Ivrit	7269	Romanian	8279
Armenian	7289	Japanese	7465	Rundi	8278
Assamese	6583	Javanese	7486	Samoan	8377
Avestan	6569	Kalaallisut	7576	Sango	8371
Aymara	6589	Kannada	7578	Sanskrit	8365
Azerbaijani	6590	Kashmiri	7583	Sardinian	8367
Bahasa Melayu	7783	Kazakh	7575	Serbian	8382
Bashkir	6665	Kernewek	7587	Shona	8378
Belarusian	6669	Khmer	7577	Shqip	8381
Bengali	6678	Kinyarwanda	8287	Sindhi	8368
Bihari	6672	Kirghiz	7589	Sinhalese	8373
Bislama	6673	Komi	7586	Slovensky	8373
Bokmål, Norwegian	7866	Korean	7579	Slovenian	8376
Bosanski	6683	Kuanyama; Kwanyama	7574	Somali	8379
Brezhoneg	6682	Kurdish	7585	Sotho; Southern	8384
Bulgarian	6671	Lao	7679	South Ndebele	7882
Burmese	7789	Latina	7665	Sundanese	8385
Castellano, Español	6983	Latvian	7686	Suomi	7073
Catalán	6765	Letzeburgesch;	7666	Swahili	8387
Chamorro	6772	Limburgan; Limburger	7673	Swati	8383
Chechen	6769	Lingala	7678	Svenska	8386
Chewa; Chichewa; Nyanja	7889	Lithuanian	7684	Tagalog	8476
中文	9072	Luxembourgish;	7666	Tahitian	8489
Chuang; Zhuang	9065	Macedonian	7775	Tajik	8471
Church Slav; Slavonic	6785	Malagasy	7771	Tamil	8465
Chuvash	6786	Magyar	7285	Tatar	8484
Corsican	6779	Malayalam	7776	Telugu	8469
Česky	6783	Maltese	7784	Thai	8472
Dans	6865	Manx	7186	Tibetan	6679
Deutsch	6869	Maori	7773	Tigrinya	8473
Dzongkha	6890	Marathi	7782	Tonga (Tonga Islands)	8479
English	6978	Marshallese	7772	Tsonga	8483
Esperanto	6979	Moldavian	7779	Tswana	8478
Estonian	6984	Mongolian	7778	Türkçe	8482
Euskara	6985	Nauru	7865	Turkmen	8475
Ελληνικά	6976	Navaho; Navajo	7886	Twi	8487
Faroese	7079	Ndebele, North	7868	Uighur	8571
Français	7082	Ndebele, South	7882	Ukrainian	8575
Frysk	7089	Ndonga	7871	Urdu	8582
Fijian	7074	Nederlands	7876	Uzbek	8590
Gaelic; Scottish Gaelic	7168	Nepali	7869	Vietnamese	8673
Gallegan	7176	Norsk	7879	Volapuk	8679
Georgian	7565	Northern Sami	8369	Walloon	8765
Gikuyu; Kikuyu	7573	North Ndebele	7868	Welsh	6789
Guarani	7178	Norwegian Nynorsk;	7878	Wolof	8779
Gujarati	7185	Occitan; Provençal	7967	Xhosa	8872
Hausa	7265	Old Bulgarian; Old Slavonic	6785	Yiddish	8973
Herero	7290	Oriya	7982	Yoruba	8979
Hindi	7273	Oromo	7977	Zulu	9085
Hiri Motu	7279	Ossetian; Ossetic	7983		
Hrwatski	6779	Pali	8073		
Ido	7379	Panjabi	8065		
Interlingua (International)	7365	Persian	7065		
Interlingue	7365	Polski	8076		
Inuktitut	7385	Português	8084		

12 Index

2

2nd audio language	17
2nd subtitle language	17

3

3D disc in 2D mode	17
3D safety	4
3D video	17

5

5.1 speakers	9
--------------	---

A

advanced settings	28
amplifier	33
audio connection (analog cable)	13
audio connection (coaxial cable)	12
audio connection (HDMI ARC)	10
audio connection (optical cable)	12
audio formats	31
audio from other devices	12
audio input mapping	14
audio language	26
audio options	19
audio post processing	28
audio settings	27
audio setup	14
auto standby	28
auto subtitle shift	27
auto volume	26

B

batteries	34
BD-Live	17
Blu-ray	16
Bonus View	17
brightness	27
browse disc or USB from smartphone	22
browse PC	24

C

change password	27
character set	18
clear BD-Live memory	17
connect a digital device (HDMI)	12
connect to TV	10
connectors	7
control buttons (disc)	16
control buttons (radio)	21
control buttons (USB)	16
customer support	2

D

data files	18
deep color	27
default settings	28
device name	15
disc language	26
disc menu	26
display panel	27
disposal	4
DivX	18
DivX subtitles	18
DLNA	24

E

Easylink (HDMI-CEC)	13
eject disc	7
enhanced audio	28
environment	4

F

factory settings	28
FAQs	2
file formats	31
FM antenna	8
front connectors	7

H

HDMI audio	27
HDMI-CEC	13
home menu	16
home network	14

<hr/>	
I	
iPod music	22
iPod or iPhone	21
<hr/>	
K	
karaoke	25
karaoke	25
<hr/>	
L	
language code	39
<hr/>	
M	
main unit	7
manual setup	13
media formats	31
menu language	26
microphone	7
musical slideshows	20
<hr/>	
N	
network	14
night mode	27
<hr/>	
O	
one-touch play	14
one-touch standby	14
Online TV	23
online video stores	24
options	19
<hr/>	
P	
parental control	27
PBC (play back control)	27
picture options	20
picture resolution	27
picture settings	27
picture-in-picture	17
play disc	16
play from iPhone	22
play from iPod	21
play from PC	24
play online video	24
play radio	20
<hr/>	
play USB storage device	19
play video and slideshow from iPod	22
power settings	28
predefined sound mode	26
preference	26
program radio stations	20
<hr/>	
R	
radio	20
recycling	4
region codes	31
remote control	5
<hr/>	
S	
SD card	24
sleep timer	28
slide animation	20
smartphone	22
software update	29
software version	29
sound	25
speaker position	9
speaker setup	13
speaker specifications	31
subtitle language	26
subtitle position	27
surround sound	25
synchronize picture and sound	17
system audio control	14
<hr/>	
T	
troubleshooting (network)	36
troubleshooting (picture)	34
troubleshooting (play)	35
troubleshooting (sound)	35
tune radio stations	20
tuning grid	21
tuning grid	21
<hr/>	
U	
update onscreen help (user manual)	30
update software (through Internet)	30
update software (through USB)	29
USB storage device	19
user manual	2

V

VCD	27
video connection (composite video)	11
video connection (HDMI ARC)	10
video connection (standard HDMI)	11
video formats	33
video options	19
video settings	27
VOD code (DivX)	19

W

watch 3D	17
Wi-Fi dongle	15
wired network	15
wireless network	15
wireless rear audio	10
wireless speakers	10

CERTIFICADO DE GARANTIA NO BRASIL

Este aparelho é garantido pela Philips do Brasil Ltda., por um período superior ao estabelecido por lei. Porém, para que a garantia tenha validade, é imprescindível que, além deste certificado, seja apresentada a nota fiscal de compra do produto.

A Philips do Brasil Ltda. assegura ao proprietário consumidor deste aparelho as seguintes garantias, a partir da data de entrega do produto, conforme expresso na nota fiscal de compra, que passa a fazer parte deste certificado:

Garantia para rádios e reprodutores de CD portáteis

(sem caixa acústica destacável): 180 dias

Garantia para os demais produtos da marca Philips: 365 dias.

Esta garantia perderá sua validade se:

- O defeito apresentado for ocasionado pelo uso indevido ou em desacordo com o seu manual de instruções.
- O produto for alterado, violado ou consertado por pessoa não autorizada pela Philips.
- O produto for ligado a fonte de energia (rede elétrica, pilhas, bateria, etc.) de características diferentes das recomendadas no manual de instruções e/ou no produto.
- O número de série que identifica o produto estiver de alguma forma adulterado ou rasurado.

Estão excluídos desta garantia defeitos decorrentes do descumprimento do manual de instruções do produto, de casos fortuitos ou de força maior, bem como aqueles causados por agentes da natureza e acidentes. Excluem-se igualmente desta garantia defeitos decorrentes do uso dos produtos em serviços não doméstico/residencial regular ou em desacordo com o uso recomendado.

ESTÃO EXCLUÍDAS DA GARANTIA ADICIONAL AS PILHAS OU BATERIAS FORNECIDAS JUNTO COM O CONTROLE REMOTO.

Nos municípios onde não exista assistência técnica autorizada Philips, as despesas de transporte do aparelho e/ou técnico autorizado correm por conta do consumidor requerente do serviço.

A garantia não será válida se o produto necessitar de modificações ou adaptações para habilitá-lo a operar em qualquer outro país que não aquele para o qual foi designado, fabricado, aprovado e/ou autorizado, ou ter sofrido qualquer dano decorrente deste tipo de modificação.

Philips do Brasil Ltda.

No Brasil, para informações adicionais sobre o produto, entre em contato com o CIC - Centro de Informações ao Consumidor através dos telefones (11) 2121-0203 (Grande São Paulo) e 0800-701-0203 (demais regiões e estados).

Horário de atendimento: de segunda a sexta-feira, das 8h às 20h e sábados das 8h às 13h.

Visite também nossa página de suporte ao consumidor no website www.philips.com.br/suporte, onde também está disponível a lista completa e atualizada das assistências técnicas autorizadas Philips.

***Para atendimento fora do Brasil, contate a Philips local ou a: Philips Consumer Service
Beukenlaan 2 - 5651 CD Eindhoven The Netherlands***

LISTA DE SERVIÇO AUTORIZADO - BRASIL

ACRE					
CRUZEIRO DO SUL	68-33227216	ITUMBIARA	64-34310837	SAO JOAO DEL REI	32-33718306
RIO BRANCO	68-32217642	LUZIANIA	61-36228519	SAO SEBASTIAO DO PARAISO	35-35313094
ALAGOS		MINEIROS	64-36618259	SETE LAGOAS	31-37718570
ARAPIRACA	82-35222367	PIRES DO RIO	64-34611133	TEOFILO OTONI	33-35225831
MACEIO	82-32417237	RIALMA	62-33971320	TIMOTEO	31-38462728
PALMEIRA DOS INDIOS	82-34213452	RIO VERDE	64-36132034	TRES CORACOES	35-32324143
UNIAO DOS PALMARES	82-32811305	TRINIDADE	62-35051505	UBA	32-35323628
AMAPA		URUACU	62-33571285	UBERABA	34-33332520
MACAPA	96-32175934	MARANHAO		UBERLANDIA	34-32123636
AMAZONAS		ACAILANDIA	99-35381889	VARGINHA	35-32228414
MANAUS	92-36633366	BACABAL	99-36212794	VARZEA DA PALMA	38-37311548
MANAUS	92-32324252	CAXIAS	99-35212377	VICOSA	31-38918000
BAHIA		CODO	99-36612942	PARA	
ALAGOINHAS	75-34211128	SANTA INES	98-36537553	ALTAMIRA	91-35154349
BARREIRAS	77-36117592	IMPERATRIZ	99-35232906	ANANINDEUA	91-32354831
CAETITE	77-34541183	PEDREIRAS	99-36423142	BELEM	91-32421090
CAMACARI	71-36218288	PRESIDENTE DUTRA	99-36631815	BELEM	91-32542424
CRUZ DAS ALMAS	75-36212839	SAO JOSE DE RIBAMAR	98-32241581	CAPANEMA	91-34621100
EUNAPOLIS	73-32815181	SAO LUIS	98-32323236	CASTANHAL	91-37215052
FEIRA DE SANTANA	75-32232882	MATO GROSSO		MARABA	94-33242207
GUANAMBI	77-34512791	BARRA DO GARCAS	66-34011394	PARAGOMINAS	91-30110778
ILHEUS	73-32315995	CIUIBA	65-33176464	PARAUAPEBAS	94-33561756
IRECE	74-36410202	LUCAS DO RIO VERDE	65-35491333	SANTAREM	93-35235322
ITABUNA	73-36137777	PONTES E LACERDA	65-32662326	TUCURUI	55-33523215
JACOBINA	74-36211323	RONDONOPOLIS	66-34233888	PARAIBA	
JEQUIE	73-35254141	TANGARA DA SERRA	65-33261431	CAMPINA GRANDE	83-33212128
JUAZEIRO	74-36116456	VARZEA GRANDE	65-36826502	GUARABIRA	83-32711159
LAURO DE FREITAS	71-33784021	MATO GROSSO DO SUL		JOAO PESSOA	83-32469689
MURITIBA	75-34241908	AMAMBAI	67-34811543	NOVA FLORESTA	83-33741014
PAULO AFONSO	75-32811349	CAMPO GRANDE	67-33831540	SAPE	83-32832479
RIBEIRA DO POMBAL	75-32761853	CAMPO GRANDE	67-33213988	PARANA	
SALVADOR	71-32473659	DOURADOS	67-34217117	ARAPONGAS	43-32521606
SALVADOR	71-32072070	NOVA ANDRADINA	67-34413851	ASSIS CHATEAUBRIAND	44-35285181
SALVADOR	71-33356233	MINAS GERAIS		BANDEIRANTES	43-35421711
SENHOR DO BONFIM	74-35413143	ANDRADAS	35-37312970	CAMPO MOURAO	44-30164500
SERRINHA	75-32611794	ARAGUARI	34-32416022	CASCAVEL	45-32254005
SANTO ANTONIO DE JESUS	75-36314470	ARAXA	34-36611132	CIANORTE	44-36292842
TEIXEIRA DE FREITAS	73-30311600	ARAXA	34-36691969	CURITIBA	41-33334764
CEARA		ARCOS	37-33513455	CURITIBA	41-32648791
CRATEUS	88-36910019	BAMBUI	37-34311473	FOZ DO IGUAQU	45-35234115
FORTALEZA	85-40088555	BELO HORIZONTE	31-32254066	FRANCISCO BELTRAO	46-35241501
IGUATU	88-35810512	BETIM	31-35220288	IBIPORA	43-32581863
ITAPIPOCA	88-36312030	BOM DESPACHO	37-35222511	IRATI	42-34221337
JUAZEIRO DO NORTE	88-35817173	CARANGOLA	32-37412017	LAPA	41-36222410
SOBRAL	88-36110605	CARATINGA	33-33213433	LONDRINA	43-33210077
TUAIA	88-34371987	CASSIA	35-35412293	MANDAGUARI	44-32331335
TIANGUA	88-36713336	CATAGUASES	32-34227985	MARECHAL CANDIDO RONDON	45-32542605
UBAJARA	88-36341233	CONGONHAS	31-37311638	MARINGA	44-32256420
DISTRITO FEDERAL		CANTAGUAS	31-37311638	MEDIANEIRA	45-32642580
BRASILIA	61-35648480	CONTAGEM	31-33912994	PARANAVAI	44-34234711
BRASILIA	61-33549615	CORONEL FABRICIANO	31-38411804	PATO BRANCO	46-32242786
BRASILIA	61-34451991	CURVELO	38-37213009	PONTA GROSSA	42-30285061
ESPIRITO SANTO		DIVINOPOLIS	37-32212353	RIO NEGROS	47-36450251
ALEGRE	28-35526349	FORMIGA	37-33214177	ROLANDIA	43-32561947
ARACRUZ	27-32561251	GOVERNADOR VALADARES	33-32716650	SANTO ANTONIO PLATINA	43-35341809
BAIXO GUANDU	27-37321142	GUAXUPÉ	35-35514124	SAO MIGUEL DO IGUAÇU	45-35651429
BARRA DE SAO FRANCISCO	27-37562245	IPATINGA	31-38222332	TOLEDO	45-32522471
CACHOEIRA DE ITAPEMIRIM	28-35223524	ITABIRA	31-38316218	UMUARAMA	44-30561485
COLATINA	27-37222288	ITAJUBA	35-36211315	PERNAMBUCO	
GUARAPARI	27-33614355	ITAPECERICA	37-33411326	CABO SANTO AGOSTINHO	81-35211823
SAO MATEUS	27-37633806	ITAJUANA	37-32412468	CAMARAGIBE	61-33812846
SERRA	27-33284292	JOAO MONLEVADE	31-38512909	CARUARU	81-37220235
VILA VELHA	27-32891233	JOAO PINHEIRO	38-35511337	GRANDE RIBEIRAO	47-37610085
VITORIA	27-32233899	JUIZ DE FORA	32-32151514	PAULISTA	81-34331142
GOIAS		LAGOA DA PRATA	37-32813493	RECIFE	81-32313399
ANAPOLIS	62-33243562	LAVRAS	35-38210550	RECIFE	81-34656042
CALDAS NOVAS	64-34532878	MANHUAQU	33-33314735	RECIFE	81-32286123
CATALAO	64-34412786	MONTE CARMELO	34-38422082	SERRA TALHADA	87-38311401
FORMOSA	61-36318166	MONTE SANTO DE MINAS	35-35911888	PIAUÍ	
GOIANESIA	62-33534967	MONTES CLAROS	38-32218925	PARNAIBA	86-33222877
GOIANIA	62-32916770	MURIAE	32-37224334	TERESINA	86-32230825
GOIANIA	62-32510533	NANUQUE	33-36212165	TERESINA	86-32214618
GOIANIA	62-32292908	NOVA LIMA	31-35412026	RIO DE JANEIRO	
GOIATUBA	64-34952401	OLIVEIRA	37-33314444	BARRA DO PIRAI	24-24437745
INHUMAS	62-35111431	PARACATU	38-36711250	BELFORD ROXO	21-27795797
ITAPURANGA	62-33551484	PASSOS	35-35214342	BOM JESUS DO ITABAPOANA	22-38312126
		PATOS DE MINAS	34-38225888	CABO FRIO	22-26451819
		PATROCINIO	34-38311531	CAMPOS DOS GOYTACAZES	22-27221499
		PIUMHI	37-33714632	CORDEIRO	22-25512099
		POÇOS DE CALDAS	35-37224448		
		PONTE NOVA	31-38172486		
		POUSO ALEGRE	35-34212120		

LISTA DE SERVIÇO AUTORIZADO - BRASIL

DUQUE DE CAXIAS	21-27711508	CONCORDIA	49-34423704	SAO CAETANO DO SUL	11-42275339
ITAGUAI	21-26886491	CRICIUMA	48-21015555	SAO CARLOS	16-33614913
ITACARA	22-38612740	CURITIBANOS	49-32410851	SAO JOAO DA BOA VISTA	19-36232990
ITAPERUNA	22-36236825	FLORIANOPOLIS	48-32049700	SAO JOSE DO RIO PARDO	19-36085760
MACEAE	22-27591358	GAZOPABA	48-32544104	SAO JOSE DO RIO PRETO	17-32325680
MAGE	21-26333342	INDIAL	47-33333275	SAO JOSE DOS CAMPOS	12-39238508
NITEROI	21-2622-0157	ITAJAI	47-33444777	SAO PAULO	11-29791184
NOVA FRIBURGO	22-25227692	JARAGUA DO SUL	47-33722050	SAO PAULO	11-38659897
PETROPOLIS	24-22454997	JOACABA	49-35220418	SAO PAULO	11-22722245
RESENDE	24-33550101	JOINVILLE	47-34331146	SAO PAULO	11-26940111
RIO DE JANEIRO	21-24264702	LAGES	49-32244414	SAO PAULO	11-32077111
RIO DE JANEIRO	21-25892030	LAGUNA	48-36443153	SAO PAULO	11-39757996
RIO DE JANEIRO	21-25096851	MARAVILHA	49-36640052	SAO PAULO	11-22976464
RIO DE JANEIRO	21-24315759	PINHALZINHO	49-33661014	SAO PAULO	11-56679695
RIO DE JANEIRO	21-25714999	PORTO UNIAO	42-35232839	SAO PAULO	11-38751333
RIO DE JANEIRO	21-3381-0711	RIO DO SUL	47-35211920	SAO PAULO	11-38457575
SAO GONCALO	21-27013214	RIO NEGRINHO	47-36440979	SAO PAULO	11-22966122
TERESOPOLIS	21-27439467	SAO MIGUEL DO OESTE	49-36220026	SAO PAULO	11-20713907
TRES RIOS	24-22521388	TUBARAO	48-36261651	SAO PAULO	11-25770999
VOLTA REDONDA	24-33481601	VIDEIRA	49-35606376	SAO PAULO	11-32223311
		XANXERE	49-34333026	SAO ROQUE	11-47125635
				SAO VICENTE	13-34646559
RIO GRANDE DO NORTE		SÃO PAULO		SOROCABA	15-32241170
CAICO	84-34171844	AGUAS DE LINDOIA	19-38241524	SUZANO	11-47598671
NATAL	84-32231249	AMERICANA	19-34062914	TABOAO DA SERRA	11-47871480
NATAL	84-32132345	AMPARO	19-38072674	TAQUARITINGA	16-32524039
PAU DOS FERROS	84-33512334	ARACATUBA	18-36218775	TAUBATE	12-36219080
		ARARAQUARA	16-33368710	TIETE	15-32822452
RIO GRANDE DO SUL		ASSIS	18-33242649	TUPA	14-34962596
BAGE	53-32411295	ATIBAIA	11-44118145	VALINHOS	19-38716629
BENTO GONCALVES	54-34526825	AVARE	14-37322142	VOTUPORANGA	17-34214940
CAMAQUA	51-36711686	BARRETOS	17-33222742		
CANELA	54-32821551	BAURU	14-31049551	SERGIPE	
CARAZINHO	54-33302292	BIRIGUI	18-36424011	ARACAJU	79-32176080
CAXIAS DO SUL	54-30211808	BOTUCATU	14-38821081	ITABAIANA	79-34313023
DOIS IRMAOS	51-35641286	CAMPINAS	19-37372500	LAGARTO	79-36312656
ERECIM	54-33211833	CAMPOS DO JORDAO	12-36622142		
ESTANCIA VELHA	51-35612142	CATANDUVA	17-35235254	TOCANTINS	
FARROUPILHA	54-32683603	CERQUILHO	15-32842121	ARAGUAIANA	63-34111818
FLORES DA CUNHA	54-32922625	CRUZEIRO	12-14333859	GUARAI	63-34641590
FREDERICO WESTPHALEN	55-37441850	DIADEMA	11-40430669	GURUPI	63-33511038
GRAVATAI	51-30422830	DRACENA	18-38212479	PALMAS	63-32175628
IJUI	55-33327766	FERNANDOPOLIS	17-34423752		
LAJEADO	51-37145155	FRANCA	16-37223898		
MARAU	54-33424571	FRANCO DA ROCHA	11-44482608		
MONTENEGRO	51-36324187	GUARATINGUETA	12-13335030		
NOVA PRATA	54-32421328	GUARUJA	13-33582942		
NOVO HAMBURGO	51-35823191	GUARULHOS	11-24431153		
OSORIO	51-36632524	IBITINGA	16-33417685		
PASSO FUNDO	54-33111104	INDAIAL	19-38753831		
PELOTAS	53-32223633	ITAPERUNA	15-32710936		
PORTO ALEGRE	51-32226941	ITAPIRA	19-36533802		
PORTO ALEGRE	51-33256853	ITAPOLIS	16-32622524		
PORTO ALEGRE	51-32268834	ITUAQUAQUETUBA	11-46404162		
RIO GRANDE	53-32323211	ITARARE	15-35322743		
SANTA CRUZ DO SUL	51-37153048	ITU	11-40230188		
SANTA MARIA	55-30282235	ITUVERAVA	16-37293365		
SANTA ROSA	55-35113449	JALES	17-36324479		
SAO JOSE DO OURO	54-33521216	JAU	14-36222117		
SOBRADINHO	51-37421409	JUNDIAI	11-45862182		
TAPERA	54-33851160	LEME	19-35713528		
T AQUARI	51-36534390	LIMEIRA	19-34413179		
TORRES	51-36641940	LINS	14-35227283		
TRES DE MAIO	55-35358727	MARILIA	14-34547437		
URUGUAIANA	55-34118069	MATAO	16-33821046		
VACARIA	54-32311396	MAJAU	11-45145233		
VENANCIO AIRES	51-37411443	MOGI DAS CRUZES	11-47941814		
VERA CRUZ	51-37181350	MOGI GUAÇU	19-38181171		
		MOJI MIRIM	19-38624401		
RONDÔNIA		OLIMPIA	17-32805378		
BURITIS	69-32383830	OSASCO	11-36837343		
CACAOAL	69-34431415	OURINHOS	14-32226545		
GUAJARA MIRIM	69-35414430	PIRACICABA	19-34340454		
PORTO VELHO	69-32273377	PIRASSUNUNGA	19-35614091		
		PORTO FERREIRA	19-35851891		
RORAIMA		PRESIDENTE PRUDENTE	18-32225168		
BOA VISTA	95-32249605	PROMISSAO	14-35411696		
		REGISTRO	13-38212324		
SANTA CATARINA		RIBEIRAO PRETO	16-36368156		
ARARANGUA	48-35220304	RIBEIRAO PRETO	16-39049908		
BALNEARIO CAMBORIU	47-33630706	RIO CLARO	19-35348843		
BLUMENAU	47-33233907	SALTO	11-40296963		
BRUSQUE	47-33557518	SANTO ANDRE	11-49905288		
CANOINHAS	47-36223615	SANTOS	13-32272947		
CAPINZAL	49-35552266	SAO BERNARDO CAMPO	11-41257000		
CHAPECO	49-33221144				

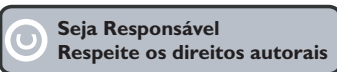

Especificações sujeitas a alteração sem aviso prévio.

Marcas comerciais são propriedade de Koninklijke Philips Electronics N.V. ou de seus respectivos proprietários.

www.philips.com

© 2012 Koninklijke Philips Electronics N.V.

All rights reserved.

sgpam_1201/78_v1