

Register your product and get support at
www.philips.com/welcome

DS3880W/10



EN User manual

PHILIPS

Contents

1	Important	4
	Safety	4
	Notice	5

2	Your Entertainment System	7
	Introduction	7
	What's in the box	7
	What else you need	7
	Overview of the main unit	9
	Get started to use AirPlay	10

3	Prepare	11
	Connect power	11
	Turn DS3880W on	11

4	Connect to your home Wi-Fi network for AirPlay	12
	Scenario 1: Connect to a WPS router	12
	Scenario 2: Connect to a non-WPS router	13

5	Play	19
	Stream audio from your iTunes music library to DS3880W	19
	Control play	20
	Use advanced sound settings	20
	Play/charge your iPod/iPhone/iPad through USB socket	21
	Play from an external device	21

6	Update firmware	23
	Download the update file	23
	Update from the configuration page	23

7	Product information	25
	Specifications	25

8	Troubleshooting	26
----------	------------------------	-----------

1 Important

Safety

Information for Europe:

Know these safety symbols



The 'exclamation mark' calls attention to features for which you should carefully read the supplied literature to prevent operating and maintenance problems.

The 'lightening bolt' symbol indicates uninsulated components within the product that can cause an electric shock.

To reduce the risk of fire or electric shock, do not expose the product to rain or moisture and do not place any objects filled with liquids, such as vases, on the product.

- ① Read these instructions.
- ② Keep these instructions.
- ③ Heed all warnings.
- ④ Follow all instructions.
- ⑤ Do not use this product near water.
- ⑥ Clean only with dry cloth.
- ⑦ Do not block any ventilation openings. Install in accordance with the manufacturer's instructions.
- ⑧ Do not remove the casing of this product.

- ⑨ Do not expose the product to dripping / splashing water, rain or high humidity.
- ⑩ Keep this product away from direct sunlight, naked flames or heat.
- ⑪ Do not install near any heat sources such as radiators, heat registers, stoves, or other electrical equipment (including amplifiers).
- ⑫ Do not place any other electrical equipment on the product.
- ⑬ Do not place any sources of danger on the product (e.g. objects containing liquids, burning candles).
- ⑭ This product may include batteries. Please refer to safety and disposal instructions for batteries in this user manual.
- ⑮ Where the mains plug or an appliance coupler is used as the disconnect device, the disconnect device shall remain readily operable.

Warning

- Never remove the casing of this apparatus.
- Never lubricate any part of this apparatus.
- Never place this apparatus on other electrical equipment.
- Keep this apparatus away from direct sunlight, naked flames or heat.
- Ensure that you always have easy access to the power cord, plug or adaptor to disconnect this apparatus from the power.

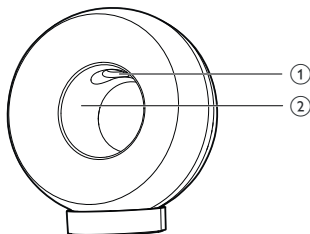

Warning

- To avoid injuries, never put your fingers into the bass pipe (1) or your hands into the aluminum ring (2).

Information about the use of batteries:

! Caution

- Risk of leakage: Only use the specified type of batteries. Do not mix new and used batteries. Do not mix different brands of batteries. Observe correct polarity. Remove batteries from products that are not in use for a longer period of time. Store batteries in a dry place.
- Risk of injury: Wear gloves when handling leaking batteries. Keep batteries out of reach of children and pets.
- Risk of explosion: Do not short circuit batteries. Do not expose batteries to excessive heat. Do not throw batteries into the fire. Do not damage or disassemble batteries. Do not recharge non-rechargeable batteries.

Always bring your product to a professional to remove the built-in battery.

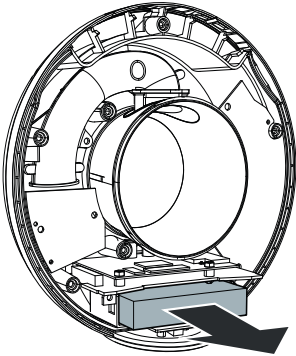

Environmental information

All unnecessary packaging has been omitted. We have tried to make the packaging easy to separate into three materials: cardboard (box), polystyrene foam (buffer) and polyethylene (bags, protective foam sheet.)

Your system consists of materials which can be recycled and reused if disassembled by a specialized company. Please observe the local regulations regarding the disposal of packaging materials, exhausted batteries and old equipment.

Made for

 iPod  iPhone  iPad



"Made for iPod," "Made for iPhone," and "Made for iPad" mean that an electronic accessory has been designed to connect specifically to iPod, iPhone, or iPad, respectively, and has been certified by the developer to meet Apple performance standards. Apple is not responsible for the operation of this device or its compliance with safety and regulatory standards. Please note that the use of this accessory with iPod, iPhone, or iPad may affect wireless performance.

AirPlay, iPod, and iPhone are trademarks of Apple Inc., registered in the U.S. and other countries. iPad is a trademark of Apple Inc.

Class II equipment symbol:



CLASS II apparatus with double insulation, and no protective earth provided.

≡ Note

- The type plate is located on the bottom of the apparatus.

2 Your Entertainment System

Congratulations on your purchase, and welcome to Philips! To fully benefit from the support that Philips offers, register your product at www.philips.com/welcome.

If you contact Philips, you will be asked for the model and serial number of this apparatus. The model number and serial number are on the bottom of the apparatus. Write the numbers here:

Model No. _____

Serial No. _____

Introduction

Apple AirPlay technology enables you to play your iTunes music library, hosted on a Mac, PC, iPhone, iPod touch, or iPad on any AirPlay-enabled device (for example, your DS3880W) connected to the Wi-Fi network.

With an AirPlay-enabled device (for example, your DS3880W), you can:

- stream audio from your iTunes music library to any room in your house
- choose which AirPlay-enabled devices you want to play music on (if you have more than one such devices in your house)
- stream audio to multiple AirPlay-enabled devices at the same time (from the iTunes music library on your PC/Mac only)



Tip

- Please visit www.philips.com/welcome for information about more Philips AirPlay-enabled devices.

With DS3880W, you can also:

- charge your iPod/iPhone/iPad through the USB socket with an Apple USB cable (not supplied).
- play your iTunes music library on your iPod/iPhone/iPad through the USB socket directly while charging.
- play music from other audio devices through the **MP3-LINK** socket.

What's in the box

Check and identify the contents of your package:

- DS3880W main unit (with a built-in Wi-Fi module)
- 1 x AC power adapter
- 1 x MP3 link cable
- Charging stand
- User manual (in CD-ROM)
- Quick start guide

What else you need

To stream audio wirelessly by AirPlay, you need:

- A Wi-Fi certified router
- A host for your iTunes music library, for example, an iPod touch/iPhone/iPad installed with iOS 4.3 (or later) or a Wi-Fi enabled PC/Mac installed with iTunes 10 (or later)

Your DS3880W should be connected to the same local network as your iTunes host device through the Wi-Fi router.



List of compatible iTunes host devices for AirPlay

In terms of AirPlay, DS3880W is compatible with:

- a Wi-Fi enabled PC/Mac installed with iTunes 10 (or later); and
- the following iPod/iPhone/iPad models installed with iOS 4.3 (or later):
 - iPad 2
 - iPad
 - iPhone 4
 - iPhone 3GS
 - iPod touch (2nd, 3rd, and 4th generation)

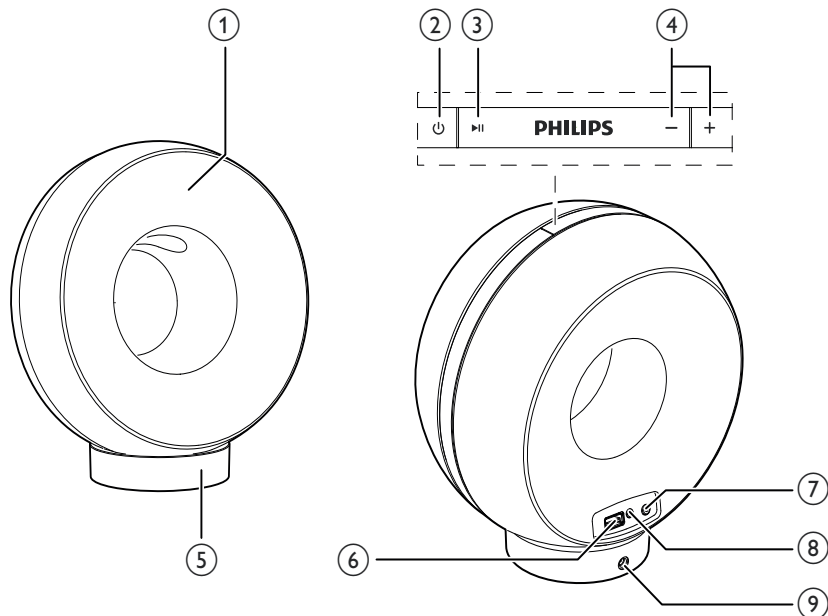
Overview of the main unit



- ① **Power indicator**
- ②  • Turn DS3880W on/off.
- ③  • Start or pause play.
- ④ **+/-** • Adjust volume.
• (Press and hold both buttons) reset DS3880W.
- ⑤ **Stand**
- ⑥ **USB**  • Connect an iPod/iPhone/iPad through an Apple USB cable (not supplied).
- ⑦ **WI-FI SETUP button/indicator**
- Connect the unit to a Wi-Fi network.
 - Show the Wi-Fi connection status of the unit.
- ⑧ **MP3-LINK**
- Connect an external audio player through the supplied MP3 link cable.
- ⑨ **DC IN**
- Connect the power adaptor.

Get started to use AirPlay

To get started with AirPlay, you need to:

- 1** Upgrade your iPod touch/iPhone/iPad to the latest iOS version (iOS 4.3 or later).
 - Or install the latest version of iTunes (iTunes 10 or later) on your PC/Mac.
- 2** Connect power to DS3880W, then turn it on (see 'Prepare' on page 11).
- 3** Connect DS3880W to your existing home Wi-Fi network.
- 4** Make sure that your iPod touch/iPhone/iPad or PC/Mac are also connected to the same Wi-Fi network.

3 Prepare

Always follow the instructions in this chapter in sequence.

Connect power

! Caution

- Risk of product damage! Make sure that the power supply voltage matches the voltage printed on the bottom of the unit.
- Risk of electric shock! When you unplug the AC adaptor, always pull the plug from the socket. Never pull the cord.
- Before you connect the AC adaptor, make sure that you have completed all the other connections.

DS3880W is designed with a built-in battery that allows you to enjoy music on the go. Before use, make sure to fully charge the built-in battery.

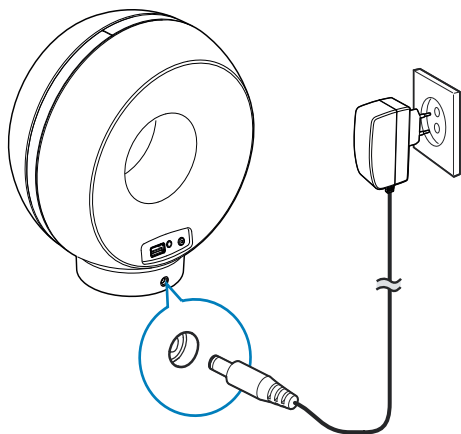

- 1 Dock the DS3880W main unit on the charging stand.
- 2 Connect the AC power cord to
 - the **DC IN** socket on the back of the charging stand.
 - the wall power socket.

* Tip

- After AC power connection, if the built-in battery is full, the power indicator on the front of the unit stays blue; if the built-in battery is not full, the power indicator flashes blue; if the battery is flat, the power indicator turns red.

Turn DS3880W on

- 1 Press \odot on the top to turn the unit on.
 - 2 Wait for successful boot-up of the unit.
 - ↳ The boot-up takes about 35 seconds.
 - ↳ During boot-up, the **Wi-Fi SETUP** indicator on the back of the unit blinks green quickly.
 - ↳ After boot-up, if no Wi-Fi connection has been set up for DS3880W, the **Wi-Fi SETUP** indicator starts to blink green slowly.
- To turn the unit off, press \odot again.

4 Connect to your home Wi-Fi network for AirPlay



To connect DS3880W to your existing home Wi-Fi network, you need to apply your home Wi-Fi setting to DS3880W.

You can do this in two ways (depending on which type of Wi-Fi router you use):

- Automatically - if your Wi-Fi router is WPS (Wi-Fi Protected Setup)-enabled and supports PBC (Push Button Connection) (see 'Scenario 1: Connect to a WPS router' on page 12)
- Manually - if your Wi-Fi router does not support WPS (see 'Scenario 2: Connect to a non-WPS router' on page 13)

Once connected successfully, DS3880W will remember your home Wi-Fi settings. Then you can enjoy AirPlay whenever DS3880W is powered on and connected to your home Wi-Fi network automatically.

Before connection of DS3880W to your home Wi-Fi network, check the points below.

- 1 Make sure that your Wi-Fi router is powered on and working properly.
- 2 Make sure that DS3880W has been powered on and booted up successfully (see 'Turn DS3880W on' on page 11).
- 3 Identify the type of your Wi-Fi router (see the user manual of your Wi-Fi router for details).

Scenario 1: Connect to a WPS router

Note

- Before you press any button on DS3880W, make sure that DS3880W has been booted up successfully (see 'Turn DS3880W on' on page 11).

- 1 Press the WPS button on your home Wi-Fi router:

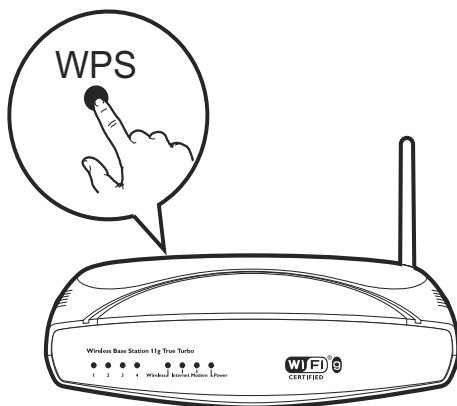

- 2 Shortly after step 1, press **Wi-Fi SETUP** on the back of DS3880W.
↳ The **Wi-Fi SETUP** indicator blinks red, yellow and green alternately.

- ↳ Within 2 minutes, the **WI-FI SETUP** indicator stops blinking and stays green, and the unit beeps.
- ↳ DS3880W is connected to your home Wi-Fi network successfully.

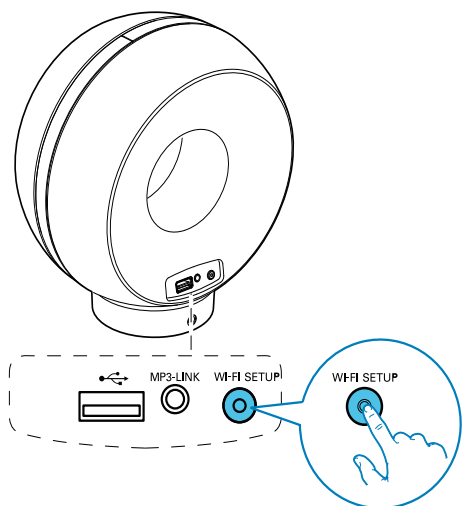

Tip

- For some Wi-Fi routers, you may need to hold the WPS button for Wi-Fi connection or enable the WPS PBC function from the router configuration pages. See the user manuals of the specific routers for details.
- If the **WI-FI SETUP** indicator on DS3880W blinks yellow, it means that the Wi-Fi connection has failed. Please wait for 2 minutes and try again. If the problem remains, try to set up the Wi-Fi connection manually (see 'Scenario 2: Connect to a non-WPS router' on page 13).
- If the Wi-Fi connection fails again, press and hold both the **+** and **-** buttons on the top of DS3880W to reset it, and then try again.

Scenario 2: Connect to a non-WPS router

Note

- You can also follow the procedures below to connect DS3880W to a WPS router manually.

To connect DS3880W to a Wi-Fi router manually, you need access to DS3880W's built-in configuration web page for change of its internal Wi-Fi settings. To do so, you need a Wi-Fi enabled device with an Internet browser for temporary Wi-Fi connection to DS3880W. The Wi-Fi enabled device can be an iPod touch/ iPhone/iPad or a Wi-Fi enabled PC/Mac. Follow the sequence below for connection of DS3880W to a non-WPS Wi-Fi router:

- 1 Collect settings of your home Wi-Fi router and write down on paper for use during DS3880W Wi-Fi setup (see 'Collect settings of your home Wi-Fi router' on page 14).
- 2 Switch DS3880W to Assisted Wi-Fi Setup mode (see 'Switch DS3880W to Assisted Wi-Fi Setup mode' on page 14).
 - ↳ A new Wi-Fi network created by DS3880W will appear; with the network name (SSID) of **Philips Fidelio AirPlay**.
- 3 Connect your Wi-Fi enabled device to the created new Wi-Fi network temporarily (see 'Connect your Wi-Fi enabled device to the newly created Wi-Fi network' on page 15).
- 4 Open the built-in web page of DS3880W with the Internet Browser of your Wi-Fi enabled device (see 'Open the built-in web page of DS3880W' on page 16).

- 5 Change the internal Wi-Fi settings of DS3880W based on the settings you wrote on paper at step 1 (see 'Change the internal Wi-Fi settings of DS3880W' on page 17).
- 6 Restore your Wi-Fi enabled device back to your existing home Wi-Fi settings (see 'Restore your Wi-Fi enabled device back to your existing home Wi-Fi setting' on page 18).

Collect settings of your home Wi-Fi router

Note

- Always consult the user manual of your home Wi-Fi router for detailed instructions.

- 1 Connect your Wi-Fi enabled device to your existing home Wi-Fi network.
- 2 Launch the Internet browser (for example, Apple Safari or Microsoft Internet Explorer) on your Wi-Fi enabled device.
- 3 Open the configuration page of your home Wi-Fi router.
- 4 Find the Wi-Fi settings tab and write down the following information on paper:
 - (A) Network name (SSID)
 - (B) Wi-Fi security mode (usually WEP, WPA or WPA2 if enabled)
 - (C) Wi-Fi password (if Wi-Fi security is enabled)
 - (D) DHCP mode (enabled or disabled)
 - (E) Static IP address settings (if DHCP mode is disabled)

Switch DS3880W to Assisted Wi-Fi Setup mode

Note

- Before you press any button on DS3880W, make sure that DS3880W has been booted up successfully (see 'Turn DS3880W on' on page 11).

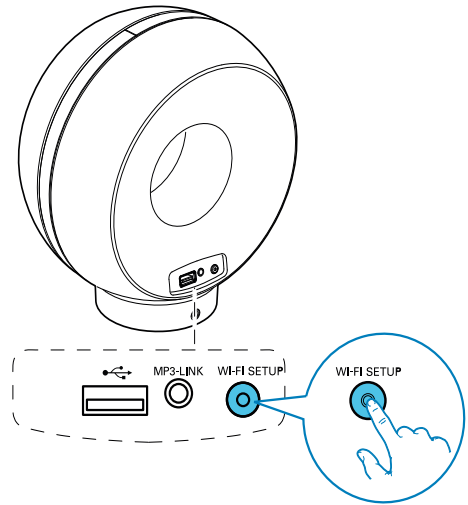

- Press and hold **Wi-Fi SETUP** on the back of DS3880W for more than 5 seconds.
 - ↳ The **Wi-Fi SETUP** indicator blinks green and yellow alternately.
 - ↳ A new Wi-Fi network created by DS3880W will appear, with the network name (SSID) of **Philips Fidelio AirPlay**.
 - ↳ It may take up to 45 seconds for successful creation of this new Wi-Fi network.

Note

- After you finish manual Wi-Fi setup for DS3880W, the new Wi-Fi network created by DS3880W will disappear.
- If you fail to enter Assisted Wi-Fi Setup mode, power off DS3880W and power on it, then try again after successful boot-up.
- Make sure that there are no other Philips AirPlay-enabled devices in Assisted Wi-Fi Setup mode at the same time. Multiple Wi-Fi networks created this way may interfere with each other.

Connect your Wi-Fi enabled device to the newly created Wi-Fi network

The new Wi-Fi network created by DS3880W only allows access of one Wi-Fi enabled device. To avoid interference from any other Wi-Fi devices, you are recommended to temporarily disable the Wi-Fi function on your other Wi-Fi devices.

Option 1: Use your iPod touch/iPhone/iPad

- 1 Select **Settings** -> **Wi-Fi** on your iPod touch/iPhone/iPad.

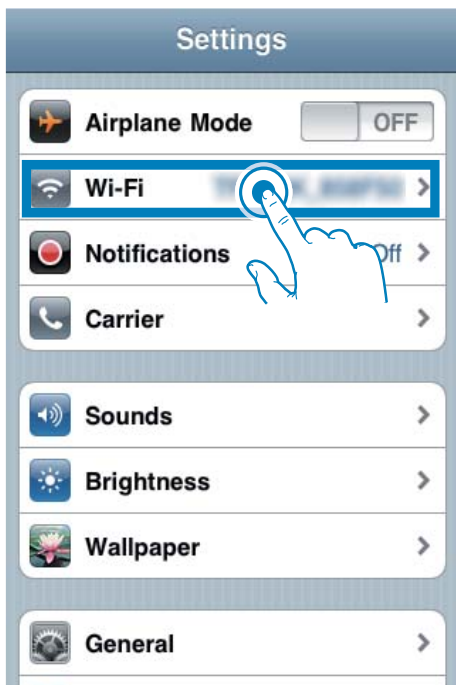

- 2 Select **Philips Fidelio AirPlay** from the list of available networks.

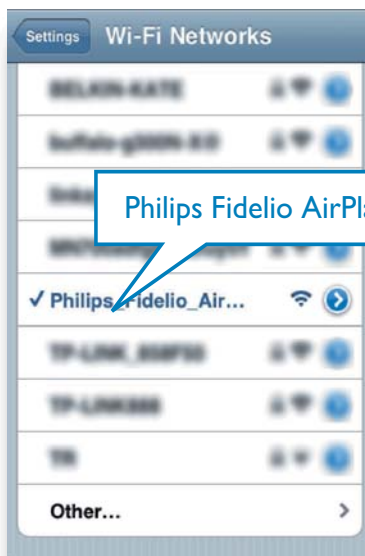

- 3 Wait until successful Wi-Fi connection on your iPod touch/iPhone/iPad.
↳  is displayed at the upper left corner of your iPod touch/iPhone/iPad.

Tip

- If **Philips Fidelio AirPlay** is not in the list, try to scan the available Wi-Fi networks again.

Use your Wi-Fi enabled PC/Mac

Note

- See the user manual of your PC/Mac for how to connect your PC/Mac to a Wi-Fi network.
- During Wi-Fi network connection, do not connect any network cable to your PC/Mac.

- 1 Open the Wi-Fi setup tool or control panel on your PC/Mac.

2 Scan the available Wi-Fi networks.



3 Select Philips Fidelio AirPlay from the list of available networks.

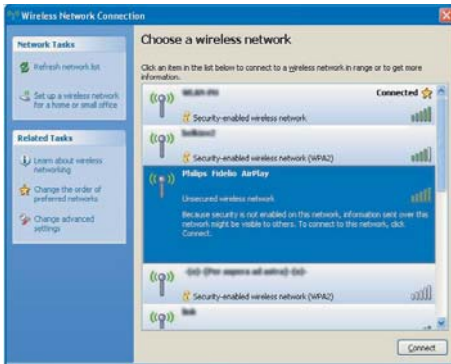

4 Wait until successful Wi-Fi connection on your PC/Mac.

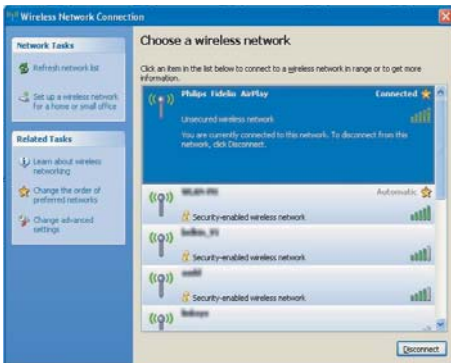

Tip

- If Philips Fidelio AirPlay is not in the list, try to scan the available Wi-Fi networks again.

Open the built-in web page of DS3880W

- 1 Launch Apple **Safari** browser or any other Internet browser on your Wi-Fi enabled device.
- 2 Type in **192.168.1.1** at the browser address bar and confirm.
 - ↳ The DS3880W configuration web page is displayed.



If you use Safari on your Wi-Fi enabled PC/Mac, you can also select 'Philips_Fidelio XXX' from the Bonjour pull-down list to enter the DS3880W configuration web page directly.

- 1 Click ***** -> **Preferences**.
↳ The Bookmarks menu is displayed.

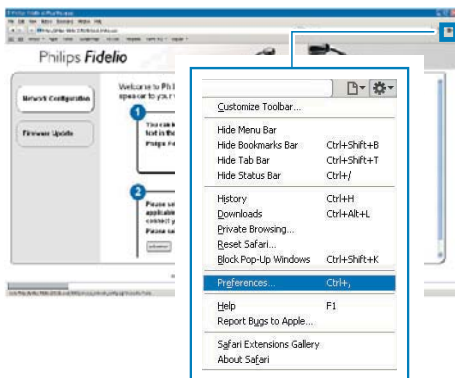

- 2 Tick **Include Bonjour** for **Bookmarks bar**.

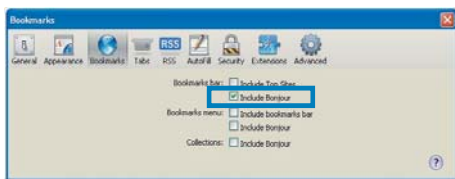

- 3 Select 'Philips_Fidelio XXX' from the Bonjour pull-down list shown at the bookmarks bar.
↳ The DS3880W configuration web page is displayed.

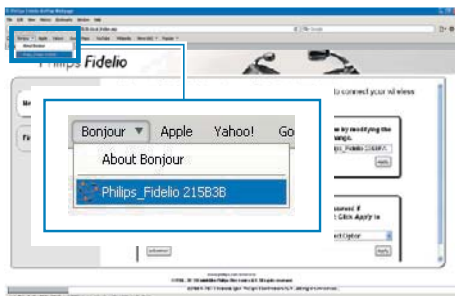

Change the internal Wi-Fi settings of DS3880W

On the DS3880W configuration web page, you can change the internal Wi-Fi settings of DS3880W for connection of DS3880W to your existing home Wi-Fi network.

Note

- Make sure that the settings on the configuration web page match your home Wi-Fi network settings that you wrote on paper.



- Follow the on-screen instructions to change and confirm the internal Wi-Fi settings of DS3880W.
↳ After a while, the indicator on the back of DS3880W stops blinking and stays green, and the unit beeps.
↳ DS3880W is connected to your existing home Wi-Fi network successfully.

Note

- If the **WI-FI SETUP** indicator on DS3880W does not stay green steadily, it means that the Wi-Fi connection has failed. Please power off both your Wi-Fi router and DS3880W and then power on them again to see whether DS3880W can be connected to your home Wi-Fi network. If the problem remains, try the above procedures again.
- After you finish the above changes or power-off and power-on of DS3880W, the new Wi-Fi network created by DS3880W will disappear.

Tip

- If you like, you can change the name of your DS3880W in **Advanced settings -> AirPlay Device Name** on the DS3880W configuration web page. This is helpful when you have multiple Philips AirPlay-enabled devices in your house and you need to distinguish between them.
- If you want to enter the network name (SSID) manually (for example, if you want to hide your SSID), go to **Advanced settings -> CONFIGURE MANUALLY** on the DS3880W configuration web page.

Restore your Wi-Fi enabled device back to your existing home Wi-Fi setting

Note

- Make sure that the settings at steps 2 to 3 below match your home Wi-Fi network settings you wrote on paper.

- 1 Select **Settings -> Wi-Fi** on your iPod touch/iPhone/iPad.
 - Or open the list of available Wi-Fi networks on your PC/Mac.

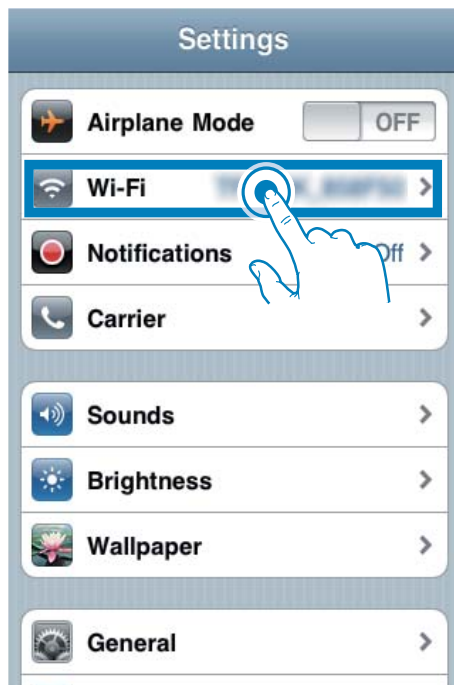

- 2 Select your network name (SSID) from the list of available wireless networks.



- 3 Enter the network key if required.
- 4 Wait until successful Wi-Fi connection to your home Wi-Fi network.

5 Play

Stream audio from your iTunes music library to DS3880W

Note

- Make sure that your iTunes host device is connected to the same Wi-Fi network as DS3880W. Your iTunes device can be an iPod touch/iPhone/iPad installed with iOS 4.3 (or later) or a Wi-Fi enabled PC/Mac installed with iTunes 10 (or later).

Stream from your iPod touch/iPhone/iPad

- 1 Launch the **iPod** application on your iPod touch/iPhone/iPad.
- 2 Tap on the AirPlay icon.

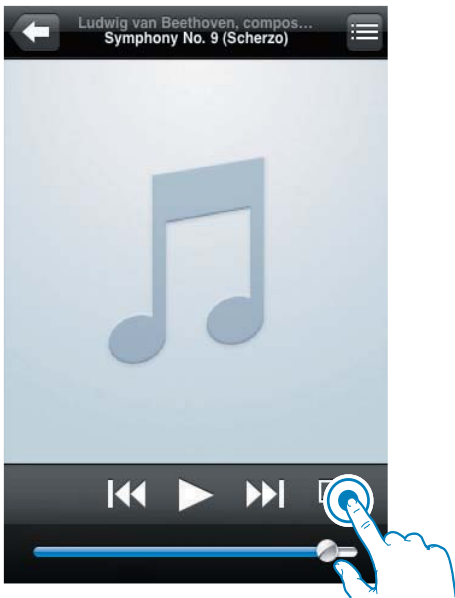

- 3 Select **Philips_Fidelio XXXX** (or user customized name) from the AirPlay list.



- 4 Select a media file and start play.
↳ After a while, you will hear music from DS3880W.

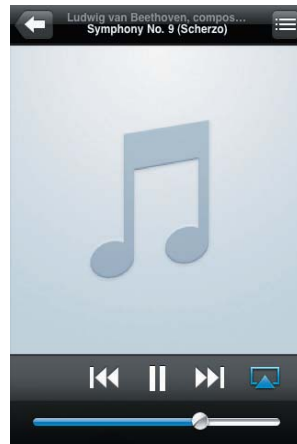

Note

- If you fail to hear music after successful setup, do one of the following on your iPod touch/iPhone/iPad:
- (1) Disconnect and then re-connect to the same Wi-Fi router again;
- (2) Close all applications running at the background;
- (3) Power off and then power on your iPod touch/iPhone/iPad again.

Stream from your PC/Mac

- 1 Launch iTunes 10 (or a later version) on your PC/Mac.
- 2 Click the AirPlay icon on the window.

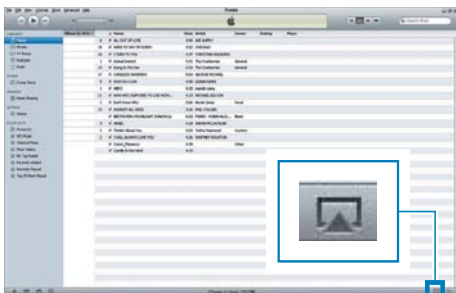

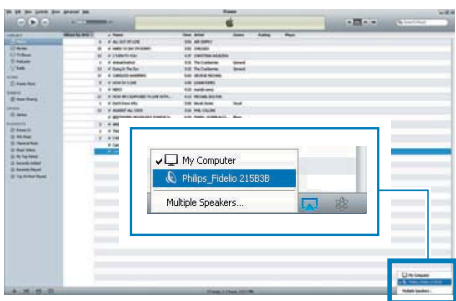

- 3 Select Philips_Fidelio_AirPlay XXXX (or user customized name) from the AirPlay list.

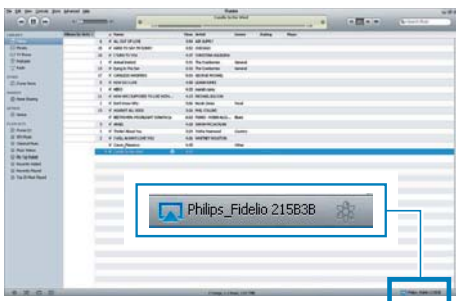

- 4 Select a media file and start play.
↳ After a while, you will hear music from DS3880W.



Tip

- When you stream audio from your iTunes music library on a PC/Mac, you can select more than one AirPlay-enabled devices (if available) at step 3 to stream music to all of them at the same time.
- If you are using an earlier version of iTunes, the AirPlay icon may be  instead of .

Control play

You can select different play options from either your iTunes host device or DS3880W.

Note

- Make sure that you have successfully streamed audio from your iTunes music library to DS3880W.

- To pause or resume play, press **▶||**.
- To adjust volume, press **+/-** repeatedly.

Tip

- If you are streaming music from a PC/Mac, to control music play from DS3880W, remember to tick **Allow iTunes audio control from remote speakers** in **Edit -> Preferences -> Devices** on iTunes.

Use advanced sound settings

If your iTunes host device is an iPod touch/iPhone/iPad:

For advanced sound settings and additional features, you can use your iPod touch/iPhone/iPad to download the **Philips Fidelio** application from Apple App Store. It is a free application from Philips.

If your iTunes host device is a Wi-Fi enabled PC/Mac:

For advanced sound settings, you can use the equalizer available on iTunes directly (**View -> Show Equalizer**).



Tip

- See the iTunes help documentation for more details.

Play/charge your iPod/iPhone/iPad through USB socket





Note

- The USB socket is only compatible with iPod/iPhone/iPad.
- To avoid possible damage to DS3880W, never try to connect devices other than iPod/iPhone/iPad to the USB socket on DS3880W.

You can play or charge your iPod/iPhone/iPad through the USB socket with an Apple USB cable (not supplied).

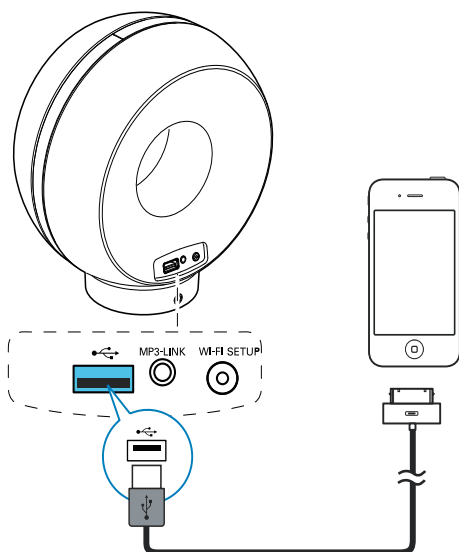
If you have stopped audio streaming by AirPlay, after successful USB connection, the unit switches to the USB source automatically.



- Connect an Apple USB cable (not supplied) to:
 - the **USB**  socket on the back of DS3880W.
 - the dock connector on your iPod/iPhone/iPad.



Tip

- With the built-in battery of DS3880W, you can play your iPod/iPhone/iPad on the go.
- The built-in battery does not support charge of your iPod/iPhone/iPad.

Compatible iPod/iPhone/iPad

The USB socket supports play and charge of the following iPod, iPhone, and iPad models.

- iPad 2
- iPad
- iPhone 4
- iPhone 3GS
- iPhone 3G
- iPhone
- iPod classic
- iPod 5G
- iPod 4G
- iPod nano (2nd, 3rd, 4th, 5th, and 6th generation)
- iPod touch (1st, 2nd, 3rd, and 4th generation)

Play from an external device

You can also listen to an external audio player through DS3880W.

If you have stopped both audio streaming by AirPlay and direct music play through the USB socket, DS3880W switches to the MP3 link source automatically.

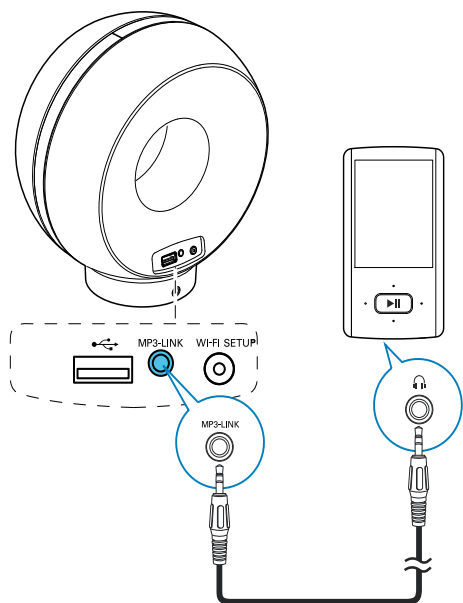

- Connect the supplied MP3 link cable to:
 - the **MP3-LINK** socket on the back of DS3880W.
 - the headphone socket on an external audio player.

6 Update firmware

To improve the performance of DS3880W, Philips may offer you new firmware for upgrade of your DS3880W.

Please register your product at www.philips.com/welcome for information about the latest firmware.

Note

- You can only update the firmware from a PC/Mac.

Download the update file

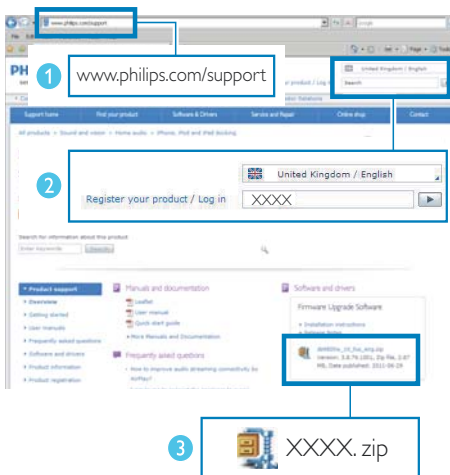

- On your PC/Mac, go to www.philips.com/support.
- Enter the model number to find the latest firmware upgrade file available.
- Save the upgrade file to your hard drive.

Update from the configuration page

Warning

- Always connect your DS3880W to AC power for firmware upgrade. Never power off your DS3880W during firmware upgrade.

Note

- To use an Internet browser other than Apple Safari on your PC/Mac, remember to go to the Wi-Fi router configuration page and write down the IP address of your DS3880W. See the user manual of your Wi-Fi router for how to find the IP addresses of devices connected to the Wi-Fi router.

- Power on DS3880W (see 'Prepare' on page 11).
 - It takes about 35 seconds for the unit to boot up. During boot-up, the **WI-FI SETUP** indicator on the back of the unit blinks green quickly.
 - After boot-up, you can hear a beep and the **WI-FI SETUP** indicator turns to green steadily. DS3880W is connected to the last configured Wi-Fi network automatically.
- Make sure that DS3880W and your PC/Mac are connected to the same Wi-Fi router.
- Open Apple **Safari** on your PC/Mac, then select 'Philips_Fidelio XXXX' from the Bonjour pull-down list.
 - Or open any other Internet browser on your PC/Mac, then type in the IP address of DS3880W (available on the Wi-Fi router configuration page) at the address bar.
 - The DS3880W configuration web page is displayed.

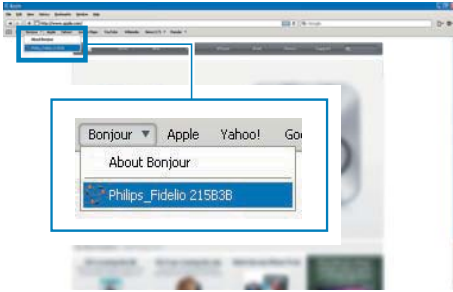

- 4 Follow the on-screen instructions to complete the firmware update.

Note

- In case the firmware update fails, you can try the above procedures again.
- After successful firmware update, if there is any problem with the Wi-Fi connection, press and hold both the + and - buttons on DS3880W for more than 5 seconds at the same time to reset the device, and then try to set up the Wi-Fi network for DS3880W again.

7 Product information

Note

- Product information is subject to change without prior notice.

Specifications

Amplifier

Rated Output Power	4 X 4 W RMS
Frequency Response	63 - 20 kHz
Signal to Noise Ratio	> 75 dB
MP3 Link	650 mV RMS 20 kohm

Speakers

Speaker Impedance	8 ohm
Speaker Driver	40 mm full range
Sensitivity	78 dB/m/W

Wireless

Wireless standard	802.11b/g
Wireless security	WEP (64 or 128 bit), WPA/WPA2 (8-63 characters)
Frequency range	2412 - 2462 MHz (CH1-CH11) (for /79, /37, /55, /97) 2412 - 2472 MHz (CH1-CH13) (for /12, /10, /05)
PBC (one button push)	Yes

General information

AC power	Input: 100 - 240 V~, 50/60 Hz 1A/1.2 A Output: 12 V --- 3.0 A
Operation Power Consumption	35 W
Power Consumption in Standby Mode	≤ 0.5 W
Dimensions	- Main Unit (L x W x H) 198 x 100 x 215 mm
Weight	- With Packing 1.95 kg - Main Unit 1.32 kg

8 Troubleshooting



Warning

- Never remove the casing of this apparatus.

To keep the warranty valid, never try to repair the system yourself.

If you encounter problems when using this apparatus, check the following points before requesting service. If the problem remains unsolved, go to the Philips web site (www.philips.com/welcome). When you contact Philips, ensure that the apparatus is nearby and the model number and serial number are available.

No power

- Make sure that the AC power plug of the device is connected properly.
- Make sure that there is power at the AC outlet.
- Before you carry DS3880W for use on the go, make sure to fully charge the built-in battery.

No sound

- Adjust the volume.
- Check the Wi-Fi network connection. Set up the network again if needed.

No response from the unit

- Press and hold both the + and - buttons on DS3880W for more than 5 seconds to reset the device. Then set up the Wi-Fi network for DS3880W again.
- Disconnect and reconnect the AC power plug, and then switch on the device again.

Wi-Fi network connection failed

- Check if your Wi-Fi router is Wi-Fi 802.11b/g certified. This device is only compatible with Wi-Fi 802.11b/g certified routers.

- If your Wi-Fi router is Wi-Fi 802.11n certified, make sure to enable the 802.11b/g mode. DS3880W does not support connection to routers with 802.11n only.
- This device does not support the WPS-PIN method.
- If your Wi-Fi router supports WPS and the WPS-PBC method but fails to connect to DS3880W, try the manual Wi-Fi setup method (see 'Scenario 2: Connect to a non-WPS router' on page 13).
- Enable SSID broadcast on the Wi-Fi router.
- Keep away from potential sources of interference which may affect Wi-Fi signal, such as microwave ovens.
- If you fail to use your PC for Wi-Fi network setup, check whether your PC is using a Wi-Fi network. You cannot use Ethernet connection for AirPlay network setup.
- Make sure that the SSID name of your home router consists of alphanumeric characters, with no space or special characters like %/#/* inserted.
- If you choose to rename the AirPlay device '**Philips_Fidelio XXXX**' in the setting menu, do not use special characters or symbols.
- For some new types of Wi-Fi routers, a network name (SSID) may be created automatically when you use WPS for connection. Always change the default network name (SSID) to a simple one that consists of alphanumeric characters, and also change the Wi-Fi security mode to secure your network.

Occasional breaking of AirPlay music streaming

Do one or all of the following:

- Move DS3880W closer to your Wi-Fi router.
- Remove any obstacles between DS3880W and your Wi-Fi router.
- Avoid using Wi-Fi channel which is overlapped by the nearby Wi-Fi network.

- Check if your network speed is fast enough (in cases where multiple devices share the same router, the AirPlay performance may be affected). Turn off the other devices connected to your home router.
- Enable the Quality of Service (QoS) option (if available on the Wi-Fi router).
- Turn off other Wi-Fi routers.

No AirPlay icon on my iTunes host device

- Make sure that DS3880W is already connected to your home Wi-Fi network.
- Before you open iTunes, make sure that you have enabled Bonjour service in your PC. Take Windows XP for example: to enable the service, you can click **Start->Control Panel**, and double-click **Administrative Tools-> Services->Bonjour Service**, then click **Start** followed by **OK** on the pop-up menu.
- If the problem remains, try to restart DS3880W.

AirPlay connection failed with Mac or PC

- Temporarily disable the firewall and security software to see whether it blocks the ports that AirPlay uses to stream content. See the help documentation of your firewall and security software on how to unblock the ports used by AirPlay.
- When you use iPod Touch/iPhone/iPad/Mac/PC for AirPlay, if the music play breaks or stops, try to restart your iPod Touch/iPhone/iPad, iTunes or DS3880W.
- Video streaming or FTP downloads may overload your router and therefore may cause interruptions during AirPlay music play. Try to reduce the load of your router.

