

User manual

Руководство пользователя

Instrukcje obsługi

Uživatelské příručky

Používateľské príručky

Felhasználói útmutatók



# PHILIPS

## MAGYARORSZÁG

### Minőségtanúsítás

A garanciajegyben feltüntetett forgalombahozó vállalat a 2/1984. (III.10.) BkM-IpM együttes rendelet értelmében tanúsítja, hogy ezen készülék megfelel a műszaki adatokban megadott értékeknek.

**Figyelem! A meghibásodott készüléket – beleértve a hálózati csatlakozót is – csak szakember (szervíz) javíthatja. Ne tegye ki a készüléket esőnek vagy nedvesség hatásának!**

### Garancia

A forgalombahozó vállalat a termékre 12 hónap garanciát vállal.

Névleges feszültség ..... 220 – 240 V / 50 Hz  
Elemes működéshez ..... 2xAAA  
Névleges frekvencia ..... 50 Hz (vagy 50-60 Hz)

Teljesítmény  
maximális ..... 55 W  
készületi állapotban ..... < 1 W

Érintésvédelmi osztály II.

Tömeg ..... 5.15 kg

Befoglaló méretek  
szélesség ..... 232 mm  
magasság ..... 75.5 mm  
mélység ..... 223.5 mm

Rádiórész vételi tartomány

URH ..... 87,5 – 108 MHz  
MW ..... 531 – 1602 KHz

Erősítő rész

Kimeneti teljesítmény ..... 1800 W PMPO  
..... 2x50 W RMS

## ČESKA REPUBLIKÁ

**Zystraha! Tento přístroj pracuje s laserovým paprskem. Při nesprávné manipulaci s přístrojem (v rozporu s tímto návodem) může dojít k nebezpečnému ozáření. Proto přístroj za chodu neotevírejte ani nesnímejte jeho kryty. Jakoukoli opravu vždy svěřte specializovanému servisu.**

**Nebezpečí! Při sejmutí krytů a odjištění bezpečnostních spínačů hrozí nebezpečí neviditelného laserového záření!**

**Chraňte se před přímým zásahem laserového paprsku.**

**Záruka: Pokud byste z jakéhokoli důvodu přístroj demontovali, vždy nejdříve vytáhněte síťovou zástrčku.**

**Přístroj chraňte před jakoukoli vlhkostí i před kapkami**

## SLOVAK REPUBLIC

**Prístroj sa nesmie používať v mokrom a vlhkom prostredí! Chráňte pred striekajúcou a kvapkajúcou vodou!**

## CAUTION

**Use of controls or adjustments or performance of procedures other than herein may result in hazardous radiation exposure or other unsafe operation.**

**Manufactured under license from Dolby Laboratories.**

"Dolby", "Pro Logic" and the double-D symbol are trademarks of Dolby Laboratories.

MANUFACTURED UNDER LICENSE FROM DIGITAL THEATER SYSTEMS, INC. US PAT. NO 5,451,942, 5,956,674, 5,974,380, 5,978,762 AND OTHER WORLDWIDE

PATENTS ISSUED AND PENDING. "DTS" AND "DTS DIGITAL SURROUND" ARE REGISTERED TRADEMARKS OF DIGITAL THEATER SYSTEMS, INC. COPYRIGHT 1996, 2000 DIGITAL THEATER SYSTEMS, INC. ALL RIGHTS RESERVED.

This product incorporates copyright protection technology that is protected by method claims of certain U.S. patents and other intellectual property rights owned by Macrovision Corporation and other rights owners. Use of this copyright protection technology must be authorized by Macrovision Corporation, and is intended for home and other limited viewing uses only unless otherwise authorized by Macrovision Corporation. Reverse engineering or disassembly is prohibited.

**DivX, DivX Certified, and associated logos are trademarks of DivX Networks, Inc and are used under license.**



**Windows Media is a trademark of Microsoft Corporation.**

# Language Code

Abkhazian	6566	Inupiaq	7375	Pushto	8083
Afar	6565	Irish	7165	Russian	8285
Afrikaans	6570	Íslenska	7383	Quechua	8185
Amharic	6577	Italiano	7384	Raeto-Romance	8277
Arabic	6582	Ivrit	7269	Romanian	8279
Armenian	7289	Japanese	7465	Rundi	8278
Assamese	6583	Javanese	7486	Samoan	8377
Avestan	6569	Kalaallisut	7576	Sango	8371
Aymara	6589	Kannada	7578	Sanskrit	8365
Azerhaini	6590	Kashmiri	7583	Sardinian	8367
Bahasa Melayu	7783	Kazakh	7575	Serbian	8382
Bashkir	6665	Kernewek	7587	Shona	8378
Belarusian	6669	Khmer	7577	Shqip	8381
Bengali	6678	Kinyarwanda	8287	Sindhi	8368
Bihari	6672	Kirghiz	7589	Sinhalese	8373
Bislama	6673	Komi	7586	Slovensky	8373
Bokmål, Norwegian	7866	Korean	7579	Slovenian	8376
Bosanski	6683	Kuanyama; Kwanyama	7574	Somali	8379
Brezhoneg	6682	Kurdish	7585	Sotho; Southern	8384
Bulgarian	6671	Lao	7679	South Ndebele	7882
Burmese	7789	Latina	7665	Sundanese	8385
Castellano, Español	6983	Latvian	7686	Suomi	7073
Catalán	6765	Letzeburgesch;	7666	Swahili	8387
Chamorro	6772	Limburgan; Limburger	7673	Swati	8383
Chechen	6769	Lingala	7678	Svenska	8386
Chewa; Chichewa; Nyanja	7889	Lithuanian	7684	Tagalog	8476
中文	9072	Luxembourgish;	7666	Tahitian	8489
Chuang; Zhuang	9065	Macedonian	7775	Tajik	8471
Church Slavic; Slavonic	6785	Malagasy	7771	Tamil	8465
Chuvash	6786	Magyar	7285	Tatar	8484
Corsican	6779	Malayalam	7776	Telugu	8469
Česky	6783	Maltese	7784	Thai	8472
Dansk	6865	Manx	7186	Tibetan	6679
Deutsch	6869	Maori	7773	Tigrinya	8473
Dzongkha	6890	Marathi	7782	Tonga (Tonga Islands)	8479
English	6978	Marshallese	7772	Tsonga	8483
Esperanto	6979	Moldavian	7779	Tswana	8478
Estonian	6984	Mongolian	7778	Türkçe	8482
Euskara	6985	Nauru	7865	Turkmen	8475
Ελληνικά	6976	Navaho; Navajo	7886	Twi	8487
Faroese	7079	Ndebele, North	7868	Uighur	8571
Français	7082	Ndebele, South	7882	Ukrainian	8575
Frysk	7089	Ndonga	7871	Urdu	8582
Fijian	7074	Nederlands	7876	Uzbek	8590
Gaelic; Scottish Gaelic	7168	Nepali	7869	Vietnamese	8673
Gallegan	7176	Norsk	8789	Volapuk	8679
Georgian	7565	Northern Sami	8369	Walloon	8765
Gikuyu; Kikuyu	7573	North Ndebele	7868	Welsh	6789
Guarani	7178	Norwegian Nynorsk;	7878	Wolof	8779
Gujarati	7185	Occitan; Provençal	7967	Xhosa	8872
Hausa	7265	Old Bulgarian; Old Slavonic	6785	Yiddish	8973
Herero	7290	Oriya	7982	Yoruba	8979
Hindi	7273	Oromo	7977	Zulu	9085
Hiri Motu	7279	Ossetian; Ossetic	7983		
Hrvatski	6779	Pali	8073		
Ido	7379	Panjabi	8065		
Interlingua (International)	7365	Persian	7065		
Interlingue	7365	Polski	8076		
Inuktitut	7385	Português	8084		

English ----- 6

Русский ----- 40

Polski ----- 78

Česky ----- 115

Slovensky ----- 149

Magyar ----- 184

English

Русский

Polski

Česky

Slovensky

Magyar

## General Information

Features .....	8
Supplied accessories .....	8
Environment information .....	8
Installation .....	8
Maintenance .....	9

## Connections

Step 1: Placing speakers .....	10
Step 2: Connecting speakers .....	11
Step 3: Connecting the control cable .....	11
Step 4: Connecting TV .....	11~13
Step 5: Connecting FM/MW antennas .....	13
Step 6: Connecting the power cord .....	14
Additional: Connecting additional equipment	14

## Functional Overview

DVD player and power amplifier .....	15
Remote control .....	16~17

## Getting Started

Step 1: Inserting batteries into the Remote Control .....	18
Using the Remote Control to operate the Player	
Step 2: Setting up the TV .....	18~19
Setting up Progressive Scan feature	
To deactivate Progressive manually	
Step 3: Setting language preference .....	20
Setting the OSD Language	
Setting the Audio, Subtitle and Disc Menu language	

## Basic Functions

Switching the system on/off .....	21
Switching the system to Eco Power Standby mode .....	21
Power-saving automatic standby .....	21
Volume control .....	21
Sound control .....	21
DBB (Dynamic Bass Boost)	
DSC (Digital Sound Control)	
LOUDNESS	
Dimming the display screen .....	21

## Disc Operations

Playable Discs .....	22
Playing discs .....	22
Using the Disc Menu .....	23
Basic playback controls .....	23~25
Pausing playback (DVD/VCD/CD/MP3/WMA)	
Selecting a track/chapter/title (DVD/VCD/CD/MP3/WMA)	
Resuming playback from the last stopped point (DVD/VCD/CD/MP3/WMA)	
Zoom (DVD/VCD/JPEG)	
Repeat (DVD/VCD/CD/MP3/WMA)	
Repeat A-B (DVD/VCD/CD/MP3/WMA)	
Slow Motion (DVD/VCD)	
Program (not for Picture CD)	
Forward/Reverse Searching (DVD/VCD/CD/MP3/WMA)	
Time search & search by chapter/track number (DVD/VCD/CD/MP3/WMA)	
Information display during playback (not for Picture CD)	
Special disc features .....	25
Playing a Title (DVD)	
Camera Angle (DVD)	
Changing the Audio Language (for DVD recorded with multiple languages)	
Changing the Audio Channel (for VCD only)	
Subtitles (DVD)	
Playing MP3/WMA/JPEG Picture disc .....	25
Playing MP3/WMA disc .....	25
General operation	
Playback selection	
Playing JPEG Picture CD .....	26
General operation	
Playback selection	
Special JPEG features .....	26
Preview function (JPEG)	
Zoom picture (JPEG)	
Slide show playback modes (JPEG)	
Playback with multi-angles (JPEG)	
Playing a DivX disc .....	27

---

## System Menu Options

Basic Operations .....	28
General Setup Page .....	28
TV Display	
OSD Language	
Screen Saver	
DIVX(R) VOD registration code	
Audio Setup Page .....	29~30
Digital Audio Setup	
Dolby Digital Setup	
3D Processing	
HDCD	
Night Mode	
Video Setup Page .....	30~31
Video Output	
TV Mode	
Color Setting	
Preference Page .....	31-32
Parental	
Default	
Password Setup Page .....	32
Password mode	
Password	

---

## Other Functions

Radio reception .....	33
Tuning to radio stations	
Presetting radio stations	
Listening to preset radio stations	
RDS .....	33
Setting the RDS clock .....	33
Setting the clock .....	33
Setting sleep/wake-up timer .....	34
Sleep timer setting	
Wake-up timer setting	

---

## Specifications .....

35

---

## Troubleshooting .....

36~36

---

## Glossary .....

39

# General Information

## Features

Your DVD Micro Theatre with 2.0 channel full digital amplifier creates the same dynamic sound qualities that you find in full-fledged cinemas and incorporates some of the best features in home theater technology.

### Other features include:

Built-in DTS and Dolby Digital decoder; supporting Incredible Surround and DSC sound setting.

### Additional Component Connections

Lets you connect other audio and audio/visual components to the DVD micro theatre.

### Night mode

Lets you compress the dynamic range, reducing the difference in loudness between different sounds in Dolby Digital mode.

### Parental Control (Rating Level)

Lets you set a ratings level so that your children cannot watch a DVD that has a rating higher than you set.

### Sleep/Wake-up Timer

Enables the system to switch on/off automatically at a preset time.

### Progressive Scan

Provides high quality flicker-free images for film based sources. When a picture refreshes, its vertical resolution can double to 525 lines.

#### Note:

- *To fully enjoy the progressive scan feature, you need a progressive scan TV.*

## Supplied accessories

- Remote control with two AAA batteries
- MW loop antenna
- FM wire antenna
- Audio (white, red) and composite video (yellow) cables (2-in-1)
- SCART cable
- Control cable
- Stand for the DVD player and power amplifier
- 2 loudspeaker boxes including 2 speaker cables
- This instruction booklet and a Quick Start Guide

***If any item is damaged or missing, contact your retailer or Philips.***

## Environmental information

All unnecessary packaging has been omitted. We have tried to make the packaging easy to separate into three materials: cardboard (box), polystyrene foam (buffer) and polyethylene (bags, protective foam sheet).

Your system consists of materials which can be recycled and reused if disassembled by a specialised company. Please observe the local regulations regarding the disposal of packaging materials, exhausted batteries and old equipment.

## Installation

- Place the player on a flat, hard, and stable surface.
- In a cabinet, allow about 10cm (4 inches) of free space all around the player for adequate ventilation.



- Do not expose your player to extreme temperatures or humidity.
- The apparatus shall not be exposed to dripping or splashing.
- No objects filled with liquids, such as vases, shall be placed on the apparatus.
- No naked flame sources, such as lighted candles, shall be placed on the apparatus.
- Install this unit near the AC outlet and where the AC power plug can be reached easily.
- The ventilation should not be impeded by covering the ventilation openings with items, such as newspapers, table-cloths, curtains, et.

## Maintenance

- When a disc becomes dirty, clean it with a cleaning cloth. Wipe the disc from the center out, in a straight line.
- Do not expose the player, batteries or discs to humidity, rain, sand or excessive heat (caused by heating equipment or direct sunlight). Always keep the disc tray closed to avoid dust on the lens.
- Do not use solvents such as benzene, thinner, commercially available cleaners, or anti-static spray intended for colour discs.
- The lens may cloud over when the player is suddenly moved from cold to warm surroundings, making it impossible to play a disc. Leave the player in the warm environment until the moisture evaporates.



## Disposal of your old product

Your product is designed and manufactured with high quality materials and components, which can be recycled and reused.



When this crossed-out wheeled bin symbol is attached to a product it means the product is covered by the European Directive 2002/96/EC

Please inform yourself about the local separate collection system for electrical and electronic products.

Please act according to your local rules and do not dispose of your old products with your normal household waste. The correct disposal of your old product will help prevent potential negative consequences for the environment and human health.

# Connections

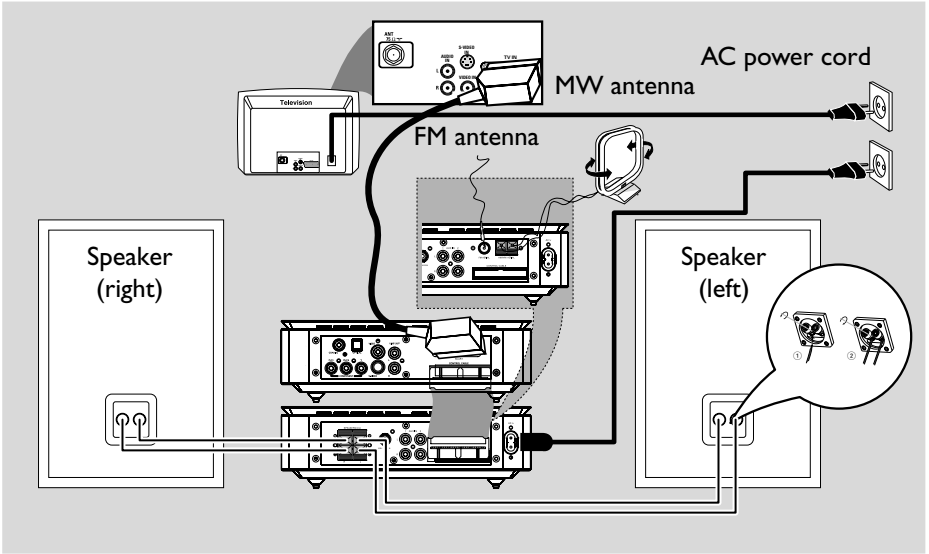

## IMPORTANT!

- The type plate is located at the bottom of the system.
- Before connecting the AC power cord to the wall outlet, ensure that all other connections have been made.
- Never make or change any connections with the power switched on.

## Notes:

- To avoid magnetic interference, do not position the front speakers too close to your TV set.
- Allow adequate ventilation around the DVD System.

## Step 1: Placing speakers

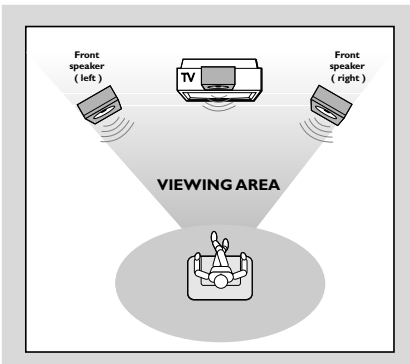

Place the front left and right speakers at equal distances from the TV set and at an angle of approximately 45 degrees from the listening position.

## Step 2: Connecting speakers

Connect the speaker wires to the SPEAKERS terminals, right speaker to "R" and left speaker to "L", coloured (marked) wire to "+" and black (unmarked) wire to "-". Fully insert the stripped portion of the speaker wire into the terminal as shown.

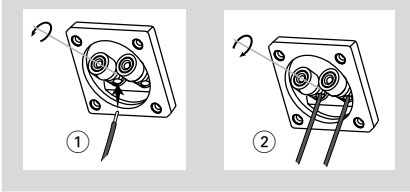

### Notes:

- Ensure that the speaker cables are correctly connected. Improper connections may damage the system due to short-circuit.
- For optimal sound performance, use the supplied speakers.
- Do not connect more than one speaker to any one pair of +/- speaker jacks.
- Do not connect speakers with an impedance lower than the speakers supplied. Please refer to the SPECIFICATIONS section of this manual.

## Step 3: Connecting the control cable

- Connect the serial port marked "CONTROL CABLE" at the rear of the DVD player to the same port at the rear of the power amplifier with the supplied flat control cable.

## Step 4: Connecting TV

### IMPORTANT!

- You only need to make one video connection from the following options, depending on the capabilities of your TV.
- Connect the DVD system directly to the TV.
- A SCART connection will let you use features both Audio and Video on the DVD Player.

### Using SCART jack

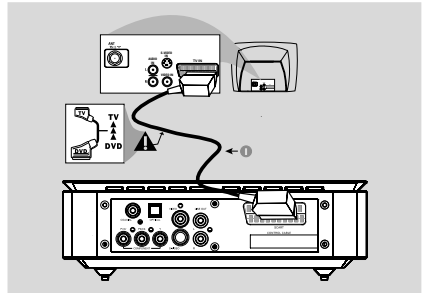

- Use the SCART cable (black) to connect the DVD Player's SCART jack (**SCART**) to the corresponding Scart input jacks on the TV.

### Note:

- Ensure that the "TV" indication on SCART cable is connected to the TV set and "DVD" indication on SCART cable is connected to the DVD Player.

### Using Composite Video jack

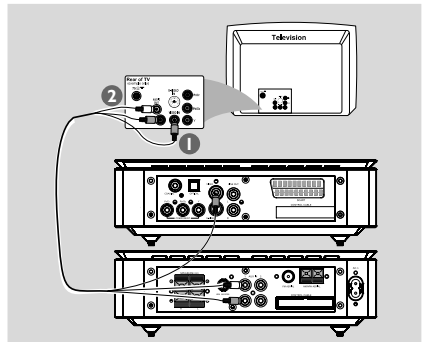

- 1 Use the composite video connectors (yellow) of the supplied audio and composite video cables (2-in1) to connect the DVD system's **VIDEO OUT** jack to the video input jack (or labeled as A/V In, CVBS, Composite or Baseband) on the TV.
- 2 To hear the TV channels through this DVD system, use the audio connectors (white/ red) of the supplied audio and composite video cables (2-in1) to connect **AUX IN** jacks to the corresponding AUDIO OUT jacks on the TV.

# Connections

## Using Component Video jacks (Y Pb Pr)

### IMPORTANT!

– The progressive scan video quality is only possible when using Y Pb Pr, and a progressive scan TV is required.

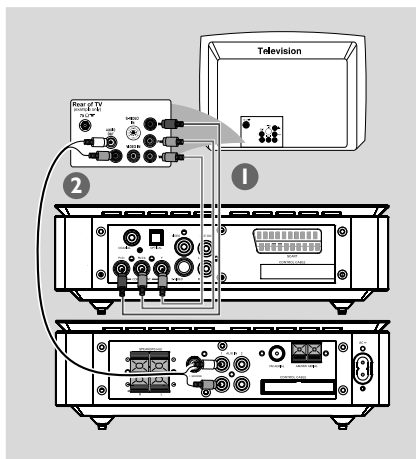

- 1 Use component video cables (red/blue/green - not supplied) to connect the DVD system's Y Pb Pr jacks to the corresponding Component video input jacks (or labeled as Y Pb/Cb Pr/Cr or YUV) on the TV.
- 2 To hear the TV channels through this DVD system, use the audio connectors (white/ red) of the supplied audio and composite video cables (2-in1) to connect **AUX IN** jacks to the corresponding AUDIO OUT jacks on the TV.
- 3 If you are using a Progressive Scan TV (TV must indicate Progressive Scan or ProScan capability), to activate TV Progressive Scan, please refer to your TV user manual. For DVD system Progressive Scan function, see "Getting Started-Setting up Progressive Scan feature".

### Note:

– If your TV does not support Progressive Scan, you will not be able to view the picture.

Press **SYSTEM** on the remote to exit the system menu and then **DISC** to exit progressive scan.

## Using S-Video jack

### IMPORTANT!

– If S-Video is used for DVD playback connection, the system's VIDEO OUT setting will need to be changed accordingly.

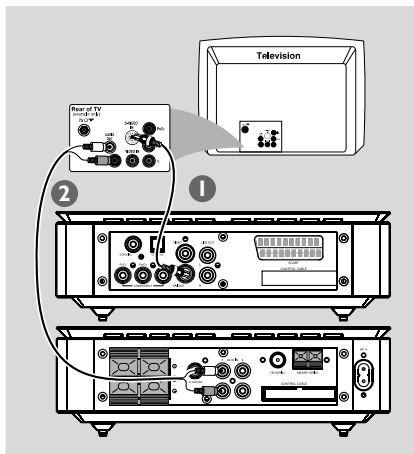

- 1 Use an S-Video cable (not supplied) to connect the DVD system's S-VIDEO jack to the S-Video input jack (or labeled as Y/C or S-VHS) on the TV.
- 2 To hear the TV channels through this DVD system, use the audio connectors (white/ red) of the supplied audio and composite video cables (2-in1) to connect **AUX IN** jacks to the corresponding AUDIO OUT jacks on the TV.

## Using an accessory RF modulator

### IMPORTANT!

– If your TV only has a single Antenna In jack (labeled as 75 ohm or RF In), you will need an RF modulator in order to view DVD playback on the TV. See your electronics retailer or contact Philips for details on RF modulator availability and operations.

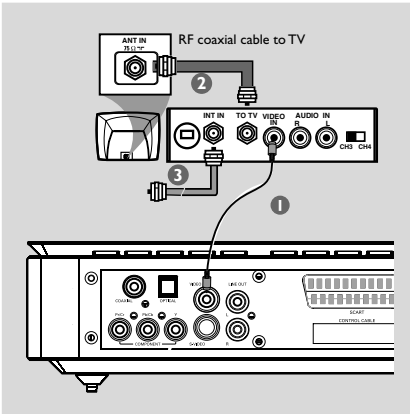

- 1 Use the composite video cable (yellow) to connect the DVD system's VIDEO OUT jack to the video input jack on the RF modulator.
- 2 Use an RF coaxial cable (not supplied) to connect ANTENNA OUT or TO TV jack on the RF modulator to the Antenna IN jack on the TV.
- 3 Connect the Antenna or Cable TV service signal to the ANTENNA IN or RF IN jack on the RF modulator. (It may have been connected to your TV previously. Disconnect it from the TV.)

## Step 5: Connecting FM/MW antennas

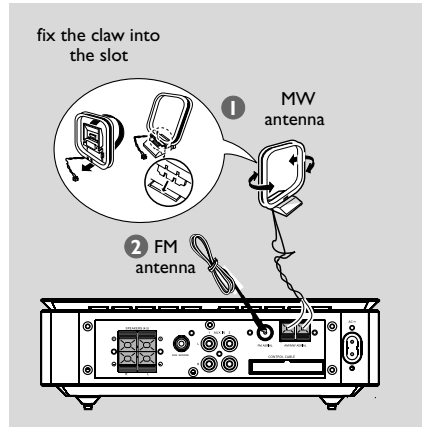

- 1 Connect the supplied MW loop antenna to the MW jack. Place the MW loop antenna on a shelf or attach to a stand or wall.
- 2 Connect the supplied FM antenna to the FM (75  $\Omega$ ) jack. Extend the FM antenna and fix its end to the wall.

For better FM stereo reception, connect an external FM antenna (not supplied).

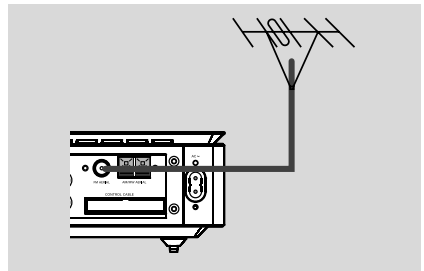

### Note:

- Adjust the position of the antennas for optimal reception.
- Position the antennas as far as possible from your TV, VCR or other radiation source to prevent unwanted interference.

## Step 6: Connecting the power cord

After everything is connected properly, plug in the AC power cord to the power outlet.

Never make or change any connection with the power switched on.

## Additional: Connecting additional equipment

### IMPORTANT!

- Some discs are copy-protected. You cannot record the disc through a VCR or digital recording device.
- When making connections, make sure the colour of cables matches the colour of jacks.
- Always refer to the owner's manual of the other equipment for complete connection and usage details.

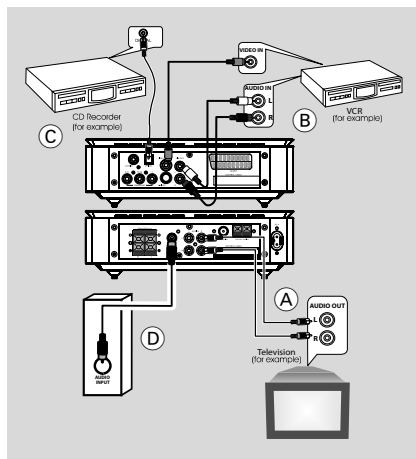

## Viewing and listening to the playback of other equipment (A)

- Connect the system's **AUX IN (R/L)** jacks to the AUDIO OUT jacks on the other audio/visual device (such as a TV, VCR, Laser Disc player or cassette deck).  
Before starting operation, press **SOURCE** on the front panel to select AUX or press **AUX** on the remote in order to activate the input source.

## Using the VCR for recording DVDs (B)

- Connect one of the system's **VIDEO** jacks to the corresponding VIDEO IN jack and **LINE OUT (R/L)** jacks to the AUDIO IN jacks on the VCR. This will allow you to make analogue stereo (two channel, right and left) recordings.

## Recording (digital) (C)

- Connect the system's **COAXIAL** or **OPTICAL** jack to the DIGITAL IN jack on a digital recording device (such as DTS-Digital Theatre compatible, with Dolby Digital decoder). Before starting operation, set the DIGITAL OUT according to the audio connection. (See "DIGITAL OUT".)

## Connecting an active subwoofer (D)

- Connect the DVD micro system's **SUBWOOFER** jack to the AUDIO INPUT jack on an active subwoofer (not supplied).

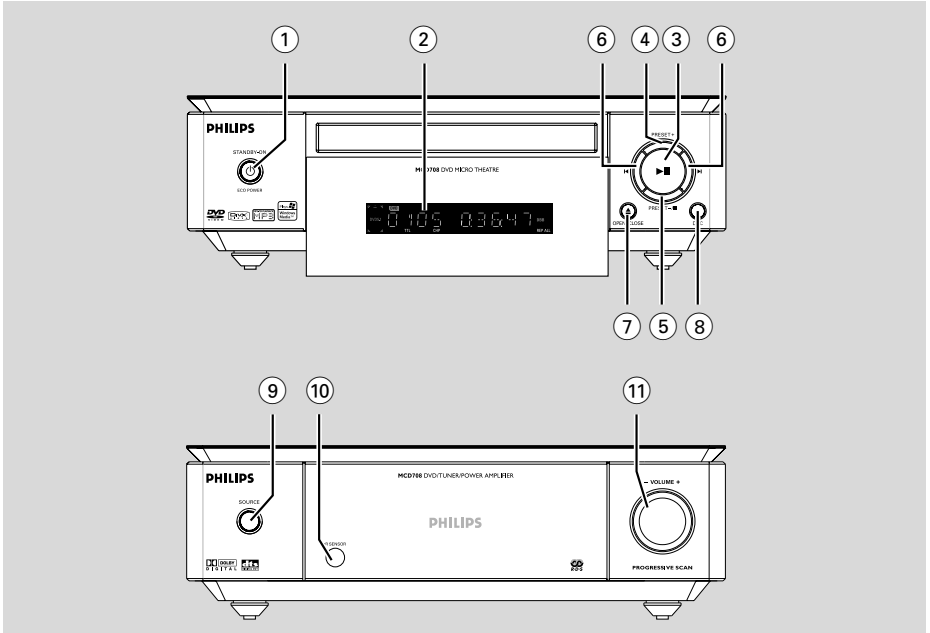

## DVD player and power amplifier

### ① ECO POWER/STANDBY-ON $\downarrow$

- to switch the system on or to Eco power/normal standby mode.

### ② Display

- shows the current status of the DVD player.

### ③ $\blacktriangleright \parallel$

- starts or interrupts disc playback.

### ④ PRESET +

- in tuner mode, selects a preset radio station forward.

### ⑤ PRESET -

- stops disc playback or erases a program.
- in tuner mode, selects a preset radio station backward.

### ⑥ $\blacktriangleleft \blacktriangleright$

#### Disc:

- skips to the previous/next chapter/title/track.

#### Tuner:

- tunes to a higher/lower radio frequency.

- press and hold, then release the key to start automatic search for a radio frequency downward/upward.

### ⑦ OPEN-CLOSE $\blacktriangle$

- opens or closes the disc tray.

### ⑧ DSC

- selects different types of preset sound equalizer settings (FLAT, POPS, JAZZ, CLASSIC or ROCK).

### ⑨ SOURCE

- selects the respective sound source: DVD/AUX1/AUX2/FM/MW.
- switches the system on.

### ⑩ IR SENSOR

- point the remote control towards this sensor.

### ⑪ VOLUME +/-

- adjusts the volume upward/downward.
- adjusts the hours and minutes in clock/timer setting mode.
- switches the set timer ON or OFF.

# Functional Overview

English

## Remote control

- ① **⏻**
  - to switch the system on or to Eco power/normal standby mode.
- ② **⏮**
  - opens or closes the disc compartment
- ③ **Numeric Keypad (0-9)**
  - inputs a track/title/chapter number of the disc.
  - inputs the number of a preset radio station.

- ④ **PROG**
  - DVD/VCD/CD: enters the program menu.
  - MP3/WMA-CD: adds/deletes a programmed track to/from the program list.
  - Picture CD: during playback, to select a slide show mode.
  - Tuner: programs preset radio stations.
- ⑤ **GOTO/ST**
  - Disc: fast searches in a disc by entering a time, title, chapter or track.
  - FM: sets stereo or mono sound mode.
- ⑥ **SYSTEM (disc mode only)**
  - enters or exits the system menu.
- ⑦ **DISC MENU (disc mode only)**
  - DVD/VCD: enters or exits the disc contents menu.
  - VCD2.0: switches the playback control mode on or off.
  - MP3/WMA: switches between Album and Filelist.
- ⑧ **▼ / ▲ / ► / ◀**
  - selects an item in a menu.
  - moves an enlarged picture up/down/left/right.
- ⑨ **OK**
  - confirms a selection.
- ⑩ **ZOOM**
  - DVD/VCD/Picture CD: enlarges or reduces a picture or active image on the TV screen.
- ⑪ **MUTE**
  - disables or enables sound output.

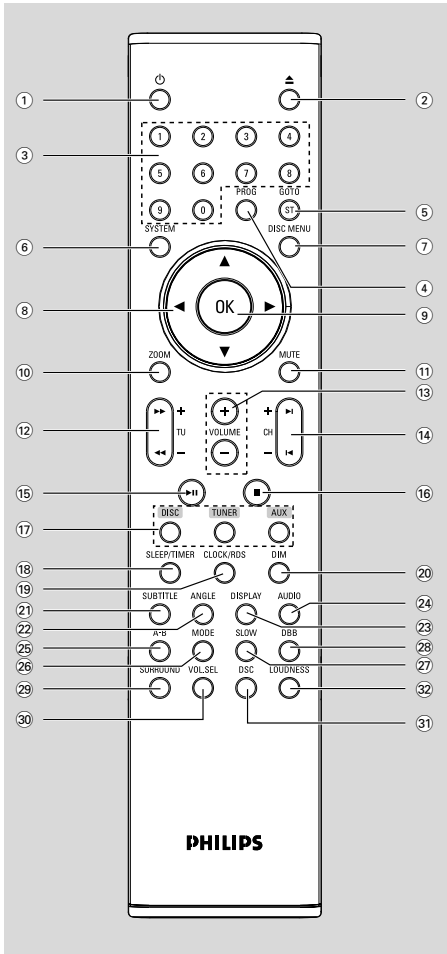



## 12 TU +/- (◀◀ / ▶▶)

### Tuner

- press to tune to a lower/higher radio frequency gradually.
- press and hold, then release the key to start automatic search for a radio frequency downward/upward.

### Disc

- searches backward/forward in a disc at different speeds.

## 13 VOLUME +/-

- adjusts the volume upward/downward.
- adjusts the hours and minutes in clock/timer setting mode.
- switches the set timer ON or OFF.

## 14 CH +/- (◀ / ▶)

- Disc: skips to the previous/next chapter/title/track
- Tuner: selects a preset radio station.

## 15 ▶ II

- starts or interrupts disc playback.

## 16 ■

- stops disc playback or erases a program.

## 17 DISC/TUNER/AUX

- selects the respective sound source for DVD/AUX1/AUX2/FM/MW.
- For tuner (TUNER): press to switch between MW and FM
- exits P-SCAN (progressive scan). (Only for DISC)

## 18 SLEEP/TIMER

### Standby mode

- sets time for switching on the system automatically.

### Power-on mode

- sets the sleep timer function (auto off).

## 19 CLOCK/RDS

### Standby mode

- sets the system clock.

### Playback mode

- displays the system clock.

## 20 DIM

- selects different levels of brightness for the display screen.

## 21 SUBTITLE

- selects a subtitle language.

## 22 ANGLE

- selects a DVD camera angle.

## 23 DISPLAY

- displays information on TV screen during playback

## 24 AUDIO

### for VCD/DivX

- sets Stereo, Mono-Left or Mono-Right sound mode.

### for DVD

- selects an audio language.

## 25 A-B

- repeats playback of a specific section on a disc.

## 26 MODE

- selects various repeat modes or the shuffle play mode for a disc.

## 27 SLOW

- selects different slow playback modes for a DivX/VCD/SVCD/DVD.

## 28 DBB

- enables or disables bass enhancement.

## 29 SURROUND (unavailable for this version)

- selects 2.1 channel output (2.1CH) or 5.1 channel output (SUR5.1 or DVD5.1).

## 30 VOL.SEL (unavailable for this version)

- adjusts volume level for individual speakers.

## 31 DSC

- selects different types of preset sound equalizer settings (FLAT, POPS, JAZZ, CLASSIC or ROCK).

## 32 LOUDNESS

- enables or disables automatic loudness adjustment.

# Getting Started

## Step 1: Inserting batteries into the Remote Control

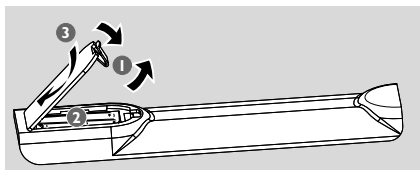

- 1 Open the battery compartment.
- 2 Insert two AAA batteries following the indications (+/-) inside the compartment.
- 3 Close the cover.

## Using the Remote Control to operate the Player

- 1 Aim the Remote Control directly at the remote sensor (IR) on the front panel.
- 2 Do not put any objects between the Remote Control and the DVD Player while operating the DVD Player.

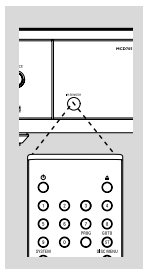

### CAUTION!

- Remove batteries if they are exhausted or if the Remote Control is not being used for a long time.
- Do not use old and new or different types of batteries in combination.
- Batteries contain chemical substances, so they should be disposed of properly.

## Step 2: Setting up the TV

### IMPORTANT!

Make sure you have completed all the necessary connections. (See “Connecting TV”).

- 1 Switch the DVD system on and then select DISC source. (See “Switching the system on/off”).
- 2 Turn on the TV and set to the correct video-in channel. You should see the blue Philips DVD background screen on the TV.

→ Usually these channels are between the lowest and highest channels and may be called FRONT, A/V IN, or VIDEO. See your TV manual for more details.

→ Or, you may go to channel 1 on your TV, then press the Channel down button repeatedly until you see the Video In channel.

→ Or, the TV Remote Control may have a button or switch that chooses different video modes.

→ Or, set the TV to channel 3 or 4 if you are using an RF modulator:

## Setting up Progressive Scan feature (for Progressive Scan TV only)

The progressive scan display twice the number of frames per seconds than interlaced scanning (ordinary normal TV system). With nearly double the number of lines, progressive scan offers higher picture resolution and quality.

### IMPORTANT!

**Before enabling the progressive scan feature, you must ensure:**

- 1) Your TV can accept progressive signals, a progressive scan TV is required.
- 2) You have connected the DVD player to your TV using Y Pb Pr (see “Connections-Step 5: Connecting TV- Using Component Video jacks”).

- 1 Turn on your TV.
- 2 Turn off your TV progressive scan mode or turn on interlaced mode (refer to your TV user manual).
- 3 Press **ECO POWER/STANDBY-ON** (⏻) on the remote) to turn on the DVD player.
- 4 Select the correct Video Input channel.  
→ The DVD background screen appears on the TV.
- 5 Press **SYSTEM**.

- 6 Press ◀ ▶ repeatedly to select **"VIDEO SETUP PAGE"**.
- 7 Select **"TV MODE"** to **"P-SCAN"**, then **OK** to confirm.  
→ The instruction menu appears on the TV.

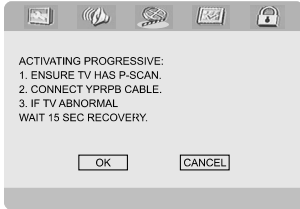

- 8 Press ◀ ▶ to highlight OK in the menu and press **OK** to confirm.  
**There will be a distorted picture on your TV at this state until you turn on the progressive scan mode on your TV.**
- 9 Turn on your TV progressive scan mode (refer to your TV user manual).  
→ The below menu appears on the TV.



- 10 Press ◀ ▶ to highlight OK in the menu and press **OK** to confirm.  
→ The setup is complete now and you can start enjoy the high quality picture.

## To deactivate Progressive manually

- **When the distorted sign still appears on the TV**, it may be due to the connected TV does not accept progressive signals, and progressive is set by mistake. You must reset the unit to interlace format.

- 1 Turn off your TV progressive scan mode or turn on to interlaced mode (refer to your TV user manual).
- 2 Press **SYSTEM** on the remote to exit the system menu and then **DISC** to exit progressive scan.  
→ The DVD blue background screen will appear on the TV.

### Note:

- During normal playback in the progressive scan mode, pressing **DISC** button will exit the progressive scan mode.

# Getting Started

## Step 3: Setting language preference

You can select your own preferred language settings. This DVD system will automatically switch to the selected language whenever you load a disc. If the language selected is not available on the disc, the disc's default language will be used instead. The OSD language in the system menu will remain once selected.

### Setting the OSD Language

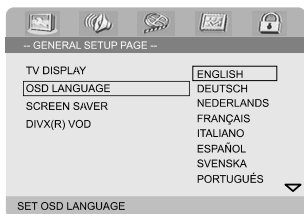

- 1 Press **SYSTEM**.
- 2 Press **◀ ▶** to select "**General Setup Page**".
- 3 Use **◀ ▶ ▲ ▼** on the remote to navigate in the menu.  
Move to "OSD Language" and press **▶**.
- 4 Select a language and press **OK**.

#### To exit from the menu

- Press **SYSTEM** again.

### Setting the Audio, Subtitle and Disc Menu language

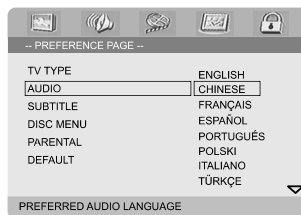

- 1 Press **SYSTEM** in stop mode.
- 2 Press **◀ ▶** to select "**Preference Page**".
- 3 Press **▲ ▼** to highlight the following in the Preference Page.
  - "Audio" (disc's soundtrack)
  - "Subtitle" (disc's subtitles)
  - "Disc Menu" (disc's menu)
- 4 Enter its submenu by pressing **▶**.
- 5 Select a language and press **OK**.
- 6 Repeat steps 3~5 for other language settings.

#### To exit from the menu

- Press **SYSTEM** again.

#### If you choose **OTHERS** in Audio, Subtitle or Disc Menu,

- 1 Press **▲ ▼** to highlight "Others".
- 2 Press **OK**.
- 3 When you are asked to enter a language code, input a language code by using the **Numeric Keypad (0-9)**.
- 4 Press **OK** to confirm.



## Switching the system on/off

- Press **ECO POWER/STANDBY-ON**  (⏻) on the remote).  
→ "HELL" is displayed briefly. The system will switch to the last selected source.
- Press **DISC, TUNER** or **AUX** on the remote.  
→ The system will switch to the selected source.

## To switch the system to standby mode

- Press **ECO POWER/STANDBY-ON**  (⏻) on the remote).  
→ "BYE BYE" is displayed briefly. The interactive sound settings, last selected source and tuner presets will be retained in the player's memory.

## Switching the system to Eco Power Standby mode

- Press **ECO POWER/STANDBY-ON**  (⏻) in the active mode.  
→ The system enters Eco power standby (the ECO POWER LED is on) or normal standby with clock display.
- The volume level (up to a maximum volume level of 12), interactive sound settings, last selected mode, source and tuner presets will be retained in the player's memory.
- If the system is normal standby with clock display, press and hold **ECO POWER/STANDBY-ON**  (⏻) for 3 seconds or more to switch to Eco power standby or vice versa.

## Power-saving automatic standby

As a power-saving feature, the system will automatically switch to Standby mode if you do not press any buttons within 15 minutes after a disc has stopped playing.

## Volume control

Turn **VOLUME (-/+)** clockwise or anticlockwise (or press **VOLUME +/-** on the remote) to increase or decrease the volume level.  
→ "VOL XX" is displayed on the display panel. "XX" denotes the volume level.

## To switch off the volume temporarily

- Press **MUTE** on the remote.  
→ Playback will continue without sound and "MUTING" flashes.
- To activate sound reproduction, you can:
  - press **MUTE** again;
  - adjust the volume controls;
  - change source.

## Sound control

**DBB, DSC and LOUDNESS sound features cannot be activated at the same time.**

### DBB (Dynamic Bass Boost)

DBB enhances the bass response.

- Press **DBB** on the remote to enable/disable DBB feature.  
→ Some discs might be recorded in high modulation, which causes a distortion at high volume. If this occurs, switch off DBB or reduce the volume.

### DSC (Digital Sound Control)

DSC provides a different type of preset sound equalizer setting.

- Press **DSC** on the system or remote control repeatedly to select: FLAT, POPS, JAZZ, CLASSIC or ROCK.

### LOUDNESS

LOUDNESS feature enables the system to automatically increase the treble and bass sound effect at low volume (the higher the volume, the lower the treble and bass increase).

- Press **LOUDNESS** on the remote to enable or disable LOUDNESS feature.  
→  icon appears/disappears after this feature is enabled/disabled.

## Dimming the display screen

- Press **DIM** repeatedly to select different levels of brightness for the display screen.

# Disc Operations

## IMPORTANT!

- Depending on the DVD or VIDEO CD, some operations may be different or restricted.
- Do not push on the disc tray or put any objects other than disc on the disc tray. Doing so may cause the disc player malfunction.
- If the inhibit icon (⊘) appears on the TV screen when a button is pressed, it means the function is not available on the current disc or at the current time.

## Playable Discs

Your DVD Player will play:

- Digital Video Discs (DVDs)
- Video CDs (VCDs)
- Super Video CDs (SVCDs)
- Digital Video Discs + Rewritable (DVD+RW)
- Compact Discs (CDs)
- Picture (Kodak, JPEG) files on CDR(W)
- DivX(R) disc on CD-R(W):
- DivX 3.11, 4.x and 5.x
- WMA
- Supported MP3-CD format.
- ISO 9660
- Max. title/album name –12 characters
- Max. title number plus album is 255.
- Max. nested directory is 8 levels.
- The max. album number is 32.
- The max. MP3 track number is 999.
- Supported sampling frequencies for MP3 disc: 32 kHz, 44.1 kHz, 48 kHz.
- Supported Bit-rates of MP3 disc are: 32, 64, 96, 128, 192, 256 (kbps).
- Following formats can't be supported
- The files like \*.VMA, \*.AAC, \*.DLF, \*.M3U, \*.PLS, \*.WAV
- Non-English Album/Title name
- The discs recorded under Joliet format
- MP3 Pro and MP3 with ID3 tag

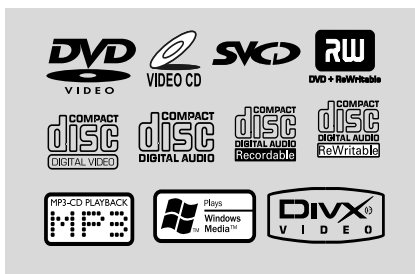

## Region Codes

DVDs must be labeled for ALL regions or Region 5 in order to play on this DVD system. You cannot play discs that are labeled for other regions.



Note:

- If you are having trouble playing a certain disc, remove the disc and try a different one. Improperly formatted disc will not play on this DVD Player.

## Playing discs

- 1 Connect the power cords of the system and TV (or any optional stereo or AV receiver) to a power outlet.
- 2 Turn on the TV power and set to the correct Video In channel. (See "**Setting up the TV**").
- 3 Press **ECO POWER/STANDBY-ON** on the DVD Player front panel or on the remote.  
→ You should see the blue Philips DVD background screen on the TV.
- 4 Press **OPEN•CLOSE** to open the disc tray and load in a disc, then press the same button again to close the disc tray.  
→ Make sure the label side is facing up.
- 5 Playback will start automatically (depending on the disc type).  
→ If a disc menu appears on the TV, see "**Using the Disc Menu**".  
→ If the disc is locked by parental control, you must enter your four-digit password. (See "**Password Setup Page**").
- 6 At any time, simply press **PRESET-/■** () on the remote) to stop playback.

## Using the Disc Menu

Depending on the disc, a menu may appear on the TV screen once you load the disc.

### To select a playback feature or item

- Use ◀ ▶ ▲ ▼ and **OK** or **Numeric Keypad (0-9)** on the remote.  
→ Playback will start automatically.

### To access or exit from the menu

- Press **DISC MENU** on the remote.

### For VCD with Playback Control (PBC) feature (version 2.0 only)

PBC playback allows you to play Video CDs interactively, following the menu on the display.

- During playback, press **DISC MENU**.  
→ If PBC was ON, it will switch to OFF and continue playback.  
→ If PBC was OFF, it will switch to ON and return to menu screen.

## Basic playback controls

### Pausing playback (DVD/VCD/CD/MP3/DivX/WMA)

- 1 During playback, press ▶II.  
→ Playback will pause and sound will be muted.
- 2 Press ▶II again to resume.

### Selecting a track/chapter/title (DVD/VCD/DivX/CD)

- 1 Press ▶ (CH + ▶) on the remote) during playback to go to the next chapter/track
- 2 Press ◀ (CH - ◀) on the remote) to go to the previous chapter/track.
- 3 To go directly to any chapter/track/title, enter the chapter/track/title number using the **Numeric Keypad (0-9)**.

### Resuming playback from the last stopped point (DVD/VCD/CD)

- In stop mode and when a disc has not been removed, press ▶II.

### To cancel resume mode

- In stop mode, press **PRESET-■** (■ on the remote) again.

### Zoom (DVD/VCD/DivX/JPEG)

Zooming allows you to enlarge or reduce the video image during playback.

- 1 Press **ZOOM** repeatedly to enlarge or reduce the playback video image.
- 2 Press ◀ ▶ ▲ ▼ to pan across the TV screen.

### Repeat (DVD/VCD/CD/MP3/DivX/WMA)

#### For DVD/VCD/CD

- Press **MODE** repeatedly to choose a repeat mode during playback.

#### CHAPTER (DVD)

– to repeat playback of the current chapter:

#### TRACK (CD/VCD)/TITLE (DVD)

– to repeat playback of the current track (CD/SVCD/VCD)/title (DVD).

#### ALL

– to repeat playback of all the disc.

#### SHUFFLE

– to repeat playback at random order.

#### For MP3/WMA/DivX

- Press **MODE** continuously to access different repeat modes.  
→ **Shuffle**: play all files in the selected folder in random order.  
→ **Repeat One**: play an MP3/WMA file repeatedly.  
→ **Repeat All**: play all files repeatedly.  
→ **Off**: switches off the shuffle or repeat mode.

# Disc Operations

## Repeat A-B (DVD/VCD/CD/MP3/DivX/WMA)

- 1 Press **A-B** at your chosen starting point.
- 2 Press **A-B** again at your chosen end point.  
→ The section A and B can be set only within the same chapter/track.  
→ The section will now repeat continuously.
- 3 To exit the sequence, press **A-B** again.

## Slow Motion (DVD/VCD)

- 1 Press **SLOW** during playback to select the required speed: 1/2, 1/4, 1/8 or 1/16 (backward or forward).  
→ Sound will be muted.
- 2 To return to normal speed, press **▶II**.

### Note:

– *Slow backward is not possible on VCDs.*

## Program (not for Picture CD)

To select favourite tracks/chapters for playback in preferred sequence.

### For DVD/VCD/CD

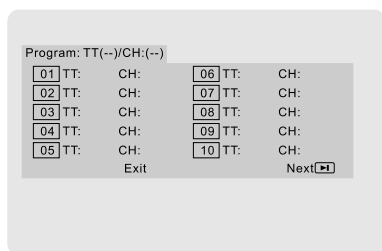

(DVD program for example)

- 1 Press **PROG** on the remote to enter the program mode.
- 2 Use the **Numerical Keypad (0-9)** to directly input the tracks or chapters (single track number with digit "0" in front, for example "05").
- 3 Move the cursor by pressing **◀▶▲▼** to select **START**.
- 4 Press **OK** to start playback.

### For MP3/WMA

- 1 In Stop mode, press **DISC MENU** to switch the menu between Album and Filelist.
- 2 When Filelist is on the screen, press **▲▼** to select the files and press **PROG** to add the files to the program list.
- 3 Press **DISC MENU** to display the program list.
- 4 Press **PROG** to delete unwanted files from the program list.

## Forward/Reverse Searching (DVD/VCD/DivX/CD/MP3/WMA)

- 1 Press **TU +/- (◀▶)** during playback to select the required speed: 2X, 4X, 8X, 16X or 32X (backward or forward).  
→ Sound will be muted.
- 2 To return to normal speed, press **▶II**.

## Time search & search by chapter/track number (DVD/VCD/CD/MP3/WMA)

- 1 Press **GOTO/ST** until the time or chapter/track edit box appears.
- 2 Enter hours, minutes and seconds from left to right in the time edit box using remote control numerical keypad.

### OR

Enter your desired chapter/track number in the chapter/track edit box using remote control numerical keypad.

## Information display during playback (not for Picture CD)

- 1 During playback, press **DISPLAY** to show disc information on the TV screen.

### For DVD

- **Title/Chapter Elapsed**: displays the elapsed time of the current title/chapter.
- **Title/Chapter Remain**: displays the remaining time of the current title/chapter.
- **Display Off**: switches time display off.



## For Super VCD/VCD/DivX/CD

- **Single/Total Elapsed**: displays the elapsed time of the current single/total track.
- **Single/Total Remain**: displays the remaining time of the current single/total track.
- **Display Off**: switches time display off.

## Special disc features

### Playing a Title (DVD)

- 1 Press **DISC MENU**.  
→ The disc title menu appears on the TV screen.
- 2 Use **◀▶▲▼** or **Numeric Keypad (0-9)** to select a play option.
- 3 Press **OK** to confirm.

### Camera Angle (DVD)

- Press **ANGLE** repeatedly to select different desired angle.

### Changing the Audio Language (for DVD recorded with multiple languages)

- Press **AUDIO** repeatedly to select different audio languages.

### Changing the Audio Channel (for VCD only)

- Press **AUDIO** to select the available audio channels provided by the disc (Mono Left, Mono Right or Stereo).

### Subtitles (DVD)

- Press **SUBTITLE** repeatedly to select different subtitle languages.

## Playing MP3/WMA/JPEG Picture CD

### IMPORTANT!

**You have to turn on your TV and set to the correct Video In channel. (See "Setting up the TV").**

## Playing MP3/WMA disc

### IMPORTANT!

**For DRM protected WMA files, use Windows Media Player 10 (or later) for CD burning/conversion. Visit [www.microsoft.com](http://www.microsoft.com) for details about Windows Media Player and WM DRM (Windows Media Digital Rights Management).**

### General operation

- 1 Load an MP3/WMA disc.  
→ The data disc menu appears on the TV screen.
- 2 Use **▲ ▼** to select an album and press **OK** to open the album.

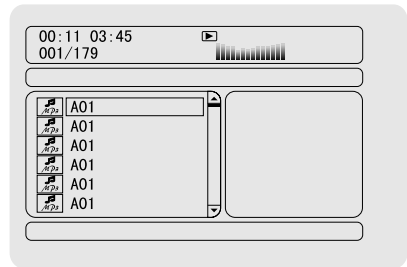

- 3 Press **▲ ▼** or use the **Numeric Keypad (0-9)** to highlight a track.
- 4 Press **OK** to confirm.  
→ The playback will start from the selected track to the end of the album.

### Note:

- The disc reading time may exceed 10 seconds due to large number of songs compiled onto the disc.

### Playback selection

During playback, you can:

- Press **◀ / ▶ (CH +/- ◀ / ▶)** on the remote to select another track in the current album.
- Press **▶||** repeatedly to pause/resume playback.
- Press **DISC MENU** on the remote to switch between Album and Filelist.

# Disc Operations

## Playing JPEG Picture CD

### General operation

- 1 Load a JPEG Picture CD.  
→ The data disc menu appears on the TV screen.
- 2 Use ▲▼ to select a folder and press **OK** to open the folder.
- 3 Press ▲▼ or use the **Numeric Keypad (0-9)** to highlight a picture file.
- 4 Press **OK** to confirm.  
→ The playback will start from the selected picture to the end of the folder.

### Playback selection

During playback, you can:

- Press **◀ / ▶** (**CH +/- ◀ / ▶**) on the remote to select another file in the current folder.
- Use **◀ ▶ ▲ ▼** on the remote to rotate/flip the picture files.
- Press **▶||** repeatedly to pause/resume playback.
- Press **DISC MENU** on the remote to switch between Folder and Filelist.

## Special JPEG features

### Preview function (JPEG)

This function shows the content of the current folder or the whole disc.

- 1 Press **PRESET-/■** (■ on the remote) during playback.  
→ Thumbnails of 12 pictures appears on the TV screen.

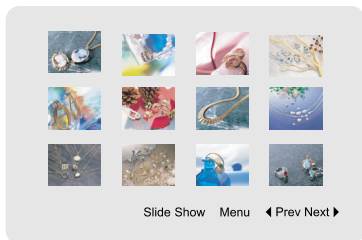

- 2 Use **◀ ▶ ▲ ▼** to highlight one of the pictures/ "Slide Show" and press **OK** to start playback/ slide show.

### To enter the remote key function menu

- Use **◀ ▶ ▲ ▼** to highlight "Menu" and press **OK**.

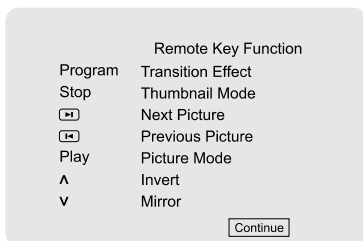

### To display the other pictures on the previous/next page

- Press **◀ / ▶** (**CH +/- ◀ / ▶**) on the remote).
- Use **◀ ▶ ▲ ▼** to highlight "Prev" or "Next" and press **OK**.

### Zoom picture (JPEG)

- During playback, press **ZOOM** repeatedly to display the picture with different scales.
- Use **◀ ▶ ▲ ▼** to view the zoomed picture.

### Slide show playback modes (JPEG)

- During playback, press **PROG** on the remote repeatedly to select different slide-show playback modes:

Mode 0: None  
Mode 1: Wipe Top  
Mode 2: Wipe Bottom  
Mode 3: Wipe Left  
Mode 4: Wipe Right  
Mode 5: Diagonal Wipe Left Top  
Mode 6: Diagonal Wipe Right Top  
Mode 7: Diagonal Wipe Left Bottom  
Mode 8: Diagonal Wipe Right Bottom  
Mode 9: Extend From Center H  
Mode 10: Extend From Center V  
Mode 11: Compress To Center H  
Mode 12: Compress To Center V  
Mode 13: Window H  
Mode 14: Window V  
Mode 15: Wipe From Edge To Center  
Mode 16: Move In From Top

## Playback with multi-angles (JPEG)

- During playback, press ◀ ▶ ▲ ▼ to rotate the picture on the TV screen.
  - ▲: flip the picture vertically.
  - ▼: flip the picture horizontally.
  - ◀: rotate the picture anti-clockwise.
  - ▶: rotate the picture clockwise.

## Playing a DivX disc

This DVD player supports the DivX movie playback that you download from your computer onto a CD-R/RW (see "System Menu Options-DIVX(R) VOD registration code" for more information).

- 1 Load a DivX disc.
    - Playback will start automatically. If not press ▶||
  - 2 If the DivX movie contains external subtitles, the subtitle menu will appear on the TV screen for your selection.
- In this case, pressing **SUBTITLE** on the remote control will turn on or off the subtitle.
  - If multilingual subtitles are embedded on the DivX disc, pressing **SUBTITLE** will change the subtitle language during playback.

### Note:

- *Subtitle files with the following filename extensions (.srt, .smi, .sub, .ssa, .ass) are supported but do not appear on the file navigation menu.*
- *The subtitle filename have to be the same as the filename of the movie.*

# System Menu Options

## Basic operations

- 1 Press **SYSTEM** to enter the Setup Menu.
- 2 Press ◀ ▶ to select a page to be set.
- 3 Press ▲ ▼ to highlight an option.
- 4 Enter its submenu by pressing ▶ or **OK**.
- 5 Move the cursor by pressing ▲ ▼ to highlight the selected item.  
→ In cases of value setting, press ◀ ▶ to adjust values.
- 6 Press **OK** to confirm.

### To return to the upper-level menu

- Press ◀ or **OK** (in cases of value adjustment).

### To exit from the menu

- Press **SYSTEM** again.  
→ The settings will be stored in the player's memory even if the player is switched off.

#### Note:

- Some of the features in the System Menu Options are described in "Getting Started".

## General Setup Page

The options included in General Setup page are: "TV Display", "OSD Language", "Screen Saver" and "DIVX(R) VOD".

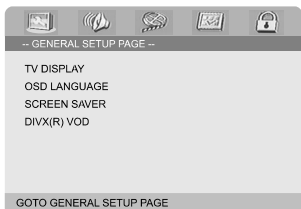

## TV Display

Set the aspect ratio of the DVD Player according to the TV you have connected.

→ **4:3 PANSKAN**: If you have a normal TV and want both sides of the picture to be trimmed or formatted to fit your TV screen.



→ **4:3 LETTER BOX**: If you have a normal TV. In this case, a wide picture with black bands on the upper and lower portions of the TV screen will be displayed.



→ **16:9**: If you have a wide-screen TV.



## OSD Language

See "Getting Started-Step 3: Setting language preference".

## Screen Saver

This function is used to turn the screen saver on or off.

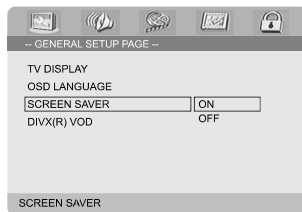

→ **On**: In STOP, PAUSE or No DISC mode, if no actions are performed about 3 minutes, the screen saver will be activated.

→ **Off**: Screen saver is disabled.

## DIVX(R) VOD registration code

Philips provides you the DivX® VOD (Video On Demand) registration code that allows you to rent and purchase videos using the DivX® VOD service.

For more information, visit us at [www.divx.com/vod](http://www.divx.com/vod).

- In 'General Setup Page', press ▲ ▼ to highlight DIVX(R) VOD, then press ► or **OK** to enter its submenu and press **OK** again to confirm.

→ The registration code will appear.



- Press **OK** to exit.
- Use the registration code to purchase or rent the videos from DivX® VOD service at [www.divx.com/vod](http://www.divx.com/vod). Follow the instructions and download the video onto a CD-R for playback on this DVD player.

### Notes:

- All the downloaded videos from DivX® VOD can only be played back on this DVD player.
- Time search feature is not available during DivX movie playback.

## Audio Setup Page

The options included in Audio Setup page are: "Digital Audio Setup", "Dolby Digital Setup", "3D Processing", "HDCD" and "Night Mode".

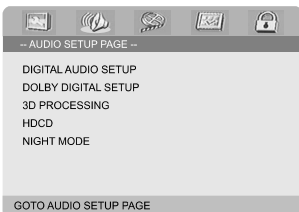

## Digital Audio Setup

The options included in Digital Audio Setup are: "SPDIF Off", "All" and "PCM only".

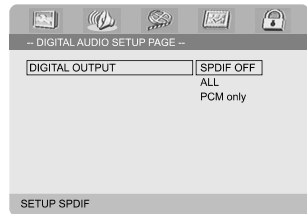

- **SPDIF Off:** Turns off the SPDIF output.
- **All:** If you have connected your DIGITAL OUT (COAXIAL or OPTICAL) to a multi-channel decoder/receiver.
- **PCM only:** Only if your receiver is not capable of decoding multi-channel audio.

## Dolby Digital Setup

The option included in Dolby Digital Setup is: "Dual Mono".

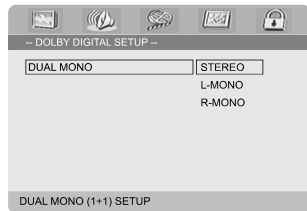

### Dual Mono

Select the setting that matches the number of speakers you have connected.

- **Stereo:** Left mono sound will send output signals to Left speaker and Right mono sound will send output signals to Right speaker.
- **L-Mono:** Left mono sound will send output signals to Left speaker and Right speaker.
- **R-Mono:** Right mono sound will send output signals to Left speaker and Right speaker.

# System Menu Options

## 3D Processing

The option included in 3D Processing is: "Reverb Mode".

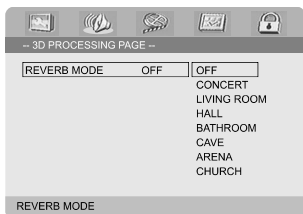

### Reverb Mode

Reverb mode provides a virtual surround sound experience using just two speakers.

→ **Off, Concert, Living Room, Hall, Bathroom, Cave, Arena and Church.**

## HDCD

The option included in HDCD (High Definition Compatible Digital) is: "Filter".

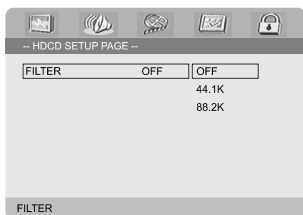

### Filter

Sets the audio output cutoff frequency point when playing an HDCD disc.

→ **Off, 44.1K and 88.2K.**

## Night Mode

In this mode, the high volume outputs are softened and low volume outputs are brought upward to an audible level. It is useful for watching your favourite action movie without disturbing others at night.

→ **On:** Select this to level out the volume. This feature is only available for movies with Dolby Digital mode.

→ **Off:** Select this when you want to enjoy the surround sound with its full dynamic range.

## Video Setup Page

The options included in Video Setup page are: "Video Output", "TV Mode" and "Color Setting".

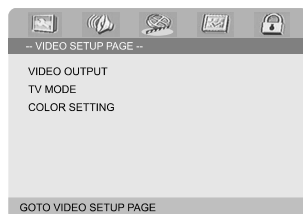

### Video Output

Sets the video output according to your video connection. This setting is not required if you are using the **VIDEO OUTPUT** jack (yellow) to connect the DVD micro system to your TV.

→ **Pr/Cr Pb/Cb Y:** Select this if you have connected the DVD micro system to your TV using Component video jacks.

→ **S-Video:** Select this if you have connected the DVD micro system to your TV using S-Video jack.

→ **RGB:** Select this for Scart connection.

#### Note:

– *When the player is set to Y Pb Pr (YUV), some TV may not properly synchronise with player on the SCART connector.*

## TV Mode

Selects interlace or P-SCAN video output mode when **Pr/Cr Pb/Cb Y** is selected.

→ **P-SCAN** and **Interlace**.

In the progressive scan mode, you can enjoy the high quality picture with less flickers. It only works when you have connected the DVD player's Y Pb Pr jacks to your TV that supports the progressive video input. Otherwise, a distorted picture will appear on the TV. For proper progressive scan set up, see page 18-19.

## Color Setting

This menu helps you to set the video quality.

- 1 Press **▲▼** to highlight "Color Setting".
- 2 Press **▶** or **OK** to enter Color Setting Setup.

The options included in Color Setting Setup page are: "Sharpness", "Brightness", "Contrast", "Gamma", "Hue", "Saturation" and "Luma Delay".

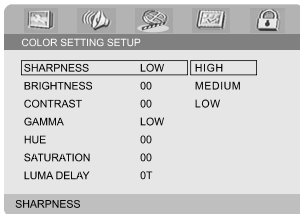

### Sharpness

Adjusts the sharpness level.

→ **High, Medium** and **Low**.

### Brightness

Adjusts the brightness level. Range: -20-+20.

### Contrast

Adjusts the contrast level. Range: -16-+16.

### Gamma

Adjusts the gamma level.

→ **High, Medium, Low** and **None**.

### Hue

Adjusts the hue level. Range: -9-+9.

### Saturation

Adjusts the saturation level. Range: -9-+9.

### Luma Delay

Adjusts the luma delay.

→ **0T** and **1T**.

## Preference Page

The options included in Preference page are: "TV Type", "Audio", "Subtitle", "Disc Menu", "Parental" and "Default".

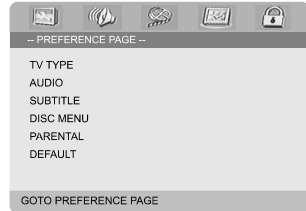

### Note:

– Preference features can be selected only during "No Disc" condition or full STOP mode.

## Parental

Some DVDs may have a parental level assigned to the complete disc or to certain scenes on the disc. This feature lets you set a playback limitation level.

The rating levels are from 1 to 8 and are country dependent. You can prohibit the playing of certain discs that are not suitable for your children or have certain discs played with alternative scenes.

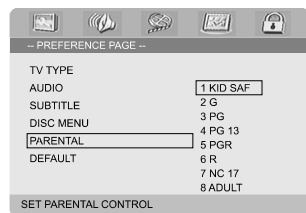

- VCD, SVCD and CD have no level indication, so parental control function has no effect on those kinds of discs. This applies to most illegal DVD discs.

- 1 Press **▲▼** to highlight "Parental".
- 2 Enter its submenu by pressing **▶**.
- 3 Use **▲▼** to highlight a rating level for the disc inserted.

# System Menu Options

→ DVDs that are rated above the level you selected will not play unless you enter your four-digit password and choose a higher level rating.

## Note:

– Some DVDs are not encoded with a rating though the movie rating may be printed on the Disc cover. The rating level feature does not work for such Discs.

## Rating explanations

### 1 KID SAF

– Kids material; recommended especially for children and viewers of all ages.

### 2 G

– General Audience; recommended as acceptable for viewers of all ages.

### 3 PG

– Parental Guidance suggested.

### 4 PG 13

– Material is unsuitable for children under age 13.

### 5-6 PGR, R

– Parental Guidance - Restricted; recommended that parents restrict children under 17 from viewing or allow to view only when supervised by a parent or adult guardian.

### 7 NC-17

– No children under age 17; not recommended viewing for children under age 17.

### 8 Adult

– Mature materials; should be viewed only by adults due to graphic sexual material, violence or language.

## Default

Setting the "Default" function will reset all options and your personal settings to the factory defaults and all your personal settings will be erased.

## Caution!

– **When this function is activated, all settings will be reset to factory defaults.**

## Password Setup Page

The options included in Password Setup page are: "Password Mode" and "Password".

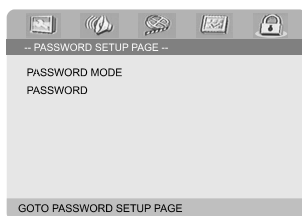

## Password Mode

This feature is used to enable/disable password by selecting "ON"/"OFF".

## Password

Enter your four digit password when a hint is displayed on the screen. The default password is 1234.

- 1 Press ▲▼ to highlight "Password".
- 2 Enter its submenu by pressing ►.
- 3 Press **OK** to open the page for inputting a new password.



- 4 Enter the existing 4-digit code.
- 5 Enter the new 4-digit code.
- 6 Enter the new 4-digit code a second time to confirm.  
→ The new 4-digit code will take effect.
- 7 Press **OK** to exit.

## Notes:

- If the password has been changed, the parental and disc lock code will also be changed.
- The default password (1234) is always active even the password has been changed.



## Radio Reception

### Tuning to radio stations

- 1 Press **ECO POWER/STANDBY-ON**  (on the remote) to switch on the last selected source.
- 2 Press **SOURCE (TUNER)** on the remote) to select TUNER mode.
- 3 Press **TUNER** on the remote again to select the desired band: FM or MW.
- 4 Press and hold **◀ / ▶ (CH +/- ◀ / ▶)** on the remote) until the frequency indication starts to change, then release.  
→ The system automatically tunes to the next strong radio station.
- To tune to a weak station, press **◀ / ▶ (CH +/- ◀◀ / ▶▶)** on the remote) briefly and repeatedly until an optimal reception is found.
- 5 Repeat Step 4 if necessary until you find the desired radio station.

### Presetting radio stations

You can preset up to 40 stations (20 in each band) regardless of the reception.

#### Automatic programming

- Press **PROG** on the remote for more than two seconds to activate programming.  
→ All available stations are programmed.

#### Manual programming

- 1 Tune to your desired radio station (refer to "Tuning to radio stations").
- 2 Press **PROG** on the remote.  
→ "PROG" icon flashes.
- 3 Press **PRESET+** or **PRESET-/■** (or **CH +/- (◀ / ▶)**) on the remote) to select the desired preset number.  
→ If "PROG" icon goes off before you select the desired preset number, press **PROG** on the remote.
- 4 Press **PROG** on the remote again to store the radio station.
- Repeat steps 1-4 to store other radio stations.

### Listening to preset radio stations

- In tuner mode, press **PRESET+** or **PRESET-/■** (or **CH +/- (◀ / ▶)** on the remote) to select the desired preset number.  
→ The preset number, radio frequency, and waveband are displayed.

## RDS

**Radio Data System** is a service that allows FM stations to show additional information. If you are receiving a RDS station, **RDS** and the station name are displayed.

### Scrolling through different RDS information

- Press **CLOCK/RDS** briefly and repeatedly to scroll through the following information (if available):
  - Station name
  - RDS clock
  - Programme type such as *NEWS, SPORT, POP M ...*
  - Frequency

### Setting the RDS clock

Some RDS radio station may be transmitting a real clock time at an interval of every minute. It is possible to set the clock by using a time signal which is broadcast together with the RDS signal.

- 1 Tune to a RDS station from FM band (refer to "Tuning to radio stations").
- 2 Press **CLOCK/RDS**.  
→ "RDS 00:00" appears.  
→ If the RDS station does not transmit RDS time, "RDS CLOCK" appears.

#### Note:

- Some RDS radio station may be transmitting a real time clock at a minute interval. The accuracy of the transmitted time depends on the transmitting RDS radio station.

# Other Functions

## Setting the clock

- 1 In Standby mode, press and hold **CLOCK/RDS** on the remote until the time flashes on the display.  
→ "CLOCK SET" is displayed briefly. Then, the hour digits flash on the display screen.
- 2 Turn **VOLUME +/-** clockwise or anticlockwise or press **VOLUME +/-** on the remote to set the hours.
- 3 Press **CLOCK/RDS** to confirm.  
→ The minute digits flash on the display screen.
- 4 Turn **VOLUME +/-** clockwise or anticlockwise or press **VOLUME +/-** on the remote to set the minutes.
- 5 Press **CLOCK/RDS** again to confirm the clock setting.

### Notes:

- This system only supports 24-hour mode.
- The clock setting will be erased when the system is disconnected from the power supply.
- The system will exit clock setting mode if no button is pressed within 30 seconds.

## Setting sleep/wake-up timer

### Sleep timer setting

In power-on mode, the sleep setting enables the system to switch to standby mode automatically at a preset time.

- 1 In power-on mode, press **SLEEP/TIMER** on the remote repeatedly to select a preset time.  
→ The selections are as follows (time in minutes):  
00 → 10 → 20 → 30 → 40 → 50 → 60 → 70 → 80 → 90 → 00
- 2 When you reach the desired length of time, stop pressing **SLEEP/TIMER**.  
→ "SLEEP" appears.

### To deactivate the sleep timer

- Press **SLEEP/TIMER** repeatedly until "00" is displayed, or press **ECO POWER/STANDBY-ON** (⏻) (⏻ on the remote).

In standby mode, the timer setting enables the system to switch on automatically at a set time.

### Wake-up timer setting

#### IMPORTANT!

– Before setting the timer, ensure that the clock is set correctly.

- 1 Press and hold **SLEEP/TIMER** until the time flashes on the display.  
→ "TIME SET" scrolls. Then, the hour digits flash on the display screen.
- 2 Turn **VOLUME +/-** clockwise or anticlockwise or press **VOLUME +/-** on the remote to set the hours.
- 3 Press **SLEEP/TIMER** to confirm.  
→ The minute digits flash on the display screen.
- 4 Turn **VOLUME +/-** clockwise or anticlockwise or press **VOLUME +/-** on the remote to set the minutes.
- 5 Press **SLEEP/TIMER** to confirm the time setting.  
→ "OFF" flashes on the display screen.
- 6 Turn **VOLUME +/-** clockwise or anticlockwise or press **VOLUME +/-** on the remote to select "ON".  
→ ⏻ icon appears on the display screen.

### To deactivate the timer

- Select "OFF" at Step 6.

## SYSTEM

Power supply .....	220 – 240 V / 50 Hz
Rated working power consumption (1/8 rated output power) .....	≤ 55W
AUX input sensitivity .....	≤ 350mV
Channel Separation .....	≥ 40dB
Distortion .....	0.7%
Eco power Standby .....	< 1W

## DVD

Frequency response .....	100Hz-20kHz (±1dB)
Video output .....	1 V <sub>P,P</sub>
Horizontal definition .....	500 (TV)
Dimensions .....	232 (W) × 75.5 (H) × 223.5 (D) mm
Weight .....	1.85 kg

## AMPLIFIER

Rated output power (THD = 10%) .....	1×50W(4Ω)
Frequency response .....	100Hz-20kHz (±1dB)
S/N Ratio .....	≥ 60dB
Loaded impedance .....	4 Ω
Dimensions .....	232 (W) × 75.5 (H) × 223.5 (D) mm
Weight .....	3.3 kg

## TUNER

FM Frequency range .....	87.5-108 MHz
FM Noise limit sensitivity .....	≤ 20μV/M
FM S/N .....	≥ 46dB
MW Frequency range .....	531-1602 kHz
MW Noise limit sensitivity .....	≤ 3.0μV/m
MW S/N .....	≥ 40dB

## SPEAKERS

Impedance .....	4 Ω
Sensitivity .....	80 ± 4dB
Frequency response .....	80Hz-16kHz
Dimensions .	160 (W) × 270 (H) × 225 (D) mm
Weight .....	3.1 kg/each

## REMOTE

Distance .....	6m
Angle .....	± 30°



**Specifications subject to change without prior notice**

# Troubleshooting

## WARNING

Under no circumstances should you try to repair the system yourself, as this will invalidate the warranty. Do not open the system as there is a risk of electric shock.

If a fault occurs, first check the points listed below before taking the system for repair. If you are unable to remedy a problem by following these hints, consult your dealer or Philips for help.

Problem	Solution
No power.	<ul style="list-style-type: none"><li>✓ Check if the AC power cord is properly connected.</li><li>✓ Press <b>ECO POWER/STANDBY-ON</b>  on the top of the DVD micro system or  on the remote to turn on the power.</li></ul>
No picture.	<ul style="list-style-type: none"><li>✓ Check if the TV is switched on.</li><li>✓ Check the video connection.</li><li>✓ Press SOURCE on the top of the DVD player repeatedly to select "DVD" or press DISC on the remote.</li><li>✓ Set your TV to the correct Video In channel. This channel is usually near channel 00. Or, you may have a button on the TV remote control that selects Auxiliary or A/V IN channel. See your TV owner's manual for details. Or, change channels at the TV until you see DVD screen on the TV.</li><li>✓ If the progressive scan feature is activated but the connected TV does not support progressive signals or the cables are not connected accordingly, see page 18-19 for proper progressive scan setup or deactivate the progressive scan feature as below:<ol style="list-style-type: none"><li>1) Turn off your TV progressive scan mode or turn on to interlaced mode.</li><li>2) Press SYSTEM on the remote to exit the system menu and then DISC to exit progressive scan.</li></ol></li></ul>
Distorted or poor picture.	<ul style="list-style-type: none"><li>✓ Sometimes a small amount of picture distortion may appear. This is not a malfunction.</li><li>✓ Clean the disc.</li></ul>
Completely distorted picture or black/white picture.	<ul style="list-style-type: none"><li>✓ TV has a colour system standard. If the disc's or DVD system's colour system is different than your TV's colour system, the picture may be distorted or colourless.</li></ul>

**The aspect ratio of the screen cannot be changed even though you have set the TV shape.**

**No sound or distorted sound.**

**The micro DVD player does not start playback.**

**The DVD micro system does not respond when the buttons are pressed.**

**Cannot activate some features, such as Angles, Subtitles, or multi-language Audio.**

**Considerable noise in radio broadcasts.**

- ✓ The aspect ratio is fixed on the DVD disc.
- ✓ Depending on the TV, it may not be possible to change the aspect ratio.
- ✓ Adjust the volume.
- ✓ Check that the speakers are connected correctly.
- ✓ Replace the speaker cables.
- ✓ Disconnect the headphones.
- ✓ The system is in pause, slow motion or fast forward/reverse mode, press **PRESET/ ▶ II** (or **▶ II** on the remote) to resume normal play mode.
- ✓ Insert a readable disc with the playback side facing down.
- ✓ Check the disc type, colour system and regional code. Check for any scratches or smudges on the disc.
- ✓ Press SYSTEM MENU to turn off the setup menu screen.
- ✓ Cancel the parental control rating function or change the rating level.
- ✓ Moisture has condensed inside the system. Remove the disc and leave the system turned on for about an hour.
- ✓ Disconnect the power plug from the outlet and insert again.
- ✓ Multi-language sound or subtitle is not recorded on the DVD.
- ✓ Changing the language for the sound or subtitle is prohibited on the DVD.
- ✓ The features may not be available on the disc.
- ✓ Tune in to the correct frequency.
- ✓ Connect the antennas.
- ✓ Fully extend the FM wire antenna. Position for best reception and secure to a wall.
- ✓ Connect an outdoor FM or AM antenna.
- ✓ Adjust the direction and position for best reception.
- ✓ Place the antenna farther away from any equipment that may be causing the noise.
- ✓ Increase the distance between the system and your TV or other equipment.

# Troubleshooting

## The remote control does not function.

## The display is dark.

## Low hum or buzz sound.

## Low bass response.

## Unable to select Progressive Scan

## No sound and picture

- ✓ Select the correct source (DISC or TUNER, for example) before pressing the function button.
- ✓ Point the remote control at the remote sensor of the unit.
- ✓ Reduce the distance to the player.
- ✓ Remove any possible obstacles.
- ✓ Replace the batteries with new ones.
- ✓ Check that the batteries are loaded correctly.
  
- ✓ Press DIM again.
  
- ✓ Place the DVD micro system as far away as possible from electrical devices that may be causing interference.
  
- ✓ Check all speakers for correct polarity.
  
- ✓ Check that the output of the video signal is switched to 'Ypbpr'.
  
- ✓ Check that the RGB/SCART cable is connected to the correct device (See Connecting TV).

**Analog:** Sound that has not been turned into numbers. Analog sound varies, while digital sound has specific numerical values. These jacks send audio through two channels, the left and right.

**Aspect ratio:** The ratio of vertical and horizontal sizes of a displayed image. The horizontal vs. vertical ratio of conventional TVs is 4:3, and that of wide-screens is 16:9.

**AUDIO OUT Jacks:** Jacks on the back of the DVD System that send audio to another system (TV set, Stereo, etc.).

**Bit Rate:** The amount of data used to hold a given length of music; measured in kilobits per second, or kbps. Or, the speed at which you record. Generally, the higher the bit rate the better the sound quality. However, higher bit rates use more space on a Disc.

**Chapter:** Sections of a picture or a music piece on a DVD that are smaller than titles. A title is composed of several chapters. Each chapter is assigned a chapter number enabling you to locate the chapter you want.

**Component Video Out Jacks:** Jacks on the back of the DVD System that send high-quality video to a TV set that has Component Video In jacks (R/G/B, Y/Pb/Pr, etc.).

**Disc menu:** A screen display prepared for the selection of images, sound, subtitles, multi-angles, etc recorded on a DVD.

**Digital:** Sound that has been converted into numerical values. Digital sound is available when you use the DIGITAL AUDIO OUT COAXIAL or OPTICAL jacks. These jacks send audio through multiple channels, instead of just two channels as analog does.

**Dolby Digital:** A surround sound system developed by Dolby Laboratories containing up to six channels of digital audio (front left and right, surround left and right and center).

**DTS:** Digital Theater Systems. This is a surround sound system, but different from Dolby Digital. The formats were developed by different companies.

**JPEG:** A still-picture data compression system proposed by the Joint Photographic Expert Group, which features small decrease in image quality in spite of its high compression ratio.

**MP3:** A file format with a sound data compression system; "MPE" is the abbreviation of Motion Picture Experts Group 1 (or MPEG-1) Audio Layer 3. Through the MP3 format, one CD-R or CD-RW can contain about 10 times as much data volume as a regular CD can.

**Multichannel:** DVD is specified to have all sound tracks constitute one sound field. Multichannel refers to a structure of sound tracks having three or more channels.

**Parental control:** A function of the DVD to limit playback of the disc by the age of the users according to the limitation level in each country. The limitation varies from disc to disc; when it is activated, playback will be prohibited if the software's level is higher than the user-set level.

**PCM (Pulse Code Modulation):** A system for converting analog sound signal to digital signal for later processing without data compression.

**Playback control (PBC):** Refers to the signal recorded on video CDs or SVCDs for reproduction control. By using screen menus recorded on a Video CD or SVCD that supports PBC, you can enjoy interactive-type software as well as software having a search function.

**Progressive Scan (P-Scan):** It displays all the horizontal lines of a picture at one time, as a signal frame. This system can convert interlaced video from DVD into progressive format for connection to a progressive display. It dramatically increases the vertical resolution. A progressive scan TV set is needed to receive progressive scan output from the system.

**Region code:** A system allowing discs to be played only in preset regions. This unit will only play discs that have compatible region codes. You can find the region code of your unit from the product label. Some discs are compatible with more than one region (or ALL regions).

**S-Video:** Produces a clear picture by sending separate signals for luminance and the color. You can use S-Video only if your TV set has S-Video In jack.

**Sampling Frequency:** Frequency of data sampling when analog data is converted to digital data. Sampling frequency numerically represents how many times the original analog signal is sampled per second.

**Surround:** A system for users to create realistic three-dimensional sound fields full of realism by arranging multiple speakers around the listener.

**Title:** The longest section of a picture or music feature on DVD, music, etc., in video software, or the entire album in audio software. Each title is assigned a title number enabling you to locate the title you want.

**VIDEO OUT jack:** Jack on the back of the DVD System that sends video to TV.