

PHILIPS

Soundbar

5000 Series

TAB5308



User manual

Register your product and get support at
www.philips.com/support

Contents

1 Important	2
Help and support	2
Important safety instructions	2
Care for your product	3
Care of the environment	3
Compliance	4
What's in the box	4

2 Your soundbar	4
Main unit	4
Remote control	5
Connectors	6

3 Connect	6
Placement	6
Connect the soundbar and subwoofer	7
Pair the subwoofer manually	7
Connect audio from TV and other devices	8

4 Use your soundbar	9
Power on/off	9
Volume control	9
Source selection	9
EQ setting	9
AUX audio source	9
Optical audio source	9
HDMI (ARC) audio source	10
Play audio through Bluetooth	10
Auto standby	10
Apply factory settings	10

5 Wall mount	11
---------------------	-----------

6 Product specifications	11
---------------------------------	-----------

7 Troubleshooting	12
--------------------------	-----------

1 Important

Read and understand all instructions before you use your product. If damage is caused by failure to follow instructions, the warranty does not apply.

Help and support

For extensive online support, visit www.philips.com/support:

- download the user manual and the quick start guide
- watch video tutorials (available only for selected models)
- find answers to frequently answered questions (FAQs)
- email us a question
- chat with our support representative.

Follow the instructions on the website to select your language, and then enter your product model number.

Alternatively, you can contact Consumer Care in your country. Before you contact, note down the model number and serial number of your product. You can find this information on the back or bottom of your product.

Important safety instructions

- Read these instructions.
- Keep these instructions.
- Heed all warnings.
- Follow all instructions.
- Do not use this apparatus near water.
- Clean only with dry cloth.
- Do not block any ventilation openings. Install in accordance with the manufacturer's instructions.
- Do not install near any heat sources such as radiators, heat registers, stoves, or other apparatus (including amplifiers) that produce heat.
- Do not defeat the safety purpose of the polarized or grounding-type plug. A polarized plug has two blades with one wider than the other. A grounding type plug has two blades and a third grounding prong. The wide blade or the third prong

are provided for your safety. If the provided plug does not fit into your outlet, consult an electrician for replacement of the obsolete outlet.

- Protect the power cord from being walked on or pinched, particularly at plugs, convenience receptacles, and the point where they exit from the apparatus.
- Only use attachments/accessories specified by the manufacturer.
- Use only with the cart, stand, tripod, bracket or table specified by the manufacturer or sold with the apparatus.



When a cart is used, use caution when moving the cart/apparatus combination to avoid injury from tip-over.

- Unplug this apparatus during lightning storm or when unused for long periods of time.
- Refer all servicing to qualified service personnel. Servicing is required when the apparatus has been damaged in any way, such as power-supply cord or plug is damaged, liquid has been spilled or objects have fallen into the apparatus, the apparatus has been exposed to rain or moisture, does not operate normally, or has been dropped.
- Battery usage CAUTION - To prevent battery leakage which may result in bodily injury, property damage, or damage to the unit:
 - Install all batteries correctly, + and - as marked on the unit.
 - Do not mix batteries (old and new or carbon and alkaline, etc.).
 - Remove batteries when the unit is not used for a long time.
 - The batteries shall not be exposed to excessive heat such as sunshine, fire or the like.
- The product/remote control may contain a coin/button type battery, which can be swallowed. Keep the battery out of reach of children at all times! If swallowed, the battery can cause serious injury or death. Severe internal burns can occur within two hours of ingestion.
- If you suspect that a battery has been swallowed or placed inside any part of the body, seek immediate medical attention.
- When you change the batteries, always keep all new and used batteries out of

reach of children. Ensure that the battery compartment is completely secure after you replace the battery.

- If the battery compartment cannot be completely secured, discontinue use of the product. Keep out of reach of children and contact the manufacturer
- Apparatus shall not be exposed to dripping or splashing.
- Do not place any sources of danger on the apparatus (for example, liquid filled objects, lighted candles).
- This apparatus may contain lead and mercury. Dispose according to local, State or Federal laws. For disposal or recycling information, please contact your local authorities. For additional assistance on recycling options, please contact www.mygreenelectronics.com or www.eiae.org or www.recycle.philips.com.
- Where the MAINS plug or an appliance coupler is used as the disconnect device, the disconnect device shall remain readily operable.
- Do not place this apparatus on the furniture that is capable of being tilted by a child and an adult leaning, pulling, standing or climbing on it. A falling apparatus can cause serious injury or even death.
- This apparatus should not be placed in a built-in installation such as a bookcase or rack unless proper ventilation is provided. Make sure to leave a space of 7.8 inches (20cm) or more around this apparatus.

Class II equipment symbol



This symbol indicates that the unit has a double insulation system.

Know these safety symbols

This 'bolt of lightning' indicates uninsulated material within your unit may cause an electrical shock. For the safety of everyone in your household, please do not remove product covering.

The 'exclamation point' calls attention to features for which you should read the enclosed literature closely to prevent operating and maintenance problems.

WARNING: To reduce the risk of fire or electric shock this apparatus should not be exposed to rain or moisture and objects filled with liquids, such as vases, should not be placed on this apparatus.



CAUTION: To prevent electric shock match wide blade of plug to wide slot, fully insert.



Care for your product

Use only microfiber cloth to clean the product.

Care of the environment

Disposal of your old product and battery



Your product is designed and manufactured with high quality materials and components, which can be recycled and reused.



This symbol on a product means that the product is covered by European Directive 2012/19/EU.



This symbol means that the product contains batteries covered by European Directive 2013/56/EU which cannot be disposed of with normal household waste. Inform yourself about the local separate collection system for electrical and electronic products and batteries. Follow local rules and never dispose of the product and batteries with normal household waste. Correct disposal of old products and batteries helps prevent negative consequences for the environment and human health.

Removing the disposable batteries

To remove the disposable batteries, see battery installation section.

Compliance

This product complies with the radio interference requirements of the European Community. Hereby, TP Vision Europe B.V. declares that this product is in compliance with the essential requirements and other relevant provisions of Directive 2014/53/EU and UK Radio Equipment Regulations SI 2017 No 1206. You can find the Declaration of Conformity on www.philips.com/support.

What's in the box

Check and identify the item in the package:

Soundbar	x1
Wireless subwoofer	x1
Remote control	x1
AC adaptor (for soundbar)	x1
Power cord (for subwoofer)	x2
Wall Mount Kit	x1
(Wall brackets x2, screws x6, dowels x2)	
Quick Start Guide/Warranty Card/	
Safety sheet	x1
AAA batteries	x2

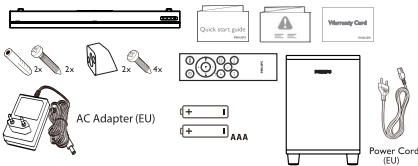

2 Your soundbar

Congratulations on your purchase, and welcome to Philips! To fully benefit from the support that Philips offers, register your soundbar at www.philips.com/support.

Main unit

This section includes an overview of the main unit.

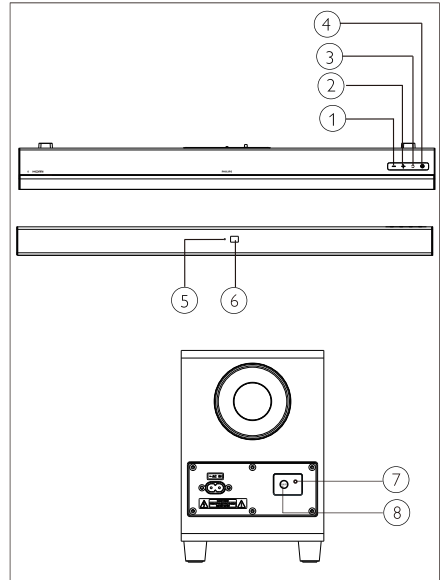

- ① **- (Volume)**
Decrease volume.
- ② **+ (Volume)**
Increase volume.
- ③ **☑ (SOURCE)**
Select an input source for the soundbar.
- ④ **⏻**
Switch the soundbar on or to standby.
- ⑤ **Multi-color LED indicator: Source / Standby**
- ⑥ **Remote sensor**
- ⑦ **Subwoofer's LED indicator**
- ⑧ **PAIR**

Remote control

This section includes an overview of the remote control.

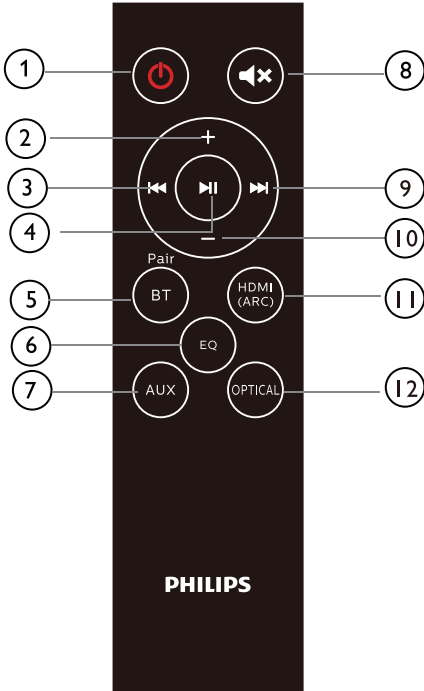

- ① **⏻ (Standby-On)**
 - Switch the soundbar on or to standby.
- ② **+ (Volume)**
 - Increase volume.
- ③ **⏮**
 - Skip to the previous track in Bluetooth mode.
- ④ **⏸**
 - Play, pause or resume play in Bluetooth mode.
- ⑤ **BT/PAIR**
 - Press to switch to the Bluetooth mode.
 - Press and hold to the disconnect the currently connected Bluetooth device and start a new pairing.
- ⑥ **EQ**
 - Switch between four EQ modes: Movie, Music, Stadium and News.
- ⑦ **AUX**
 - Switch your audio source to the AUX connection.
- ⑧ **🔇**
 - Mute or restore volume.
- ⑨ **⏭**
 - Skip to the next track in Bluetooth mode.
- ⑩ **- (Volume)**
 - Decrease volume.
- ⑪ **HDMI (ARC)**
 - Switch your audio source to the HDMI (ARC) connection.
- ⑫ **OPTICAL**
 - Switch your audio source to the optical connection.

Connectors

This section includes an overview of the connectors available on your soundbar.

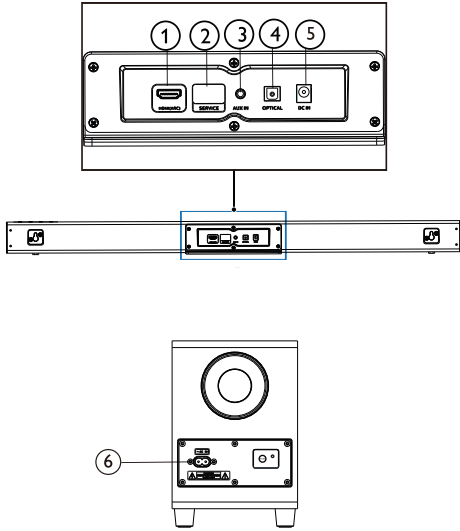

- ① **HDMI (ARC)**
Connect to the HDMI input on the TV.
- ② **SERVICE**
For software upgrade.
- ③ **AUX IN**
Audio input from, for example, an MP3 player (3.5mm jack).
- ④ **OPTICAL**
Connect to an optical audio output on the TV or a digital device.
- ⑤ **DC IN**
Connect the soundbar to the power supply.
- ⑥ **AC IN**
Connect the subwoofer to the power supply.

3 Connect

This section helps you connect your soundbar to a TV and other devices.

For information about the basic connections of your soundbar and accessories, see the quick start guide.

Note

- For identification and supply ratings, refer to the type plate at the back or bottom of the product.
- Before you make or change any connections, make sure that all devices are disconnected from the power outlet.

Placement

Place your soundbar and subwoofer as shown below.

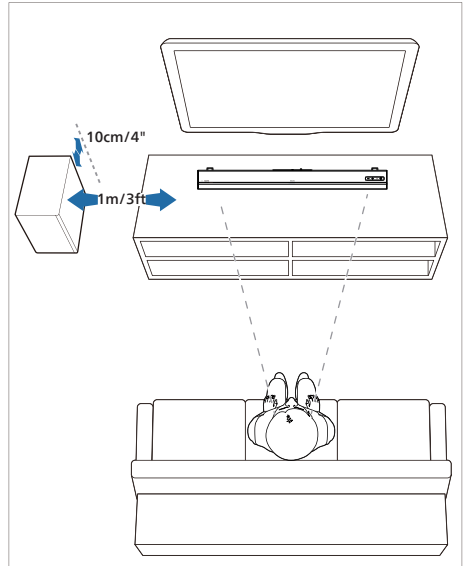

Connect the soundbar and subwoofer

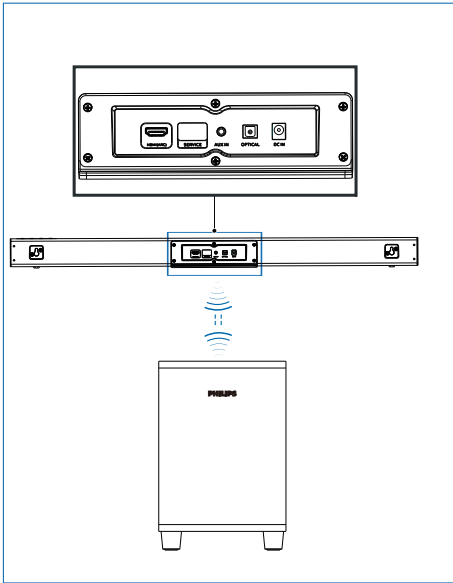

Connect the soundbar and subwoofer through Bluetooth

- The subwoofer will be connected with the soundbar via Bluetooth signal.
- The subwoofer's indicator will blink red before connected with the soundbar, and will turn solid blue after connected with the soundbar.
- If the soundbar and the subwoofer have been paired before, when you again plug in and power on the soundbar, the subwoofer will be automatically paired with the soundbar with normal sound output and solid blue indicator. And the subwoofer will go into standby automatically after the soundbar is powered off.





Pair the subwoofer manually

- If no audio is heard from the subwoofer or the subwoofer's indicator does not turn blue, follow the steps below to reset and pair up the subwoofer again:
 1. Press the **PAIR** button on the subwoofer when the subwoofer is in Disconnected status (subwoofer's indicator blinks red slowly, once per second), and then the subwoofer's indicator will blink red quickly (twice per second).
 2. Switch the soundbar source to **AUX**, and then press and hold **⏻** on the soundbar for five seconds. The soundbar will reset and go into standby automatically.
 3. Press **⏻** on the soundbar. The soundbar will pair with the subwoofer automatically. The connection is successful when the subwoofer's indicator turns solid blue.

Note: Once the soundbar is reset, you should clear the Bluetooth device list in your phone before you pair your phone with the soundbar.

When the soundbar and subwoofer are connected, you can press and hold **⏻** and **+** (**Volume**) on the soundbar for five seconds to disconnect them.

Subwoofer indicator

-  Pairing: Fast blinking red
-  Connected: Solid blue
-  Disconnected: Slow blinking red
-  Standby: Solid red

Connect audio from TV and other devices

Option 1: Connect audio through a digital optical cable

Best quality audio

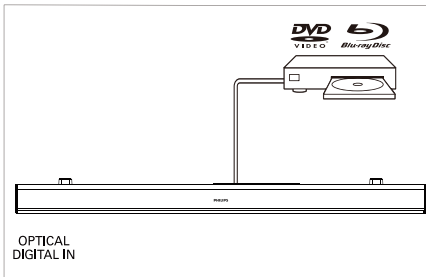
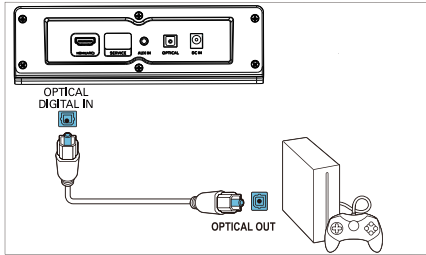
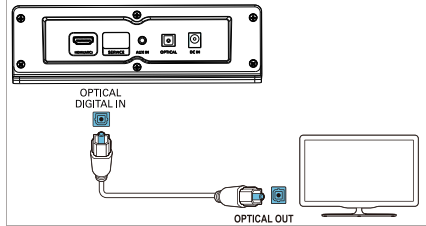

Using an optical cable, connect the **OPTICAL** connector on your soundbar to the **OPTICAL OUT** connector on the TV or other device.

- The digital optical connector might be labeled **SPDIF** or **SPDIF OUT**.

NOTE: The TV audio output must be set to PCM.

Option 2: Connect audio through a 3.5mm stereo audio cable

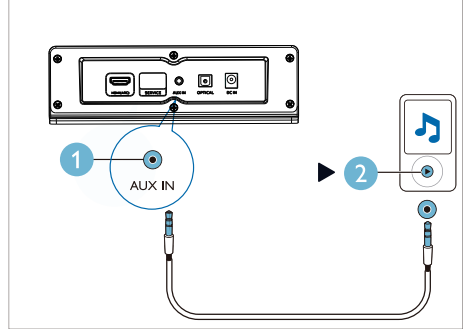
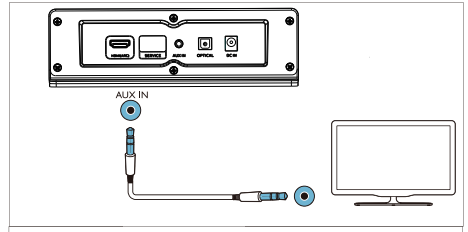

Using a 3.5mm stereo audio cable, connect the **AUX IN** connector on your soundbar to the **AUX** connector on the TV or other device.

Option 3: Connect to HDMI (ARC) Socket

Your soundbar supports HDMI with Audio Return Channel (ARC). If your TV is HDMI ARC compatible, you can listen to the TV audio through your soundbar by using a single HDMI cable.

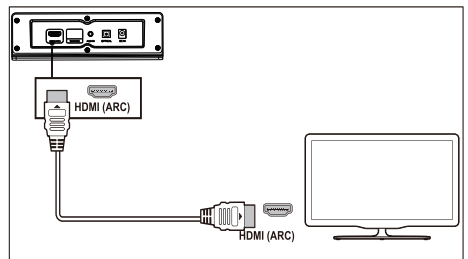

- 1 Using a High Speed HDMI cable, connect the **HDMI (ARC)** connector on your soundbar to the **HDMI ARC** connector on the TV.
 - The **HDMI ARC** connector on the TV might be labeled differently. For details, see the TV user manual.
- 2 On your TV, turn on HDMI-CEC operations. For details, see the TV user manual.
NOTE: The TV audio output must be set to PCM.

4 Use your soundbar

This section helps you use the soundbar to play audio from connected devices.

Before you start

- Make the necessary connections described in the quick start guide or the user manual.
- Switch the soundbar to the correct source for other devices.

Power on/off

Connect the soundbar to the power supply, and the red standby indicator lights up.



Press  to power on the soundbar.

The soundbar's indicator lights up white, and then will show the status of the last selected source. Press again to switch the soundbar to standby.



-  Standby: The indicator is solid red.

Volume control

Press **+/- (Volume)** to increase or decrease the volume level.





- To mute sound, press  on the remote control.
- To restore the sound, press  again or press **+/- (Volume)**.

Indicator status

-  Decrease /Increase volume/Mute: Blinking red.
-  Maximum/Minimum volume: Solid red for three seconds.
- When you press **+ (Volume)** to increase the volume, the soundbar's indicator will blink red, and the volume will return to the normal state. The soundbar's indicator will show solid red for three seconds when the volume reaches the maximum.
- When you press **- (Volume)** to decrease the volume, the soundbar's indicator will blink red, and the volume will return to the normal state. The soundbar's indicator will show solid red for three seconds when the volume reaches the minimum.





Source selection

Press  on the soundbar repeatedly or the corresponding buttons (**BT/PAIR**, **AUX**, **HDMI (ARC)**, **OPTICAL**) on the remote control to switch between different sources.

-  AUX IN: Solid green
-  Bluetooth-pairing: Blinking blue
-  Bluetooth-connected: Solid blue
-  OPTICAL: Solid yellow
-  HDMI (ARC): Solid purple

EQ setting

Press **EQ** on the remote control to select Music, Movie, News or Stadium mode.

-  • Music: Soundbar's indicator blinks white for 3 seconds.
-  • Movie: Soundbar's indicator blinks green for 3 seconds.
-  • News: Soundbar's indicator blinks red for 3 seconds.
-  • Stadium: Soundbar's indicator blinks cyan for 3 seconds.

AUX audio source

You can play audio from an external device (smart phone, tablet, etc.) via a 3.5mm audio cable.

- 1 Connect the external device to your soundbar via the 3.5 mm stereo audio cable (not included). Refer to Page 8 for steps of AUX connection.
- 2 Press **AUX** on the remote control.
 -  The soundbar's indicator turns solid green.
- 3 Play audio on the external device (refer to the user manual of the device).

Optical audio source

You can play audio from a TV via an optical cable.

- 1 Connect the TV to your soundbar via the optical cable (not included). Refer to Page 8 for steps of OPTICAL connection.
- 2 Press **OPTICAL** on the remote control.

- The soundbar's indicator turns solid yellow.

Note: The TV audio output must be set to PCM signal.

HDMI (ARC) audio source

ARC (Audio Return Channel) is used in digital audio output of liquid crystal display television in order to get the optimal synchronous sound quality.

- 1 Connect the TV to your soundbar via the HDMI cable (not included). Refer to Page 8 for steps of HDMI (ARC) connection.
- 2 Press **HDMI (ARC)** on the remote control.
 - The soundbar's indicator turns solid purple.

Note: The TV audio output must be set to PCM signal and ARC on (refer to the manual of the TV).

Play audio through Bluetooth

Through Bluetooth, connect the soundbar with your Bluetooth device (such as an iPad, iPhone, iPod touch, Android phone, or laptop), and then you can listen to the audio files stored on the device through your soundbar.

What you need

- A Bluetooth device which supports Bluetooth profile A2DP and AVRCP, and with Bluetooth version 4.2 or above.
 - The operational range between the soundbar and a Bluetooth device is approximately 4 meters (13 feet).
- 1 Press **BT/Pair** on the remote control to switch the soundbar to Bluetooth mode.
 - ↳ The soundbar's indicator blinks blue.
 - 2 On the Bluetooth device, switch on Bluetooth, search for and select **Philips TAB5308** to start connection (see the user manual of the Bluetooth device on how to enable Bluetooth).
 - ↳ During connection, the soundbar's indicator blinks blue.
 - 3 Wait until the soundbar's indicator turns solid blue, and a beep sound will be heard upon a successful connection.

If the connection fails, the indicator blinks continually.

- 4 Select and play audio files or music on your Bluetooth device.
 - During play, if a call comes in, music play is paused.
 - If your Bluetooth device supports AVRCP profile, on the remote control you can press **◀◀/▶▶** to skip to a track, or press **▶||** to pause/resume play.
- 5 To exit Bluetooth, switch your soundbar to another source.
 - When you switch back to Bluetooth mode, Bluetooth connection remains active.

Disconnect from the current device:

- If you want to connect your soundbar with another Bluetooth device, press and hold **BT/PAIR** on the remote control to disconnect the currently connected Bluetooth device.

Indicator status

- Waiting to connect: Blinking blue
- Connected: Solid blue
- Disconnected: Blinking blue



Note

- The music streaming may be interrupted by obstacles between the device and soundbar; such as wall, metallic casing that covers the device, or other devices nearby that operate in the same frequency.

Auto standby

This product automatically switches to standby after 15 minutes of button inactivity and no audio play from a connected device.

Apply factory settings

You can reset your soundbar to the default setting mode.

- In AUX mode, press and hold **⏻** on the remote control for 5 seconds.
 - ↳ The factory settings is restored.

5 Wall mount

Note

- Improper wall mounting may result in accident, injury or damage. If you have any query, contact Consumer Care in your country.
- Before wall mounting, make sure the wall can support the weight of your soundbar.

Screw length/diameter

Depending on the type of wall mounting, make sure that you use screws of a suitable length and diameter.

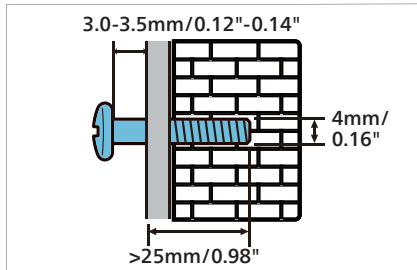

See the illustration in the quick start guide on how to wall mount the soundbar.

- 1) Drill two holes on the wall.
- 2) Secure the dowels and screws in the holes.
- 3) Hang the soundbar on the fastening screws.

6 Product specifications

Note

- Specifications and design are subject to change without notice.

Amplifier

- RMS total output power: 70W RMS (+/- 0.5 dB, 10% THD)
- Frequency response: 50 Hz-15 kHz / ± 3 dB
- Signal-to-noise ratio: > 65 dB (CCIR) / (A-weighted)
- Total Harmonic Distortion: <1%
- Input sensitivity:
 - LINE IN: 500 mV +/-50 mV

Bluetooth

- Bluetooth profiles: A2DP, AVRCP
- Bluetooth version: 4.2
- Frequency band/Output power: 2402 - 2480 MHz / ≤ 20 dBm

Main unit

Soundbar

- Power supply: 100-240 V~, 50/60 Hz
- Power consumption: 15V/1.6A
- Standby power consumption: ≤ 0.5 W
- Dimensions (W x H x D):
900 x 65.5 x 91 mm
- Weight: 1.53 kg
- Driver: 2 x full range
(52 mm/2", 4 ohm)

Subwoofer

- Power supply: 100-240 V~, 50/60 Hz
- Power consumption: 20 W
- Standby power consumption: ≤ 2 W
- Dimensions (W x H x D):
150 x 225 x 267 mm
- Weight: 2.1 kg
- Driver: 1 x low frequency
(118 mm/4.5", 4 ohm)

Remote control batteries

- 2 x AAA-R03-1.5 V

7 Troubleshooting



Warning

- Risk of electric shock! Never remove the casing of the product.

To keep the warranty valid, never try to repair the product yourself.

If you have problems using this product, check the following points before you request service.

If you still have a problem, get support at www.philips.com/support.

Main unit

The buttons on the soundbar do not work.

- Disconnect the soundbar from the power supply for a few minutes, then reconnect.

Sound

No sound from the soundbar speakers.

- Connect the audio cable from your Soundbar to your TV or other devices.
- Reset your soundbar to its factory settings.
- On the remote control, select the correct audio input.
- Make sure that the soundbar is not muted.

Distorted sound or echo.

- If you play audio from the TV through the soundbar, make sure that the TV is muted.

Bluetooth

A device cannot connect with the soundbar.

- The device does not support the compatible profiles required for the soundbar.
- You have not enabled the Bluetooth function of the device. See the user manual of the device on how to enable the function.
- The device is not correctly connected. Connect the device correctly (see 'Play audio through Bluetooth' on page 10).
- The soundbar is already connected with another Bluetooth device. Disconnect the connected device, then try again.

Quality of audio play from a connected Bluetooth device is poor.

- The Bluetooth reception is poor. Move the device closer to the soundbar, or remove any obstacle between the device and the soundbar.

The connected Bluetooth device connects and disconnects constantly.

- The Bluetooth reception is poor. Move the device closer to the soundbar, or remove any obstacle between the device and the soundbar.
- Turn off Wi-Fi function on the Bluetooth device to avoid interference.
- For some Bluetooth devices, the Bluetooth connection can be deactivated automatically to save power. This does not indicate any malfunction of the soundbar.



Specifications are subject to change without notice. Please visit www.philips.com/support for the latest updates and documents. Philips and Philips Shield Emblem are registered trademarks of Koninklijke Philips N.V. and are used under license. This product has been manufactured by and is sold under the responsibility of MMD Hong Kong Holding Limited, or one of its affiliates, and MMD Hong Kong Holding Limited, is the warrantor in relation to this product.

